

New Jersey Institute of Technology
Digital Commons @ NJIT

Theses

Electronic Theses and Dissertations

Spring 5-31-2016

Antibacterial efficacy of nanometals in conjunction with electrical stimulus

Syed A. Hussain
New Jersey Institute of Technology

Follow this and additional works at: <https://digitalcommons.njit.edu/theses>



Part of the [Biomedical Engineering and Bioengineering Commons](#)

Recommended Citation

Hussain, Syed A., "Antibacterial efficacy of nanometals in conjunction with electrical stimulus" (2016).
Theses. 271.
<https://digitalcommons.njit.edu/theses/271>

This Thesis is brought to you for free and open access by the Electronic Theses and Dissertations at Digital Commons @ NJIT. It has been accepted for inclusion in Theses by an authorized administrator of Digital Commons @ NJIT. For more information, please contact digitalcommons@njit.edu.

Copyright Warning & Restrictions

The copyright law of the United States (Title 17, United States Code) governs the making of photocopies or other reproductions of copyrighted material.

Under certain conditions specified in the law, libraries and archives are authorized to furnish a photocopy or other reproduction. One of these specified conditions is that the photocopy or reproduction is not to be “used for any purpose other than private study, scholarship, or research.” If a user makes a request for, or later uses, a photocopy or reproduction for purposes in excess of “fair use” that user may be liable for copyright infringement,

This institution reserves the right to refuse to accept a copying order if, in its judgment, fulfillment of the order would involve violation of copyright law.

Please Note: The author retains the copyright while the New Jersey Institute of Technology reserves the right to distribute this thesis or dissertation

Printing note: If you do not wish to print this page, then select “Pages from: first page # to: last page #” on the print dialog screen

The Van Houten library has removed some of the personal information and all signatures from the approval page and biographical sketches of theses and dissertations in order to protect the identity of NJIT graduates and faculty.

ABSTRACT

ANTIBACTERIAL EFFICACY OF NANOMETALS IN CONJUNCTION WITH ELECTRICAL STIMULUS

**By
Syed A. Hussain**

Hospital related infections generally result from the combined effect of preexisting bacteria on the patient and invasive devices. This demonstrates the significance in improving these medical devices to increase the quality of life of the patients that require them. This study will attempt to evaluate the antibacterial efficacy of nanocopper particles and an electrical stimulus for the usage in medical device development and the hospital environment.

For devices such as catheters, infections typically result from bacteria entering the body from the outside. This is accomplished by bacteria attaching themselves to the exterior of the device and producing biofilm which allows them to enter the body and cause an infection.

The first and second studies positively demonstrate that the nanocopper and electrical stimulus work well in creating inhibition zones. However, the third test which focuses primarily on biofilm prevention presents negative results. In fact, it appears that the nanocopper has no effect on biofilm growth at all. The reasons for these mixed results could be due to a variety of reasons. For instance, when adding small particles to a very viscous solution, ensuring thorough dispersion proves very difficult without the proper tools which may have influenced the observed discrepancies. Another, possible conclusion could be due to the variability of thickness of the samples which can contribute to the high

standard deviations. The results of this thesis indicate that with the proper materials and preparation, the application of nanocopper and direct current can potentially be applied towards the development of medical devices.

**ANTIBACTERIAL EFFICACY OF NANOMETALS IN CONJUNCTION WITH
ELECTRICAL STIMULUS**

**By
Syed A. Hussain**

**A Thesis
Submitted to the Faculty of
New Jersey Institute of Technology
in Partial Fulfillment of the Requirements for the Degree of
Master of Science in Biomedical Engineering**

Department of Biomedical Engineering

May 2016

Blank Page

APPROVAL PAGE

**ANTIBACTERIAL EFFICACY OF NANOMETALS
IN CONJUNCTION WITH ELECTRICAL STIMULUS**

Syed A. Hussain

Dr. Michael Jaffe, Thesis Advisor Date
Research Professor of Biomedical Engineering and Chemistry, NJIT

Dr. William C. Hunter, Committee Member Date
Professor of Biomedical Engineering, NJIT

Dr. Treena L. Arinzeh, Committee Member Date
Professor and Director of the Biomedical Engineering Graduate Program, NJIT

Blank Page

BIOGRAPHICAL SKETCH

Author: Syed A. Hussain

Degree: Master of Science

Date: May 2016

Undergraduate and Graduate Education:

- Master of Science in Biomedical Engineering
New Jersey Institute of Technology, Newark, NJ, 2016
- Bachelor of Science in Biomedical Engineering
New Jersey Institute of Technology, Newark, NJ, 2014

Major: Biomedical Engineering

I dedicate this thesis to my parents, Meher and Murtuza who have given everything for my success. I also dedicate this thesis to my sisters, Asiya and Farah for their relentless support.

*Logic will get you from A to B. Imagination will take you everywhere.
-Albert Einstein*

ACKNOWLEDGEMENTS

I'd like to acknowledge Dr. Michael Jaffe for advising and counselling me throughout this process. In addition, I would also like to give thanks to Dr. Treena Arinzeh and Dr. William Hunter for serving on my thesis committee. I would also like to acknowledge Dr. Jeff Boyd from the department of microbiology at Rutgers University of New Brunswick and his PhD student Ameya Mashruwala for their assistance and support of the study. Lastly, I must also recognize my colleagues Kristian Budinoski, Maulik Jani, and Ikramah Nazir for their contributions to and support of this project.

TABLE OF CONTENTS

Chapter		Page
1	INTRODUCTION.....	1
1.1	Objective.....	1
1.2	Background Information.....	1
1.3	Hospital Associated Urinary Tract Infections.....	4
1.3.1	Pathophysiology.....	6
1.4	Pneumonia.....	8
1.4.1	Epidemiology.....	9
1.4.2	Pathophysiology.....	9
1.5	Microbiology.....	10
1.5.1	Symbiosis.....	10
1.5.2	Parasitism.....	11
1.6	Bacteria Taxonomy.....	11
1.7	Pathogenesis of Bacterial Infection.....	12
1.8	Role of Biofilm in CAUTIs.....	14
2	ANTIBACTERIAL MECHANISMS.....	15
2.1	Biofilm Resistance.....	15
2.2	Application of Electrical Current.....	16
2.3	Bioelectric Effect Mechanism.....	16

TABLE OF CONTENTS
(Continued)

Chapter		Page
2.4	Oligodynamic Effect.....	17
	2.4.1 Example Study.....	18
2.5	Cu Nanoparticles.....	19
3	EXPERIMENTAL SETUP AND RESULTS.....	21
	3.1 Sample Preparation.....	21
	3.2 Circuit Design.....	23
	3.3 Zones of Inhibition.....	24
	3.4 Application of Electrical Current Test.....	24
	3.5 Biofilm Inhibition.....	27
	3.6 Results Zones of Inhibition Test.....	28
	3.7 Results of Bioelectric Effect Test.....	29
	3.8 Results of Biofilm Elimination Test.....	30
4	CONCLUSION.....	36
5	REFERENCES.....	39

LIST OF TABLES

Table		Page
1.1	Various Types of Pneumonia.....	8
3.1	Results of Applied DC.....	29
3.2	Results of Biofilm Test.....	28
3.3	ANOVA Test at 7 Hours.....	30
3.4	ANOVA Test at 22 Hours.....	30
3.5	2 Way ANOVA Test.....	32

LIST OF FIGURES

Figure		Page
1.1	Estimates of Healthcare-Associated Infections.....	3
1.2	Foley Catheter	5
1.3	Pyelonephritis.....	7
1.4	Various Bacteria Shapes.....	12
1.5	Bacterial Adhesion.....	13
2.1	Biofilm Resistance.....	15
2.2	Bioelectric Effect.....	17
2.3	Oligodynamic Effect on Bacteria.....	18
2.4	Oligodynamic Effect on Antibiotic Resistant Bacteria.....	19
2.5	Antibacterial Mechanism of Metals.....	20
3.1	Circuit Diagram.....	23
3.2	Petri Dish for Current Test.....	26
3.3	Zones of Inhibition.....	28
3.4	Effects of Applied DC.....	29
3.5	Power Curve	33
3.6	Graphs Demonstrating Results of Biofilm Test.....	34

LIST OF DEFINITIONS

CAUTI	Catheter associated urinary tract infection.
Epidemiology	A branch of medical science that deals with the incidence, distribution, and control of disease in a population.
Pathology	The study of the essential nature of diseases and especially of the structural and functional changes produced by them
Pathophysiology	The functional changes that accompany a particular syndrome or disease

CHAPTER 1

INTRODUCTION

1.1 Objective

The objective of this thesis was to study the antibacterial efficacy of nanocopper particles and electrical stimulus so that this concept if effective could be applied in the development of medical devices and hospital equipment.

For this study nanocopper particles with different diameter sizes were tested. They included 25, 40, and 70 nanometer particles. In addition, medical grade silicone was used as a basis for the testing. Medical grade silicone is of course found in various types of Class I, II, and III devices which makes it an excellent component in this experiment.

Lastly, an electrical stimulus will also contribute to the antibacterial properties of this study. The hope is that the electrical stimulus will weaken the bacteria cell wall and ultimately lead to the destruction of the bacteria cells. The key for this component of the study is to ensure that the current that will be applied will not harm humans if this were a true medical device.

1.2 Background Information

Nosocomial infections are a significant factor in increased healthcare costs and additional healthcare related issues (Boyer, 2015). Infections can occur in anyone. That is, they do not discriminate between race, age, and geography. Every year nationally, infection affects over 2 million people and generally result in 90,000 deaths (Flanders, 2009). Although, in

some situations, geography can have a correlation to certain types of infections (Stevens, 2015). Some methods of dispersion include air travel, natural disasters, and trauma. Developing one clear cut method of prevention is difficult as there several factors involved. This thesis will shall primarily focus on nosocomial infections and device related infections.

Nosocomial infections are also known as hospital acquired infections. 10% of all patients that need to be treated in an acute care hospitals have the tendency of developing of developing an infection (Flanders, 2009). Acute care hospitals are hospitals that patients can go to for severe injury or when they are seeking treatment for illness. Patients are typically admitted into acute care hospitals when they present with severe injury, illness, or an urgent medical condition or are post op. A majority of these infections are a result of UTIs, pneumonia, surgical site infections, and bloodstream infections.

Type of Infection	Rank	No. of Infections	Percentage of All Health Care–Associated Infections (95% CI)
Pneumonia†	1 (tie)	110	21.8 (18.4–25.6)
Surgical-site infection	1 (tie)	110	21.8 (18.4–25.6)
Gastrointestinal infection	3	86	17.1 (14.0–20.5)
Urinary tract infection‡	4	65	12.9 (10.2–16.0)
Primary bloodstream infection§	5	50	9.9 (7.5–12.8)
Eye, ear, nose, throat, or mouth infection	6	28	5.6 (3.8–7.8)
Lower respiratory tract infection	7	20	4.0 (2.5–6.0)
Skin and soft-tissue infection	8	16	3.2 (1.9–5.0)
Cardiovascular system infection	9	6	1.2 (0.5–2.5)
Bone and joint infection	10	5	1.0 (0.4–2.2)
Central nervous system infection	11	4	0.8 (0.3–1.9)
Reproductive tract infection	12	3	0.6 (0.2–1.6)
Systemic infection	13	1	0.2 (0.01–1.0)

* Infections were defined with the use of National Healthcare Safety Network criteria. CI denotes confidence interval.

† A total of 43 pneumonia events (39.1%) were associated with a mechanical ventilator.

‡ A total of 44 urinary tract infections (67.7%) were associated with a catheter.

§ A total of 42 primary bloodstream infections (84.0%) were associated with a central catheter.

Figure 1.1 Estimates of Healthcare-Associated Infections Occurring in Acute Care Hospitals in the United States, 2011.

Source: Shelley S. Magill, M. P.-H. (2014). *Multistate Point-Prevalence Survey of Health Care–Associated Infections*. Retrieved from The New England Journal of Medicine:

<http://www.nejm.org/doi/ref/10.1056/NEJMoa1306801#t=references>.

1.3 Hospital Associated Urinary Tract Infections

In the previous, a brief introduction on the concept of medical device related infections was provided to strengthen the cause of this particular study. This section goes into detail of certain nosocomial or healthcare-acquired infections and the risks they pose. The purpose of providing this information is to further emphasize the need for developing devices that are designed to prevent infection.

Urinary tract infections are a very common hospital associated infection. Prior to the existence of antibiotics, UTIs resulted in relatively high morbidity rates. Fortunately, today treatment does exist yet it still remains as one of the most commonly acquired nosocomial infections. UTIs usually present with dysuria and frequent urination along with the associated pain and discomfort. Dysuria is also known as difficulty urinating. UTIs generally account for about 40% of all hospital acquired infections (Flanders, 2009). It is clear this affects a significant population and an issue that has existed for such a long time and the biomedical community has yet to find a solution. Hospital acquired UTIs are characteristic of bacteremia in 4% of patients and as a result it possesses a generally high mortality rate (Flanders, 2009). As a result, UTIs are responsible for significant health care costs. In the United States alone, common UTIs generally result in at least several hospital visits, estimates around 7 million, and extensive costs nearing \$1.6 billion dollar annually (Ross, 2012). The risk of this contracting this type of infection increases when a catheter is put in place.

A urinary catheter (see Figure 1.2) is a catheter that is placed in the patient's bladder and is fed out through the patient's urethra. This allows the patients bladder to be drained of urine into a collection bag on the end of the catheter located outside of the body. The

catheters are usually put in place when a patient is undergoing surgery or when the patient is unable to urinate on their own.



Figure 1.2 Typical Foley Catheter. The catheter is either composed of silicone, latex, and sometimes PVC. There are several different types of catheters; this is balloon catheter with two lumens.

Source: *Foley Catheters*. (n.d.). Retrieved from Bard Medical:

<http://www.bardmedical.com/products/urological-drainage/foley-catheters>.

Urinary catheterization increases the risk of UTIs. The presence of a Foley catheter increases the risk of UTIs. Upon insertion, bacteria are able to migrate outside the catheter and the urethral mucosa to gain entry to the bladder. The bacteria are capable of producing a biofilm on the catheter which provides protection from antibiotics and other host defenses (Ross, 2012). If bacteria are allowed to remain in contact with the surface of the device, then they can eventually reach the bladder uroepithelium where they may also produce biofilm. This puts the patient in a very uncomfortable situation as treating a catheter associated urinary tract infection requires frequent hospitalization as well catheter replacement which is essential for treatment. Catheter replacement generally involves clean intermittent catheterization every six hours (Ross, 2012). This study focuses upon

preventing CAUTI by using nanomaterials and electrical stimulus to eliminate bacteria and prevent biofilm formation.

1.3.1 Pathophysiology

UTIs are generally caused by strains of *Escheriachia Coli* and *Staphylococcus Aureus*. A normal and healthy urinary tract generally is immune to pathogenic infection. This is possibly attributed to the mucosal membranes that are not only located in this region but in other entry ways of the body. The insertion of a foley catheter can suppress neutrophil function and deteriorate this effectiveness of this defense mechanism. Neutrophils generally are responsible for prevent infections that can result from pathogens. What also contributes to the susceptibility to UTIs is the accumulation of bacteria in the urine which is also known as bacteriuria.

Subsequent to catheter placement, the rate of bacteria accumulation in the urine is nearly 5% per day which could translate to even large quantities for patients that require long term catheterization (Ross, 2012). Other additional risk factors that can contribute to the occurrence of urinary tract infections include diabetes, glucosuria, and urinary stasis from obstruction, bladder diverticula, neurologic disease, vesicoureteral reflux, and urinary calculi (Ross, 2012)

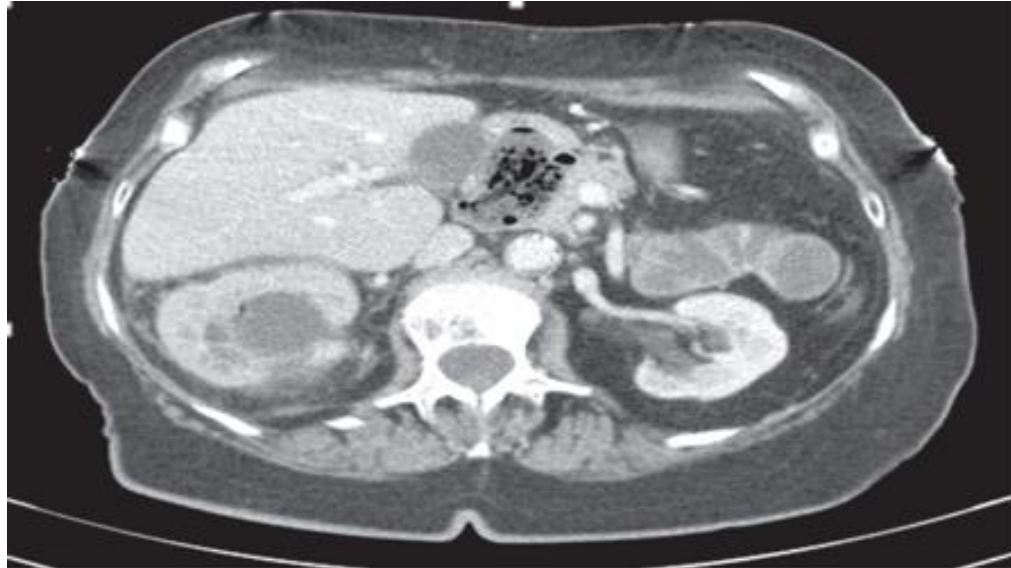

Figure 1.3 Observation of pyelonephritis in a patient with a urinary tract obstruction from a stone at the ureteropelvic junction.

Source: McKean S, Ross JJ, Dressier DD, Brotman DJ, Ginsberg JS: Principles and Practice of Hospital Medicine: www.accessmedicine.com

1.4 Pneumonia

Hospital acquired pneumonia falls under three different categories: healthcare-associated pneumonia, hospital-acquired pneumonia (HAP), ventilator-associated pneumonia (VAP), and hospital-acquired pneumonia (Boyer, 2015).

Table 1.1 Demonstrates the Various Types of Pneumonia Which Result From the Bacteria Existing in a Hospital Environment

Definitions of Nosocomial Pneumonia	Definitions
HCAP, healthcare-associated pneumonia	Pneumonia diagnosed in any patient who was hospitalized in an acute care hospital for 2 or more days within 90 d of the diagnosis, resided in a nursing home or long-term care facility; received recent intravenous antibiotic therapy, chemotherapy, or wound care within the past 30 d of the current infection; or attended a hospital or hemodialysis clinic
HAP, hospital-acquired pneumonia	Pneumonia diagnosed 48 h or more after hospital admission
VAP, ventilator-associated pneumonia	Pneumonia diagnosed 48 h or more after endotracheal intubation

Source: Boyer A.F., Kollef M.H. (2015). Healthcare-Acquired Pneumonia, Including Ventilator-Associated Pneumonia. In Grippi M.A., Elias J.A., Fishman J.A., Kotloff R.M., Pack A.I., Senior R.M., Siegel M.D. (Eds), *Fishman's Pulmonary Diseases and Disorders, Fifth Edition*. Retrieved April 22, 2016 from <http://accessmedicine.mhmedical.com/content.aspx?bookid=1344&Sectionid=81199415>

One of the most common illnesses that can result in hospitalization and ICU admission is pneumonia which is characterized by potential respiratory failure (Wunderink, 2015). The term hemodynamics refers to the flow and distribution of blood within the body. To maintain the correct amount of intravascular and extravascular volumes, the body must maintain both hydrostatic pressure and osmotic pressure. In vessels, hydrostatic pressure refers to the pressure pushing fluid out into the interstitial tissue. In interstitial tissue, hydrostatic pressure pushes fluid into the vessels and osmotic pressure pulls the fluid into the interstitial tissue (Kemp, 2008). An imbalance of either of these two pressures can ultimately result in unequal distribution of fluids. In short, when there is fluid in the lungs,

pneumonia can occur. In addition, to the hemodynamic imbalance, pneumonia can also result in septic shock. Septic shock is characterized by sepsis, or infection which is accompanied by hypotension (Kemp, 2008)

1.4.1 Epidemiology

There are more than 5 million cases of pneumonia annually in the United States. The mortality rate among outpatients is less than 1%. On the other hand, the mortality rate for inpatients can range anywhere between 12% to 40%. This all depends upon whether treatment is given inside or outside the ICU (Mandell, 2015). HAP has been found to occur at a rate of 5 to 10 cases per 1000 hospital admission and VAP occurs in 9-27% of patients with that are intubated (Boyer, 2015).

1.4.2 Pathophysiology

There are several mechanical mechanisms that play a vital role in host defense against pneumonia. For example, in the nostrils, the hair and turbinates, prevent particles from reaching the lower respiratory tract. In addition, the gag reflex and cough mechanism also offer protection during aspiration. Lastly, the flora adhere to mucosal cells that exist within the oropharynx prevent the adhesion of external pathogens. These mechanisms help reduce the risk of pneumonia (Mandell, 2015). Many of the mucosal membranes in the body prevent pathogens from entering deeper into the body and in doing so can prevent infection.

Sometimes, these defenses can be overcome. Illnesses such as Pneumonia can result from the proliferation of microbial pathogens and a host response (Mandell, 2015). For pneumonia to occur, bacteria need to gain access to the alveoli. This can occur in several ways. The easiest way is during aspiration through the oropharynx. During the aspiration phase, many pathogens can be inhaled as contaminated droplets. Once inside the alveoli, macrophages attack the pathogens. Pneumonia results when the capacity of the macrophages to kill the pathogens has been exceeded (Mandell, 2015).

1.5 Microbiology

Microbiology focuses upon the study of microorganisms which can exist as single cellular organisms or clusters. Microorganisms play a fundamental role in the life process. The cycling of life essential elements is one of many different tasks attributed to them. In fact, our bodies are hosts to these bacteria which compose more than 90% of all cells in our bodies (Carroll, 2015). From this, there are different relationships that exist between our bodies and the microbes that we host. These relations can be described as either mutual, also known as symbiotic, or parasitic. This research paper primarily focuses upon parasitic bacteria and will be discussed more in depth.

1.5.1 Symbiosis

In a mutualistic or symbiotic relationship, both the host and the cells living in the host benefit from each other's presence. An example of this includes lichens which generally consist of a fungus with a phototropic partners such as alga or a cyanobacterium (Carroll,

2015). The alga or cyanobacterium acts the producer of food and energy while the fungus serves to anchor and protect the phototropic cell.

1.5.2 Parasitism

In parasitism, only one party is benefited. In a microbe-host relationship, the parasite would be benefiting. An example of this would be a virus. While viruses are not cellular, they are still microorganisms (Carroll, 2015). Viruses attempt to infect the cells of their host in order for them to survive and reproduce so that eventually they can continue to infect additional cells. Other types of microbes that maintain a parasitic relationship with their host include but are not limited to *Escherichia coli* or *Staphylococcus aureus*. These bacteria are often called pathogenic bacteria.

1.6 Bacteria Taxonomy

It is very important to understand the type of bacteria to better understand whether or not it can cause infectious disease. The classification of bacteria is based off the Bergey's Manual of Systematic Bacteriology. Because there are so many different types of bacteria, one can only assume that there are several groups that can be classified under. Some of these include archaeobacterial, cell wall-less eubacteria, gram positive bacteria, and gram negative bacteria. According to Bergey's Manual of Determinative Bacteriology, these are the major categories of bacteria that are known to cause disease in humans. The bacteria used in this study included both gram-negative bacteria and gram-positive bacteria. To identify if bacteria are either gram positive or gram negative, the microorganisms are stained using dyes such as methylene blue, crystal violet, and several others (Ryan, 2014).

Gram-positive bacteria retain a purple iodine-dye complex whereas gram-negative bacteria do not retain complexes when decolorized.

Gram negative bacteria consist of bacteria that possess a complex cell envelope consisting of an outer membrane. The shape of the cells in both gram-negative and gram –positive can vary between spherical, rod, and helical. See Figure 3.1.

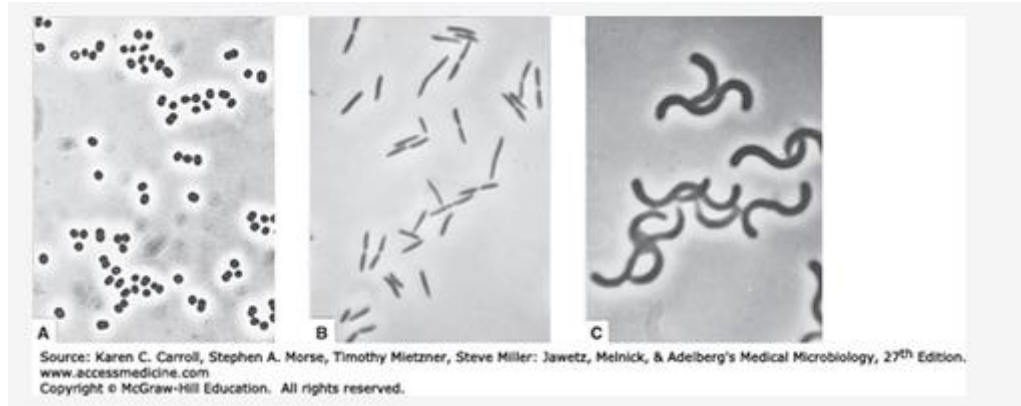

Figure 1.4 This diagram shows the various shapes that are can characterize bacteria.
Source: Karen C. Carroll, Stephen A. Morse, Timothy Mietzner, Steve Miller: jawetz, Melnick, & Adelberg's Medical Microbiology, 27th edition. www.accessmedicine.com

Reproduction in this bacteria generally occurs through the process of binary fission however some bacteria are able to accomplish this through the process of budding (Carroll, 2015). Binary fission is type of asexual reproduction which results in the prokaryotic cell dividing into two daughter cells. Budding is also a type of asexual reproduction that involves cell division from a specific region of the cell.

1.7 Pathogenesis of Bacterial Infection

Pathogenesis refers to the entire infection process including the presentation of symptoms indicating disease. Some typical characteristics of pathogenic bacteria include the ability

of being transmitted, adhere to other cells, and the ability to survive the host's immune system (Carroll, 2015). The primary issue that occurs with medical devices is that bacteria can adhere to surfaces of the device. Once they have adhered to the surface, it can be very difficult to remove them as a result of antibiotic resistance and persistent nature. The adherence of bacteria is essentially a survival mechanism and virulence factor.

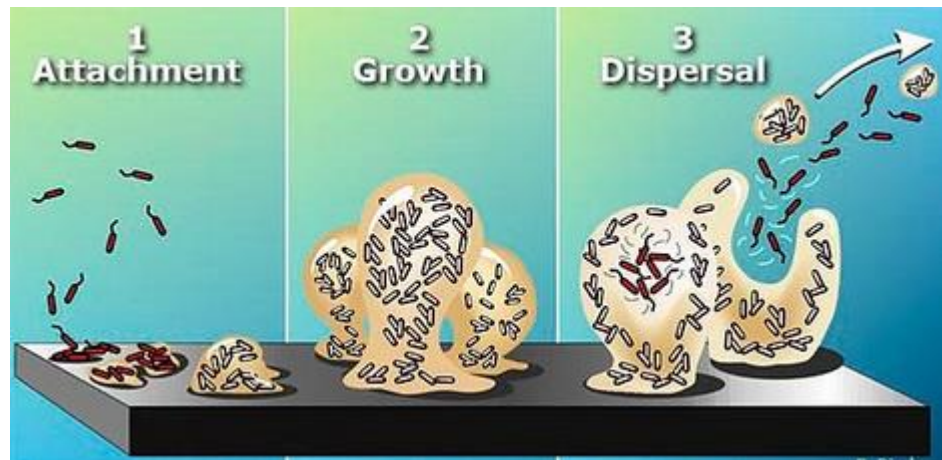

Figure 1.5 Demonstrates the biofilm life cycle. Initial bacteria attachment (left) biofilm growth (middle), biofilm maturation and dispersal (right).

Source: Stoodley, P., & Dirckx, P. (2003). *Biofilm formation in 3 steps*. Retrieved from Center for Biofilm Engineering: <https://www.biofilm.montana.edu/resources/images/multicellularextracellular/biofilm-formation-3-steps.html>.

Adherence enables the bacteria to produce extracellular polymeric substances which allows bacteria to embed themselves in a protective matrix (Busscher, 2012). In the case of CAUTIs, bacteria can adhere to the surface of the catheter and invade the body. Infection results from the bacteria attaching to host cells, generally epithelial cells. Once bacteria have established the site of infection, they will multiply and spread throughout the body. It is important to note that bacteria can adapt to a variety of environments and survivability is further enhanced by biofilm. The extracellular polymeric substances

provide mechanical stability to the biofilm (Busscher, 2012). Biofilm production on the surface of medical devices such as catheters can ensure bacteria survival and increase the chances of infection (Carroll, 2015).

1.8 Role of Biofilm in CAUTIs

Biofilm is composed of the adhering microorganisms and extracellular components. Typical catheter material is generally inert and as a result tends to be susceptible to bacterial adhesion. Inside the body, bacteria binding results in an immune-response which is generally characterized by an increase of neutrophil presence and removal of epithelial cells with bound bacteria (Trautner, 2004). As mentioned previously, biofilm enhances the survivability of the bacteria and thus its presence on the surface of catheter can ultimately result in persistent infections. In addition, other biofilm functions also include reducing the effect of shear forces, resistance to phagocytosis, and resistance to antimicrobial agents (Trautner, 2004).

In addition, to not preventing biofilm adhesion, the catheter also weakens the defense of the bladder in the sense the catheter acts as a method of transport between the otherwise sterile bladder and a heavy bacteria presence urethra (Trautner, 2004). Further, in the bladder or the catheter, urine tends to pool and the stasis can allow bacterial multiplication. Lastly, the presence of the catheter also damages the bladder mucosa layer by mechanical erosion and by stimulating an immune response. The catheter is a device that is often changed and while removing it can potentially prevent infection and enhance antibiotics, frequent removal wears down defenses and can be uncomfortable for the patients

CHAPTER 2

ANTIBACTERIAL MECHANISMS

Biofilm increase bacterial resistance to antibiotics to levels 500 to 5000 times higher than those needed to kill non-biofilm bacteria (Del Pozo, 2008). When biofilm is produced on the surface of a catheter or any other medical device, it can be difficult to remove and prevent continued growth. The following sections will discuss the methods and the mechanisms behind which bacteria is killed and biofilm growth is ultimately prevented.

2.1 Biofilm Resistance

Bacterial resistance is influenced by biofilm growth. Potential mechanisms that increase biofilm resistance to antimicrobial agents include restricted penetration to the biofilm matrix, enzymes capable of destroying antibiotics, stress response to hostility, and overexpression of genes (Del Pozo, 2008). Furthermore, biofilm also provides protection in dynamic environments wherein one might find different types of flow.

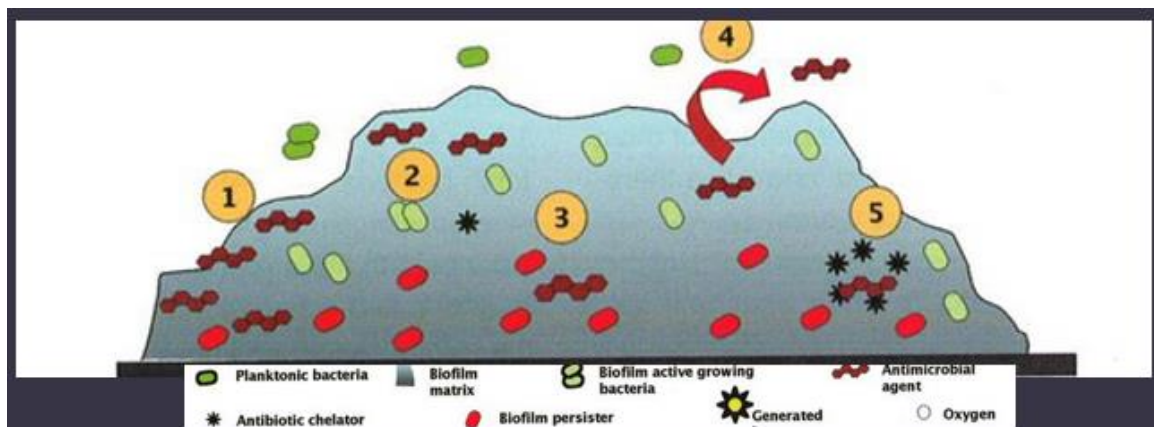

Figure 2.1 Diagram demonstrates the proposed ideas behind biofilm resistance. Source: Del Pozo, J., Rouse, M., & R., P. (2008). Bioelectric Effect and Bacterial Biofilms. A Systematic Review. *The International journal of artificial organs*, 786-795.

2.2 Application of Electrical Current

Bacterial cells are dependent up membrane potentials to maintain a certain level of metabolic activity. Applied electrical fields and currents can affect biological membranes as well as the metabolic and developmental process of cells. In some studies, it has been suggested that application of electrical current to bacteria can result in the production of toxic substances produced as a result of electrolysis such as H_2O_2 , chlorine molecules, and oxidizing radicals (Del Pozo, 2008). Furthermore, it has also been indicated that direct current can also result in oxidation of enzymes and coenzymes, membrane damage which can lead to the leakage of essential bacterial cytoplasmic components, and potentially a decrease in bacterial respiratory rate. This ultimately leads to bacteria cell death. If used in conjunction with antibiotics, it may be possible to develop devices that can prevent infection indefinitely. Although, it has been found that the application of electrical current alone has an antibacterial effect.

2.3 Bioelectric Effect Mechanisms

There are many ideas surrounding the mechanism of the bioelectric effect. There has yet to be one solid explanation. However, a current hypothesis is that applied electrical current reduces the biofilm capacity for binding to antimicrobial agents. It is believed that the matrix in which biofilm cells resided tend to bind to antimicrobial agents before they are able to reach the target cells (Del Pozo, 2008). Applying an electrical current may disrupt the matrix and thus allow the antibiotics to reach their necessary targets. Another, proposal is that an effect of the current is increased membrane permeability thus allowing antibiotics to enter the membrane.

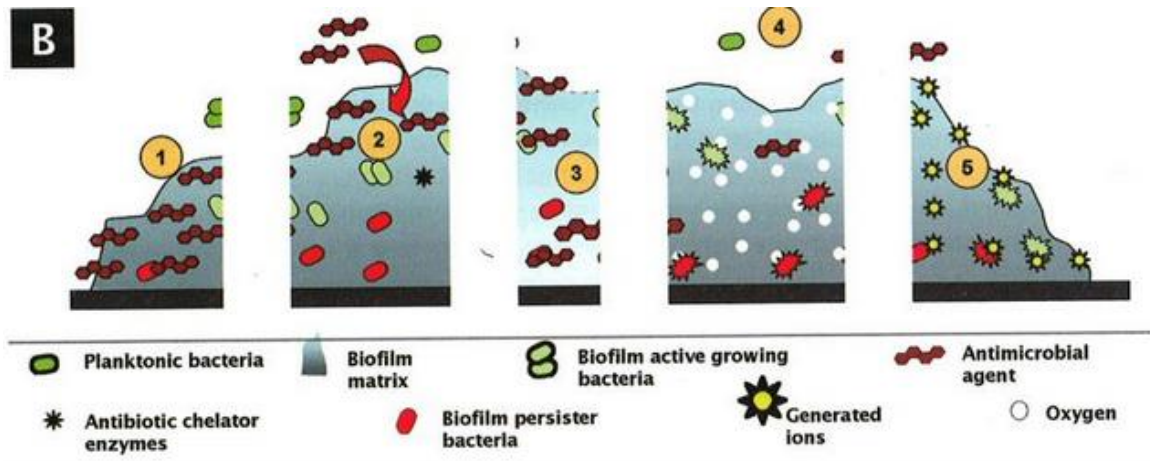

Figure 2.2 This diagram demonstrates the concepts that enable the bioelectric effect to be effective in killing bacteria.

Source: Del Pozo, J., Rouse, M., & R., P. (2008). Bioelectric Effect and Bacterial Biofilms. A Systematic Review. *The International journal of artificial organs*, 786-795.

2.4 Oligodynamic Effect

A botanist by the name of Carl Nageli initially discovered the oligodynamic effect. The term itself comes from the Greek word oligos meaning few and dynamis meaning power. He used this term to describe how low concentrations of metal ions to influence cell death (Rentz, 2003). The previous sections focuses upon bacteria and an important component of this study, the bioelectric effect. The following section continues to focus on different antibacterial solutions that can be applied to medical devices. More specifically, it will study the application of metals and how they influence bacterial cell death. As mentioned previously, there are millions of different types of bacteria. Many of these pathogenic bacteria are antibiotic resistant and thus it is necessary to develop solutions that can be effective against bacteria.

One of the primary components of this study was to explore the antibacterial characteristics of nanocopper particles. Silver is widely in silverware for its bactericidal properties. A possible explanation can be due to oligodynamic action. This essentially is the ability of metals to influence a lethal effect on bacterial cells (Shrestha, 2009). While the mechanism itself is still not fully understood, studies suggest that metal ions denature the proteins of the target cells by binding to reactive groups which results in inactivation.

2.4.1 Example Study

In one study, a group of scientists attempted to determine the impact of silver, copper, and brass. The water was contaminated with gram negative pathogens such as *Escherichia Coli*, *Salmonella* in addition to other multi drug resistant bacteria. They were attempting to study the oligodynamic action of metal pots. The graph below indicates the effect of the metal on *Escherichia Coli* which was found to be more susceptible to this mechanism. They found a reduction in the bacteria within 4 hours of placement in to pots made of copper and brass (Shrestha, 2009).

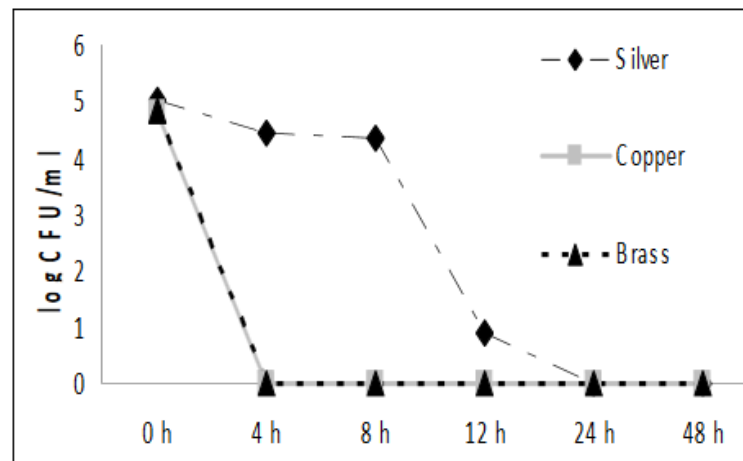

Figure 2.3 Notice after 4 hours the load of *E. coli* is reduced significantly in all the metal environments

Source: Shrestha, R. D. (2009). Oligodynamic Action of Silver, Copper, and Brass on Enteric Bacteria Isolated from Water of Kathmandu Valley. *Nepal Journal of Science and Technology*.

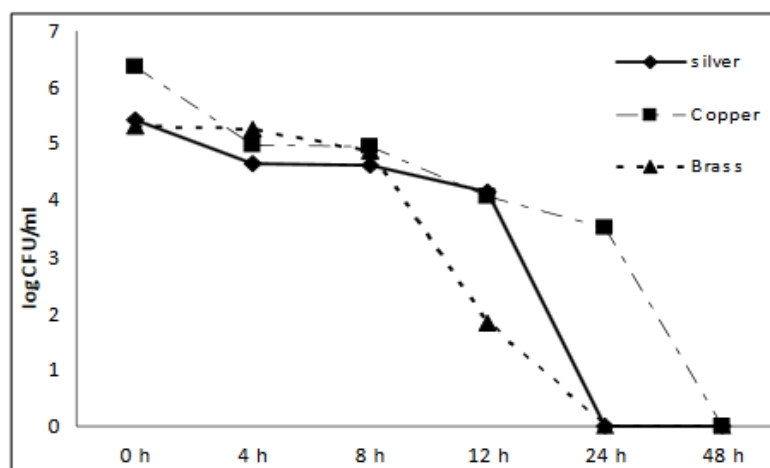

Figure 2.4 This is the effect of oligodynamic action on multidrug resistant *E. coli*. Notice that it took an additional 44hrs for the bacteria to be eliminated.
 Source: Shrestha, R. D. (2009). Oligodynamic Action of Silver, Copper, and Brass on Enteric Bacteria Isolated from Water of Kathmandu Valley. *Nepal Journal of Science and Technology*.

2.5 Cu Nanoparticles

Cu nanoparticles can be potentially a solution for all antibacterial purposes. Figure 5.2.1 demonstrates the various mechanisms of antimicrobial activity of the metal nanoparticles. According to scientists, it is believed that the nanoparticles cross through the bacterial cell membrane and are then able to influence destruction of significant bacterial enzymes triggering cell death. Various sizes of nanocopper were used in the proceeding study to determine if the size would affect the rate of cell death. The smaller the material, the greater the surface to volume ratio and thus a higher reactivity.

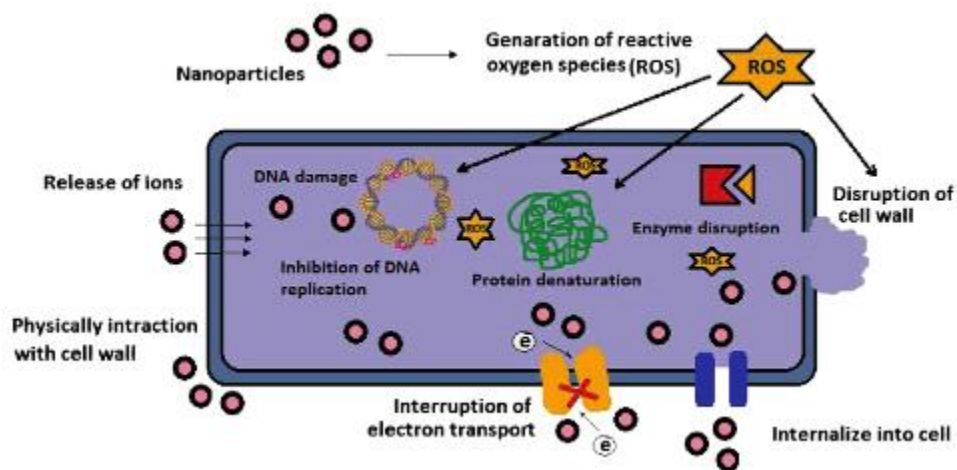

Figure 2.5 Various antibacterial mechanisms of metal nanoparticles.

Source: Azam A, A. A. (2012). *Antimicrobial Activity of Metals and Metal Oxide Nanoparticles Material Science & Engineering*. Retrieved from Pubmed: <http://www.ncbi.nlm.nih.gov/pubmed/23233805>

Chapter 3

Experimental Setup

3.1 Sample Preparation

This particular study was performed over the course of a year. The purpose of this initial study was to design and develop an antibacterial foley catheter in hopes of eliminating the occurrence of the infections. By doing so, the hope was that frequency of catheter removal and insertion would be dramatically decreased. In addition the other hope was that frequent hospital visits could also be reduced. The initially study involved coated several samples of medical grade silicone that was obtained from an industrial supplier of silicone rubbers and other polymers. The material initially was in the form of liquid silicone elastomers which required to be cured. The material itself possessed a very high viscosity and would adhere practically too any surface that it came in contact with which turned out to be problematic when transferring the solution to other surfaces.

The nanoparticle sizes that were initially used varied between 45 to 50 nanometers. Nanomaterials can be difficult and frustrating to work with because during the experimental setup of this study, the nanocopper would form clusters. These clusters contained several nanoparticles which made it very difficult to quantify and determine a concentration. The only instrumentation that we could utilize was a scale that measured units in terms of micrograms. This was also a very difficult task as we were attempting to measure quantitates that would not influence cytotoxicity. There wasn't a really clear answer and with limited resources it was proposed that that this study while important, be

temporarily halted and to focus primarily on whether or not the copper would produce antibacterial effects.

Once the quantity was finally determined, the nanocopper particles were mixed with the silicone elastomers. However, due to the viscosity of the silicone elastomers, it was especially difficult ensuring that the copper had thoroughly dispersed in the solution. Methods to ensure an almost equal distribution involve stirring for long periods of time or using a high velocity viscometer. For this study the nanoparticles were added to the mixture and stirred for approximately 10 minutes. This was repeated for each additional study. If the latter were available, it is possible that results would have been more positive and demonstrate antibacterial effectiveness.

Once this mixing step was completed, the silicone elastomers mixed with nanocopper was placed between two heavy hot press plates. The hot press has a temperature indicator for both plates. Because the particular polymer we were working with cures at 150 degrees Celsius, it was important to ensure that both plates reached that temperature so that the material would cure thoroughly. Otherwise, it would be difficult to remove the material from the hotplates. The shape of the final product was determined by using metal shims that were placed in between the hot plates of the press. They had specific thicknesses and areas. Overall, 18 samples were created for the inhibition assays using the methods described above. Furthermore, in preparation for the biofilm assay, discs of about 0.5 cm in diameter were cut out of the material created giving a total of 30 samples. The restriction of materials limited the ability to produce several more samples.

Another method of preparation involved sputtering. This was attempted to coat the substrate using copper. This is performed by the initial creation of a gaseous plasma and

then having ions accelerate into the source material. While this experiment did work and copper which as result wears down and ejects neutral particles which will travel in straight line unless they come into contact with something (Sputtering). For the purpose of the study, a silicone substrate was coated by a thin film of copper. It was observed upon completion that the film coating the surface of the silicone material carried charge however, it smeared easily which is not ideal for invasive medical devices.

3.2 Circuit Design

Through research it was found that an application of direct current could potentially inhibit bacterial growth. For this source of a current, a simple circuit was developed using a 9 volt battery as a power source. The circuit was switch operated and utilized an LED to indicate battery power level. The resistor used was 15kiloohm and with a 9 volt battery that outputted a current of 600 micro amps. For the purpose of medical device development, this amount of current was found to be safe because it is still less than 1 Amp which can potentially be fatal.

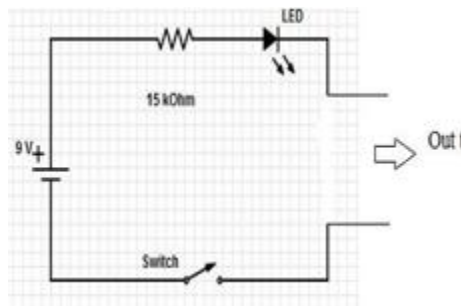

Figure 3.1 Circuit Diagram indicating where the +/- leads should connect.

3.3 Zones of Inhibition

This particular part of the study was completed at Rutgers University in New Brunswick, New Jersey. The study involved incubating bacteria, specifically in colonies of *E. coli* and *Staph.* in agar solution over a period of 24 hours and placing 18 samples cut to 0.5 cm diameter circles into the petri dishes. The study was done in an attempt to determine if the silicone material inhibited growth of the bacteria. To determine the efficacy, we would need observe zones of inhibition surrounding the samples. If zones were found, this would indicate that there was a presence of nanocopper on the surface of the material. It is also possible to infer that the formation of zones of inhibition would also indicate that there is no bacteria growth on the surface of the sample itself. This study was again repeated for different sized copper particles. However, as a result of time restraints, the electrical components of the study could not be studied.

3.4 Application of Electrical Current Test

Due to time restraints, the electrical components of the study were not able to be tested at Rutgers University. Thus the test was completed at NJIT using similar methods. The primary difference was instead of testing the efficacy of copper coated media, an electrical current was tested instead. However, due to fear of contamination the study was completed in a lab where there was potentially a high risk of contamination from the external environment. However, non-pathogenic *E.coli* was obtained through Rutgers University for this study. However, due to limited resources and time, there was only one available sample for this study. The following protocol was used in the first and second tests.

The materials used in this study included the following:

1. Agar Plates
2. Hard Agar Tryptic Soy
3. Soft Agar Tryptic Soy
4. Inoculating Loops
5. Bacteria (Non-pathogenic-*E.coli*)
6. Incubator
7. DC Circuit
8. Vortex Tubes
9. Vortex Machine

The following procedure describes the methods used in the sample preparation for all the samples.

Initially, the hard agar needed to be melted and the petri dishes required to be setup which simply required installing the electrodes as seen in Figure 6.2. The hard agar was melted using a hot water bath and then added to the dishes and left under UV overnight. The next day, the soft agar was melted and poured into a vortex tube. Using inoculating loops, colonies from the dish given to us from Rutgers University were mixed into the soft agar in the vortex tube. The tube was then vortexed for approximately 30 seconds to ensure that the bacteria were thoroughly mixed in. 10-15 ml of this solution was poured into the hard agar plate that was placed under UV and was sealed. During this entire process, it was important to turn on the incubator as it normally takes a while for it to warm up. After 10 minutes, the soft agar hardened and was placed inside the incubator upside down to

prevent condensation from ruining the sample. The temperature inside the incubator needed to remain at 37 degrees Celsius.

Next, alligator clips were attached to each electrode and the circuit. While the plate was inside the incubator the circuit for obvious reasons needed to remain outside which was not a problem because the alligator clip wires were quite long. The circuit was switched on and left for 24 hrs. Upon completion of the study, the plates were sterilized using 80% ethanol before disposal.

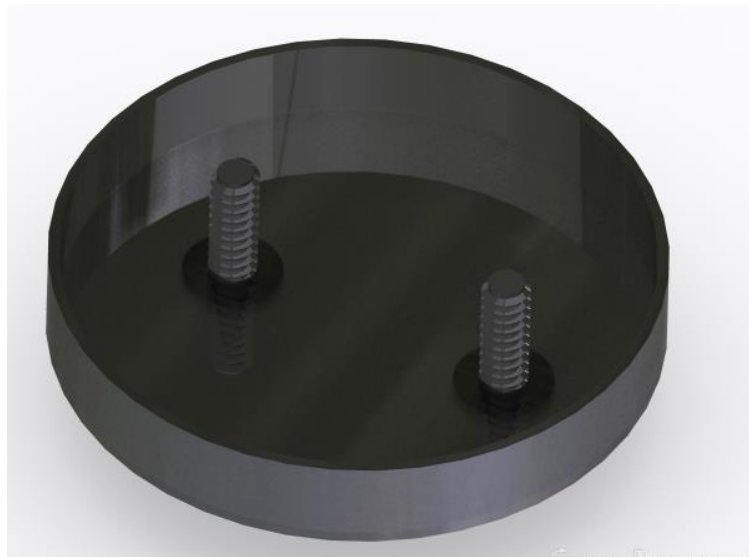

Figure 3.2 This is the setup for the electrical test. The current would move between the electrodes (screws) creating a complete circuit over the bacterial media.

Based off the results of this study which will be discussed later, it was proposed to determine the efficacy of an alternating current on bacterial growth. However, due to lack of resources and a lab to support these studies, it was not possible to perform this test. However, the proposed ideas for this circuit involved using an NE555 timer. The benefit of using this particular electrical component is that it gives an option of either utilizing its astable or monostable functionality. The monostable function allows adjustment of pulse

duration whereas a stable allows for an oscillating output. Another idea, involved using a power supply to produce the alternating current but because of the inability to set this up at Rutgers due to lab restrictions and lack of equipment availability this was also not possible.

3.5 Biofilm Inhibition

This next test involved determining the efficacy of removing all traces of biofilm on the surface of that catheter material. This test was also completed at Rutgers University of New Brunswick in the Microbiology Department under lab safety conditions. . Bacterial adhesion was monitored using USA 300_LAC strain of Methicillin resistant *Staphylococcus Aureus*. The bacteria for this particular test required that only individuals who were trained were allowed to perform these tests. In addition, the bacteria were incubated at 37 degrees Celsius under standard conditions. The 30 samples were prepared the same exact way as mentioned previously. The primary difference between this test and the initial test was that this time the efficacy of preventing biofilm adhesion was attempted. Further, the test attempted to compare non treated samples to treated samples. The samples were prepped and cut using a circle cutting tool. This allowed for the samples to be placed in small vials during testing. There was a control group which was composed of 10 non-coated discs which were initially tested to determine if biofilm would grow on the samples and how well it would grow. The second test involved using 20 treated samples which were composed of both 25 nm and 50 nm nanocopper particles. The test would measure the quantity of colonies of bacteria.

It is important to note that this study was conducted at Rutgers University and required biosafety lab.

3.6 Results of Zones of Inhibition Test

For the initial test several samples of silicone coated with nanocopper were created. The sizes varied by size. This test was done to determine if nanocopper had any inhibiting effect on *E Coli*, and *Staph*. As you can see in the figures below, it appears as there is inconsistency amongst the inhibition zone sizes. This possibly is due to different levels of concentration or even different quantities of nanocopper actually appearing on the surface of the silicone material itself which will influence the quantity of cell death. However, the results still demonstrate that the nanocopper is effective in killing bacteria and with the right application and tools it could potentially be implemented into a medical device. In the samples below, the zones of inhibition look like dark circular regions surrounding the samples.

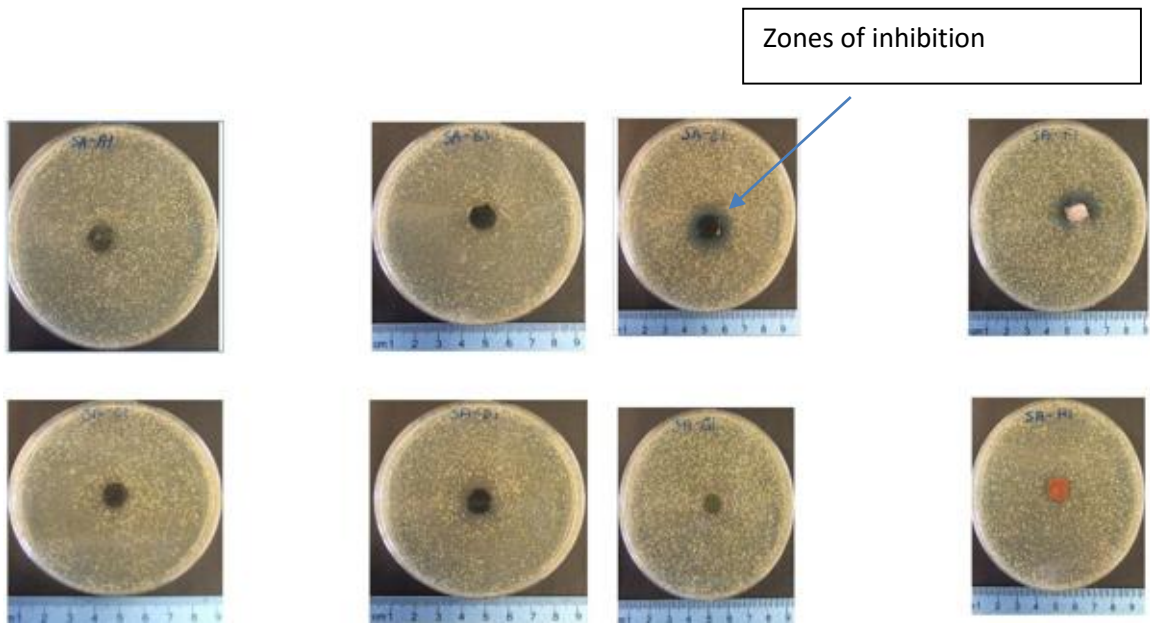

Figure 3.3 Zones of inhibition around the various samples of silicone coated material.

3.7 Results of Bioelectric Effect Test

After the first 24 hours of incubating and running the electrical current, we found that a large zone of inhibition formed around the electrode attached to the positive terminal of the circuit. We thought that this potentially could mean that the bacteria was in fact polarized and thus switching the leads that connected each electrode would give us a zone of inhibition around the other electrode. See figure below. The current remained the same as it was measured using voltmeter each morning and evening over the course the experiment.

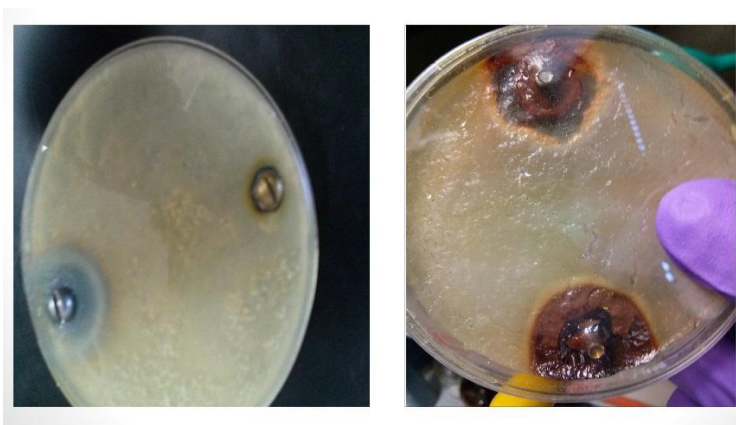

Figure 3.4 This picture demonstrates the zone of inhibition around the electrodes. The picture demonstrates on the left demonstrates the first 24 hours and the picture on the right demonstrates 48 hrs. after the polarity was switched.

Table 3.1 Shows the size of the diameters of one sample over the course of 24, 48 hours appearing around the +/- electrodes.

	24 Hours		48 hours	
+/- Electrode	+	-	+	-
Diameter of Zone	0.5 cm	0.2 cm	0.6cm	0.5cm

3.8 Results of Biofilm Elimination Test

For this test, bacteria were grown with and without the discs (treated/non-treated) for about 7 hours. Then the discs were washed to remove any loose bound bacteria cells. Following that, whatever bacteria cells were remaining on the sample discs were dislodged and quantified. The amount of bacteria present in the original containers was also quantified. Doing so would aid in determining if there was any effect on the growth rate when discs are added or whether the copper discs affect bacterial growth.

Table 3.2 Demonstrates the Mean and Standard Deviation Values for Biofilm Growth. Based off the Data it was Determined that the Nanocopper had no Effect upon the Bacterial Growth

	Sample Size	Hours	Average	Std Deviation
Non-treated	10	7	9.00E+06	5.57E+06
Non-treated	10	22	2.42E+06	1.94E+06
Cu25	10	7	5.83E+06	3.40E+06
Cu25	10	22	7.83E+05	4.04E+05
Cu50	10	7	1.07E+07	1.04E+06
Cu50	10	22	9.17E+05	4.65E+05

The results shown in table 3.2 demonstrate that there was no significant difference between treated or non-treated samples upon bacteria growth and is further supported by the results of an analysis of variance test (ANOVA). The purpose of the performing this particular test was to determine whether or not there was a difference between the mean bacterial growths amongst all three treatment types. It is common practice in this test to assume for the null hypothesis that the means are all equal. Upon completion of an F-test, it was clear that there was not a significant difference among all treatment means because

the null hypothesis was not rejected. Because the means were quite similar, there was no significant difference amongst the treatment means. See Table 3.2. Similarly, an ANOVA was completed for the different treatments at 22 hours to determine if there was a difference in means. Based off calculations, the null hypothesis should not be rejected thus again indicating that there is no significant difference between the sample means.

Table 3.3 ANOVA Test for Determining the Difference of Means at 7 Hours between the Treatment Groups

Source of Variation	Sum of Squares	dF	MS	F
Between	6.11E+13	2	3.05E+13	2.10
Within	1.75E+14	12	1.46E+13	
Total	2.36E+14	14		

$$H_o: \mu_1 = \mu_2 = \mu_3$$

$$H_1: \text{means not all equal}$$

$$\text{Reject } H_o \text{ if } F \geq 3.89$$

$$\text{Do Not Reject } H_o \text{ if } F < 3.89$$

Table 3.4 ANOVA Test for Determining the Difference of Means at 22 Hours between the Treatment Groups

Source of Variation	Sum of Squares	dF	MS	F
Between	8.26E+12	2	4.13E+12	0.297
Within	1.67E+14	12	1.39E+13	
Total	1.75E+14	14		

$$H_o: \mu_1 = \mu_2 = \mu_3$$

$$H_1: \text{means not all equal}$$

$$\text{Reject } H_o \text{ if } F \geq 3.89$$

Do Not Reject H_0 if $F < 3.89$

It is also possible to determine the difference in mean between 2 groups using two-way ANOVA. See Figure In this particular case the two groups that can be considered are the groups present at 7 and 22 hours. According to the test, there was no significant difference between the samples when it comes to bacteria quantity. In addition, there was no significance between the times at which bacteria was counted. Thus, it is clear that there was not a significant interaction between the samples and bacteria counts at 7 and 22 hours.

Table 3.5 2-Way ANOVA Test to determine the difference in means between treatment options and time

Source of Variation	Sum of Squares	dF	Mean Squares	Calculated F	F(df1,df2) $\alpha = 0.05$
Samples	-2.16E+17	2	-1.08E+17	1.00E-17	3.4
Time	-1.82E+17	1	-1.82E+17	1.69E-17	4.26
Interaction	2.58E+35	2	1.29E+35	-1.20E+01	3.4
Within	-2.58393E+35	24	-1.07664E+34		
Total	-2.93E+17	29	-1.01E+16		

$$F_{\text{samp}} = 1.00E-17 < 3.4 \rightarrow \text{No significance}$$

$$F_{\text{Time}} = 1.69E-17 < 4.26 \rightarrow \text{No significance}$$

$$F_{\text{Within}} = -1.20E+01 < 3.4 \rightarrow \text{No significance}$$

In addition a power test was completed to determine how many samples were actually required to achieve significant results. For this type of analysis, a power level is required and it is the probability at which an effect will be able to be detected. Generally, a high power is recommended and thus a level of 0.8 was used. The study requires taking the largest difference in means. In this case, at the 7 hour mark, it is the difference between the mean of Cu25 and Cu 50. It also requires using the mean square error which found while performing an ANOVA test. The required number of samples for this study to ensure

that a treatment effect is observable at 26. See Figure 3.5. The tables above references the data in table 3.2.

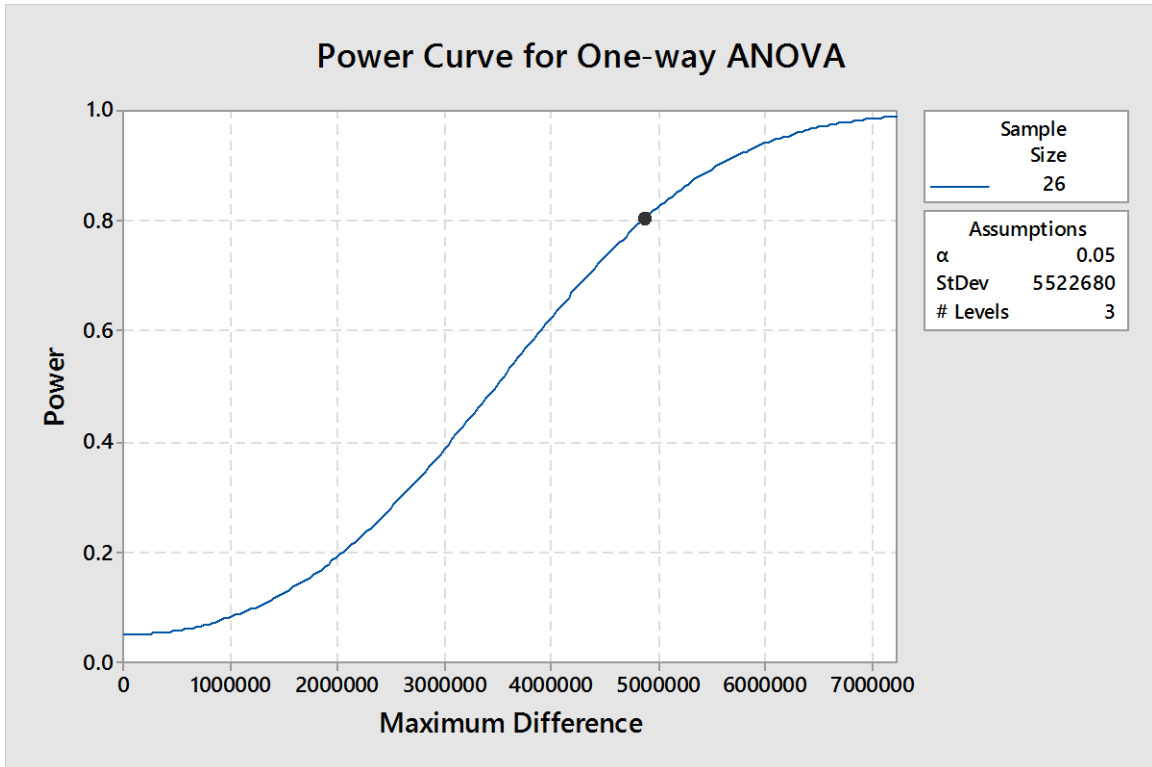

Figure 3.5 This graph indicates the sample size based on the power of 0.8. In order to achieve significant results, the number of samples must be around 26. This was completed using a one-way ANOVA to find sample size.

Also quite noticeable is the large standard deviation sizes which is generally expected during biofilm assay tests. Another possible reason that the standard deviations are so high could be attributed to sample size. Upon further review, it was discovered that the samples had variable thickness. This translates to more surface area for bacteria to adhere on to which may have also factored into why the data appeared as it did. Both the non-treated and treated samples were found to have bacterial binding at the same rate and amount.

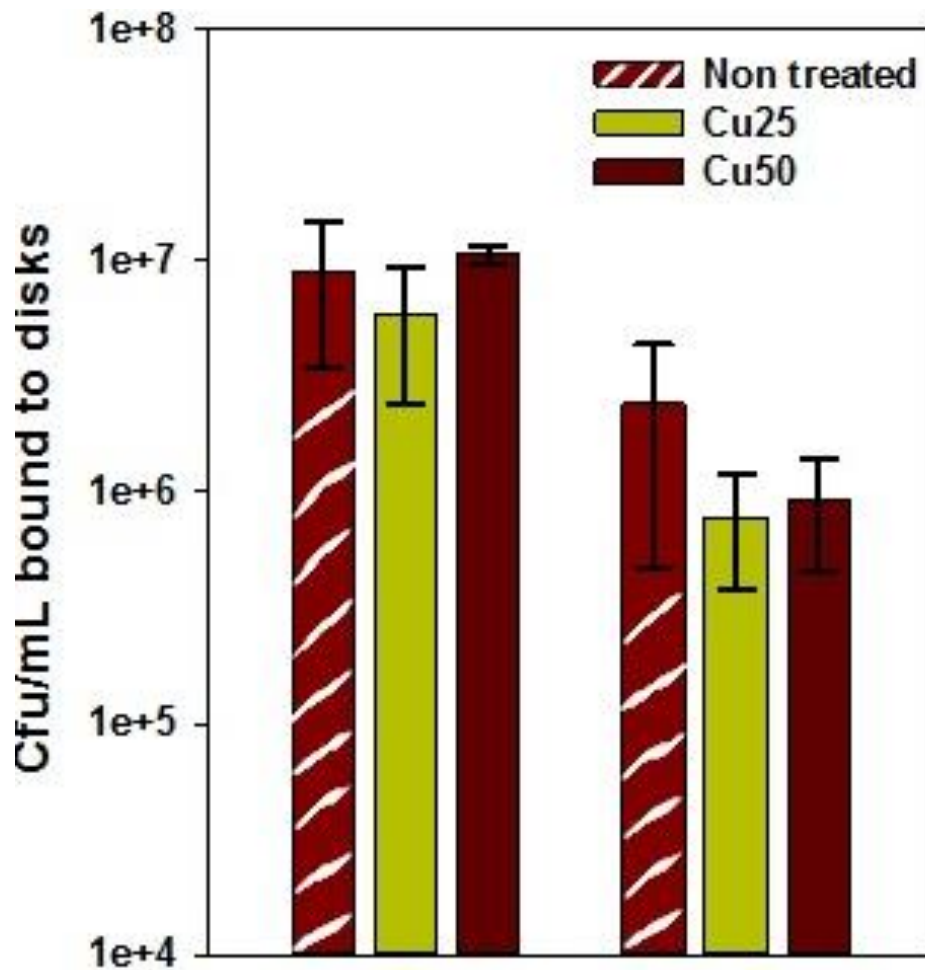

Figure 3.6 The biofilm growth after the initial early biofilm stage at 7 hours and late maturation at 22 hours. There was no noticeable impact on the bacterial growth seen by between the non-treated and treated samples. The standard deviations are indicated by the error bars.

To further support the data in the table above the graphs above further demonstrate that there was no significant difference between the quantity of bacteria adhering to both the non-treated and treated copper coated discs. Furthermore, it may appear based off the graph that after a period of 22 hours the quantity of biofilm overall declined for all the different types of samples. This is actually a result of the biofilm reaching the maturation stage at which point the biofilm disperses. The decline can also be associated with the decline in nutrients for the biofilm to maintain that volume. The y-scale is a logarithmic

scale which is used because of the large values present in the data associated with the colony forming count. Colony forming units generally refer to colonies of bacteria and are used to measure the quantity of microorganisms present on a surface.

Chapter 4

CONCLUSION

The results of this study while mixed, were very informative. While there are only a few studies that currently exist that explore antibacterial efficacy of nanoparticles, copper, and electrical current (refs), this particular study demonstrated the potential value of nano-Cu/electrical current to a real world medical device applications. This was accomplished by presenting strong evidence of hospital related infections and discussing the invasive devices which can often unintentionally compromise the patient's immune system. While the study was primarily targeting CAUTIs, it's important to note that this concept can be applied towards preventing other medical device related infections. The goal of the initial testing was to observe whether zones of bacterial inhibition were forming on the sample surface, indicating that that the nanocopper was expressing antibacterial properties. This was in fact the end result of this experiment. Although there were clear zones of inhibition around several of the samples in the first experiment, there was some variability between the different samples which could be attributed to the variability in the sample preparation method. Specifically, it was likely that the nanocopper concentration varied among the samples and that much of nanocopper that was present in the samples that demonstrated very little antibacterial activity were actually on the surface of the sample, inhibiting bacterial attachment.. The second experiment attempted to focus upon the anti-bacterial efficacy of low direct electrical current. It was also found here that the direct current exhibited antibacterial properties by producing zones of inhibition. The third and last set of experiments were focused towards further determining whether these concepts could be

applied towards the development of improved, anti-bacterial, invasive medical devices. Often, invasive medical devices become the site of biofilm growth. In doing so, they can result in frequent device removal, hospital visits, and increased healthcare costs. The objective of this experiment was to determine whether the presence of nanocopper would prevent biofilm formation. The third study was inconclusive as the results that were produced did not demonstrate that nanocopper exhibited any significant antibacterial activity towards biofilm growth. Potential reasons for these outcomes could have been the result of a variety of factors. One possibility is that a percolation density of the nanocopper was not dispersed evenly enough towards the top of surface of the silicone materials thus minimizing the effect. The presence of imaging may could have been a potential solution to this. Another contributing factor was the lack of uniformity of sample thickness, providing more surface area for the bacteria to adhere and increasing the variability between samples. Finally, an increased sample size (number of specimens tested) would have given the test results more statistical significance.

Based on all the results, it can be concluded that that under the right conditions and preparation nanocopper and application of an electrical current has the potential to be an effective means of preventing medical device related infections. To validate this in future work, the sample size should be increased. Further, from the results of the bioelectric effect study, it was demonstrated that the application of direct current had produced zones of inhibition. However, as shown in Figure 7.2 the zones differed in terms of size. After altering the polarity, it was observed that the zones were nearly of equal size. This gives reason to believe that bacteria possess some form of polarity. The application of an

alternating current could potentially be solution for this and should be investigated. It would also be advantageous to do a repeat study on the effect of nanocopper on both bacteria and biofilm. However, instead of hand mixing the silicone and nanocopper, use a more intense and reproducible mixing method such as a high velocity viscometer should be employed to ensure a thorough dispersal of nanocopper particles. In addition, it also may be beneficial to quantify using high powered imaging and in doing so save resources and prepare more effective samples. Lastly, for the purpose of medical device development, it would be an interesting study to determine the whether the combination of nanocopper of electric field had a synergistic effect on antibacterial efficacy

Overall, the aim of this thesis was able to examine the antibacterial efficacy of nanocopper and an electrical stimulus. While the study produced mixed results, it is clear that under the right conditions and right applications, these concepts can be applied in the development of future medical devices.

REFERENCES

- Azam A, A. A. (2012). *Antimicrobial Activity of Metals and Metal Oxide Nanoparticles Material Science & Engineering*. Retrieved from Pubmed:
<http://www.ncbi.nlm.nih.gov/pubmed/23233805>
- Boyer A.F., Kollef M.H. (2015). Healthcare-Acquired Pneumonia, Including Ventilator-Associated Pneumonia. In Grippi M.A., Elias J.A., Fishman J.A., Kotloff R.M., Pack A.I., Senior R.M., Siegel M.D. (Eds), *Fishman's Pulmonary Diseases and Disorders, Fifth Edition*. Retrieved April 22, 2016 from
<http://accessmedicine.mhmedical.com/content.aspx?bookid=1344&Sectionid=81199415>
- Busscher, H. J., & Van der Mei, H. C. (2012, January 26). *How Do Bacteria Know They Are on a Surface and Regulate Their Response to an Adhering State?* Retrieved from PLOS Pathogens:
<http://journals.plos.org/plospathogens/article?id=10.1371%2Fjournal.ppat.1002440>
- Carroll K.C., Hobden J.A., Miller S, Morse S.A., Mietzner T.A., Detrick B, Mitchell T.G., McKerrow J.H., Sakanari J.A. (2015). The Science of Microbiology. In Carroll K.C., Hobden J.A., Miller S, Morse S.A., Mietzner T.A., Detrick B, Mitchell T.G., McKerrow J.H., Sakanari J.A. (Eds), *Jawetz, Melnick, & Adelberg's Medical Microbiology, 27e*. Retrieved April 23, 2016 from
<http://accessmedicine.mhmedical.com/content.aspx?bookid=1551&Sectionid=94105059>.
- Costerton, J. W. (1999, May). *Introduction to Biofilm*. Retrieved from ScienceDirect:
<http://www.sciencedirect.com/science/article/pii/S0924857999000187>
- Del Pozo, J., Rouse, M., & R., P. (2008). Bioelectric Effect and Bacterial Biofilms. A Systematic Review. *The International journal of artificial organs*, 786-795.
- Flanders S.A., Podrazik P.M., Whelan C, Blaum C (2009). Chapter 17. Acute Hospital Care. In Halter J.B., Ouslander J.G., Tinetti M.E., Studenski S, High K.P., Asthana S (Eds), *Hazzard's Geriatric Medicine and Gerontology, 6e*. Retrieved April 22, 2016 from
<http://accessmedicine.mhmedical.com/content.aspx?bookid=371&Sectionid=41587623>.
- Foley Catheters*. (n.d.). Retrieved from Bard Medical:
<http://www.bardmedical.com/products/urological-drainage/foley-catheters/>

- Garrett, T. R., Bhakoo, M., & Zhang, Z. (2008, September 10). *Bacterial Adhesion and Biofilms on Surfaces*. Retrieved from ScienceDirect:
<http://www.sciencedirect.com/science/article/pii/S1002007108002049>
- Gupta K, Trautner B.W. (2015). Urinary Tract Infections, Pyelonephritis, and Prostatitis. In Kasper D, Fauci A, Hauser S, Longo D, Jameson J, Loscalzo J (Eds), *Harrison's Principles of Internal Medicine, 19e*. Retrieved April 23, 2016 from <http://accessmedicine.mhmedical.com/content.aspx?bookid=1130&Sectionid=79734151>.
- Jones D, Kho A, Francesco L (2012). Chapter 91. Hypotension. In McKean S.C., Ross J.J., Dressler D.D., Brotman D.J., Ginsberg J.S. (Eds), *Principles and Practice of Hospital Medicine*. Retrieved April 22, 2016 from <http://accessmedicine.mhmedical.com/content.aspx?bookid=496&Sectionid=41304063>.
- Kemp W.L., Burns D.K., Brown T.G. (2008). Chapter 8. Hemodynamics. In Kemp W.L., Burns D.K., Brown T.G. (Eds), *Pathology: The Big Picture*. Retrieved April 22, 2016 from <http://accessmedicine.mhmedical.com/content.aspx?bookid=499&Sectionid=41568291>.
- Klompas M (2012). Chapter 194. Healthcare and Hospital-Acquired Pneumonia. In McKean S.C., Ross J.J., Dressler D.D., Brotman D.J., Ginsberg J.S. (Eds), *Principles and Practice of Hospital Medicine*. Retrieved April 22, 2016 from <http://accessmedicine.mhmedical.com/content.aspx?bookid=496&Sectionid=41304181>.
- Mandell L.A., Wunderink R.G. (2015). Pneumonia. In Kasper D, Fauci A, Hauser S, Longo D, Jameson J, Loscalzo J (Eds), *Harrison's Principles of Internal Medicine, 19e*. Retrieved April 22, 2016 from <http://accessmedicine.mhmedical.com/content.aspx?bookid=1130&Sectionid=79733578>.
- Rentz, E. J. (2003). Viral Pathogens and Severe Acute Respiratory Syndrome: Oligodynamic Ag+ for Direct Immune Intervention. *Journal of Nutritional & Environmental Medicine*, 109-118.
- Ross J.J. (2012). Chapter 205. Urinary Tract Infections and Pyelonephritis. In McKean S.C., Ross J.J., Dressler D.D., Brotman D.J., Ginsberg J.S. (Eds), *Principles and Practice of Hospital Medicine*. Retrieved April 22, 2016 from <http://accessmedicine.mhmedical.com/content.aspx?bookid=496&Sectionid=41304192>.
- Ryan K.J., Ray C (2014). Principles of Laboratory Diagnosis of Infectious Diseases. In Ryan K.J., Ray C (Eds), *Sherris Medical Microbiology, 6e*. Retrieved April 23, 2016 from <http://accessmedicine.mhmedical.com/content.aspx?bookid=1020&Sectionid=56968646>.

- Schwartz B.S. (2014). Urinary Tract Infections. In Levinson W (Eds), *Review of Medical Microbiology and Immunology, 13e*. Retrieved April 22, 2016 from <http://accessmedicine.mhmedical.com/content.aspx?bookid=1023&Sectionid=57053527>.
- Shelley S. Magill, M. P.-H. (2014). *Multistate Point-Prevalence Survey of Health Care–Associated Infections*. Retrieved from The New England Journal of Medicine: <http://www.nejm.org/doi/ref/10.1056/NEJMoa1306801#t=references>
- Shrestha, R. D. (2009). Oligodynamic Action of Silver, Copper, and Brass on Enteric Bacteria Isolated from Water of Kathmandu Valley. *Nepal Journal of Science and Technology*.
- Sputtering*. (n.d.). Retrieved from AJA International INC: <http://www.ajaint.com/what-is-sputtering.html>
- Stevens D.L. (2015). Infections of the Skin, Muscles, and Soft Tissues. In Kasper D, Fauci A, Hauser S, Longo D, Jameson J, Loscalzo J (Eds), *Harrison's Principles of Internal Medicine, 19e*. Retrieved April 22, 2016 from <http://accessmedicine.mhmedical.com/content.aspx?bookid=1130&Sectionid=79733782>.
- Stoodley, P., & Dirckx, P. (2003). *Biofilm formation in 3 steps*. Retrieved from Center for Biofilm Engineering: <https://www.biofilm.montana.edu/resources/images/multicellularextracellular/biofilm-formation-3-steps.html>
- Trautner, B. W., & Darouiche, R. O. (2004). Role of Biofilm in Catheter Associated Urinary Tract Infection. *American Journal of Infection Control*, 177-183.
- Wunderink R.G., Waterer G (2015). Pneumonia. In Hall J.B., Schmidt G.A., Kress J.P. (Eds), *Principles of Critical Care, 4e*. Retrieved April 22, 2016 from <http://accessmedicine.mhmedical.com/content.aspx?bookid=1340&Sectionid=80034063>.