

## New Jersey Institute of Technology Digital Commons @ NJIT

---

Theses

Theses and Dissertations

---

Spring 2013

# Research on MPPT methods for photovoltaic system based on microgrid

Jingchu Ji

*New Jersey Institute of Technology*

Follow this and additional works at: <https://digitalcommons.njit.edu/theses>

 Part of the [Electrical and Electronics Commons](#)

---

### Recommended Citation

Ji, Jingchu, "Research on MPPT methods for photovoltaic system based on microgrid" (2013). *Theses*. 175.  
<https://digitalcommons.njit.edu/theses/175>

This Thesis is brought to you for free and open access by the Theses and Dissertations at Digital Commons @ NJIT. It has been accepted for inclusion in Theses by an authorized administrator of Digital Commons @ NJIT. For more information, please contact [digitalcommons@njit.edu](mailto:digitalcommons@njit.edu).

## **Copyright Warning & Restrictions**

The copyright law of the United States (Title 17, United States Code) governs the making of photocopies or other reproductions of copyrighted material.

Under certain conditions specified in the law, libraries and archives are authorized to furnish a photocopy or other reproduction. One of these specified conditions is that the photocopy or reproduction is not to be “used for any purpose other than private study, scholarship, or research.” If a user makes a request for, or later uses, a photocopy or reproduction for purposes in excess of “fair use” that user may be liable for copyright infringement,

This institution reserves the right to refuse to accept a copying order if, in its judgment, fulfillment of the order would involve violation of copyright law.

**Please Note: The author retains the copyright while the New Jersey Institute of Technology reserves the right to distribute this thesis or dissertation**

Printing note: If you do not wish to print this page, then select “Pages from: first page # to: last page #” on the print dialog screen

The Van Houten library has removed some of the personal information and all signatures from the approval page and biographical sketches of theses and dissertations in order to protect the identity of NJIT graduates and faculty.

## **ABSTRACT**

### **RESEARCH ON MPPT METHODS FOR PHOTOVOLTAIC SYSTEM BASED ON MICROGRID**

**by  
Jingchu Ji**

This thesis introduces some basic concepts about a microgrid. Then it discusses the structure of photovoltaic system (PVS) which contains a solar panel and simplified PV models. Next, it discusses and compares different methods for Maximum Power Point Tracking (MPPT) with PVS. It presents three types of DC-DC converters -- Buck, Boost and Buck-Boost converter. This work proposes to apply a DC-DC converter of Buck-Boost type to make PVS controllable because this type of converter has the largest range for operational region so that it can get the best result on MPPT. Finally, this thesis presents a kind of new MPPT method based on fuzzy logic theory. It concludes that the proposed method is effective in achieving MPPT in comparison with the prior arts.

**RESEARCH ON MPPT METHODS FOR PHOTOVOLTAIC  
SYSTEM BASED ON MICROGRID**

by  
**Jingchu Ji**

**A Thesis  
Submitted to the Faculty of  
New Jersey Institute of Technology  
in Partial Fulfillment of the Requirements for the Degree of  
Master of Science in Electrical Engineering**

**Department of Electrical and Computer Engineering**

**May 2013**

Blank Page

**APPROVAL PAGE**

**RESEARCH ON MPPT METHODS FOR PHOTOVOLTAIC  
SYSTEM BASED ON MICROGRID**

**Jingchu Ji**

---

Dr. Mengchu Zhou, Dissertation Advisor Date  
Professor of Electrical and Computer Engineering, NJIT

---

Dr. Hongya Ge Date  
Associate Professor of Electrical and Computer Engineering, NJIT

---

Dr. Yunni Xia Date  
Associate Professor of School of Computer, Chongqing University

## **BIOGRAPHICAL SKETCH**

**Author:** Jingchu Ji  
**Degree:** Master of Science  
**Date:** May 2013

### **Undergraduate and Graduate Education:**

- Master of Science in Electrical Engineering,  
New Jersey Institute of Technology, Newark, NJ, 2013
- Bachelor of Science in Automation,  
China University of Petroleum, Dongying, Shandong Province, P. R. China, 2011

**Major:** Electrical Engineering



我想感谢我的父母，因为他们不仅养育了我，还教会我如何做人以及获取知识。在他们不断的鼓励中，我可以坦然面对各种难题。另外，还要感谢在座论文期间所有提供帮助的人们。

Dedicated to my family, all inclusive, known and unknown – for the gift of life, and supports during the research.

## ACKNOWLEDGMENT

I would like to thank for the supports and guidance of Dr. Mengchu Zhou. He is not only my academic endeavor, but my personal ones as well. Professor Zhou served as my research advisor, but he was very influential in the academic path chosen I have made. Also, he help me finding solutions to solve those problems during the research.

Also, I appreciate all the members in the committee for giving me valuable advises about my thesis' future work and improvements.

I want to thank for Ms. Gonzalez too. She has guided me a lot about the thesis work, and helps me finish it.

## TABLE OF CONTENTS

<b>Chapter</b>		<b>Page</b>
1	INTRODUCTION.....	1
1.1	Background Information.....	1
1.1.1	Distributed Generation.....	1
1.1.2	Microgrid.....	2
1.2	Solar Energy.....	3
1.2.1	Instruction of Solar Energy.....	3
1.2.2	Economics.....	5
1.2.3	Other Advantages of Solar Energy.....	6
2	PHOTOVOLTAIC SYSTEM MODEL.....	8
2.1	Solar Panels.....	8
2.1.1	Concept of a Photovoltaic System.....	8
2.1.2	Mounting Systems.....	8

**TABLE OF CONTENTS**  
**(Continued)**

<b>Chapter</b>		<b>Page</b>
2.2	PV System Structure.....	9
2.2.1	Primary Components in PVS.....	10
2.2.2	Energy Costs.....	13
2.3	Photovoltaic System Model.....	14
2.3.1	Linear Power Model.....	14
2.3.2	Classical Single-diode Model.....	15
3	MAXIMUM POWER POINT TRACKING METHODS.....	17
3.1	Introduction of MPPT.....	17
3.1.1	I-V Curve.....	17
3.2	Perturb and Observe.....	19
3.3	Incremental Conductance.....	20
3.4	Fuzzy Logic-based MPPT.....	21

**TABLE OF CONTENTS**  
**(Continued)**

<b>Chapter</b>		<b>Page</b>
	3.4.1 Neuro-fuzzy MPPT Method.....	21
	3.4.2 Modified Hill-climbing Method with Fuzzy-Logic-Control.....	24
4	DC-DC CONVERTER.....	29
	4.1 Introduction of DC-DC Converter.....	29
	4.2 Buck Type Converter.....	30
	4.3 Boost Type Converter.....	33
	4.4 Buck-Boost Type Converter.....	34
5	PROPOSED RESEARCH METHOD.....	37
	5.1 Introduction of Proposed Method.....	37
	5.2 Fuzzy Logic Design.....	41
6	CONCLUSION.....	44
	6.1 Contribution.....	44
	6.2 Limitations and Future Directions.....	44

## LIST OF TABLES

<b>Table</b>		<b>Page</b>
2.1	Electrical STC Specifications of PV Panels.....	10
2.2	Cost Per Kilowatt Hour.....	14
3.1	Fuzzy Rule Assignment.....	23
5.1	Label Value of the Input of Fuzzy Logic Controller.....	41

## LIST OF FIGURES

Figure	Page
1.1 Solar cell production by region in globe.....	3
1.2 Average solar irradiance.....	4
1.3 Sun hours/day in Paris over one year.....	5
2.1 Solar cell model.....	15
3.1 The block diagram of the perturb and observe method.....	19
3.2 The block diagram of incremental conductance method.....	20
3.3 Architecture of the neuro-fuzzy network.....	22
3.4 Fuzzy rule-based classification system.....	22
3.5 Fuzzy reasoning method.....	23
3.6 Membership functions of input and output.....	23
3.7 Effect of increasing radiation density on P-D curve.....	24
3.8 Effect of increasing temperature on P-D curve.....	25
3.9 The block diagram of the modified system.....	26
3.10 Fuzzification rules of modified hill-climbing.....	26
3.11 Membership function of $\Delta P$ .....	27
3.12 Membership function of $\Delta I$ .....	27
3.13 Membership function of $\Delta D$ .....	28
4.1 PV module connected to the load through DC-DC converter.....	29

**LIST OF FIGURES**  
**(Continued)**

<b>Figure</b>	<b>Page</b>
4.2 I-V characteristic.....	30
4.3 Equivalent model for PV system.....	31
4.4 Example of load curves.....	32
4.5 Operational region for Buck converter.....	33
4.6 Operational region for Boost converter.....	34
4.7 Operational region for Buck-Boost converter.....	35
5.1 P-D curves with radiation density change.....	38
5.2 P-D curves with temperature change.....	39
5.3 Different bell curves under varying of $a$ .....	39
5.4 Different bell curves under varying of $b$ .....	40
5.5 Different bell curves under varying of $c$ .....	40
5.6 Membership function of input temperature.....	41
5.7 Membership function of input radiation density.....	42
5.8 Rule evaluation.....	43



# CHAPTER 1

## INTRODUCTION

### 1.1 Background Information

Recent years, due to the increasing demand for electrical energy and rapid development and deployment of renewable energy technologies, a significant amount of researches on microgrids including photovoltaic systems (PVS) has been performed.

#### 1.1.1 Distributed Generation

Distributed generation (DG) generates electricity from many small energy sources. Many countries generate electricity in large centralized facilities. These plants have excellent economies of scale, but usually transmit electricity long distances and negatively affect the environment. Distributed generation allows collection of energy from many sources and may lead to lower environmental impacts and improved security of energy supply.

DG plants are mass-produced, small, and less site-specific. Their development arose out of: concerns over perceived externalized costs of central plant generation, particularly environmental concerns; the increasing age, deterioration, and capacity constraints upon transmission and distribution (T&D) for bulk power; the increasing relative economy of mass production of smaller appliances over heavy manufacturing of larger units and on-site construction; and higher relative prices for energy, higher

overall complexity and total costs for regulatory oversight, tariff administration, and metering and billing.

DG reduces the amount of energy lost in transmitting electricity because the electricity is generated near where it is consumed, in many cases in the same building. This also reduces the size and number of power lines that must be constructed, which are required for the cases of using large centralized generation facilities.

Solar power has a low capacity factor, producing peak power at local noon each day. Average capacity factor is typically 20%.

### **1.1.2 Microgrid**

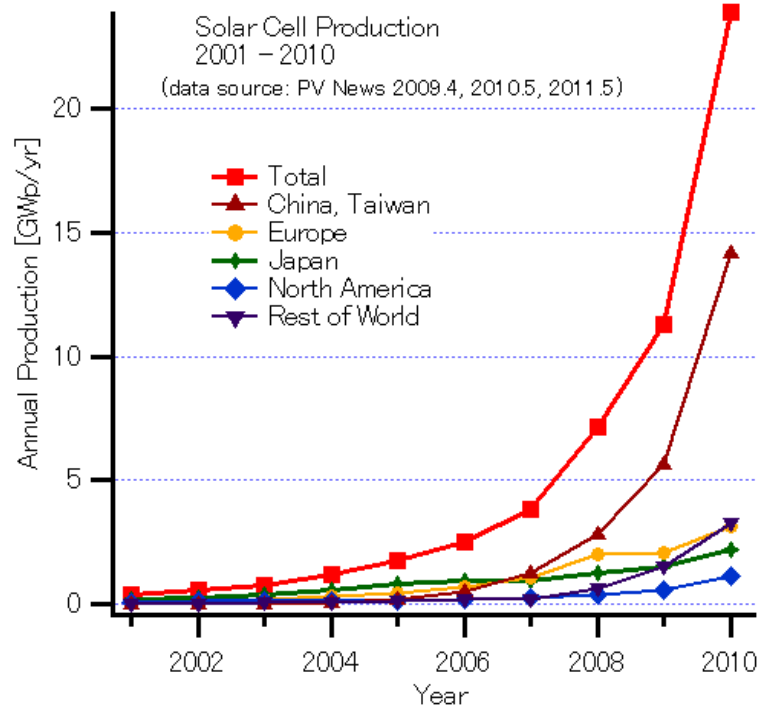
A microgrid is a localized grouping of electricity generation, energy storage, and loads that normally operate with the connection to a traditional centralized grid. This single point of common coupling with the microgrid can be disconnected. The microgrid can then function autonomously. Generation and loads in a microgrid are usually interconnected at low voltage. From the point of view of the grid operator, a connected microgrid can be controlled as if it was one entity. The multiple dispersed generation sources and ability to isolate the microgrid from a larger power grid would provide highly reliable electric power to users.

Small micro-grids cover 30–50 km radius. Small power stations of 5–10 MW are used to serve the micro-grids. They can generate power locally to reduce dependence on long distance transmission lines and cut transmission losses.

## 1.2 Solar Energy

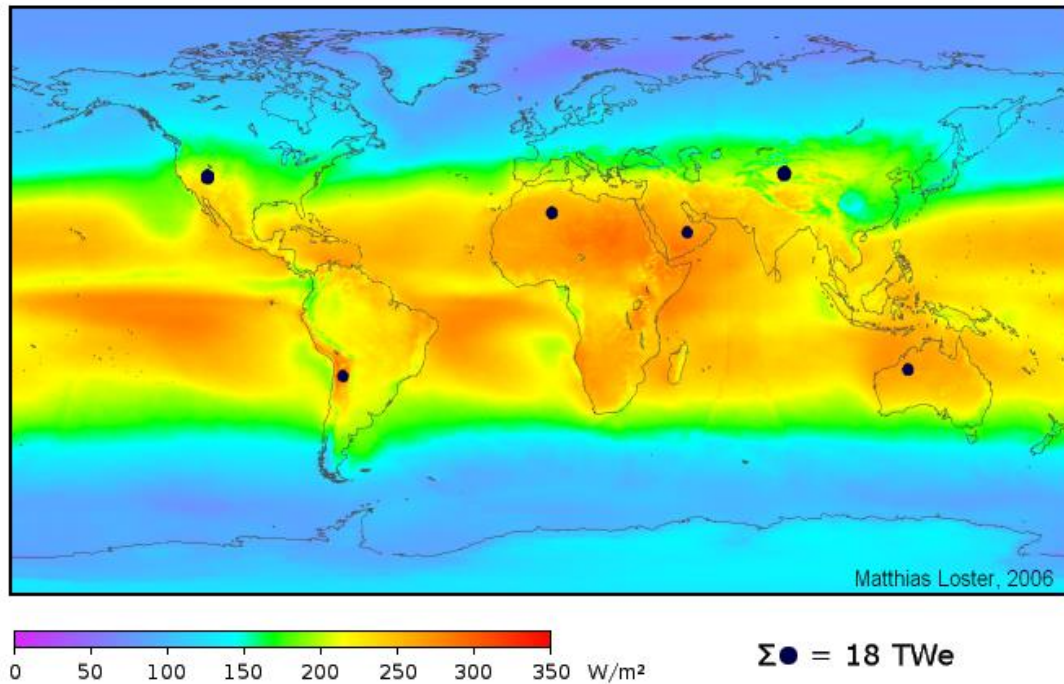
### 1.2.1 Instruction of Solar Energy

Solar photovoltaic energy source has long been recognized as a sustainable one. By the end of 2011, a total of 67.4 GW had been installed. Following hydro and wind power, solar photovoltaic energy source is now the third most important renewable one. As shown in Figure 1.1, the production of solar cell is increasing as a very high speed.



**Figure 1.1** Solar cell production by region in globe.

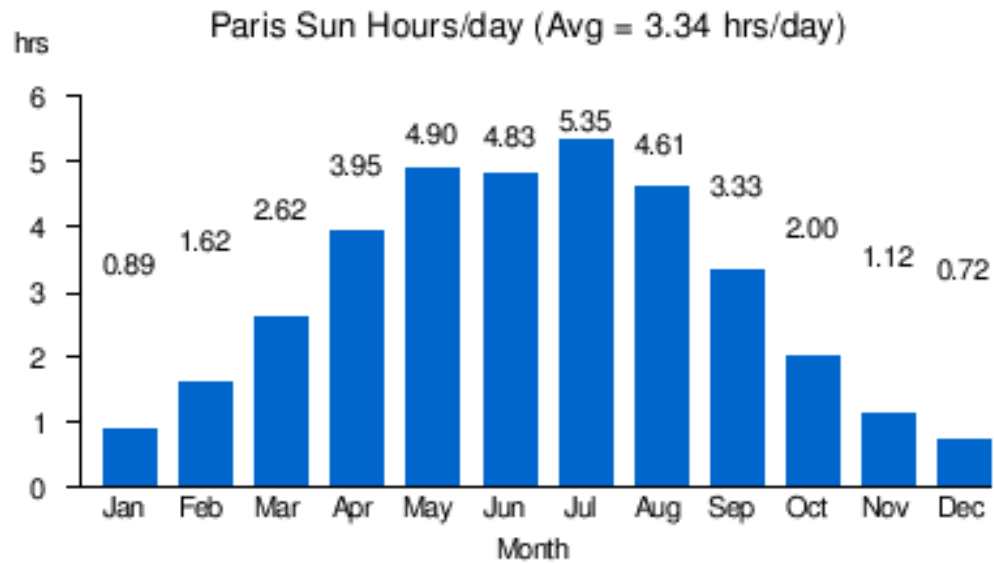
Figure 1.2 shows that the solar energy potential of the world. It is clear that most of the countries can benefit from this kind of energy resources.



**Figure 1.2** Average solar irradiance.

Photovoltaic (PV) conversion is a method of generating electrical power by converting solar radiation into direct current electricity by using semiconductors that exhibit the photovoltaic effect. Photovoltaic power generation employs solar panels composed of a number of solar cells containing a photovoltaic material.

Photovoltaic power capacity is measured as maximum power output under standardized test conditions (STC) in "Wp" (Watts peak). The actual power output at a particular point in time may be less than or greater than this standardized, or "rated," value, depending on geographical location, time of day, weather conditions, and other factors. Solar photovoltaic array capacity factors are typically under 25%, which is lower than many other industrial sources of electricity.



**Figure 1.3** Sun hours/day in Paris over one year.

### 1.2.2 Economics

The output of a photovoltaic array is a product of the panel area, efficiency, and insolation. The capacity factor, or duty cycle, of photovoltaic conversion is relatively low, typically from 0.10 to 0.30, as insolation ranges, by latitude and prevailing weather, and is location specific from about 2.5 to 7.5 sun hours/day. Panels are rated under standard conditions by their output power. The DC output is a product of four quantities, i.e., the rated output, the number of panels, the insolation, and the number of days. The sunlight received by the array is affected by a combination of tilt, tracking and shading. Tracking the sunlight can increase the yield but also the cost of installation and maintenance. For example, for a 4 kW array in Paris, where the average insolation is 3.34 sun hours/day, the annual (AC) output would be approximately  $3.34 \times 4 \times 365 \times 0.75 = 3657$  kWh, and the monthly output, as shown in Figure 1.3, would range from 67 kWh in December to 498 kWh in July. The weather

strongly affects the output. Monthly and annual energy production varies substantially from year to year (by  $\pm 40\%$  monthly and  $\pm 20\%$  annually).

Solar cell efficiencies vary from 6% for amorphous silicon-based ones to 44.0% with multiple-junction concentrated photovoltaic conversion. Solar cell energy conversion efficiencies for commercially available photovoltaic panel are around 14-22%. Concentrated photovoltaic (CPV) conversion may reduce cost by concentrating up to 1,000 suns (through magnifying lens) onto a smaller sized photovoltaic cell. However, such concentrated solar power requires sophisticated heat sink designs. Otherwise, the photovoltaic cell overheats, which reduces its efficiency and life. To further exacerbate the concentrated cooling design, the heat sink must be passive. Otherwise, the power required for active cooling reduces the overall efficiency and economic gains.

### **1.2.3 Other Advantages of Solar Energy**

Solar power is pollution-free during use. Production end-wastes and emissions are manageable using the existing pollution control. End-of-use recycling technologies are under development and policies are being made to encourage 100% recycling from producers.

PV installations can operate for many years with little maintenance or intervention after their initial set-up, i.e., after the initial capital cost of building any solar power plant, operating costs are extremely low compared to the existing power technologies.

Compared to fossil and nuclear energy sources, very little research money has been invested in the development of solar cells. Consequently, there is a considerable room for improvement. Nevertheless, experimental high efficiency solar cells already have efficiencies of over 40% in case of concentrating photovoltaic cells and efficiencies are rapidly rising while mass-production costs are rapidly falling.

## **CHAPTER 2**

### **PHOTOVOLTAIC SYSTEM MODEL**

#### **2.1 Solar Panels**

##### **2.1.1 Concept of a Photovoltaic System**

Photovoltaic array consists of many solar panels. A solar panel, also named a solar module, photovoltaic module or photovoltaic panel, is a packaged, connected assembly of photovoltaic cells. The solar panel can be used as a component of a larger photovoltaic system to generate and supply electricity in commercial and residential applications. Each panel is rated by its DC output power under standard test conditions. Because a single solar panel can produce only a limited amount of power, most installations contain multiple panels. A photovoltaic system typically includes an array of solar panels, an inverter, and sometimes a battery and or solar tracker and interconnection wiring.

##### **2.1.2 Mounting Systems**

Photovoltaic systems can be constructed with different mounting methods of solar panels.

###### **(1) Trackers**

Some photovoltaic systems apply solar trackers to increase the amount of energy produced per panel. However, this comes with a cost of mechanical



complexity and need for maintenance. They sense the direction of the Sun and tilt the panels as needed for maximum exposure to the light.

(2) Fixed racks

Fixed racks hold panels stationary as the sun moves across the sky. The fixed rack sets the angle at which the panel is held. Tilt angles equivalent to an installation's latitude are common. Most of these fixed racks are set on poles above ground.

(3) Ground mounted

Ground mounted solar power systems consist of solar panels held in place by racks or frames that are attached to ground based mounting supports.

(4) Roof mounting

Roof-mounted solar power systems consist of solar panels held in place by racks or frames attached to roof-based mounting supports.

## **2.2 PV System Structure**

Photovoltaic systems (PVS) use solar panels to convert sunlight into electricity. A system is made up of one or more PV panels, a DC/AC power converter, also known as an inverter, a racking system that holds the solar panels, electrical interconnections, and mounting for other components. Optionally, it may include a maximum power point tracker (MPPT), battery system and charger, solar tracker, energy management software, solar concentrators and other equipment. A small PVS may provide energy to a single consumer, or to an isolated device like a lamp or a weather instrument. A

large grid-connected PVS can provide the energy needed by many customers. The electricity generated can be either stored, used directly (island/standalone plant), or fed into a large electricity grid powered by central generation plants (grid-connected/grid-tied plant), or combined with one or many domestic electricity generators to feed into a small grid (hybrid plant). Systems are generally designed in order to ensure the highest energy yield for a given investment.

### **2.2.1 Primary Components in PVS**

A photovoltaic array or solar array is a linked collection of solar panels. The power that one module can produce is seldom enough to meet requirements of a home or business. As a result, the modules are linked together to form an array. Most PV arrays use an inverter to convert the DC power produced by the modules into alternating current that can power lights, motors, and other loads. The modules in a PV array are usually first connected in series to obtain the desired voltage; the individual strings are then connected in parallel to allow the system to produce more current. Solar panels are typically measured under STC (standard test conditions).

**Table 2.1** Electrical STC Specifications of PV Panels

Name of type	Solar-Fabrik SF-130/2-125
Number of cells in series ( $N_S$ )	36
Short-circuit current ( $I_{SC}$ )	7.84A
Open-circuit voltage ( $V_{OC}$ )	21.53V
Maximum power point current ( $I_{MPP}$ )	7.14A
Maximum power point voltage ( $V_{MPP}$ )	17.50V
Maximum power ( $P_{MPP}$ )	124.95W
cell temperature reference ( $\theta^*$ )	25 °C
irradiance reference ( $G^*$ )	1000W/m <sup>2</sup>
temperature coefficient for current ( $K_I$ )	0.00545A/K

### (1) Mounting systems

Modules are assembled into arrays in some kind of mounting systems. For solar parks, a large rack is mounted on the ground, and the modules mounted on the rack. For buildings, many different racks have been devised for pitched roofs. For flat roofs, racks, bins and building integrated solutions are used.

### (2) Trackers

A solar tracker tilts a solar panel throughout the day. Depending on the type of tracking systems, the panel is either aimed directly at the sun or the brightest area of a partly clouded sky. Trackers greatly enhance early morning and late afternoon

performance, increasing the total amount of power produced by a system by about 20–25% for a single axis tracker and about 30% or more for a dual axis tracker, depending on latitude. Trackers are effective in regions that receive a large portion of sunlight directly. In diffuse light, i.e., under cloud or fog, tracking has little or no value. Because most concentrated PVSs are very sensitive to the sunlight's angle, tracking systems allow them to produce useful power for more than a brief period each day. Tracking systems improve performance for two main reasons. First, when a solar panel is perpendicular to the sunlight, it receives more light on its surface than if it were angled. Second, direct light is used more efficiently than angled light. Special anti-reflective coatings can improve solar panel efficiency for direct and angled light, somewhat reducing the benefit of tracking.

### (3) Inverters

Systems designed to deliver alternating current (AC), such as grid-connected applications need an inverter to convert the direct current (DC) from the solar modules to AC. Grid connected inverters must supply AC electricity in a sinusoidal form, be synchronized to the grid frequency, limit feed in voltage to no higher than the grid voltage and disconnect from the grid if the grid voltage is turned off. Islanding inverters need only produce regulated voltages and frequencies in a sinusoidal wave shape because neither synchronization nor co-ordination with grid supplies is required. A solar inverter may connect to a string of solar panels. In some installations a solar micro-inverter is connected at each solar panel. For safety reasons

a circuit breaker is provided both on the AC and DC side to enable maintenance. AC output may be connected through an electricity meter into the public grid.

(4) Maximum power point tracking and charge control

Maximum power point tracking (MPPT) is used to maximize module output power. The power output of a module varies as a function of the voltage in a way that power generation can be optimized by varying the system voltage to find the 'maximum power point'. Some inverters incorporate maximum power point tracking.

(5) Monitoring and metering

The metering must be able to accumulate energy units in both directions or two meters must be used. Many meters accumulate bidirectionally.

### **2.2.2 Energy Costs**

Table 1.2 shows the total cost in US cents per kWh of electricity generated by a PVS. The row headings on the left show the total cost, per peak kilowatt (kWp), of a photovoltaic installation. PVS costs have been declining and in Germany. It was reported to have fallen to USD 2200/kWp by the second quarter of 2012. The column headings across the top refer to the annual energy output in kWh expected from each installed kWp. This varies by geographic regions because the average insolation depends on the average cloudiness and the thickness of atmosphere traversed by the sunlight. It also depends on the path of the sun relative to the panel and the horizon. Panels are usually mounted at an angle based on latitude, and often they are adjusted

seasonally to meet the changing solar declination. Solar tracking can also be utilized to access even more perpendicular sunlight, thereby raising the total energy output.

The calculated values in Table 1.2 reflect the total cost in cents per kWh produced. They assume a 10% total capital cost (for instance 4% interest rate, 1% operating and maintenance cost, and depreciation of the capital outlay over 20 years). Normally, photovoltaic modules have a 25 year warranty.

**Table 2.2** Cost Per Kilowatt Hour (US cents/kWh)

20 years	2400 kWh/k $W_p y$	2200 kWh/k $W_p y$	2000 kWh/k $W_p y$	1800 kWh/k $W_p y$	1600 kWh/k $W_p y$	1400 kWh/k $W_p y$	1200 kWh/k $W_p y$	1000 kWh/k $W_p y$	800 kWh/k $W_p y$
\$200 /kW <sub>p</sub>	0.8	0.9	1.0	1.1	1.3	1.4	1.7	2.0	2.5
\$600 /kW <sub>p</sub>	2.5	2.7	3.0	3.3	3.8	4.3	5.0	6.0	7.5
\$1000 /kW <sub>p</sub>	4.2	4.5	5.0	5.6	6.3	7.1	8.3	10.0	12.5
\$1400 /kW <sub>p</sub>	5.8	6.4	7.0	7.8	8.8	10.0	11.7	14.0	17.5
\$1800 /kW <sub>p</sub>	7.5	8.2	9.0	10.0	11.3	12.9	15.0	18.0	22.5
\$2200 /kW <sub>p</sub>	9.2	10.0	11.0	12.2	13.8	15.7	18.3	22.0	27.5
\$2600 /kW <sub>p</sub>	10.8	11.8	13.0	14.4	16.3	18.6	21.7	26.0	32.5
\$3000 /kW <sub>p</sub>	12.5	13.6	15.0	16.7	18.8	21.4	25.0	30.0	37.5

## 2.3 Photovoltaic System Model

### 2.3.1 Linear Power Model

The simplest model for power output at MPP is:

$$P_{PV_{MPP}} = P_{MPP} \frac{g}{1000} [1 + \gamma(\theta - 25)] N_{PV} \quad (2.1)$$

In Equation (2.1),  $P_{MPP}$  is the reference of maximum power which can be obtained from manufacturer's data sheet;  $P_{PV_{MPP}}$  is defined as maximum power output of PVS;  $N_{PV}$  refers to the number of serial solar panels;  $\gamma$  is a parameter for industry and highly depends on the value of  $g$  and  $\theta$  – which are the radiation parameter and temperature parameter under different weather conditions.

### 2.3.2 Classical Single-diode Model

The equivalent circuit mathematic model for PV cells includes a current source in parallel with a diode as shown in Figure 1.4. The current for PV output is consist of three parts:  $I_{ph}$ ,  $I_D$  and  $I_{sh}$ . They are explained as follows:

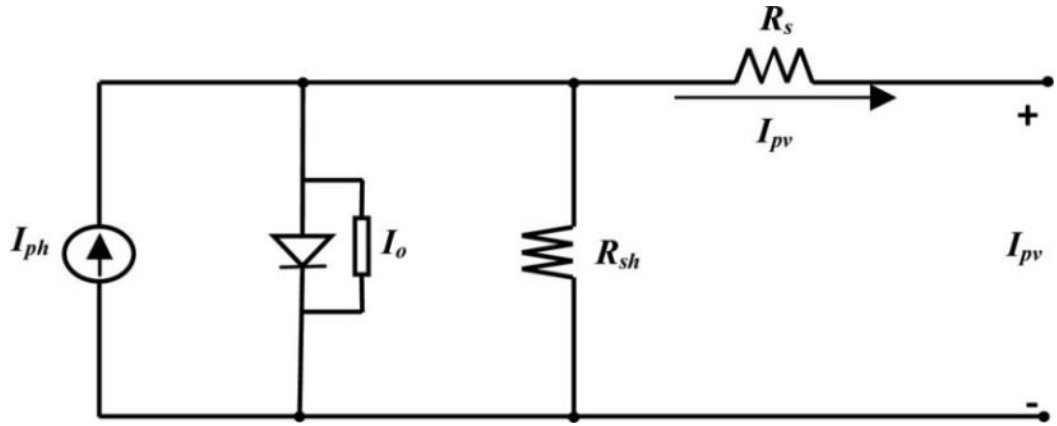


Figure 2.1 Solar cell model.

(1)  $I_{ph}$  means the photo current produced by solar cells under radiation;

(2)  $I_D$  is the current that goes through the diode. It contains several parameters that can be found in the manufacturer's data sheet;

$$I_D = I_0 \left[ \exp \left( \frac{V + I \times R_s}{V_T} \right) - 1 \right] \quad (2.2)$$

(3)  $I_{sh}$  is the current through shunt resistance.

$$I_{sh} = \frac{V+I \times R_s}{R_{sh}} \quad (2.3)$$

Therefore, the mathematical model derived from identical solar cells' equivalent circuit is:

$$I_{pv} = n_p I_{ph} - n_p I_0 \left[ e^{\frac{q(V_{pv} - R_s I_{pv})}{AKT n_s}} - 1 \right] - n_p \left( \frac{V_{pv} + R_s I_{pv}}{n_s R_{sh}} \right) \quad (2.4)$$

In this model,  $V_{pv}$  and  $I_{pv}$  represent the output voltage and current of the whole solar cells' array.  $R_s$  and  $R_{sh}$  are the resistances of series and shunt of solar cells.  $q$  is the electron charge ( $1.6 \times 10^{-19} \text{C}$ ).  $I_{ph}$  is the current generated from the solar cells,  $I_0$  is a parameter related to the diode which is the reverse saturation current.  $A$  is a dimensionless junction material factor,  $k$  is Boltzmann constant ( $1.38 \times 10^{-23} \frac{\text{J}}{\text{K}}$ ),  $T$  is the temperature, and  $n_p$  and  $n_s$  are the number of solar cells in parallel and series.

$$I_{ph} = I_{ph(T_{ref})} \times (1 + K_0(T - T_{ref})) \quad (2.5)$$

$$I_{ph(T_{ref})} = \frac{G}{G_{ref}} \times I_{sc(T_{ref})} \quad (2.6)$$

$$K_0 = \frac{I_{sc(T)} - I_{sc(T_{ref})}}{T - T_{ref}} \quad (2.7)$$

For a given single solar cell,  $n_p = n_s = 1$ . Also to simplify the model the last part is always ignored, thereby leading to:

$$I_{pv} = I_{ph} - I_0 \left[ \exp\left[\frac{q(V_{pv} - R_s I_{pv})}{AKT}\right] - 1 \right] \quad (2.8)$$

After the reference parameters about temperature photo current and radiation are obtained, any photo current can be obtained no matter what time or what weather condition through these equations. Therefore, every variable in the PV model is given.



The next issue is how to use this model to find the maximum power point. MPPT methods are proposed to address it as discussed in the next chapter.

## CHAPTER 3

### MAXIMUM POWER POINT TRACKING METHODS

#### 3.1 Introduction of MPPT

Maximum power point tracking (MPPT) is a technique applying grid-tie inverters, solar battery chargers and similar devices to obtain the maximum possible power from one or more photovoltaic devices. The power output of solar cells has a complex relationship with solar irradiation, temperature and total resistance. It is non-linear and can be analyzed based on the I-V curve. It is the purpose of an MPPT system to sample the output of the cells and apply the proper resistance (load) to obtain maximum power for any given environmental conditions. MPPT devices are typically integrated into an electric power converter system that provides voltage or current conversion, filtering, and regulation for driving various loads, including power grids, batteries, or motors.

##### 3.1.1 I-V Curve

Photovoltaic cell outputs have a complex relationship with the cells' operating environment and the maximum power they can produce. The fill factor, abbreviated as FF, is a parameter characterizing the non-linear electrical behavior of the solar cell. It is defined as the ratio of the maximum power from the solar cell to the product of Open Circuit Voltage  $V_{oc}$  and Short-Circuit Current  $I_{sc}$ . In tabulated data it is often used to

estimate the maximum power that a cell can provide with an optimal load under given conditions,  $P=FF \times V_{oc} \times I_{sc}$ . For most purposes, FF,  $V_{oc}$ , and  $I_{sc}$  are enough to give a useful approximate model of the electrical behavior of a photovoltaic cell under typical conditions.

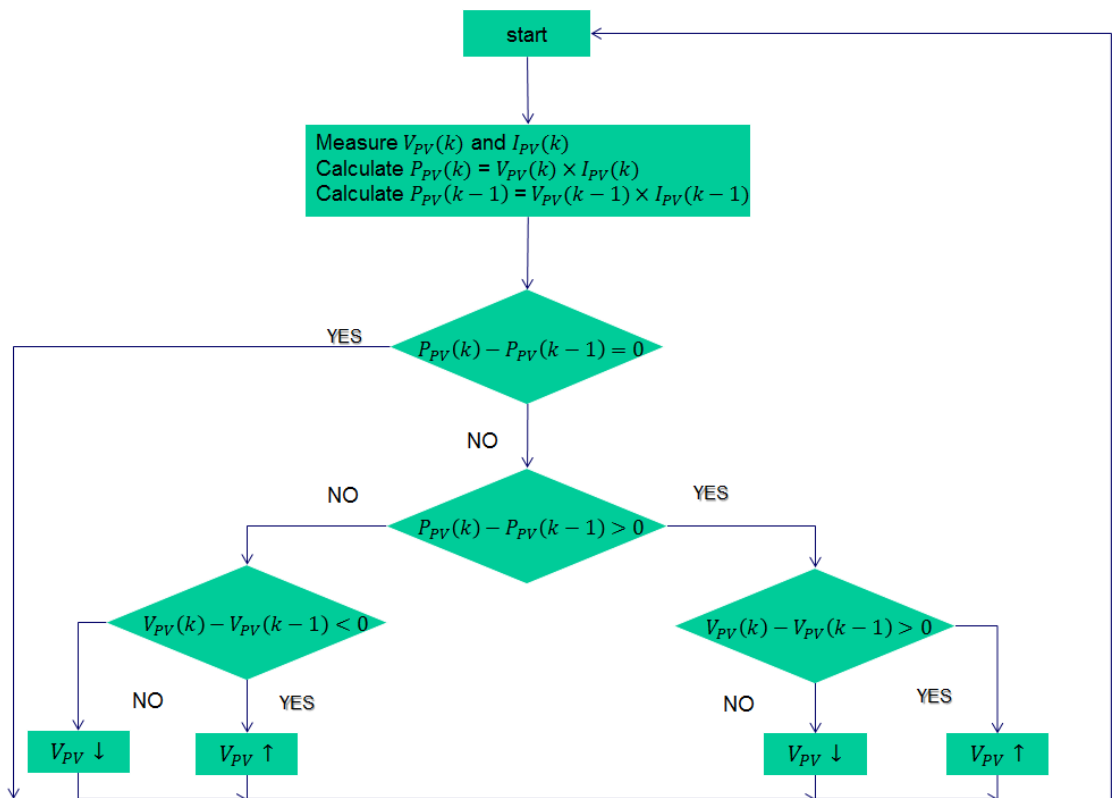
For any given set of operational conditions, cells have a single operating point where the values of current (I) and Voltage (V) of the cell result in a maximum power output. These values correspond to a particular load resistance, which is equal to  $V / I$  as specified by Ohm's Law. The power P is given by  $P=V \times I$ . A photovoltaic cell, for the majority of its useful curve, acts as a constant current source. However, at a photovoltaic cell's MPP region, its curve has an approximately inverse exponential relationship between its current and voltage. From the basic circuit theory, the power delivered from or to a device is optimized where the derivative (graphically, the slope)  $dI/dV$  of the I-V curve is equal but opposite to the I/V ratio (where  $dP/dV=0$ ). This is known as the maximum power point (MPP) and corresponds to the "knee" of the curve.

A load with resistance  $R=V/I$  equal to the reciprocal of this value draws the maximum power from the device. This is sometimes called the characteristic resistance of a cell. This is a dynamic quantity that changes depending on the level of illumination, as well as other factors such as temperature and the age of the cell. If the resistance is lower or higher than this value, the power drawn is less than the maximum one available, and thus the cell will not be used as efficiently as it could be.

Maximum power point trackers utilize different types of control circuits or logic to search for this point and thus to allow the converter circuit to extract the maximum power available from a cell.

### 3.2 Perturb and Observe

Perturb and Observe is a commonly used method for obtaining MPP. In this method, the controller adjusts the voltage by a small amount from the array and measures output power; if it increases, further adjustments along that direction are tried until it no longer increases, as shown in Figure 3.1. This method is one of "hill climbing" methods. It depends on the rise of the curve of power against voltage below the MPP, and the fall above that point.

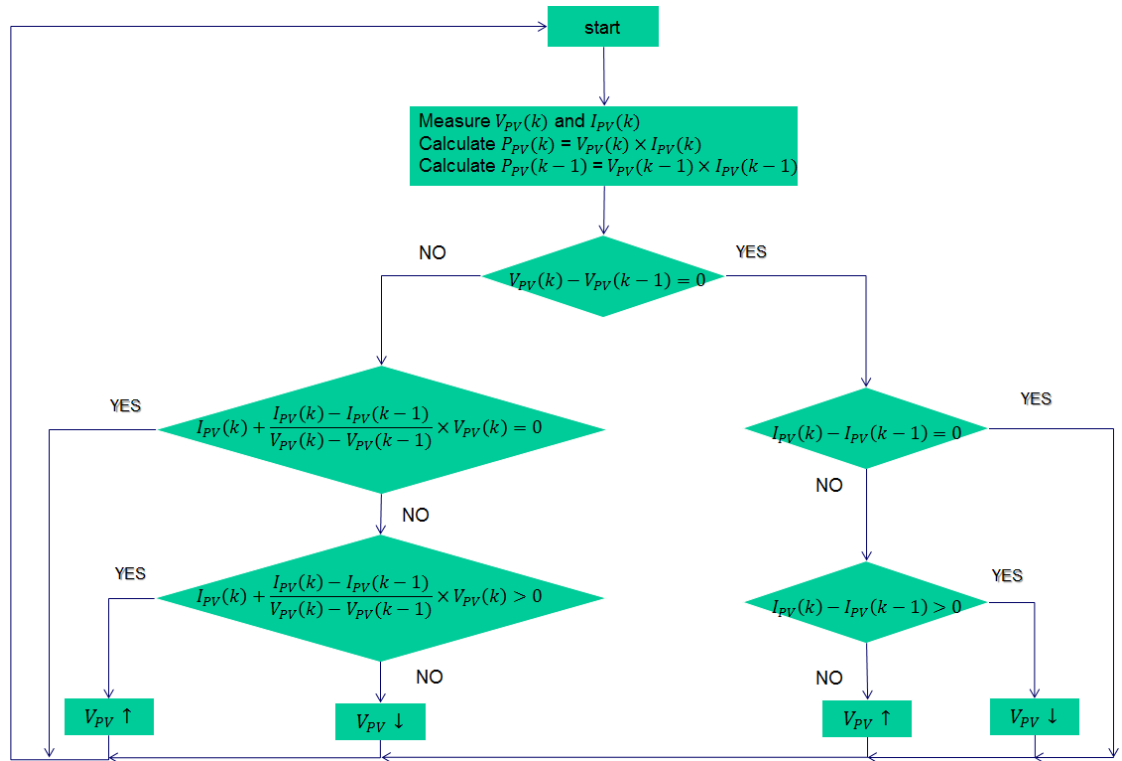


**Figure 3.1** The block diagram of the Perturb and Observe method.

### 3.3 Incremental Conductance

In the incremental conductance method, the controller measures incremental changes in array current and voltage to predict the effect of a voltage change. This method requires more computation in its controller, but can track changing conditions more rapidly than the perturb and observe method. With this method, if  $\frac{\partial I_{PV}}{\partial V_{PV}} > -\frac{I_{PV}}{V_{PV}}$ , the slope of P-V curve is positive; if  $\frac{\partial I_{PV}}{\partial V_{PV}} < -\frac{I_{PV}}{V_{PV}}$ , then it will be negative. Unless  $\frac{\partial I_{PV}}{\partial V_{PV}} = -\frac{I_{PV}}{V_{PV}}$ , which means the operating point matches the maximum power point.

For discrete system,  $\partial I_{PV}(k) = I_{PV}(k) - I_{PV}(k-1)$ ,  $\partial V(k) = V_{PV}(k) - V_{PV}(k-1)$ .



**Figure 3.2** The block diagram of incremental conductance method.

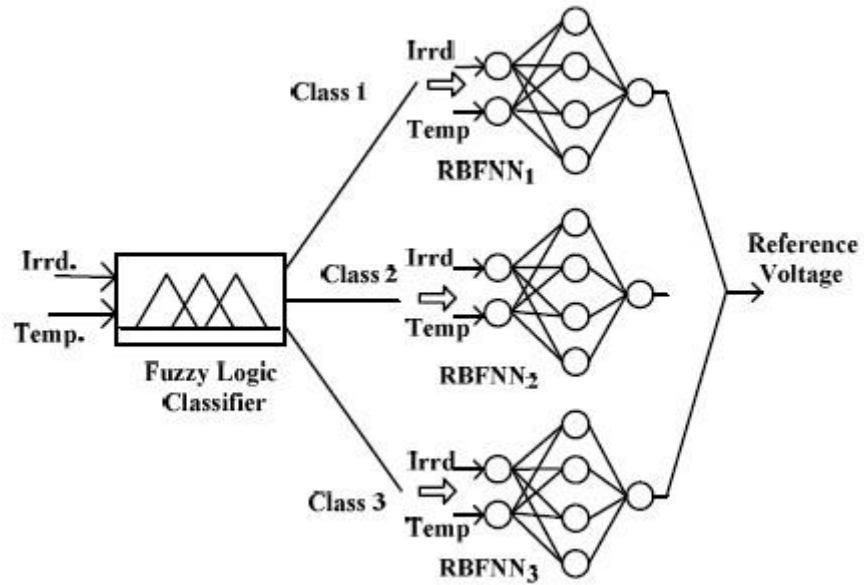
### 3.4 Fuzzy Logic-based MPPT

A PVS needs to be controlled based on the optimal operating condition by means of MPPT to obtain the maximum output power which is nonlinear and very complicate to set up the model of the curve during different weather. As a result, there is a strong demand for easy-to-use yeast powerful method to achieve this goal.

As well known, fuzzy logic control is suitable to a complicated nonlinear system whose mathematic model is unknown. Hence, this work intends to use fuzzy logic to combine different methods or structures like neuro-fuzzy MPPT method, fuzzy PID or advanced hill climbing method for the MPPT.

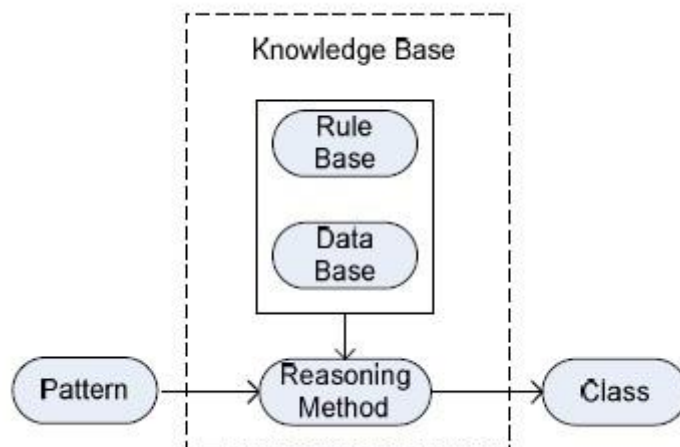
#### 3.4.1 Neuro-Fuzzy MPPT Method

A neuro-fuzzy MPPT method estimates the reference voltage ( $V_{pv}^*$ ) that guaranties an optimal power transfer. It mainly contains: radial basis function neural network (RBFNN) and fuzzy rule-based classifier, as shown in Figure 3.3. Neuro-fuzzy MPPT method's mainly advantage comparing to a conventional single neural network estimator is its generalization ability. This kind of methods based on the multi-model machine learning can define a set of local models representing appropriately the complex and nonlinear characteristic of a PVS under different weather conditions.



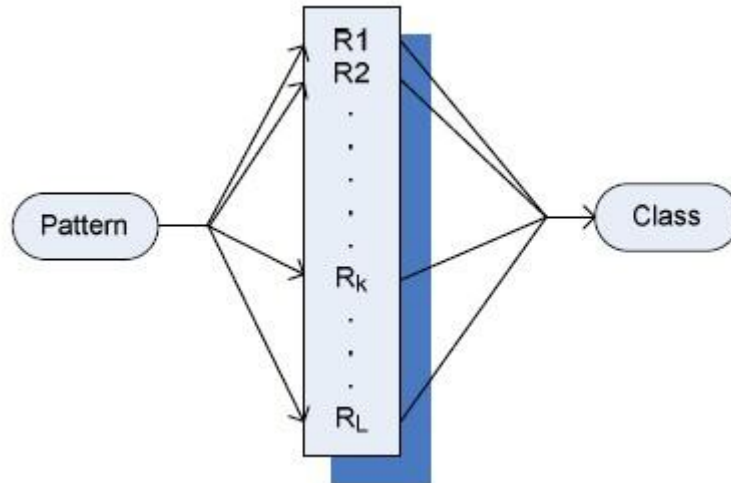
**Figure 3.3** Architecture of the neuro-fuzzy network.

The fuzzy rules-based classification consists of Fuzzy Reasoning Method (FRM) and a Knowledge Base (KB) as shown in Figure 3.4. In the KB, there are two parts: Rule Base and Data Base, which define the semantic of the fuzzy subsets related to linguistic labels on the if-then rules. As the support from KB, FRM can decide the right class label through acceptable patterns.



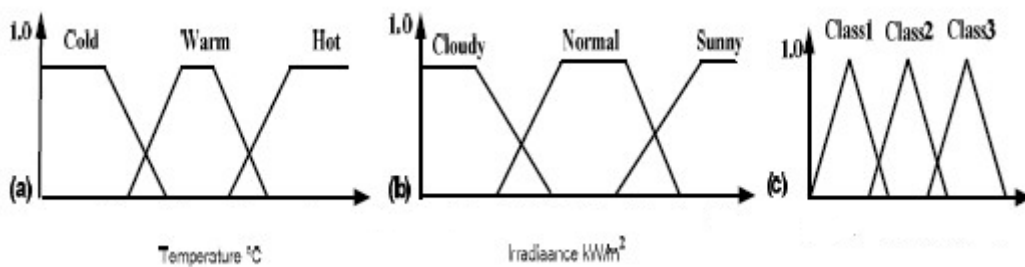
**Figure 3.4** Fuzzy rule-based classification system.

A fuzzy reasoning method is a process to derive conclusions from the if-then rules given the patterns information. As Figure 3.5 shows, under different rules, there are variant combinations.



**Figure 3.5** Fuzzy reasoning method.

The membership functions need to be defined for input and output of the classifier. A membership function represents the probability of each point in the input and output, as shown in Figure 3.6.



**Figure 3.6** Membership functions of input and output.

From the figure, three labels for temperature can be defined: cold, warm and hot. While the irradiance labeled as cloudy, normal and sunny.



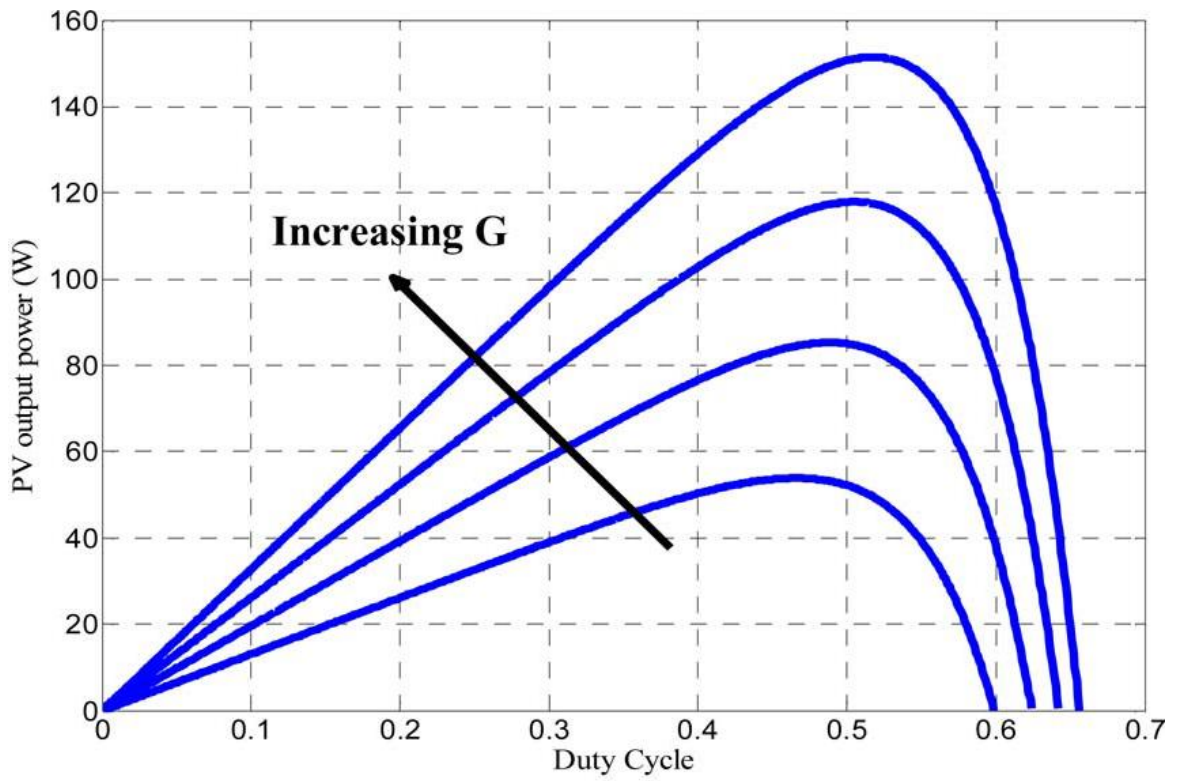
**Table 3.1** Fuzzy Rule Assignment

		Irradiance		
		Cloudy	Normal	Sunny
Temperature	Cold	Class 2	Class 3	Class 3
	Warm	Class 1	Class 2	Class 3
	Hot	Class 1	Class 1	Class2

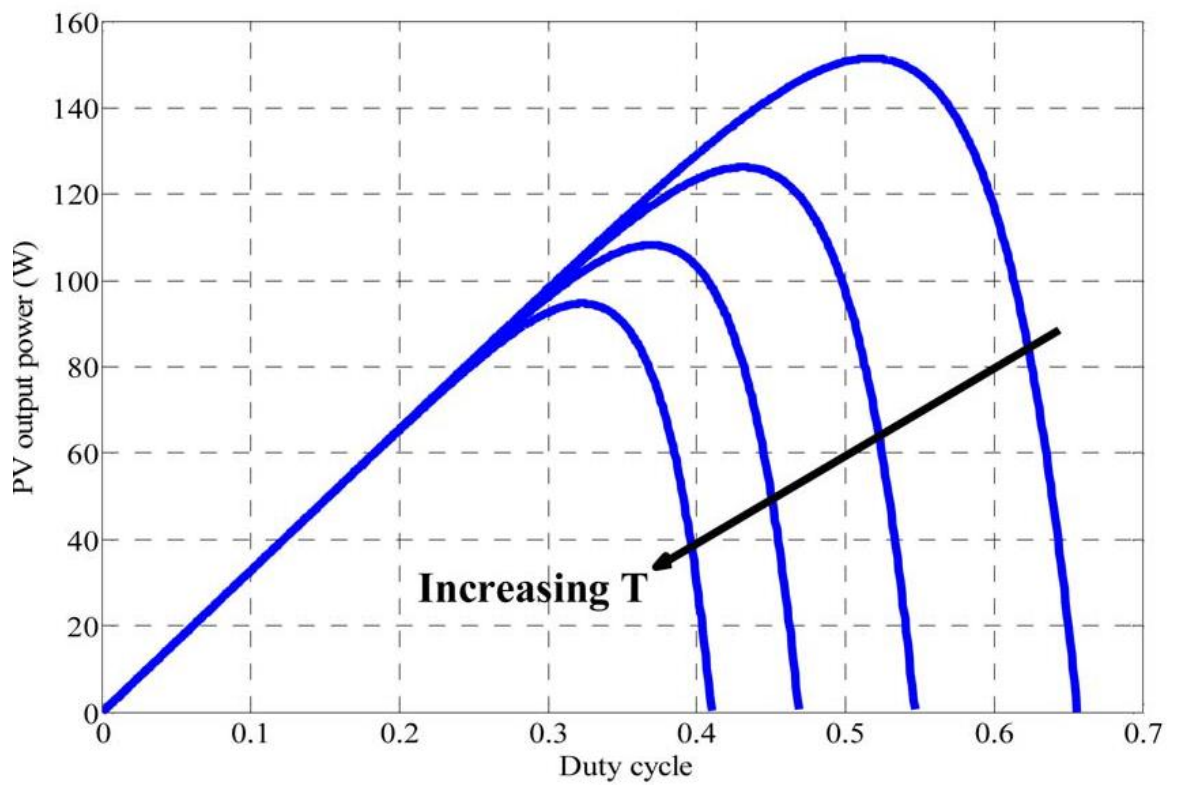
The influence of varying weather conditions will affect the value of linguistic statements as shown in Table 3.1.

### **3.4.2 Modified Hill-Climbing Method with Fuzzy-Logic-Control**

A modified hill climbing method can be obtained after fuzzy logic control principles are applied into the original one. As shown in Figures 3.7 and 3.8, the MPP characteristic can be observed under different weather conditions.



**Figure 3.7** Effect of increasing radiation density on P-D curve.



**Figure 3.8** Effect of increasing temperature on P-D curve.

In this method, the inputs of a fuzzy-logic-controller are:

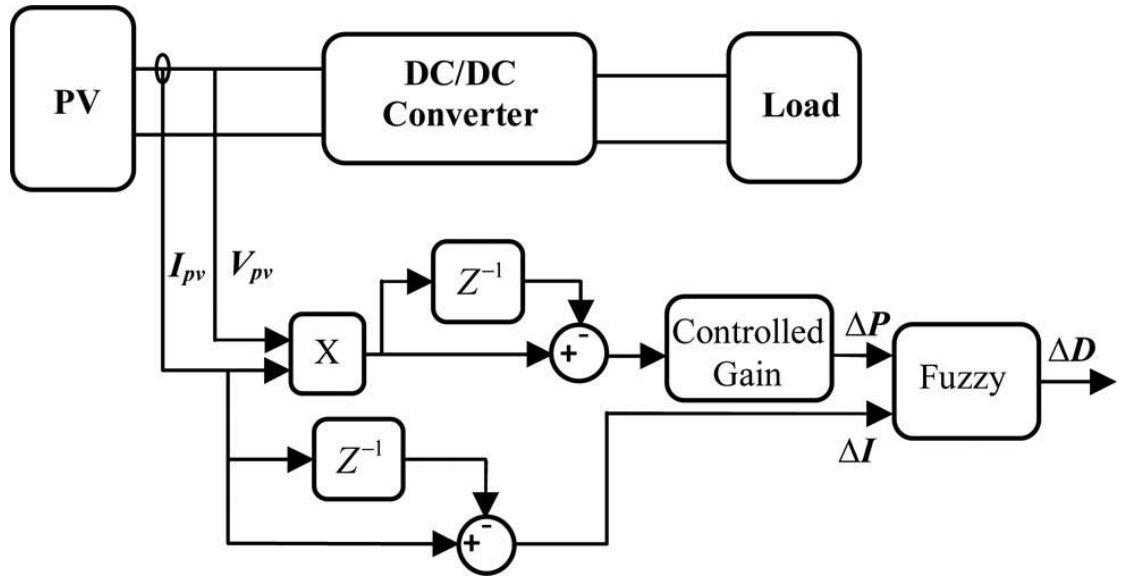
$$\Delta P = P(k) - P(k - 1) \quad (3.1)$$

$$\Delta I = I(k) - I(k - 1) \quad (3.2)$$

The output is the difference of converter's duty cycle:

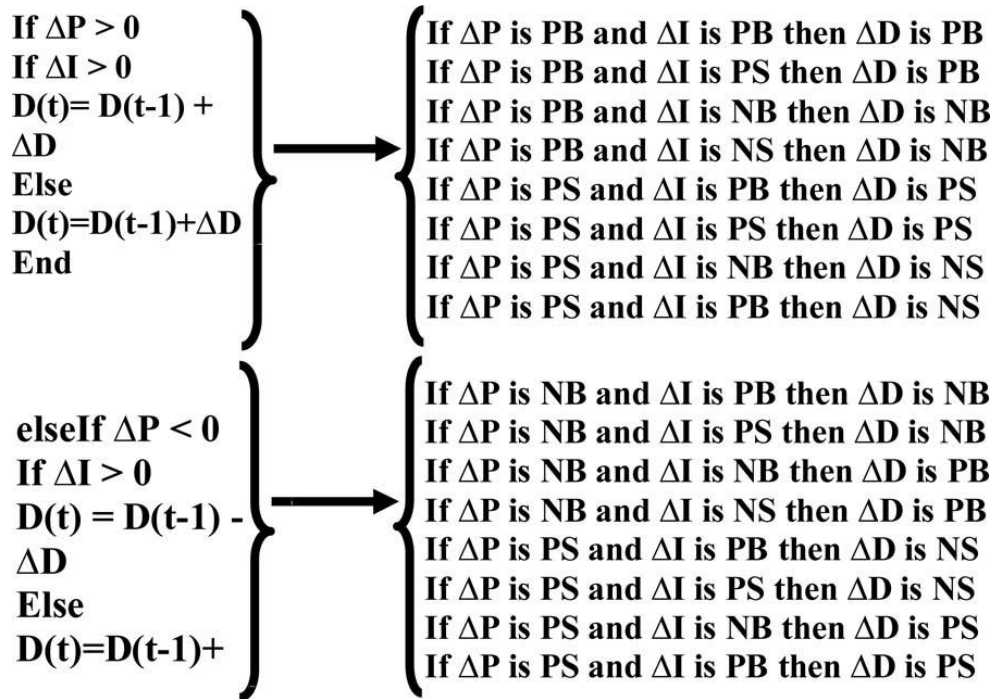
$$\Delta D = D(k) - D(k - 1) \quad (3.3)$$

Note that  $\Delta P$  means the change of output power between the (k-1)-th and k-th time points;  $\Delta I$  is the output current change and  $\Delta D$  is the difference of DC-DC converter's duty cycle used as the control signal.



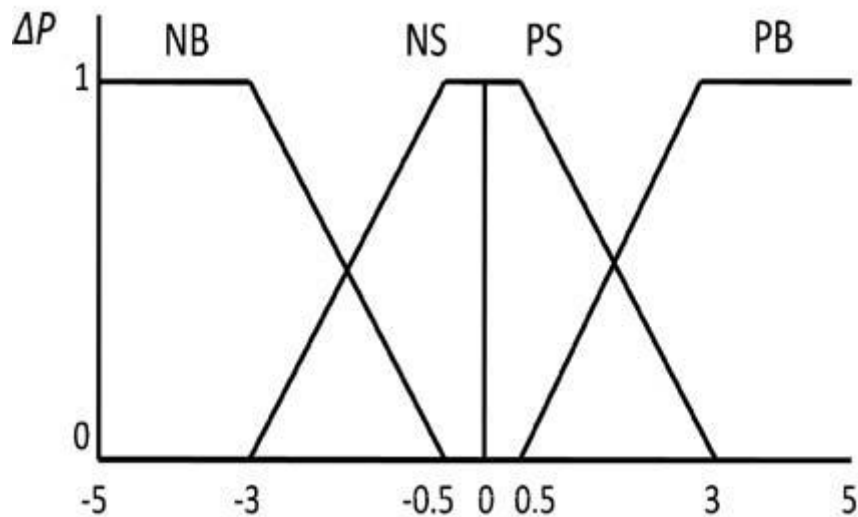
**Figure 3.9** The block diagram of the modified system.

In Figure 3.9, the controlled gain is used to reverse the direction of  $\Delta P$  such that it will not diverge from MPP under varying weather conditions. The input and output are classified as four fuzzy subsets: positive big (PB), positive small (PS), negative big (NB) and negative small (NS). Thus, fuzzy rules can be designed as shown in Figure 3.10:

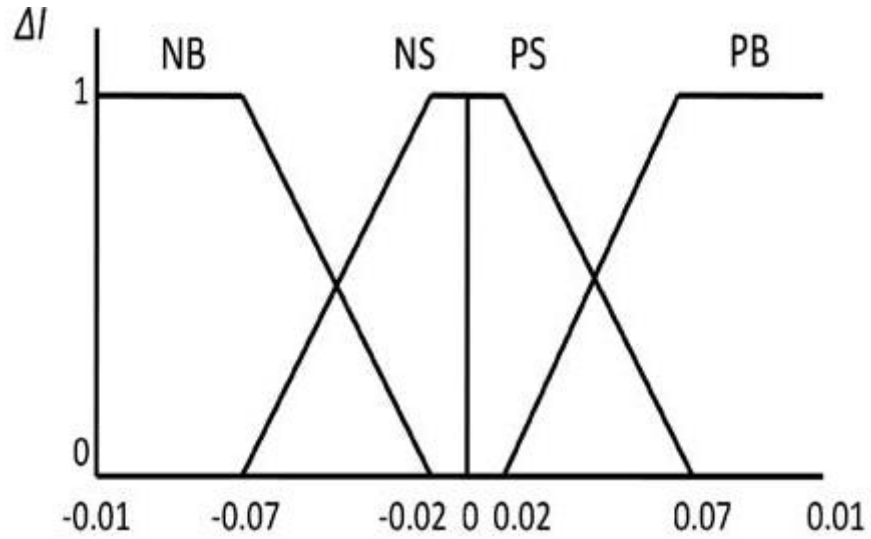


**Figure 3.10** Fuzzification rules of modified hill-climbing.

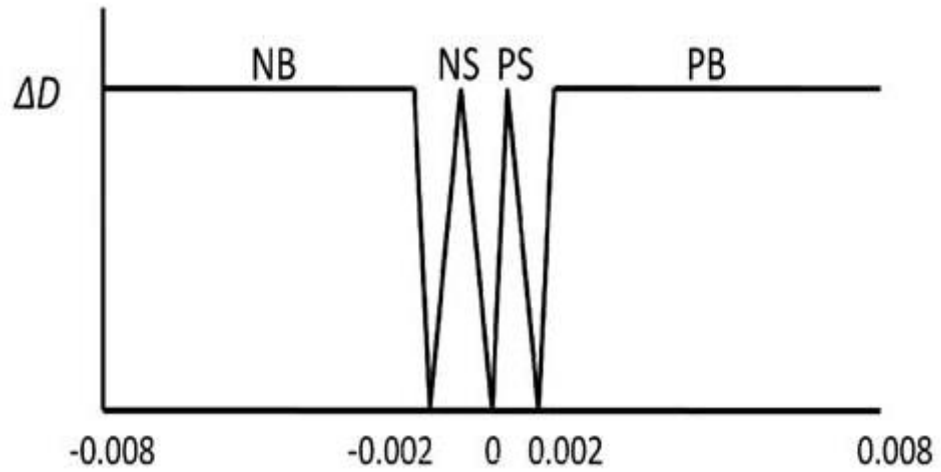
Then, through Mamdani's method with Max-Min operators, different fuzzy combinations can be performed. The membership functions are shown in Figures 3.11, 3.12 and 3.13:



**Figure 3.11** Membership function of  $\Delta P$ .



**Figure 3.12** Membership function of  $\Delta I$ .



**Figure 3.13** Membership function of  $\Delta D$ .

The last stage is defuzzification where the center of area algorithm (COA) is used to translate the value of fuzzy subset duty cycle difference to a real number.

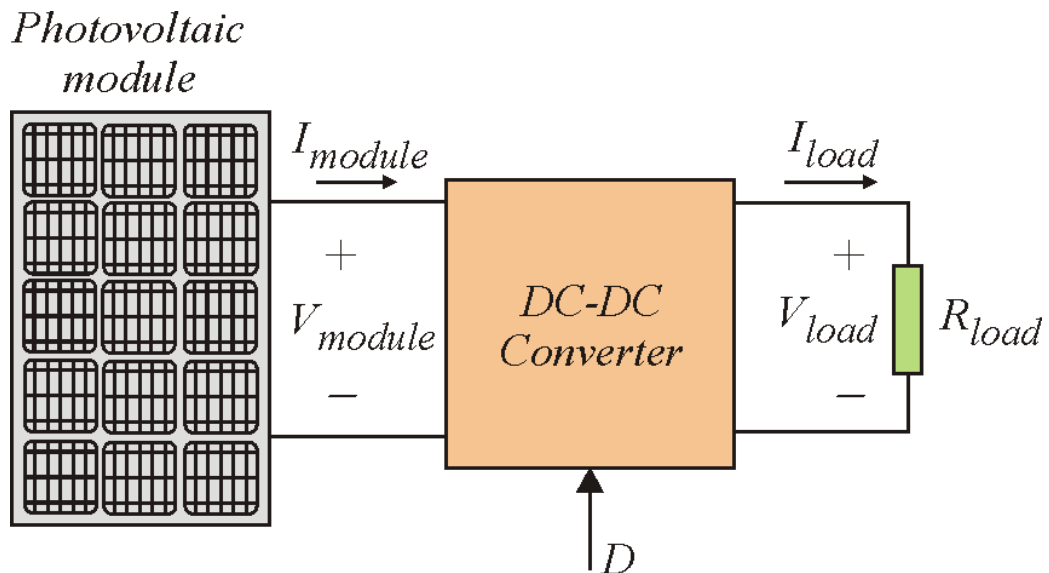
$$\Delta D = \frac{\sum_i^n \mu(D_i) D_i}{\sum_i^n \mu(D_i)} \quad (3.4)$$

## CHAPTER 4

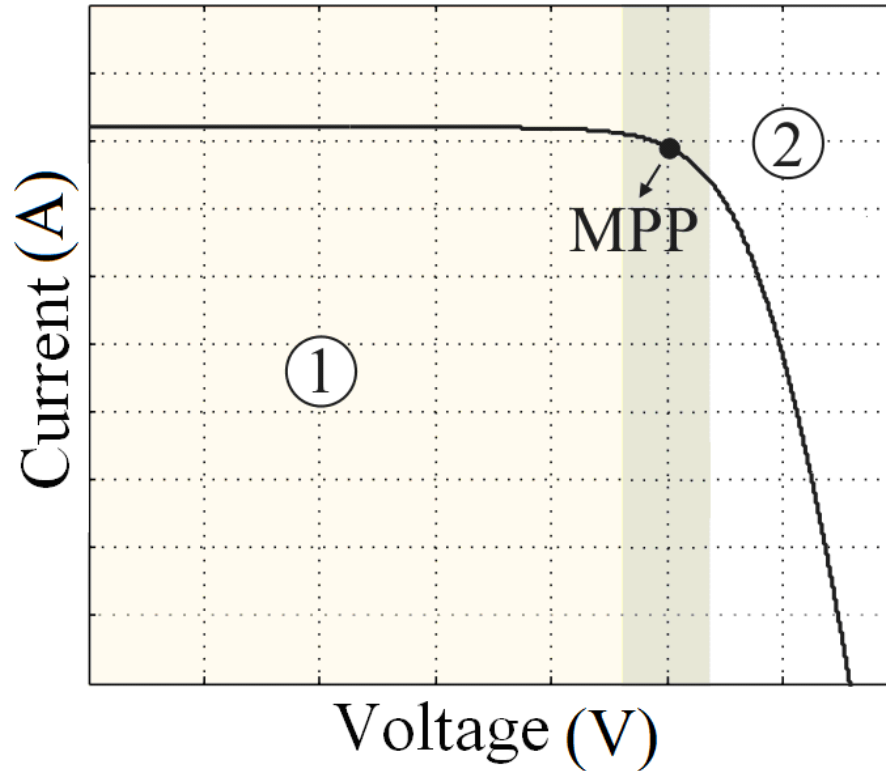
### DC-DC CONVERTER

#### 4.1 Introduction of DC-DC Converter

As shown in Figure 4.1, the MPP always happens at the knee of an I-V curve. At that point, the power output is the maximum. Hence, the control goal is to make sure the system to get close to the point. Usually, as the outside conditions change randomly, the solar radiation and temperature data also vary randomly. Consequently, the MPP would not be constant. Therefore, a tracker is needed to always follow the differences of environmental conditions such that the system outputs the maximum power. Because solar radiation and temperature cannot be measured or controlled, a new variable, called a duty cycle, is used to accomplish the mission.



**Figure 4.1** PV module connected to the load through DC-DC converter.



**Figure 4.2** I-V characteristic.

DC-DC Converters are of three types: Buck, Boost and Buck-Boost. In fact, it has been argued that the Buck-Boost type converter is the best when used to operate to achieve Maximum Power Point Tracking. The reason of why Buck-Boost converter used in this thesis is discussed through next sections.

#### 4.2 Buck Type Converter

A Buck type converter is widely used in the situations under which input voltage is higher than output voltage. Its static characteristic is as follows:

$$\frac{V_{load}}{V_{module}} = D \quad (4.1)$$

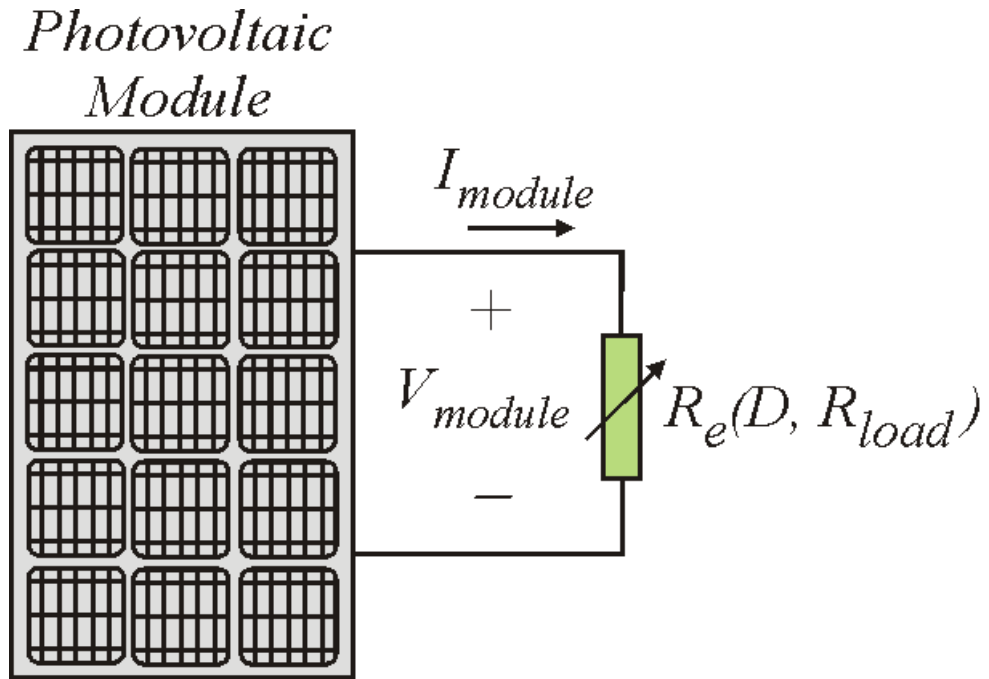
$$\frac{I_{load}}{I_{module}} = \frac{1}{D} \quad (4.2)$$

$$V_{load} = I_{load} \times R_{load} \quad (4.3)$$

Combining the three equations by using  $V_{module}$ ,  $I_{module}$  instead of  $V_{load}$  and  $I_{load}$  and moving  $V_{module}$  and  $I_{module}$  to the other hand leads to:

$$\frac{V_{module}}{I_{module}} = \frac{R_{load}}{D^2} \quad (4.4)$$

Because  $V_{module}/I_{module}$  means the resistance, an equivalent model is obtained in Figure 4.3:



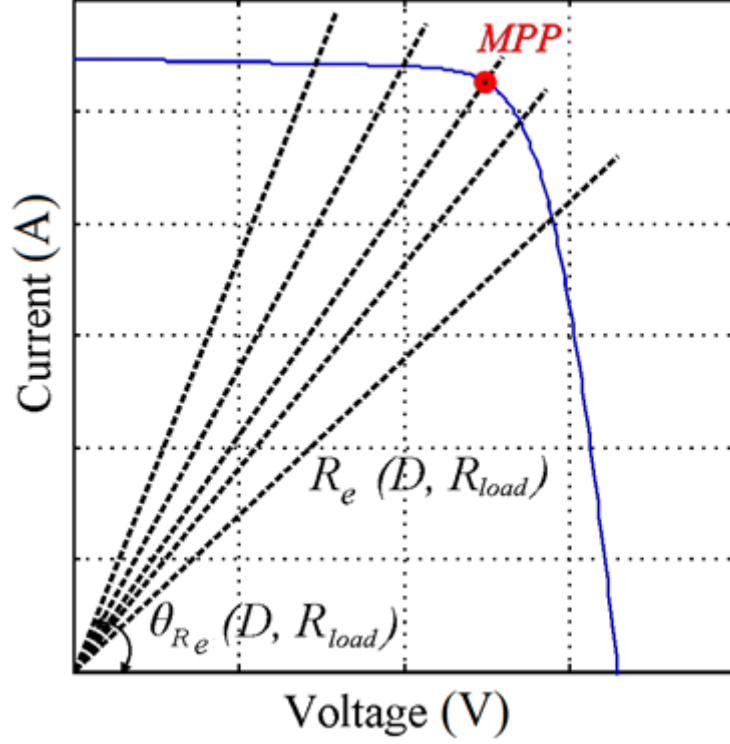
**Figure 4.3** Equivalent model for PV system.

In the figure, the resistance of equivalent model is represented by converter's duty cycle and resistance of the load:

$$R_e(D, R_{load}) = \frac{R_{load}}{D^2} \quad (4.5)$$

From the above discussions, the factors that affect the input and output voltage are related to the resistance of load and the duty cycle. As the duty cycle should be larger than 0 and smaller than 1, and  $R_{load}$  changes, the equivalent resistance varies as well.





**Figure 4.4** Example of load curves.

The angle of  $R_e(D, R_{load})$  can be calculated as:

$$\theta_{R_e}(D, R_{load}) = \tan^{-1}\left[\frac{D^2}{R_{load}}\right] \quad (4.6)$$

Although it is changing with different temperature or radiation conditions, there is still a limited change:

$$\theta_{R_e}(0, R_{load}) = \tan^{-1}\left[\frac{0}{R_{load}}\right] = 0^\circ \quad (4.7)$$

$$\theta_{R_e}(1, R_{load}) = \tan^{-1}\left[\frac{1}{R_{load}}\right] \quad (4.8)$$

$$0^\circ < \theta_{R_e}(D, R_{load}) < \tan^{-1}\left[\frac{1}{R_{load}}\right] \quad (4.9)$$

From Figure 4.5, it clearly shows the operational region with the upper and lower limits. If MPP is located in an operational region, then there is always a duty cycle value to match; else if the MPP is in a non-operational region, no matter how duty cycle changes, power output will not approach the maximum. In this case, if a

Buck type converter is used, the value of  $R_{load}$  must be small enough to suit large changes.

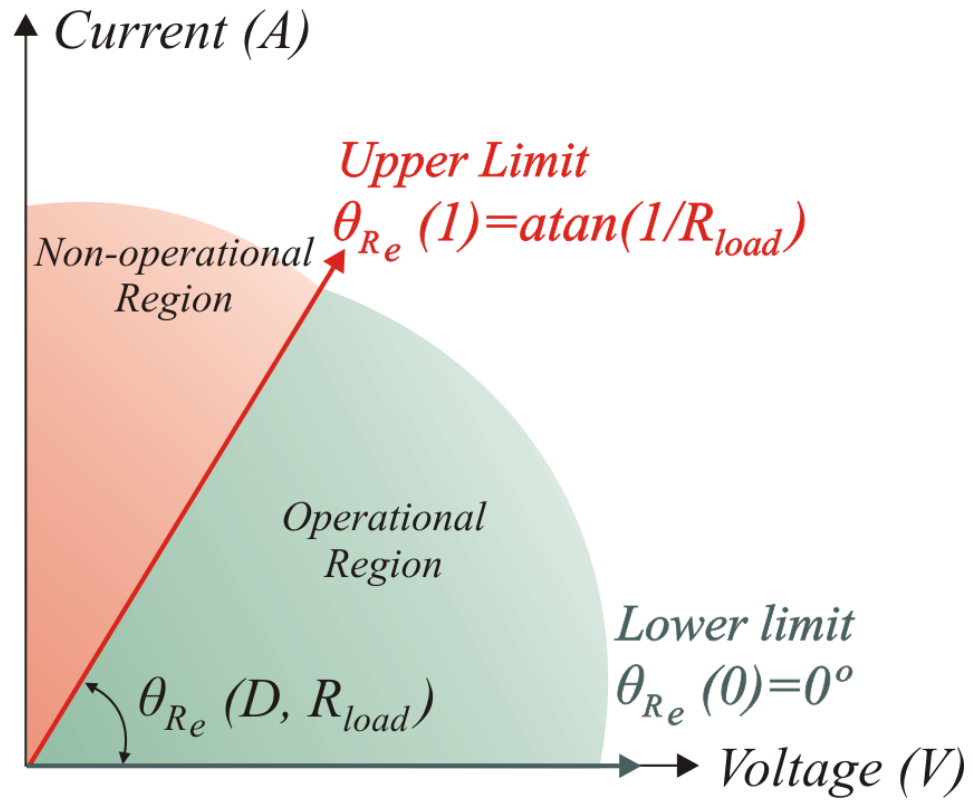


Figure 4.5 Operational region for Buck converter.

### 4.3 Boost Type Converter

The Boost type is also widely employed if the output voltage is higher than the input voltage. For the same process, the Boost type's static characteristic is given as follows:

$$\frac{V_{load}}{V_{module}} = \frac{1}{1-D} \quad (4.10)$$

$$\frac{I_{load}}{I_{module}} = 1 - D \quad (4.11)$$

$$V_{load} = I_{load} \times R_{load} \quad (4.12)$$

Then a new model is made with the equivalent resistance:

$$R_e(D, R_{load}) = (1 - D)^2 R_{load} \quad (4.13)$$

The angle slope of  $R_e(D, R_{load})$  is:

$$\theta_{R_e}(D, R_{load}) = \tan^{-1}\left[\frac{1}{(1-D)^2 R_{load}}\right] \quad (4.1)$$

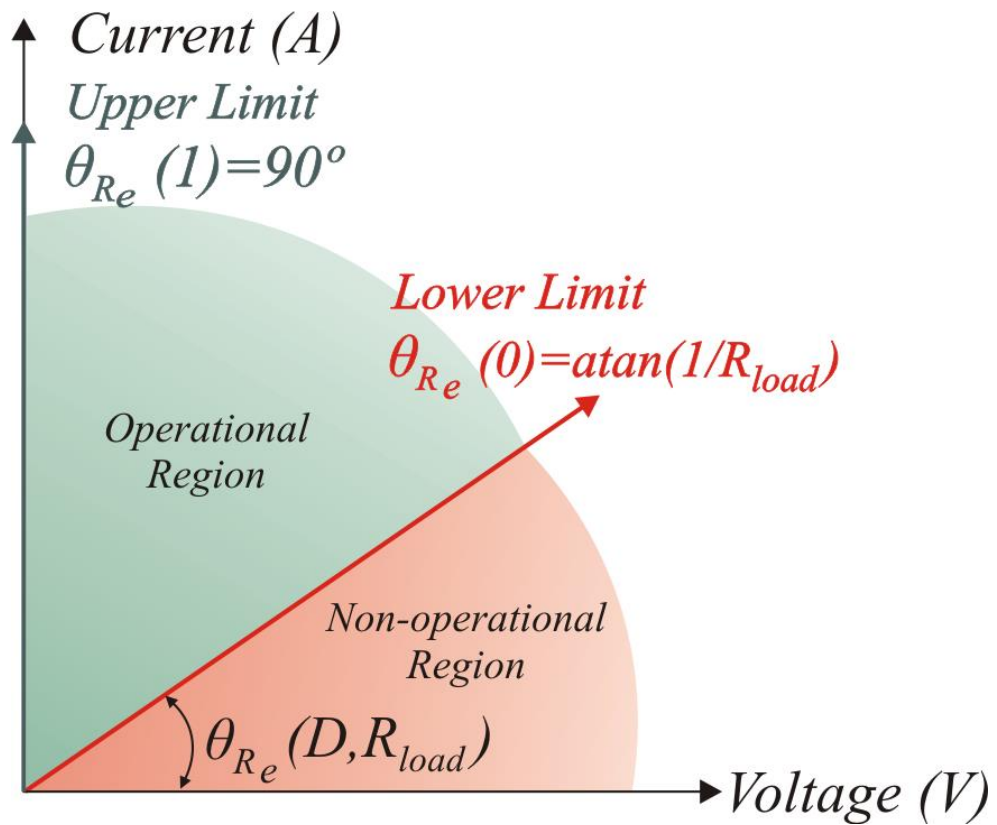
4)

The range of limitation is:

$$\theta_{R_e}(0, R_{load}) = \tan^{-1}\left[\frac{1}{R_{load}}\right] \quad (4.15)$$

$$\theta_{R_e}(1, R_{load}) = \tan^{-1}\left[\frac{1}{0}\right] = 90^\circ \quad (4.16)$$

From Figure 4.6, as the opposite of a Buck type converter, the Boost type needs the load resistance to be as large as it can to make sure that the lower limit is close to 0.



**Figure 4.6** Operational region for Boost converter.

#### 4.4 Buck-Boost Type Converter

The Buck-Boost type converter is used in the work. It combines the static transfer characteristic of both Buck type and Boost type converters. Its mathematical description is given as follows:

$$\frac{V_{load}}{V_{module}} = \frac{D}{1-D} \quad (4.17)$$

$$\frac{I_{load}}{I_{module}} = \frac{1-D}{D} \quad (4.18)$$

$$V_{load} = I_{load} \times R_{load} \quad (4.19)$$

The representation of an equivalent resistance is:

$$R_e(D, R_{load}) = \left(\frac{1-D}{D}\right)^2 R_{load} \quad (4.20)$$

The equation of the varying angle of  $R_e(D, R_{load})$  is:

$$\theta_{R_e}(D, R_{load}) = \tan^{-1}\left[\frac{D^2}{(1-D)^2 R_{load}}\right] \quad (4.21)$$

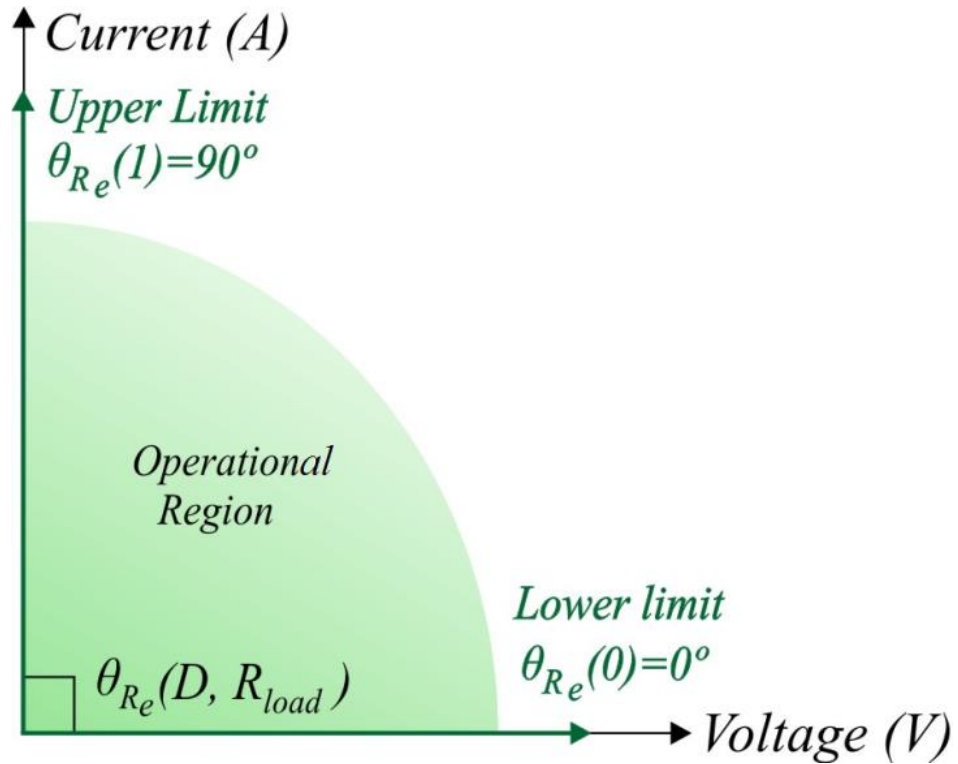
Because of the duty cycle limitation, the range of the angle  $\theta_{R_e}(D, R_{load})$  is given by:

$$\theta_{R_e}(0, R_{load}) = 0^\circ \quad (4.22)$$

$$\theta_{R_e}(1, R_{load}) = 90^\circ \quad (4.23)$$

Thus, the graph showing its operational region is obtained as shown in Figure

4.7:



**Figure 4.7** Operational region for Buck-Boost converter.

Unlike the Buck type with its upper limits or the Boost type with its lower limits on the range of operational region, Buck-Boost converters, allow one to all the duty cycle values to match the MPP, which means it can obtain the better result under different environmental conditions.

## CHAPTER 5

### PROPOSED RESEARCH METHOD

#### 5.1 Introduction of Proposed Method

This chapter presents a new methodology to achieve MPPT. It is not that complex comparing to other MPPT methods, but needs much historical data.

Firstly, establish the database and gather the weather conditions information and generation data for the chosen place during a period time – one year as one cycle, for 5-7 years. The item should include:

Radiation data

Temperature data

Output current and voltage

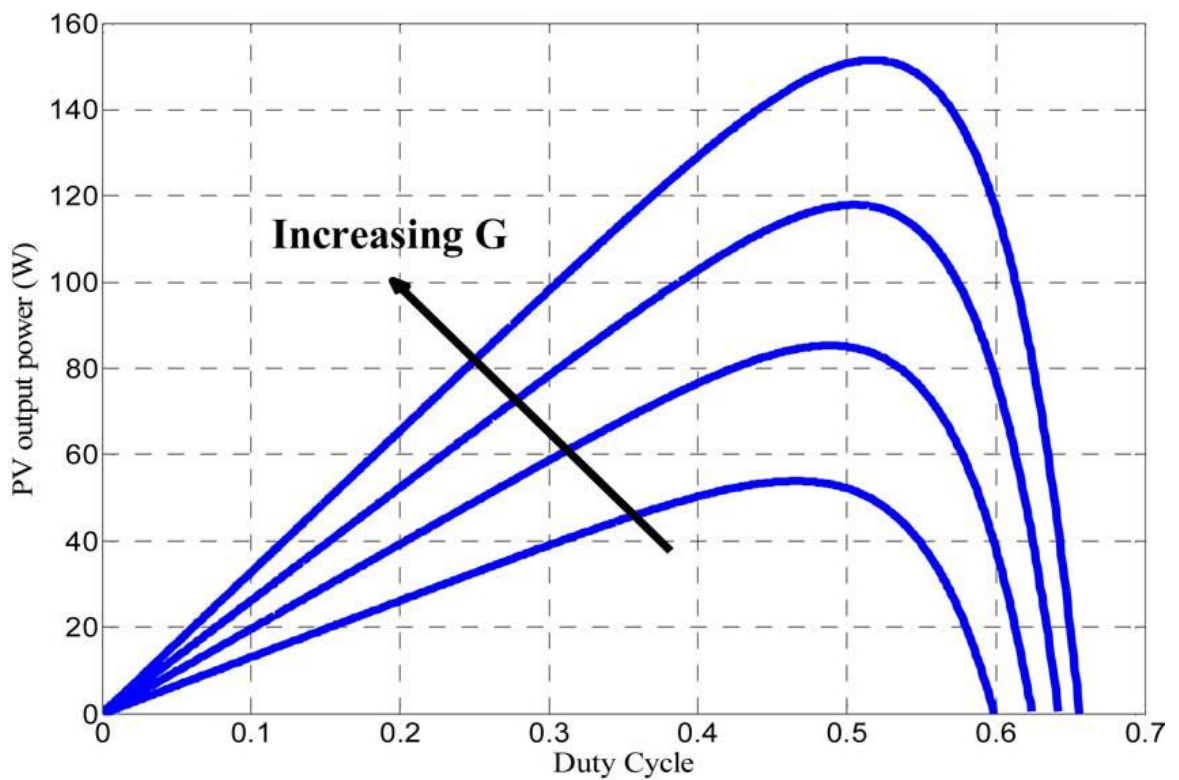
Then we can obtain the output power through the equation:

$$P_{pv} = V_{pv} \times I_{pv} \quad (5.1)$$

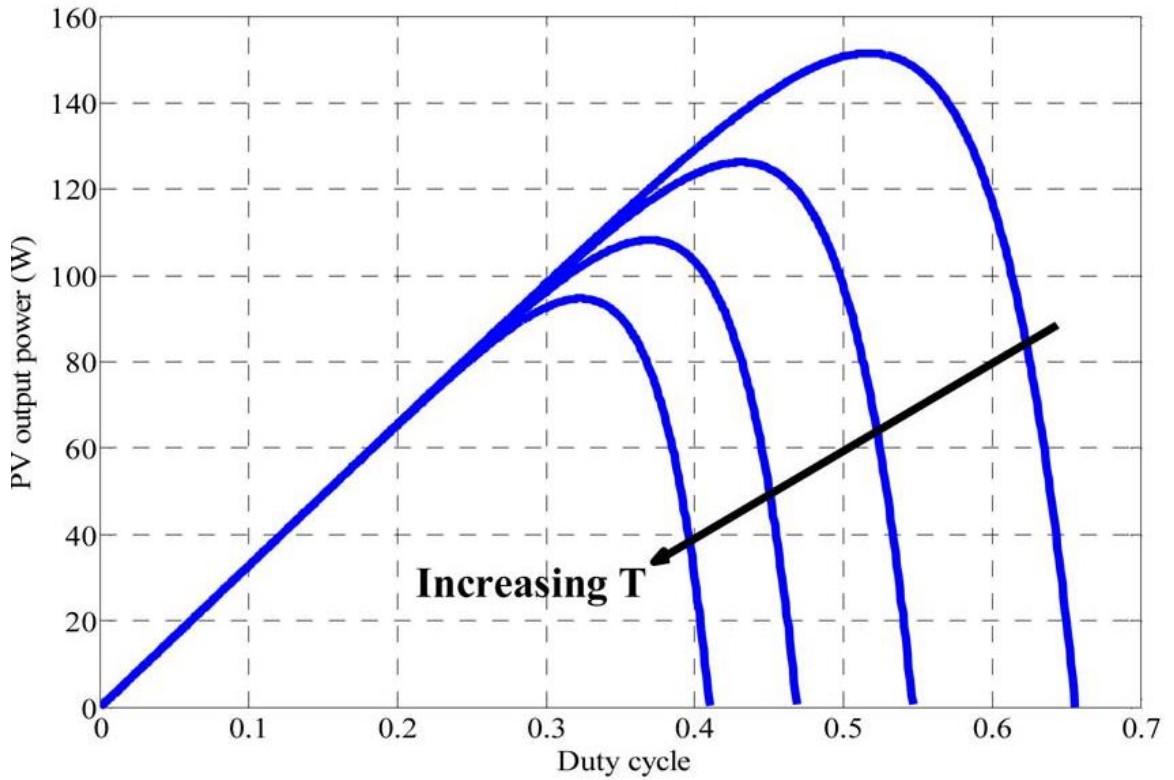
The given data of voltage and current are used to calculate the power and obtaining the P-D curve during all day under the varying of weather conditions. With those P-D curves, the Maximum Power Points in the figures are connected to obtain the different curves for maximum power for everyday in a year. Then comparing the weather conditions information in this year and selecting the normal weather condition as the standard. By “normal”, it means that it contain cloud and sunlight, perhaps a little rain but

not excess. Then MPPs under the standard weather condition are connected to obtain the reference maximum power curve.

The next step is to use the data of radiation and temperature to calculate the P-D curve, but only change one variable each time during the standard weather condition. Hence, it has either irradiance changing or temperature changing from the standard conditions.



**Figure 5.1** P-D curve only changing radiation.



**Figure 5.2** P-D curve only changing temperature.

It is known that from night to day time, the radiation and temperature both increase under the normal condition. From Figures 5.1 and 5.2, it can assume that  $G$  and  $T$  follow the bell curve which is:

$$bell(x; a, b, c) = \frac{1}{1 + \left| \frac{x-c}{a} \right|^{2b}} \quad (5.2)$$



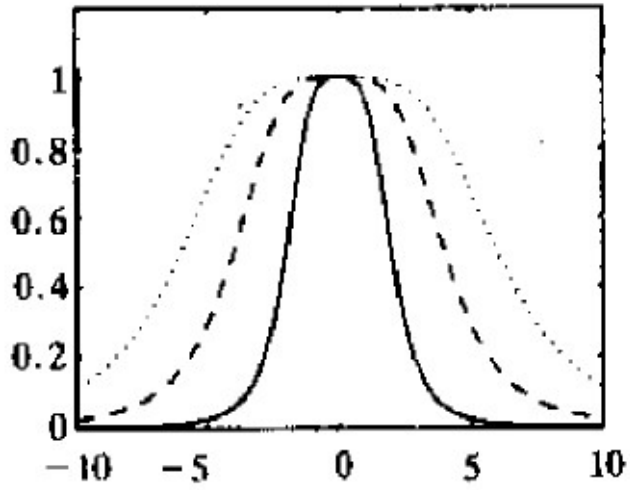


Figure 5.3 Different bell curves under varying of  $a$ .

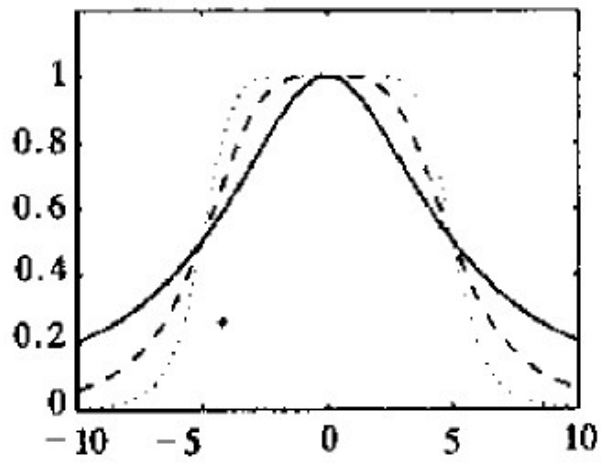


Figure 5.4 Different bell curves under varying of  $b$ .

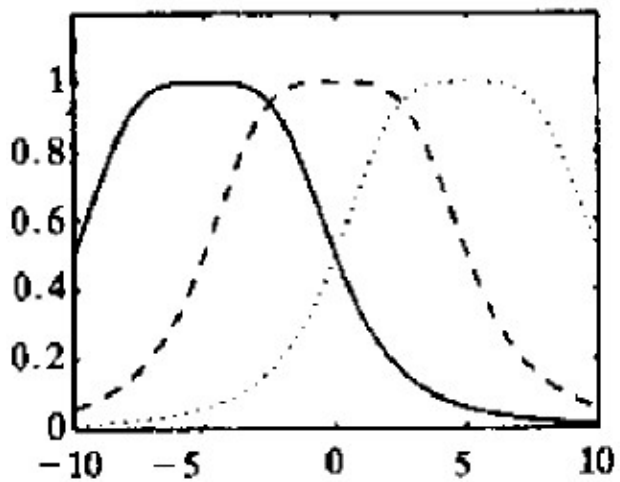


Figure 5.5 Different bell curves under varying of  $c$ .

Through Figures 5.3, 5.4 and 5.5, the characteristic of Maximum Power under different radiation or temperature can be simulated. The only difference between these two characteristics is that the curve of temperature is like the inverse of normal bell curve which means  $b$  is negative. This is mainly because as the temperature increases, the maximum power drops.

After obtaining these two kinds of curves, next step is to start combining them in order to create a new curve that represents the maximum power when radiation and temperature change. Then compare the new curve to the reference curve to adjust the parameters to fit the original one.

## 5.2 Fuzzy Logic Design

Now the maximum power curve is obtained, and then  $P_{max}$  is set as a reference at different time. When the weather changes, fuzzy rules and membership functions can be founded to solve the MPPT problem.

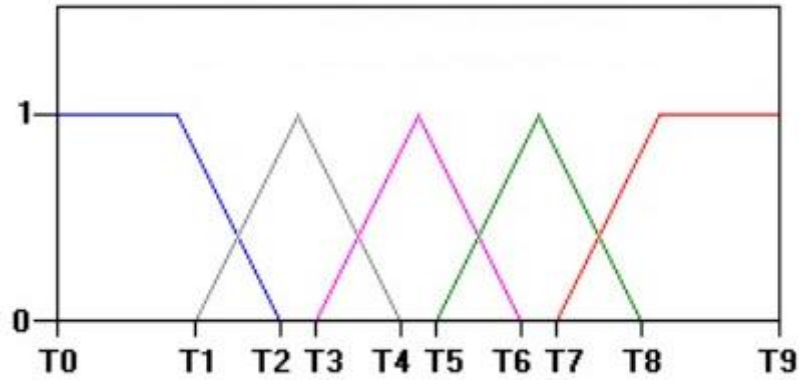
**Table 5.1** Label value of the Input of Fuzzy Logic Controller

Irradiance	Temperature	Weather
Negative big	Negative big	Very cloudy
Negative small	Negative small	cloudy
Normal	Normal	Normal(standard )
Positive small	Positive small	Bright

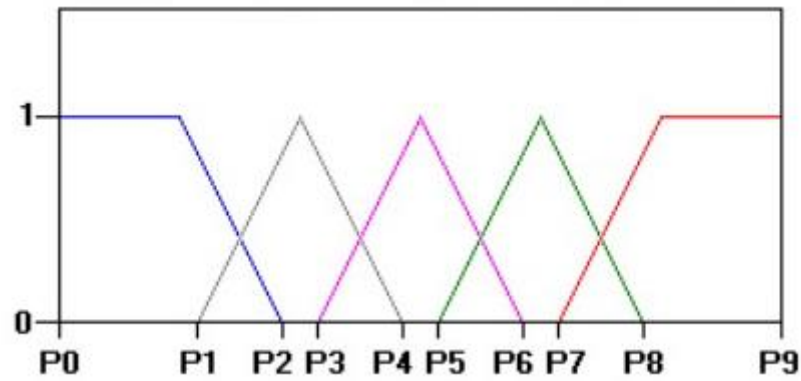
Positive big	Positive big	Strongly bright
--------------	--------------	-----------------

The sample of membership functions of temperature and radiation is shown as

Figures 5.6 and 5.7:



**Figure 5.6** Membership function of temperature.



**Figure 5.7** Membership function of input radiation density.

Thus, the if-then rules are designed as follows:

Rule 1: IF the weather is very cloudy, which means both temperature and radiation are negative big, THEN the maximum power point state drops as negative big.

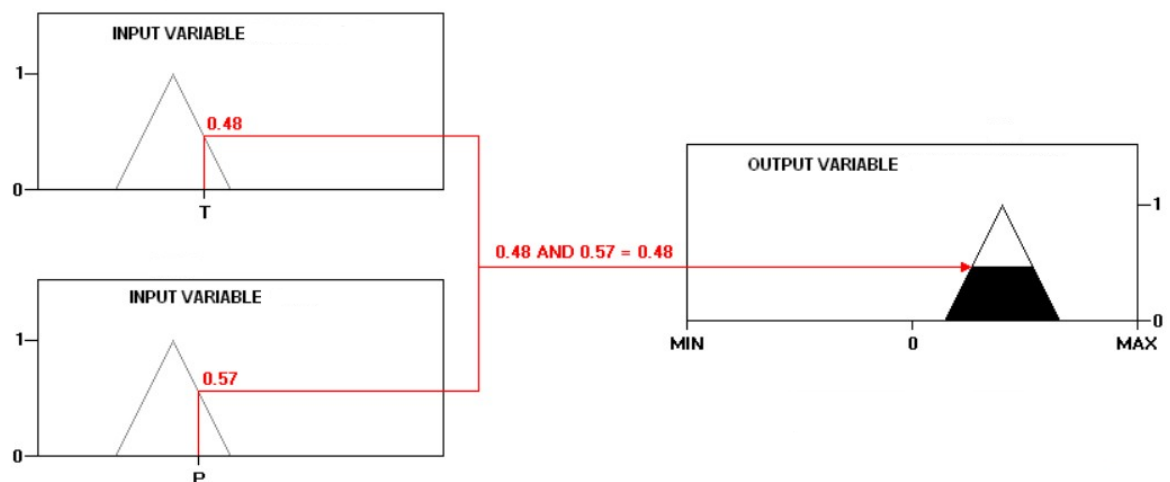
Rule 2: IF the weather is cloudy, which means both temperature and radiation are negative small, THEN the maximum power point state drops as negative small.

Rule 3: IF the weather is normal, which means both temperature and radiation are normal, THEN the maximum power point state remains normal.

Rule 4: IF the weather is bright, which means both temperature and radiation are positive small, THEN the maximum power point state increases as positive small.

Rule 5: IF the weather is very bright, which means both temperature and radiation are positive big, THEN the maximum power point state increases as positive big.

There is one problem to notice: the maximum power is increasing when temperature is NB while radiation is PB. Because the accurate value of the difference is unknown when in this rules, it is simple to assume that the effect of radiation change is bigger than the effect of temperature change. The reason why we make this assumption is that temperature is a time delay variable, while the radiation responds very quickly.



**Figure 5.8** Rule evaluation.

Also, the Mamdani's method is used as shown in Figure 5.8 to evaluate the membership functions' value under the IF-THEN rules.

After the fuzzy rules are decided, the defuzzification is applied to obtain the result for the direction and value of the change of MPP --  $\Delta P_{max}$ .

For defuzzification, the COA method is used:

$$P_{max} = \frac{\int_p \mu_p(p) \times p dp}{\int_p \mu_p(p) dp} \quad (5.3)$$

According to  $\Delta P_{max} = P_{max} - P_{max\_reference}$ ,

If  $\Delta P_{max}$  is not zero, which means the maximum power under this weather is changed, then we need to modify the duty cycle to fit the MPP.

Through all these processes, the power output always keeps at its maximum value.

## **CHAPTER 6**

### **CONCLUSION**

#### **6.1 Contributions**

This thesis introduces the background of solar energy and microgrids. It has covered PV system models, advanced Maximum Power Point Tracking (MPPT) methods and analysis of dc-dc circuit structure. The work has designed a new kind of MPPT methodology based on fuzzy logic. For this new method, it is easy to achieve MPPT, but need enough data to derive the needed reference curve.

#### **6.2 Limitations and Future Directions**

Advantages:

(1) This method directly connects irradiance and temperature to Maximum Power Point.

(2) Different definitions of label values of the membership functions represent different percentage of change in both input and output.

(3) Different fuzzy rules design leads to different weather conditions which will make this method more close to real world. And also, it can fit different places

Disadvantages:

(1) It needs lots of data collection and analysis.

(2) It's difficult to create the model of Maximum Power Point.

(3) The maximum power model is only the approximation of the real world.

## REFERENCES

- Chaouachi, A. ; Kamel, R.M. ; Nagasaka, K., “Microgrid Efficiency Enhancement based on Neuro-Fuzzy MPPT Control for Photovoltaic generator,” in *Photovoltaic Specialists Conference (PVSC)*, 2010, pp. 002889 – 002894.
- Alajmi, B.N. ; Ahmed, K.H. ; Finney, S.J. ; Williams, B.W., “Fuzzy-Logic-Control Approach of a Modified Hill-Climbing Method for Maximum Power Point in Microgrid Standalone Photovoltaic System,” *Power Electronics*, vol. 26, pp. 1022 – 1030, April 2011.
- Abdelsalam, A.K. ; Massoud, A.M. ; Ahmed, S. ; Enjeti, P., “High-Performance Adaptive Perturb and Observe MPPT Technology for Photovoltaic-based Microgrids,” *Power Electronics*, vol. 26, pp. 1010 – 1021, April 2011
- Salam, A.A. ; Adam, I. ; Hamidon, F.Z. ; Haidar, A.M.A., “Behaviour of Grid Connected Photovoltaic System,” in *Industrial Electronics and Applications (ISIEA)*, 2011, pp. 481 – 485.
- Sungwoo Bae and Kwasinski, A., “Dynamic Modeling and Operation Strategy for a Microgrid with Wind and Photovoltaic Resources,” *Smart Grid*, vol. 3, pp. 1867 – 1876, Dec 2012.
- Soto, Daniel and Modi, Vijay., “ Simulations of Efficiency Improvements using Measured Microgrid Data,” *Global Humanitarian Technology Conference (GHTC)*, 2012, pp. 369 – 374.
- Houssamo, I. ; Wang, B. ; Sechilariu, M. ; Locment, F. , Friedrich, G., “A Simple Experimental Prediction Model of Photovoltaic Power for DC Microgrid,” *Industrial Electronics (ISIE)*, 2012, pp. 963 – 968.
- Elrayah, A. ; Sozer, Y. ; Elbuluk, M., “Control of Microgrid-Connected PV-sources,” *Industry Applications Society Annual Meeting (IAS)*, 2012, pp. 1 – 8.
- Du Yan ; Su Jianhui ; Shi Yong., “A Unified Power Controller for Photovoltaic Generators in Microgrid,” *Electric Utility Deregulation and Restructuring and Power Technologies (DRPT)*, 2011, pp. 1121 – 1125.

Peng Li ; Chengjia Liu ; Wanping Li ; Ziheng Yin ; Jianjie Chen ; Kaiwen Liu., “The Research on Photovoltaic Power Flexible Grid-Connected in Microgrid based on  $H_{\infty}$  Control,” *Power System Technology (POWERCON)*, 2012, pp. 1 – 6.

Li Zhang ; Tianjin Wu ; Yan Xing ; Kai Sun ; Gurrero, J.M., “Power Control of DC Microgrid Using DC Bus Signaling,” *Applied Power Electronics Conference and Exposition (APEC)*, 2011, pp. 1926 – 1932.

Peng Li ; Ling Zhang ; Yan Wang ; Yin-Bo Sheng., “Research on the Control of the Single-Stage Photovoltaic System in Microgrid,” *China International Conference on Electricity Distribution (CICED)*, 2008, pp. 1 – 7.

Kanchev, H. ; Di Lu ; Colas, F. ; Lazarov, V. ; Francois, B., “Energy Management and Operational Planning of a Microgrid with a PV-based Active Generator for Smart Grid Applications,” *Industrial Electronics*, vol. 58, pp. 4583 – 4592.

Villalva, M.G. ; Gazoli, J.R. ; Filho, E.R., “Comprehensive Approach to Modeling and Simulation of Photovoltaic Arrays,” *Power Electronics*, vol. 24, pp. 1198 – 1208.

Peftitsis, D. ; Adamidis, G. ; Bakas, P. ; Balouktsis, A., “Photovoltaic System MPPTTracker Investigation and Implementation using DSP engine and Buck-Boost DC-DC converter,” *13<sup>th</sup> Power Electronics and Motion Control Conference (EPE-PEMC)*, 2008, pp. 1840 – 1846.

Kryukov, K.V. ; Valiev, M.M., “Residential Photovoltaic Power Conditioning System with Module Integrated DC-DC Converters,” *15<sup>th</sup> Power Electronics and Motion Control Conference (EPE/PEMC)*, 2012, pp. DS3b.9-1 - DS3b.9-4.

Kadri, R. ; Gaubert, J.-P. ; Champenois, G., “Nondissipative String Current Diverter for Solving the Cascaded DC-DC Converter Connection Problem in Photovoltaic Power Generation System,” *Power Electronics*, vol. 27, pp. 1249 – 1258.

Coelho, R.F. ; Concer, F.M. ; Martins, D.C., “A Simplified Analysis of DC-DC Converters Applied as Maximum Power Point Tracker in Photovoltaic Systems,” *Power Electronics for Distributed Generation Systems (PEDG)*, 2010, pp. 29 – 34.

Vekhande, V. ; Fernandes, B.G., “Module Integrated DC-DC Converter for Integration of Photovoltaic Source with DC Micro-grid,” *38th Annual Conference on IEEE Industrial Electronics Society*, 2012, pp. 5657 – 5662.



Jianwu Zeng ; Wei Qiao ; Liyan Qu., “A Single-Switch Isolated DC-DC Converter for Photovoltaic Systems,” *Energy Conversion Congress and Exposition (ECCE)*, 2012, pp. 3446 – 3452.

Suwannatrai, P. ; Liutanakul, P. ; Wipasuramontorn, P., “Maximum Power Point Tracking by Incremental Conductance Method for Photovoltaic Systems with Phased Shifted Full-Bridge dc-dc Converter,” *8<sup>th</sup> Electrical Engineering/Electronics, Computer, Telecommunications and Information Technology (ECTI-CON)*, 2011, pp. 637 – 640.

Fang Luo ; Pengwei Xu ; Yong Kang ; Shangxu Duan., “A Variable Step Maximum Power Point Tracking Method Using Differential Equation Solution,” *2<sup>nd</sup> Industrial Electronics and Applications (ICIEA)*, 2007, pp. 2259 – 2263.

Fangrui Liu ; Yong Kang ; Yu Zhang ; Shanxu Duan., “Comparison of P&O and Hill-Climbing MPPT Methods for Grid-Connected PV Converter,” *3<sup>rd</sup> Industrial Electronics and Applications (ICIEA)*, 2008, pp. 804 – 807.

Zhang, Hui ; Hong Ji ; Jing Ren ; Lin Shan ; Yongjun Gao., “Research on MPPT Control and Implementation Method for Photovoltaic Generation System and Its Simulation,” *6<sup>th</sup> Power Electronics and Motion Control Conference (IPEMC)*, 2009, pp. 2108 – 2112.

Suganya, J. ; Carolin Mabel, M., “Maximum Power Point Tracker for a Photovoltaic System,” *Computing, Electronics and Electrical Technologies (ICCEET)*, 2012, pp. 463 – 465.

Ovalle, A.A. ; Chamorro, H.R. ; Ramos, G., “Improvements to MPPT for PV Generation based on Mamdani and Takagi-Sugeno Fuzzy techniques,” *Transmission and Distribution: Latin America Conference and Exposition (T&D-LA)*, 2012, pp. 1 – 6.

Sharma, D.K. ; Purohit, G., “Advanced Perturbation and Observation (P&Q) based Maximum Power Point Tracking (MPPT) of a Solar Photo-Voltaic System,” *5<sup>th</sup> Power Electronics (IICPE)*, 2012, pp. 1 – 5.