

C-GROUPS OF HIGH RANK FOR THE SYMMETRIC GROUPS

MARIA ELISA FERNANDES AND DIMITRI LEEMANS

ABSTRACT. We give presentations for the C-groups of rank $n - 1$ of the symmetric group S_n . We also classify C-groups of rank $n - 2$ for S_n . We show that all these C-groups correspond to regular hypertopes, that is, thin, residually connected flag-transitive geometries. Therefore we generalise some similar results obtained in the framework of string C-groups that are in one-to-one correspondence with abstract regular polytopes.

Keywords: C-groups, regularity, thin geometries, abstract polytopes, hypertopes, Coxeter groups, independent generating sets, inductively minimal geometries.

2000 Math Subj. Class: 52B11, 20D06.

1. INTRODUCTION

In 1896, Eliakim H. Moore [21] gave, for the symmetric group S_n , a generating set consisting of the $n - 1$ transpositions $(i, i + 1)$, $(i = 1, \dots, n - 1)$. This set is closely linked to the $(n - 1)$ -simplex and, as it was shown in [15], it gives the unique abstract regular polytope of rank $n - 1$ for S_n when $n \geq 5$. In [15], the authors also proved that, up to isomorphism and duality, there is only one abstract regular polytope of rank $n - 2$ for S_n when $n \geq 7$.

In 1997, Francis Buekenhout, Philippe Cara and Michel Dehon [2] introduced inductively minimal geometries. It turns out that inductively minimal geometries of rank $n - 1$ are all thin with automorphism group the symmetric group S_n . The $(n - 1)$ -simplex is one of them.

There exists a one-to-one correspondence between the set of non-isomorphic inductively minimal geometries of rank $n - 1$ and the set of non-isomorphic trees with n vertices (see [9]). Moreover, the diagrams of these geometries are the line graphs of the corresponding trees.

In 2002, Julius Whiston [23] showed that the size of an independent generating set in the symmetric group S_n is at most $n - 1$. In [6], Peter Cameron and Cara determined all sets meeting this bound and gave a bijection between independent generating sets of size $n - 1$ (up to conjugation and inversion of some generators) and residually weakly primitive coset geometries of rank $n - 1$ for the symmetric group S_n . Particularly, the geometries arising from a group generated by a set of $n - 1$ transpositions in S_n corresponding to the edges of a tree, are precisely, the inductively minimal geometries of rank $n - 1$.

There is a well known correspondence between polytopes and geometries. Indeed polytopes are thin residually connected geometries with a linear diagram. In the present paper we consider geometries whose diagram need not be linear and we generalise Theorems 1 and 2 of [15] giving a classification of regular hypertopes (also known as thin regular residually connected geometries) of ranks $n - 1$ and $n - 2$ for S_n . The automorphism groups of regular hypertopes are C-groups (see

[18]), thus we characterise the geometries in terms of finite quotients of certain Coxeter groups.

C-groups of rank $n - 1$ for S_n are in one-to-one correspondence with regular hypertopes of rank $n - 1$, that are precisely the inductively minimal geometries of rank $n - 1$, thus the classification follows from [6] as explained in Section 3.

Theorem 1.1. *For $n \geq 7$, G a permutation group of degree n and $\{\rho_0, \dots, \rho_{n-2}\}$ a set of involutions of G , $\Gamma := (G, \{\rho_0, \dots, \rho_{n-2}\})$ is a C-group of rank $n - 1$ if and only if the permutation representation graph of Γ is a tree \mathcal{T} with n vertices. Moreover, the ρ_i 's are transpositions, $G \cong S_n$ and the Coxeter diagram of Γ is the line graph of \mathcal{T} . Finally, every such C-group gives a regular hypertope of rank $n - 1$ for S_n .*

The main result of this paper is the following theorem that gives a classification of C-groups of rank $n - 2$ for S_n . Recall that a 2-transposition is an involution that is the product of two transpositions.

Theorem 1.2. *Let $n \geq 9$. Let $\{\rho_0, \dots, \rho_{n-3}\}$ be a set of involutions of S_n . Then $\Gamma := (S_n, \{\rho_0, \dots, \rho_{n-3}\})$ is a C-group of rank $n - 2$ if and only if its permutation representation graph belongs to one the following three families, up to a renumbering of the generators, where $\rho_2, \dots, \rho_{n-3}$ are transpositions corresponding to the edges of a tree with $n - 3$ vertices and the two remaining involutions, ρ_0 and ρ_1 , are either transpositions or 2-transpositions (with at least one of them being a 2-transposition).*

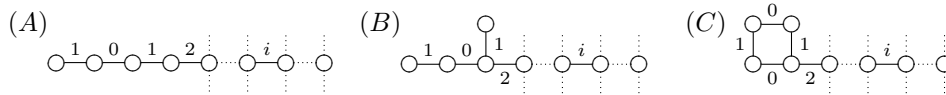

Moreover, every such C-group gives a regular hypertope of rank $n - 2$ for S_n .

In order to prove this theorem, we use group theory and especially knowledge of primitive and transitive imprimitive groups, but also elementary graph theory while investigating permutation representation graphs.

In Section 2 we give the background needed for the understanding of this paper. In Section 3 we focus on the classification of C-groups of rank $n - 1$ for S_n , determining a presentation for these groups. In Section 4 we show that all maximal parabolic subgroups of a C-group of rank $n - 2$ for S_n must be intransitive when $n \geq 9$. In Section 5 we deal with the case where all maximal parabolic subgroups are intransitive and determine the possible shapes of the permutation representation graphs of these C-groups. Finally, in Section 6, we give the proof of Theorem 1.2 and we obtain new presentations for the groups S_n from the permutation representation graphs appearing in Theorem 1.2.

We follow notation of the Atlas [11] for groups.

2. BACKGROUND

2.1. C-groups. Let G be a group generated by r involutions $\rho_0, \dots, \rho_{r-1}$. Then $\Gamma := (G, \{\rho_0, \dots, \rho_{r-1}\})$ is called a C-group of rank r if Γ satisfies the *intersection property* (1) with respect to its generators; that is,

$$(1) \quad \forall J, K \subseteq \{0, \dots, r-1\}, \langle \rho_j \mid j \in J \rangle \cap \langle \rho_k \mid k \in K \rangle = \langle \rho_j \mid j \in J \cap K \rangle$$

Here, ‘‘C’’ stands for ‘‘Coxeter’’, as a Coxeter group is a C-group. Let $p_{i,j}$ be the order of $\rho_i \rho_j$. The *Coxeter diagram* of Γ is a graph whose vertices are the generators

$\rho_0, \dots, \rho_{r-1}$ and with an edge $\{\rho_i, \rho_j\}$ whenever $p_{i,j} > 2$. An edge $\{\rho_i, \rho_j\}$ of the Coxeter graph has a label $p_{i,j}$ when $p_{i,j} > 3$ and it has no label when $p_{i,j} = 3$. The subgroups $G_i = \langle \rho_j : j \in \{0, \dots, r-1\} \setminus \{i\} \rangle$ with $i = 0, \dots, r-1$ are called the *maximal parabolic subgroups of Γ* . Finally, the *C-rank* of a group G is the maximal size r of a set of generators $\{\rho_0, \dots, \rho_{r-1}\}$ of G that satisfies (1).

2.2. Regular hypertopes. As in [3], an *incidence system* $\Gamma := (X, *, t, I)$ is a 4-tuple such that

- X is a set whose elements are called the *elements* of Γ ;
- I is a set whose elements are called the *types* of Γ ;
- $t : X \rightarrow I$ is a *type function*, associating to each element $x \in X$ of Γ a type $t(x) \in I$;
- $*$ is a binary relation on X called *incidence*, that is reflexive, symmetric and such that for all $x, y \in X$, if $x * y$ and $t(x) = t(y)$ then $x = y$.

The *incidence graph* of Γ is the graph whose vertex set is X and where two vertices are joined provided the corresponding elements of Γ are incident. A *flag* is a set of pairwise incident elements of Γ , i.e. a clique of its incidence graph. The *type* of a flag F is $\{t(x) : x \in F\}$. A *chamber* is a flag of type I . An element x is *incident* to a flag F and we write $x * F$ for that, when x is incident to all elements of F . An incidence system Γ is a *geometry* or *incidence geometry* if every flag of Γ is contained in a chamber (or in other words, every maximal clique of the incidence graph is a chamber). The *rank* of Γ is the number of types of Γ , namely the cardinality of I .

Let $\Gamma := (X, *, t, I)$ be an incidence system. Given a flag F of Γ , the *residue* of F in Γ is the incidence system $\Gamma_F := (X_F, *_F, t_F, I_F)$ where

- $X_F := \{x \in X : x * F, x \notin F\}$;
- $I_F := I \setminus t(F)$;
- t_F and $*_F$ are the restrictions of t and $*$ to X_F and I_F .

An incidence system Γ is *residually connected* when each residue of rank at least two of Γ has a connected incidence graph. It is called *thin* when every residue of rank one of Γ contains exactly two elements. Every thin connected rank 2 geometry is an m -gon for some $m \in \mathbb{N} \cup \{\infty\}$. The following result reduces the thinness test to residues of rank two.

Lemma 2.1. [3] *An incidence geometry of rank at least two is thin if and only if all of its rank two residues are thin.*

As in [18], a *hypertope* is a thin incidence geometry which is residually connected.

Let Γ be a hypertope. The *Buekenhout diagram* of Γ is a graph whose vertices are the elements of I and with an edge $\{i, j\}$ with label m whenever every residue of type $\{i, j\}$ is a m -gon and $m \neq 2$. A *polytope* is a hypertope with linear Buekenhout diagram.

Let $\Gamma := (X, *, t, I)$ be an incidence system. An *automorphism* of Γ is a mapping $\alpha : (X, I) \rightarrow (X, I) : (x, t(x)) \mapsto (\alpha(x), t(\alpha(x)))$ where

- α is a bijection on X inducing a bijection on I ;
- for each $x, y \in X$, $x * y$ if and only if $\alpha(x) * \alpha(y)$;
- for each $x, y \in X$, $t(x) = t(y)$ if and only if $t(\alpha(x)) = t(\alpha(y))$.

An automorphism α of Γ is called *type preserving* when for each $x \in X$, $t(\alpha(x)) = t(x)$. An incidence system Γ is *flag-transitive* if $\text{Aut}_I(\Gamma)$ is transitive on all flags of a given type J for each type $J \subseteq I$. Finally, an incidence system Γ is *regular*

if $\text{Aut}_I(\Gamma)$ acts regularly on the chambers (i.e. the action is semi-regular and transitive). A *regular hypertope* is a flag-transitive hypertope. Indeed, as explained in [18], thinness and residual connectedness imply that the stabilizer of a chamber must be the identity element of $\text{Aut}_I(\Gamma)$. Hence whenever a hypertope is flag-transitive, it is necessarily regular.

If Γ is a regular hypertope of rank r with type-set $I := \{0, \dots, r-1\}$, and C is a chamber of Γ , the automorphism group $\text{Aut}_I(\Gamma)$ is generated by a set of *distinguished generators* $\{\rho_0, \dots, \rho_{r-1}\}$ such that ρ_i maps C to its i -adjacent chamber in Γ , that is the unique chamber C_i of Γ such that C and C_i differ only in their respective elements of type i (see Proposition 2B4 of [22] which is easily generalisable to the case of hypertopes).

Given an incidence system Γ and a chamber C of Γ , we may associate to the pair (Γ, C) a pair consisting of a group G and a set $\{G_i : i \in I\}$ of subgroups of G where $G := \text{Aut}_I(\Gamma)$ and G_i is the stabilizer in G of the element of type i in C . The following proposition shows how to reverse this construction, that is starting from a group and some of its subgroups, to construct an incidence system.

Observe that in this paper all C-groups we get give hypertopes as we will show in Section 6.

Proposition 2.2. [24] *Let n be a positive integer and $I := \{0, \dots, r-1\}$ a finite set. Let G be a group together with a family of subgroups $(G_i)_{i \in I}$, X the set consisting of all cosets $G_i g$, $g \in G$, $i \in I$ and $t : X \rightarrow I$ defined by $t(G_i g) = i$. Define an incidence relation $*$ on $X \times X$ by :*

$$G_i g_1 * G_j g_2 \text{ iff } G_i g_1 \cap G_j g_2 \text{ is non-empty in } G.$$

*Then the 4-tuple $\Gamma := (X, *, t, I)$ is an incidence system having a chamber. Moreover, the group G acts by right multiplication as an automorphism group on Γ . Finally, the group G is transitive on the flags of rank less than 3.*

If $\Gamma := \Gamma(G; (G_i)_{i \in I})$ is a regular hypertope, its distinguished generators are the generators of the subgroups $\bigcap_{j \in I \setminus \{i\}} G_j$.

Theorem 2.3. [18][Theorem 4.1] *Let $I := \{0, \dots, r-1\}$ and let $\Gamma := \Gamma(G; (G_i)_{i \in I})$ be a regular hypertope of rank r . The pair (G, S) where S is the set of distinguished generators of Γ is a C-group of rank r .*

Regular hypertopes with a linear Buekenhout diagram are in one-to-one correspondance with C-groups with a linear Coxeter diagram that are also called *string C-groups*. Nevertheless from a C-group that is not string we may not get a regular hypertope. Some examples can be found in [18] as well as the following result.

Proposition 2.4. [18][Theorem 4.6] *Let $(G, \{\rho_0, \dots, \rho_{r-1}\})$ be a C-group of rank r and let $\Gamma := \Gamma(G; (G_i)_{i \in I})$ with $G_i := \langle \rho_j \mid \rho_j \in S, j \in I \setminus \{i\} \rangle$ for all $i \in I := \{0, \dots, r-1\}$. If G is flag-transitive on Γ , then Γ is thin, residually connected and regular (and hence a regular hypertope).*

The following result gives a way to check whether or not Γ is a flag-transitive geometry. See also Dehon [14].

Theorem 2.5. [4] *Let $\mathcal{P}(I)$ be the set of all the subsets of I and let $\alpha : \mathcal{P}(I) \setminus \{\emptyset\} \rightarrow I$ be a function such that $\alpha(J) \in J$ for every $J \subset I$, $J \neq \emptyset$. The geometry $\Gamma := \Gamma(G; (G_i)_{i \in I})$ is flag-transitive if and only if, for every $J \subset I$ such that $|J| \geq 3$,*

we have

$$\bigcap_{j \in J - \alpha(J)} (G_j G_{\alpha(J)}) = \left(\bigcap_{j \in J - \alpha(J)} G_j \right) G_{\alpha(J)}$$

A proof of this result is also available in [3, Theorem 1.8.10]. We prefer to use the following result to check flag-transitivity as it is much easier to apply in our case. In the software MAGMA [1], Leemans implemented an algorithm to check flag-transitivity based on Theorem 2.6. The proof is due to Leemans [19] in his Master's thesis, directed by Francis Buekenhout and Michel Dehon. It is actually fairly easy to obtain from the previous theorem by noting that the conditions tested in the previous theorem amount to test flag-transitivity of rank three geometries.

Theorem 2.6. [19] *Let $\Gamma(G, \{G_0, \dots, G_{r-1}\})$ be a flag-transitive coset geometry of rank r , let H be a subgroup of G and let $\Gamma'(H, \{G_0 \cap H, \dots, G_{r-1} \cap H\})$ be a flag-transitive geometry. Then the incidence systems $\Gamma_{(ij)}(G, \{G_i, G_j, H\})$ is a flag-transitive geometry for each i and j in $\{0, \dots, r-1\}$ if and only if the incidence system $\Gamma''(G, \{G_0, \dots, G_{r-1}, H\})$ is a flag-transitive geometry.*

2.3. Permutation representation graphs. In what follows, $\Gamma := (G, \{\rho_0, \dots, \rho_{r-1}\})$ is a group G generated by the involutions $\rho_0, \dots, \rho_{r-1}$. Moreover, G is of permutation degree n and the maximal parabolic subgroups of Γ are the subgroups $G_i := \langle \rho_j \mid j \neq i \rangle$, $i = 0, \dots, r-1$. Let $J \subseteq I := \{0, \dots, r-1\}$, we define $G_J := \langle \rho_i : i \in I \setminus J \rangle$. If $J = \{i_1, \dots, i_k\}$ we write G_{i_1, \dots, i_k} , omitting the set brackets.

The *permutation representation graph* \mathcal{G} of Γ is the graph with n vertices and an i -edge $\{a, b\}$ whenever $a = \rho_i b$. We denote by \mathcal{G}_I the subgraph of \mathcal{G} with n vertices and with the edges of \mathcal{G} that have labels in I . As G is generated by involutions, $\mathcal{G}_{\{i\}}$ is a matching.

A *fracture graph* \mathcal{F} of Γ is a subgraph of \mathcal{G} containing all vertices of \mathcal{G} . For each subgroup G_i that is intransitive, we pick an edge of \mathcal{G} with label i , such that the edge joins two vertices a_i and b_i that are in distinct orbits of G_i . Therefore a fracture graph has at most r edges. Moreover, it has no i -edges whenever G_i is transitive. Fracture graphs play an important role when every G_i is intransitive as in that case a fracture graph has exactly r edges and is a forest with c components when $r = n - c$ (see [17]). When we want to represent a fracture graph \mathcal{F} it is convenient to distinguish edges in \mathcal{F} from edges that are not in \mathcal{F} . For that reason dashed edges will be used for edges in $\mathcal{G} \setminus \mathcal{F}$.

3. C-GROUPS OF RANK $n - 1$ FOR S_n

In [9] the authors give an enumeration of the inductively minimal geometries of any rank by exhibiting a correspondence between the inductively minimal geometries of rank $n - 1$ and the trees with n vertices. More precisely, the line graph of a tree is the diagram of an inductively minimal geometry and vice-versa. We recall that the *line graph* of a given graph \mathcal{G} is defined as follows:

- the vertices are the edges of \mathcal{G} ;
- two vertices of the line graph are adjacent if they have a common vertex in \mathcal{G} .

In [6] the authors answer the 3rd question of Section 3 of [9], showing that the tree corresponding to a inductively minimal geometry is just the permutation representation of an independent set of size $n - 1$ for S_n , when $n \geq 7$. We summarised their result in Theorem 1.1. We now give a proof of Theorem 1.1.

Proof of Theorem 1.1. Suppose that $\Gamma := (G, \{\rho_0, \dots, \rho_{n-2}\})$ is a C-group of rank $n - 1$. Then $\{\rho_0, \dots, \rho_{n-2}\}$ is an independent set of size $n - 1$, and therefore $G \cong S_n$ [23]. By Theorem 2.1 of [6] the involutions $\rho_0, \dots, \rho_{n-2}$ are transpositions corresponding to the edges of a tree \mathcal{T} . Two generators ρ_i and ρ_j either commute or $(\rho_i \rho_j)^2 = 3$. Therefore the Coxeter diagram of G is the line graph of \mathcal{T} . Conversely Lemma 2 of [9] shows that a line graph of a tree is the diagram of an inductively minimal geometry. Hence $\Gamma(G; (G_i)_{i \in \{0, \dots, r-2\}})$ is a thin residually connected geometry and therefore $\Gamma := (G, \{\rho_0, \dots, \rho_{n-2}\})$ is a C-group. By Theorem 2.4 it remains to prove flag-transitivity. Consider the equalities of Theorem 2.5:

$$\bigcap_{j \in J - \alpha(J)} (G_j G_{\alpha(J)}) = \left(\bigcap_{j \in J - \alpha(J)} G_j \right) G_{\alpha(J)}.$$

Let $H := \left(\bigcap_{j \in J - \alpha(J)} G_j \right) G_{\alpha(J)}$ and $H^i := \left(\bigcap_{j \in J - \alpha(J)} (G_i)_j \right) (G_i)_{\alpha(J)}$ where $(G_i)_i := G_i$. Assume without loss of generality that $\{1, 2\}$ is a leaf of the permutation representation graph of Γ corresponding to the generator ρ_i . We have that $(1, 2) \in H$ and H^i is a subgroup of H acting transitively on $\{2, \dots, n\}$, thus H is isomorphic to S_n . Therefore all the equalities of Theorem 2.5 are verified. \square

We note that the Coxeter diagram Δ of a inductively minimal geometry satisfies the following three properties:

- Δ has no minimal circuit of length greater than three;
- every edge of Δ is in a unique maximal clique;
- each vertex of Δ is either in one or in two maximal cliques.

A graph satisfying these three conditions is called an *IMG diagram* in [9]. The Coxeter diagram of a C-group Γ of rank $n - 1$ is an IMG diagram. In the following proposition we prove that each triangle of the Coxeter diagram of Γ corresponds to the finite geometric group [111]² (as defined in [13]), that is, a C-group with three generators, say ρ_0, ρ_1, ρ_2 , satisfying the relations $\rho_0^2 = \rho_1^2 = \rho_2^2 = (\rho_0 \rho_1)^3 = (\rho_0 \rho_2)^3 = (\rho_1 \rho_2)^3 = (\rho_0 \rho_1 \rho_0 \rho_2)^2 = 1$.

The following proposition shows that to every IMG-diagram we can associate a presentation of S_n by adding to the usual Coxeter relations obtained from the Coxeter diagram an extra relation for each triangle appearing in the diagram.

Proposition 3.1. *Let $G = S_n$. For $n \geq 7$, $\Gamma := (G, \{\rho_0, \dots, \rho_{n-2}\})$ is a C-group of rank $n - 1$ if and only if G is abstractly defined by the relations corresponding to its Coxeter diagram, that is an IMG diagram, and a relation $(\rho_i \rho_j \rho_i \rho_k)^2 = 1$ whenever $\{\rho_i, \rho_j, \rho_k\}$ is a triangle of the Coxeter diagram.*

Proof. By Theorem 1.1, Γ is a C-group of rank $n - 1$ if and only if the permutation representation graph of Γ is a tree \mathcal{T} with n vertices. It remains to prove that the defining relations of G are those corresponding to the Coxeter diagram plus $(\rho_i \rho_j \rho_i \rho_k)^2 = 1$ whenever $\{\rho_i, \rho_j, \rho_k\}$ is a triangle of the Coxeter diagram.

Suppose that Γ is a C-group of rank $n - 1$. By Theorem 1.1, its permutation representation graph \mathcal{G} is a tree. Suppose that $\{\rho_i, \rho_j, \rho_k\}$ is a triangle of the Coxeter Diagram of Γ . Then $\mathcal{G}_{\{i,j,k\}}$ is as follows.

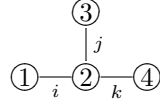

For the above numbering of the vertices we have $\rho_i \rho_j \rho_i \rho_k = (13)(24)$, therefore $(\rho_i \rho_j \rho_i \rho_k)^2 = 1$.

Now let us prove that the relations of the Coxeter diagram plus the relations of the form $(\rho_i \rho_j \rho_i \rho_k)^2 = 1$ corresponding to a triangle of the Coxeter Diagram, are sufficient to give a presentation of G . The fact that Γ is a C-group will then follow from Theorem 1.1.

First suppose that the Coxeter diagram of Γ has no triangles. Then the vertices of the permutation representation graph of Γ have degree at most two. In this case Γ is the n -simplex. The Coxeter diagram of Γ gives all the relations for a presentation of G . We now proceed by induction, assuming that the proposition holds whenever the Coxeter diagram has less than t triangles.

Suppose that the Coxeter diagram of Γ has exactly t triangles. Pick any vertex v of \mathcal{G} of degree one and let w be the vertex of degree at least three closest to v . Now let z be another vertex of degree one. Consider the labelling of the edges as in the following figure.

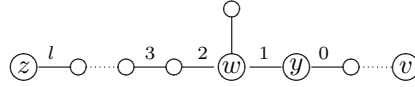

Removing the 1-edge $\{w, y\}$ of \mathcal{G} and replacing it by the 1-edge $\{y, z\}$ we obtain another graph \mathcal{D} that is also a tree.

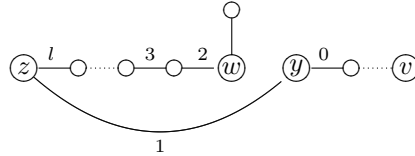

By Theorem 1.1, \mathcal{D} is the permutation representation graph of a C-group $\Delta := (H, \{\alpha_0, \dots, \alpha_{n-2}\})$ of rank $n - 1$ with $H = S_n$. By construction the Coxeter diagram of Δ has less triangles than the Coxeter diagram of Γ . Indeed we reduced the degree of w increasing the degree of a vertex of degree one, thus we did not create another triangle, as only vertices of degree at least three correspond to triangles of the Coxeter diagram.

By induction, apart from the relations given by the Coxeter diagram of Δ , that is the line graph of \mathcal{D} following Theorem 1.1, we have the relations $(\alpha_i \alpha_j \alpha_i \alpha_k)^2 = 1$ for each triangle $\{\alpha_i, \alpha_j, \alpha_k\}$ of the Coxeter Diagram.

In what follows we rewrite the relations of the presentation of H in terms of the ρ_i 's to get a presentation of G . According to the way the permutation representation of H was obtained from the permutation representation of Γ we have that $\rho_i = \alpha_i$ for $i \neq 1$ and $\rho_1 = \alpha_1^{\alpha_2 \dots \alpha_l}$. Using this substitution, all the relations not involving α_1 give either relations of the Coxeter diagram of Δ or relations of the

form $(\rho_i \rho_j \rho_i \rho_k)^2 = 1$ whenever $\{\rho_i, \rho_j, \rho_k\}$ is a triangle of the Coxeter diagram of Δ (and of Γ). Therefore we need to consider only the relations of H involving α_1 .

First if i is such that the i -edge of \mathcal{D} is not incident to a vertex of the path between w and z , then α_i commutes with $h = \alpha_2 \dots \alpha_l$, hence $\rho_1 \rho_i = h^{-1} \alpha_1 h \alpha_i = (\alpha_1 \alpha_i)^h$. Therefore $\alpha_1 \alpha_i$ and $\rho_1 \rho_i$ have the same order.

Now suppose that i is the label of an edge e incident to a vertex of the path from w to z . We deal with the following cases separately: (1) e is incident to w and $i \neq l$, (2) e is an edge of the path and is not incident to w and $i \in \{2, \dots, l-1\}$, (3) e is an edge of the path and $i = l$ and (4) $i \notin \{1, \dots, l-1\}$ but is a label of an edge incident to the path from w to z . Let $g_i := \rho_i \dots \rho_l$ for $i \in \{2, \dots, l-1\}$, $g_l := \rho_l$ and $g_{l+1} := 1$.

(1) In this case $(\alpha_1 \alpha_i)^2 = 1$. We have $\alpha_1 \alpha_i = g_3^{-1} \rho_2 \rho_1 \rho_2 g_3 \rho_i = g_3^{-1} \rho_2 \rho_1 \rho_2 \rho_i g_3$. Thus $(\alpha_1 \alpha_i)^2 = 1 \Leftrightarrow (\rho_2 \rho_1 \rho_2 \rho_i)^2 = 1$. In this case we get the relation corresponding to the triangles $\{\rho_1, \rho_2, \rho_i\}$ of the Coxeter diagram of Γ .

(2) Here $(\alpha_1 \alpha_i)^2 = 1$ and $\alpha_1 \alpha_i = g_2^{-1} \rho_1 g_2 \rho_i = g_2^{-1} \rho_1 \rho_2 \dots \rho_{i-1} (\rho_i \rho_{i+1} \rho_i) g_{i+2} = g_2^{-1} \rho_1 \rho_2 \dots \rho_{i-1} (\rho_{i+1} \rho_i \rho_{i+1}) g_{i+2} = g_2^{-1} \rho_1 \rho_{i+1} \rho_2 \dots \rho_{i-1} \rho_i \rho_{i+1} g_{i+2} = (\rho_1 \rho_{i+1})^{g_2}$. Thus $(\alpha_1 \alpha_i)^2 = 1 \Leftrightarrow (\rho_1 \rho_{i+1})^2 = 1$, $i \in \{2, \dots, l-1\} \Leftrightarrow (\rho_1 \rho_i)^2 = 1$, $i \in \{3, \dots, l\}$. In this case we obtain a relation implicit in the Coxeter diagram of Γ .

(3) Let first $l \neq 2$. We have $\alpha_1 = \rho_l^{\rho_{l-1} \dots \rho_2 \rho_1}$. Hence $\alpha_1 \alpha_l = \rho_l^{\rho_{l-1} \dots \rho_2 \rho_1} \rho_l = \rho_1 \rho_2 \dots \rho_{l-2} (\rho_{l-1} \rho_l \rho_{l-1} \rho_l) \rho_{l-2} \dots \rho_2 \rho_1 = (\rho_l \rho_{l-1})^{\rho_{l-2} \dots \rho_2 \rho_1}$ thus $(\alpha_1 \alpha_l)^3 = 1 \Leftrightarrow (\rho_l \rho_{l-1})^3 = 1$. When $l = 2$, $\alpha_1 = \rho_1^{\rho_2} = \rho_2^{\rho_1}$ hence $(\rho_1 \rho_2)^3 = 1$. In any case we obtain a relation implicit in the Coxeter diagram of Γ .

(4) Suppose that i is incident to the j -edge and to the $(j-1)$ -edge for some $j \in \{3, \dots, l\}$.

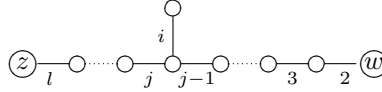

In this case we have that $(\alpha_{j-1} \alpha_j \alpha_i \alpha_j)^2 = 1$ thus,

$$\begin{aligned} \alpha_1 \alpha_i &= g_2^{-1} \rho_1 g_2 \rho_i = g_2^{-1} \rho_1 \rho_2 \dots \rho_{j-1} \rho_j \rho_i g_{j+1} = \\ &= g_2^{-1} \rho_1 \rho_2 \dots \rho_{j-2} (\rho_{j-1} \rho_j \rho_i \rho_j) g_j = \\ &= g_2^{-1} \rho_1 \rho_2 \dots \rho_{j-2} (\rho_j \rho_i \rho_j \rho_{j-1}) g_j = \\ &= g_2^{-1} \rho_1 \rho_j \rho_i \rho_j g_2 = (\rho_1 \rho_i)^{\rho_j g_2}. \end{aligned}$$

Hence $(\alpha_1 \alpha_i)^2 = 1 \Leftrightarrow (\rho_1 \rho_i)^2 = 1$. In this case we obtain a relation implicit in the Coxeter diagram of Γ .

This proves that each relation of Δ is either converted in a relation implicit in the Coxeter diagram of Δ or into a relation of the form $(\rho_i \rho_j \rho_i \rho_k)^2 = 1$, and the latter happens when $\{\rho_i, \rho_j, \rho_k\}$ is a triangle of the Coxeter diagram of Γ . \square

Proposition 3.1 can be seen as a corollary of the results obtained in [8] where the authors have more general results related to Coxeter groups with diagrams having cycles of odd length.

4. BOUNDING THE C-RANK OF A TRANSITIVE MAXIMAL PARABOLIC SUBGROUP OF A C-GROUP FOR S_n

Let $G := S_n$. In this section we prove that if $\Gamma := (G, \{\rho_0, \dots, \rho_{r-1}\})$ is a C-group of rank r and G_i is transitive for some $i \in \{0, \dots, r-1\}$, then $r \leq n-3$ when $n \geq 9$. The proofs of this section are very similar to those in [7]. We decide

to give them in full details here as the latter reference deals with string C-groups and we deal with the more general framework of C-groups. We first deal with the case where G_i is a primitive group of degree n for some $i \in \{0, \dots, r-1\}$. Let us recall the following result that gives a bound for the order of a primitive group of given degree.

Theorem 4.1. [20] *Let G be a primitive group of degree n which is not S_n nor A_n . Then one of the following possibilities occurs:*

- (1) *For some integers m, k, l we have $n = \binom{m}{k}^l$, and G is a subgroup of $S_m \wr S_l$, where S_m is acting on k -subsets of $\{1, \dots, m\}$;*
- (2) *G is M_{11}, M_{12}, M_{23} or M_{24} in its natural 4-transitive action;*
- (3) $|G| \leq n \cdot \prod_{i=0}^{\lfloor \log_2 n-1 \rfloor} (n-2^i)$

Now we establish that the C-rank of G_i is at most $n-4$ when G_i is primitive and $n \geq 9$. In order to do this, we use the fact that the C-rank of a group H is at most the maximum length of a chain of subgroups from H to the trivial subgroup of H . This is an immediate consequence of the intersection property (1).

Lemma 4.2. *The C-rank of a C-group $(G, \{\rho_0, \dots, \rho_{r-1}\})$ where G is a primitive group of degree $n \geq 9$, not isomorphic to A_n or S_n , is at most $n-4$.*

Proof. We consider separately the three possibilities given by Theorem 4.1.

In case (1) when $l \geq 2$ we have $n-4 = \binom{m}{k}^l - 4 \geq m^l - 4 \geq ml - 2 \geq r$. When $l = 1$ we have $k \geq 2$, $m \leq n/2$ and the group is a subgroup of S_m or A_m , so its rank is at most $m-1$, much smaller than $n-4$.

In case (2) we have to consider the groups M_{11}, M_{12}, M_{23} or M_{24} . The maximal length of a chain of subgroups of M_{11}, M_{23} or M_{24} is 7, 11 and 14 resp. (see [23]). Note that the bound for the chain length is also a bound for the C-rank. If G is isomorphic to M_{12} then the C-rank of G is at most 9 [23]. Suppose that the C-rank of G is 9. Then one of the following subgroups of M_{12} , namely M_{11} or $PGL(2, 9)$, has to have C-rank 8. As the rank of M_{11} is at most 7 (see [23]), $PGL(2, 9)$ should have C-rank 8. If this is so, one of the following groups, $PGL(2, 9)$, S_6 or M_{10} have C-rank 7. The latter is not generated by involutions, S_6 is known to have C-rank at most 5 and $PGL(2, 9)$ has C-rank at most 3 (see [10]), thus we get a contradiction. Hence the C-rank of M_{12} is at most 8.

In case (3) we use the fact that the length of a maximal chain of subgroups in G is bounded by $\log_2(|G|)$ since every subgroup appearing in the chain must be at least twice smaller than its overgroup. Hence, in this case we have that the chain length is bounded by $\log_2 \left[n \cdot \prod_{i=0}^{\lfloor \log_2 n-1 \rfloor} (n-2^i) \right]$ that is at most $n-4$ for $n \geq 26$. For the primitive groups of degree 9 (see for instance [5]), we readily see that the only groups that can be generated by involutions are $3^2 : D_8$, $AGL(2, 3)$ and $PSL(2, 8)$. The group $3^2 : D_8$ has chains of maximum length 5 in its subgroup lattice. An exhaustive computer search with MAGMA [1] gives C-rank 4 for $AGL(2, 3)$. The C-rank of $PSL(2, 8)$ is known to be 3 by [10]. The primitive groups G with degree between 10 and 25 for which $\log_2(|G|) > n-4$ are listed in Table 1 where r is the C-rank of the corresponding group. It is well known that M_{10} cannot be generated by involutions, hence its C-rank is 0. For $PGL(2, 9)$, we already showed above that the C-rank is at most 6. A chain of subgroups in the subgroup lattice of $PSL(3, 3)$

n	G	r	n	G	r	n	G	r
10	$PSL_2(9)$	3 [10]	12	$PSL_2(11)$	4 [10]	16	$2^4 : A_6$	≤ 10
	S_6	5 [23]		$PGL_2(11)$	4 [10]		$2^4 : S_6$	≤ 11
	$PGL_2(9)$	4 [10]	13	$PSL_3(3)$	≤ 8		$2^4 : A_7$	≤ 11
	M_{10}	0	14	$PGL_2(13)$	3 [10]		$AGL_4(2)$	≤ 12
	$P\Gamma L_2(9)$	≤ 6	15	$PSL_4(2)$	≤ 9	22	$M_{22} : 2$	≤ 13
11	$PSL_2(11)$	4 [10]						

TABLE 1. The groups not failing the chain length bound.

has length 8 at most, hence the C-rank of $PSL(3, 3)$ is 8 at most. A chain of subgroups in the subgroup lattice of $PSL(4, 2)$ has length 9 at most, hence the C-rank of $PSL(4, 2)$ is 9 at most. A chain of subgroups in the subgroup lattice of $2^4 : A_7$ or $2^4 : S_6$ has length 11 at most, hence the C-rank of these groups is 11 at most. A chain of subgroups in the subgroup lattice of $2^4 : A_6$ has length 10 at most, hence the C-rank is 10 at most. A chain of subgroups in the subgroup lattice of $M_{22} : 2$ has length 13 at most, hence the C-rank is 13 at most. For $AGL(4, 2)$, a chain of subgroups may have up to length 13 but a computer search shows that none of the groups at Level 5 in the subgroup lattice that could have a C-group representation with a non-empty graph as diagram have C-rank 5. So $AGL(4, 2)$ cannot be of C-rank 13. \square

Lemma 4.3. *Let $G = S_n$. If $\Gamma := (G, \{\rho_0, \dots, \rho_{r-1}\})$ is a C-group of rank $n - 2$ with $n \geq 3$, then G_i is not isomorphic to A_n , for every $i = 0, \dots, r - 1$.*

Proof. Suppose without loss of generality that G_0 is isomorphic to A_n . Then, since Γ satisfies the intersection property, we have $G_0 \cap \langle \rho_0, \rho_i \rangle = \langle \rho_i \rangle$ for all $i = 1, \dots, n - 3$. As $\rho_i \in A_n = G_0$ also $\rho_i^{\rho_0} \in A_n = G_0$ thus, $\rho_i^{\rho_0} = \rho_i$ for all i which implies that $S_n \cong A_n \times C_2$, a contradiction. \square

Proposition 4.4. *Let $n \geq 9$ and $G := S_n$. If $\Gamma := (G, \{\rho_0, \dots, \rho_{r-1}\})$ is a C-group of rank r and G_i is transitive imprimitive for some $i \in \{0, \dots, r - 1\}$, then $r \leq n - 3$.*

Proof. The case $n = 9$ is dealt with by performing an exhaustive computer search using MAGMA. We now assume $n \geq 10$. Suppose that G_i is embedded into $S_k \wr S_m$ with k being maximal. Let $S = \{\rho_j \mid j \in I, j \neq i\}$ and denote by M the subset of S generating the block action. We have that $|M| \leq m - 1$ (see [23]). We can use the elements of M to undo the block action of the elements of $N := S \setminus M$ (by right multiplication), and as shown in Lemma 3 of [23], we get an independent set $\bar{S} = M \cup \bar{N}$ with \bar{N} fixing the blocks setwisely. Consider the action of \bar{N} on the blocks.

First suppose there is no ordering on the blocks such that \bar{N} acts as S_k on the first $m - 2$ blocks. In that case $|\bar{S}| \leq (m - 1) + m(k - 1) - 3 = n - 4$. Thus $r \leq n - 3$.

Now assume there exists an ordering such that the action of \bar{N} on the first $m - 2$ blocks is S_k . We now use the following argument used in the proof of Proposition 4 of [23]: if $B \subset \bar{N}$ generates the action on the first i blocks for $i \leq m - 2$, then at most one element of \bar{N} needs to be added to $M \cup B$ to generate the block action on $(i + 1)$ blocks. Therefore,

$$|\bar{S}| \leq (m - 1) + (k - 1) + (m - 2) + (k - 2) = 2m + 2k - 6.$$

Now $2m + 2k - 6 \leq km - 4 \Leftrightarrow (m - 2)(k - 2) \geq 2$ which is true for $n \geq 10$ and $m, k \neq 2$.

Let us consider the case $k = 2$. If $|\bar{N}| \leq 1$ then $r \leq m = \frac{n}{2} \leq n - 4$, thus it may be assumed that $|\bar{N}| \geq 2$. In that case there exists $j \neq i$ such that $G_{i,j}$ is transitive. First if G_j is primitive then by Lemmas 4.2 and 4.3 $r \leq n - 3$. If G_j is imprimitive by assumption G_j cannot be embedded into a wreath product with more than two blocks. Hence $G_{i,j}$ is embedded into $S_2 \wr S_{\frac{n}{2}}$ for two distinct blocks systems. Now we can use the argument used in [16] to prove that $G_{i,j}$ must be a dihedral group. Therefore $r - 2 \leq \log_2(2n) \leq n - 5$ for $n \geq 10$.

Now suppose that $m = 2$ and assume the action of \bar{N} is not S_k neither in block 1 nor in block 2, for otherwise $r - 1 \leq 1 + (k - 1) + 1 \leq 2k - 4 = n - 4$ for $n \geq 10$. Consider two subsets of \bar{N} , A and B , generating independently the block action of \bar{N} on block 1 and on block 2, respectively. If $A \cap B \neq \emptyset$ then $|\bar{N}| \leq |A| + |B| - 1$, thus

$$|S| \leq 1 + 2(k - 2) - 1 = n - 4.$$

Suppose that $A \cap B = \emptyset$ and let $M = \{\tau\}$. As the conjugation by the permutation of τ defines an isomorphism between the group action on block 1 and the group action on block 2, these groups must both be transitive on the respective blocks, otherwise G_i is itself intransitive, a contradiction. Then if any element $\alpha_j \in \bar{N} = A \cup B$ is removed from the generating set $M \cup \bar{N}$, we still get a transitive group $G_{i,j}$. If G_j is primitive then $r \leq n - 3$. Suppose that G_j is imprimitive. If G_j is embedded into a block system with more than two blocks of size greater than two, then we have proved previously that $r \leq n - 3$. Thus we need to consider only two cases: G_j is embedded into $S_{\frac{n}{2}} \wr S_2$ and G_j is embedded into $S_2 \wr S_{\frac{n}{2}}$.

Let us first consider that G_j is embedded into $S_{\frac{n}{2}} \wr S_2$. The block systems of the embeddings of G_j and G_i need to be different, otherwise G is itself embedded into $S_{\frac{n}{2}} \wr S_2$, a contradiction. Thus $G_{i,j}$ is embedded into $S_{\frac{n}{2}} \wr S_2$ for two distinct block systems $\{X, X\tau\}$ and $\{Y, Y\delta\}$. Then $G_{i,j}$ is also embedded into $S_{\frac{n}{4}} \wr S_4$ with the block system being $\{X \cap Y\}, \{X \cap Y\delta\}, \{X\tau \cap Y\}, \{X\tau \cap Y\delta\}$ with $\{\tau, \delta\}$ generating the block action. Now let $M = \{\tau, \delta\}$, let N be the set of the remaining generators of $G_{i,j}$ and consider the set \bar{N} as before. If there is no ordering on the blocks such that \bar{N} acts as $S_{\frac{n}{4}} \times S_{\frac{n}{4}}$ in the first two blocks we have $|S| - 1 \leq 2 + 4(n/4 - 1) - 3 \Rightarrow |S| \leq n - 4$. Now suppose the contrary. Hence we have $|S| - 1 \leq 2 + (n/4 - 1) + 2 + (n/4 - 2) \Rightarrow |S| \leq n - 3$ for $n \geq 10$. Suppose that G_j is embedded into $S_2 \wr S_{\frac{n}{2}}$. Now we may assume that for this embedding $|\bar{N}| \leq 1$ otherwise there exist $k \neq j, i$ such that G_k is transitive and then we get one of the situations considered previously. Hence $r - 1 \leq 1 + \frac{n}{2} - 1 \leq n - 4$ for $n \geq 8$. \square

Proposition 4.5. *Let $n \geq 9$ and $G = S_n$. If $\Gamma := (G, \{\rho_0, \dots, \rho_{r-1}\})$ is a C-group of rank $r \in \{n - 2, n - 1\}$ then G_i is intransitive for every $i \in \{0, \dots, r - 1\}$.*

Proof. This is a consequence of Lemmas 4.2 and 4.3 and Proposition 4.4. \square

5. INTRANSITIVE MAXIMAL PARABOLIC SUBGROUPS OF A C-GROUP OF RANK $n - 2$ FOR S_n

Let $n \geq 9$, $G := S_n$ and $\Gamma := (G, \{\rho_0, \dots, \rho_{n-3}\})$ be a C-group of rank $n - 2$. Suppose that G_i is intransitive for every $i \in \{0, \dots, n - 3\}$. Let \mathcal{G} be the permutation representation graph of Γ and \mathcal{F} be a fracture graph of Γ . We recall the following lemma that will be useful in later proofs.

Lemma 5.1. [17, Lemmas 3.2 and 3.5] \mathcal{F} has exactly 2 connected components. Moreover, the edges of \mathcal{G} that are not in \mathcal{F} must connect vertices in different connected components of \mathcal{F} .

In the next lemma we prove that the connection in \mathcal{G} between the two components of the fracture graph is made either by a single edge, a multiple edge or an alternating square.

Lemma 5.2. If $\{a, b\}$ and $\{c, d\}$ are distinct edges ($\{a, b\} = \{c, d\}$ means that $\{a, b\}$ is a double edge) of $\mathcal{G} \setminus \mathcal{F}$ with labels i and j respectively then:

- (1) $\{a, b\} \cap \{c, d\} \neq \emptyset$, particularly $i \neq j$;
- (2) If $\{a, b\} \neq \{c, d\}$ then i and j are labels of edges of a square with alternating labels i and j as in the following figure.

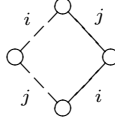

Proof. Suppose $\{a, b\} \cap \{c, d\} = \emptyset$. Then, by Lemma 5.1, a and b (and also c and d) are in distinct connected components of \mathcal{F} . Suppose without loss of generality that a and c are in the same connected component of \mathcal{F} (and hence b and d are in the other connected component of \mathcal{F}) and that there exists a k -edge $\{e, f\}$ of \mathcal{F} with $i \neq k \neq j$ in that connected component (see picture below). Then e and f are in the same G_k -orbit. This contradicts the fact that \mathcal{F} is a fracture graph and proves (1).

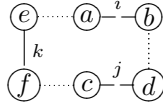

Let us now prove (2). Suppose that $a = c$ and $b \neq d$. Again by Lemma 5.1, b and d are in the same connected component of \mathcal{F} . Hence there is a path of \mathcal{F} leading from b to d . This path cannot contain edges of label different from i and j for otherwise, \mathcal{F} would not be a fracture graph. Therefore, $\{a, b\}$ and $\{a, d\}$ must be edges of an $\{i, j\}$ -square with a in one component of \mathcal{F} and the other vertices of the square in the other component as in the following figure.

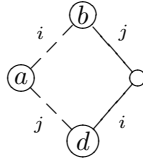

□

The following lemma shows that the distinguished generators of G are either transpositions or 2-transpositions.

Lemma 5.3. Let $n \geq 9$. If \mathcal{G} has at least two i -edges, then \mathcal{G} has exactly two i -edges and the distance between a pair of i -edges of \mathcal{G} is one.

Proof. Suppose $\{a, b\}$ and $\{c, d\}$ are i -edges of \mathcal{G} . By Lemma 5.2 (1), there are at most two i -edges in \mathcal{G} . Let $\{a, b\}$ be the i -edge in \mathcal{F} . If the two i -edges are in a square, as in Lemma 5.2 (2), then the distance between them is one, as wanted.

Now consider that the i -edges are not in a square and are not at distance one. Suppose that j and l are labels of edges of a path from $\{a, b\}$ to $\{c, d\}$, as follows.

$$\textcircled{a} \xrightarrow{i} \textcircled{b} \xrightarrow{l} \textcircled{} \cdots \textcircled{} \xrightarrow{j} \textcircled{c} \xrightarrow{i} \textcircled{d}$$

By Lemmas 5.1 and 5.2, there are four possibilities for the graph $\mathcal{G}_{i,j,l}$:

$$(1) \quad \textcircled{a} \xrightarrow{i} \textcircled{b} \xrightarrow{l} \textcircled{} \xrightarrow{j} \textcircled{c} \xrightarrow{i} \textcircled{d} \quad (2) \quad \textcircled{a} \xrightarrow{i} \textcircled{b} \xrightarrow{l} \textcircled{} \xrightarrow{j} \textcircled{c} \xrightarrow{\frac{i}{l}} \textcircled{d}$$

$$(3) \quad \textcircled{a} \xrightarrow{i} \textcircled{b} \xrightarrow{l} \textcircled{} \xrightarrow{j} \textcircled{c} \xrightarrow{i} \textcircled{d} \quad (4) \quad \textcircled{a} \xrightarrow{i} \textcircled{b} \xrightarrow{l} \textcircled{e} \xrightarrow{j} \textcircled{c} \xrightarrow{\frac{i}{l}} \textcircled{d}$$

In the first and third case $(ab) \in \langle \rho_i, \rho_j \rangle \cap \langle \rho_i, \rho_l \rangle$ but $(ab) \notin \langle \rho_i \rangle$, a contradiction with the intersection property. In the second case, $\langle \rho_i, \rho_j \rangle \cap \langle \rho_j, \rho_l \rangle$ contains at least an element of order 3, a contradiction with the intersection property again. In case (4), as $n \geq 9$, there must be at least another edge with label m in the fracture graph. Suppose the connected component of \mathcal{F} containing d contains such an edge m starting at d . Then, $\langle \rho_i, \rho_m \rangle \cap \langle \rho_m, \rho_l \rangle$ contains at least an element of order 3, a contradiction with the intersection property. Hence one of the two components of the fracture graph is a single vertex. Moreover, we may assume that the edge of label m in \mathcal{F} connects to one of a, b, c or e . In addition the m -edge does not form a double edge with one of the existing edges. Also, from the beginning of the proof, we know that ρ_m is either a transposition or a 2-transposition and in the latter case, ρ_m swaps c and d . It is then easily checked with MAGMA that the intersection property fails for any possible ρ_m for the group $\langle \rho_i, \rho_j, \rho_l, \rho_m \rangle$. \square

Lemma 5.4. \mathcal{G} is either a tree or has exactly one cycle that is an alternating square.

Proof. First observe that if \mathcal{G} is not a tree, it has exactly one cycle. By Lemma 5.2 (2), this cycle must be an alternating square. Also, if \mathcal{G} has a square then one vertex of the square is in one component of \mathcal{F} and the other 3 are in the other component of \mathcal{F} . As two edges of the square are in \mathcal{F} the square has no multiple edges, and it is unique. Now suppose that $\{a, b\}$ is a multiple edge of \mathcal{G} and let i and j be two labels of that edge. Then by Lemma 5.3 there are two edges with labels k and l such that the graph $\mathcal{G}_{\{i,j,k,l\}}$ is one of the following:

$$\textcircled{a} \xrightarrow{i} \textcircled{b} \xrightarrow{l} \textcircled{c} \xrightarrow{\frac{i}{j}} \textcircled{d} \xrightarrow{k} \textcircled{} \xrightarrow{j} \textcircled{} \quad \text{or} \quad \textcircled{c} \xrightarrow{\frac{i}{j}} \textcircled{d} \xrightarrow{l} \textcircled{} \xrightarrow{i} \textcircled{} \quad \begin{array}{l} \textcircled{} \\ \textcircled{} \\ \textcircled{} \end{array} \begin{array}{l} \textcircled{} \\ \textcircled{} \\ \textcircled{} \end{array}$$

In both cases $(ab) \in \langle \rho_i, \rho_j, \rho_k \rangle \cap \langle \rho_i, \rho_j, \rho_l \rangle$ but $(ab) \notin \langle \rho_i, \rho_j \rangle$, a contradiction. The rest follows from Lemma 5.2. \square

When \mathcal{G} is a tree, let 1 be the label of the edge between the two components of \mathcal{F} and 0 be the label of the unique edge between the two 1-edges. When \mathcal{G} is not a tree let $\{0, 1\}$ be the labels of the alternating square, the unique cycle of \mathcal{G} .

Lemma 5.5. If \mathcal{G} is a tree, then $\mathcal{G}_{\{0, \dots, r-1\} \setminus \{0\}}$ has two components, one of them having exactly two vertices.

Proof. Suppose that $k, l \geq 2$ are labels of two edges incident to the 1-edges, then $\mathcal{G}_{\{0,1,k,l\}}$ is one of the following graphs:

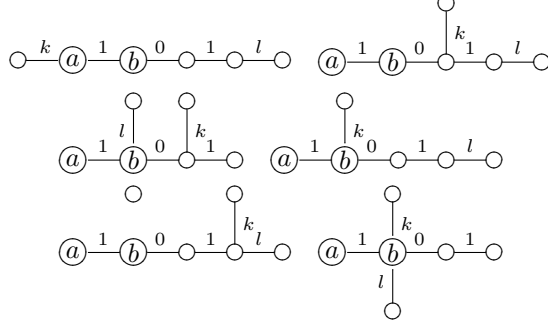

In any case $(ab) \in \langle \rho_0, \rho_1, \rho_k \rangle \cap \langle \rho_0, \rho_1, \rho_l \rangle$ but $(ab) \notin \langle \rho_0, \rho_1 \rangle$, a contradiction. \square

Lemma 5.6. *If \mathcal{G} has a square, then three vertices of the square have degree 2 in \mathcal{G} and the fourth vertex has degree 3.*

Proof. Suppose that there are two edges with labels k and l incident to the square, then we have the following possibilities for $\mathcal{G}_{i,j,k,l}$

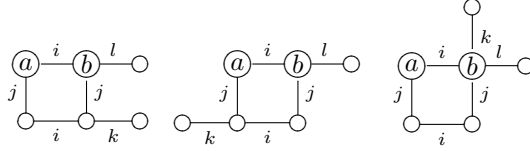

In any case $(ab) \in \langle \rho_i, \rho_j, \rho_k \rangle \cap \langle \rho_i, \rho_j, \rho_l \rangle$ but $(ab) \notin \langle \rho_i, \rho_j \rangle$, a contradiction. \square

Proposition 5.7. *If G_i is intransitive for all $i \in \{0, \dots, n-3\}$, then, up to a renumbering of the generators, the permutation representation graph \mathcal{G} of Γ is one of the following graphs where all the 0-edges and the 1-edges are pictured and $\mathcal{G}_{\{2, \dots, n-3\}}$ is a tree.*

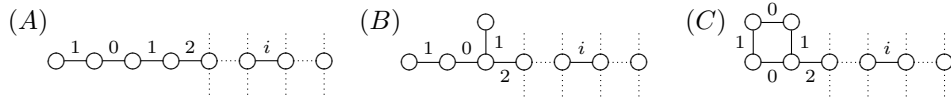

Proof. This is a consequence of Lemmas 5.4, 5.5 and 5.6. \square

6. PROOF OF THEOREM 1.2

Let $n \geq 9$, let $G = S_n$ and $\Gamma := (G, \{\rho_0, \dots, \rho_{n-3}\})$ be a C-group of rank $n-2$. We observe that for $n=8$ there is a C-group having one maximal parabolic subgroup that is transitive, generated by the following set of involutions.

$$\{(12), (12)(34), (12)(78), (12)(56), (13)(68), (18)(36)\}$$

This C-group also yields a hypertope. In this case the permutation representation graph is different from those given in Theorem 1.2.

Now suppose that $n \geq 9$. By Proposition 4.5, all G_i 's are intransitive. Thus by Proposition 5.7 the permutation representation graph of Γ is one of the three possibilities given in Theorem 1.2. It remains to prove that any group generated by involutions having one of these three graphs as permutation representation graph

gives a C-group of rank $n - 2$ and also a regular hypertope of rank $n - 2$ for the symmetric group S_n . By Proposition 2.4 we just need to prove that the groups satisfy the intersection property (and hence are C-groups) and that the corresponding coset geometries are flag-transitive.

We first focus on the intersection property. In order to prove it, we need a slightly different result than Proposition 2E16 of [22].

Proposition 6.1. *Let G be a group generated by r involutions g_0, \dots, g_{r-1} . Suppose that every maximal parabolic subgroup G_i is a C-group. Then G is a C-group if and only if $G_i \cap G_j = G_{i,j}$ for all $0 \leq i, j \leq r - 1$.*

Proof. Obviously, if $G_i \cap G_j \neq G_{i,j}$ for some i, j , then G is not a C-group. As pointed out in the proof of [22, Proposition 2E16], to prove the intersection property, it suffices to show that

$$G_K := \langle g_k | k \notin K \rangle = \bigcap \{G_j | j \in K\}$$

This follows immediately from the hypothesis that $G_i \cap G_j = G_{i,j}$ for all $0 \leq i, j \leq r - 1$. \square

Lemma 6.2. *The permutation representation graph (A) gives a rank $n - 2$ C-group isomorphic to S_n .*

Proof. By Proposition 6.1, and using induction on n , it is sufficient to prove that $G_i \cap G_j = G_{i,j}$ for every $i, j \in I$. Indeed, all G_i 's will either be C-groups of rank $n - 3$ for S_{n-1} or direct products of two smaller groups that are obviously C-groups.

$G_{0,1} = G_0 \cap G_1$: we have $G_{0,1} \cong S_{n-3}$, thus $G_{0,1}$ is a maximal subgroup of $G_1 \cong 2 \times S_{n-3}$;

$G_{0,2} = G_0 \cap G_2$: we have that $G_{0,2} \cong 2 \times S_{n-4}$, and $G_2 \cong D_8 \times S_{n-4}$. Suppose $G_0 \cap G_2 \neq G_{0,2}$. Then $G_0 \cap G_2$ must be a proper subgroup of G_0 and a proper subgroup of G_2 containing $G_{0,2}$. The involution ρ_1 corresponds to a fixed-point-free reflection of a square in D_8 . The only possibility is then to have another reflection or a central symmetry in $G_0 \cap G_2$. But then $G_0 \cap G_2$ is transitive on the four vertices of the square which is impossible as G_0 is not. Hence $G_0 \cap G_2 = G_{0,2}$

$G_{0,l} = G_0 \cap G_l$ for $l \geq 3$: we have that $G_{0,l} \cong 2 \times S_{n_1-2} \times S_{n_2}$ with $n_1 + n_2 = n$, thus $G_{0,l}$ is a maximal subgroup of $G_0 \cong 2 \times S_{n-2}$;

$G_{1,2} = G_1 \cap G_2$: we have $G_{1,2} \cong 2 \times S_{n-4}$, thus $G_{1,2}$ is a maximal subgroup of $G_1 \cong 2 \times S_{n-3}$;

$G_{1,l} = G_1 \cap G_l$ for $l \geq 3$: we have that $G_{1,l} \cong 2 \times S_{n_1-3} \times S_{n_2}$ with $n_1 + n_2 = n$, thus $G_{1,l}$ is a maximal subgroup of $G_1 \cong 2 \times S_{n-3}$;

$G_{2,l} = G_2 \cap G_l$ for $l \geq 3$: we have that $G_{2,l} \cong D_8 \times S_{n_1-4} \times S_{n_2}$ with $n_1 + n_2 = n$, thus $G_{2,l}$ is a maximal subgroup of $G_2 \cong D_8 \times S_{n-4}$;

$G_{l,k} = G_l \cap G_k$ for $l, k \geq 3$: we have that $G_{l,k} \cong S_{n_1} \times S_{n_2} \times S_{n_3} \times S_{n_4}$ with $n_1 + n_2 + n_3 + n_4 = n$, thus $G_{l,k}$ is a maximal subgroup of $G_l \cong S_{n_1} \times S_{n_2} \times S_{n_3+n_4}$. \square

Lemma 6.3. *The permutation representation graph (B) gives a rank $n - 2$ C-group isomorphic to S_n .*

Proof. By Proposition 6.1, and using induction on n as in the previous lemma, it is sufficient to prove that $G_i \cap G_j = G_{i,j}$ for every $i, j \in I$.

To prove the equalities $G_{0,2} = G_0 \cap G_2$, $G_{1,2} = G_1 \cap G_2$, $G_{0,l} = G_0 \cap G_l$ for $l \geq 3$, $G_{2,l} = G_2 \cap G_l$ for $l \geq 3$, and $G_{l,k} = G_l \cap G_k$ for $l, k \geq 3$, we can use the

same argument used in Lemma 6.2. Hence to prove that G is a C-group only the following two equalities are needed.

$G_{0,1} = G_0 \cap G_1$: we have $G_{0,1} \cong S_{n-3}$, thus $G_{0,1}$ is a maximal subgroup of $G_1 \cong S_{n-2}$;

$G_{1,l} = G_1 \cap G_l$ for $l \geq 3$: we have that $G_{1,l} \cong S_{n_1-2} \times S_{n_2}$ with $n_1 + n_2 = n$, thus $G_{1,l}$ is a maximal subgroup of $G_1 \cong S_{n-2}$;

□

Lemma 6.4. *The permutation representation graph (C) gives a rank $n-2$ C-group isomorphic to S_n .*

Proof. By Proposition 6.1, and using induction on n as in the previous lemmas, it is sufficient to prove that $G_i \cap G_j = G_{i,j}$ for every $i, j \in I$.

As $\mathcal{G}_{0,1}$ is a tree with $n-3$ vertices, the group $G_{0,1}$ is a C-group isomorphic to S_{n-3} . In addition we have the following equalities:

$G_{0,1} = G_0 \cap G_1$: we have $G_{0,1} \cong S_{n-3}$ and $G_0 \cong 2 \times S_{n-2}$. Obviously, $G_0 \cap G_1$ has three fixed points, hence the equality follows.

$G_{0,2} = G_0 \cap G_2$: we have $G_{0,2} \cong 2 \times S_{n-4}$, thus $G_{0,2}$ is a maximal subgroup of $G_2 \cong 2^2 \times S_{n-4}$;

$G_{0,l} = G_0 \cap G_l$ for $l \geq 3$: we have that $G_{0,l} \cong 2 \times S_{n_1-2} \times S_{n_2}$ with $n_1 + n_2 = n$, thus $G_{0,l}$ is a maximal subgroup of $G_0 \cong 2 \times S_{n-2}$;

$G_{1,2} = G_1 \cap G_2$: we have that $G_{1,2} \cong 2 \times S_{n-4}$, thus $G_{1,2}$ is a maximal subgroup of $G_2 \cong 2^2 \times S_{n-4}$;

$G_{1,l} = G_1 \cap G_l$ for $l \geq 3$: we have that $G_{1,l} \cong 2 \times S_{n_1-2} \times S_{n_2}$ with $n_1 + n_2 = n$, thus $G_{1,l}$ is a maximal subgroup of $G_1 \cong 2 \times S_{n-2}$;

$G_{2,l} = G_2 \cap G_l$ for $l \geq 3$: we have that $G_{2,l} \cong 2^2 \times S_{n_1-4} \times S_{n_2}$ with $n_1 + n_2 = n$, thus $G_{2,l}$ is a maximal subgroup of $G_2 \cong 2^2 \times S_{n-2}$;

$G_{l,k} = G_l \cap G_k$ for $l, k \geq 3$: we have that $G_{l,k} \cong S_{n_1} \times S_{n_2} \times S_{n_3} \times S_{n_4}$ with $n_1 + n_2 + n_3 + n_4 = n$, thus $G_{l,k}$ is a maximal subgroup of $G_l \cong S_{n_1} \times S_{n_2} \times S_{n_3+n_4}$.

Hence we have proved that $G_i \cap G_j = G_{i,j}$ for every $i, j \in I$ which is sufficient to show that G is a C-group.

□

The following corollary gives the Coxeter diagrams of the C-groups of Theorem 1.2 as well as presentations for these groups.

Corollary 6.5. *Let $n \geq 9$, let $G = S_n$ and $\Gamma := (G, \{\rho_0, \dots, \rho_{n-3}\})$ be a C-group of rank $n-2$ with one of the three possible permutation representations given in Theorem 1.2.*

- (1) *The Coxeter diagram of $\langle \rho_0, \rho_1, \rho_2, \rho_3 \rangle$ is one of the following, accordantly to its permutation representation graph.*

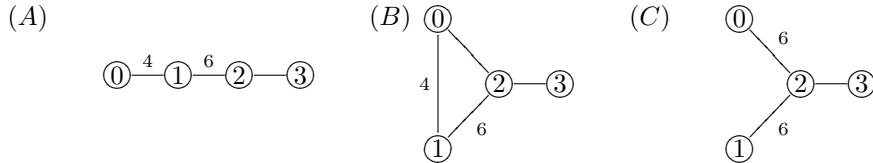

- (2) ρ_0, ρ_1 and ρ_2 commute with ρ_i for $i \geq 4$;
- (3) *The Coxeter diagram of $\langle \rho_3, \dots, \rho_{n-3} \rangle$ is the line graph of $\mathcal{G}_{3, \dots, n-3}$ that is an IMG graph;*

- (4) If $\{\rho_i\rho_j\rho_k\}$, for $i, j, k \geq 3$, is a triangle of the Coxeter diagram then $(\rho_i\rho_j\rho_i\rho_k)^2 = 1$;
- (5) The hypertopes with permutation representation (A), (B) and (C) satisfy the following relations, respectively.

$$(A) \quad [(\rho_1\rho_2)^3\rho_0]^3 = [\rho_3(\rho_1\rho_2)^3]^2 = (\rho_0\rho_1\rho_2\rho_1)^3 = 1$$

$$(B) \quad [\rho_0(\rho_1\rho_2)^3]^3 = (\rho_1\rho_0\rho_1\rho_2)^2 = [(\rho_1\rho_2)^3\rho_3]^2 = 1$$

$$(C) \quad [(\rho_0\rho_2)^3(\rho_1\rho_2)^3\rho_1]^3 = [(\rho_0\rho_2)^3(\rho_1\rho_2)^3]^3 = [(\rho_1\rho_2)^3\rho_3]^2 = [(\rho_0\rho_2)^3\rho_3]^2 = 1$$

Moreover the relations given by the Coxeter diagram (characterized by (1), (2) and (3)), plus the relations given in (4) and (5) are sufficient to define G .

Proof. If Γ is a C-group of rank $n - 2$ for S_n with $n \geq 9$ then by Theorem 1.2 and Proposition 3.1 all items of this Corollary can be easily verified. In what follows we prove that these relations are sufficient to characterise the groups of these C-groups.

We proceed by induction over the number of nonlabelled triangles of the Coxeter diagram. Starting from a C-group of rank $n - 2$ for S_n having $t \geq 1$ nonlabelled triangles on its Coxeter diagram we can reduce the number of triangles using the construction given in Proposition 3.1. Note that in any of the three permutation representations (A), (B) and (C) it is possible to apply the construction used in Proposition 3.1. Indeed, if $t > 0$, in any of the three cases there are two vertices of degree one and a path between them not containing the first four generators. Thus only the cases without nonlabelled triangles ($t = 0$) need to be analysed. In what follows let $\alpha_0, \dots, \alpha_{n-2}$ be the generators of the string C-group $[3^{n-2}]$ (the finite irreducible Coxeter group of type A_{n-2}).

Let us first consider the C-group with permutation representation (A) and $t = 0$, that is, the string C-group of rank $n - 2$ for the symmetric group of type $\{4, 6, 3^{n-5}\}$. We can derive a presentation of the group of this C-group from the finite Coxeter group $[3^{n-1}]$ with generating set $\{\alpha_i \mid i = 0, \dots, n - 2\}$ as defined in [12]. Let

$$\rho_0 = \alpha_1, \rho_1 = \alpha_0\alpha_2 \text{ and } \rho_i = \alpha_{i+1} \text{ for } i \in \{2, \dots, n - 3\}.$$

where $\alpha_0, \dots, \alpha_{n-2}$ are the standard generators of $[3^n]$. We have,

$$\alpha_0 = (\rho_1\rho_2)^3 \text{ and } \alpha_2 = (\rho_1\rho_2)^3\rho_1.$$

Now from the relations of the Coxeter group $[3^n]$ we derive, apart from the relations giving the type, two other relations: $((\rho_1\rho_2)^3\rho_0)^3 = 1$, $((\rho_1\rho_2)^3\rho_3)^2 = 1$ and $(\rho_0\rho_1\rho_2\rho_1)^3 = 1$. This proves that the relations given in this corollary are sufficient to give a presentation of the group of this C-group.

Now consider the C-group with permutation representation (B) and $t = 0$. In this case let,

$$\rho_0 = \alpha_2, \rho_1 = (\alpha_0, \alpha_2\alpha_1)^2, \rho_i = \alpha_{i+1} \text{ for } i \in \{2, \dots, n - 3\}.$$

We have,

$$\alpha_0 = \rho_1\rho_0\rho_1 \text{ and } \alpha_1 = (\rho_1\rho_2)^3.$$

Now from the relations of the Coxeter group $[3^n]$ we derive, apart from the relations giving the type, only two extra relations: $[\rho_0(\rho_1\rho_2)^3]^3 = (\rho_1\rho_0\rho_1\rho_2)^2 = [(\rho_1\rho_2)^3\rho_3]^2 = 1$. This proves that the relations given in this corollary are sufficient to give a presentation of the group of this C-group.

For the C-group with permutation representation (C) and $t = 0$ we again derive a presentation from the group of the C-group without triangles in its Coxeter diagram from $[3^n]$ changing the generating set as follows:

$$\rho_0 = (\alpha_0\alpha_2\alpha_1)^2, \rho_1 = \alpha_0\alpha_2 \text{ and } \rho_i = \alpha_{i+1} \text{ for } i \in \{2, \dots, n-3\}$$

On the other hand we have,

$$\alpha_0 = (\rho_1\rho_2)^3, \alpha_1 = (\rho_0\rho_2)^3 \text{ and } \alpha_2 = (\rho_1\rho_2)^3\rho_1.$$

Now from the relations of the Coxeter group $[3^n]$ we derive, apart from the relations giving the type, the two relations given in this corollary. \square

Observe that (1), (2) and (3) of Corollary 6.5 permit to say that the number of C-groups of rank $n-2$ up to isomorphism and duality is divisible by 3. For S_n with $n \geq 9$, it corresponds to three times the number of leaves in the permutation representation graphs of the inductively minimal geometries of S_{n-3} .

It now remains to prove that the coset geometries obtained from the permutation representation graphs (A), (B) and (C) are all flag-transitive in order to show that these C-groups are all giving regular hypertopes.

Theorem 6.6. *The coset geometries obtained from the permutation representation graphs (A), (B) and (C) are flag-transitive.*

Proof. Let $\Gamma := \Gamma(G; (G_i)_{i \in \{0, \dots, r-3\}})$ be a coset geometry of rank $n-2$ obtained from one of the permutation representation graphs. Recall that for each such geometry, the maximal parabolic subgroups G_i are intransitive subgroups on n points. Choose one leaf on the right hand side of the permutation representation graph of the C-groups we obtained, and suppose its edge-label is $n-3$. Then G_{n-3} is isomorphic to S_{n-1} by induction and $\Gamma(G_{n-3}, \{G_0 \cap G_{n-3}, \dots, G_{n-4} \cap G_{n-3}\})$ is a flag-transitive geometry. Using Theorem 2.6, we just need to check that $\Gamma_{(ij)}(S_n, \{G_i, G_j, G_{n-3}\})$ is flag-transitive for all $0 < i, j < n-4$ in order to prove that Γ is flag-transitive. Observe that by Lemmas 6.2, 6.3 and 6.4, we have $G_i \cap G_j = G_{i,j}$. Let p be the point fixed by G_{n-3} . We have that $G_{n-3}(G_i \cap G_j) = G_{n-3}G_{i,j}$ and since $G_{n-3} \cong S_{n-1}$, this is the set of all the elements of S_n that map p to any point of the orbits $p^{G_{i,j}}$. Now, assume by way of contradiction that $H := G_{n-3}G_i \cap G_{n-3}G_j > G_{n-3}(G_i \cap G_j)$. Then there exists $\alpha \in H$ such that $p\alpha =: q \notin p^{G_{i,j}}$. This point must then be either in $p^{G_i} \setminus p^{G_j}$ or in $p^{G_j} \setminus p^{G_i}$. Suppose without loss of generality that $q \in p^{G_i} \setminus p^{G_j}$. As $\alpha \in H$, $\alpha = \gamma_{n-3}\gamma_i = \nu_{n-3}\nu_j$ for some $\gamma_{n-3}, \nu_{n-3} \in G_{n-3}$, $\gamma_i \in G_i$ and $\nu_j \in G_j$. But since $p\alpha = p(\nu_{n-3}\nu_j) = p\nu_j$ we cannot have $p\alpha = q$, a contradiction. Hence $\Gamma_{(ij)}(S_n, \{G_i, G_j, G_{n-3}\})$ is flag-transitive for all $0 \leq i, j \leq n-4$ and by Theorem 2.6, Γ is flag-transitive. \square

7. ACKNOWLEDGEMENTS

This research was supported by a Marsden grant (UOA1218) of the Royal Society of New Zealand and by the Portuguese funds through the CIDMA - Center for Research and Development in Mathematics and Applications, and the Portuguese Foundation for Science and Technology (FCT- Fundação para a Ciência e a Tecnologia), through CIDMA - Center for Research and Development in Mathematics and Applications, within project UID/MAT/04106/2013. The authors also thank an anonymous referee for useful comments on a preliminary version of this paper.

REFERENCES

- [1] Wieb Bosma, John J. Cannon, and Catherine Ployoust. The Magma Algebra System. I. The User Language. *J. Symbolic Comput.*, 24(3-4):235–265, 1997. Computational Algebra and Number Theory (London, 1993).
- [2] Francis Buekenhout, Philippe Cara, and Michel Dehon. Inductively minimal flag-transitive geometries. In Johnson N.L., editor, *Mostly Finite Geometries*, pages 185–190, 1997.
- [3] Francis Buekenhout and Arjeh M. Cohen. *Diagram Geometry. Related to classical groups and buildings*. Ergebnisse der Mathematik und ihrer Grenzgebiete. 3. Folge. A Series of Modern Surveys in Mathematics [Results in Mathematics and Related Areas. 3rd Series. A Series of Modern Surveys in Mathematics], 57. Springer, Heidelberg, 2013. xiv+592 pp.
- [4] Francis Buekenhout and Michel Hermand. *On flag-transitive geometries and groups*. Travaux de Mathématiques de l’Université Libre de Bruxelles, 1:45–78, 1991.
- [5] Francis Buekenhout and Dimitri Leemans. *On the list of finite primitive permutation groups of degree ≤ 50* . *J. Symbolic Comput.* 22:215–225, 1996.
- [6] Peter J. Cameron and Philippe Cara. *Independent generating sets and geometries for symmetric groups*. *J. Algebra*, 258(2):641–650, 2002.
- [7] Peter J. Cameron, Maria Elisa Fernandes, Dimitri Leemans and Mark Mixer. *String C-groups as transitive subgroups of S_n* . *J. Algebra*, 447:468–478, 2016
- [8] Peter J. Cameron, Jaap J. Seidel and Sergei V. Tsaranov. *Signed graphs, root lattices, and Coxeter groups*. *J. Algebra*, 164(1):173–209, 1994.
- [9] Philippe Cara, Serge Lehman and Dmitrii V. Pasechnik. *On the number of inductively minimal geometries*. *Theoretical Computer Science* 263: 31–35, 2001.
- [10] Thomas Connor, Sebastian Jambor, and Dimitri Leemans. *C-groups of $PSL(2, q)$ and $PGL(2, q)$* . *J. Algebra*, 427:455–466, 2015.
- [11] John H. Conway, Robert T. Curtis, Simon P. Norton, Richard A. Parker, and Robert A. Wilson. *Atlas of Finite Groups*. Oxford U.P., 1985.
- [12] H. S. M. Coxeter (1935), *The complete enumeration of finite groups of the form $r_i^2 = (r_i r_j)^{k_{ij}} = 1, r_i^2 = (r_i r_j)^{k_{ij}} = 1$* . *J. London Math. Soc.*, 1, 10 (1): 21–25, 1935.
- [13] H. S. M. Coxeter, *Groups generated by unitary reflections of period two*. *Canad. J. Math.*, 9, 243–272, 1957.
- [14] Michel Dehon. *Classifying geometries with CAYLEY*. *J. Symbolic Comput.*, 17(3):259–276, 1994.
- [15] Maria Elisa Fernandes and Dimitri Leemans. *Polytopes of high rank for the symmetric groups*. *Adv. Math.*, 228:3207–3222, 2011.
- [16] Maria Elisa Fernandes, Dimitri Leemans and Mark Mixer. *Corrigendum to “Polytopes of high rank for the symmetric groups”*. *Adv. Math.*, 238:506–508, 2013.
- [17] Maria Elisa Fernandes, Dimitri Leemans and Mark Mixer. *An extension of the classification of high rank regular polytopes*. *Trans. Amer. Math. Soc.*, to appear.
- [18] Maria Elisa Fernandes, Dimitri Leemans and Asia Ivić Weiss. *Highly symmetric hypertopes*. *Aeq. Math.*, 90:1045–1067, 2016.
- [19] Dimitri Leemans. *Contribution à l’élaboration d’un atlas de géométries*. Master’s thesis, Université Libre de Bruxelles, 1994.
- [20] Attila Maróti. *On the orders of primitive groups*. *J. Algebra*, Vol. 258 (2):631–640, 2002.
- [21] Eliakim H. Moore. Concerning the abstract groups of order $k!$ and $\frac{1}{2}k!$. *Proc. London Math. Soc.*, 28:357–366, 1896.
- [22] Peter McMullen and Egon Schulte. *Abstract Regular Polytopes*, volume 92 of *Encyclopedia of Mathematics and its Applications*. Cambridge University Press, Cambridge, 2002.
- [23] Julius Whiston. Maximal independent generating sets of the symmetric group. *J. Algebra*, 232(1):255–268, 2000.
- [24] Jacques Tits. *Sur les analogues algébriques des groupes semi-simples complexes*. Colloque d’algèbre supérieure, tenu à Bruxelles du 19 au 22 décembre 1956, Centre Belge de Recherches Mathématiques, 261–289, Établissements Ceuterick, Louvain; Librairie Gauthier-Villars, Paris, 1957.

MARIA ELISA FERNANDES, CENTER FOR RESEARCH AND DEVELOPMENT IN MATHEMATICS AND APPLICATIONS, DEPARTMENT OF MATHEMATICS, UNIVERSITY OF AVEIRO, PORTUGAL

E-mail address: `maria.elisa@ua.pt`

DIMITRI LEEMANS, DEPARTMENT OF MATHEMATICS, UNIVERSITY OF AUCKLAND, PRIVATE BAG 92019, AUCKLAND 1142, NEW ZEALAND AND UNIVERSITÉ LIBRE DE BRUXELLES, DÉPARTEMENT DE MATHÉMATIQUE, C.P.216 - ALGÈBRE ET COMBINATOIRE, BOULEVARD DU TRIOMPHE, 1050 BRUSSELS, BELGIUM

E-mail address: `dleemans@ulb.ac.be`