

# An Artificial Arm Pressure Able to Reproduce Oscillometric Blood Pressure for Testing Holter Devices

Claudio De Lazzari<sup>1,2,\*</sup>, Iginio Genuini<sup>2,3</sup>, Bernhard Quatember<sup>4</sup> and Francesco Fedele<sup>2,3</sup>

<sup>1</sup>*CNR, Institute of Clinical Physiology, UOS of Rome, Italy*

<sup>2</sup>*National Institute of Cardiovascular Research, Bologna, Italy*

<sup>3</sup>*Department of Cardiovascular, Respiratory, Nephrological, Anesthesiological and Geriatric Sciences, "Sapienza" University of Rome Italy*

<sup>4</sup>*Medizinische Universitaet Innsbruck, Austria*

**Abstract:** The aim of this work is the realization of an "Artificial Arm Pressure" permitting to reproduce oscillometric waveforms able to replace expensive clinical trials for validating and testing a Holter blood pressure device. To perform this new device a hybrid simulator (numerical/hydraulic) of the left cardiocirculatory network was implemented in order to reproduce in different fixed times different oscillometric blood arterial pressure waveforms. The "Artificial Arm Pressure" consists of a numerical simulator of the left cardiovascular system, in which it is possible to fix the left atrial pressure (preload) and the left arterial pressure (afterload) and of an hydraulic system consisting of a D/A converter, a servo-amplifier, a D/C motor and a "gear pump". The numerical simulator allows to vary the heart rate, the time duration of systole/diastole and the morphology of the ventricular/aortic pressure waveform in order to reproduce different physiopathology cardiovascular diseases. The hybrid simulator can be used to program the type and amount of steps you want to perform in 24/48-h to check the correct operation/calibration of the Holter blood pressure device. A Holter programmed to acquire data every 15 min has been tested for 24-h on the "Artificial Arm Pressure". The comparison between simulated and measured data shown that for systolic (diastolic) blood pressure the percentage of variation was in average about  $\pm 2.6\%$  ( $\pm 2.9\%$ ). In the case of HR, the percentage of variation was in average about  $\pm 2.0\%$ .

**Keywords:** Numerical model, Cardiovascular system, Holter blood pressure, Left ventricle, Hybrid model.

## 1. INTRODUCTION

Holter blood pressure is the process in which blood pressure is measured at regular intervals over 24 hours.

The Holter blood pressure measurement technique is an excellent method:

- to assess the variations in pressure during an entire day and night cycle,
- to monitor the effects of antihypertensive therapy,
- to detect sudden periods of hypotension, and
- to make necessary alterations in the administration of antihypertensive drugs without delay. In Italy in many ASL "Azienda Sanitaria Locale/Local Health Structure", hospitals and clinics where it is being applied, specific checks which would ascertain the correct calibration and operation of the Holter blood pressure device

when handed out to a patient are not yet foreseen. Usually, a Holter which is returned from a patient is subsequently applied to another patient. Since important diagnostic findings and therapeutic measures are derived from the stored Holter data, it is essential to regularly test and calibrate

Holter blood pressure devices to ensure valid measurement data [1]. To fulfil these requirements, we have developed a so called "Arm Artificial Pressure" (AAP) equipment which allows us to attach and check the Holter device for 24 or 48 hours, respectively. During this period of time, the Holter is newly calibrated and tested for proper functioning. The AAP is based on a hybrid numerical/hydraulic approach. We use a relatively simple lumped parameter (numerical) simulation model of the heart and the arterial part of the systemic circulation (we will call it "left cardiovascular network") together with an electro-hydraulic system which comprises a D/A converter, a servo-amplifier, a DC motor and a "gear pump".

For the implementation of the aforementioned lumped parameter simulation model of the "left cardiovascular network", we have adopted the software

\*Address correspondence to this author at the C.N.R., Institute of Clinical Physiology, U.O.S. of Rome, Italy Via S.M. della Battaglia, 44 00185 Rome, Italy; E-mail: [claudio.delazzari@ifc.cnr.it](mailto:claudio.delazzari@ifc.cnr.it)

concept of the CARDIOSIM<sup>®</sup> simulator [2]. Our simulation model comprises:

- a component for the left atrium which allows us to arbitrarily determine the pressure (preload),
- a component for the left ventricle, and
- a component which represents a simple configuration of the systemic arterial tree and allows us to specify the afterload [2-4].

The numerical simulator allows us to (arbitrarily) specify and vary the heart rate, the time duration of systole and diastole, and, moreover, to generate those ventricular/aortic pressure patterns which are characteristic for the pathophysiological characteristics of all the cardiovascular diseases that we must take into consideration. The pulsatile (wavelike) flow pattern which is calculated by using our simulation model is available as a digital signal at an USB port of the computer. It is taken as the input of a D/A converter. As will be described in detail later, the D/A converter is connected with a servo amplifier which controls a DC motor-driven "gear pump". In turn, this pump generates the calculated wavelike flow pattern within the artificial artery of the AAP. The flow pattern within the artificial artery determines the pressure pattern. Since we are able to consider in our calculations of the flow and pressure patterns the specific characteristics of the patient's disease, it is warranted that the calibrations procedures and checks of the Holter blood pressure device which will be carried out are fully adapted to the patient's requirements.

## 2. MATERIALS AND METHODS

The Arm Artificial Pressure device is based on hybrid (numerical/hydraulic) simulator developed at the "Telecardiology & Clinical Applications of Numerical Modeling of Biological Systems" research unit of the National Institute of Cardiovascular Research (INRC). The software portion of the AAP hybrid system, derives from the cardiovascular numerical simulator CARDIOSIM<sup>®</sup> [2, 3, 5]. This numerical part reproduces the left circulatory cardiovascular network by a ventricle and a simple systemic arterial section (Figure 1). The numerical network is represented by a first-order lumped-parameter model and it is implemented by Euler's method. The ventricular behavior is reproduced by a variable elastance model according to Sagawa's studies [3-5]. The systemic arterial section is simulated by a modified windkessel ( $R_{cs}$ ,  $L_s$  and  $C_{as}$ ) with a

variable peripheral resistance [6, 7]. The entire system is able to reproduce the Starling's law of the heart.

Figure 2 shows the connection between the numerical model and the hydraulic system. The simulated systemic arterial flow ( $Q_{as}$ ) is transmitted by USB port to a DC motor and a servo-amplifier that drives the gear pump and controls the flow adequately (*i.e.* the speed pump). Gear pump guaranteeing a linear relationship between the rotational speed and the flow can be used as flow generator [9, 10]. We used a gear pump that, at the maximum speed of 1750 rpm, yields a flow of about 35 [ $l \cdot min^{-1}$ ] [8]. The DC motor used in order to realize the AAP is produced by Maxon. It is equipped with a tachometer (Hubner model GT5.05L410). The servo-amplifier (Model B25A20FACQ; Advanced Motion Controls, Camarillo, CA) is used in the AAP system. The electromagnetic flow probe (Model 300A; Carolina Medical, King, NC) measures the flow rate at the outlet of the pump. A silicon vessel incorporating the liquid was fixed to the artificial arms made using PVC. The silicon artery was connected to gear pump and to a reservoir.

During one of the first tests performed on the AAP, every 13 min the numerical simulator sent (for a period of 4 min) one different  $Q_{as}$  waveform to a DC motor and a servo-amplifier. The different  $Q_{as}$  waveforms were obtained changing in the numerical circulatory network the preload, the ventricular elastance ( $E_{lv}$ ), the heart rate (HR), the left ventricular systole/diastole (S/D) ratio, the value of the systemic peripheral resistance ( $R_{as}$ ) and finally the value of systemic arterial compliance ( $C_{as}$ ). The variations of the described parameters were performed using protocol implemented in a software way in which through different combinations:

- preload ( $P_{la}$ ) changed from 5 to 20 [mmHg] [11].
- ventricular elastance ( $E_{lv}$ ) changed from 0.8 to 3.5 [ $mmHg/cm^3$ ] [7].
- HR changed from 50 to 240 [beats/min] [11, 12].
- S/D ratio changed from 0.3 to 1.7 duration, in particular systolic period duration decreased with increasing HR (according linear law) and diastolic duration decreased in an exponential fashion as HR increased [13, 14]
- systemic peripheral resistance changed from 600 to 2500 [ $g \cdot cm^{-4} \cdot sec^{-1}$ ] [7, 15].

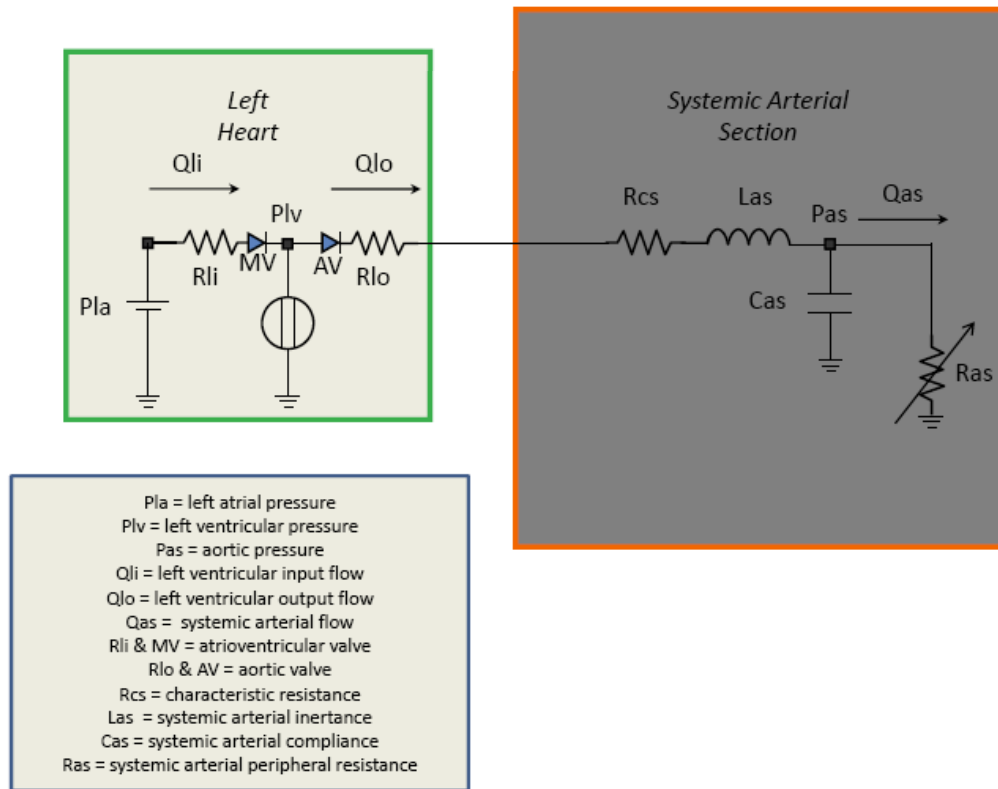

**Figure 1:** Electrical analog of the left circulatory network implemented in the cardiovascular simulator CARDIOSIM<sup>®</sup>. This network consists of a fixed left atrial pressure (Pla), of the left ventricle and of a modified windkessel with a variable peripheral resistance. Qas represents the arterial blood flow that must be reproduced by the hydraulic system into the silicon vessel present on the artificial arm.

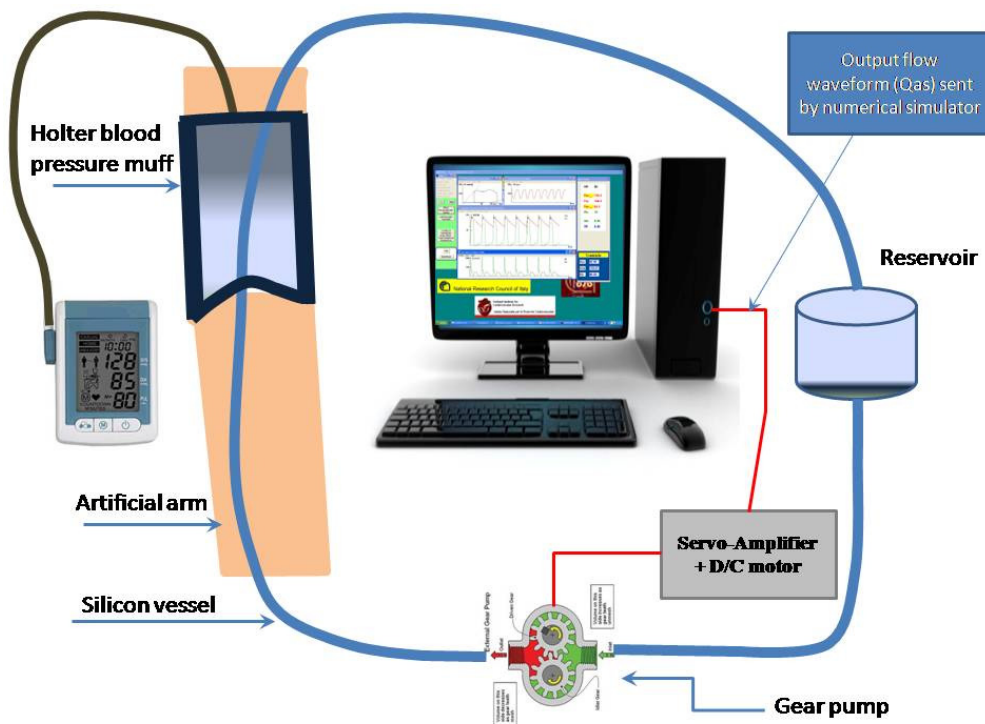

**Figure 2:** Representation of AAP hybrid system composed by numerical simulator and hydraulic system. The flow waveform (Qas) generated by numerical simulator is reproduced into the silicon artery by a DC motor and a servo-amplifier that drives the gear pump and controls the flow. Gear pump guaranteeing a linear relationship between the rotational speed and the flow can be used as flow generator.

- systemic arterial compliance changed from 0.8 to 3.5 [cm<sup>3</sup>/mmHg] [7, 15, 16].

The values measured and stored (every 15 min, for 24-h) on the Holter (FDA CE CONTEC Medical Systems ABPM50), installed on the AAP, are: the HR, the systolic, diastolic and mean pressures.

### 3. RESULTS

Figure 3 shows the simulated arterial blood flow waveforms sent to hydraulic section of the AAP during

the test performed as described in the previous section. In the graph we present four different types of waveforms performed setting the HR to 60, 80, 100 and 200 [beats/min] in the numerical simulator. The table reports the HR, systolic, diastolic, and mean pressures stored in the Holter. In the last case the HR measured is different respect to HR set in the numerical section. The results presented in Figure 3 have been obtained setting in the numerical section of the AAP:  $P_{la}=12$  [mmHg],  $R_{as}=1200$  [g·cm<sup>-4</sup>·sec<sup>-1</sup>],  $C_{as}=1.8$  [cm<sup>3</sup>/mmHg],  $S/D=0.76$  and  $Elv=3.3$  [mmHg/cm<sup>3</sup>]. In

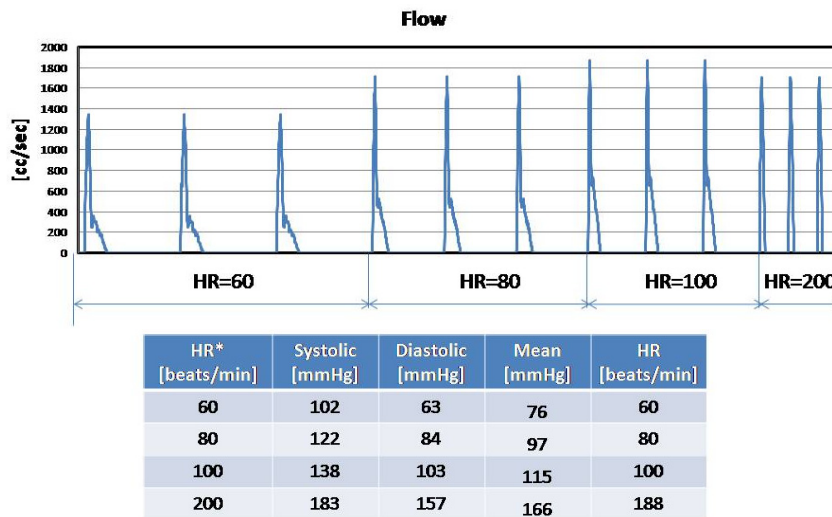

**Figure 3:** The simulated arterial blood flow waveforms sent to hydraulic section of the AAP are plotted in the graphics window. The figure presents four different types of waveforms performed setting in the numerical simulator the HR to 60, 80, 100 and 200 [beats/min] respectively. For each HR value three waveforms are plotted. The table reports the HR values (first column) set into the numerical simulator and the HR (last column), systolic, diastolic, and mean pressures values measured and stored in the Holter blood pressure.

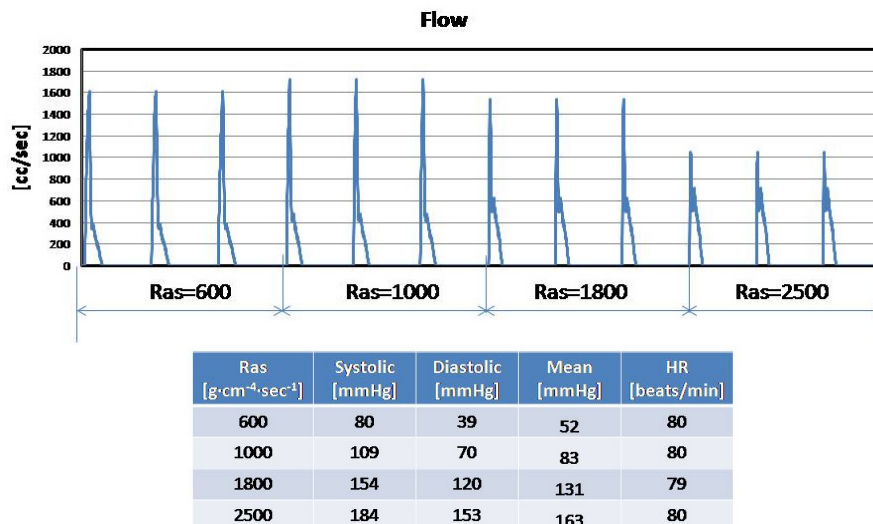

**Figure 4:** The simulated arterial blood flow waveforms sent to hydraulic section of the AAP are plotted in the graphics window. The figure presents four different type of waveforms performed setting in the numerical simulator the peripheral resistance (Ras) to 600, 1000, 1800 and 2500 [g·cm<sup>-4</sup>·sec<sup>-1</sup>] respectively. For each Ras value are plotted three waveforms. In the table are reported the systolic, diastolic, and mean pressures together with HR values measured and stored in the Holter blood pressure device. In all conditions the HR, in the numerical simulator, was set to 80 [beats/min].

these conditions the simulated mean blood flow (calculated during a cardiac cycle) was  $Q_{as}=5.5$  [l/min] (HR=60),  $Q_{as}=6.9$  [l/min] (HR=80),  $Q_{as}=8.1$  [l/min] (HR=100) and  $Q_{as}=11.0$  [l/min] (HR=200).

Figure 4 reports the simulated arterial blood flow waveforms sent to hydraulic section of the AAP when the peripheral resistance was set to 600, 1000, 1800 and 2500 [g·cm<sup>-4</sup>·sec<sup>-1</sup>]. In this way it was possible to induce a changing in the afterload of the left circulatory network. In the table we report the HR, systolic, diastolic, and mean pressures stored in the Holter. The results presented in figure have been obtained with the following setting in the numerical section of the AAP:  $P_{la}=12$  [mmHg], HR=80 [beats/min],  $C_{as}=1.8$  [cm<sup>3</sup>/mmHg], S/D=0.76 and  $E_{lv}=3.3$  [mmHg/cm<sup>3</sup>]. In these conditions the simulated mean blood flow (calculated during a cardiac cycle) was  $Q_{as}=8.0$  [l/min] (Ras=600),  $Q_{as}=7.2$  [l/min] (Ras=1000),  $Q_{as}=6.1$  [l/min] (Ras=1800) and  $Q_{as}=5.4$  [l/min] (Ras=2500). Also in this case for one value of HR imposed in the numerical simulator, has been measured a different HR value.

Figure 5 shows the simulated arterial blood flow waveforms sent to hydraulic section of the AAP when left ventricular elastance changes from 0.8 to 3.5 [mmHg/cm<sup>3</sup>]. The results presented in figure have been performed setting in the numerical section of the AAP in the following way:  $P_{la}=12$  [mmHg], HR=80

[beats/min],  $C_{as}=2.0$  [cm<sup>3</sup>/mmHg], S/D=0.76 and  $R_{as}=1000$  [g·cm<sup>-4</sup>·sec<sup>-1</sup>]. In these conditions the simulated mean blood flow was  $Q_{as}=4.0$  [l/min] ( $E_{lv}=0.8$ ),  $Q_{as}=5.8$  [l/min] ( $E_{lv}=1.5$ ),  $Q_{as}=7.2$  [l/min] ( $E_{lv}=2.5$ ) and  $Q_{as}=8.1$  [l/min] ( $E_{lv}=3.5$ ).

The results presented in Figure 6 are obtained changing the preload into the circulatory network. In the graphics window are plotted the blood flow waveforms sent to hydraulic section of the AAP. In the numerical simulator the preload ( $P_{la}$ ) was set to 5, 10, 15 and 20 [mmHg]. In this case all experiments are performed setting HR=90 [beats/min],  $C_{as}=2.5$  [cm<sup>3</sup>/mmHg], S/D=0.5 and  $R_{as}=2500$  [g·cm<sup>-4</sup>·sec<sup>-1</sup>]. In these conditions the simulated mean blood flow was  $Q_{as}=5.5$  [l/min] ( $P_{la}=5$ ),  $Q_{as}=6.2$  [l/min] ( $P_{la}=10$ ),  $Q_{as}=6.5$  [l/min] ( $P_{la}=15$ ) and  $Q_{as}=6.7$  [l/min] ( $P_{la}=20$ ). Figure 7 shows a graphical output of the numerical section of the hybrid system obtained setting the parameters as described in Figure 6. In Figure 7 the upper graphical window shows two left ventricular cardiac cycles performed setting  $P_{la}=15$  mmHg and  $P_{la}=5$  mmHg. In the lower left (right) graphical window are plotted the left ventricular volume waveforms (the left ventricular pressure ( $P_{lv}$ ) and the systemic arterial pressure ( $P_{as}$ )). The values of the end systolic (diastolic) volume  $V_{es}$  ( $V_{ed}$ ) and of the stroke volume (SV) are obtained when  $P_{la}=5$  [mmHg].

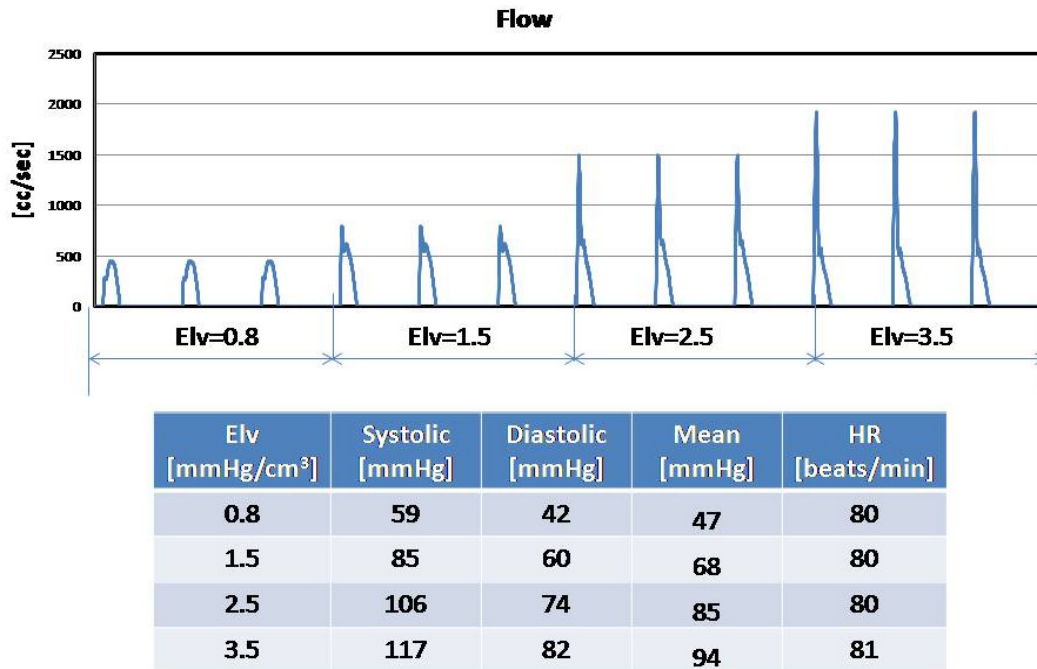

**Figure 5:** The simulated arterial blood flow waveforms sent to hydraulic section of the AAP are plotted in the graphics window. In the numerical simulator the left ventricular elastance ( $E_{lv}$ ) was set to 0.8, 1.5, 2.5 and 3.5 [mmHg·cm<sup>-3</sup>] respectively. In all conditions the HR, in the numerical simulator, was set to 80 [beats/min].

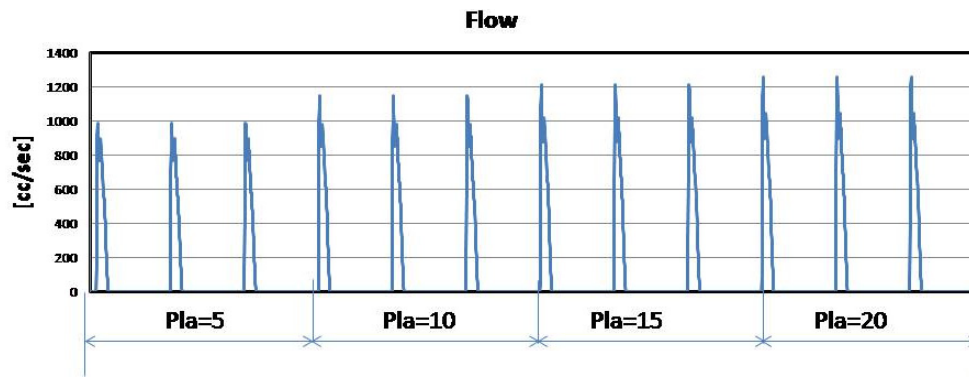

Pla [mmHg]	Systolic [mmHg]	Diastolic [mmHg]	Mean [mmHg]	HR [beats/min]
5	113	93	100	90
10	127	104	112	90
15	134	109	118	90
20	138	113	122	90

Figure 6: The simulated arterial blood flow waveforms sent to hydraulic section when the preload changed from 5 to 20 [mmHg]. In all conditions the HR, was set to 90 [beats/min] in the numerical simulator.

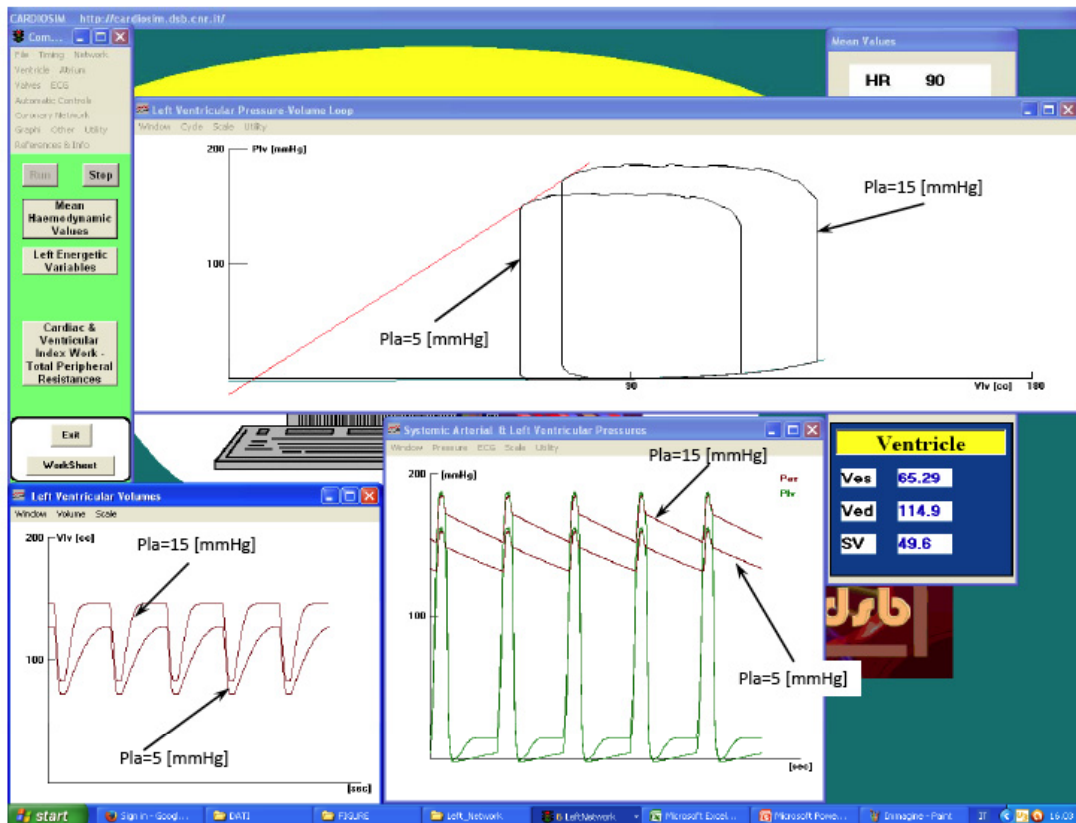
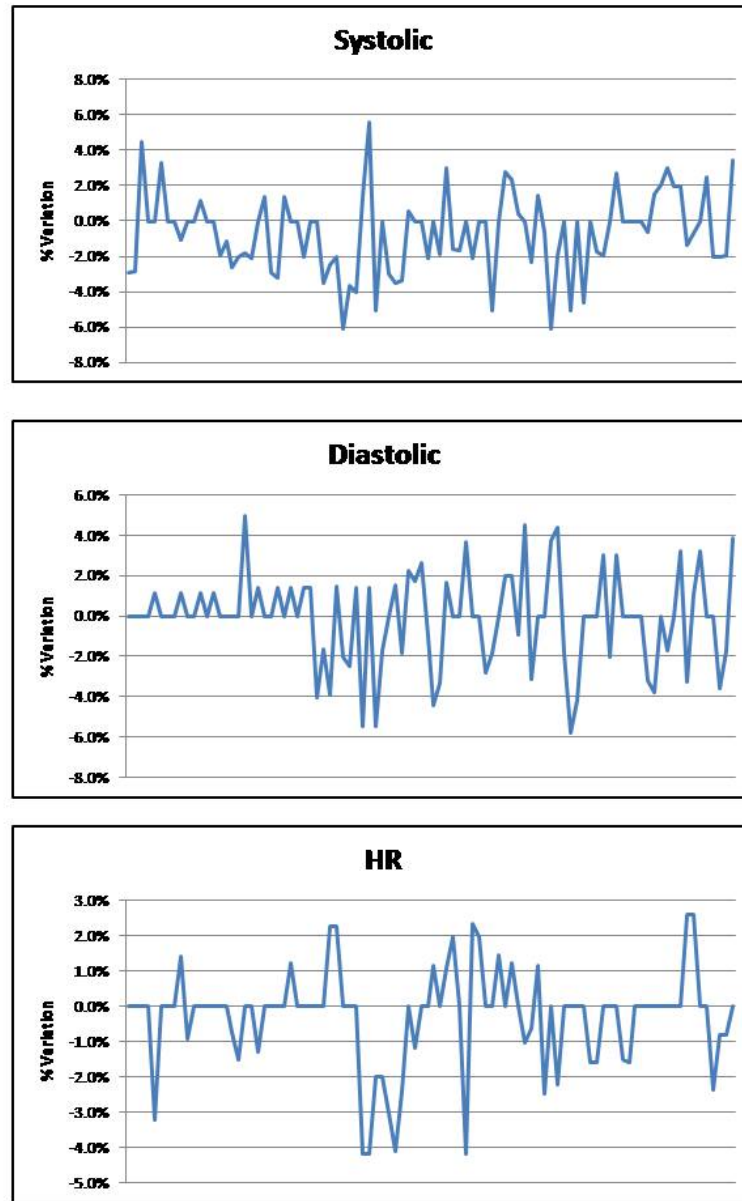

Figure 7: One of the different graphical output performed by the modular package software CARDIOSIM®. The waveforms are obtained setting the preload to 5 and to 15 [mmHg]. Starting from Pla=15 [mmHg] and setting Pla to 5 [mmHg], it is possible to observe that the left ventricular cardiac loop shifts in the left side, reducing both ventricular end systolic and end diastolic volume according to the Starling's law.



**Figure 8:** Percentage of variation in systolic/diastolic pressure and in HR calculated between simulated and measured data. The registrations on Holter blood pressure were performed every 15 min. The percentages of variation presented in all windows were performed using 96 (simulated) data. All measurements were performed changing the parameters as described in material and methods section.

Figure 8 reports the percentage of variation calculated on data measured and simulated during an experiment in which a Holter blood pressure was tested in 24-h. In the upper window the percentage of variation between simulated and stored systolic pressure changes between a maximum and a minimum of around  $\pm 6.0\%$  with fluctuations in average of around  $\pm 2.6\%$ . In the middle window the percentage of variation in diastolic pressure changes between a maximum and a minimum of around  $\pm 5.0\%$  with fluctuations in average of around  $\pm 2.9\%$ . Finally, in the lower window the percentage of variation in HR changes between a maximum of around  $2.5\%$  and a minimum of around -

$4.0\%$  with fluctuations in average of about  $\pm 2.0\%$ .

The discrepancies observed between simulated and measured data depend in part by the characteristics of the Holter blood pressure device, as described in the instruction manual, and in part by the transmission line of the AAP hydraulic circuit.

#### 4. CONCLUSIONS

An "Artificial Arm Pressure" hybrid system was realized in order to test a Holter blood pressure device during 24/48-h. The hybrid system consists of a numerical simulator that can reproduce different

circulatory conditions and hydraulic system on which is installed the Holter device. The whole system is able to reproduce the Starling's law of the heart.

A Holter programmed to acquire data every 15 min has been tested for 24-h on AAP. The comparison between simulated and measured data showed that, for systolic (diastolic) blood pressure, the percentage of variation was in average about  $\pm 2.6\%$  ( $\pm 2.9$ ). In the case of HR the percentage of variation was in average about  $\pm 2.0\%$ .

In this paper we presented the first prototype of the AAP and the produced results are concerning tests performed on only one type of Holter.

The AAP hybrid system described in the paper has moderately high costs regarding the components that drive the hydraulic section. We believe that these costs can be greatly reduced during the industrialization of the AAP. The device produced with low costs, could be bought directly from ASL "Local Health / Local Health Structure", hospital and clinics in order to check the correct operation/calibration of a Holter. The presented hybrid system is versatile and can be adapted to evaluate the correct operation of other devices used to monitor blood pressure.

## REFERENCES

- [1] Rodríguez J, Prieto S, Domínguez D, Melo M, Mendoza F, Correa C, *et al.* Mathematical-physical prediction of cardiac dynamics using the proportional entropy of dynamic systems. *Journal of Medicine and Medical Sciences* 2013; 4(9): 370-381.
- [2] CARDIOSIM<sup>®</sup>, Cardiovascular Software Simulator developed at the Institute of Clinical Physiology -UOS of Rome- (C.N.R. National Research Council) -Italy- Available from: <https://cardiosim.dsb.cnr.it/>.
- [3] De Lazzari C, Ferrari G, Mimmo R, Tosti G, Ambrosi D. A desk top computer model of the circulatory system for heart assistance simulation: effect of an LVAD on energetic relationships inside the left ventricle. *Med. Eng. Phys.* 1994; 16(2): 97-103.
- [4] Sagawa K, Maughan WL, Suga H, Sunagawa K. *Cardiac contraction and the Pressure-Volume relationships*. Oxford University Press, New York 1988.
- [5] De Lazzari C. Interaction between the septum and the left (right) ventricular free wall in order to evaluate the effects on coronary blood flow: numerical simulation. *Comput. Meth. Biomech. Biomed. Eng.* 2012; 15(12): 1359-1368.
- [6] Guyton AC, Jones CE, Coleman TG. *Computer analysis of total circulatory function and of cardiac output regulation*, In: *Circulatory Physiology: Cardiac Output and its Regulation*, WB Saunders Company, Philadelphia 1973.
- [7] De Lazzari C, L'Abbate A, Micalizzi M, Trivella MG, Neglia D. Effects of amlodipine and adenosine on coronary haemodynamics: *in vivo* study and numerical simulation. *Comput. Meth. Biomech. Biomed. Eng.* 2014; 17(15): 1642-52.
- [8] Starling E.H. *The Linacre lecture on the law of the heart*. London: Longmans, Green & Co, 1-27, 1918.
- [9] Ferrari G, Kozarski M, De Lazzari C, Clemente F, Merolli M, Tosti G, *et al.* A hybrid (numerical-physical) model of the left ventricle. *The International Journal of Artificial Organs* 2001; 24(7): 456-462.
- [10] Siewnicka A, Fajdek B, Janiszowski K. Application of a PEXSim for modeling a POLVAD artificial heart and the human circulatory system with left ventricle assistance. *Pol. J. Med. Phys. Eng.* 2010; 16(2): 107-124.
- [11] Eiby YA, Lumbers ER, Headrick JP, Lingwood BE. Left ventricular output and aortic blood flow in response to changes in preload and afterload in the preterm piglet heart. *Am. J. Physiol. Regul. Integr. Comp. Physiol.* 2012; 303: R769-R777.
- [12] Palatini P. Need for a revision of the normal limits of resting heart rate. *Hypertension*. 1999; 33: 622-625.
- [13] Samari R, Kamal RY, Friedberg MK, Silverman NH. Doppler assessment of the ratio of the systolic to diastolic duration in normal children: relation to heart rate, age and body surface area. *J. Am. Soc. Echocardiogr.* 2009; 22(8): 928-32.
- [14] De Lazzari C, D'Ambrosi A, Tufano F, Fresiello L, Garante M, Sergiacomi R, *et al.* Cardiac resynchronization therapy: could a numerical simulator be a useful tool in order to predict the response of the biventricular pacemaker synchronization? *Eur. Rev. Med. Pharmacol. Sci.*, 2010; 14(11): 969-978.
- [15] De Lazzari C, Neglia D, Ferrari G, Bernini F, Micalizzi M, L'Abbate A, *et al.* Computer simulation of coronary flow waveforms during caval occlusion. *Method. Inform. Med.* 2009; 48(2): 113-122.
- [16] Ferguson JJ, Randall OS. Hemodynamic correlates of arterial compliance. *Cathet. Cardiovasc. Diagn.* 1986; 12: 376-380.