

MICROSTRUCTURAL AND PHYSICAL ASPECTS OF HEAT TREATED WOOD. PART 1. SOFTWOODS

M.J. Boonstra, J.F. Rijdsdijk, C. Sander, E. Kegel, B. Tjeerdsma, H. Militz, J. van Acker, M. Stevens

ar papers at core.ac.uk

ABSTRACT

Heat treatment of wood is an effective method to improve the dimensional stability and durability against biodegradation. Optimisation of a two-stage heat treatment process at relatively mild conditions (<200°C) and its effect on the anatomical structure of softwoods were investigated by means of a light and scanning electron microscopic analysis. Heat treatment did have an effect on the anatomical structure of wood, although this depends on the wood species considered and on the process method and conditions used. Softwood species with narrow annual rings and/or an abrupt transition from earlywood into latewood were sensitive to tangential cracks in the latewood section. Radial cracks occurred mainly in impermeable wood species such as Norway spruce, caused by large stresses in the wood structure during treatment. Sapwood of treated pine species revealed some damage to parenchyma cells in the rays and epithelial cells around resin canals, whereas this phenomenon has not been noticed in the heartwood section. Treated radiata pine resulted in a very open and permeable wood structure limiting the applications of this species. Broken cell walls perpendicular to the fibre direction resulting in transverse ruptures have been noticed in treated softwood species. This contributes to abrupt fractures of treated wood as observed in bending tests which can lead to considerably different failure behavior after impact or mechanical stress. In some treated softwood species maceration (small cracks between tracheids) was noticed after heat treatment. Heat treatment did not cause damage to the ray parenchyma pit membranes, bordered pits and large window pit membranes; the margo fibrils appeared without damage. Compared to the other softwood timbers tested European grown Douglas fir was the timber that stands heat treatment the best.

Keywords. Wood modification, heat treatment, softwood, microscopy.

INTRODUCTION

Heat treatment of wood at relatively high temperatures ranging from 150 to 260°C is an effective method to improve dimensional stability and durability (Seborg et al, 1953, Kollmann and Schneider, 1963; Stamm, 1964; Kollmann and Fengel, 1965; Noack, 1969; Burmester, 1973 and 1975; Giebeler, 1983; Hillis, 1984; Bourgois and Guyonnet, 1988). In the last decade several research groups have been developing heat treatment methods which are suitable for industrial applications (Viitaniemi and Jamsa, 1996; Weiland and Guyonnet, 1997; Boonstra et al, 1998).

One of those methods is a two-stage heat treatment method, which is the result of an extensive research and also known as the Plato process (Boonstra et al, 1998; Tjeerdsma et al, 1998a). This heat

Plato International BV, PO Box 2159, NL-6802 CD Arnhem, The Netherlands. M.Boonstra@PlatoWood.nl.

² RINNTECH - Frank Rinn Engineering and Distribution. Bierhelder Weg 20, D-69126 Heidelberg, Germany

³ SHR Hout Research, PO Box 497, 6700 AL Wageningen, The Netherlands

⁴ Wood Biology and Wood Technology, University Göttingen, Büsgenweg 4, 37077 Göttingen, Germany

⁵ Laboratory of Wood Technology, Ghent University, Coupure links 653, 9000 Ghent, Belgium

Corresponding author: M.Boonstra@PlatoWood.nl

Received: April 20, 2006

Accepted: September 28, 2006

treatment method consists of two distinguished process stages:

- Heating and conversion of the wood to an intermediate product; and
- Curing the intermediate product into an end product.

Originally this two stage-heat treatment is based on findings of Ruyter et al (1989) who started the development of this process in the KSLA laboratory of Shell. As a result of the oil crisis in the 1970's and an increasing concern about global warming, there was a worldwide interest in fuels and chemicals from renewable sources. In the KSLA laboratory of Shell, heat treatment processes at very high temperatures and pressures were developed in order to obtain fuels and chemicals from organic material. As a spin-off of this research a new process concept for the upgrading of wood was invented (Ruyter, 1989), based on an adaptation of the process conditions. Developments in the 1990's, such as reduced oil prices and an increased industrial competition on a shrinking world market, forced companies back to their core business, and have led to the decision not to implement this project in Shell. In 1994 an independent research group was established in Wageningen (The Netherlands) to continue the development of this two-stage heat treatment method and to optimise the process conditions in order to develop an industrially applicable process and product.

In this paper a two-stage heat treatment process at relatively mild conditions (<200°C) and its effect on the anatomical structure of softwood is described. Heat treated softwood specimens were investigated by means of light and scanning electron microscopy in order to reveal possible damages or changes of the wood structure.

MATERIALS AND METHODS

Materials

The following wood species were used for heat treatment: European grown Douglas fir (*Pseudotsuga menziessii* FRANCO), Scots pine (*Pinus sylvestris* L.), Norway spruce (*Picea abies* KARST), and radiata pine (*Pinus radiata* D.).

For each species at least 10 boards or poles were treated per process condition. Cross sections of the boards had a thickness of 25-50 mm and a width of 100-150 mm while the diameter of the poles was 10 cm. The length of the boards/poles was approximately 3.0 m. The moisture content of the boards/poles before treatment was varied, respectively fresh, water-soaked, shipping dry (16-20%) or conditioned to a relatively low moisture content (12-14%).

Non-treated control specimens were used for comparison purposes.

Heat treatment

The heat treatment was performed in two separate heat treatment stages and a drying stage in between. In the first stage of the heat treatment the timber was treated in an aqueous environment at superatmospheric pressure (8-10 bar), a so called hydro thermolysis treatment. This was done in a 600 litres pilot plant and the treatment temperature varied between 165 and 185°C. The specimens were then dried in a 1 m³ (net) kiln, using a conventional drying process at 50-60°C. After drying the wood specimens were heat treated again in a special curing kiln for the second stage, now under dry and atmospheric conditions, a so called "curing" treatment (at 160-190°C). During this stage superheated steam or nitrogen gas was used as a sheltering gas to exclude oxygen.

During the first stage of the heat treatment saturated steam (a so-called steam hydro thermolysis) or liquid water (a so-called liquid full hydro thermolysis) was used as the heating medium to increase the temperature of the boards/poles. A heat exchanger was used to heat and cool the process water in the

reactor during liquid full hydro thermolysis. NaOH was added to the process water to control the pH. During steam hydro thermolysis cooling down was accomplished by flashing the reactor (a quick but controlled release of the pressure) to atmospheric conditions followed by a cold water circulation in the wall of the reactor.

Light microscopy

Small blocks were cut from the treated and non-treated boards and boiled carefully in water for approximately 15 minutes. Boiling softened the wood and thus it was possible to prepare smooth surfaces for microscopy using a microtome. If possible, sections of 30-35 μm were cut whereas sections of 60-70 μm were cut when stresses were observed in the specimens. Cross-sectional, tangential and radial surfaces of wood were cut and prepared for analysis with an Olympus binocular microscope. Enlargements of 4x, 10x, 40x, 60x (objective), 10x (oc), and 3.3x (photo oc.) were used.

Scanning electron microscopy

Small wood blocks (ca. 5x5x10mm) were cut from treated and non-treated boards and boiled in water in a microwave for 15 minutes. Since damages could occur due to microtomy, the specimens were temporarily embedded in ice by shock-freezing the wet specimens in liquid nitrogen. The ice served as an embedding material for a short time which allowed carefully cutting with a microtome. Cross and radial surfaces of wood were cut. The small specimens were subsequently kiln dried, sputter coated with gold-palladium under vacuum (ca. 20 nm), mounted on a specimen holder with carbon glue, and scanned in a Jeol Scanning Electron Microscope (JSM 5200) with magnification up to 7.500x at 15-20kV. Digital images were online transferred to a personal computer and saved as image files. To improve image quality, resolution, contrast and brightness were corrected digitally on the computer.

The electron microscopic analysis was performed on completely treated wood (including the curing treatment stage) and was mainly focused on the cross sectional and radial sectional level of wood.

RESULTS AND DISCUSSION

Process development

During the development of this two-stage heat treatment process it was found that the first process stage (the hydro thermolysis) was critical to maintain the wood quality during treatment. Defects which occurred after the complete treatment were already visible after the first process stage. It was also found that when the visual wood quality was retained after the first treatment stage, the wood quality did not change after drying and the second treatment stage (curing). For this reason much attention has been focussed on the development of the first treatment stage and its effect on the anatomical structure of wood.

- Three heating methods have been considered to perform the first process stage:
- Conductive heating with saturated steam
- Dielectric heating with microwave and radio frequency fields; and
- Resistance (Ohmic) heating.

Dielectric and resistance heating methods have been used in laboratory tests. However, these methods have practical limitations when applied on an industrial scale and therefore, external conductive heating with saturated steam was chosen as the heating medium.

Originally the two-stage heat treatment was performed on fresh timber. If necessary the test specimens were pre-soaked in water in order to keep the wood fresh. During the steam hydro thermolysis treatment

of fresh timber, it was not possible to prevent serious drying defects (surface cracks, collaps and/or deformation). These defects probably occurred during the cooling-down phase, since the reduction and eventually absence of (saturated) steam resulted in an uncontrolled drying process. In the first lab experiments the wood boards were pressed during the curing stage in order to increase the density. As a result, the surface cracks that were observed after the steam hydro thermolysis treatment and/or the drying phase, were closed and not visible anymore. On an industrial (bulk) scale it is not possible to perform the curing in a press and for this reason a special kiln was used. Closing of surface cracks during curing was not possible anymore in this kiln.

In order to prevent defects such as surface cracks the hydro thermolysis was then performed with liquid water as a heating medium, which was heated and cooled down in a heat exchanger. A liquid full hydro thermolysis facilitates a better control of the process conditions (heating and especially cooling down velocity) preventing an uncontrolled drying process of the wood surface. Furthermore, addition of NaOH to the process water is possible in order to control the pH during heat treatment.

Although the visual wood quality was slightly improved after treatment of fresh and pre-soaked timber, much better results were obtained using shipping dry timber (MC 18-22%) . Permeable wood species like radiata pine gave good results without any loss of the visual wood quality. Hardwood species and non-permeable softwood species like Norway spruce were still difficult to treat and significant losses (30-50%) in wood quality were found (cracks, collapse and/or deformation) .

An important improvement was obtained when shipping dry timber was hydro thermolysis treated using saturated steam as a heating medium. This gave the possibility to treat several hardwood species and non—permeable softwood species without a serious loss of the visual wood quality. A further fine tuning of the process conditions was performed in order to find the optimal hydro thermolysis treatment method, including moisture content before treatment, heating and cooling down velocity, final treatment temperature and process time, and equipment setting. The optimal process conditions were determined per wood species based on the wood quality after treatment.

Drying of hydro thermolysed boards/poles was performed in a conventional kiln at relatively moderate temperatures (50-60°C) which seemed best to retain the wood quality. In order to reduce emission of volatile compounds an enclosed drying system instead of a fresh air kiln was used to dry the intermediate product on an industrial scale. The moisture content after drying must be low enough (7-8%) to permit the curing stage, because in the first phase of this curing stage timber was heated rather fast (1-2°C/min) to a temperature of 100-110°C with a risk of cracks and deformation. After evaporating wood moisture the temperature is elevated again to a temperature of 170-180°C, while superheated steam was added to exclude oxygen (<2%) preventing fire risks and undesirable oxidation reactions. The heating-up and cooling-down velocity depended on the timber species used and the dimensions of the boards/poles. It is important that the temperature gradient between the surface and inner site of the boards/poles did not exceed 15-20°C during heating-up and cooling-down in order to retain the wood quality. After curing the treated timber was conditioned to a moisture content of 3-4%, since no water is available anymore (evaporated). The timber is then ready for processing (e.g. sawing, planing, etc), since the equilibrium moisture content of heat treated timber is much lower than of non-treated timber (Tjeerdsma et al, 1998a).

Special care must be taken when scaling-up a heat treatment process, because practical problems such as waste treatment may arise. The liquid waste stream includes small quantities of organic compounds extracted during thermolysis (condensate), drying (wood moisture) and curing (wood moisture) which should be treated before being discharged. Gaseous compounds extracted from the curing kiln should be treated in a scrubber system to remove the VOC's – including any organic matter and extractives from wood – from the gas stream and to minimise odour.

In figure 1 an overview of the different treatment stages is shown.

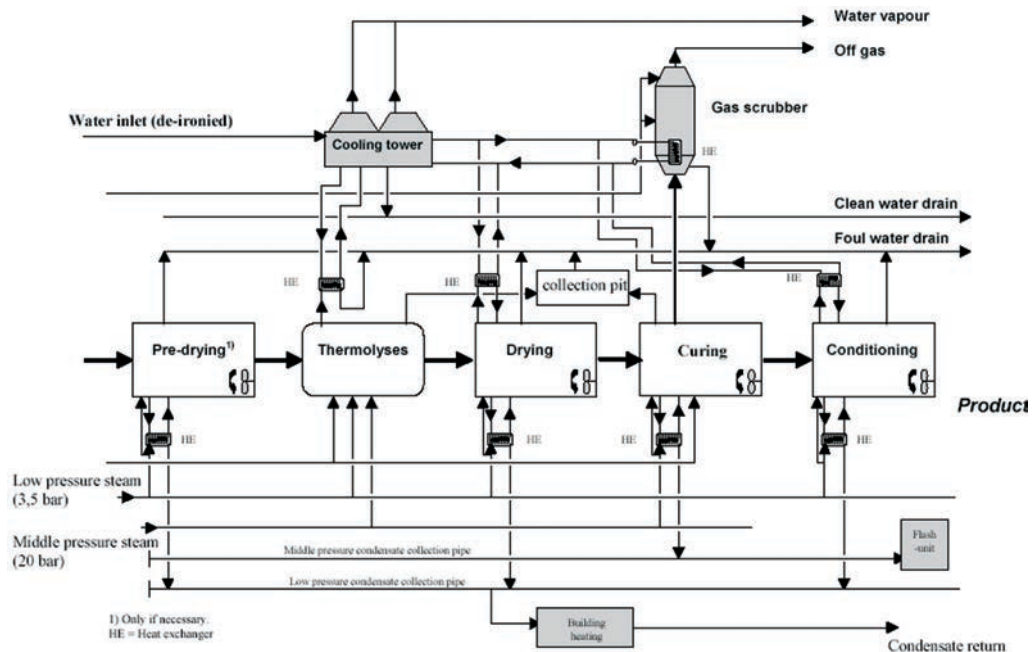

Fig. 1: Schematic overview of a two-stage heat treatment process

Colour changes due to heat treatment

The wood colour after the first treatment stage (hydro thermolysis) varied from light to dark brown, caused by the formation of quinones (Tjeerdsma et al, 1998) or the caramellization of holocellulose components (Boonstra and Tjeerdsma, 2006). An increase of the treatment temperature changed the colour into a darker tinge. Most of the colour changes occurred during the hydro thermolysis, whereas treatment of wood specimens without the first treatment stage (only the curing) resulted in a light brown colour, much lighter than after the hydro thermolysis. The colour change also depends on the timber used and is correlated to the density of the wood since the colour is becoming darker with an increasing density. The colour of the wood surface is slightly darker than the colour of the inner wood giving a lighter colour after planing. During heat treatment, extraction and/or diffusion of dark brown reaction products occurred and were depleted at the wood surface. Some timber species with a high resin content like Scots pine showed resin spots on the surface after treatment.

Dipping treated wood specimens in water resulted in an emission of a brown component, indicating a polar characteristic. This emission has also been noticed when treated timber was painted with waterborne paint systems, resulting in light brown spots in the paint layer. This was not observed for solvent borne paint systems.

During the first microscopic analysis of several wood species after the hydro thermolysis treatment stage it was noticed that the colour of the cell wall changes from white to brown. This colour change involved the compound middle lamella and the secondary cell wall. This is believed to be due to the formation of reaction products in the cell wall or to the diffusion of such reaction products within the cell wall.

Light microscopic analysis

Unfortunately it was not possible to prepare light microscopic slices using an embedding method. However, after the hydro thermolysis stage the wood structure is still rather soft and not brittle, and it is not expected that this will lead to slicing artefacts. The typical effects of the hydro thermolysis treatment on the anatomical wood structure are discussed below. Due to an apparent decrease of the visual wood quality (cracks, collaps and/or deformation), no light microscopic observations were made after the hydro thermolysis treatment of fresh (or pre-soaked) timber.

Liquid full hydro thermolysis treatment of shipping dry softwood

The liquid full hydro thermolysis treatment of shipping dry Scots pine and Norway spruce reveals tangential cracks in the latewood section (Fig. 2a). Both timber species were characterized by very narrow annual rings (approximately 1 mm per annual ring) and an abrupt transition from earlywood into latewood. During treatment large stresses must have occurred between the earlywood and latewood tracheids due to differences in shrinkage/swelling behaviour, resulting in these tangential cracks. In Norway spruce specimens with wider annual rings (2.5-3 mm per annual ring) and a gradual transition from earlywood to latewood, no tangential cracks were observed (Fig. 2b). The differences in the shrinkage/swelling behaviour are more gradual reducing the stresses between earlywood and latewood. Shipping dry radiata pine sapwood boards¹, characterized by a gradual transition from earlywood to latewood and a similar cell wall thickness for the earlywood and latewood tracheids, did not reveal tangential cracks after treatment. Although the transition from earlywood to latewood is rather sharp for Douglas fir no tangential nor radial cracks were observed after treatment.

In Scots pine, radial cracks were noticed starting in the earlywood section (Fig. 3a). The tracheids were cleaved but the cell walls seemed still intact, whereas the crack runs near the compound middle lamella (Fig. 3b). In the latewood section the cracks were closed and it seemed that the tracheids were pushed against each other.

The earlywood and latewood tracheids of Scots pine were still intact after liquid full hydro thermolysis treatment, although the linear structure of the tracheid rows and rays were slightly curved. The earlywood tracheids of Norway spruce were slightly deformed, but this was also found for the non-treated reference (so it might not be an effect of the treatment). The liquid full hydro thermolysis treatment of shipping dry Douglas fir resulted in a strong deformation of the earlywood tracheids near the latewood - earlywood border (Fig. 4a+b). The cell walls of these tracheids were partly cleaved and curved. However, this type of tracheids can be found very often in the earlywood of untreated Douglas fir, so this does not have to imply an effect of heat treatment. The latewood tracheids were still intact and straight.

The deformations of these earlywood tracheids could indicate large stresses during the hydro thermolysis treatment, caused by differences in the shrinkage/swelling behaviour between earlywood and latewood tracheids. The typical structure of the tracheid cell wall in Douglas fir, spiral thickening of the cell wall, which is thought to improve its strength might be of importance in the maintenance of the wood structure during heat treatment.

The ray parenchyma cells of pine sapwood (e.g. Scots pine, radiata pine) seemed to be damaged after hydro thermolysis and remainders of the thin cell wall were still visible (Fig. 5a). The ray tracheids were not damaged and still intact. The thin-walled epithelial cells around longitudinal resin canals seemed also to be damaged (Fig. 5b). The damage of these parenchymatic and epithelial cells decreases in the intermediate zone between sapwood and heartwood, and was not observed in the heartwood section of Scots pine. There could be several reasons for the damage of the parenchymatic and epithelial cells:

1.- According to Fujita and Harada (2001) the ray parenchyma cell wall in the Diploxyton of Pinus

¹ South Africa and New Zealand grown radiata pine with cross section sizes only containing sapwood

develops in two stages: the primary wall and inner protective layer are formed in the sapwood, and just before the heartwood is developed, the secondary wall and protective layer are deposited. Furthermore ray parenchyma cells from the sapwood of softwood species tend to be non-lignified, while adjacent ray tracheids are lignified (Daniel, 2003). This reveals a rather thin parenchymatic cell wall without lignin which should be more sensitive for the process conditions used (high temperature and pressure).

2.-Degradation of hemicelluloses which is in a relatively high content available in the compound middle lamella, during heat treatment (Tjeerdsma et al, 1998; Boonstra and Tjeerdsma, 2006).

3.-The action of the microtome knife when preparing thin slides.

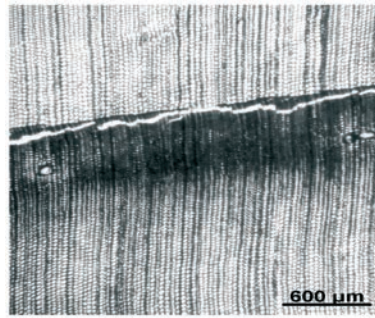

Fig. 2a Liquid full hydro thermolysed treated Norway spruce (cross section), tangential cracks in the latewood section.



Fig. 2b. Liquid full hydro thermolysed treated Norway spruce (cross section), with larger annual rings and a gradual transition from earlywood to latewood. No tangential cracks in the latewood section are visible

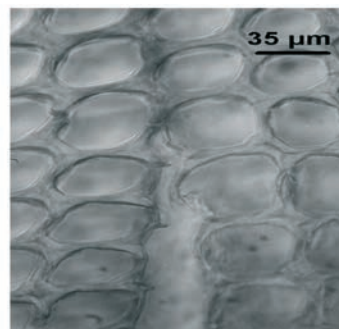
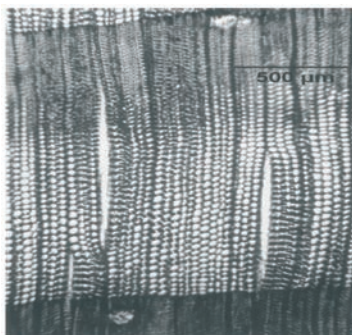

Fig. 3a+b. Liquid full hydro thermolysed treated Scots pine (cross section), radial cracks in the earlywood

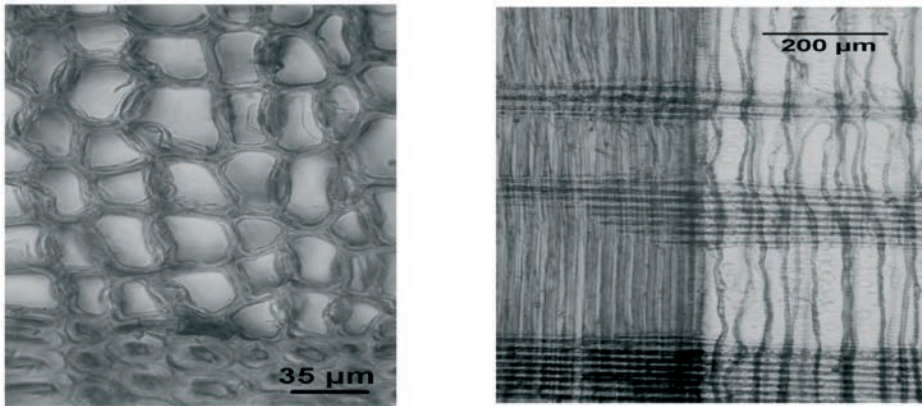

Fig. 4a+b Liquid full hydro thermolysed treated Douglas fir (cross and radial section, 400x), deformed earlywood tracheid cells near the earlywood . latewood border

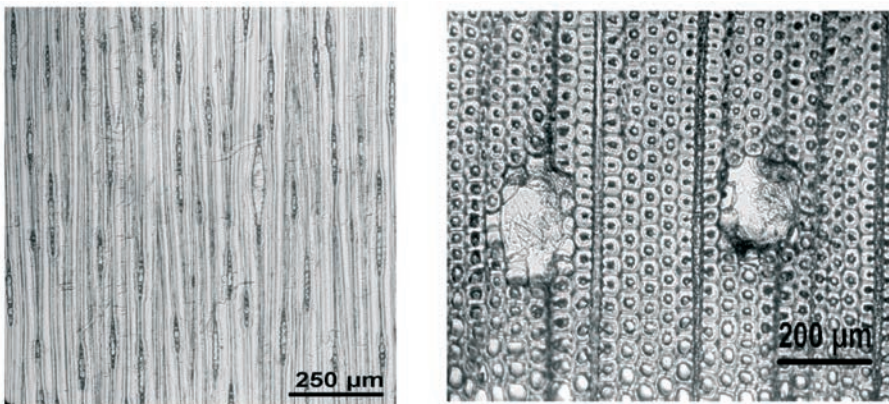

Fig. 5a+b Liquid full hydro thermolysed treated Scots pine (tangential and cross section), damaged parenchyma ray cells (a) and epithelial cells of resin canals (b). The ray tracheids are still intact

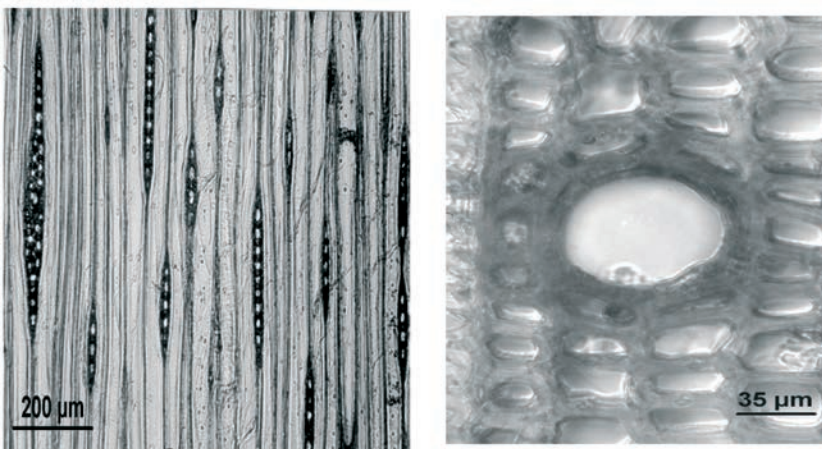

Fig. 6a+b Liquid full hydro thermolysed treated Douglas fir (tangential and cross section), the parenchyma ray cells (a) and epithelial cells of resin canals (b) are not degraded and still intact

Damage of ray parenchyma cells and the rather thick-walled epithelial cells around the resin canals of Norway spruce was not observed in the treated specimens. Norway spruce consists mainly heartwood and it is expected that the ray and axial parenchyma cell contains a secondary cell wall and is lignified. The parenchyma cells of the rays and the thick-walled epithelial cells around resin canals of Douglas fir were not damaged and were still intact (Fig. 6a,b). The cell walls of these cell structures were rather thick (including a secondary cell wall) preventing damage during the hydro thermolysis treatment.

After sawing small blocks of treated Scots pine for the microscopic analysis, the transverse section was slightly hairy and during sawing in the fibre direction loose fibres were formed. This is an indication that maceration, visible as small cracks between tracheids, occurred during the liquid full hydro thermolysis treatment stage.

Steam hydro thermolysis of shipping dry softwood

In general the application of the steam hydro thermolysis revealed positive effects on the visual wood quality after treatment compared to the liquid full hydro thermolysis. The first steam hydro thermolysis trials resulted however in a lot of stresses in the wood specimens preventing the cutting of thin sections. If it was possible to cut (thick) sections and they were often characterised by large radial cracks. Deformation of the tracheids occurred and small cracks between the tracheids were observed indicating maceration. Optimisation of the process conditions (e.g. conditioning of wood samples to a moisture content between 14% and 18% before treatment, heating and cooling down velocity, final treatment temperature and process time) was therefore necessary to prevent serious defects of the wood structure.

The application of an optimised steam hydro thermolysis treatment prevented the formation of radial cracks in earlywood section of Scandinavian grown Scots pine. However, Scots pine from German origin still revealed some radial cracks in the latewood section, probably caused by the tangential shrinkage during drying before or during the heat treatment. The Scots Pine specimens were still sensitive to tangential cracks in the latewood section and some deformation of the earlywood tracheids occurred. According to Schweingrubber (1990), the transition from earlywood to latewood is generally abrupt for Scots pine which might limit its use for this heat treatment. Small cracks between the tracheids were observed indicating some maceration. Degradation of parenchyma cells of the rays and the thin-walled epithelial cells around resin canals were still noticed in the sapwood of Scots pine.

Optimisation of the process conditions and a reduction of the moisture content before treatment were necessary to improve the wood quality of Norway spruce after treatment. Treated Norway spruce which was kiln dried to a moisture content of approximately 14% did not show tangential cracks in the latewood section. Although the amount and size of the radial cracks were decreased it was not possible to prevent the occurrence of radial cracks, especially with an increasing thickness of the boards. Norway spruce which mainly consists of heartwood, is very impermeable due to the occurrence of closed (encrusted) pits (Kollmann and Coté, 1968). During the hydro thermolysis treatment the Norway spruce specimens must be subject to large stresses, especially during the:

- warming up phase (evaporation of moisture into steam increasing the pressure in the cell lumina) and
- cooling down phase (condensation of vapours such as steam reducing the pressure and a possible vacuum formation).

Delamination (raising grain) between earlywood and latewood on the growth ring boundary is typical for tangentially sawn heat treated softwood species (located at the heartwood side of the boards). In order to prevent delamination, radial sawn Norway spruce was treated with an optimised steam hydro

thermolysis process. The results were rather disappointing as large radial cracks occurred after treatment, even in 25 mm thick Norway spruce wood specimens. This must be due to large stresses in the wood specimens during treatment closely related to the limited effect of the rays on the permeability of Norway spruce.

It was also found that the difference in temperature between the surface and the core of the wood sample should not be too high ($<30^{\circ}\text{C}$) in order to prevent or reduce serious damage to the wood structure (e.g. internal cracks), especially when an impermeable wood species was used.

An interesting phenomenon which was observed in the tangential section of treated Norway spruce was that the tracheid cell walls were broken at several places perpendicular to the tracheid direction resulting in transverse ruptures (Fig. 7a). The occurrence of this phenomenon in heat treated wood must be closely related to the abrupt fractures as observed in bending tests (Fig. 7b).

Damages to ray parenchyma cells and epithelial cells around resin canals were still observed after an optimised hydro thermolysis treatment of radiata pine with saturated steam instead of liquid water. This, however, was also observed before treatment, possibly caused by steaming and/or kiln drying at high temperatures. Damages of such cells in treated radiata pine sapwood specimens which is also observed in other pine wood species such as Scots pine, Ponderosa pine and Slash pine, resulted in a very open and permeable wood structure as revealed by a simple experiment. A wad of cotton wool was wetted with a Rhodamine B solution and placed horizontally on treated radiata pine sapwood specimen with a (radial) thickness of 25 mm. After 2 days the Rhodamine B solution was transported through the entire wood specimen.

The open structure of treated radiata pine revealed practical problems when applied in service conditions. The wood surface is subject to a fast and rather unlimited absorption and desorption (evaporation) of moisture. This results in the occurrence of deformation and/or surface cracks, already visible after a few weeks in service conditions, hazard class 3 (Fig. 8). Furthermore, a relatively long period of high moisture content can stimulate the growth of blue stain fungi and/or moulds as observed in treated radiata pine. Degradation of parenchyma ray cells reduces the physical barrier for spores and other micro organism which can settle in the wood more easily. A permeable wood structure can also affect the penetration of paint and adhesive systems affecting the performance of the paint-layer.

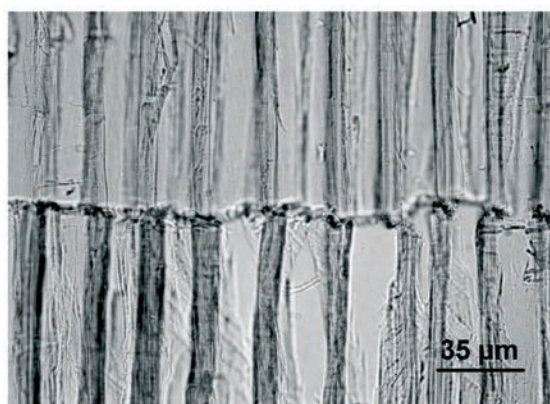

Fig. 7a Hydro thermolysed treated Norway spruce (tangential section), broken tracheid cell walls perpendicular to the fibre direction.



Fig. 7b The typical fracture of a completely treated Norway spruce specimen after a bending test

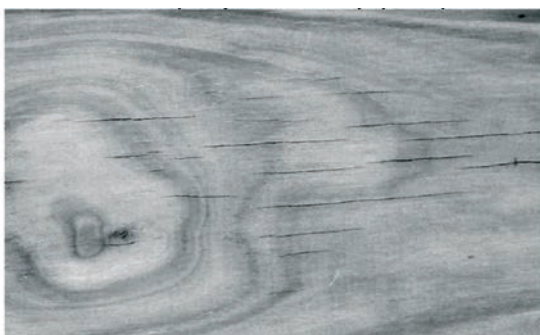

Fig. 8 Fast weathering of completely treated radiata pine (including steam hydro thermolysis) with surface cracks

Scanning electron microscopic analysis

Within the cross fields between axially oriented tracheids and radially oriented ray parenchyma's of treated radiata pine, thin pit membranes appeared not to be affected (Fig. 9). Also in Scots pine no distinct changes of anatomical feature were found. Bordered pits (interconnecting tracheids) were not affected (Fig. 10a,b) and also the large window pit membranes did not reveal any damage which can be attributed to the heat treatment (Fig. 10c).

Norway spruce (Fig. 11a,b) neither revealed damages like detachment of cells or cell wall layers nor destruction or degradation of pits. Pit membranes of bordered pits between tracheids were intact; the margo fibrils appeared without damage. There was only some indication of plasticization and starting liquefaction of pit torus material, flowing along the margo fibrils into the margo region (Fig. 11b+c). Kollmann and Sachs (1967) have found comparable features in spruce after thermal treatment between 190°C and 240°C. Nevertheless, such type of changes were not distinct and it appears very likely that plasticization of cell wall material appears only to a very limited degree during this heat treatment.

Sticks from heat treated and non-treated radiata pine (20x20x360 mm) were tested for bending strength and modulus of elasticity. The heat treated specimens revealed a considerably altered breaking behaviour compared to the non-treated specimens. For treated wood specimens the fracture surfaces were mainly brittle and abrupt.

These differences in breaking behavior were confirmed by SEM analysis. The fracture surface appeared brittle and flat (Fig. 12a-c). Fractures in non-treated control specimens (Fig. 13a-c) lead to

defibrillation of tissue and delamination of cell walls, resulting in a more axial orientation of detachments. In contrast to this, treated wood had straight fractures favoring detachments perpendicular to the longitudinal axis. In some cases (Fig. 12c) the fracture surface resembles a cut appearance, which appears to be most prominent in the secondary cell wall.

Other SEM-studies on fracture surfaces after strength tests prove that delamination of cell walls due to forces perpendicular to the cell axis lead to delamination between cell wall layers, most prominently between the compound middle lamella and the secondary wall (Wardrop 1951, Zimmermann et al. 1994). Nevertheless, fracture behavior of wood is affected by duration of stress, wood moisture content and temperature. The present study indicates that heat treatment can lead to considerably different failure behavior after impact of mechanical stress.

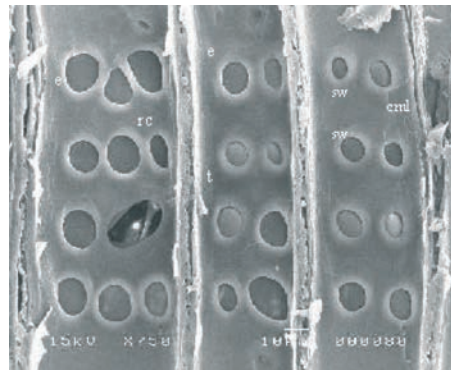

Fig. 9 Two stage heat treated radiata pine: radial section of crossing field.

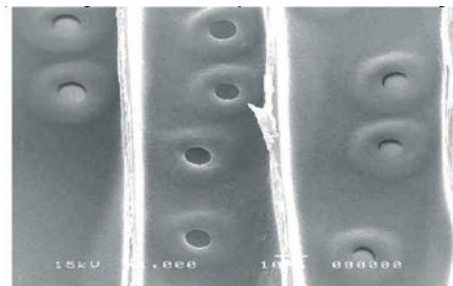

Fig. 10a Two stage heat treated Scots pine: radial section of tracheids.

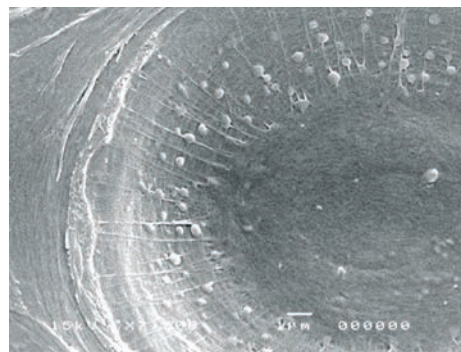

Fig. 10b Two stage heat treated Scots pine, bordered pit with opened pit chamber.

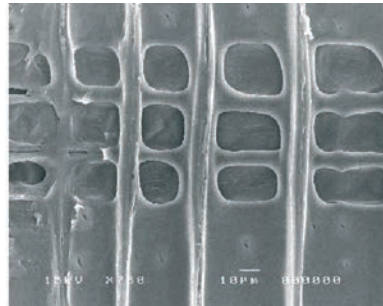

Fig. 10c. Two stage heat treated Scots pine, radial section, crossing field.

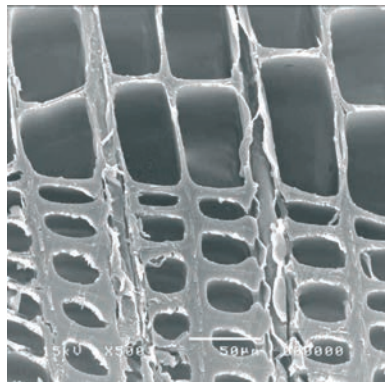

Fig. 11a. Two stage heat treated Spruce, cross section.

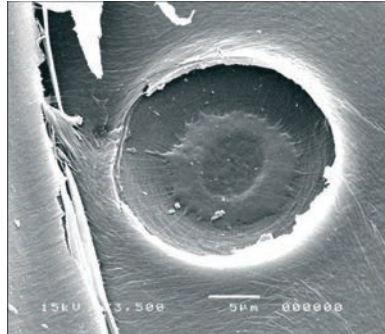

Fig. 11b. Two stage heat treated Spruce, bordered pit with opened pit chamber

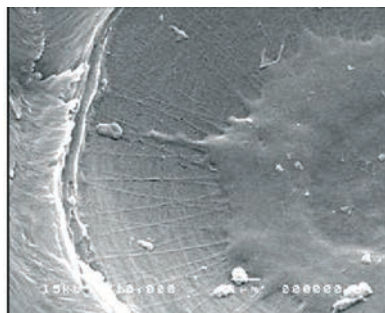

Fig. 11c Magnification of Figure 11b

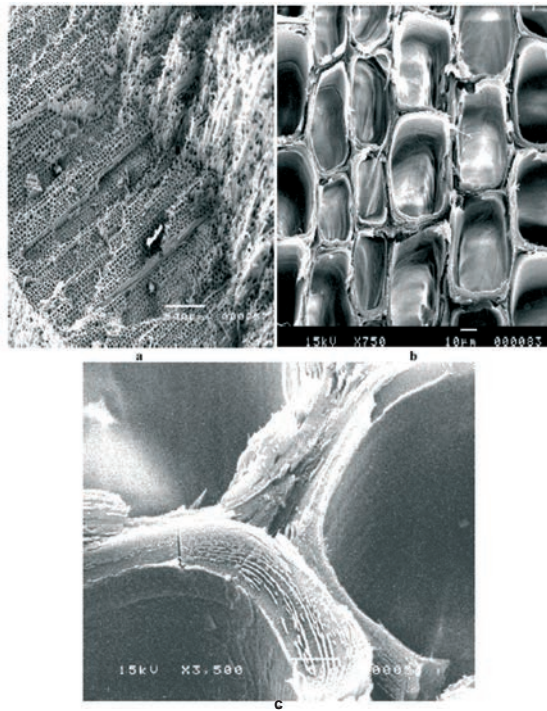

Fig. 12: Two stage heat treated radiata pine, fracture surface after bending test

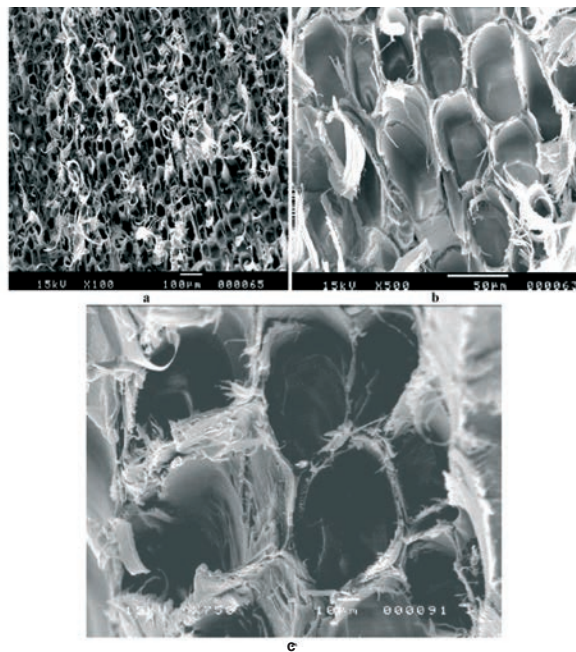

Fig. 13: Non-treated radiata pine, fracture surface after bending test.

CONCLUSIONS

A two-stage heat treatment does have an effect on the anatomical structure of wood, although this depends on the wood species considered and on the process method and conditions used. Softwood species with narrow annual rings and/or an abrupt transition from earlywood into latewood were sensitive to tangential cracks in the latewood section. Radial cracks occurred mainly in impermeable wood such as Norway spruce, caused by large stresses in the wood structure during treatment. Sapwood of treated pine species revealed some damage to parenchyma cells in the rays and epithelial cells around resin canals, whereas this phenomenon has not been noticed in the heartwood section (Scots pine). Treated radiata pine resulted in a very open and permeable wood structure limiting the applications of this species. Broken cell walls perpendicular to the fibre direction resulting in transverse ruptures have been noticed in treated softwood species. This contributes to abrupt fractures of treated wood as observed in bending tests which can lead to considerably different failure behavior after impact or mechanical stress. In some treated softwood species maceration (small cracks between tracheids) was noticed after heat treatment. Heat treatment did not cause damage to the ray parenchyma pit membranes, bordered pits and large window pit membranes; the margo fibrils appeared without damage. Compared to the other softwood timbers tested European grown Douglas fir was the timber that stands heat treatment the best.

After process optimisation a well controlled heat treatment process was developed suitable for an industrial production of timber species. Changes of the anatomical structure after heat treatment should not limit the use of treated timber in the usual timber applications. However, some treated wood species require special attention in service conditions.

Acknowledgements

The authors are also very grateful that most of this research was financially supported by the Dutch government within the BTS program.

REFERENCES

- Boonstra, M.J.; Tjeerdsma, B.F.; Groeneveld, H.A.C. 1998.** Thermal modification of non-durable wood species. Part 1. The Plato technology: thermal modification of wood. International Research Group on Wood Preservation, Document no. IRG/WP 98-40123
- Boonstra, M.J.; Tjeerdsma, B.F. 2006.** Chemical analysis of heat treated softwoods. *Holz als Roh- und Werkstoff* 64: 204-211.
- Bourgois, J.; Guyonnet, R. 1988.** Characterization and analysis of torrefied wood. *Wood Science and Technology* 22:143-155
- Burmeister, A. 1973.** Einfluss einer Wärme-Druck-Behandlung haldtrockenen Holzes auf seine Formbeständigkeit. *Holz als Roh- und Werkstoff* 31:237-243
- Burmeister, A. 1975.** Zur Dimensionsstabilisierung von Holz. *Holz als Roh- und Werkstoff* 33:333-335.
- Daniel, G. 2003.** Microview of wood under degradation by bacteria and fungi. Chapter 4. in *Wood deterioration and preservation*. Advances in our changing world. ISBN 0-8412-3797-2
- Giebler, E. 1983.** Dimensionsstabilisierung von Holz durch eine Feuchte/Wärme/Druck-Behandlung. *Holz als Roh- und Werkstoff* 41:87-94
- Fengel, D.; Wegener, G. 1984.** Distribution of the components within the wood cell wall. In *Wood: Chemistry, Ultrastructure, Reactions*. Walter de Gruyter and Co. Berlin, New York. Chapter 8: 227-239
- Fujita, M.; Harada, H. 2001.** Ultrastructure and formation of wood cell wall. In: Hon N-S and Shiraishi N (2001). *Wood and cellulosic chemistry*. Marcel Dekker Inc. New York. Chapter 1: 1-50
- Hillis, W.E. 1984.** High temperature and chemical effects on wood stability. Part 1. General considerations. *Wood Science and Technology* 18:281-293

- Kollmann, F.; Coté, W. 1968.** *Principles of wood science and technology*. In Chapter 1 and 2. Springer-Verlag Heidelberg 1968.
- Kollmann, F.; Fengel, D. 1965.** Änderungen der chemischen Zusammensetzung von Holz durch thermische Behandlung. *Holz als Roh- und Werkstoff* 21(3):77-85
- Kollmann, F.; Sachs, I.B. 1967.** The effects of elevated temperature on certain wood cells. *Wood Sci. Technol.* 1: 14-25
- Kollmann, F.; Schneider, A. 1963.** Über das Sorptionsverhalten wärmebehandelter Hölzer. *Holz als Roh- und Werkstoff* 41:87-94
- Noack, D. 1969.** p über die Heisswasserbehandlung von Rotbuchenholz im Temperaturbereich von 100 bis 180°C. *Holzforschung und Holzverwertung* 21(5):118-124
- Ruyter, H.P. 1989.** European patent Appl. No. 89-203170.9
- Schweingrubber, F.H. 1990.** Anatomy of European woods. ISBN 3-258-04258-6
- Seborg, R.M.; Tarkow, H.; Stamm, A.J. 1953.** Effect of heat upon the dimensional stabilisation of wood. *Journal Forest Products Research Society* 3(9):59-67
- Stamm, A.J. 1964.** *Wood science and technology*. The Ronald Press Company. USA. Chapter 19: 312-342
- Tjeerdsma, B.F.; Boonstra, M.; Militz, H. 1998a.** Thermal modification of non-durable wood species. Part 2. Improved wood properties of thermally treated wood. International Research Group on Wood Preservation, Document no. IRG/WP 98-40124
- Tjeerdsma, B.F.; Boonstra, M.; Pizzi, A.; Tekely, P.; Militz, H. 1998b.** Characterisation of thermally modified wood: molecular reasons for wood performance improvement. *Holz als Roh- und Werkstoff* 56:149-153
- Tjeerdsma, B.F.; Militz, H. 2005.** Chemical changes in hydrothermal treated wood: FTIR analysis of combined hydrothermal and dry heat-treated wood. *Holz als Roh- und Werkstoff* 63: 102-111.
- Viitaniemi, P.; Jamsa, S. 1996.** Puun modifointi lampokassittelyllä (Modification of wood with heat treatment). Espoo 1996, VTT Juskaisuja - Publikationer 814.
- Wardrop, A.B. 1951.** Cell wall organization and the properties of the xylem 1. Cell wall organization and the variation of breaking loading tension of the xylem in conifer stems. *Australian J. Sci. Res., Series B - Biol. Sci.* 4(4)
- Weiland, J.J.; Guyonnet, R. 1997.** Retifiziertes Holz. 16. Verdichteter Holzbau in Europa. Motivation, Erfahrung, Entwicklung. Dreiländer Holztagung. 10. Joanneum Research Fachtage. 2.-5.11.1997. Grazer Congress. Graz, Austria
- Zimmermann, T.; Sell, J.; Eckstein, D. 1994.** Rasterelektronenmikroskopische Untersuchungen an Zugbruchflächen von Fichtenholz. *Holz Roh- Werkstoff* 52: 223-229