



Graduate Theses, Dissertations, and Problem Reports

2014

Nerve growth factor regulates Na⁺ transport in human airway epithelial cells

Michael J. Shimko
West Virginia University

Follow this and additional works at: <https://researchrepository.wvu.edu/etd>

Recommended Citation

Shimko, Michael J., "Nerve growth factor regulates Na⁺ transport in human airway epithelial cells" (2014). *Graduate Theses, Dissertations, and Problem Reports*. 562.
<https://researchrepository.wvu.edu/etd/562>

This Dissertation is protected by copyright and/or related rights. It has been brought to you by the The Research Repository @ WVU with permission from the rights-holder(s). You are free to use this Dissertation in any way that is permitted by the copyright and related rights legislation that applies to your use. For other uses you must obtain permission from the rights-holder(s) directly, unless additional rights are indicated by a Creative Commons license in the record and/ or on the work itself. This Dissertation has been accepted for inclusion in WVU Graduate Theses, Dissertations, and Problem Reports collection by an authorized administrator of The Research Repository @ WVU. For more information, please contact researchrepository@mail.wvu.edu.

Nerve growth factor regulates Na⁺ transport in human airway epithelial cells

Michael J. Shimko

Dissertation Submitted to the
School of Pharmacy
at West Virginia University

in partial fulfillment of the requirements for the degree of

Doctor of Philosophy
in
Pharmaceutical and Pharmacological Science

Jeffrey S. Fedan, Ph.D., Chair
James M. Antonini, Ph.D.
Patrick S. Callery, Ph.D.
Richard D. Dey, Ph.D.
Gregory M. Dick, Ph.D.

Department of Basic Pharmaceutical Sciences

Morgantown, West Virginia

2014

Keywords: Ion transport, Nerve Growth Factor, Airway Epithelium, Lung,
Electrophysiology

Abstract

Nerve growth factor regulates Na⁺ transport in human airway epithelial cells

Michael Shimko

Nerve growth factor (NGF) was discovered for its ability to enhance nerve growth, but recent evidence suggests there is a correlation between elevated NGF levels in the lung and airway diseases, including lung inflammatory diseases and respiratory virus infections. NGF can be produced and act upon both structural and non-structural cells of the airways, and overexpression of NGF causes morphological and physiological changes in the airways, such as an increased innervation resulting in a neuronal remodeling of the lung, airway smooth muscle thickening, increased vascularization, airway hyperreactivity to capsaicin, and subepithelial thickening. Although work has been conducted to investigate NGFs effects on ion transport in non-airway cells, such as PC12, MTAL, and HEK-293 cells, no information is available regarding the effect NGF has on ion transport of airway epithelial cells. To investigate whether NGF can affect epithelial ion transport, a well-differentiated human primary cultured epithelial cell model was developed. The ability for these cells to differentiate into epithelial cells, which represent *in situ* epithelial morphology, was confirmed using several imaging techniques. Cells were placed in Ussing chambers to obtain transepithelial voltage (V_t , -7.1 ± 3.4 mV), short-circuit current (I_{sc} , 5.9 ± 1.0 μ A), and transepithelial resistance (R_t , $750 \Omega \cdot \text{cm}^2$), and to measure responses to ion transport inhibitors. Apical and basolateral

NGF concentration-response curves were generated, but NGF only evoked bioelectric responses apically with the maximum response occurring at 1 ng/ml. To investigate the ionic basis for the bioelectric responses to NGF, responses to known ion transport inhibitors were generated in the absence or presence of 1 ng/ml NGF. The addition of 1 ng/ml of NGF to the apical membrane decreased I_{sc} by 5.3 %. Amiloride (apical, 3.5×10^{-5} M), which inhibits Na^+ transport, decreased I_{sc} by 55.3 % in the absence of NGF, but this response was reduced (41.6 %; $p = 0.0127$) in the presence of 1 ng/ml NGF, which indicated NGF was affecting amiloride-sensitive Na^+ transport. There were no differences in response to NPPB or ouabain, indicating NGF did not have an effect on Cl^- transport or the Na^+/K^+ -ATPase. To investigate if the trkA receptor was responsible for mediating the NGF-induced reduction in Na^+ transport, the non-specific tyrosine kinase inhibitor, K-252a (10 nM, apical), was used. K-252a reduced the NGF bioelectric response as well as attenuated the NGF-induced reduction in Na^+ transport. The trkA receptor activates the Erk 1/2 signaling pathway, which has been shown to phosphorylate ENaC and reduce Na^+ transport by channel degradation through a NEDD4-mediated ubiquitin pathway. To investigate if NGF is activating the Erk 1/2 signaling pathway downstream of trkA, the specific Erk 1/2 inhibitor, PD-98059 (30 μM , apical and basolateral), was used. PD-98059 reduced the NGF-induced bioelectric response as well as attenuated the NGF-induced reduction in Na^+ transport. Protein analysis using western blot techniques confirmed NGF-mediated reduction in Na^+ transport was a result of Erk 1/2 activation and ENaC phosphorylation.

To investigate if incubation with NGF can elicit changes in ion transport, cells were incubated with NGF for 24 or 48 h prior to placing to cells into Ussing chambers. Cells exposed to NGF for either 24 or 48 h did not demonstrate changes in ion transport as compared to control cells, indicating NGF did not have a genomic effect on ion transporter subunit expression. These results also suggest that the rapid reduction in amiloride-sensitive Na^+ transport is a transient reduction. To determine if this lack of response was a result of a decreased concentration of NGF during the incubation period, a NGF-specific ELISA assay was used. Cells internalized or metabolized 94% of initial concentration of NGF applied within 5 min, as inserts without cells did not demonstrate a reduction in NGF concentration.

The findings discussed in this dissertation indicate that NGF causes a transient and non-genomic reduction in Na^+ transport in epithelium through a *trkA*-Erk1/2-mediated signaling pathway, resulting in the internalization and degradation of ENaC. This reduction in Na^+ transport would result in the hydration of the airway surface liquid.

Dedication

To my parents, Michael Shimko and Mary Kay Shimko, my sister, Olivia Shimko, my aunt, Susan Wojcik, and my grandparents, John and Catherine Wojcik. Their continuous support provides the encouragement necessary to pursue and fulfill my dreams.

To my friends for continuous support throughout the years.

To my previous coaches and teachers for teaching me valuable life lessons, both on and off the field.

Acknowledgements

I wish to thank my mentor, Jeffrey S. Fedan, for the support and guidance during my graduate career. I would like to thank my graduate committee, James Antonini, Gregory Dick, Patrick Callery, and Richard Dey for their guidance on my graduate research project. Finally, I would like to thank Eric Zaccone and Janet Thompson for their support and friendship in the lab.

Table of Contents

Abstract.....	ii
Dedication.....	v
Acknowledgements.....	vi
Table of Contents.....	vii
List of Figures.....	x
List of Abbreviations.....	xi
Chapter 1: Introduction and discovery of NGF.....	1
Introduction.....	2
Discovery of NGF.....	4
β -NGF chromosomal gene location.....	10
Discovery of other members of the neurotrophin family.....	11
Brain-derived neurotrophic factor.....	11
Neurotrophin-3.....	12
Neurotrophin-4/5.....	13
Neurotrophin receptor family.....	13
Introduction.....	14
Discovery of the neurotrophin receptor(s)	14
trkA.....	15
trkA neurotrophin binding.....	16
trkB.....	17
trkB neurotrophin binding.....	17
trkC.....	18
trkC neurotrophin binding.....	19
p75 ^{NTR}	19
p75 ^{NTR} neurotrophin binding and intracellular signaling pathways.....	19
trkA structure and intracellular signaling pathways.....	21
References.....	24

Chapter 2: NGF and lung disease.....	36
Introduction.....	37
Sources of NGF in the lung.....	37
NGF and airway epithelial cells.....	38
NGF and immune cells.....	38
NGF and airway nerve innervation.....	40
NGF and airway smooth muscle.....	42
NGF and pulmonary vasculature.....	42
NGF and lung disease.....	44
References.....	46
Chapter 3: NGF and Ion Transport.....	57
Introduction.....	58
Ion transport in airway epithelial cells.....	58
Sodium transport.....	61
Chloride transport.....	64
Ion transport and airway disease.....	66
NGF and ion transport.....	69
References.....	72
Chapter 4: Research Plan.....	82
Introduction.....	83
Research design and methods.....	83
Specific Aim 1.....	83
1.1.....	84
1.2.....	84
Specific Aim 2.....	85
2.1.....	85
2.2.....	86
References.....	87
Chapter 5.....	89

Nerve growth factor reduces amiloride-sensitive Na ⁺ transport in human airway epithelial cells.....	89
Abstract.....	90
Introduction.....	91
Methods.....	93
Results.....	98
Discussion.....	105
Acknowledgements.....	108
References.....	109
Figures.....	113
Chapter 6: Discussion.....	125
Introduction.....	126
Specific Aim 1.....	126
Specific Aim 2.....	128
Future experiments.....	129
NGF's effect on airway surface liquid height.....	129
NGF's effects on alveolar type II cells.....	130
Desensitization to NGF.....	131
References.....	133

List of Figures

Chapter 3

Figure 3.1 – Representative model to depict the location of ion channels in airway epithelial cells.....61

Chapter 5

Figure 5.1 – Time-course of the development of R_t in ALI-cultured NHBE cells.....116

Figure 5.2 – Confirmation of NHBE cell differentiation.....117

Figure 5.3 – Representative I_{sc} tracings of responses ion transport inhibitors.....118

Figure 5.4 – Effect of NGF on ion transport.....119

Figure 5.5 – Effect of NGF on amiloride-sensitive Na^+ transport.....120

Figure 5.6 – Effect of NGF-induced trkA activation on amiloride-sensitive Na^+ transport.....121

Figure 5.7 - The involvement of the trkA downstream signaling pathway, Erk 1/2, in the NGF-induced reduction of amiloride-sensitive Na^+ transport.....122

Figure 5.8 – Effect of prolonged incubation with NGF on ion transport.....123

Figure 5.9 – Effect of NGF on Erk 1/2 activation and ENaC phosphorylation..124

List of Abbreviations

6-OHDA	6-hydroxydopamine
AHR	airway hyperresponsiveness
ASL	airway surface liquid
ASM	airway smooth muscle
ATII	alveolar type II
BAL	bronchoalveolar lavage
BCFTR	basolateral CFTR-like channel
BDNF	brain-derived neurotrophic factor
BORC	basolateral outward rectifying channel
CaCC	Ca ⁺² -dependent Cl ⁻ channels
CCSP	Clara-cell secretory protein
CFTR	cystic fibrosis transmembrane conductance regulator
CHO	Chinese hamster ovary
ClC	Cl ⁻ channels
COPD	chronic obstructive pulmonary disease
EDRF	epithelium-derived relaxing factor
EFS	electric field stimulation
ENaC	epithelial Na ⁺ channels
eNOS	nitric oxide synthase
GM-CSF	granulocyte-macrophage colony-stimulating factor
HRV	human rhinovirus
ICAM-1	intercellular adhesion molecule 1

Ig-C2	C2-type immunoglobulin
MKHS	modified Krebs-Henseleit solution
NADE	nerve death executor
NGF	nerve growth factor
NHBE	normal human bronchial epithelial
NHE	Na ⁺ /H ⁺ exchanger
NKCC	Na ⁺ /K ⁺ /2 Cl ⁻ cotransporter
NRAGE	neuropeptide receptor-interacting MAGE homolog
NT-3	neurotrophic factor 3
NT-4/5	neurotrophic factor 4/5
PC12	pheochromocytoma
PCL	periciliary liquid
PCR	polymerase chain reaction
PHA1	pseudohypoaldosteronism type 1
PN1	peripheral nerve-type Na ⁺ channel
PPxY	proline-rich domain
RSV	respiratory syncytial virus
SAEC	small airway epithelial cells
SP	substance P
SPLUNC	short palate, lung and nasal epithelial clone
VEGF	vascular endothelial growth factor

Chapter 1

Introduction and Discovery of NGF

Introduction

Nerve growth factor (NGF), discovered by Rita Levi-Montalcini in the late 1950's, was the first member of the neurotrophin family. Several other neurotrophins have since been discovered, including brain-derived neurotrophic factor (BDNF), neurotrophic factor 3 (NT-3), and neurotrophic factor 4/5 (NT-4/5).

Levi-Montalcini was born in Turin, Italy on April 9, 1909. She graduated from Turin medical school in 1936 with a degree in Medicine and Surgery before spending three years in a specialized neurology and psychiatry program at the same university working with Dr. Giuseppe Levi. In 1938 Benito Mussolini published the Manifesto of Race which prevented Levi-Montalcini from working at the university. Determined to continue practicing her new passion of research, Levi-Montalcini set up a makeshift laboratory in her countryside home where she confirmed and expanded upon the effects of limb removal on the development of the nervous system, which was previously reported by Viktor Hamburger. After Hamburger learned about Levi-Montalcini's work, he offered her a one year position in his laboratory in 1946. Levi-Montalcini moved to Washington University in St. Louis to work with Hamburger. In Hamburger's laboratory, Levi-Montalcini made several important discoveries which eventually lead to the discovery of NGF. The exciting discoveries which took place extended Levi-Montalcini's one year rotation to her spending thirty years at the Washington University (24, 54).

Although Levi-Montalcini and Hamburger designed several very important experiments to identify the ability of mouse sarcoma tumors to increase the size of the chicks embryo sensory ganglia, their abilities to identify the compound responsible for

this enhanced nerve growth was lacking. Stanley Cohen was born in Brooklyn in 1922, attended Brooklyn College where he majored in biology and chemistry, and obtained his masters at Oberlin College and Ph.D. in biochemistry at the University of Michigan in 1948. In 1952 Cohen moved to Washington University to work in the radiology department. Cohen and Levi-Montalcini crossed paths at the university. Needing a biochemist, Hamburger secured funding to allow Cohen to join his team and aid in the identification and characterization of the nerve growth factor which was being released by the sarcoma tumors to increase the size of the chick embryo sensory ganglia. Stanley, Levi-Montalcini, and Hamburger published their first joint paper in 1954 titled “A Nerve Growth-Stimulating Factor Isolated from Sarcomas 37 and 180” (22). This was the last publication to include Hamburger as an author, as Hamburger felt he could not contribute to the content of the experiments with his lack of knowledge in the field of biochemistry.

Levi-Montalcini and Cohen went on to publish numerous publications dealing with the newly discovered nerve growth agent, later termed nerve growth factor (NGF). Their efforts to identify the protein that caused enhanced nerve growth earned Levi-Montalcini and Cohen the Noble Prize in Medicine or Physiology in 1986 (24). Levi-Montalcini founded and headed the European Brain Research Institute (EBRI) located in Rome, Italy. Levi-Montalcini never retired, and was the longest living Noble Prize winner to date. She used NGF eye drops daily, and believed they gave her energy and kept her brain function properly. Levi-Montalcini passed away on December 30, 2012 at the age of 103 (16).

Discovery of NGF

The discovery of NGF came after an experimental observation made by Bueker et al. in 1947 (15). Using a technique involving transplanting mouse tumors intra-embryonically in chick embryos, Bueker found that the transplanted tumor, sarcoma 180, was highly invaded by the host sensory nerve fibers. The ganglia, located on the same side as the tumor, were also considerably larger (14, 15). Expanding on this work, Levi-Montalcini et al. transplanted both sarcomas 37 and 180 intra-embryonically and examined nerve growth during the entire developmental period of the chick embryo. She discovered that both sarcomas 37 and 180 caused a 600 % increase in the size of the sympathetic ganglia adjacent to the tumor (48, 53). The increased nerve volume was attributed to increased cell number, increased cell size, and accelerated differentiation (48). From these results, it was concluded that the sarcoma 37 and 180 tumor cells produced and released a nerve growth stimulating agent that was specific for sensory cells and sympathetic ganglia (48).

After discovering that sarcomas 37 and 180 had effects on nerve growth, Levi-Montalcini et al. began to isolate the agent responsible for the increase in nerve growth. She cultured chick embryo sensory ganglia using a hanging drop method in which the media used to grow the ganglia contained either homogenates of sarcomas 37 or 180 tumors grown in the body wall of chick-embryos or saline. Ganglia cultured in media containing sarcoma homogenates had increased neuronal outgrowth compared to saline controls. Sarcomas 37 and 180 tumors, which were grown in a mouse host, did not have a growth effect on ganglia (22). Sarcoma 37 and 180 tumors, which were grown in the

body wall of a chick embryo, were homogenized, separated through differential centrifugation, and each component (whole homogenate, nuclei, mitochondria, microsomes, and supernatant) was added to the culture medium used to culture chick embryo sensory ganglia. Of the cellular components obtained during differential centrifugation, the microsomal fraction resulted in the highest degree of neuronal outgrowth. Further investigation was conducted by precipitating out from the microsomes highly polymerized nucleic acids and nucleoproteins using streptomycin. After precipitation, the supernatant had no effect on chick embryo sensory ganglia growth, but the re-suspended fraction containing the polymerized acids and nucleoproteins resulted in an increased nerve growth. The growth factor in the re-suspended fraction was found to be heat sensitive and nondialyzable.

The agent which caused enhanced nerve growth was also found to be a diffusible agent. This was discovered using *in vitro* co-cultures of sarcoma 37 or 180 and chick embryo sensory ganglia located in close proximity to each other (55). Nerve fiber outgrowth, in this *in vitro* experimental design, started at 12 h, peaked at 24 - 48 h, and then regressed. The neuronal outgrowth was not directed towards the tumor, but, rather, equally in all directions.

During the process of trying to identify the agent which was responsible for the increased nerve growth, snake venom was used as a source of a phosphodiesterase. It was found that treatment of sarcoma homogenates with snake venom enhanced its effect on nerve growth (20). The increased activity after treatment suggested the venom also contained an agent which caused increased nerve growth, and was later determined to be

3,000 - 6,000 times as active as the sarcoma homogenates. The effects of snake venom on nerve growth could be blocked with anti-snake serum, heating, and acid treatment. The agent in snake venom was also determined to be nondialyzable and proteinaceous. Both sarcoma lysate and snake venom had similar effects on nerve growth and function in chick embryos (52). Cohen demonstrated that venom from different snake species had different potencies in eliciting nerve growth, with the most potent venom being from *Vipera russelli* and *Vipera aspis*. Using ultracentrifugation, Cohen detected a protein in the snake venom with a mass of 2.2 S and an absorbance spectrum 280/260 ratio of 1.3 (18). After purifying the venom, Cohen concluded the agent responsible for the enhanced nerve growth was a protein after incubating the purified venom with proteolytic enzymes and observing a reduction in activity. Venom incubated with RNase or DNase retained the ability to enhance nerve growth (18).

The results obtained so far demonstrated the ability of two unrelated sources, mouse sarcoma tumors and snake venom, to cause an increased level of growth in chick sensor nerves and sympathetic ganglia. Since the snake venom, which is produced in modified salivary glands in the snake, had a greater effect on nerve growth than the sarcoma homogenate, Levi-Montalcini et al. investigated whether the mouse salivary glands produced a similar effect on nerve growth using both *in vitro* and *in vivo* techniques. She found that homogenized mouse salivary glands, which proved to be much more potent than sarcoma homogenates and snake venom, produced similar results on mouse nerve growth and differentiation (51). Levi-Montalcini et al. demonstrated that the salivary factor could increase the size of ganglia isolated from human aborted fetuses,

rodents and birds. *In vivo*, newborn mice, injected daily after birth with purified salivary gland extract, had twice as many cells located in their superior cervical ganglia as compared to controls after nineteen days, which was due to both hypertrophy and hyperplasia of the cells. When adult mice were injected daily with the purified salivary factor, their ganglia doubled in size, but this doubling was due to cellular hypertrophy only (51).

Levi-Montalcini and Cohen detected that the purified mouse salivary glands produced a very potent factor which caused nerve growth in several different species. The salivary glands were a very accessible source of this growth factor. The salivary gland homogenates were purified by Cohen through a series of precipitation and centrifugation steps prior to separating the material through a cellulose column (50). The purified salivary gland extract required 0.015 $\mu\text{g/ml}$ of purified protein to generate a halo effect on cultured sensory ganglia, compared to 1.5 $\mu\text{g/ml}$ of salivary gland homogenate and 0.15 $\mu\text{g/ml}$ of purified snake venom. So far, all of the evidence from the purification steps suggested the compound responsible for nerve growth was a protein.

An antibody to the growth factor was developed to determine if the effect of the purified salivary gland extract could be inhibited. Rabbits were injected with the purified salivary gland extract along with Freund's adjuvant. Rabbit serum, when added to *in vitro* hanging drop assays to assess ganglia growth, blocked the responses to purified salivary glands and snake venom, but serum from non-treated rabbits did not (19). When this rabbit anti-serum was injected into both newborn and adult mice, the anti-serum caused a 93 % reduction in the cell population of the superior cervical ganglion, but animals

injected with the control serum were unaffected (49, 51). The ability of the anti-serum to reduce the number of cells in the ganglia was confirmed in several other species, including rats, rabbits, and cats.

The identification of the molecular characteristics of NGF could be investigated in more depth with the readily available and highly potent source from salivary glands. Bueker et al., improving on Cohen's isolation and purification methods, performed electrophoresis on the purified protein, and assayed each band for its biological ability to induce neuronal outgrowth of chick embryo sensory ganglia (74). The results indicated that two proteins, only in combination with each other, produced an increased level of neuronal outgrowth. Bueker determined the molecular weight of the two proteins to be 8.6 and 4.3 kDa. The 280/260 ultraviolet-absorption ratio, for the protein with the molecular weight of 8.6 kDa, was 1:78. The protein with a molecular weight of 4.3 kDa was negative to ultraviolet-absorption. This absorption ratio was slightly different from those obtained from earlier in the mouse sarcoma (1:25) (21), snake venom (1:30) (18), and mouse salivary gland (1:53) (19). The estimated molecular weights were also slightly different than the previously reported 20 kDa from the snake venom (18) and 40 kDa from the salivary gland (19). Bueker, by hydrolyzing the protein using HCl and heat, identified the amino acids which composed the 8.6 and 4.3 kDa proteins, as well as determined the C and N terminal amino acid residues (74).

Differences in the isolation and purification processes could be the reason why different investigators obtained different results in the identification of the protein responsible for increasing nerve growth. Varon, using gel filtration, identified the parent

protein which causes enhanced nerve growth as a large protein with a mass of 140 kDa (85). This large molecule is then split into three separate subunits, α , β , and γ , with the β -subunit containing the nerve growth properties. Other reports indicated the activity of the β -subunit can be enhanced in the presence of the α - and γ -subunits (86). The β -subunit has a sucrose density of 2.5 S.

Although these initial reports provided an initial identification of the protein, it was not until 1971 when Angeletti determined the sequence of the active component of the protein responsible for the enhanced nerve growth (1, 2). Following up on the previous work of Bocchini, who published the first predicted amino acid sequence of the protein in 1970 (12), and Varon, who determined that NGF was composed of three subunits, Angeletti determined the protein composition and amino acid sequence through a series of tryptic, chymotryptic, thermolytic, and peptic digestions of the 2.5 S β -NGF. Angeletti's analysis revealed that the primary NGF protein contained a homodimer of β -NGF with an estimated weight of 26.5 kDa. Each subunit of β -NGF contained 118 amino acids and has an estimated molecular weight of 13.3 kDa, an isoelectric point of 9.3, and three disulfide bonds (1).

The identification of the amino acid sequence allowed researchers to investigate the secondary structure of the NGF protein. Argos suggested initially, based on the amino acid sequence, that NGF existed in an approximately 53 % helix confirmation (4). This was later found to be inaccurate, as Williams et al., using Raman spectroscopy, identified that NGF was mostly a β -sheet, with little to no helix structure (91). The reports that NGF existed in mostly a β -sheet were confirmed when McDonald et al. published the

first crystal structure of NGF, and determined NGF to have three anti-parallel pairs of β -sheets with four loop regions to give a very flat surface (60). McDonald also reported that NGF's structure measured $60 \times 25 \times 15 \text{ \AA}$ with a surface area of $7,229 \text{ \AA}^2$.

β -NGF chromosomal gene location

NGF is secreted as a pre-pro-NGF protein. This pre-pro-protein consists of α -, β -, and γ -subunits with a molecular weight of 130 kDa or 7 S. The initial amino acid sequence for NGF was determined by Angeletti using purified NGF from mouse salivary gland extract (2). Determining the protein structure of NGF allowed researchers to determine the β -NGF's nucleotide sequence. Ullrich et al. utilizing a cDNA cloning approach, found the nucleotide sequence for β -NGF to be highly homologous between the mouse and human and contain a 87 % similarity (81, 82). Scott et al., using NGF mRNA from the mouse submaxillary gland, generated a cDNA probe corresponding to the predicted NGF amino acid sequence (76). Zable et al., using this NGF cDNA clone, identified the chromosomal location of NGF in both the mouse and human, as Axel demonstrated the two species have a high level of gene homology. In the mouse, NGF is located on chromosome 3, and in humans NGF is located on chromosome 1p21-22 (26, 94).

Discovery of other members of the neurotrophin family

Brain-derived neurotrophic factor

Brain-derived neurotrophic factor (BDNF), discovered by Barde et al. in 1982, was the second member of the neurotrophin family to be discovered (8). The initial observation that a second growth factor, other than NGF, could be secreted by cells to promote the growth and survival of neurons occurred in 1978 (9). Cell culture media, when conditioned by C-6 glioma cells, demonstrated the ability to cause an increase in chick embryo sensory ganglia outgrowth similar to that of NGF. This increase in neuronal outgrowth could not be blocked by the addition of an NGF-antibody, and suggested the glioma cells secreted a substance other than NGF to cause enhanced neuronal outgrowth (9). Using pig brain to isolate and purify the new growth factor revealed the presence of a monomer with an initial estimated molecular weight of 12.3 kDa. This molecule was determined, again, to not be NGF by the inability of NGF-antibodies to block the biological activity of the growth factor as well as the inability to detect NGF in the purified protein sample. Further investigation into the structure, amino acid homology (50 %), and amino acid length (NGF 118 base pairs, BDNF 112 base pairs) revealed BDNF to be very similar to NGF. They each contain three disulfide bridges which contribute to their biological activity, and they have a similar tertiary structure (33, 47). Although there is a high level of homology between NGF and BDNF, their genomic locations vary, with NGF located in humans on chromosome 1 p21-22 and in mice on chromosome 3 11 (26, 94), and BDNF located in the human on the human chromosome 11 p13 and on chromosome 2 in the mouse (57).

Neurotrophin-3

The third member of the neurotrophin family, neurotrophin-3 (NT-3), was discovered by Hohn et al. in 1990. Recognizing that the work done by Leibrock et al. in 1989 demonstrated how similar NGF and BDNF were in structure and function, Hohn proposed that because of the similarities these two proteins had belong to a similar class. To investigate if there were other members of this family, he compared the sequences of NGF and BDNF and found two stretches of six amino acids were conserved in each protein. Generating oligonucleotide primers based on the two sequences, Hohn used polymerase chain reaction (PCR) to amplify a mouse genomic template. The result from this experiment was the discovery of a 119 amino acid long protein, termed NT-3 (33). Again, this neurotrophin shares similar features with NGF and BDNF. The amino acid sequences between the three proteins are 50% conserved, which included the three disulfide bonds formed by six highly conserved cysteine residues. There were also four variable regions identified in NGF, BDNF, and NT-3 that consist of seven to eleven amino acids responsible for some of their specific characteristics (33). There is also a difference in the calculated isoelectric points for each of the proteins compared to NGF (11.4), BDNF (5.1), and NT-3 (9.0) (7). NT-3 is located in humans on chromosome 12p13 and in the mouse on chromosome 6 (67).

Neurotrophin-4/5

The last member of the neurotrophin was discovered by Hallbook et al. in and Berkemeier et al. in 1991 (10, 29). Because the discovery of these proteins occurred at relatively the same time, each researcher gave their discovered protein a unique name.

Hallbook, who published his findings first, termed the new protein neurotrophin-4, while Berkemeier, who acknowledges Hallbook's work in his own findings, believed he identified a different neurotrophin and termed it neurotrophin-5. Berkemeier does acknowledge that the only difference in NT-4 and NT-5 is the tissue distribution, but this would later result in the neurotrophin being referred to as neurotrophin-4/5 (NT-4/5). Again, these proteins were discovered utilizing the known structures of the previously discovered neurotrophins, and oligonucleotide primers were constructed and used in PCR amplification of various species to study the distribution of these neurotrophins. Data generated from viper and *Xenopus* DNA fragments revealed the presence of a new sequence which was then confirmed in a host of other species, including humans (29, 35). The new sequence was highly conserved in comparison to the other three neurotrophins with a 50-60 % amino acid homology, and it also contained the three characteristic cysteine disulfide bonds. The NT-4/5 protein is also secreted as a larger pro-protein, and then cleaved into the 123 amino acid long mature active protein which has been shown to enhanced outgrowth of dorsal root ganglia (29). In humans, the gene for NT-4/5 is located on chromosome 19 q13.3 (35).

Neurotrophin receptor family

Introduction

The four members of the neurotrophin family, NGF, BDNF, NT-3, and NT-4/5, are secreted proteins which elicit their effects on their target cells through a high affinity tyrosine kinase named tropomyosin-related kinase receptor, referred to as trk, and a low

affinity tumor necrosis factor (TNF) receptor, referred to as p75^{NTR}. There have been three members of the trk family discovered, trkA, trkB, and trkC, and all of the members of the neurotrophin family bind specifically to their corresponding trk receptor. All members of the neurotrophin family bind nonspecifically to p75^{NTR}. The discovery of these receptors came long after the initial discovery of NGF, but since their discovery a lot of work has been done to characterize their function and intracellular signaling pathways triggered by neurotrophins.

Discovery of the neurotrophin receptor(s)

The initial publication by Bueker et al. in 1947 (15) reported that a mouse sarcoma tumor produced an agent that increased nerve growth. This was followed by the discovery of NGF in the late 1950's by Levi-Montalcini et al. with the final protein sequence determined in 1971 by Angeletti et al. (1). Once the protein sequence was determined, it allowed researchers to start to identify the other members of the neurotrophin family and the receptors responsible for regulating their effects on the cell. The first receptor studies were conducted by Banerjee et al. (6). Using ¹²⁵I-labeled NGF and rabbit superior cervical ganglia, the NGF receptor was found to reside in the membrane fraction of ganglia homogenates. This binding was inhibited by increasing levels of nonradioactive NGF but not by other hormones, including epidermal growth factor (EGF), proinsulin, and insulin, which indicated the receptor was specific for NGF. The interaction between NGF and the NGF receptor is also dependent on the presence of Ca²⁺, with maximal NGF binding occurring in the presence of 5 mM Ca²⁺ (5). Binding

was also determined to be saturable at 0.2 nM NGF as reported by Banerjee et al., or 30-50 ng/ml NGF as reported by Herrup et al. (6, 32). Frazier et al. demonstrated that peripheral neurons and organs contained receptors specific for NGF on their cell surfaces (27, 28). The binding kinetic data generated from these initial experiments suggested the existence of only one membrane bound receptor for NGF.

Later work would support the idea that two different receptors for NGF exist (46, 73, 79, 80). Sutter et al., using 8-day old chick sensory ganglia, demonstrated two saturable binding sites for radiolabeled ^{125}I -NGF with unique binding affinities representing a high affinity receptor with a dissociation constant (K_d) value of 2.3×10^{-11} and a low affinity receptor with a K_d of 1.7×10^{-9} (80).

trkA

Martin-Zanca et al. published the initial molecular characterization of trkA in 1986, which was a result of an investigation of an up-regulated proto-oncogene isolated from a colon carcinoma biopsy (58, 59). The trkA protein was composed of 790 amino acids and determined to have a molecular weight of 110 kDa, and, in humans, the gene which encodes trkA resides on chromosome 1q21-11 (88). The trkA protein undergoes a series of glycosylation steps in which it is predicted to be glycosylated while in the endoplasmic reticulum and then again when it is transported to the cell membrane. Only the glycosylated mature protein, with a molecular weight of 140 kDa, is incorporated into the plasma membrane. The protein also contains an intracellular tyrosine kinase domain which shares high homology with other tyrosine kinase receptors (59). The extracellular

domain contains 24 cysteine residues, similar to that of other cell surface receptors, such as the EGF receptor, EGFR (37).

trkA neurotrophin binding

Kaplan et al. first reported that NGF specifically activates trkA receptors in PC12 cells (40). The activation and phosphorylation of the trkA receptor was demonstrated to be specific for NGF, as other factors which stimulate other members of the tyrosine kinase family did not activate the trkA receptor. The addition of NGF to PC12 cells resulted in activation of the trkA receptor within 1 min, with a maximum activation occurring at 5 min post-exposure. This activation also occurred at physiologic concentrations of NGF, and demonstrated a half-maximum activation in the presence of 0.1 ng/ml NGF (39, 40). Klein et al. demonstrated that NGF bound specifically to the trkA receptor and not to the other members of the trk family (42). Although the work conducted by Sutter et al. demonstrated the presence of two different receptors with notably different binding affinities, Meakin et al. was the first to term the trkA receptor the high-affinity receptor (61, 62). This high affinity receptor, trkA, binds NGF for a longer duration than the low affinity receptor, p75^{NTR} (84).

Once NGF binds to the trkA receptor, the NGF-trkA complex is rapidly internalized (72). Because topology is conserved when the NGF-trkA complex is internalized into vesicles, the activated tyrosines, located on the intracellular region of the trkA receptor, continue to activate intracellular signaling cascades, and the trafficking of

the intracellular vesicle determines the intracellular signaling pathway to be activated (34).

trkB

The second member of the trk family, trkB, was identified by Klein et al. in 1989 (44, 63). Using probes to investigate the distribution of RNA for trk in different cell types, Klein obtained different results from those of Martin-Zanca, who published the first reports of trkA. The differences in the results lead to the generation of trk-specific DNA probes, and revealed the presence of a gene which was related to but distinct from the trkA receptor initially discovered. This new trk receptor was termed trkB. trkB was shown to have high levels of homology with that of trkA, with 57 % homology in the extracellular domain and 88 % homology in the catalytic domain. The glycosylated molecular weight of trkB (145 kDa) is very similar to that of trkA (140 kDa).

trkB neurotrophin binding

Cordon-Cardo et al. co-transfected NIH 3T3 cells with a plasmid containing the NGF gene and a plasmid containing the trkA gene, and demonstrated that NGF, acting through the trkA receptor, had a mitogenic effect on the cells and also caused the cells to become morphologically transformed (23). Kline et al. used this technique to investigate the binding of neurotrophins to the trkB receptor, and co-transfected NIH 3T3 cells with a plasmid containing trkB and a plasmid containing either NGF, BDNF, or NT3 (43). The results demonstrated that cells transfected with NGF and trkB did not cause any level of

cellular transformation, but cells containing trkB with either BDNF or NT-3 had a high level of transforming activity. Later, NT-4/5 was also demonstrated to bind and elicit its signaling effects on the cell through trkB (92).

trkC

The last member of the trk family, trkC was identified and characterized by Lamballe et al. (45). This receptor was discovered through screening porcine brain DNA with probes which were generated using the catalytic domain of trkA. The cDNA which hybridized with the probes used to screen the porcine brain did not hybridize with probes corresponding to regions of trkA or trkB cDNA, indicating that this was a different trk receptor, which they names trkC. The protein sequence of trkC is very similar and shares a high level of homology with that of trkA, 67 %, and trkB, 68 %, with the extracellular domain having a 54 % homology with trkA and 53 % homology with trkB. The external domain of trkC also contains several of the highly conserved cysteine residues. The catalytic domain of trkC shares an 87 % homology with trkA and 88 % homology with trkB. The glycosylated trkC protein had an identical molecular weight as trkB, 145 kDa (45).

trkC neurotrophin binding

Lamballe et al. also investigated the neurotrophins which bind to trkC (45). Using NIH 3T3 cells which were transfected with a plasmid containing the trkC gene, cells

were incubated with ^{125}I -labeled NGF, BDNF, or NT-3. Only NT-3 demonstrated binding to the cells, which was inhibited by non-labeled NT-3.

p75^{NTR}

The possibility that NGF had multiple receptors was initially suggested when Sutter et al. (80) demonstrated that NGF bound to two sites, which had binding affinities that differed by 2 log-orders. Vale et al. demonstrated that NGFs association with the low affinity receptor, p75^{NTR}, was significantly shorter than that of the high affinity receptor, trkA, and thus, at the time, termed it the fast NGF receptor (NGFR) (80, 84). Radeke et al., by generating a probe specific for the NGFR receptor, was able to generate complementary DNA to the NGFR allowing the molecular sequence and structure of p75^{NTR} to be determined (69). The mature p75^{NTR} receptor is composed of 396 amino-acid residues and has a molecular weight of 42.5 kDa. The receptors extracellular domain is composed of 222 amino-acids and contains several repeating cysteine regions similar to that of trkA, a single transmembrane domain composed of 24 amino-acid residues, and a intracellular domain containing 151 amino-acid residues.

p75^{NTR} neurotrophin binding and intracellular signaling pathways

Unlike the trk receptors, trkA, trkB, and trkC, which demonstrate neurotrophin binding specificity, the p75^{NTR} binds non-specifically to all members of the neurotrophin family with almost equal affinity but different binding kinetics (13). Although the trk receptors activate signaling pathways responsible for growth, differentiation, and

survival, there is a large body of work that supports the view that p75^{NTR} is responsible for enhancing trk activation. This was first suggested when Choa demonstrated that neurotrophin binding was increased in cells expressing both trk and p75^{NTR}, and this binding was reduced in the presence of the trk receptor only, suggesting that cooperation existed between the two receptors (17). This was also demonstrated by Verdi et al. using sympathoadrenal cells containing trkA alone or trkA with p75^{NTR}, and cells which contained both receptors had an 8-fold higher activation in trkA activation as compared to cells which contained only trkA (87).

The crystal structure for p75^{NTR} bound to NGF reveals a 2:1 NGF:p75^{NTR} complex, which is different from the reported 2:2 ratio of NGF:trkA binding (31, 90). This binding ratio suggests that the homodimer of β -NGF binds with one p75^{NTR} receptor. NGF binds in a parallel fashion with two sites on the p75^{NTR} receptor, termed site I and site II. The first binding site, site I, is near the end of the extracellular domain of the receptor located near the cysteine rich domains 1 and 2, and the second binding site, site II, is located in the region closest to the transmembrane domain on the extracellular domain near the cysteine-rich domains 3 and 4. The high level of conserved amino acid regions between all of the neurotrophins suggests these regions are highly conserved. Although p75^{NTR} binds to one of the NGF dimers, the binding results in structural changes in the second NGF dimer. Because p75^{NTR} is a rigid receptor, structural changes in NGF, which occur once the homodimer is bound, prevents binding to a second p75^{NTR} receptor. The availability of a second NGF dimer could explain the notion that p75^{NTR} affects trkA binding to NGF, and this complex would allow the trimolecule of NGF,

trkA, and p75^{NTR} to form. This trimolecule binding could explain the complex signaling pathways documented which result after NGF binding.

The activation of the p75^{NTR} by neurotrophins can result in the activation of either prosurvival intracellular signaling pathways, such as NF- κ B and Akt, proapoptotic intracellular signaling pathways, including Jun, Jnk, sphingolipid turnover, neuropeptide receptor-interacting MAGE homolog (NRAGE) and p75^{NTR}-associated nerve death executor (NADE), or activate signaling pathways responsible for cellular growth and motility, including the Rac and Rho pathways (30, 38, 66, 70, 71, 89, 93). The activation of the p75^{NTR} pro-apoptotic signaling pathways has been shown to be regulated by trk receptor signaling, specifically trk-mediated activation of Raf and Akt, to promote neurotrophic prosurvival and pro-differentiation effects (64). Upon NGF binding the NGF-p75^{NGF} complex is not internalized as occurs when NGF binds to trkA (11, 77).

trk structure and intracellular signaling pathways

The extracellular domain of the trk receptor family, trkA, trkB, and trkC, is responsible for the binding its corresponding neurotrophin to result in the activation of the receptor and, therefore, activates several intracellular signaling cascades which allows cells to respond to their extracellular environment. The trk receptors extracellular domain is very unique in comparison to other members of the tyrosine kinase family of receptors, and is composed of two cysteine-rich domains separated by a region of three leucine-rich regions followed by two C2-type immunoglobulin (Ig-C2)-like domains before a single transmembrane domain and an intracellular domain, which is structurally similar to other

members of the receptor tyrosine kinase family (34, 75). As mentioned above, the trk family receptors display specific binding to their respective neurotrophins, with NGF specifically binding and activating the trkA receptor. This specificity results primarily from differences in the major neurotrophin binding domain 5, Ig-C2 (68, 83), but can also be mediated partially by the cysteine-rich domains (3). The trkA immunoglobulin domain 5, alone, has been shown to bind to NGF with similar binding affinities to that of the native receptor (90)

Jing et al. demonstrated that once NGF binds to trkA, the trkA receptor forms a stable dimer (36). When the kinase domains are brought into close proximity to one another upon dimerization, the contralateral kinase domain auto-phosphorylates tyrosines located at positions Y670, Y674, and Y675, which then leads to the auto-phosphorylation of three tyrosines on the outside kinase domain at positions Y490, Y751, Y785 (40, 65, 78). The negatively charged phosphorylated tyrosines on the outside region of the kinase domain generate docking sites for adaptor proteins containing basic residues, such as PTB and SH2 domains (25). Phosphorylated Y490 recruits and binds Shc and fibroblast growth factor receptor substrate 2 (Frs2) resulting to activate the downstream signaling pathways Ras-Raf-Erk and PI3-kinase-Akt. Phosphorylated Y785 activates the PLC- γ and the PKC pathways (41, 56, 78). The activation of these pathways results primarily in cell survival and differentiation.

1. **Angeletti RH and Bradshaw RA.** Nerve growth factor from mouse submaxillary gland: amino acid sequence. *Proc Natl Acad Sci U S A* 68: 2417-2420, 1971.
2. **Angeletti RH, Bradshaw RA, and Wade RD.** Subunit structure and amino acid composition of mouse submaxillary gland nerve growth factor. *Biochemistry* 10: 463-469, 1971.
3. **Arevalo JC, Conde B, Hempstead BI, Chao MV, Martin-Zanca D, and Perez P.** A novel mutation within the extracellular domain of TrkA causes constitutive receptor activation. *Oncogene* 20: 1229-1234, 2001.
4. **Argos P.** Prediction of the secondary structure of mouse nerve growth factor and its comparison with insulin. *Biochem Biophys Res Commun* 70: 805-811, 1976.
5. **Banerjee SP, Cuatrecasas P, and Snyder SH.** Nerve growth factor receptor binding. Influence of enzymes, ions, and protein reagents. *J Biol Chem* 250: 1427-1433, 1975.
6. **Banerjee SP, Snyder SH, Cuatrecasas P, and Greene LA.** Binding of nerve growth factor receptor in sympathetic ganglia. *Proc Natl Acad Sci U S A* 70: 2519-2523, 1973.
7. **Barde YA.** The nerve growth factor family. *Prog Growth Factor Res* 2: 237-248, 1990.
8. **Barde YA, Edgar D, and Thoenen H.** Purification of a new neurotrophic factor from mammalian brain. *EMBO J* 1: 549-553, 1982.

9. **Barde YA, Lindsay RM, Monard D, and Thoenen H.** New factor released by cultured glioma cells supporting survival and growth of sensory neurones. *Nature* 274: 818, 1978.
10. **Berkemeier LR, Winslow JW, Kaplan DR, Nikolics K, Goeddel DV, and Rosenthal A.** Neurotrophin-5: a novel neurotrophic factor that activates trk and trkB. *Neuron* 7: 857-866, 1991.
11. **Bernd P and Greene LA.** Association of 125I-nerve growth factor with PC12 pheochromocytoma cells. Evidence for internalization via high-affinity receptors only and for long-term regulation by nerve growth factor of both high- and low-affinity receptors. *J Biol Chem* 259: 15509-15516, 1984.
12. **Bocchini V.** The nerve growth factor. Amino acid composition and physicochemical properties. *Eur J Biochem* 15: 127-131, 1970.
13. **Bothwell M.** Functional interactions of neurotrophins and neurotrophin receptors. *Annu Rev Neurosci* 18: 223-253, 1995.
14. **Bueker ED.** Implantation of tumors in the hind limb field of the embryonic chick and the developmental response of the lumbosacral nervous system. *Anat Rec* 102: 369-389, 1948.
15. **Bueker ED and Belkin M.** Growth of the lumbosacral nervous system of chick embryos after the substitution of tumors for the limb periphery. *Anat Rec* 97: 323, 1947.
16. **Chao MV.** A conversation with Rita Levi-Montalcini. *Annu Rev Physiol* 72: 1-13, 2010.
17. **Chao MV.** The p75 neurotrophin receptor. *J Neurobiol* 25: 1373-1385, 1994.

18. **Cohen S.** Purification and metabolic effects of a nerve growth-promoting protein from snake venom. *J Biol Chem* 234: 1129-1137, 1959.
19. **Cohen S.** Purification of a nerve-growth promoting protein from the mouse salivary gland and its neuro-cytotoxic antiserum. *Proc Natl Acad Sci U S A* 46: 302-311, 1960.
20. **Cohen S and Levi-Montalcini R.** A nerve growth-stimulating factor isolated from snake venom. *Proc Natl Acad Sci U S A* 42: 571-574, 1956.
21. **Cohen S and Levi-Montalcini R.** Purification and properties of a nerve growth-promoting factor isolated from mouse sarcoma 180. *Cancer Res* 17: 15-20, 1957.
22. **Cohen S, Levi-Montalcini R, and Hamburger V.** A nerve growth-stimulating factor isolated from sarcoma 37 and 180. *Proc Natl Acad Sci U S A* 40: 1014-1018, 1954.
23. **Cordon-Cardo C, Tapley P, Jing SQ, Nanduri V, O'Rourke E, Lamballe F, Kovary K, Klein R, Jones KR, Reichardt LF, and et al.** The trk tyrosine protein kinase mediates the mitogenic properties of nerve growth factor and neurotrophin-3. *Cell* 66: 173-183, 1991.
24. **Cowan WM.** Viktor Hamburger and Rita Levi-Montalcini: the path to the discovery of nerve growth factor. *Annu Rev Neurosci* 24: 551-600, 2001.
25. **Cunningham ME and Greene LA.** A function-structure model for NGF-activated TRK. *EMBO J* 17: 7282-7293, 1998.

26. **Francke U, de Martinville B, Coussens L, and Ullrich A.** The human gene for the beta subunit of nerve growth factor is located on the proximal short arm of chromosome 1. *Science* 222: 1248-1251, 1983.
27. **Frazier WA, Boyd LF, and Bradshaw RA.** Properties of the specific binding of ¹²⁵I-nerve growth factor to responsive peripheral neurons. *J Biol Chem* 249: 5513-5519, 1974.
28. **Frazier WA, Boyd LF, Szutowicz A, Pulliam MW, and Bradshaw RA.** Specific binding sites for ¹²⁵I-nerve growth factor in peripheral tissues and brain. *Biochem Biophys Res Commun* 57: 1096-1103, 1974.
29. **Hallbook F, Ibanez CF, and Persson H.** Evolutionary studies of the nerve growth factor family reveal a novel member abundantly expressed in *Xenopus* ovary. *Neuron* 6: 845-858, 1991.
30. **Harrington AW, Kim JY, and Yoon SO.** Activation of Rac GTPase by p75 is necessary for c-jun N-terminal kinase-mediated apoptosis. *J Neurosci* 22: 156-166, 2002.
31. **He XL and Garcia KC.** Structure of nerve growth factor complexed with the shared neurotrophin receptor p75. *Science* 304: 870-875, 2004.
32. **Herrup K and Shooter EM.** Properties of the beta nerve growth factor receptor of avian dorsal root ganglia. *Proc Natl Acad Sci U S A* 70: 3884-3888, 1973.
33. **Hohn A, Leibrock J, Bailey K, and Barde YA.** Identification and characterization of a novel member of the nerve growth factor/brain-derived neurotrophic factor family. *Nature* 344: 339-341, 1990.

34. **Huang EJ and Reichardt LF.** Trk receptors: roles in neuronal signal transduction. *Annu Rev Biochem* 72: 609-642, 2003.
35. **Ip NY, Ibanez CF, Nye SH, McClain J, Jones PF, Gies DR, Belluscio L, Le Beau MM, Espinosa R, 3rd, Squinto SP, and et al.** Mammalian neurotrophin-4: structure, chromosomal localization, tissue distribution, and receptor specificity. *Proc Natl Acad Sci U S A* 89: 3060-3064, 1992.
36. **Jing S, Tapley P, and Barbacid M.** Nerve growth factor mediates signal transduction through trk homodimer receptors. *Neuron* 9: 1067-1079, 1992.
37. **Johnson D, Lanahan A, Buck CR, Sehgal A, Morgan C, Mercer E, Bothwell M, and Chao M.** Expression and structure of the human NGF receptor. *Cell* 47: 545-554, 1986.
38. **Jordan BW, Dinev D, LeMellay V, Troppmair J, Gotz R, Wixler L, Sendtner M, Ludwig S, and Rapp UR.** Neurotrophin receptor-interacting mage homologue is an inducible inhibitor of apoptosis protein-interacting protein that augments cell death. *J Biol Chem* 276: 39,985-39,989, 2001.
39. **Kaplan DR, Hempstead BL, Martin-Zanca D, Chao MV, and Parada LF.** The trk proto-oncogene product: a signal transducing receptor for nerve growth factor. *Science* 252: 554-558, 1991.
40. **Kaplan DR, Martin-Zanca D, and Parada LF.** Tyrosine phosphorylation and tyrosine kinase activity of the trk proto-oncogene product induced by NGF. *Nature* 350: 158-160, 1991.

41. **Kaplan DR and Miller FD.** Neurotrophin signal transduction in the nervous system. *Curr Opin Neurobiol* 10: 381-391, 2000.
42. **Klein R, Jing SQ, Nanduri V, O'Rourke E, and Barbacid M.** The trk proto-oncogene encodes a receptor for nerve growth factor. *Cell* 65: 189-197, 1991.
43. **Klein R, Nanduri V, Jing SA, Lamballe F, Tapley P, Bryant S, Cordon-Cardo C, Jones KR, Reichardt LF, and Barbacid M.** The trkB tyrosine protein kinase is a receptor for brain-derived neurotrophic factor and neurotrophin-3. *Cell* 66: 395-403, 1991.
44. **Klein R, Parada LF, Coulier F, and Barbacid M.** trkB, a novel tyrosine protein kinase receptor expressed during mouse neural development. *EMBO J* 8: 3701-3709, 1989.
45. **Lamballe F, Klein R, and Barbacid M.** trkC, a new member of the trk family of tyrosine protein kinases, is a receptor for neurotrophin-3. *Cell* 66: 967-979, 1991.
46. **Landreth GE and Shooter EM.** Nerve growth factor receptors on PC12 cells: ligand-induced conversion from low- to high-affinity states. *Proc Natl Acad Sci U S A* 77: 4751-4755, 1980.
47. **Leibrock J, Lottspeich F, Hohn A, Hofer M, Hengerer B, Masiakowski P, Thoenen H, and Barde YA.** Molecular cloning and expression of brain-derived neurotrophic factor. *Nature* 341: 149-152, 1989.
48. **Levi-Montalcini R.** Effects of mouse tumor transplantation on the nervous system. *Ann N Y Acad Sci* 55: 330-344, 1952.

49. **Levi-Montalcini R and Booker B.** Destruction of the sympathetic ganglia in mammals by an antiserum to a nerve-growth protein. *Proc Natl Acad Sci U S A* 46: 384-391, 1960.
50. **Levi-Montalcini R and Booker B.** Excessive growth of the sympathetic ganglia evoked by a protein isolated from mouse salivary glands. *Proc Natl Acad Sci U S A* 46: 373-384, 1960.
51. **Levi-Montalcini R and Cohen S.** Effects of the extract of the mouse submaxillary salivary glands on the sympathetic system of mammals. *Ann N Y Acad Sci* 85: 324-341, 1960.
52. **Levi-Montalcini R and Cohen S.** In vitro and in vivo effects of a nerve growth-stimulating agent isolated from snake venom. *Proc Natl Acad Sci U S A* 42: 695-699, 1956.
53. **Levi-Montalcini R and Hamburger V.** Selective growth stimulating effects of mouse sarcoma on the sensory and sympathetic nervous system of the chick embryo. *J Exp Zool* 116: 321-361, 1951.
54. **Levi-Montalcini R, Knight RA, Nicotera P, Nistico G, Bazan N, and Melino G.** Rita's 102!! *Mol Neurobiol* 43: 77-79, 2011.
55. **Levi-Montalcini R, Meyer H, and Hamburger V.** In vitro experiments on the effects of mouse sarcomas 180 and 37 on the spinal and sympathetic ganglia of the chick embryo. *Cancer Res* 14: 49-57, 1954.
56. **Loeb DM, Stephens RM, Copeland T, Kaplan DR, and Greene LA.** A Trk nerve growth factor (NGF) receptor point mutation affecting interaction with

phospholipase C-gamma 1 abolishes NGF-promoted peripherin induction but not neurite outgrowth. *J Biol Chem* 269: 8901-8910, 1994.

57. **Mariman EC, van Beersum SE, Cremers CW, Struycken PM, and Ropers HH.** Fine mapping of a putatively imprinted gene for familial non-chromaffin paragangliomas to chromosome 11q13.1: evidence for genetic heterogeneity. *Hum Genet* 95: 56-62, 1995.

58. **Martin-Zanca D, Mitra G, Long LK, and Barbacid M.** Molecular characterization of the human trk oncogene. *Cold Spring Harb Symp Quant Biol* 51 Pt 2: 983-992, 1986.

59. **Martin-Zanca D, Oskam R, Mitra G, Copeland T, and Barbacid M.** Molecular and biochemical characterization of the human trk proto-oncogene. *Mol Cell Biol* 9: 24-33, 1989.

60. **McDonald NQ, Lapatto R, Murray-Rust J, Gunning J, Wlodawer A, and Blundell TL.** New protein fold revealed by a 2.3-A resolution crystal structure of nerve growth factor. *Nature* 354: 411-414, 1991.

61. **Meakin SO and Shooter EM.** Molecular investigations on the high-affinity nerve growth factor receptor. *Neuron* 6: 153-163, 1991.

62. **Meakin SO and Shooter EM.** Tyrosine kinase activity coupled to the high-affinity nerve growth factor-receptor complex. *Proc Natl Acad Sci U S A* 88: 5862-5866, 1991.

63. **Middlemas DS, Lindberg RA, and Hunter T.** trkB, a neural receptor protein-tyrosine kinase: evidence for a full-length and two truncated receptors. *Mol Cell Biol* 11: 143-153, 1991.
64. **Miller FD and Kaplan DR.** Neurotrophin signalling pathways regulating neuronal apoptosis. *Cell Mol Life Sci* 58: 1045-1053, 2001.
65. **Mitra G.** Mutational analysis of conserved residues in the tyrosine kinase domain of the human trk oncogene. *Oncogene* 6: 2237-2241, 1991.
66. **Mukai J, Hachiya T, Shoji-Hoshino S, Kimura MT, Nadano D, Suvanto P, Hanaoka T, Li Y, Irie S, Greene LA, and Sato TA.** NADE, a p75NTR-associated cell death executor, is involved in signal transduction mediated by the common neurotrophin receptor p75NTR. *J Biol Chem* 275: 17566-17570, 2000.
67. **Ozcelik T, Rosenthal A, and Francke U.** Chromosomal mapping of brain-derived neurotrophic factor and neurotrophin-3 genes in man and mouse. *Genomics* 10: 569-575, 1991.
68. **Perez P, Coll PM, Hempstead BL, Martin-Zanca D, and Chao MV.** NGF binding to the trk tyrosine kinase receptor requires the extracellular immunoglobulin-like domains. *Mol Cell Neurosci* 6: 97-105, 1995.
69. **Radeke MJ, Misko TP, Hsu C, Herzenberg LA, and Shooter EM.** Gene transfer and molecular cloning of the rat nerve growth factor receptor. *Nature* 325: 593-597, 1987.

70. **Roux PP, Bhakar AL, Kennedy TE, and Barker PA.** The p75 neurotrophin receptor activates Akt (protein kinase B) through a phosphatidylinositol 3-kinase-dependent pathway. *J Biol Chem* 276: 23097-23104, 2001.
71. **Salehi AH, Roux PP, Kubu CJ, Zeindler C, Bhakar A, Tannis LL, Verdi JM, and Barker PA.** NRAGE, a novel MAGE protein, interacts with the p75 neurotrophin receptor and facilitates nerve growth factor-dependent apoptosis. *Neuron* 27: 279-288, 2000.
72. **Saragovi HU, Zheng W, Maliartchouk S, DiGuglielmo GM, Mawal YR, Kamen A, Woo SB, Cuello AC, Debeir T, and Neet KE.** A TrkA-selective, fast internalizing nerve growth factor-antibody complex induces trophic but not neuritogenic signals. *J Biol Chem* 273: 34933-34940, 1998.
73. **Schechter AL and Bothwell MA.** Nerve growth factor receptors on PC12 cells: evidence for two receptor classes with differing cytoskeletal association. *Cell* 24: 867-874, 1981.
74. **Schenkein I and Bueker ED.** Dialyzable cofactor in nerve growth promoting protein from mouse salivary glands. *Science* 137: 433-434, 1962.
75. **Schneider R and Schweiger M.** A novel modular mosaic of cell adhesion motifs in the extracellular domains of the neurogenic trk and trkB tyrosine kinase receptors. *Oncogene* 6: 1807-1811, 1991.
76. **Scott J, Selby M, Urdea M, Quiroga M, Bell GI, and Rutter WJ.** Isolation and nucleotide sequence of a cDNA encoding the precursor of mouse nerve growth factor. *Nature* 302: 538-540, 1983.

77. **Shooter EM, Yankner BA, Landreth GE, and Sutter A.** Biosynthesis and mechanism of action of nerve growth factor. *Recent Prog Horm Res* 37: 417-446, 1981.
78. **Stephens RM, Loeb DM, Copeland TD, Pawson T, Greene LA, and Kaplan DR.** Trk receptors use redundant signal transduction pathways involving SHC and PLC-gamma 1 to mediate NGF responses. *Neuron* 12: 691-705, 1994.
79. **Sutter A, Riopelle RJ, Harris-Warrick RM, and Shooter EM.** The heterogeneity of nerve growth factor receptors. *Prog Clin Biol Res* 31: 659-667, 1979.
80. **Sutter A, Riopelle RJ, Harris-Warrick RM, and Shooter EM.** Nerve growth factor receptors. Characterization of two distinct classes of binding sites on chick embryo sensory ganglia cells. *J Biol Chem* 254: 5972-5982, 1979.
81. **Ullrich A, Gray A, Berman C, Coussens L, and Dull TJ.** Sequence homology of human and mouse beta-NGF subunit genes. *Cold Spring Harb Symp Quant Biol* 48 Pt 1: 435-442, 1983.
82. **Ullrich A, Gray A, Berman C, and Dull TJ.** Human beta-nerve growth factor gene sequence highly homologous to that of mouse. *Nature* 303: 821-825, 1983.
83. **Ultsch MH, Wiesmann C, Simmons LC, Henrich J, Yang M, Reilly D, Bass SH, and de Vos AM.** Crystal structures of the neurotrophin-binding domain of TrkA, TrkB and TrkC. *J Mol Biol* 290: 149-159, 1999.
84. **Vale RD and Shooter EM.** Assaying binding of nerve growth factor to cell surface receptors. *Methods Enzymol* 109: 21-39, 1985.
85. **Varon S, Nomura J, and Shooter EM.** The isolation of the mouse nerve growth factor protein in a high molecular weight form. *Biochemistry* 6: 2202-2209, 1967.

86. **Varon S, Nomura J, and Shooter EM.** Subunit structure of a high-molecular-weight form of the nerve growth factor from mouse submaxillary gland. *Proc Natl Acad Sci U S A* 57: 1782-1789, 1967.
87. **Verdi JM, Birren SJ, Ibanez CF, Persson H, Kaplan DR, Benedetti M, Chao MV, and Anderson DJ.** p75LNGFR regulates Trk signal transduction and NGF-induced neuronal differentiation in MAH cells. *Neuron* 12: 733-745, 1994.
88. **Weier HU, Rhein AP, Shadravan F, Collins C, and Polikoff D.** Rapid physical mapping of the human trk protooncogene (NTRK1) to human chromosome 1q21-q22 by P1 clone selection, fluorescence in situ hybridization (FISH), and computer-assisted microscopy. *Genomics* 26: 390-393, 1995.
89. **Whitfield J, Neame SJ, Paquet L, Bernard O, and Ham J.** Dominant-negative c-Jun promotes neuronal survival by reducing BIM expression and inhibiting mitochondrial cytochrome c release. *Neuron* 29: 629-643, 2001.
90. **Wiesmann C, Ultsch MH, Bass SH, and de Vos AM.** Crystal structure of nerve growth factor in complex with the ligand-binding domain of the TrkA receptor. *Nature* 401: 184-188, 1999.
91. **Williams R, Gaber B, and Gunning J.** Raman spectroscopic determination of the secondary structure of crystalline nerve growth factor. *J Biol Chem* 257: 13321-13323, 1982.
92. **Wong V, Arriaga R, Ip NY, and Lindsay RM.** The neurotrophins BDNF, NT-3 and NT-4/5, but not NGF, up-regulate the cholinergic phenotype of developing motor neurons. *Eur J Neurosci* 5: 466-474, 1993.

93. **Wooten MW, Seibenhener ML, Mamidipudi V, Diaz-Meco MT, Barker PA, and Moscat J.** The atypical protein kinase C-interacting protein p62 is a scaffold for NF- κ B activation by nerve growth factor. *J Biol Chem* 276: 7709-7712, 2001.
94. **Zabel BU, Eddy RL, Lalley PA, Scott J, Bell GI, and Shows TB.** Chromosomal locations of the human and mouse genes for precursors of epidermal growth factor and the beta subunit of nerve growth factor. *Proc Natl Acad Sci U S A* 82: 469-473, 1985.

Chapter 2

NGF and Lung Disease

Introduction

NGF was discovered for its ability to enhance nerve growth, but recent findings suggests a correlation between elevated levels of NGF in the lung and airway inflammatory diseases. Patients suffering from airway diseases, such as severe asthma, allergic rhinitis, lung cancer, and respiratory virus infections, have an elevated level of NGF in both the lung, as determined by bronchoalveolar lavage (BAL) fluid, and blood (1, 32, 65, 74). In the lungs, NGF can be produced by non-neuronal structural and non-structural cells. These non-neuronal cells express both the high affinity, trkA, and low affinity, p75^{NTR}, receptors allowing them to respond to NGF (59, 60). Elevated levels of NGF in the lung and blood are associated with bronchial hyperresponsiveness and inflammation in both humans and animals (21, 23, 42, 43). These findings suggest that the overexpression of NGF in the lung contributes to airway disease progression (16, 17, 20).

Lung function is controlled and regulated through several different cells types, including airway epithelial cells, airway smooth muscle cells, nerve cells, the pulmonary vasculature, and inflammatory cells. Although other neurotrophins, such as BDNF, NT-3, and NT-4/5, and their receptors, trkB and trkC, have also been shown to be elevated during lung disease, this chapter will focus on previous findings regarding NGF-mediated mechanisms that have been demonstrated to alter cellular processes to promote disease progression.

Sources of NGF in the lung

As mentioned above, there is a correlation between respiratory disease and elevated NGF levels in patients' BAL fluid as well as blood. NGF can be produced by and act upon all cells of the airways. NGF has been shown to be produced by and act upon structural cells of the airways, including nerves, epithelial cells, fibroblasts, and smooth muscle cells, and the non-structural cells, such as inflammatory T and B lymphocytes, mast cells, eosinophils, and macrophages (11, 14, 18, 38, 47, 61, 67, 70). These airway cells produce more NGF during airway disease conditions to result in increased concentrations of NGF in the lung and blood. The pro-inflammatory cytokines TNF- α and IL-1 β activate c-fos and c-jun signaling pathways in structural cells of the airways. The activation of this pathway results in the transcription of the NGF gene, and results in enhanced NGF expression (19, 22, 28, 39, 47, 48, 53, 54). NGF expression is elevated in non-structural cells, such as eosinophils in the lung and monocytes in the blood, in diseases such as asthma (44, 64). NGF also acts as a chemoattractant, which causes inflammatory cells to migrate into the lung. Enhanced NGF production by several different cell types of the lung, as well as the increased number of inflammatory cells in the lung associated with lung diseases, would suggest a correlation between NGF levels and pathophysiological alterations observed in lung disease.

NGF and airway epithelial cells

The epithelial cells of the airways have several functions including being the primary barrier against inhaled agents, regulating the airway surface liquid (ASL) levels through ion transport, and mediating airway smooth muscle tone through the release of

factors such as epithelium-derived relaxing factor (EDRF)(13). Epithelial cells have been shown to produce NGF and express the NGF receptors, trkA and p75^{NTR}. Airway epithelial cells, treated with the pro-inflammatory cytokines TNF- α , IL-1 β , and T_H2 cytokines, produce and secrete more NGF as compared to non-treated cells (14, 23). Immunohistochemistry studies of human nasal mucosa has revealed that trkA and p75^{NTR} receptors are polarized in their locations, with trkA located on the apical membrane and p75^{NTR} located on the basolateral membrane (75). Elevated levels of NGF in the lung may function to support the survival of epithelia cells, through trkA-mediated pathways, as well as promote lung repair (49, 68). Mice which are genetically engineered to overexpress NGF have subepithelial thickening, which could contribute to airway remodeling, which is seen in asthmatic patients with advanced disease (30).

The influence of NGF on ion transport in airway epithelial is the focus of the work presented in this dissertation. Because airway epithelial cells can produce and respond to NGF, it is possible that NGF could alter ion transport in these cells. The affects of NGF on ion transport in other cell types will be reviewed later in Chapter three.

NGF and immune cells

Inflammatory cells, such as T and B lymphocytes, mast cells, eosinophils, and basophils, are elevated in the lungs of patients suffering from respiratory diseases, such as respiratory virus infections and asthma (25). Elevated levels of neurotrophins, specifically NGF, are reported in BAL fluid and plasma in patients with asthma, allergic rhinitis, and respiratory virus infections (55, 63, 74). Inflammatory cells, when stimulated

with an allergen trigger, produce and secrete NGF, resulting in elevated NGF levels in the lung and plasma (2, 42, 43). Mast cells release NGF upon IgE cross-linking. Eosinophils produce NGF when treated with NGF or granulocyte-macrophage colony-stimulating factor (GM-CSF), as well, neurotrophin receptor expression is also increased (35, 44, 56, 72). Macrophages, dendritic cells, and T and B lymphocytes produce elevated levels of NGF after an antigen challenge (29, 34, 37, 45, 46). Splenic mononuclear cells from allergen-sensitized mice, which also produce elevated levels of NGF, respond to NGF by secreting IL-4 and IL-5.

NGF has also been shown to enhance eosinophil survival, increase its cytotoxic activity, and result in the expression of CD69 on the cell surface (24, 41). NGF also serves as a chemoattractant for mast cells. NGF, acting through the trkA receptor, activates the MAPK and PI-3 kinase pathway in mast cells promoting migration (66). The ability of structural cells of the airways, such as epithelial cells, to produce NGF and attract inflammatory cells to the lung is a vicious cycle. NGF increases the survival and function of infiltrating inflammatory cells, which, in turn, will enhance NGF production and release by inflammatory cells. This excessive NGF production is manifested in patients' BAL fluid and blood.

NGF and airway innervation

The first publication that suggested that NGF was involved in mediating airway hyperresponsiveness (AHR) was that of Hoyle et al. in 1998 (30). At the time, the focus of this study was not to investigate NGF's involvement in AHR, but, rather, to investigate

the role of the sensory nerve mediator, substance P (SP), in the development of AHR. Hoyle et al. generated a transgenic mouse model in which NGF was overexpressed, specifically in Clara cells of the lung, by inserting the NGF gene after the Clara-cell secretory protein (CCSP) promoter. The increased level of NGF produced resulted in increased innervation of the lung. Mice were treated with 6-hydroxydopamine (6-OHDA) from the time of birth to inhibit the growth of the sympathetic nerves in the airways, but 6-OHDA allowed enhanced sensory nerve innervation to occur. Sensory nerves in mice overexpressing NGF demonstrated increased SP expression. These mice displayed AHR to inhaled capsaicin, which stimulates sensory nerves to release tachykinins. These findings suggest that elevated levels of NGF in the lung could result in neuronal remodeling of the lung, as well as regulate sensory nerve SP expression and release resulting in AHR.

Since the reports above, several other studies have been conducted to investigate the involvement of NGF in the etiology of AHR. Guinea pigs, injected intravenously with NGF, developed AHR to histamine after 30 min and 3 h, but AHR was not observed 24 h post-administration. The AHR could be blocked with a neurokinin-1 receptor antagonist, suggesting that NGF can quickly affect sensory nerves to elevate tachykinin release and cause AHR (9). Tracheal instillation of NGF was also shown to cause increased production of SP by sensory nerves (73). Although SP's ability to initiate AHR was shown to be antagonized by the neurokinin-1 receptor antagonist, SR 140333, electric field stimulation (EFS) of mouse tracheal segments, treated with the anti-NGF-antibody, demonstrated a reduction in reactivity to EFS (2). These reports suggest that

NGF has multiple effects on the nerves of the airways and could stimulate SP production in sensory neurons, enhance the sensitivity of sensory nerves to stimuli, such as EFS, and, as its name implies, enhance nerve growth causing neuronal remodeling of the lung, all of which would result in AHR observed in patients suffering from lung diseases in which NGF is overexpressed.

NGF and airway smooth muscle

There has long been an association between airway smooth muscle (ASM) and airway disease, specifically asthma (51). The amount of ASM present in asthmatics is increased significantly as compared to non-asthmatics, and this increase in ASM is a result of cellular hypertrophy and hyperplasia (7). ASM has been shown to produce NGF and express the *trkA*, but not $p75^{\text{NTR}}$, indicating that ASM is capable of responding to NGF (59). The production of NGF by the ASM is increased in the presence of IL-1 β and INF- γ (33). In human airway smooth muscle cells in culture, NGF increased cell proliferation through a *trkA*-PKC-p38- and a *trkA*-ras/raf-Erk1/2-mediated pathway, indicating that NGF may facilitate airway remodeling of ASM like that observed in asthmatics (15).

NGF and pulmonary vasculature

The lungs, which are highly vascularized, support gas exchange to maintain a proper blood oxygen level. Asthma, chronic obstructive pulmonary disease (COPD), and bronchiectasis are associated with increased vascularization of the bronchial wall (31).

The remodeling of the pulmonary vasculature, through angiogenesis, is prominent in patients who die of asthma and contributes to airway disease pathogenesis, specifically vascular dilation, congestion, and edema, to promote swelling and stiffness of the airway walls (8, 31). The vascular endothelium produce and respond to NGF through the NGF receptors, trkA and p75^{NTR}, and the responses to NGF have been shown to be involved in mediating vascular remodeling associated with airway disease progression (5).

Raychaudhuri et al. reported that NGF could promote endothelial cell proliferation and up-regulate the expression of intercellular adhesion molecule 1 (ICAM-1), a cell surface protein which promotes binding and transmigration of inflammatory cells, in human dermal microvasculature endothelial cells (58). These findings were confirmed in several other types of endothelial cells, including human umbilical vein endothelial cells, (5), human choroidal endothelial cells (69), and rat brain endothelial cells (40). The expression of ICAM-1 could result in enhanced infiltration of inflammatory cells into the lung.

NGF produced by structural and non-structural cells in the lung could play a role in the remodeling of the pulmonary vasculature. NGF has been shown to be a chemoattractant for endothelial cells, and results in endothelial cell migration, which could explain the enhanced vascularization of the airways in asthmatic patients (10, 57). Endothelial cell proliferation due to angiogenesis stimulated by NGF was determined to be mediated by a trkA pathway. The activation of the trkA receptor promoted the expression of vascular endothelial growth factor (VEGF) and activation of VEGF-receptors to promote vascular growth (4, 12, 26).

Vascular dilation has been reported in fatal asthma, and the excessive leakiness of these vesicles could contribute to airway narrowing (8). NGF can up-regulate endothelial cell nitric oxide synthase (eNOS) through a trkA-Akt mediated pathway, which will generate NO and cause vascular dilation (6).

NGF and lung disease

Asthma is an inflammatory disease of the airways, and is characterized by infiltration of inflammatory cells into the lungs, airway obstruction, and AHR. Elevated levels of NGF are reported in asthmatic patients' BAL fluid and blood as compared to non-asthmatics. The ability of NGF to stimulate AHR through increased SP production and enhanced sensory nerve sensitivity to stimuli, to cause subepithelial thickening to reduce airway elasticity, to act as a chemoattractant, to increase the survival of, and increase the cytotoxicity of inflammatory cells, and to affect pulmonary vasculature to cause lung edema, to enhance inflammatory cell migration, and to stimulate angiogenesis, would suggest that NGF is involved intimately in mediating the pathological changes in the lung resulting in disease progression.

Respiratory syncytial virus (RSV) and human rhinovirus (HRV) infections have been shown to increase the expression of NGF in the lungs (50, 71). Exposure to these virus infections early in life, especially in infants less than one year old, can result in long-lasting effects on the lung, such as increasing the probability of developing asthma later in life (27). The lungs undergo development during infancy and it is suspected that a severe RSV infection could cause airway remodeling to give rise to pre-dispose toward

an asthmatic condition later in life. NGF is vital in the development of both central and periphery sensory nerves, and the overexpression of NGF early in life could give rise to changes in nerve innervation and density, function, and development as well as alter inflammatory responses and evoke changes in epithelial ion transport.

The first reports that a nerve growth agent existed came from the work conducted by Bueker et al. in 1947, when he demonstrated that mouse sarcoma tumors, when transplanted intra-embryonically, became highly invaded with nerves (3). Elevated levels of NGF and trkA expression are observed in malignant cancer cells patients suffering from non-small cell lung cancer and small cell lung cancer (62). NGF and trkA have been reported to be overexpressed in several other types of cancers, including esophageal, breast, cervix, and skin cancer, but all of these cancers lacked the p75^{NTR} receptor, which is involved in mediating apoptotic pathways (36). NGF has been shown to increase cellular growth and prolong survival of cultured human lung adenocarcinoma cells (A549) through a trkA-Akt mediated pathway. When cells were first treated with the non-specific tyrosine kinase inhibitor, K-252a, prior to the addition of NGF, cells underwent apoptosis and died (52). Thus, overexpression of the NGF, as well as the lack of the p75^{NTR} receptor, may be important factors in the development of several cancers in the body

1. **Bonini S, Lambiase A, Bonini S, Angelucci F, Magrini L, Manni L, and Aloe L.** Circulating nerve growth factor levels are increased in humans with allergic diseases and asthma. *Proc Natl Acad Sci U S A* 93: 10955-10960, 1996.
2. **Braun A, Appel E, Baruch R, Herz U, Botchkarev V, Paus R, Brodie C, and Renz H.** Role of nerve growth factor in a mouse model of allergic airway inflammation and asthma. *Eur J Immunol* 28: 3240-3251, 1998.
3. **Bueker ED and Belkin M.** Growth of the lumbosacral nervous system of chick embryos after the substitution of tumors for the limb periphery. *Anat Rec* 97: 323, 1947.
4. **Calza L, Giardino L, Giuliani A, Aloe L, and Levi-Montalcini R.** Nerve growth factor control of neuronal expression of angiogenetic and vasoactive factors. *Proc Natl Acad Sci U S A* 98: 4160-4165, 2001.
5. **Cantarella G, Lempereur L, Presta M, Ribatti D, Lombardo G, Lazarovici P, Zappala G, Pafumi C, and Bernardini R.** Nerve growth factor-endothelial cell interaction leads to angiogenesis in vitro and in vivo. *FASEB J* 16: 1307-1309, 2002.
6. **Caporali A and Emanuelli C.** Cardiovascular actions of neurotrophins. *Physiol Rev* 89: 279-308, 2009.
7. **Carroll N, Elliot J, Morton A, and James A.** The structure of large and small airways in nonfatal and fatal asthma. *Am Rev Respir Dis* 147: 405-410, 1993.
8. **Charan NB, Baile EM, and Pare PD.** Bronchial vascular congestion and angiogenesis. *Eur Respir J* 10: 1173-1180, 1997.

9. **de Vries A, Dessing MC, Engels F, Henricks PA, and Nijkamp FP.** Nerve growth factor induces a neurokinin-1 receptor- mediated airway hyperresponsiveness in guinea pigs. *Am J Respir Crit Care Med* 159: 1541-1544, 1999.
10. **Dolle JP, Rezvan A, Allen FD, Lazarovici P, and Lelkes PI.** Nerve growth factor-induced migration of endothelial cells. *J Pharmacol Exp Ther* 315: 1220-1227, 2005.
11. **Ehrhard PB, Erb P, Graumann U, and Otten U.** Expression of nerve growth factor and nerve growth factor receptor tyrosine kinase Trk in activated CD4-positive T-cell clones. *Proc Natl Acad Sci U S A* 90: 10984-10988, 1993.
12. **Emanueli C, Salis MB, Pinna A, Graiani G, Manni L, and Madeddu P.** Nerve growth factor promotes angiogenesis and arteriogenesis in ischemic hindlimbs. *Circulation* 106: 2257-2262, 2002.
13. **Fedan JS, Dowdy JA, Johnston RA, and Van Scott MR.** Hyperosmolar solution effects in guinea pig airways. I. Mechanical responses to relative changes in osmolarity. *J Pharmacol Exp Ther* 308: 10-18, 2004.
14. **Fox AJ, Patel HJ, Barnes PJ, and Belvisi MG.** Release of nerve growth factor by human pulmonary epithelial cells: role in airway inflammatory diseases. *Eur J Pharmacol* 424: 159-162, 2001.
15. **Freund-Michel V, Bertrand C, and Frossard N.** TrkA signalling pathways in human airway smooth muscle cell proliferation. *Cell Signal* 18: 621-627, 2006.
16. **Freund-Michel V and Frossard N.** The nerve growth factor and its receptors in airway inflammatory diseases. *Pharmacol Ther* 117: 52-76, 2008.

17. **Freund V and Frossard N.** Expression of nerve growth factor in the airways and its possible role in asthma. *Prog Brain Res* 146: 335-346, 2004.
18. **Freund V, Pons F, Joly V, Mathieu E, Martinet N, and Frossard N.** Upregulation of nerve growth factor expression by human airway smooth muscle cells in inflammatory conditions. *Eur Respir J* 20: 458-463, 2002.
19. **Friedman WJ, Altiok N, Fredholm BB, and Persson H.** Mechanisms of nerve growth factor mRNA regulation by interleukin-1 beta in hippocampal cultures: role of second messengers. *J Neurosci Res* 33: 37-46, 1992.
20. **Frossard N, Freund V, and Advenier C.** Nerve growth factor and its receptors in asthma and inflammation. *Eur J Pharmacol* 500: 453-465, 2004.
21. **Frossard N, Naline E, Olgart Hoglund C, Georges O, and Advenier C.** Nerve growth factor is released by IL-1beta and induces hyperresponsiveness of the human isolated bronchus. *Eur Respir J* 26: 15-20, 2005.
22. **Gadient RA, Cron KC, and Otten U.** Interleukin-1 beta and tumor necrosis factor-alpha synergistically stimulate nerve growth factor (NGF) release from cultured rat astrocytes. *Neurosci Lett* 117: 335-340, 1990.
23. **Hahn C, Islamian AP, Renz H, and Nockher WA.** Airway epithelial cells produce neurotrophins and promote the survival of eosinophils during allergic airway inflammation. *J Allergy Clin Immunol* 117: 787-794, 2006.
24. **Hamada A, Watanabe N, Ohtomo H, and Matsuda H.** Nerve growth factor enhances survival and cytotoxic activity of human eosinophils. *Br J Haematol* 93: 299-302, 1996.

25. **Hamid Q, Tulic MK, Liu MC, and Moqbel R.** Inflammatory cells in asthma: mechanisms and implications for therapy. *J Allergy Clin Immunol* 111: S5-S12; discussion S12-17, 2003.
26. **Hansen-Algenstaedt N, Algenstaedt P, Schaefer C, Hamann A, Wolfram L, Cingoz G, Kilic N, Schwarzloh B, Schroeder M, Joscheck C, Wiesner L, Ruther W, and Ergun S.** Neural driven angiogenesis by overexpression of nerve growth factor. *Histochem Cell Biol* 125: 637-649, 2006.
27. **Hashimoto S, Matsumoto K, Gon Y, Ichiwata T, Takahashi N, and Kobayashi T.** Viral infection in asthma. *Allergol Int* 57: 21-31, 2008.
28. **Hattori A, Tanaka E, Murase K, Ishida N, Chatani Y, Tsujimoto M, Hayashi K, and Kohno M.** Tumor necrosis factor stimulates the synthesis and secretion of biologically active nerve growth factor in non-neuronal cells. *J Biol Chem* 268: 2577-2582, 1993.
29. **Hikawa S, Kobayashi H, Hikawa N, Kusakabe T, Hiruma H, Takenaka T, Tomita T, and Kawakami T.** Expression of neurotrophins and their receptors in peripheral lung cells of mice. *Histochem Cell Biol* 118: 51-58, 2002.
30. **Hoyle GW, Graham RM, Finkelstein JB, Nguyen KP, Gozal D, and Friedman M.** Hyperinnervation of the airways in transgenic mice overexpressing nerve growth factor. *Am J Respir Cell Mol Biol* 18: 149-157, 1998.
31. **Jeffery PK.** Remodeling in asthma and chronic obstructive lung disease. *Am J Respir Crit Care Med* 164: S28-38, 2001.

32. **Kassel O, de Blay F, Duvernelle C, Olgart C, Israel-Biet D, Krieger P, Moreau L, Muller C, Pauli G, and Frossard N.** Local increase in the number of mast cells and expression of nerve growth factor in the bronchus of asthmatic patients after repeated inhalation of allergen at low-dose. *Clin Exp Allergy* 31: 1432-1440, 2001.
33. **Kemi C, Grunewald J, Eklund A, and Hoglund CO.** Differential regulation of neurotrophin expression in human bronchial smooth muscle cells. *Respir Res* 7: 18, 2006.
34. **Kerschensteiner M, Gallmeier E, Behrens L, Leal VV, Misgeld T, Klinkert WE, Kolbeck R, Hoppe E, Oropeza-Wekerle RL, Bartke I, Stadelmann C, Lassmann H, Wekerle H, and Hohlfeld R.** Activated human T cells, B cells, and monocytes produce brain-derived neurotrophic factor in vitro and in inflammatory brain lesions: a neuroprotective role of inflammation? *J Exp Med* 189: 865-870, 1999.
35. **Kobayashi H, Gleich GJ, Butterfield JH, and Kita H.** Human eosinophils produce neurotrophins and secrete nerve growth factor on immunologic stimuli. *Blood* 99: 2214-2220, 2002.
36. **Koizumi H, Morita M, Mikami S, Shibayama E, and Uchikoshi T.** Immunohistochemical analysis of TrkA neurotrophin receptor expression in human non-neuronal carcinomas. *Pathol Int* 48: 93-101, 1998.
37. **Lambiase A, Bracci-Laudiero L, Bonini S, Bonini S, Starace G, D'Elios MM, De Carli M, and Aloe L.** Human CD4⁺ T cell clones produce and release nerve growth factor and express high-affinity nerve growth factor receptors. *J Allergy Clin Immunol* 100: 408-414, 1997.

38. **Leon A, Buriani A, Dal Toso R, Fabris M, Romanello S, Aloe L, and Levi-Montalcini R.** Mast cells synthesize, store, and release nerve growth factor. *Proc Natl Acad Sci U S A* 91: 3739-3743, 1994.
39. **Lindholm D, Heumann R, Hengerer B, and Thoenen H.** Interleukin 1 increases stability and transcription of mRNA encoding nerve growth factor in cultured rat fibroblasts. *J Biol Chem* 263: 16348-16351, 1988.
40. **Moser KV, Reindl M, Blasig I, and Humpel C.** Brain capillary endothelial cells proliferate in response to NGF, express NGF receptors and secrete NGF after inflammation. *Brain Res* 1017: 53-60, 2004.
41. **Nassenstein C, Braun A, Erpenbeck VJ, Lommatzsch M, Schmidt S, Krug N, Luttmann W, Renz H, and Virchow JC, Jr.** The neurotrophins nerve growth factor, brain-derived neurotrophic factor, neurotrophin-3, and neurotrophin-4 are survival and activation factors for eosinophils in patients with allergic bronchial asthma. *J Exp Med* 198: 455-467, 2003.
42. **Nockher WA and Renz H.** Neurotrophins and asthma: novel insight into neuroimmune interaction. *J Allergy Clin Immunol* 117: 67-71, 2006.
43. **Nockher WA and Renz H.** Neurotrophins in allergic diseases: from neuronal growth factors to intercellular signaling molecules. *J Allergy Clin Immunol* 117: 583-589, 2006.
44. **Noga O, Englmann C, Hanf G, Grutzkau A, Seybold J, and Kunkel G.** The production, storage and release of the neurotrophins nerve growth factor, brain-derived

neurotrophic factor and neurotrophin-3 by human peripheral eosinophils in allergics and non-allergics. *Clin Exp Allergy* 33: 649-654, 2003.

45. **Noga O, Peiser M, Altenahr M, Knieling H, Wanner R, Hanf G, Grosse R, and Suttorp N.** Differential activation of dendritic cells by nerve growth factor and brain-derived neurotrophic factor. *Clin Exp Allergy* 37: 1701-1708, 2007.

46. **Noga O, Peiser M, Altenahr M, Schmeck B, Wanner R, Dinh QT, Hanf G, and Suttorp N.** Selective induction of nerve growth factor and brain-derived neurotrophic factor by LPS and allergen in dendritic cells. *Clin Exp Allergy* 38: 473-479, 2008.

47. **Olgart C and Frossard N.** Human lung fibroblasts secrete nerve growth factor: effect of inflammatory cytokines and glucocorticoids. *Eur Respir J* 18: 115-121, 2001.

48. **Olgart Hoglund C, de Blay F, Oster JP, Duvernelle C, Kassel O, Pauli G, and Frossard N.** Nerve growth factor levels and localisation in human asthmatic bronchi. *Eur Respir J* 20: 1110-1116, 2002.

49. **Othumpangat S, Gibson LF, Samsell L, and Piedimonte G.** NGF is an essential survival factor for bronchial epithelial cells during respiratory syncytial virus infection. *PLoS One* 4: e6444, 2009.

50. **Othumpangat S, Walton C, and Piedimonte G.** MicroRNA-221 modulates RSV replication in human bronchial epithelium by targeting NGF expression. *PLoS One* 7: e30030, 2012.

51. **Pascoe CD, Wang L, Syyong HT, and Pare PD.** A brief history of airway smooth muscle's role in airway hyperresponsiveness. *J Allergy (Cairo)* 2012: 768982, 2012.
52. **Perez-Pinera P, Hernandez T, Garcia-Suarez O, de Carlos F, Germana A, Del Valle M, Astudillo A, and Vega JA.** The Trk tyrosine kinase inhibitor K252a regulates growth of lung adenocarcinomas. *Mol Cell Biochem* 295: 19-26, 2007.
53. **Pons F, Freund V, Kuissu H, Mathieu E, Olgart C, and Frossard N.** Nerve growth factor secretion by human lung epithelial A549 cells in pro- and anti-inflammatory conditions. *Eur J Pharmacol* 428: 365-369, 2001.
54. **Pshenichkin SP, Szekely AM, and Wise BC.** Transcriptional and posttranscriptional mechanisms involved in the interleukin-1, steroid, and protein kinase C regulation of nerve growth factor in cortical astrocytes. *J Neurochem* 63: 419-428, 1994.
55. **Raap U and Braunstahl GJ.** The role of neurotrophins in the pathophysiology of allergic rhinitis. *Curr Opin Allergy Clin Immunol* 10: 8-13, 2010.
56. **Raap U, Fokkens W, Bruder M, Hoogsteden H, Kapp A, and Braunstahl GJ.** Modulation of neurotrophin and neurotrophin receptor expression in nasal mucosa after nasal allergen provocation in allergic rhinitis. *Allergy* 63: 468-475, 2008.
57. **Rahbek UL, Dissing S, Thomassen C, Hansen AJ, and Tritsarlis K.** Nerve growth factor activates aorta endothelial cells causing PI3K/Akt- and ERK-dependent migration. *Pflugers Arch* 450: 355-361, 2005.

58. **Raychaudhuri SK, Raychaudhuri SP, Weltman H, and Farber EM.** Effect of nerve growth factor on endothelial cell biology: proliferation and adherence molecule expression on human dermal microvascular endothelial cells. *Arch Dermatol Res* 293: 291-295, 2001.
59. **Ricci A, Felici L, Mariotta S, Mannino F, Schmid G, Terzano C, Cardillo G, Amenta F, and Bronzetti E.** Neurotrophin and neurotrophin receptor protein expression in the human lung. *Am J Respir Cell Mol Biol* 30: 12-19, 2004.
60. **Ricci A, Graziano P, Bronzetti E, Saltini C, Sciacchitano S, Cherubini E, Renzoni E, Du Bois RM, Grutters JC, and Mariotta S.** Increased pulmonary neurotrophin protein expression in idiopathic interstitial pneumonias. *Sarcoidosis Vasc Diffuse Lung Dis* 24: 13-23, 2007.
61. **Ricci A, Greco S, Mariotta S, Felici L, Amenta F, and Bronzetti E.** Neurotrophin and neurotrophin receptor expression in alveolar macrophages: an immunocytochemical study. *Growth Factors* 18: 193-202, 2000.
62. **Ricci A, Greco S, Mariotta S, Felici L, Bronzetti E, Cavazzana A, Cardillo G, Amenta F, Bisetti A, and Barbolini G.** Neurotrophins and neurotrophin receptors in human lung cancer. *Am J Respir Cell Mol Biol* 25: 439-446, 2001.
63. **Rochlitzer S, Nassenstein C, and Braun A.** The contribution of neurotrophins to the pathogenesis of allergic asthma. *Biochem Soc Trans* 34: 594-599, 2006.
64. **Rost B, Hanf G, Ohnemus U, Otto-Knapp R, Groneberg DA, Kunkel G, and Noga O.** Monocytes of allergics and non-allergics produce, store and release the neurotrophins NGF, BDNF and NT-3. *Regul Pept* 124: 19-25, 2005.

65. **Sanico AM, Stanisz AM, Gleeson TD, Bora S, Proud D, Bienenstock J, Koliatsos VE, and Togias A.** Nerve growth factor expression and release in allergic inflammatory disease of the upper airways. *Am J Respir Crit Care Med* 161: 1631-1635, 2000.
66. **Sawada J, Itakura A, Tanaka A, Furusaka T, and Matsuda H.** Nerve growth factor functions as a chemoattractant for mast cells through both mitogen-activated protein kinase and phosphatidylinositol 3-kinase signaling pathways. *Blood* 95: 2052-2058, 2000.
67. **Solomon A, Aloe L, Pe'er J, Frucht-Pery J, Bonini S, Bonini S, and Levi-Schaffer F.** Nerve growth factor is preformed in and activates human peripheral blood eosinophils. *J Allergy Clin Immunol* 102: 454-460, 1998.
68. **Sonar SS, Schwinge D, Kilic A, Yildirim AO, Conrad ML, Seidler K, Muller B, Renz H, and Nockher WA.** Nerve growth factor enhances Clara cell proliferation after lung injury. *Eur Respir J* 36: 105-115, 2010.
69. **Steinle JJ and Granger HJ.** Nerve growth factor regulates human choroidal, but not retinal, endothelial cell migration and proliferation. *Auton Neurosci* 108: 57-62, 2003.
70. **Torcia M, Bracci-Laudiero L, Lucibello M, Nencioni L, Labardi D, Rubartelli A, Cozzolino F, Aloe L, and Garaci E.** Nerve growth factor is an autocrine survival factor for memory B lymphocytes. *Cell* 85: 345-356, 1996.
71. **Tortorolo L, Langer A, Polidori G, Vento G, Stampachiacchere B, Aloe L, and Piedimonte G.** Neurotrophin overexpression in lower airways of infants with respiratory syncytial virus infection. *Am J Respir Crit Care Med* 172: 233-237, 2005.

72. **Toyoda M, Nakamura M, Makino T, and Morohashi M.** Localization and content of nerve growth factor in peripheral blood eosinophils of atopic dermatitis patients. *Clin Exp Allergy* 33: 950-955, 2003.
73. **Undem BJ, Hunter DD, Liu M, Haak-Frendscho M, Oakragly A, and Fischer A.** Allergen-induced sensory neuroplasticity in airways. *Int Arch Allergy Immunol* 118: 150-153, 1999.
74. **Virchow JC, Julius P, Lommatzsch M, Luttmann W, Renz H, and Braun A.** Neurotrophins are increased in bronchoalveolar lavage fluid after segmental allergen provocation. *Am J Respir Crit Care Med* 158: 2002-2005, 1998.
75. **Wu X, Myers AC, Goldstone AC, Togias A, and Sanico AM.** Localization of nerve growth factor and its receptors in the human nasal mucosa. *J Allergy Clin Immunol* 118: 428-433, 2006.

Chapter 3

NGF and Ion Transport

Introduction

The epithelial cells which line the airways serve several important functions, such as acting as a primary physical barrier between the body and the outside environment and regulating airway surface liquid (ASL). The ASL level is maintained by ion transport, and proper ASL height is essential to allow ciliary beating to occur and to move inhaled particles up the airways for removal. Disruption of the ion transport has been shown to be associated with several airway diseases.

This chapter will review the ion transport proteins responsible for maintaining the ASL level, discuss airway diseases in which ion transport is affected, and describe the findings which support out hypothesis that NGF, which is up-regulated in airway diseases, can regulate ion transport in the airway epithelium.

Ion transport in airway epithelial cells

Airway epithelial cells traffic proteins responsible for ion transport to either the apical/luminal membrane or the basolateral/blood membrane. This trafficking results in polarization. Humans airway epithelial cells are primarily Na^+ re-absorbers and Cl^- secretors (53). On the apical membrane, epithelial cells regulate ASL primarily by Na^+ reabsorption through epithelial Na^+ channels (ENaC) and Cl^- secretion through the cystic fibrosis transmembrane conductance regulator (CFTR), Cl^- channels 2 and 3 (ClC2 and ClC3), and Ca^{2+} -dependent Cl^- channels (CaCC). The basolateral membrane contains the Na^+/K^+ -ATPase, which is the driving force for Na^+ reabsorption, the Na^+/H^+ exchanger (NHE), the $\text{Na}^+/\text{K}^+ / 2 \text{Cl}^-$ (NKCC) cotransporter, this $\text{HCO}_3^-/\text{Cl}^-$ anion exchanger, the

basolateral outward rectifying Cl^- channel (BORC), the basolateral inward rectifying Cl^- channel (BIRC) and the basolateral CFTR-like Cl^- channel (BCFTR) (32). Figure 3.1, from Hollenhorst et al. (32), depicts the locations of these transporters on the cell surface.

ASL levels are maintained through coordinated ion transport by these ion transport proteins. Song et al., using cultured human airway epithelial cells, human trachea obtained from lung transplant patients, and pig tracheas, measured ASL levels under basal conditions, after treatment with the ENaC inhibitor amiloride, and after CFTR stimulation with cAMP agonist, forskolin (59). Treatment with either amiloride or forskolin resulted in increased ASL height, or hydration of the ASL, as compared to non-treated preparations. These results indicate the importance of ion transport, specifically Na^+ and Cl^- transport, in maintaining ASL height.

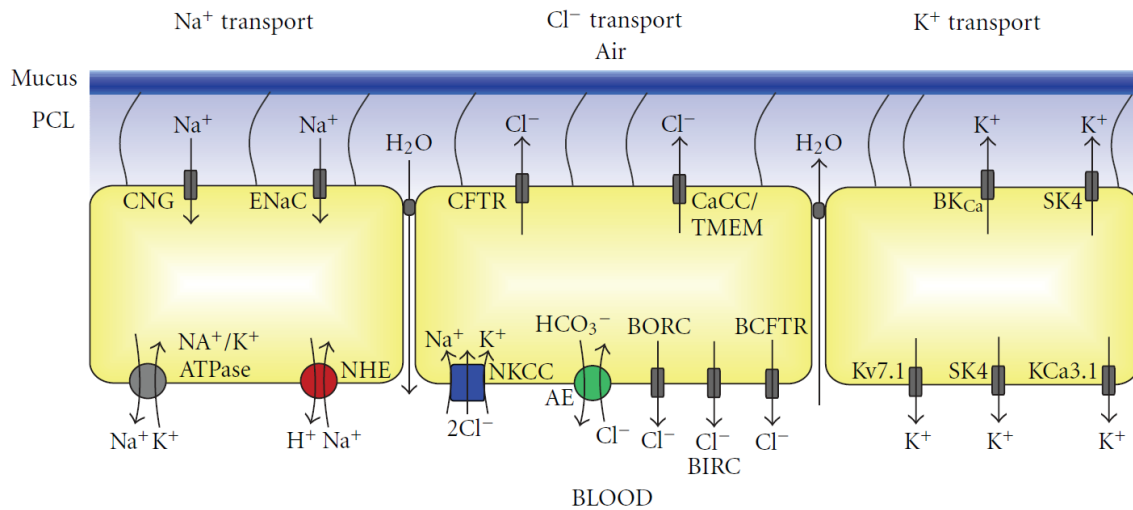

Figure 3.1 – Representative model depicting the location of ion channels in airway epithelial cells. The epithelial cells, through coordinated ion transport, maintain a properly hydrated ASL to allow for ciliary beating to occur. Human airway epithelial cells are primarily Na⁺ re-absorbers and Cl⁻ secretors. The epithelial Na⁺ channel (ENaC) is located on the apical membrane and is considered to be the rate limiting step for Na⁺ reabsorption. On the basolateral membrane, the Na⁺/K⁺-ATPase provides the driving force for Na⁺ reabsorption. Cl⁻ secretion occurs through several Cl⁻ channels on the apical membrane including the cystic fibrosis transmembrane conductance regulator (CFTR), Cl⁻ channels 2 and 3 (ClC2 and ClC3), and Ca²⁺-dependent Cl⁻ channels (CaCC). The basolateral membrane contains the Na⁺/K⁺-ATPase, the Na⁺/H⁺ exchanger (NHE), the Na⁺/K⁺/2 Cl⁻ (NKCC) cotransporter, the HCO₃⁻/Cl⁻ anion exchanger, the basolateral outward rectifying channel (BORC), the basolateral inward rectifying channel (BIRC) and the basolateral CFTR-like channel (BCFTR). Image used with permission from Hollenhorst et al. (32).

Sodium transport

As described in the sections 3.2, human airway epithelium is primarily a Na⁺ re-absorbing epithelium, and ENaC is the rate-limiting step for Na⁺ re-absorption. This re-absorption occurs through apical ENaC channels, and the driving force for this re-absorption is the Na⁺ concentration gradient established by the basolateral Na⁺/K⁺-ATPase. Canessa et al. demonstrated that the ENaC channel is composed of three subunits, α , β , and γ , and only when the three subunits are expressed together could the maximum amiloride-sensitive current be obtained (14).

The maturation and activation of these channels occurs after proteolytic cleavage at two sites on the α -subunit extracellular domain, and on two sites on the γ -subunit extracellular domain. Hughey et al. published findings demonstrating that furin, an endoprotease and a member of the proprotein convertase family, cleaves two sites on the α -subunit and one site on the γ -subunit to result in ENaC maturation and increased Na⁺ transport in Chinese hamster ovary (CHO) cells (33, 66). Donaldson et al. demonstrated that ENaC channel activation is regulated by the serine protease, prostaticin, which functions to cleave the extracellular domain on the γ -subunit (23). When *Xenopus oocyte* cells were treated with prostaticin there was an 80 % increase in ENaC current. The findings that ENaC could be activated by a serine protease were confirmed in cultured human primary nasal epithelial cells. Ussing chamber studies were performed using these nasal epithelial cells to investigate changes in I_{sc} following treatment with the serine protease trypsin in the absence or presence of the protease inhibitor, aprotinin. When cells were treated with aprotinin, Na⁺ current steadily declined. This Na⁺ current could be

restored when cells were treated with, trypsin, but no additional increases in Na^+ current were observed when trypsin was applied to non-aprotinin treated cells. Prostasin has been shown to be a glycosylphosphatidylinositol-anchored membrane bound protein (17). The cleavage of the α and γ extracellular subunit domains by furin and prostasin result in increased open probability of the channel, and, therefore, increased Na^+ transport.

Regulation of ENaC activity is important for maintaining ASL hydration to allow cilia to beat. When Na^+ is re-absorbed from the lumen and transported to the basolateral membrane, water flows down its transepithelial osmotic gradient from the lumen to the basolateral membrane. In order to regulate ASL, ENaC activity must be regulated. Myerburg et al. published findings which suggest that the airways produce protease inhibitors to prevent the cleavage and activation of ENaC (47). Using cultured human primary airway epithelial cells, Myerburg et al. demonstrated that increased ASL volume dilutes the inhibitory proteases, allowing furin and prostasin to cleave and activate ENaC and dehydrate ASL to reduce its height. Once the ASL height is reduced to a certain level, the inhibitory proteases are no longer diluted, allowing once again ENaC activation by proteolytic cleavage.

Garcia-Caballero et al., using a proteomic approach, identified the secreted short palate, lung and nasal epithelial clone (SPLUNC) 1 as being responsible for inactivating ENaC in human primary bronchial epithelial cells (26). SPLUNC1 is expressed and secreted by the airway epithelium, submucosal glands, and neutrophils. SPLUNC1 represents 10% of the total protein contained in the ASL (4, 13). Regulation of ENaC by SPLUNC1 results from its direct binding to ENaC to prevent proteolytic cleavage, not by

inhibiting the proteases furin and prostaticin. This binding was determined to be dependent on ASL height, with higher ASL height causing the dilution, and therefore, inactivation, of SPLUNC1.

The basolateral membrane of the airway epithelium contains the Na^+/K^+ -ATPase, which is the driving force responsible for Na^+ re-absorption from the lumen. The Na^+/K^+ -ATPase is a heterodimer composed of an α_1 and β_1 subunit, but there have been four α -isoforms and three β -isoforms discovered (57). The $\alpha_1\beta_1$ isoform is the primary isoform in the airway epithelial cells, but it is also expressed by all of the cells in the body. The expression of the other α and β subunits is highly tissue specific. The α_1 subunit is 1,024 amino acids long, contains 4 transmembrane domains on the NH_2 -terminal segment, a large cytoplasmic domain, followed by six transmembrane domains on the COOH -terminal segment with both the NH_2 and COOH regions residing in the cytoplasm (15, 41, 61). The α -subunit is responsible for the 3:2 exchange of Na^+/K^+ , and contains the phosphorylation sites necessary to activate the pump (62). The α_1 -subunit also contains the binding site for Na^+/K^+ -ATPase inhibitor, ouabain, on the extracellular domain between transmembrane segments 1 and 2 (41). The β_1 -subunit, which is much smaller than the α_1 -subunit, is composed of 304 amino acids, contains three glycosylation sites, has one transmembrane domain with the NH_2 terminal segment located in the cytoplasm, and contains six cysteine residues important for forming three disulfide bridges (5, 44). The β_1 -subunit is suggested to aid in protein trafficking to the basolateral membrane as well as playing a role in protein regulation (62).

The Na⁺/K⁺-ATPase (i.e., Na⁺/K⁺-pump) generates a transepithelial gradient, causing Na⁺ to be re-absorbed from the lumen and pumped out of the cell across the basolateral membrane (5). The activity of basal Na⁺/K⁺-ATPase activity is predicted to be approximately one-third of the pump's maximum capacity (58). The amount of Na⁺ pumped out of the cell is determined by the number of Na⁺/K⁺-pumps on the membrane, the turnover activity of the pump, and changes in the pumps affinity for Na⁺.

Dopaminergic and β-adrenergic signaling in the airways has been shown to rapidly enhance Na⁺ transport and reduce lung edema (3). Dopamine and dopaminergic agonists that bind to the D₁, but not the D₂ receptor, activate the PKC signaling pathway which is responsible for causing the exocytosis of intracellular vesicles, which ultimately increases the number of Na⁺/K⁺-pump molecules in the membrane (51). The β-adrenoceptor agonist, terbutaline, stimulates Na⁺ reabsorption by activating the Na⁺/K⁺-ATPase through a cAMP-dependent activation of Cl⁻ channels (36). Minakata et al. demonstrated that β- adrenoceptor agonists induced the gene expression of the α-subunit of ENaC and the α₁-subunit of the Na⁺/K⁺-ATPase, which resulted in increased Na⁺ transport as well as increased Na⁺ currents in alveolar type II cells (45).

Chloride transport

Cl⁻ channels are important regulators of cell volume, cellular pH, and fluid transport (35). Epithelial cells of the lung secrete Cl⁻ into the lumen of the airways, and this secretion is mediated by the apical Cl⁻ channels cystic fibrosis transmembrane conductance regulator (CFTR), Cl⁻ channels (ClC), and Ca⁺²-activated ion channels (CaCCs)(Figure 3.1).

Riordan et al. identified the CFTR gene on chromosome 7, and found it to be composed of 6,100 nucleotides which encoded a protein containing 1,480 amino acids and a mass of 168 kDa (52). The protein structure contained two repeated motifs composed of six membrane-spanning domains, and each motif contained an ATP nucleotide-binding domain. These two repeated motifs were linked by a regulatory domain, which contains several PKA and PKC phosphorylation sites (52). The CFTR NH₂ and COOH segments, the nucleotide-binding domains, and the regulatory domain, were determined to be located in the cytoplasm (22). Tabcharani et al. demonstrated that the Cl⁻ transport by the CFTR is regulated through channel phosphorylation, and channels could be activated by cAMP, PKA, or PKC, and inactivation was observed when the channel was dephosphorylated using alkaline phosphatases and fluoride (63).

The CIC family consists of nine family members, with CIC-2 being expressed in almost all cell types (65). The CIC-2 has been demonstrated to be located in the apical membrane of the airway epithelial cells (not shown in Figure 3.1), but its expression is down-regulated after birth (46). The expression of the CIC-2 is not important in mediating lung development, and CIC-2 knockout mice demonstrate normal lung development and function (10). The structure of CIC-2 consists of two identical subunits, each having of eighteen α -helices, which form a rhombus structure that protrudes out of the membrane (24). Amino acids from four separate regions on the D, F, and N α -helices, which contain positively charged amino acids, are brought together to form a common center which generates the pore complex. The positive charged pore region generates a favorable environment which stabilizes Cl⁻ and allows for Cl⁻ diffusion (24). Cuppoletti

et al. published findings demonstrating that CIC-2 channel activity in cultured human primary buccal cells and immortalized airway cells could be increased when treated with arachidonic acid, amidation, and omeprazole, which increased Cl^- current (20)

The CaCCs are reported in several cell types (35). They are located on the apical surface of airway epithelial cells, are activated by intercellular Ca^{2+} , and play an important role maintaining ASL levels in the lung (1, 40, 48). Tarran et al. reported that CaCCs could be stimulated with UTP to result in increased Cl^- and fluid secretion, as indicated by increases in ASL height (64). The activation of the CaCC by UTP is a result of increased IP_3 production and release of intracellular Ca^{2+} (25).

Ion transport and airway disease

As reviewed in section 3.3, Na^+ is re-absorbed from the lumen through ENaC, and this Na^+ transport is driven by the Na^+/K^+ -ATPase. When Na^+ is re-absorbed from the lumen, water follows its osmotic gradient from the lumen to the basolateral membrane and decreases ASL height. When Na^+ transport is inhibited, fluid is retained in the lung causing pulmonary edema. Hummler et al. demonstrated the importance of ENaC in fluid clearance by generating an α -ENaC knockout mouse (34). No changes in the morphology of the lung occurred in the knockout animals, indicating ENaC was not responsible for lung development. However, all mice died within 40 h after birth due to an inability to clear lung fluid, which was determined by measuring the lung wet/dry ratio.

Transepithelial potential difference measurements of newborn tracheas also revealed that these mice lacked epithelial Na^+ transport, as they were insensitive to amiloride (34).

Patients suffering from chronic congestive heart failure, acute myocardial infarction, and intravascular volume overload suffer from severe hydrostatic pulmonary edema (68). Saldias et al. demonstrated that increased pulmonary arterial pressure resulted in increased permeability of fluid and albumin into the lung, and this increased fluid accumulation was a result of decreased Na^+ transport (54). The accumulation of fluid in the airways results in impaired gas exchange, causing hypoxic conditions. Hypoxic conditions in the airways reduce Na^+ transport as well as reduce ENaC and Na^+/K^+ -ATPase subunit synthesis (31, 42, 49).

Pseudohypoaldosteronism type 1 (PHA1) and Liddle's syndrome are genetic diseases in which alterations to genes encoding the ENaC subunits have been reported. PHA1 is characterized as a salt-wasting disease and results from impaired ENaC function due to mutations in the α - and β -subunits. Fluid clearance in the lungs of patients suffering from PHA1 is impaired, and may cause patients to develop a respiratory distress syndrome (2, 38, 50). Chang et al. identified two mutations in the α -subunit and one mutation in the β -subunit responsible for impaired ENaC function. The first mutation detected was a deletion of two bases in exon 2 of the α -subunit, which results in a frame shift in the amino acid translation producing an α -subunit with a different amino acid sequence from 68-144. The second mutation changes codon R508 from CGA to TGA, a premature stop codon. Both mutations to the α -subunit result in a loss of function in ENaC. The β -subunit mutation results from a glycine to serine mutation at position 37 (G37S). Expression of the mutant β -subunit with wild type α - and γ -subunits in *Xenopus* oocytes resulted in a 60 % reduction in ENaC activity as compared to the wild type (16).

Transgenic mice generated to model PHA1 die within 50 h after birth, again indicating the importance of ENaC function (6).

Liddle's syndrome is characterized by early onset of hypertension, normo- or hypokalemia, metabolic alkalosis, and repressed renin and aldosterone secretion (11). The generation of a premature stop codon results the deletion of 45-76 amino acids on the C terminus of the ENaC β - or γ -subunit and results in a 3-fold increase in Na^+ transport (30, 55). Further investigation revealed that the truncated regions of the β - and γ -subunits contain a proline-rich domain (PPxY), which interacts with the Nedd-4 ubiquitin ligase to facilitate the degradation of the ENaC channel (60). Because the mutated ENaC β - and γ -subunits can no longer interact with Nedd4, there is an increased expression of ENaC channels on the membrane, which results in increased Na^+ transport.

Patients suffering from cystic fibrosis have impaired Cl^- transport as a result of a loss of function mutation in their CFTR gene, with the most common mutation being ΔF508 (39). This mutation results in the CFTR protein misfolding in the endoplasmic reticulum, but the misfolded protein is still able to be trafficked to the apical membrane. Although present on the apical membrane, the CFTR is unable to secrete Cl^- (37, 70). In addition to a loss of Cl^- transport, airway epithelial cells containing mutated CFTR demonstrate an increased Na^+ transport as compared to cells from non-cystic fibrosis patients, indicating that CFTR may also regulate ENaC function (18). The loss of Cl^- transport combined with an increased Na^+ transport result in a depleted periciliary liquid (PCL) layer. This reduction in PCL causes a loss of cilia-dependent mucus transport, and

results in a thickening of mucus to form mucus plaques and mucus plugging, which favors growth of bacteria in the airways (12, 43).

NGF and ion transport

The treatment of rat adrenal pheochromocytoma (PC12) cells with NGF results in a morphological change from a rounded morphology to cells that are long, fine, highly branched, and synthesize enzymes and neurotransmitters resembling those of sympathetic neurons (29). The ability to transform PC12 cells into cells with neuronal properties is a model to study the nervous system.

Schubert et al., using PC12 cells, published the first report of NGF having an effect on ion transport in cells, specifically Ca^{+2} (56). This study aimed to investigate the mechanism by which NGF treatment resulted in an increased nerve outgrowth and adhesion. The findings suggested that treatment with NGF, acting through a cAMP-mediated pathway, resulted in Ca^{2+} release from intracellular stores to promote cellular growth and adhesion (56).

Varon et al. demonstrated that NGF could regulate Na^{+} transport in chick embryo sensory ganglia, and that this Na^{+} transport was essential for regulating cell survival, size, neurite outgrowth, and the synthesis of neurotransmitter enzymes (28, 67). Boonstra et al. demonstrated that NGF could activate the $\text{Na}^{+}/\text{K}^{+}$ -ATPase through increasing amiloride-sensitive Na^{+} transport in both PC12 cells and chick embryo dorsal root ganglia giving rise to enhanced cellular growth (7-9).

NGF has also been shown to elicit genomic responses to alter ion transport. D'Arcangelo et al. incubated differentiating sympathetic neurons and PC12 cells with NGF and, using a whole cell patch clamp to measure Na⁺ current, found that NGF increased Na⁺ current, with the maximum current being achieved after three days of incubation with NGF (21). The increased Na⁺ current was a result of rapid induction of the type II/IIA Na⁺ gene, which was a result of activation of a cAMP-dependent, PKA-mediated pathway, and induction of the peripheral nerve-type Na⁺ channel (PN1) gene through a PKA-independent pathway (21).

As mentioned in Chapter 2, transgenic mice developed to overexpress NGF in Clara cells of the lung displayed AHR to inhaled capsaicin. Chuang et al. suggested that NGF is able to sensitize the vanilloid receptor, VR1, on sensory neurons, resulting in an increased sensitivity to capsaicin, which acts through this receptor (19). Mice injected with NGF developed thermal hypersensitivity, as measured using a paw withdrawal assay, and NGF enhanced proton-evoked and heat-evoked currents in oocytes expressing VR1, trkA, p75, and 5HT₃R-A. Chuang et al. concluded that NGF was able to sensitize the VR1 channel through a PLC- γ mediated pathway, and that VR1 associates with the NGF-trkA complex (19). Zhang et al. also demonstrated that NGF signaling through the trkA receptor can enhance TRPV1 channel activity through a PLC- γ pathway, promoting insertion of TRPV1 receptors into the plasma membrane through a PI3K-mediated pathway (71).

NGF has also been found to affect ion transport in renal epithelial cells. Watts et al., using perfused rat medullary thick ascending limb (MTAL) preparations,

demonstrated that NGF, acting through an Erk-mediated pathway, inhibits the basolateral Na^+/H^+ exchanger and apical HCO_3^- absorption (27, 69).

1. **Anderson MP, Sheppard DN, Berger HA, and Welsh MJ.** Chloride channels in the apical membrane of normal and cystic fibrosis airway and intestinal epithelia. *Am J Physiol* 263: L1-14, 1992.
2. **Barker PM, Gowen CW, Lawson EE, and Knowles MR.** Decreased sodium ion absorption across nasal epithelium of very premature infants with respiratory distress syndrome. *J Pediatr* 130: 373-377, 1997.
3. **Barnard ML, Ridge KM, Saldias F, Friedman E, Gare M, Guerrero C, Lecuona E, Bertorello AM, Katz AI, and Sznajder JI.** Stimulation of the dopamine 1 receptor increases lung edema clearance. *Am J Respir Crit Care Med* 160: 982-986, 1999.
4. **Bartlett JA, Hicks BJ, Schlomann JM, Ramachandran S, Nauseef WM, and McCray PB, Jr.** PLUNC is a secreted product of neutrophil granules. *J Leukoc Biol* 83: 1201-1206, 2008.
5. **Blanco G and Mercer RW.** Isozymes of the Na-K-ATPase: heterogeneity in structure, diversity in function. *Am J Physiol* 275: F633-650, 1998.
6. **Bonny O and Hummler E.** Dysfunction of epithelial sodium transport: from human to mouse. *Kidney Int* 57: 1313-1318, 2000.
7. **Boonstra J, Moolenaar WH, Harrison PH, Moed P, van der Saag PT, and de Laat SW.** Ionic responses and growth stimulation induced by nerve growth factor and epidermal growth factor in rat pheochromocytoma (PC12) cells. *J Cell Biol* 97: 92-98, 1983.

8. **Boonstra J, Skaper SD, and Varon S.** Regulation of Na⁺,K⁺ pump activity by nerve growth factor in chick embryo dorsal root ganglion cells. *J Cell Physiol* 113: 28-34, 1982.
9. **Boonstra J, van der Saag PT, Moolenaar WH, and de Laat SW.** Rapid effects of nerve growth factor on the Na⁺, K⁺-pump in rat pheochromocytoma cells. *Exp Cell Res* 131: 452-455, 1981.
10. **Bosl MR, Stein V, Hubner C, Zdebik AA, Jordt SE, Mukhopadhyay AK, Davidoff MS, Holstein AF, and Jentsch TJ.** Male germ cells and photoreceptors, both dependent on close cell-cell interactions, degenerate upon ClC-2 Cl⁻ channel disruption. *EMBO J* 20: 1289-1299, 2001.
11. **Botero-Velez M, Curtis JJ, and Warnock DG.** Brief report: Liddle's syndrome revisited - a disorder of sodium reabsorption in the distal tubule. *N Engl J Med* 330: 178-181, 1994.
12. **Boucher RC.** New concepts of the pathogenesis of cystic fibrosis lung disease. *Eur Respir J* 23: 146-158, 2004.
13. **Campos MA, Abreu AR, Nlend MC, Cobas MA, Conner GE, and Whitney PL.** Purification and characterization of PLUNC from human tracheobronchial secretions. *Am J Respir Cell Mol Biol* 30: 184-192, 2004.
14. **Canessa CM, Schild L, Buell G, Thorens B, Gautschi I, Horisberger JD, and Rossier BC.** Amiloride-sensitive epithelial Na⁺ channel is made of three homologous subunits. *Nature* 367: 463-467, 1994.

15. **Canfield VA and Levenson R.** Transmembrane organization of the Na,K-ATPase determined by epitope addition. *Biochemistry* 32: 13782-13786, 1993.
16. **Chang SS, Grunder S, Hanukoglu A, Rosler A, Mathew PM, Hanukoglu I, Schild L, Lu Y, Shimkets RA, Nelson-Williams C, Rossier BC, and Lifton RP.** Mutations in subunits of the epithelial sodium channel cause salt wasting with hyperkalaemic acidosis, pseudohypoaldosteronism type 1. *Nat Genet* 12: 248-253, 1996.
17. **Chen LM, Skinner ML, Kauffman SW, Chao J, Chao L, Thaler CD, and Chai KX.** Prostasin is a glycosylphosphatidylinositol-anchored active serine protease. *J Biol Chem* 276: 21434-21442, 2001.
18. **Chinet TC, Fullton JM, Yankaskas JR, Boucher RC, and Stutts MJ.** Mechanism of sodium hyperabsorption in cultured cystic fibrosis nasal epithelium: a patch-clamp study. *Am J Physiol* 266: C1061-1068, 1994.
19. **Chuang HH, Prescott ED, Kong H, Shields S, Jordt SE, Basbaum AI, Chao MV, and Julius D.** Bradykinin and nerve growth factor release the capsaicin receptor from PtdIns(4,5)P₂-mediated inhibition. *Nature* 411: 957-962, 2001.
20. **Cuppoletti J, Tewari KP, Sherry AM, Kupert EY, and Malinowska DH.** ClC-2 Cl⁻ channels in human lung epithelia: activation by arachidonic acid, amidation, and acid-activated omeprazole. *Am J Physiol Cell Physiol* 281: C46-54, 2001.
21. **D'Arcangelo G, Paradiso K, Shepherd D, Brehm P, Halegoua S, and Mandel G.** Neuronal growth factor regulation of two different sodium channel types through distinct signal transduction pathways. *J Cell Biol* 122: 915-921, 1993.

22. **Denning GM, Ostedgaard LS, Cheng SH, Smith AE, and Welsh MJ.** Localization of cystic fibrosis transmembrane conductance regulator in chloride secretory epithelia. *J Clin Invest* 89: 339-349, 1992.
23. **Donaldson SH, Hirsh A, Li DC, Holloway G, Chao J, Boucher RC, and Gabriel SE.** Regulation of the epithelial sodium channel by serine proteases in human airways. *J Biol Chem* 277: 8338-8345, 2002.
24. **Dutzler R, Campbell EB, Cadene M, Chait BT, and MacKinnon R.** X-ray structure of a ClC chloride channel at 3.0 Å reveals the molecular basis of anion selectivity. *Nature* 415: 287-294, 2002.
25. **Gabriel SE, Makhlina M, Martsen E, Thomas EJ, Lethem MI, and Boucher RC.** Permeabilization via the P2X7 purinoreceptor reveals the presence of a Ca²⁺-activated Cl⁻ conductance in the apical membrane of murine tracheal epithelial cells. *J Biol Chem* 275: 35028-35033, 2000.
26. **Garcia-Caballero A, Rasmussen JE, Gaillard E, Watson MJ, Olsen JC, Donaldson SH, Stutts MJ, and Tarran R.** SPLUNC1 regulates airway surface liquid volume by protecting ENaC from proteolytic cleavage. *Proc Natl Acad Sci U S A* 106: 11412-11417, 2009.
27. **Good DW, George T, and Watts BA, 3rd.** Nerve growth factor inhibits Na⁺/H⁺ exchange and formula absorption through parallel phosphatidylinositol 3-kinase-mTOR and ERK pathways in thick ascending limb. *J Biol Chem* 283: 26602-26611, 2008.
28. **Greene LA and Shooter EM.** The nerve growth factor: biochemistry, synthesis, and mechanism of action. *Annu Rev Neurosci* 3: 353-402, 1980.

29. **Greene LA and Tischler AS.** Establishment of a noradrenergic clonal line of rat adrenal pheochromocytoma cells which respond to nerve growth factor. *Proc Natl Acad Sci U S A* 73: 2424-2428, 1976.
30. **Hansson JH, Schild L, Lu Y, Wilson TA, Gautschi I, Shimkets R, Nelson-Williams C, Rossier BC, and Lifton RP.** A de novo missense mutation of the β subunit of the epithelial sodium channel causes hypertension and Liddle syndrome, identifying a proline-rich segment critical for regulation of channel activity. *Proc Natl Acad Sci U S A* 92: 11495-11499, 1995.
31. **Hardiman KM and Matalon S.** Modification of sodium transport and alveolar fluid clearance by hypoxia: mechanisms and physiological implications. *Am J Respir Cell Mol Biol* 25: 538-541, 2001.
32. **Hollenhorst MI, Richter K, and Fronius M.** Ion transport by pulmonary epithelia. *J Biomed Biotechnol* 2011: 174306, 2011.
33. **Hughey RP, Bruns JB, Kinlough CL, Harkleroad KL, Tong Q, Carattino MD, Johnson JP, Stockand JD, and Kleyman TR.** Epithelial sodium channels are activated by furin-dependent proteolysis. *J Biol Chem* 279: 18111-18114, 2004.
34. **Hummler E, Barker P, Gatzky J, Beermann F, Verdumo C, Schmidt A, Boucher R, and Rossier BC.** Early death due to defective neonatal lung liquid clearance in α -ENaC-deficient mice. *Nat Genet* 12: 325-328, 1996.
35. **Jentsch TJ, Stein V, Weinreich F, and Zdebik AA.** Molecular structure and physiological function of chloride channels. *Physiol Rev* 82: 503-568, 2002.

36. **Jiang X, Ingbar DH, and O'Grady SM.** Adrenergic regulation of ion transport across adult alveolar epithelial cells: effects on Cl⁻ channel activation and transport function in cultures with an apical air interface. *J Membr Biol* 181: 195-204, 2001.
37. **Kalin N, Claass A, Sommer M, Puchelle E, and Tummeler B.** Δ F508 CFTR protein expression in tissues from patients with cystic fibrosis. *J Clin Invest* 103: 1379-1389, 1999.
38. **Kerem E, Bistritzer T, Hanukoglu A, Hofmann T, Zhou Z, Bennett W, MacLaughlin E, Barker P, Nash M, Quittell L, Boucher R, and Knowles MR.** Pulmonary epithelial sodium-channel dysfunction and excess airway liquid in pseudohypoaldosteronism. *N Engl J Med* 341: 156-162, 1999.
39. **Kerem E, Corey M, Kerem BS, Rommens J, Markiewicz D, Levison H, Tsui LC, and Durie P.** The relation between genotype and phenotype in cystic fibrosis-analysis of the most common mutation (Δ F508). *N Engl J Med* 323: 1517-1522, 1990.
40. **Kidd JF and Thorn P.** Intracellular Ca²⁺ and Cl⁻ channel activation in secretory cells. *Annu Rev Physiol* 62: 493-513, 2000.
41. **Lingrel JB, Orłowski J, Shull MM, and Price EM.** Molecular genetics of Na,K-ATPase. *Prog Nucleic Acid Res Mol Biol* 38: 37-89, 1990.
42. **Mairbaur H, Mayer K, Kim KJ, Borok Z, Bartsch P, and Crandall ED.** Hypoxia decreases active Na transport across primary rat alveolar epithelial cell monolayers. *Am J Physiol Lung Cell Mol Physiol* 282: L659-665, 2002.
43. **Matsui H, Grubb BR, Tarran R, Randell SH, Gatzky JT, Davis CW, and Boucher RC.** Evidence for periciliary liquid layer depletion, not abnormal ion

composition, in the pathogenesis of cystic fibrosis airways disease. *Cell* 95: 1005-1015, 1998.

44. **McDonough AA, Geering K, and Farley RA.** The sodium pump needs its β subunit. *FASEB J* 4: 1598-1605, 1990.

45. **Minakata Y, Suzuki S, Grygorczyk C, Dagenais A, and Berthiaume Y.** Impact of β -adrenergic agonist on Na^+ channel and Na^+ - K^+ -ATPase expression in alveolar type II cells. *Am J Physiol* 275: L414-422, 1998.

46. **Murray CB, Morales MM, Flotte TR, McGrath-Morrow SA, Guggino WB, and Zeitlin PL.** CIC-2: a developmentally dependent chloride channel expressed in the fetal lung and downregulated after birth. *Am J Respir Cell Mol Biol* 12: 597-604, 1995.

47. **Myerburg MM, McKenna EE, Luke CJ, Frizzell RA, Kleyman TR, and Pilewski JM.** Prostin expression is regulated by airway surface liquid volume and is increased in cystic fibrosis. *Am J Physiol Lung Cell Mol Physiol* 294: L932-941, 2008.

48. **Petersen OH.** Stimulus-secretion coupling: cytoplasmic calcium signals and the control of ion channels in exocrine acinar cells. *J Physiol* 448: 1-51, 1992.

49. **Planes C, Escoubet B, Blot-Chabaud M, Friedlander G, Farman N, and Clerici C.** Hypoxia downregulates expression and activity of epithelial sodium channels in rat alveolar epithelial cells. *Am J Respir Cell Mol Biol* 17: 508-518, 1997.

50. **Prince LS, Launspach JL, Geller DS, Lifton RP, Pratt JH, Zabner J, and Welsh MJ.** Absence of amiloride-sensitive sodium absorption in the airway of an infant with pseudohypoaldosteronism. *J Pediatr* 135: 786-789, 1999.

51. **Ridge KM, Dada L, Lecuona E, Bertorello AM, Katz AI, Mochly-Rosen D, and Sznajder JI.** Dopamine-induced exocytosis of Na,K-ATPase is dependent on activation of protein kinase C- ϵ and - ζ . *Mol Biol Cell* 13: 1381-1389, 2002.
52. **Riordan JR, Rommens JM, Kerem B, Alon N, Rozmahel R, Grzelczak Z, Zielenski J, Lok S, Plavsic N, Chou JL, and et al.** Identification of the cystic fibrosis gene: cloning and characterization of complementary DNA. *Science* 245: 1066-1073, 1989.
53. **Ruckes-Nilges C, Weber U, Lindemann H, Munker G, Clauss W, and Weber WM.** Minor role of Cl⁻ secretion in non-cystic fibrosis and cystic fibrosis human nasal epithelium. *Cell Physiol Biochem* 9: 1-10, 1999.
54. **Saldias FJ, Azzam ZS, Ridge KM, Yeldandi A, Rutschman DH, Schraufnagel D, and Sznajder JI.** Alveolar fluid reabsorption is impaired by increased left atrial pressures in rats. *Am J Physiol Lung Cell Mol Physiol* 281: L591-597, 2001.
55. **Schild L, Canessa CM, Shimkets RA, Gautschi I, Lifton RP, and Rossier BC.** A mutation in the epithelial sodium channel causing Liddle disease increases channel activity in the *Xenopus laevis* oocyte expression system. *Proc Natl Acad Sci U S A* 92: 5699-5703, 1995.
56. **Schubert D, LaCorbiere M, Whitlock C, and Stallcup W.** Alterations in the surface properties of cells responsive to nerve growth factor. *Nature* 273: 718-723, 1978.
57. **Skou JC.** Nobel Lecture. The identification of the sodium pump. *Biosci Rep* 18: 155-169, 1998.

58. **Skou JC and Esmann M.** The Na,K-ATPase. *J Bioenerg Biomembr* 24: 249-261, 1992.
59. **Song Y, Namkung W, Nielson DW, Lee JW, Finkbeiner WE, and Verkman AS.** Airway surface liquid depth measured in ex vivo fragments of pig and human trachea: dependence on Na⁺ and Cl⁻ channel function. *Am J Physiol Lung Cell Mol Physiol* 297: L1131-1140, 2009.
60. **Staub O, Dho S, Henry P, Correa J, Ishikawa T, McGlade J, and Rotin D.** WW domains of Nedd4 bind to the proline-rich PY motifs in the epithelial Na⁺ channel deleted in Liddle's syndrome. *EMBO J* 15: 2371-2380, 1996.
61. **Sverdlov ED, Monastyrskaya GS, Broude NE, Ushkaryov Yu A, Allikmets RL, Melkov AM, Smirnov Yu V, Malyshev IV, Dulobova IE, Petrukhin KE, and et al.** The family of human Na⁺,K⁺-ATPase genes. No less than five genes and/or pseudogenes related to the α -subunit. *FEBS Lett* 217: 275-278, 1987.
62. **Sznajder JI, Factor P, and Ingbar DH.** Invited review: lung edema clearance: role of Na⁺-K⁺-ATPase. *J Appl Physiol (1985)* 93: 1860-1866, 2002.
63. **Tabcharani JA, Chang XB, Riordan JR, and Hanrahan JW.** Phosphorylation-regulated Cl⁻ channel in CHO cells stably expressing the cystic fibrosis gene. *Nature* 352: 628-631, 1991.
64. **Tarran R, Loewen ME, Paradiso AM, Olsen JC, Gray MA, Argent BE, Boucher RC, and Gabriel SE.** Regulation of murine airway surface liquid volume by CFTR and Ca²⁺-activated Cl⁻ conductances. *J Gen Physiol* 120: 407-418, 2002.

65. **Thiemann A, Grunder S, Pusch M, and Jentsch TJ.** A chloride channel widely expressed in epithelial and non-epithelial cells. *Nature* 356: 57-60, 1992.
66. **Thomas G.** Furin at the cutting edge: from protein traffic to embryogenesis and disease. *Nat Rev Mol Cell Biol* 3: 753-766, 2002.
67. **Varon S and Skaper SD.** Short-latency ionic effects of nerve growth factor deprivation and readministration on ganglionic cells. *J Supramol Struct* 13: 329-337, 1980.
68. **Vergheze GM, Ware LB, Matthay BA, and Matthay MA.** Alveolar epithelial fluid transport and the resolution of clinically severe hydrostatic pulmonary edema. *J Appl Physiol (1985)* 87: 1301-1312, 1999.
69. **Watts BA, 3rd and Good DW.** ERK mediates inhibition of Na⁺/H⁺ exchange and HCO³⁻ absorption by nerve growth factor in MTAL. *Am J Physiol Renal Physiol* 282: F1056-1063, 2002.
70. **Willumsen NJ, Davis CW, and Boucher RC.** Cellular Cl⁻ transport in cultured cystic fibrosis airway epithelium. *Am J Physiol* 256: C1045-1053, 1989.
71. **Zhang X, Huang J, and McNaughton PA.** NGF rapidly increases membrane expression of TRPV1 heat-gated ion channels. *EMBO J* 24: 4211-4223, 2005.

Chapter 4

Research Plan

Introduction

In view of the substantial evidence linking NGF to several pulmonary diseases as reviewed in Chapter 3, we propose that NGF has the ability to alter ion transport properties of airway epithelial cells. Ion transport in airway epithelial cells is the mechanism by which ASL is regulated (3). As well, ion transport is involved in the release of epithelium-derived relaxing factor, which induces relaxation of airway smooth muscle and submucosal blood vessels (1, 4, 7). By affecting fluid balance in the lung, NGF could contribute to disease progression and severity.

The **goal** of this project is to determine whether NGF alters ion transport in airway epithelial cells, and to understand mechanisms by which NGF mediates these responses. We **hypothesize** that NGF affects ion transport in epithelial cells. To test our hypothesis, two specific aims have been developed.

Research design and methods

Specific Aim 1: To investigate the effect of NGF on ion transport in human airway epithelial cells.

Goal: To determine whether NGF alters ion transport in airway epithelial cells, and to understand how NGF initiates these responses.

Rationale: Because NGF has been shown to facilitate the rapid insertion of ion channels into the membrane of HEK 293 cells (9) and has been shown to alter the expression of proteins involved in neural signal transduction (2, 6), we propose that NGF

will elicit bioelectric responses and alter ion transport after incubation with airway epithelial cells.

1.1 To investigate immediate bioelectric responses to acute additions of NGF.

Normal human primary cultured epithelial cells that demonstrate desirable *in situ* morphology and ion transport function will be placed in Ussing chambers, and I_{sc} will be recorded. NGF concentration-response curves will be generated for the separate addition of NGF to the apical and basolateral chambers, because the NGF receptors are located on either the apical (trkA) and basolateral (p75^{NTR}) membranes (8). The concentration of NGF that elicits the largest bioelectric response will be used to conduct the remaining experiments.

To investigate the basis of NGF-induced bioelectric responses, specific ion transport inhibitors will be used, each one added to the appropriate chamber to inhibit the channel or transporter of interest. Inferences will be made by comparing the transport blockers' responses in the presence or absence of NGF. These results will identify the ionic basis for NGF-induced bioelectric changes.

1.2 To investigate the effect of incubation with NGF on ion transport.

To investigate if incubation with NGF alters ion transport (as opposed to the “acute” effect, specific aim 1.1), epithelial cells will be incubated with NGF for 24 and 48 hr. At the conclusion of NGF incubation, cells will be placed into an Ussing chamber, and responses to ion channel blockers will be measured and compared to control cells

incubated in the absence of NGF at each time point. Differences in responses to the ion channel blockers will allow us to make inferences as to the ion channels affected after incubation with NGF, and, using western blot analysis, we will determine if these changes are due to changes in channel/transporter expression.

Specific Aim 2: To investigate the molecular pathways involved in NGF signaling related to epithelial ion transport.

Goal: To determine and understand on a molecular level how NGF mediates alterations in bioelectric responses of airway epithelial cell.

Rationale: The receptors for NGF have been shown to be polarized across the epithelial cell, and the NGF response may vary depending on the site of exposure. We will investigate the molecular mechanism by which the NGF-induced bioelectric response is occurring.

2.1 To investigate the pathways responsible for NGF-induced alterations ion transport.

The data generated in specific aim 1.1 will provide insight into the receptor responsible for the acute NGF-induced alteration in ion transport. If NGF stimulates bioelectric responses when applied apically ion transport studies will be conducted in the presence of the non-specific tyrosine kinase inhibitor, K-252a, to investigate whether the trkA receptor is involved in mediating NGFs bioelectric response. If NGF stimulates bioelectric responses when applied to the basolateral membrane, ion transport studies will

be conducted in the presence of the p75^{NTR} receptor inhibitor, TAT-Pep5, to investigate whether the trkA receptor is involved in mediating NGFs bioelectric response. The results from these experiments will provide insight into the signaling pathway responsible for NGF-mediated bioelectric responses.

2.2 To investigate intracellular second messengers involved in NGF-induced signal transduction in human epithelial cells.

The signaling pathways of both p75^{NTR} and trkA have been extensively investigated (5). Both receptors are responsible for the activation of several intracellular signaling pathways, and in this specific aim we will investigate the pathways responsible for the alteration in the bioelectric properties of airway epithelial cells.

To investigate the intracellular signaling pathway(s) involved in early changes in ion transport (specific aim 2.1), western blot analysis of phosphorylated protein and unphosphorylated protein will be used.

1. **Fedan JS, Dowdy JA, Johnston RA, and Van Scott MR.** Hyperosmolar solution effects in guinea pig airways. I. Mechanical responses to relative changes in osmolarity. *J Pharmacol Exp Ther* 308: 10-18, 2004.
2. **Gingras J, Rassadi S, Cooper E, and Ferns M.** Agrin plays an organizing role in the formation of sympathetic synapses. *J Cell Biol* 158: 1109-1118, 2002.
3. **Marunaka Y, Niisato N, Taruno A, Ohta M, Miyazaki H, Hosogi S, Nakajima K, Kusuzaki K, Ashihara E, Nishio K, Iwasaki Y, Nakahari T, and Kubota T.** Regulation of epithelial sodium transport via epithelial Na⁺ channel. *J Biomed Biotechnol* 2011: 978196, 2011.
4. **Prazma J, Coleman CC, Shockley WW, and Boucher RC.** Tracheal vascular response to hypertonic and hypotonic solutions. *J Appl Physiol* 76: 2275-2280, 1994.
5. **Reichardt LF.** Neurotrophin-regulated signalling pathways. *Philos Trans R Soc Lond B Biol Sci* 361: 1545-1564, 2006.
6. **Smith MA, Fanger GR, O'Connor LT, Bridle P, and Maue RA.** Selective regulation of agrin mRNA induction and alternative splicing in PC12 cells by Ras-dependent actions of nerve growth factor. *J Biol Chem* 272: 15675-15681, 1997.
7. **Wu DX, Johnston RA, Rengasamy A, Van Scott MR, and Fedan JS.** Hyperosmolar solution effects in guinea pig airways. II. Epithelial bioelectric responses to relative changes in osmolarity. *J Pharmacol Exp Ther* 308: 19-29, 2004.
8. **Wu X, Myers AC, Goldstone AC, Toggias A, and Sanico AM.** Localization of nerve growth factor and its receptors in the human nasal mucosa. *J Allergy Clin Immunol* 118: 428-433, 2006.

9. **Zhang X, Huang J, and McNaughton PA.** NGF rapidly increases membrane expression of TRPV1 heat-gated ion channels. *EMBO J* 24: 4211-4223, 2005.

Chapter 5

**Nerve growth factor reduces amiloride-sensitive
Na⁺ transport in human airway epithelial cells**

Abstract

Nerve growth factor (NGF) is overexpressed in patients with inflammatory lung diseases, including virus infections. Airway surface liquid (ASL), which is regulated by epithelial cell ion transport, is essential for normal lung function. No information is available regarding the effect of NGF on ion transport of airway epithelium. To investigate whether NGF can affect ion transport, human primary air-interface cultured epithelial cells were placed in Ussing chambers to obtain transepithelial voltage (-7.1 ± 3.4 mV), short-circuit current (I_{sc} , 5.9 ± 1.0 μ A), and transepithelial resistance ($750 \Omega \cdot \text{cm}^2$), and to measure responses to ion transport inhibitors. Amiloride (apical, 3.5×10^{-5} mol/L) decreased I_{sc} by 55.3%. Apically applied NGF (1 ng/mL) reduced I_{sc} by 5.3% in 5 min; basolaterally applied NGF had no effect. The response to amiloride was reduced (41.6%) in the presence of NGF. K-252a (10 nmol/L, apical) did not itself affect Na^+ transport, but it attenuated the NGF-induced reduction in Na^+ transport, indicating the participation of the trkA receptor in the NGF-induced reduction in Na^+ transport. PD-98059 (30 μ mol/L, apical and basolateral) did not itself affect Na^+ transport, but attenuated the NGF-induced reduction in Na^+ transport, indicating that trkA activated the Erk 1/2 signaling cascade. NGF stimulated phosphorylation of Erk 1/2 and the β -subunit of ENaC. K-252a and PD-98059 inhibited these responses. NGF had no effect on I_{sc} in the presence of apical nystatin (50 μ mol/L). These results indicate that NGF inhibits Na^+ transport through a trkA-Erk 1/2-activated signaling pathway linked to ENaC phosphorylation.

Introduction

Nerve growth factor (NGF), the first member of the neurotrophin family discovered by Levi-Montalcini (Cohen et al. 1954), is involved in the development, growth, and survival of sympathetic nerves. Although NGF was discovered in the context of nerve growth and function, it has been shown to be produced by both structural and nonstructural cells in the lung (Hoyle 2003; Frossard et al. 2004). NGF is involved in the development of several airway diseases, such as asthma, and neurogenic inflammation (Braun et al. 1998; Nassenstein et al. 2006). Elevated levels of NGF have been shown to cause airway hyperreactivity, enhance the airway inflammatory response in ovalbumin-sensitized mice, and cause airway remodeling (Braun et al. 1998; Freund and Frossard 2004). Both NGF and its receptors, trkA and p75, are upregulated during respiratory syncytial virus infections (Hu et al. 2002; Tortorolo et al. 2005). No studies have been conducted to investigate the effect of NGF on ion transport in airway epithelial cells.

In addition to acting as a physical barrier, the polarized airway epithelial cells maintain the airway surface liquid (ASL), which is composed of a periciliary liquid layer (PCL) and a mucus phase. The PCL is necessary for mucociliary clearance of infectious organisms and inhaled particles (Toczyłowska-Maminska and Dolowy 2012). The PCL is maintained by the coordinated action of many ion channels, pumps, and transporters (Knowles et al. 1984; Toczyłowska-Maminska and Dolowy 2012). Disruption of ion transport can contribute to airway diseases, such as mucus thickening in cystic fibrosis due to PCL dehydration, lung edema due to an inhibition of epithelial Na⁺ channels (ENaC; Chen et al. 2004; Morty et al. 2007; Ji et al. 2009), and interfere with regulatory mechanisms in the airways, such as the release of epithelium-derived relaxing factor which induces relaxation of airway smooth muscle and submucosal blood vessels (Prazma et al. 1994; Fedan et al. 2004; Wu et al. 2004).

There is a large body of evidence supporting the notion that NGF can alter ion transport in nonpulmonary cells. For example, in PC12 cells, NGF has been demonstrated to increase Na⁺ current (Pollock et al. 1990), increase Na⁺/K⁺-pump activity (Boonstra et al. 1983), induce type II/IIA Na⁺ channel gene expression (D'Arcangelo et al. 1993), and induce expression of the peripheral nerve-Na⁺ channel gene, PN42 (Toledo-Aral et al. 1995). In the renal medullary thick ascending limb (MTAL), NGF inhibits the Na⁺/H⁺ exchanger 1 (NHE1; Watts and Good 2002).

In view of the substantial evidence linking NGF to pulmonary diseases, as well NGF's ability to alter ion transport in PC12 and the MTAL cells, we hypothesized that NGF is involved in the regulation of ion transport in airway epithelial cells. Our results suggest that NGF produces a rapid reduction in amiloride-sensitive Na⁺ transport in human airway epithelial cells, that is accompanied by phosphorylation of Erk1/2 and the β-subunit of ENaC.

Methods

Cell Culture

Normal human bronchial epithelial cells (NHBE, CC- 2540S; Lonza, Walkersville, MD) were cultured according to the manufacturer's instructions. NHBE cells were seeded and expanded (<20 doublings) in a T-75 flask supported by bronchial air-liquid interface (B-ALI) growth media containing the recommended supplements (B-ALI BulletKit, 193514; Lonza). Cells were grown to 80–90% confluence. Following trypsinization (100 $\mu\text{L}/\text{cm}^2$, 5 min, 25°C), the cells were transferred to semipermeable rat tail collagen (354236; BD Biosciences, San Jose, CA)-coated polyester transwell inserts (0.4 μm pore size; 0.33 cm^2 ; 3470; Corning, Corning, NY) at a density of 50,000 cells/well. The cells were cultured using B-ALI growth medium in both apical and basolateral compartments for approximately 3 days or until the cells became confluent. Once confluent, the cells were placed under ALI culture conditions, and only supported by B-ALI differentiation media containing the recommended supplements in the basolateral compartment. The cells were allowed to grow for 21 days under ALI conditions with daily media changes. Growth to confluence was monitored by measuring transepithelial resistance (R_t , EVOM²; World Precision Instruments, Sarasota, FL), and cells were used after 21 days of growth and when R_t was approximately 1000 $\Omega\cdot\text{cm}^2$ (Fig. 1).

Cell imaging

Differentiation into a ciliated pseudo-stratified epithelial cell culture was confirmed through a series of imaging and staining techniques. The membrane inserts were fixed in 10% buffered formalin, rinsed in Hank's balanced salt solution (37°C), dehydrated in graded series of ethanol, cleared in xylene, infiltrated, and embedded in paraffin. Sections (5 μm) were placed on

microscope slides, and stained with hematoxylin and eosin (H&E). The samples were imaged on an Olympus IX70 photomicroscope (Shinjuku, Tokyo, Japan). H&E staining revealed the presence of a pseudo-stratified epithelial cell culture.

Mucus production was confirmed using alcian blue staining. Membrane inserts were stained apically with a 1% alcian blue solution (3% acetic acid, pH 2.5) for 30 sec. The alcian blue solution was removed, and cells were imaged on a Zeiss Axiovert 100 microscope (Oberkochen, Germany) equipped with a Pixera Pro 150ES camera (Santa Clara, CA).

The presence of cilia was confirmed by immunofluorescence from β -tubulin, scanning electron microscopy (SEM), and transmission electron microscopy (TEM). For β -tubulin immunofluorescence membrane inserts were washed with PBS, fixed with apically applied methanol (4°C), and stained using a monoclonal antitubulin-FITC antibody (F2043; Sigma-Aldrich, St. Louis, MO). β -tubulin was detected using immunofluorescence on a Axiovert 100 microscope equipped with a Pixera Pro 150ES camera. For SEM, the samples were fixed in 4% paraformaldehyde fixative and postfixed in osmium tetroxide. The cells were dehydrated in an ethanol series, dried using hexamethyldisilizane as the final solution and coated with gold/palladium. The samples were imaged on a Hitachi 4800 field emission scanning electron microscope (Chiyoda, Tokyo). For TEM, the samples were fixed in Karnovsky's fixative (2.5% glutaraldehyde, 2.5% paraformaldehyde in 0.1 mol/L sodium cacodylic buffer), postfixed in osmium tetroxide, mordanted in 1% tannic acid, and stained en bloc in 0.5% uranyl acetate. The cells were dehydrated in an ethanol series and embedded in Epon, sectioned, and stained with Reynold's lead citrate and an aqueous uranyl acetate. The sections were imaged on a JEOL 1220 transmission electron microscope (Peabody, MA).

Ion transport in cultured epithelial cells

Transwell cell culture inserts were placed into Ussing chambers (Physiologic Instruments, San Diego, CA). Cells were bathed in modified Krebs-Henseleit solution (MKHS, 113.0 mmol/L NaCl; 4.8 mmol/L KCl; 2.5 mmol/L CaCl₂; 1.2 mmol/L KH₂PO₄; 1.2 mmol/L MgSO₄; 25.0 mmol/L NaHCO₃; and 5.7 mmol/L glucose; pH 7.4; 37°C; gassed with 95% O₂, 5% CO₂) in both apical and basolateral hemi-chambers. Cells were stabilized under open-circuit conditions before applying a 0 mV voltage-clamp using an automatic voltage/current amplifier (EVC 4000, World Precision Instruments or VCC MC8; Physiological Instruments). Short-circuit current (I_{sc}) and R_t were monitored to investigate whether responses to agents were due to a change in transcellular as opposed to paracellular ion transport. This was done by delivering 5-sec long, 1 mV pulses every 55 sec and calculating R_t using Ohm's law.

Effects of NGF and agents on ion transport

After stabilization of I_{sc} , concentration–response curves for apical and basolateral additions of NGF (SRP3018, 0.001–100 ng/mL NGF; Sigma-Aldrich) were generated. The ability of NGF to alter ion transport responses to amiloride (3.5×10^{-5} mol/L), NPPB (10^{-4} mol/L), and ouabain (10^{-4} mol/L) were evaluated in the absence or presence of 1 ng/mL NGF. To investigate whether the NGF receptor, trkA, mediates the effects of NGF on ion transport, cells were incubated for 30 min with the nonspecific tyrosine kinase inhibitor, K-252a (10 nmol/L, apical, K1639; Sigma-Aldrich), or DMSO (0.004%). Subsequently, responses to the ion transport inhibitors were obtained in the absence or presence of NGF. To investigate whether trkA activates the Erk1/2 signaling pathway during responses to NGF, cells were incubated 60 min with the Erk1/2-specific inhibitor, PD-98059 (30 μ mol/L, apical and basolateral; 9900L, Cell

Signaling, Danvers, MA) or DMSO (0.06%). Responses to the ion transport inhibitors mentioned above were obtained in the absence or presence of NGF after 60 min incubation with either PD-98059 or DMSO. To investigate whether NGF could alter ion transport after a 24- and 48-h incubation, cells were incubated apically with MKHS only or MKHS containing 1 ng/mL of NGF. Responses to known ion transport inhibitors were evaluated to investigate changes in ion transport. To investigate whether the effects of NGF involved changes in Na⁺/K⁺-ATPase activity, the apical membrane was permeabilized with nystatin (50 μmol/L, N6261; Sigma-Aldrich) and responses to ouabain generated in the absence or presence of NGF were compared. Results are expressed as a percent change in baseline I_{sc} . Results obtained in the presence of nystatin are expressed as a percent change from the I_{sc} value in the presence of nystatin.

NGF stability and concentration after prolonged incubation periods

To investigate the stability of NGF in sterile MKHS (the medium in which cells were bathed in Ussing chambers), MKHS with or without 1 ng/mL NGF was added apically to transwell cell culture inserts, lacking or containing cells, and incubated at 37°C for 5 min, 6, 24, and 48 h. The basolateral chamber contained MKHS only. An enzyme linked immunosorbent assay (ELISA; ab99986; Abcam, Cambridge, MA) was used to measure the apical NGF concentration and endogenous release of NGF from epithelial cells. Results were expressed as a percent change from the initial NGF concentration.

Protein analysis using western blots of NHBE cells incubated with NGF

Cell lysates were prepared from NHBE cells cultured under ALI culture for 21 days. Cells were treated with K-252a (10 nmol/L, 30 min, apical) or PD-98059 (30 μmol/L, 60 min,

apical and basolateral) prior to incubation with either MKHS or MKHS containing 1 ng/ml NGF. Cells were washed with PBS (4°C) and lysed with Pierce RIPA buffer (89901, Thermo Fisher Scientific, Waltham, MA) containing halt protease inhibitor (78430, Thermo Fisher Scientific), 5 mmol/L EDTA (1960851, Thermo Fisher Scientific), and phosphatase inhibitor cocktail 2 (P5726, Sigma-Aldrich). Cell lysates were sonicated for two rounds of 10-sec pulses, centrifuged at 14,000 rpm for 5 min, and protein concentrations were determined using a BCA protein assay (23227, Thermo Fisher Scientific). Samples were denatured in Laemmli sample buffer (161-0737, BioRad, Hercules, CA) containing β -mercaptoethanol (M-6250, Sigma-Aldrich) at 95°C. Proteins were separated on a 4–15% mini-protein TGX Gel (456-1034, BioRad), and transferred to a nitrocellulose membrane (162-0112, Bio-Rad). Membranes were blocked for 1 h with Odyssey blocking buffer (927-40000, Li-Cor, Lincoln, NE) before being probed for 1 h with the primary antibodies for β -ENaC and phosphorylated- β -ENaC (T615)(ab28668 and ab79172, Abcam, Cambridge, MA), Erk 1/2 and phosphorylated-Erk 1/2 (ab36991 and ab4819, Abcam), and β -actin (ab8227, Abcam). Membranes were washed three times with TBST-20 (28360, Thermo Fisher Scientific), incubated with the secondary antibody, IRDye 680LT (926-68021, Li-Cor) or IRDye 800CW (926-32210, Li-Cor), washed three more times with TBST-20, and then developed and analyzed on an Odyssey infrared imaging system (9120, Li-Cor) with software version 3.0.30. Membranes were stripped between incubations with primary antibodies using OneMinute Advanced Western Blot Stripping Buffer (GM6031, GM Biosciences, Rockville, MD). Results are expressed as a percent of control.

Statistical analysis

Statistical comparisons between groups containing multiple donors were performed with SAS/STAT software (v9.2) for Windows, utilizing the Proc Mixed function to carry out a one-way analysis of variance. Statistical comparisons between groups involving cells from a single donor were performed with SigmaPlot 11.0 to carry out a one-way analysis of variance. Differences were considered significant at $p < 0.05$.

Results

Airway epithelial cell characteristics

Cells were cultured under ALI conditions for 30 days, and R_t was measured daily (Fig. 1). The cells generated high epithelial resistance similar to that reported previously in NHBE cultures grown using ALI conditions (Lin et al. 2007). The cells reached a maximum R_t on day 30 ($1792 \pm 87 \Omega \cdot \text{cm}^2$), and averaged an R_t of $1204 \pm 66 \Omega \cdot \text{cm}^2$ from day 10 onward.

The NHBE cells grew into a well-differentiated airway epithelium resembling that of in situ tissue. H&E staining (Fig. 2A) revealed that cells differentiated into a pseudostratified epithelium with the presence of cilia on the apical membrane. The production of mucus was confirmed using alcian blue staining (Fig. 2B). The formation of cilia was confirmed using SEM (Fig. 2C), TEM (Fig. 2D), and immunofluorescence for β -tubulin, a marker for cilia (Fig. 2E). The TEM imaging revealed the presence of a 9 + 2 doublet in cilia, indicating that the structures were not microvilli.

After 21 days of ALI culture, cells placed into a Ussing chamber and allowed to equilibrate under open-circuit conditions displayed a V_t value of $-7.1 \pm 3.4 \text{ mV}$. Basal I_{sc} was $5.9 \pm 1.0 \mu\text{A}/\text{cm}^2$ (average of 4 donors). Preliminary NGF concentration–response curves (0.001–100 ng/mL) were generated to investigate whether NGF could elicit bioelectrical responses in airway epithelial cells (data not shown). The addition of NGF to the apical membrane resulted in a reduction in I_{sc} . NGF did not evoke responses at any concentration after being applied basolaterally. The concentrations used to generate these NGF concentration–response curves are clinically relevant and reflect levels found in both the blood and BAL-fluid samples of infants experiencing respiratory infections and after surgery (Tortorolo et al. 2005). Based on the

concentration–response analysis, 1 ng/mL of NGF applied to the apical membrane was used routinely for the remaining experiments as this concentration provided the maximum response.

NGF reduces amiloride-sensitive Na⁺ transport

To investigate the basis of the bioelectric responses to NGF, ion transport inhibitors were added apically or basolaterally as appropriate, in the absence (Fig. 3A) or presence (Fig. 3B) of 1 ng/mL NGF. The addition of 1 ng/mL NGF to the apical chamber resulted in a $5.3 \pm 1.5\%$ reduction in I_{sc} . In the absence of NGF, amiloride (3.5×10^{-5} mol/L, apical), which inhibits the ENaC, caused a $55.3 \pm 4.6\%$ reduction in I_{sc} , but in the presence of NGF, amiloride reduced the I_{sc} by $41.6 \pm 3.0\%$ (Fig. 4A; $P = 0.0127$). NGF had no effect on the response to the Cl⁻ channel inhibitor, NPPB (Fig. 4B; apical, 10^{-4} mol/L; control $11.9 \pm 1.6\%$, NGF $13.8 \pm 1.7\%$; $P = 0.800$) or the Na⁺/K⁺-ATPase inhibitor, ouabain (Fig. 4C; basolateral; control $31.9 \pm 2.6\%$, NGF $35.8 \pm 2.6\%$; $P = 1.00$). The decrease in amiloride-sensitive Na⁺ transport by NGF was observed in the epithelium from four different donors (Fig. 5). Because of the consistency of the amiloride response between donors, it was decided to use the epithelial cells from one donor for the remaining experiments.

In the above experiments the cells had been incubated with NGF until a stable response was obtained, that is, ~5 min, before amiloride was applied. To investigate whether the effect of NGF on Na⁺ transport was maintained for longer period of time, responses to amiloride were generated following 30-min incubation with 1 ng/mL NGF. Under these conditions responses to amiloride were reduced in magnitude in the presence of NGF, albeit not significantly (Fig. 6).

NGF reduces amiloride-sensitive Na⁺ transport through a trkA receptor-mediated pathway

To investigate whether the trkA receptor, which has been identified histologically on the apical surface of airway epithelial cells (Wu et al. 2006), mediates the reduction in amiloride-sensitive Na^+ transport in response to NGF, cells were incubated for 30 min with the nonspecific tyrosine kinase inhibitor K-252a (10 nmol/L; apical) or DMSO as the vehicle control (0.004%). K-252a significantly reduced NGF responses (Fig. 7A). K-252a itself did not have an effect on amiloride-sensitive I_{sc} , but K-252a attenuated the NGF-induced reduction in Na^+ transport (Fig. 7B). There were no significant changes in the responses to NPPB or ouabain, indicating that there were no changes in Cl^- transport or Na^+/K^+ -ATPase activity (Fig. 7C and D). These results suggest that the trkA receptor mediates bioelectric responses to NGF and its activation inhibits amiloride-sensitive Na^+ transport.

NGF reduces amiloride-sensitive Na^+ transport through a trkA/Erk1/2-mediated pathway

The trkA receptor, when activated by NGF, can activate several intracellular signaling cascades, including the Erk1/2 signaling pathway (Segal and Greenberg 1996). To investigate whether the NGF-induced reduction in amiloride-sensitive Na^+ transport involves the activation of the Erk1/2 signaling cascade, cells were incubated with either the Erk1/2 inhibitor, PD-98059 (30 $\mu\text{mol/L}$; apical and basolateral), or DMSO (0.06%) 60 min prior to generating responses to ion transport inhibitors in the absence or presence of NGF. PD-98059 itself significantly reduced the response to NGF (Fig. 8A), and also attenuated the NGF-induced reduction in amiloride-sensitive Na^+ transport (Fig. 8B). Again, there were no significant changes in the responses to NPPB or ouabain, indicating that there were no changes in Cl^- transport or Na^+/K^+ -ATPase activity (Fig. 8C and D). These findings suggest that Erk1/2 participates in the reduction in amiloride-sensitive Na^+ transport in response to NGF.

NGF does not affect Na⁺/K⁺ ATPase activity

Although apically applied NGF did not result in significant changes in Na⁺/K⁺-ATPase activity (Fig. 4C), Erk 1/2 activation has been reported to affect Na⁺/K⁺-ATPase expression (Guerrero et al. 2001) and activity (Lei et al. 2008) in alveolar epithelial cells. It is possible, therefore, that NGF could affect Na⁺/K⁺-ATPase activity in addition to Na⁺ transport. To investigate whether NGF affects Na⁺/K⁺-ATPase activity, the apical membrane was permeabilized with nystatin (50 μmol/L; apical), and responses to ouabain were obtained in the absence (Fig. 9A) or presence (Fig. 9B) of NGF (1 ng/mL). In the presence of nystatin, apically applied NGF had no effect on *I*_{sc}, in contrast to responses of cells in the absence of nystatin (data not shown). There was no significant difference in the responses to ouabain between the vehicle control and NGF-treated groups (Control 98.4 ± 1.2%, NGF 99.7 ± 0.8%; data not shown). These results suggest that the NGF-induced Erk 1/2 activation is a localized signaling event which occurs at the apical membrane that affects amiloride-sensitive Na⁺ transport but not basolateral Na⁺/K⁺-ATPase activity.

Prolonged incubation with NGF

To examine the effect of prolonged incubation with NGF, cells which were incubated for 24 h (Fig. 10A–C) or 48 h (Fig. 10D–F) with apically applied NGF (1 ng/mL) or MKHS, were placed into the Ussing system to measure responses to amiloride. NGF did not reduce the amiloride-sensitive Na⁺ transport in cells incubated for either 24 or 48 h, which suggested at first that the reduction in Na⁺ transport is a transient, nongenomic cellular response to NGF.

We considered the possibility that the lack of a lasting effect of NGF on amiloride-sensitive Na⁺ transport could be due to a reduction in NGF concentration during the incubation

period or due to desensitization of the cells. Therefore, an ELISA specific for β -NGF was used to measure the NGF concentration in the apical solution. Transwell inserts with and without cells were incubated for 5 min, or 6, 24, and 48 h apically with either NGF (1 ng/mL) or MKHS. After incubation, the apical solution was collected and analyzed for NGF. There were no detectable levels of endogenous NGF in any of the transwell inserts with or without cells incubated with MKHS. However, following 5-min incubation on inserts which contained cells, the NGF concentration was reduced by 93%. Transwell inserts which did not contain cells and were incubated with NGF did not reveal a reduction in NGF concentration, indicating that NGF was either metabolized by epithelial proteases or NGF was internalized into the cells with the trkA receptor, as reported previously (Saragovi et al. 1998).

In the presence of epithelial cells, $94.7 \pm 0.4\%$, $94.9 \pm 0.5\%$, and $96.1 \pm 0.1\%$ reductions in NGF concentration were observed following 6, 24, and 48 h of incubation, respectively. In inserts lacking cells, which did not reveal a decrease in NGF after 5 min, there were $84.2 \pm 2.3\%$, $99.8 \pm 0.1\%$, and $99.9 \pm 0.0\%$ reductions in NGF concentration following a 6-, 24-, and 48-h incubation, respectively. The reduction of NGF in transwell inserts without cells demonstrates that NGF is degraded when incubated at 37°C in MKHS for a prolonged period of time.

NGF mediates ENaC phosphorylation through a trkA-Erk 1/2 signaling pathway

In the Ussing system experiments, we demonstrated that NHBE cells respond electrophysiologically to apically applied NGF, and, in the presence of NGF, amiloride sensitive Na^+ transport was attenuated. Furthermore, K-252a and PD-98059 inhibited NGF's effect. Apically permeabilized epithelial cells were unresponsive to NGF, and NGF was found to have no effect on the Na^+/K^+ -ATPase activity. Epidermal growth factor (EGF) also has been shown to

activate an Erk 1/2-mediated pathway and selectively inhibit ENaC without affecting Na⁺/K⁺-ATPase activity (Shen and Cotton 2003). Thus, the ability of NGF to activate the Erk 1/2 signaling, as well as the possibility that NGF, acting through this second messenger pathway, could phosphorylate ENaC was investigated. Treatment with apical NGF (1 ng/mL, 5 min) resulted in a twofold Erk 1/2 activation (Fig. 11A) and a threefold increase in β-ENaC phosphorylation (Fig. 11B) as compared to controls. The increases in Erk 1/2 activity and β-ENaC phosphorylation were blocked by K-252a (10 nmol/L, apical) and PD-98059 (30 μmol/L, apical and basolateral; Fig. 11C). Although there was a threefold increase in β-ENaC phosphorylation, there were no changes in total β-ENaC (Fig. 12). These results could suggest that NGF, acting through a trkA-Erk 1/2-mediated pathway, causes the phosphorylation of ENaC, which could be associated with reduced Na⁺ transport.

Discussion

The addition of NGF to the apical membrane of NHBE cells decreased I_{sc} , and reduced amiloride-sensitive Na^+ transport. NGF did not affect Cl^- transport or Na^+/K^+ -ATPase activity, as there were no effects on the responses to NPPB or ouabain, and NGF was ineffective in the presence of nystatin to short circuit the apical membrane. The nonspecific tyrosine kinase inhibitor, K-252a, as well as the specific Erk 1/2 inhibitor, PD-98059, attenuated both the response to NGF as well as the NGF-induced reduction in amiloride-sensitive Na^+ transport. NGF did not reduce amiloride-sensitive Na^+ transport after a 24- or 48-h incubation, which appears to be a result of NGF degradation. This finding also implies that NGF did not elicit early genomic effects to change ion transporter expression under the conditions of our experiments. The results would suggest that NGF, acting through a trkA-Erk1/2- mediated signaling pathway leading to ENaC phosphorylation, reduces Na^+ transport in airway epithelial cells.

There has been extensive work to investigate the regulatory mechanisms controlling ENaC, as ENaC not only plays a critical role in airway fluid clearance but also in the kidney where it is involved in maintaining blood volume and pressure (Bhalla and Hallows 2008). The regulation of ENaC can be controlled through a variety of both extrinsic and intrinsic factors, both through genomic effects, such as protein synthesis, and nongenomic effects, such as the change in the number of ENaC channels expressed on the membrane or a change in ENaC kinetics. The rapidity of the NGF-induced reduction in Na^+ transport would suggest that the mechanism involves a nongenomic mechanism(s).

The addition of NGF to the apical membrane, but not the basolateral membrane, resulted in a decrease in I_{sc} . Previous work suggests the specific trafficking of the trkA receptor to the apical membrane and the p75 receptor to the basolateral membrane (Wu et al. 2006). The lack of

bioelectric response when NGF was applied to the basolateral membrane, as well as the significant reduction in the response to apically applied NGF in the presence of K-252a, would suggest the interaction of NGF with the apical trkA receptor led to altered ion transport.

NGF, specifically protein loops 2 and 4, interacts with the trkA receptor, but not with the p75 receptor, to phosphorylate and activate the Erk1/2 signaling pathway (Xie et al. 2000). The interaction between NGF and trkA occurs within 1 min, with maximum trkA activation occurring after a 5-min incubation with NGF (Kaplan et al. 1991). Activated Erk 1/2 mediates the phosphorylation of two specific threonine residues on the β - and γ -ENaC subunits located near a PXTTP motif on the cytosolic C-terminus (Shi et al. 2002). The phosphorylation of β Thr-613 and γ Thr-623 on ENaC results in much higher binding affinity between the WW domain on the E3 ubiquitin-protein ligase Nedd4 and the PXTTP motif on ENaC, resulting in the ubiquitination and downregulation of ENaC. Although NGF activates the Erk1/2 signaling pathway downstream of the trkA receptor and activated Erk1/2 has been shown to phosphorylate and downregulate ENaC, no previous study has investigated NGF's ability to activate the Erk1/2 signaling pathway and the resulting phosphorylation of ENaC in airway epithelial cells.

The ELISA data demonstrated a rapid reduction (93% in 5 min) in apically applied NGF in the presence of epithelial cells. Without NGF present in the apical bath continued signal activation would not be expected to occur. However, NGF has been shown to cause trkA activation in 1 min (Kaplan et al. 1991) and maximum Erk activation 1.5 min after exposure (Saragovi et al. 1998). This rapid signaling coincides with the rapid electrophysiological responses stimulated by NGF. Thus, the bioelectric and the biochemical events would appear to have followed a similar time course. After 30-min incubation with NGF, at a time when NGF concentration in the chamber had diminished substantially, the effect of amiloride was blunted

and was no longer significant. This must reflect the decline in NGF levels during this period. But the fact that there was a trend toward an effect on responses to amiloride could suggest, interestingly, that NGF had initiated a longer term, “hit and run” effect during the first 5 min of incubation.

Although we observed a threefold increase in β -ENaC phosphorylation after a 5-min incubation with NGF, we did not observe a reduction in total β -ENaC (Fig. 12) over the measurement period. Falin and Cotton (2007) using MDCK cells demonstrated that EGF induced an Erk-mediated reduction in Na^+ transport as a result of ENaC phosphorylation, but a reduction in ENaC surface expression was not observed until after 60 min. It is possible that longer incubations with NGF (under conditions in which NGF levels might somehow be stabilized in MKHS) could reveal ENaC degradation late in the response. During diseases such RSV infections, NGF is significantly increased in the cell fraction of the bronchoalveolar lavage fluid, but not in the serum (Tortorolo et al. 2005). This increased NGF level has been attributed to increased production by the infiltrating inflammatory cells. The increased production and release of NGF by inflammatory cells would result in a continuous release of NGF and exposure of the epithelium, and, perhaps, initiate changes in ion transport by mechanisms uncovered during this investigation.

Acknowledgments

The findings and conclusions in this report are those of the authors and do not necessarily represent the views of the National Institute for Occupational Safety and Health. Mention of brand name does not constitute product endorsement.

Conflict of Interest

None declared.

References

- Bhalla, V., and K. R. Hallows. 2008. Mechanisms of ENaC regulation and clinical implications. *J. Am. Soc. Nephrol.* 19:1845–1854.
- Boonstra, J., W. H. Moolenaar, P. H. Harrison, P. Moed, P. T. van der Saag, and S. W. de Laat. 1983. Ionic responses and growth stimulation induced by nerve growth factor and epidermal growth factor in rat pheochromocytoma (PC12) cells. *J. Cell Biol.* 97:92–98.
- Braun, A., E. Appel, R. Baruch, U. Herz, V. Botchkarev, R. Paus, et al. 1998. Role of nerve growth factor in a mouse model of allergic airway inflammation and asthma. *Eur. J. Immunol.* 28:3240–3251.
- Chen, X. J., S. Seth, G. Yue, P. Kamat, R. W. Compans, D. Guidot, et al. 2004. Influenza virus inhibits ENaC and lung fluid clearance. *Am. J. Physiol. Lung Cell. Mol. Physiol.* 287:L366–L373.
- Cohen, S., R. Levi-Montalcini, and V. Hamburger. 1954. A nerve growth-stimulating factor isolated from sarcomas 37 and 180. *Proc. Natl Acad. Sci. USA* 40:1014–1018.
- D’Arcangelo, G., K. Paradiso, D. Shepherd, P. Brehm, S. Halegoua, and G. Mandel. 1993. Neuronal growth factor regulation of two different sodium channel types through distinct signal transduction pathways. *J. Cell Biol.* 122:915–921.
- Falin, R. A., and C. U. Cotton. 2007. Acute downregulation of ENaC by EGF involves the PY motif and putative ERK phosphorylation site. *J. Gen. Physiol.* 130:313–328.
- Fedan, J. S., J. A. Dowdy, R. A. Johnston, and M. R. Van Scott. 2004. Hyperosmolar solution effects in guinea pig airways. I. Mechanical responses to relative changes in osmolarity. *J. Pharmacol. Exp. Ther.* 308:10–18.

Freund, V., and N. Frossard. 2004. Expression of nerve growth factor in the airways and its possible role in asthma. *Prog. Brain Res.* 146:335–346.

Frossard, N., V. Freund, and C. Advenier. 2004. Nerve growth factor and its receptors in asthma and inflammation. *Eur. J. Pharmacol.* 500:453–465.

Guerrero, C., E. Lecuona, L. Pesce, K. M. Ridge, and J. I. Sznajder. 2001. Dopamine regulates Na-K-ATPase in alveolar epithelial cells via MAPK-ERK-dependent mechanisms. *Am. J. Physiol. Lung Cell. Mol. Physiol.* 281: L79–L85.

Hoyle, G. W. 2003. Neurotrophins and lung disease. *Cytokine Growth Factor Rev.* 14:551–558.

Hu, C., K. Wedde-Beer, A. Auais, M. M. Rodriguez, and G. Piedimonte. 2002. Nerve growth factor and nerve growth factor receptors in respiratory syncytial virus-infected lungs. *Am. J. Physiol. Lung Cell. Mol. Physiol.* 283:L494–L502.

Ji, H. L., W. Song, Z. Gao, X. F. Su, H. G. Nie, Y. Jiang, et al. 2009. SARS-CoV proteins decrease levels and activity of human ENaC via activation of distinct PKC isoforms. *Am. J. Physiol. Lung Cell. Mol. Physiol.* 296:L372–L383.

Kaplan, D. R., D. Martin-Zanca, and L. F. Parada. 1991. Tyrosine phosphorylation and tyrosine kinase activity of the trk proto-oncogene product induced by NGF. *Nature* 350:158–160.

Knowles, M., G. Murray, J. Shallal, F. Askin, V. Ranga, J. Gatzky, et al. 1984. Bioelectric properties and ion flow across excised human bronchi. *J. Appl. Physiol.* 56:868–877.

Lei, J., C. N. Mariash, M. Bhargava, E. V. Wattenberg, and D. H. Ingbar. 2008. T3 increases Na-K-ATPase activity via a MAPK/ERK1/2-dependent pathway in rat adult alveolar epithelial cells. *Am. J. Physiol. Lung Cell. Mol. Physiol.* 294: L749–L754.

Lin, H., H. Li, H. J. Cho, S. Bian, H. J. Roh, M. K. Lee, et al. 2007. Air–liquid interface (ALI) culture of human bronchial epithelial cell monolayers as an in vitro model for airway drug transport studies. *J. Pharm. Sci.* 96:341–350.

Morty, R. E., O. Eickelberg, and W. Seeger. 2007. Alveolar fluid clearance in acute lung injury: what have we learned from animal models and clinical studies? *Intensive Care Med.* 33:1229–1240.

Nassenstein, C., O. Schulte-Herbruggen, H. Renz, and A. Braun. 2006. Nerve growth factor: the central hub in the development of allergic asthma? *Eur. J. Pharmacol.* 533: 195–206.

Pollock, J. D., M. Krempin, and B. Rudy. 1990. Differential effects of NGF, FGF, EGF, cAMP, and dexamethasone on neurite outgrowth and sodium channel expression in PC12 cells. *J. Neurosci.* 10:2626–2637.

Prazma, J., C. C. Coleman, W. W. Shockley, and R. C. Boucher. 1994. Tracheal vascular response to hypertonic and hypotonic solutions. *J. Appl. Physiol.* 76:2275–2280.

Saragovi, H. U., W. Zheng, S. Maliartchouk, G. M. DiGuglielmo, Y. R. Mawal, A. Kamen, et al. 1998. A TrkA-selective, fast internalizing nerve growth factor-antibody complex induces trophic but not neuritogenic signals. *J. Biol. Chem.* 273:34933–34940.

Segal, R. A., and M. E. Greenberg. 1996. Intracellular signaling pathways activated by neurotrophic factors. *Annu. Rev. Neurosci.* 19:463–489.

Shen, J. P., and C. U. Cotton. 2003. Epidermal growth factor inhibits amiloride-sensitive sodium absorption in renal collecting duct cells. *Am. J. Physiol. Renal Physiol.* 284: F57–F64.

Shi, H., C. Asher, A. Chigaev, Y. Yung, E. Reuveny, R. Seger, et al. 2002. Interactions of beta and gamma ENaC with Nedd4 can be facilitated by an ERK-mediated phosphorylation. *J. Biol. Chem.* 277:13539–13547.

Toczyłowska-Maminska, R., and K. Dolowy. 2012. Ion transporting proteins of human bronchial epithelium. *J. Cell. Biochem.* 113:426–432.

Toledo-Aral, J. J., P. Brehm, S. Halegoua, and G. Mandel. 1995. A single pulse of nerve growth factor triggers long-term neuronal excitability through sodium channel gene induction. *Neuron* 14:607–611.

Tortorolo, L., A. Langer, G. Polidori, G. Vento, B. Stampachiacchere, L. Aloe, et al. 2005. Neurotrophin overexpression in lower airways of infants with respiratory syncytial virus infection. *Am. J. Respir. Crit. Care Med.* 72:233–237.

Watts, B. A. 3rd, and D. W. Good. 2002. ERK mediates inhibition of Na⁺/H⁺ exchange and HCO₃ absorption by nerve growth factor in MTAL. *Am. J. Physiol. Renal Physiol.* 282:F1056–F1063.

Wu, D. X., R. A. Johnston, A. Rengasamy, M. R. Van Scott, and J. S. Fedan. 2004. Hyperosmolar solution effects in guinea pig airways. II. Epithelial bioelectric responses to relative changes in osmolarity. *J. Pharmacol. Exp. Ther.* 308:19–29.

Wu, X., A. C. Myers, A. C. Goldstone, A. Togias, and A. M. Sanico. 2006. Localization of nerve growth factor and its receptors in the human nasal mucosa. *J. Allergy Clin. Immunol.* 118:428–433.

Xie, Y., M. A. Tisi, T. T. Yeo, and F. M. Longo. 2000. Nerve growth factor (NGF) loop 4 dimeric mimetics activate ERK and AKT and promote NGF-like neurotrophic effects. *J. Biol. Chem.* 275:29868–29874.

Figures

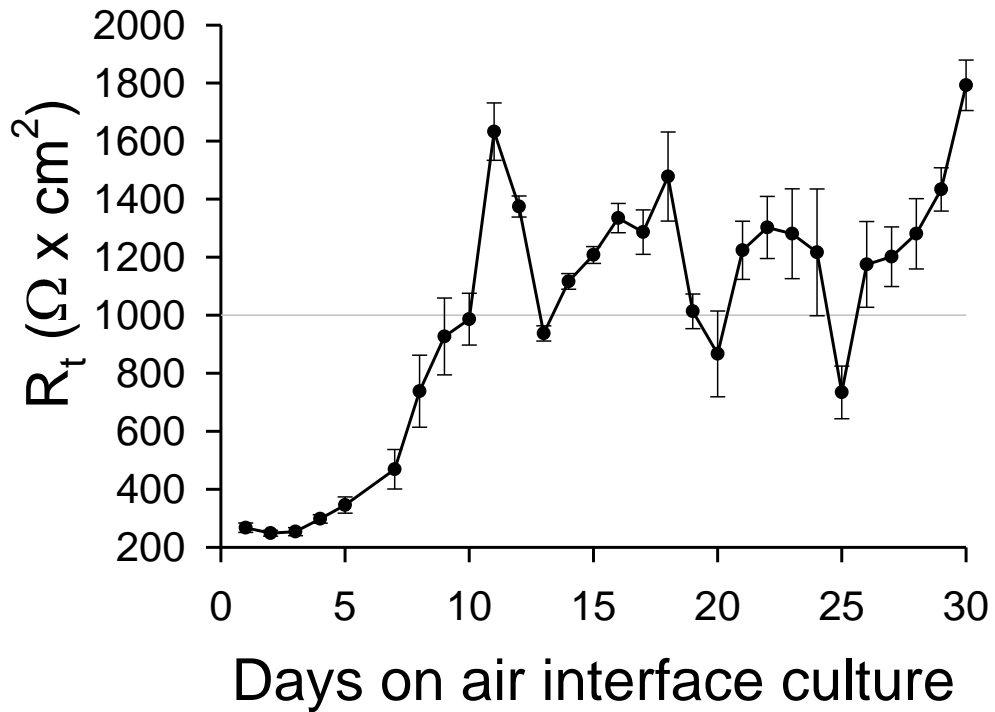

Figure 1. Time course of the development of R_t in air-liquid interface (ALI)-cultured normal human bronchial epithelial cells (NHBE). R_t was monitored over 30 days on ALI. NHBE cells generated and maintained high resistance after 10 days on ALI culture (n = 1 donor, 12 replicates).

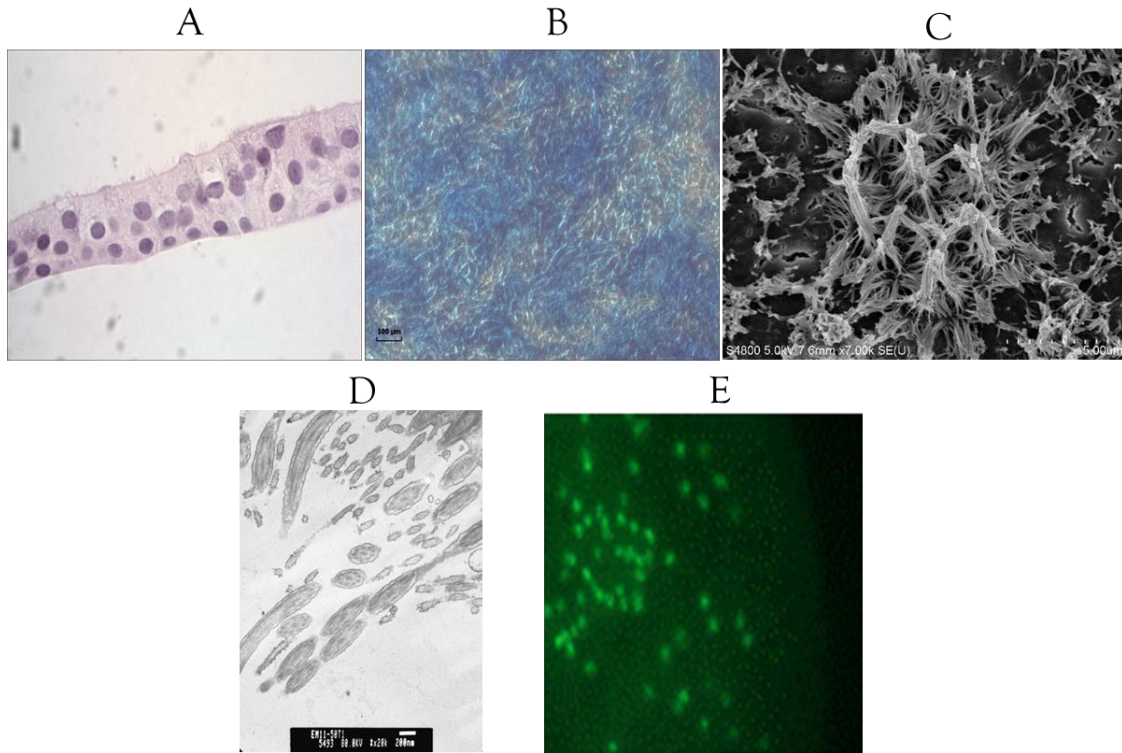

Figure 2. Confirmation of normal human bronchial epithelial cell (NHBE) differentiation. The differentiation of NHBE cells was confirmed through several imaging techniques. (A) Hematoxylin and eosin staining revealed a pseudo-stratified epithelium with the presence of cilia, (B) alcian blue staining confirmed mucus production, and (C) scanning electron microscopy revealed the presence of cilia on the apical surface. These structures were confirmed to be cilia through the use of (D) transmission electron microscopy, which revealed the presence of a 9 + 2 doublet of microtubules, and (E) immunofluorescence for β -tubulin.

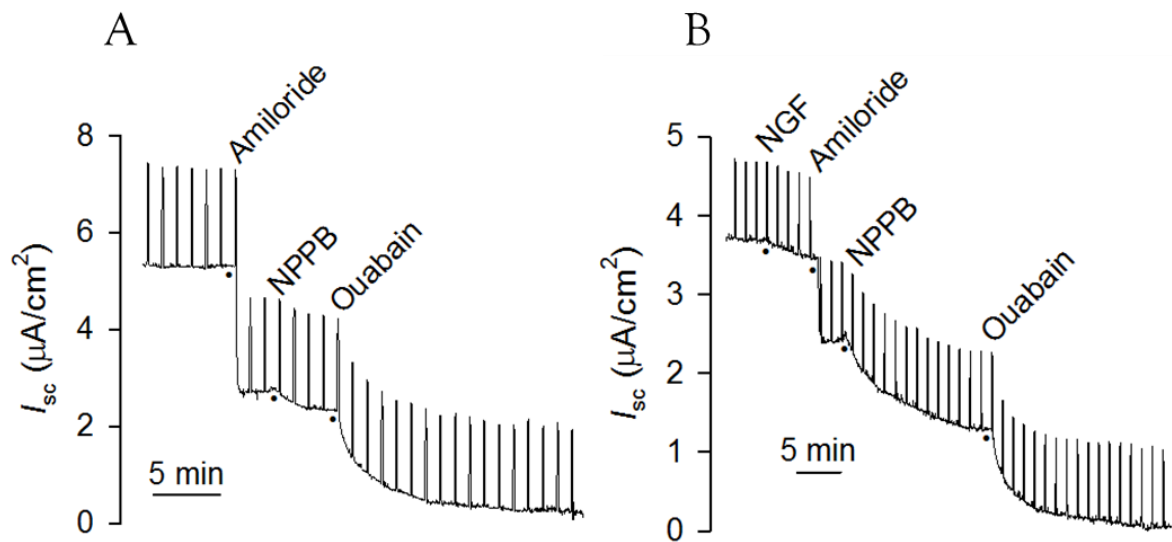

Figure 3. Representative I_{sc} tracings of responses to known ion transport inhibitors. Once I_{sc} stabilized, responses to amiloride (3.5×10^{-5} mol/L), NPPB (10^{-4} mol/L), and ouabain (10^{-4} mol/L) were generated in the (A) absence or (B) presence of 1 ng/mL nerve growth factor (NGF).

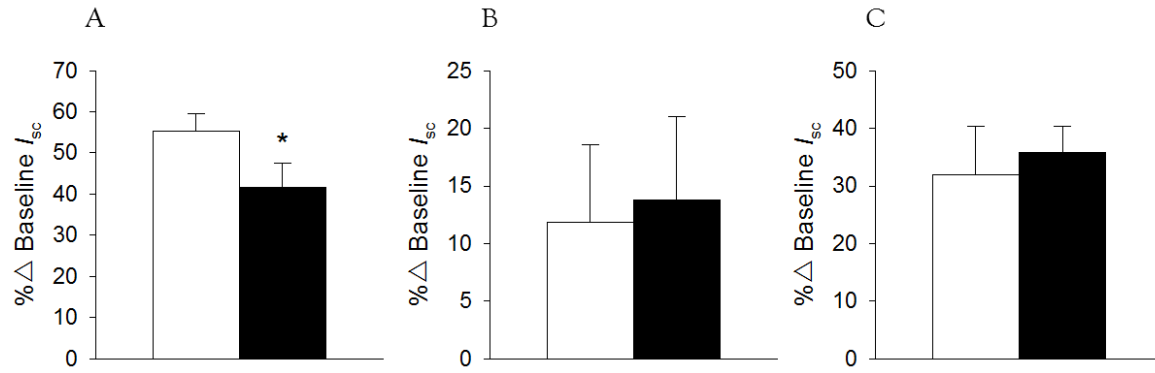

Figure 4. Effect of nerve growth factor (NGF) on ion transport. Responses to (A) amiloride, (B) NPPB, and (C) ouabain were calculated as percent change from baseline (4 donors). NGF significantly reduced the amiloride response ($P = 0.0127$).

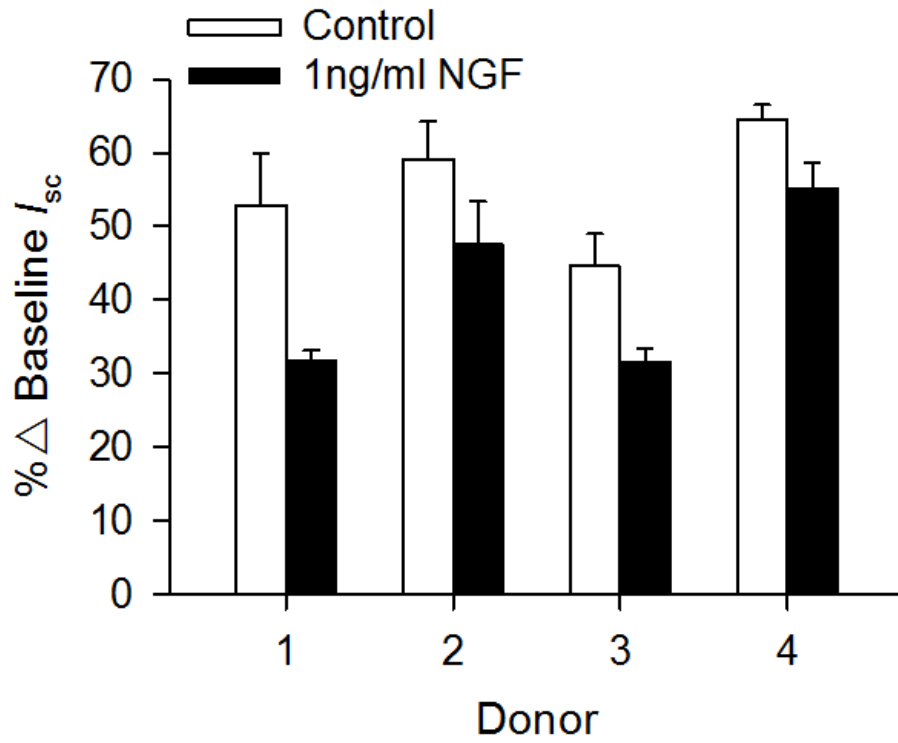

Figure 5. Effect of nerve growth factor (NGF) on amiloride-sensitive Na⁺ transport. Normal human bronchial epithelial cells cultured from four donors demonstrated consistent reductions in Na⁺ transport in the presence of 1 ng/mL NGF.

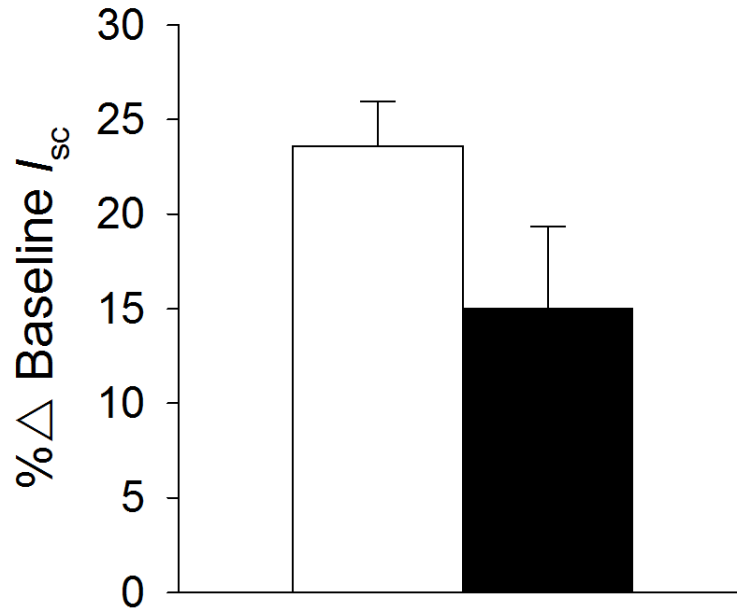

Figure 6. Effect of nerve growth factor (NGF) on responses to apically applied amiloride after 30 min. Although the response to amiloride was reduced in the presence of NGF, this reduction was not significant. n = 4.

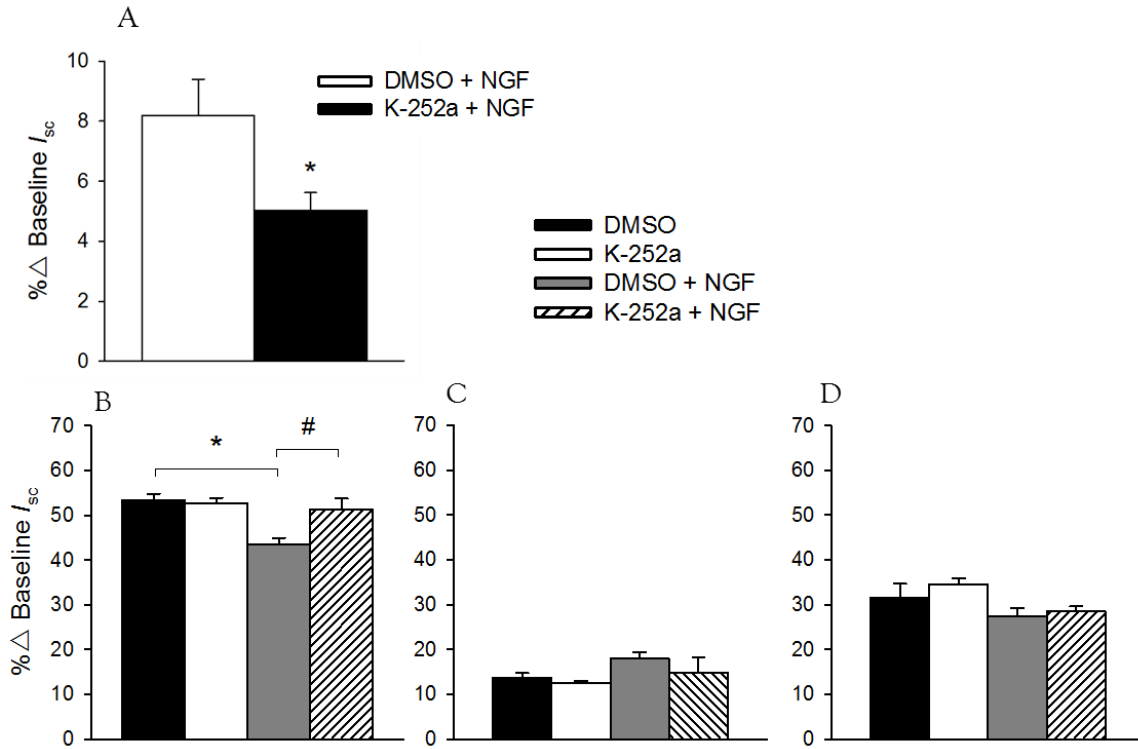

Figure 7. Effect of nerve growth factor (NGF)-induced trkA activation on amiloride-sensitive Na⁺ transport. Cells were either incubated apically with the nonspecific tyrosine kinase inhibitor, K-252a, or DMSO for 30 min prior to generating responses to (A) NGF, (B) amiloride, (C) NPPB, and (D) ouabain in the absence or presence of NGF. Incubation with K-252a significantly attenuated both the (A) NGF response ($P = 0.04$) and (B) the NGF induced reduction in amiloride-sensitive Na⁺ (* $P = 0.002$; # $P = 0.041$). DMSO $n = 4$; all other groups $n = 6$.

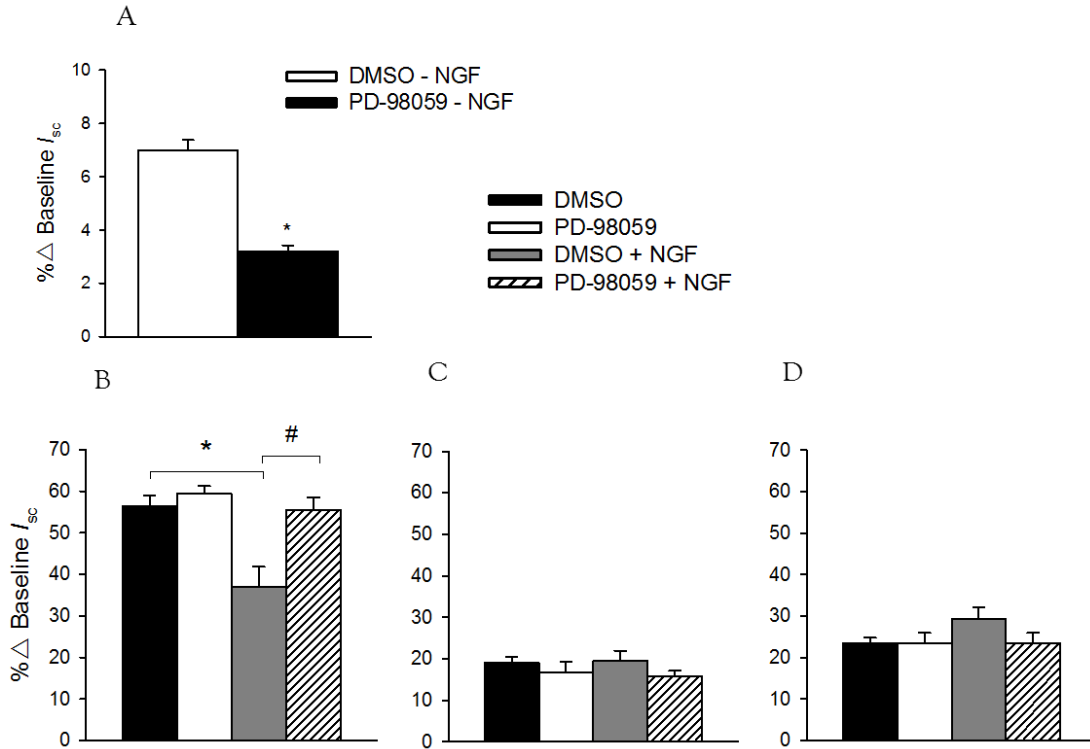

Figure 8. The involvement of the trkA downstream signaling pathway, Erk 1/2, in the nerve growth factor (NGF)-induced reduction in amiloride-sensitive Na^+ transport. Cells were either incubated apically and basolaterally with the specific Erk 1/2 inhibitor, PD-98059, or DMSO for 30 min prior to generating responses to (A) NGF, (B) amiloride, (C) NPPB, and (D) ouabain in the absence or presence of NGF. Incubation with PD-98059 significantly attenuated both the (A) NGF response ($P = 0.001$) and (B) the NGF induced reduction in amiloride-sensitive Na^+ transport (* $P = 0.002$; # $P = 0.012$). DMSO $n = 4$; all other groups $n = 6$.

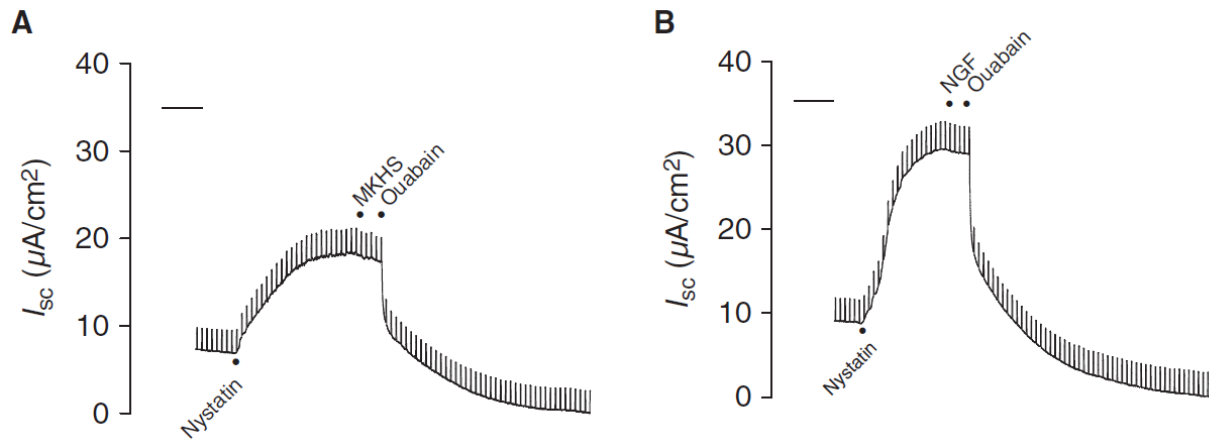

Figure 9. The effect of nerve growth factor (NGF) in epithelial cells permeabilized apically with nystatin. Cells were placed into Ussing chambers and allowed to equilibrate prior to adding nystatin (50 $\mu\text{mol/L}$) to the apical chamber. Nystatin caused a large increase in I_{sc} . Responses to ouabain were generated in the (A) absence (vehicle control – modified Krebs-Henseleit solution [MKHS]) or (B) presence of 1 ng/mL NGF. NGF did not elicit bioelectric responses when applied apically to the permeabilized cells, and did not alter Na^+/K^+ -ATPase activity as there were no differences in the response to ouabain. Control $n = 6$, NGF $n = 4$. Scale bar = 10 min.

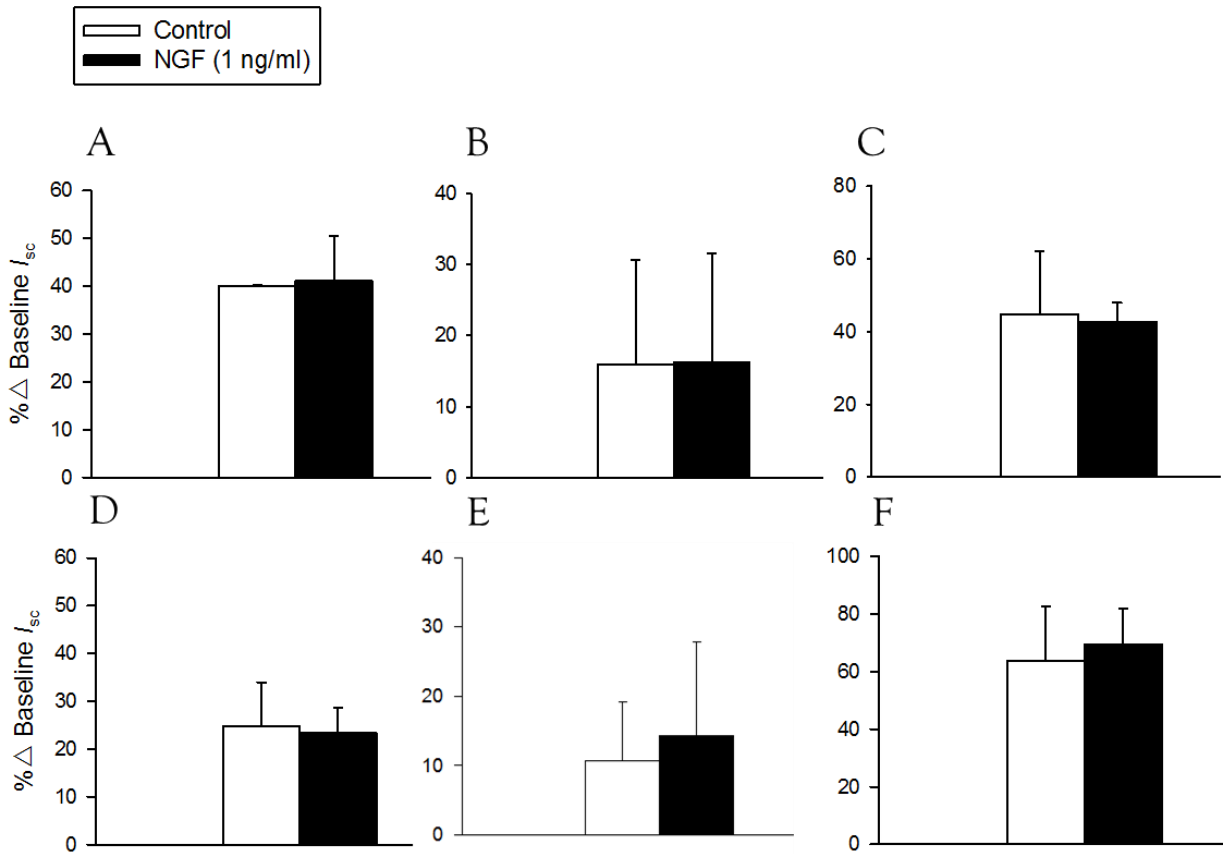

Figure 10. Effect of prolonged incubation with nerve growth factor (NGF) on ion transport.

Responses to known ion transport inhibitors were generated after incubating cells 24 h (A–C) and 48 h (D–F) with 1 ng/mL NGF. There were no difference in response to amiloride (A and D), NPPB (B and E), and ouabain (C and F) between control or NGF treated cells following either a 24- or 48-h incubation (2 donors).

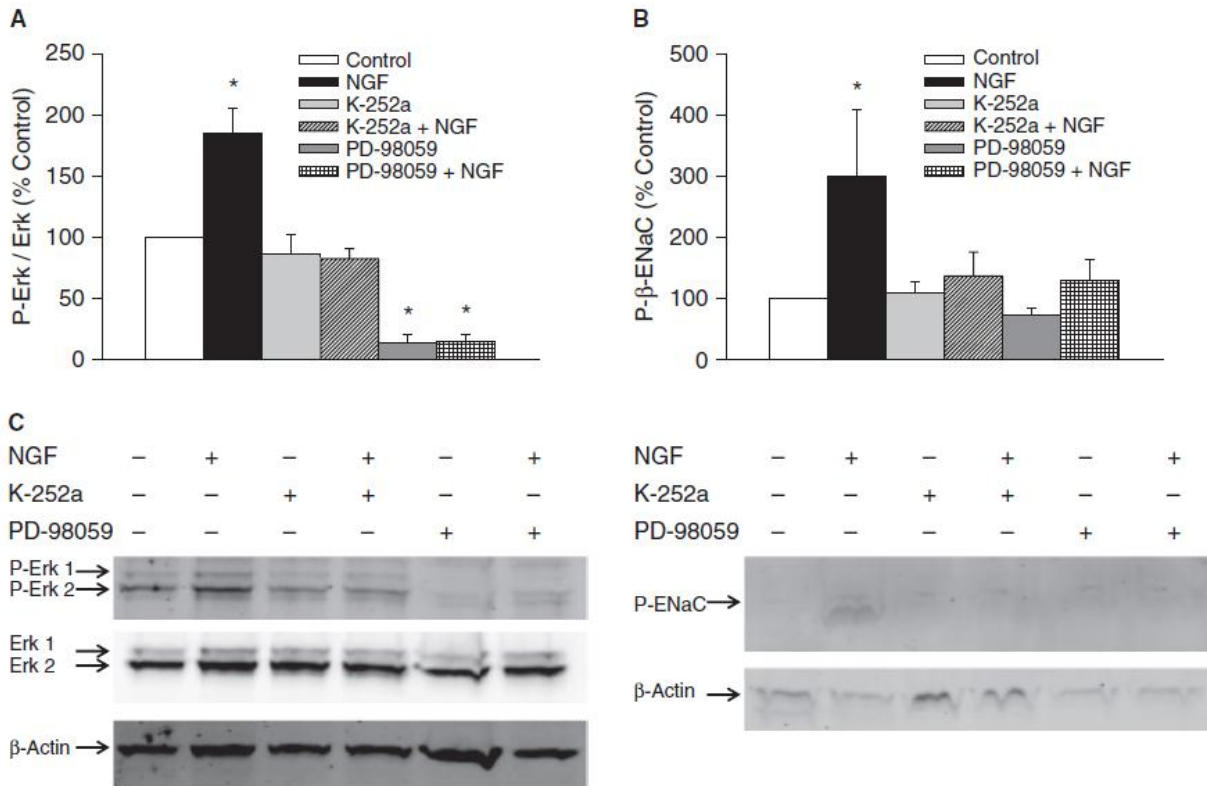

Figure 11. Western blots showing the effects of nerve growth factor (NGF) on Erk 1/2 activation and ENaC phosphorylation. Cells were incubated apically with modified Krebs-Henseleit solution (MKHS; control) or 1 ng/ml NGF in MKHS for 5 min. (A) NGF activated the Erk 1/2 signaling pathway. This activation was inhibited by K-252a and PD-98059. (B) NGF-mediated activation of Erk 1/2 resulted in ENaC phosphorylation, and was inhibited with K-252a and PD-98059. (C) Representative blots for Erk 1/2 (42 and 44 kDa), phosphorylated Erk 1/2 (P-Erk; 44 and 45 kDa), phosphorylated ENaC (76 kDa), and the loading control, β -actin (47 kDa). $n = 4$. * $P < 0.05$.

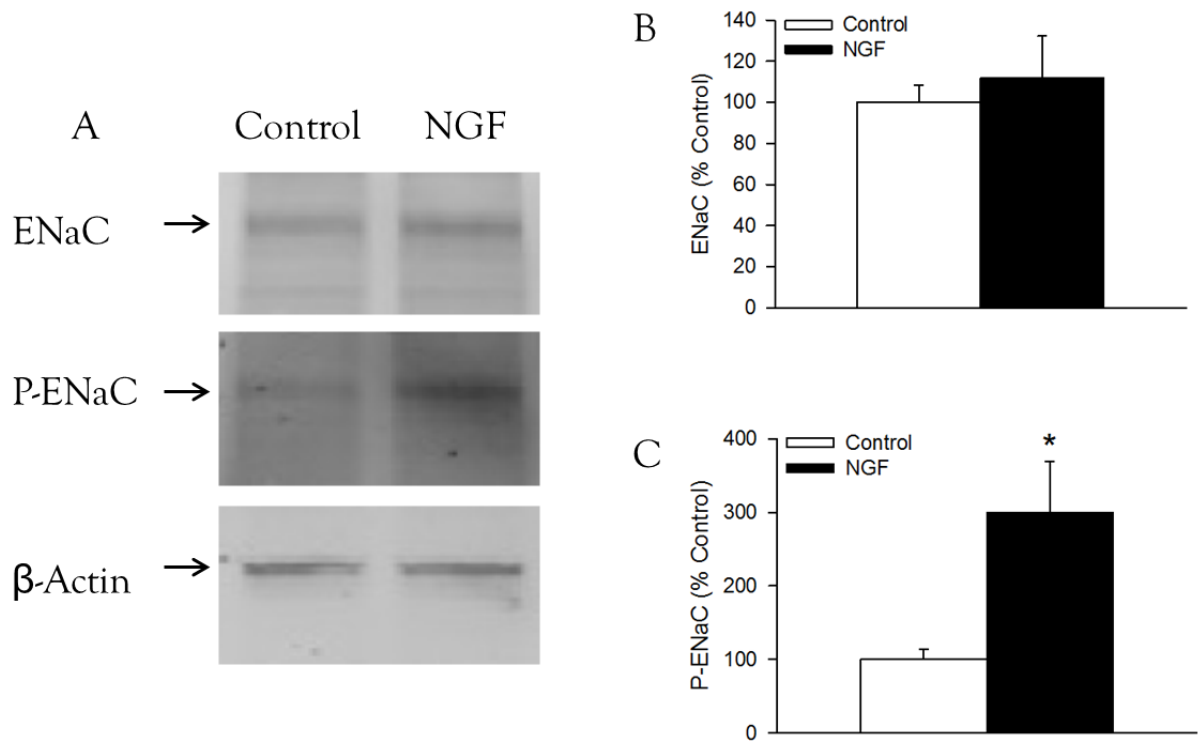

Figure 12. Western blots showing the effect of nerve growth factor (NGF) on β -ENaC. (A and C) Cells incubated with NGF for 5 min demonstrated a threefold increase in phosphorylated- β -ENaC (76 kDa). (B) Blots were stripped and probed for β -ENaC (75 kDa) and β -Actin (42 kDa). NGF did not affect β -ENaC levels. $n = 6$, $*P < 0.05$.

Chapter 6

Summary and Conclusion

The work presented in this dissertation demonstrates that NGF, acting through a trkA-Erk 1/2 mediated pathway, reduces amiloride-sensitive Na⁺ transport in NHBE cells. The reduction of Na⁺ transport in airway epithelial cells would result in periciliary liquid (PCL) hydration, which could lead or contribute to pulmonary edema. Although this project has identified the initial observation that NGF can regulate Na⁺ transport in the airway epithelium, there are still several questions left unanswered, but the work presented has laid the foundation for several subsequent experiments.

Specific Aim 1: To investigate the effect of NGF on ion transport in human airway epithelial cells.

The goal of specific aim 1 was to identify if NGF can elicit bioelectric responses in NHBE cells, and understand how NGF is mediating these responses. To first identify whether NGF has a bioelectric effects on the airway epithelium, both the apical and the basolateral membrane NGF concentration-response curves were required.

Immunohistological reports identified the trkA receptor to be located to the apical membrane and the p75^{NTR} receptor to be located on the basolateral membrane. NHBE cells responded with changes in I_{sc} only after NGF was applied to the apical, but not the basolateral membrane. This would suggest that either the trkA receptor is responsible for mediating the bioelectric responses, or that NGF was having an effect on directly on ion transport channels.

To investigate the molecular basis for the NGF bioelectric response, specific ion transport inhibitors were used, and differences in response to these inhibitors were

measured. In the presence of NGF, the amiloride response, or Na^+ transport, was reduced, but there were no differences in the response to NPPB or ouabain, indicating that Cl^- transport or Na^+/K^+ -ATPase were unaffected by NGF. The mechanism by which NGF was able to reduce the amiloride-sensitive Na^+ transport was further investigated in specific aim 2.

To investigate whether NGF could induce lasting changes in NHBE cells, cells were incubated for 24 or 48 h with NGF, and responses to known ion channel inhibitors were obtained. There were no differences in the responses to the channel inhibitors, indicating NGF did not initiate genomic effects to alter channel subunit expression during the period of incubation. The stability of NGF in culture was investigated to determine if this lack of effect was related to a degradation of NGF. To evaluate this possibility, the NGF concentration was measured after a 5 min, 6, 24, and 48 h incubation. Within 5 min, the NGF concentration was reduced by 93.4 % from the initial concentration applied to the cells. There were no detectable changes in the NGF concentration after 5 min when transwell inserts without cells were incubated with NGF. This indicates that the observed reduction in NGF concentration was a result of either NGF being metabolized or internalized by the epithelial cells. Rapid internalization has been documented using radiolabeled NGF (3). There were no measurable differences in channel blocker responses 24 or 48 h following a single application of NGF, indicating there were no changes in channel expression and that channel subunit protein expression studies were not warranted.

Specific Aim 2: To investigate the molecular pathways involved in NGF-signaling related to epithelial ion transport.

The goal of specific aim 2 was to investigate and determine the molecular pathway NGF is activating to reduce Na^+ transport. Based on the initial finding that NGF elicits a bioelectric effect when applied to the apical but not the basolateral membrane, we investigated whether NGF signaling through the trkA receptor caused a reduction in amiloride-sensitive Na^+ transport. This was accomplished by incubating cells with the non-specific tyrosine kinase inhibitor K-252a prior to the addition of NGF. K-252a reduced the response to NGF and attenuated NGF's effects on amiloride-sensitive Na^+ transport, indicating trkA's involvement in the NGF-induced reduction in Na^+ transport.

The Erk 1/2 signaling pathway has been shown to be activated by the trkA receptor, and EGF-activated Erk 1/2 signaling has been shown to reduce Na^+ transport in renal epithelial cells by phosphorylating ENaC to promote its internalization and degradation through a NEDD4 pathway. To investigate whether NGF was also acting through an Erk 1/2 mediated pathway to reduce Na^+ transport, cells were incubated with the specific Erk inhibitor PD-98059. The treatment with PD-98059 reduced the response to NGF and attenuated NGF's effect on amiloride-sensitive Na^+ transport.

To obtain additional evidence that NGF was activating Erk 1/2, and, that ENaC was being phosphorylated, cells were incubated with NGF for 5 min and Erk activation and ENaC phosphorylation were investigated. NGF caused an increase in Erk 1/2 activation and ENaC phosphorylation, both of which were blocked by either K-252a.

These results have demonstrated that NGF, acting through the trkA receptor, activates the Erk 1/2 signaling pathway, which in turn phosphorylates ENaC. Phosphorylated ENaC has a higher affinity for NEDD4, and is ubiquitinated, internalized, and degraded. The reduction in ENaC on the apical membrane results in a reduced Na⁺ transport. This reduction is transient, as the cells do not display reductions in Na⁺ transport 24 and 48 h post-exposure.

Future experiments

Although the data presented in this dissertation identified the initial observation that NGF is able to regulate Na⁺ transport in the airway epithelium, there are still several unanswered questions requiring investigation.

NGF's effect on ASL height

In NHBE cells, NGF produced a 14 % reduction in amiloride-sensitive Na⁺ transport. The physiological significance of this reduction needs to be addressed. Confocal microscopy techniques have been developed to study changes in ASL height, with optimal PCL found to be approximately 7 μm, the length of extended cilia (1). To identify the effect NGF has on fluid clearance in the lung, laser scanning confocal microscopy can be used to study changes in ASL in response to agents and channel inhibitors, as previously reported (4). To study changes in ASL, epithelial cells will be stained with Cell Track Green and the ASL will be stained with rhodamine B-dextran. Cells will be exposed to either MKHS or MKHS containing NGF, and changes in ASL

will be monitored over a period of time to investigate ASL height. Responses to ion transport inhibitors can be used to cause changes in ASL height through the activation or inhibition of ion transport. These responses will be generated in the absence or presence of NGF, and ASL height will be monitored. It is expected, since NGF reduces Na^+ transport, that cells treated with NGF will have a higher ASL than cells treated with control media.

NGF's effects on alveolar type II cells

The cells used to conduct the experiments outlined in this dissertation were bronchial/tracheal epithelial cells, but alveolar type II (ATII) cells are considered to be the primary site for airway fluid removal in the lung. To confirm that NGF reduces Na^+ transport in airway epithelium, the experiments in this dissertation should be duplicated using ATII cells isolated from rodent lungs or purchased commercially. The human primary NHBE cells used in this dissertation were purchased from Lonza, and Lonza also has human primary small airway epithelial cells (SAEC)(CC-2547) available. Although the cells purchased from Lonza are a mixture of several different cell types from the lower airways, these cells do contain ATII cells. A description of the percentage of ATII cells in each culture population is not available from the company at this time, but cell specific staining could be performed to determine cell culture populations. The company also manufactures specific medium which allows SAEC to be cultured on ALI, and cellular differentiation into cells representing *in situ* epithelial cell morphology can be generated. These cells also generate an electrical resistance of $814 \pm 55 \Omega \cdot \text{cm}^2$. These cells

would be an excellent model to investigate ion transport using similar electrophysiology techniques described in this dissertation and also used in measuring ASL height, as covered in 6.3.1.

Desensitization to NGF

Kaplan et al. reported that NGF stimulated the trkA receptor in PC12 cells after a 1 min and reached a maximum activation after a 5 min incubation (2). Once bound, the NGF-trkA complex has been shown to be internalized (3). We demonstrated that NHBE cells rapidly reduced the concentration of apically applied NGF within 5 min, corroborating these previous reports of a rapid activation and internalization of the NGF-trkA complex. The reduction of NGF receptors on the cell surface due to receptor internalization would result in a cellular desensitization to NGF, but the ability for cells to become desensitized to NGF warrants further investigation.

To investigate NGF mediated trkA internalization, florescent studies to monitor trkA internalization will be conducted as previously reported (5). Cultured human epithelial cells will be treated apically NGF before being fixed, permeabilized, and stained for activated trkA.

As previously mentioned, histological evaluation of nasal mucosal demonstrated the specific targeting of trkA to the apical membrane and p75^{NTR} to the basolateral membrane. These additional fluorescent studies would also confirm the specific membrane trafficking of the trkA and p75^{NTR} receptor in our cultured airway epithelial model.

Although a single exposure of NGF did not result in genomic changes and the concentration of a single addition of NGF was reduced 93.4 % within 5 min, this exposure does not represent the physiological conditions epithelial cells are exposed to during lung disease in which NGF is continuously being secreted. Cells will be treated repeatedly at intervals during the 24 or 48 h incubation period to better simulate the physiological conditions of the lung during disease in which epithelial cells are constantly exposed to elevated levels of NGF. Ion transport in these cells would then be investigated using similar electrophysiological experiments as mentioned previously.

1. **Boucher RC.** New concepts of the pathogenesis of cystic fibrosis lung disease. *Eur Respir J* 23: 146-158, 2004.
2. **Kaplan DR, Martin-Zanca D, and Parada LF.** Tyrosine phosphorylation and tyrosine kinase activity of the trk proto-oncogene product induced by NGF. *Nature* 350: 158-160, 1991.
3. **Saragovi HU, Zheng W, Maliartchouk S, DiGuglielmo GM, Mawal YR, Kamen A, Woo SB, Cuello AC, Debeir T, and Neet KE.** A TrkA-selective, fast internalizing nerve growth factor-antibody complex induces trophic but not neuritogenic signals. *J Biol Chem* 273: 34933-34940, 1998.
4. **Song Y, Namkung W, Nielson DW, Lee JW, Finkbeiner WE, and Verkman AS.** Airway surface liquid depth measured in ex vivo fragments of pig and human trachea: dependence on Na⁺ and Cl⁻ channel function. *Am J Physiol Lung Cell Mol Physiol* 297: L1131-1140, 2009.
5. **Woronowicz A, De Vusser K, Laroy W, Contreras R, Meakin SO, Ross GM, and Szewczuk MR.** Trypanosome trans-sialidase targets TrkA tyrosine kinase receptor and induces receptor internalization and activation. *Glycobiology* 14: 987-998, 2004.