Maine Collection

1988

Contributions to the Quaternary Geology of Northern Maine and Adjacent Canada

J. Steven Kite (ed.)

Thomas V. Lowell (ed.)

Woodrow B. Thompson (ed.)

Follow this and additional works at: https://digitalcommons.usm.maine.edu/me_collection



Part of the [Geology Commons](#), [Geomorphology Commons](#), [Geophysics and Seismology Commons](#), [Glaciology Commons](#), [Mineral Physics Commons](#), [Sedimentology Commons](#), [Stratigraphy Commons](#), and the [Tectonics and Structure Commons](#)

Recommended Citation

Kite, J. Steven (ed.); Lowell, Thomas V. (ed.); and Thompson, Woodrow B. (ed.), "Contributions to the Quaternary Geology of Northern Maine and Adjacent Canada" (1988). *Maine Collection*. 188. https://digitalcommons.usm.maine.edu/me_collection/188

This Book is brought to you for free and open access by USM Digital Commons. It has been accepted for inclusion in Maine Collection by an authorized administrator of USM Digital Commons. For more information, please contact jessica.c.hovey@maine.edu.

634.3:37

BULLETIN 37

Contributions to the Quaternary Geology of Northern Maine and Adjacent Canada

Edited by

J. Stevern Kite
Thomas V. Lowell
Woodrow B. Thompson

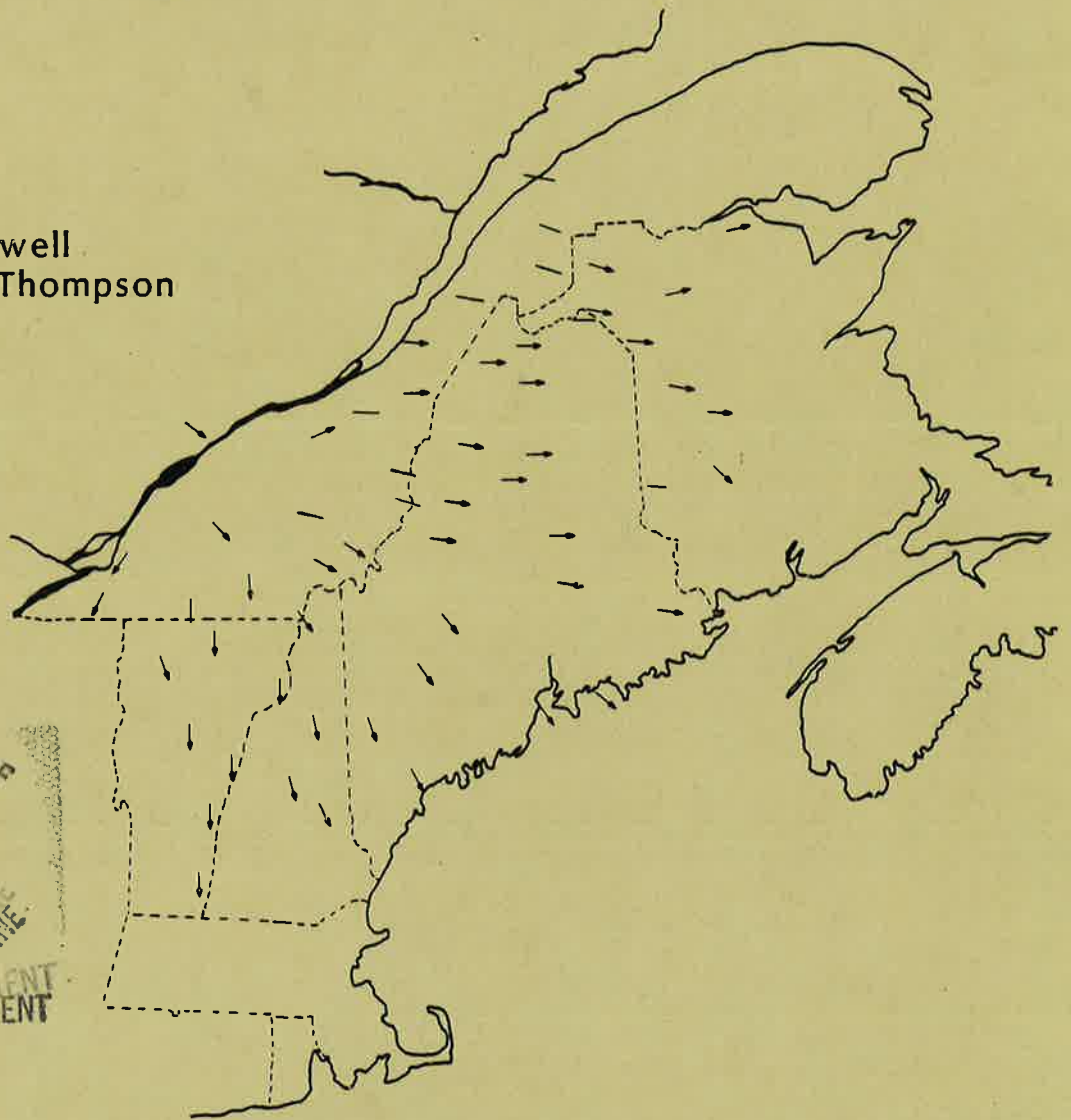

Walter A. Anderson, State Geologist
Maine Geological Survey
DEPARTMENT OF CONSERVATION

BULLETIN 37

Contributions to the Quaternary Geology
of Northern Maine and Adjacent Canada

Edited by

J. Steven Kite
Department of Geology and Geography
West Virginia University
Morgantown, WV 26506

Thomas V. Lowell
Department of Geological Sciences
State University of New York at Buffalo
Buffalo, NY 14226

Woodrow B. Thompson
Maine Geological Survey
Maine Department of Conservation
Augusta, ME 04333

Maine Geological Survey
DEPARTMENT OF CONSERVATION
Walter A. Anderson, State Geologist

1988

The laws and policies of Maine and the United States prohibit discrimination in Department of Conservation programs and/or employment because of race, religion, national origin, sex, age, or handicap. Any person who believes discrimination has occurred should contact the Commissioner, Maine Department of Conservation, Station #22, Augusta, Maine 04333; Telephone (207) 289-2211.

CONTENTS

INTRODUCTION.....	1
A GEOMORPHIC METHOD FOR RECONSTRUCTING PALEO ICE SHEETS	
PART I: GLACIAL GEOLOGY.....	3
T. Hughes and J. Fastook	
A GEOMORPHIC METHOD FOR RECONSTRUCTING PALEO ICE SHEETS	
PART II: GLACIOLOGY.....	19
J. Fastook and T. Hughes	
TILL STRATIGRAPHY AT THE BALD MOUNTAIN MINE SITE, NORTHERN MAINE.....	35
W. R. Holland and F. F. Bragdon	
GLACIAL DISPERSAL FROM THE PRIESTLY LAKE AND DEBOULLIE PLUTONS, NORTHERN MAINE.....	45
E. F. Halter	
GLACIATION OF NORTHWESTERN MAINE.....	57
T. V. Lowell and J. S. Kite	
AN UNUSUAL GLACIAL STRATIGRAPHY EXPOSED IN THE AROOSTOOK RIVER VALLEY, NORTHERN MAINE.....	73
H. W. Borns, Jr. and M. P. Borns	
DEGLACIATION OF NORTHWESTERN MAINE.....	79
T. V. Lowell and J. S. Kite	
DEGLACIATION AND STRATIGRAPHY OF THE LOWER ST. LAWRENCE VALLEY AND APPALACHIAN MOUNTAINS OF SOUTHEASTERN QUEBEC.....	91
P. LaSalle	
QUATERNARY GEOLOGY OF MADAWASKA COUNTY, WESTERN NEW BRUNSWICK: A BRIEF OVERVIEW.....	99
V. N. Rampton	
ICE MOVEMENTS IN MADAWASKA AND VICTORIA COUNTIES, NORTHWESTERN NEW BRUNSWICK.....	107
M. Rappol	
POSTGLACIAL HISTORY OF THE UPPER ST. JOHN DRAINAGE BASIN.....	117
J. S. Kite and R. Stuckenrath	
THE ARCHAEOLOGY OF THE UPPER ST. JOHN RIVER: OVERVIEW AND INTERPRETATION.....	133
G. P. Nicholas	

INTRODUCTION

This bulletin is a progress report on Quaternary studies in northern Maine and adjacent areas. It is published in conjunction with the 49th annual Friends of the Pleistocene meeting, held in Fort Kent, Maine, on May 23-25, 1986. The organizers of this meeting anticipate that this bulletin and the conference guidebook will draw attention to current problems of Quaternary research in northern Maine and surrounding areas.

The papers assembled here cover a wide range of theoretical and topical studies, which allows interested workers to place their findings in many different perspectives. The first paper, by Hughes and Fastook, describes different glaciological conditions existing in ice sheets, and the resultant glacial landforms. From the method described in the next paper, by Fastook and Hughes, the reader can calculate ice surface profiles.

The next several papers deal with stratigraphic studies. Holland and Bragdon present evidence for more than one glacial event in northern Maine. Halter then describes a glacial dispersal study which tests an ice-flow model proposed for this area. Lowell and Kite consider striation data and present an ice-flow chronology. Borns and Borns note an interesting stratigraphic relationship found in the Aroostook Valley and suggest several possible origins for the observed stratigraphy.

Lowell and Kite next consider the deglaciation evidence in a regional perspective. In adjacent southeastern Quebec, LaSalle reviews the stratigraphy and dating of events. Rampton summarizes his recent work in western New Brunswick, while Rappol describes till stratigraphy and striation studies in the northwestern part of this province.

The postglacial record of the upper St. John River valley is examined by Kite and Stuckenrath. Finally, Nicholas describes human settlement in northern New England, particularly during early postglacial time.

ACKNOWLEDGMENTS

This bulletin could not have been completed without the help of many individuals. The excellent typing of Catherine A. Stultz and Verle Sirois helped move the authors' ideas to the printed page. The quality of the figures was greatly improved by R. Tucker and his staff of R. Johnston, J. Poisson, and B. Wilson.

Finally, the papers have been further improved by the efforts of the following reviewers. We thank R. Bonnicksen, R. Brakenridge, P. Calkin, S. Cox, R. Dineen, W. Holland, C. Koteff, P. Patten, J. Thibault, and T. Weddle for their time and effort.

A GEOMORPHIC METHOD FOR RECONSTRUCTING PALEO ICE SHEETS

PART I: GLACIAL GEOLOGY

T. Hughes
Institute for Quaternary Studies
Department of Geological Sciences
University of Maine
Orono, Maine 04469

and

J. Fastook
Institute for Quaternary Studies
University of Maine
Orono, Maine 04469

INTRODUCTION

Glacial geologists need a quick, easy way to reconstruct the surface profiles of former ice sheets along flowlines deduced from the geologic record. We present a method for doing this using only a pocket calculator. In Part I, we describe the boundary conditions of an ice sheet and discuss the first-order glacial geology that might be produced by long-term steady-state equilibrium. In Part II, we show how accurate flowline profiles can be easily reconstructed from this glacial geology.

Computer ice-sheet models make use of glacial geologic information in two ways: geologic data are used as critical input to geomorphic models, and as an independent check on output from mechanical models. The use of glacial geology as input emphasizes the relationship between the pattern of flowlines at the surface and the distribution of meltwater at the bed of an ice sheet, recognizing the fact that glacial geology must be compatible with the subglacial hydrology associated with the meltwater distribution. This association was central in the geomorphic scheme that Denton and Hughes (1981) employed in reconstructing ice sheets worldwide at the last glacial maximum for CLIMAP (Climate: Long-range Investigation, Mapping, and Prediction, a project of the International Decade of Ocean Exploration, 1970-1980). Details of this scheme were presented by Hughes (1981), and its application to reconstructing the former ice sheets was presented by Hughes and others (1981). Alternative geomorphic schemes have been published by Boulton and others (1985) and Fisher and others (1985). All these schemes reconstruct steady-state ice sheets only. A mechanical model for steady-state ice sheets that ignores glacial geology, but which predicts distributions of basal meltwater that are compatible with surface flowlines, was developed by Budd and others (1971) for Antarctica, and Sugden (1977) used it to reconstruct the Laurentide Ice Sheet during its late Cenozoic maximum extent. A mechanical model that constructs time-

dependent ice sheets, and which does not rely on glacial geology, was published by Budd and Smith (1970), who used it to simulate the last glaciation cycle of North America.

SPECIFYING BOUNDARY CONDITIONS

Glacial Geology as Model Input

Boundary conditions imposed by glacial geology on ice-sheet reconstructions arise from the relationship between the pattern of surface flowlines and the distribution of basal meltwater, as shown in Figure 1 for a generalized ice sheet. Each boundary condition makes a unique contribution to our geomorphic model for reconstructing steady-state ice sheets. The ice margin marks the outer limit of glacial geology, so this limit is used in our model to reconstruct ice-sheet profiles from the ice margin to the ice divide. The ice divide is where glacial flow originates, and is located where profiles reconstructed from opposite margins have the same elevation. The ice bed creates the glacial geology that is used to draw flowbands of glacial motion along which the ice thickness profiles are computed. The ice surface experiences the major changes in mass and temperature along a flowband, and these changes ultimately determine the ice thickness profile over a given subglacial topography. These boundary conditions are input to our geomorphic model for reconstructing ice sheets, and specifying conditions at these boundaries is the first step in using our model. Figure 1 illustrates the variety of conditions at each boundary, and it should be consulted in the following discussion of these ice-sheet boundaries.

The Ice Margins

Ice sheets can have terrestrial margins where ice terminates in continental interiors or in the tidewater zone along continental coastlines, and marine margins where ice spreads over continental shelves to form floating ice shelves. Owing to the different environments, terrestrial margins are different at midcontinent and tidewater positions, and marine margins are different at the calving fronts and the grounding lines of ice shelves. Ice cliffs lie along tidewater margins and float along ice shelf calving fronts.

Ice streams are fast-moving currents of ice within an ice sheet; they form toward both terrestrial and marine margins, provided that subglacial topography is able to channel the flow of grounded ice. Ice streams are more common along marine margins because coastal mountains and islands channel flow better than the river valleys of interior plains. A terrestrial ice stream forms an ice lobe. A marine ice stream forms an ice tongue, which may float freely or be imbedded in a floating ice shelf. To remain stable, ice shelves must lie in confined embayments or be pinned to islands or shoals. Shoaling creates ice rises or ice rumples on the ice shelf, depending on how firmly the ice is pinned. Thus, an ice margin has a variety of boundary conditions to be specified.

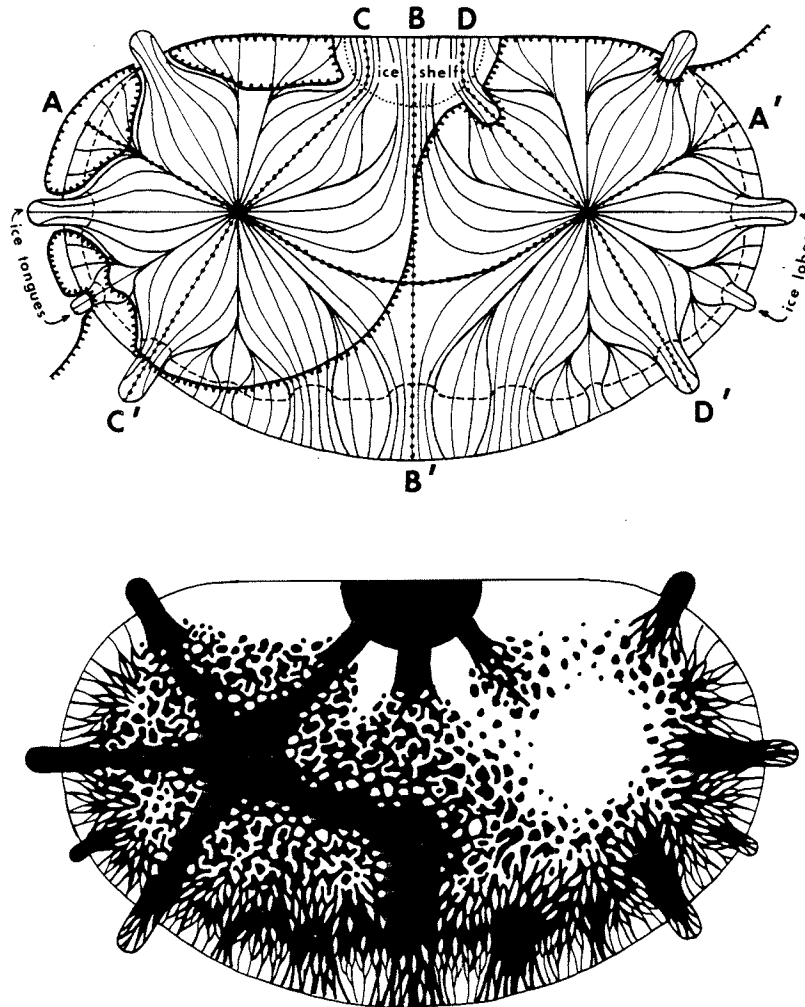

Figure 1a. Idealized ice-sheet flow regime. Flow in plan view for surface ice (top) and basal water (bottom). Shown at top are surface flowlines (solid lines) radiating from a terrestrial dome (inside hachured line) and a marine dome (outside hachured line), a surface equilibrium line (dashed line) that is highest on the equatorward flank of the ice sheet, and an ice-shelf grounding line (dotted line) on the poleward flank of the ice sheet. Shown at bottom are thawed patches (isolated black areas) where quarrying creates lakes, frozen patches (isolated white areas) where lodgement till creates drumlins, the arc of exhumation (black areas beneath the surface equilibrium line) where quarrying and regelation occur along a basal equilibrium line that separates an inner melting regime from an outer freezing regime, the arc of deposition (between the arc of exhumation and the ice margin) where regelation ice melts, selective linear erosion in ice-stream channels (broad black bands radiating from ice domes), and selective linear deposition in eskers (narrow black lines between broad black bands).

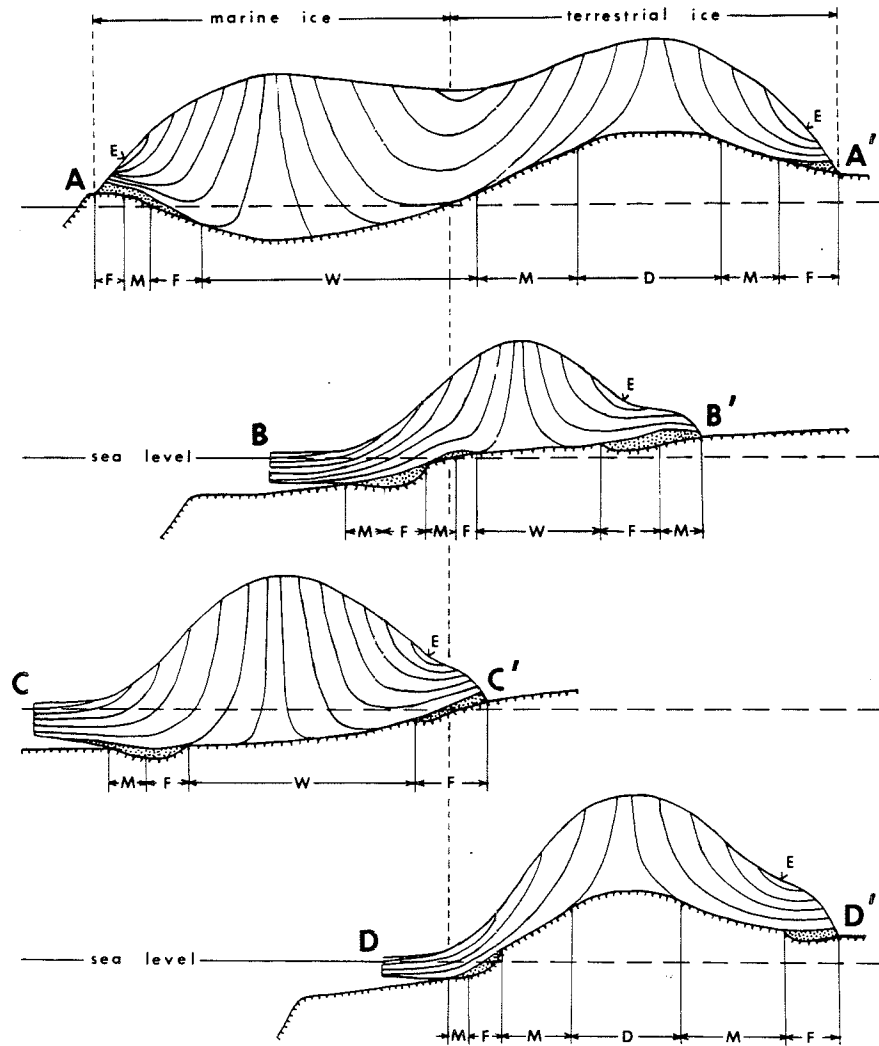

Figure 1b. Idealized ice-sheet flow regime. Flow of ice in vertical cross-sections along dotted surface flowlines A-A' through D-D' shown in Figure 1a. Shown above are longitudinal flowline profiles along the crest of the ice divide (section A-A'), along opposite flanks of a saddle on the ice divide (section B-B'), along opposite flanks of the marine ice dome (section C-C'), and along opposite flanks of the terrestrial ice dome (section D-D'). At the base (hachured line), a dry bed (D) is frozen everywhere, a wet bed (W) is thawed everywhere, melting beds (M) and freezing beds (F) have a mix of frozen and thawed areas, and regelation ice (dotted areas) forms at ice-stream headwalls, and over the thawed parts of a freezing bed.

The Ice Divide

Flow toward the terrestrial and marine margins of an ice sheet begins at the ice divide. An alternating sequence of domes and saddles commonly exists along the ice divide. Marine domes may form when sea ice thickens and becomes grounded over broad areas of shallow seas surrounded by islands or in shallow embayments on polar continental shelves. Terrestrial domes form on polar plateaus when climatic cooling lowers the snowline enough so that snowfields can expand and thicken to become ice caps. Saddles form when domes merge or when a major ice stream surges. Ice downdrawn into a surging ice stream can convert a dome into a saddle on the ice divide.

Owing to the much smaller surface slope and much greater divergence, flow from dome to saddle along an ice-divide crest is very slow compared to flow down the flanks of the ice divide. Flow diverges downslope from domes and converges downslope from saddles. At a saddle, diverging flow from adjacent domes turns sharply and becomes converging flow down the ice divide flanks. This converging flow may create ice streams along the ice-sheet margin downslope from ice-divide saddles. Domes and saddles are different boundary conditions at the ice divide.

The Ice Bed

The ice bed has frozen, thawed, freezing, and melting boundary conditions. Freezing and melting beds consist of a mosaic of frozen and thawed patches that determines if the bed is rough or smooth and hard or soft by controlling the types of glacial erosion and deposition processes. A great variety of boundary conditions is therefore possible at the bed.

Ice creeping over the bed can also slide if the bed is thawed. Basal heat is supplied by the geothermal flux and the friction in ice shearing over the bed. Although ice moves too slowly beneath ice divides to generate much frictional heat, basal melting may still occur if surface ice accumulation rates are low, so that cold surface ice moves downward slowly, and if the ice is thick enough to inhibit conduction of geothermal heat to the surface and to depress the pressure melting point to the basal ice temperature. A marine dome that formed in a polar embayment is more likely to have a thawed bed than a terrestrial dome that formed on a polar plateau because the terrestrial dome would form on colder ground and would be thinner.

Frictional heat is greatest where ice velocity is greatest and ice is still strongly coupled to the bed. These conditions exist at the bed beneath the surface equilibrium line, where the mass-balance velocity is greatest; and at the heads of ice streams, where converging flow is greatest. Ice progressively slows in the ablation zone and becomes progressively uncoupled from the bed in an ice stream. A thawed bed under the equilibrium line is likely, but a freezing bed may exist beneath the ablation zone where deceleration reduces frictional heat. The freezing bed may never become frozen because the basal temperature gradient in the ablation zone may not be sharp enough to conduct latent heat of freezing to the surface. A thawed bed at the head of an ice stream should remain thawed in the ice stream because ice streams accelerate as they become progressively uncoupled from the bed. However, a layer of regelation basal

ice may form in the ice stream because uncoupling also reduces basal frictional heat.

If the bed is frozen beneath the ice divide, a melting bed will lie between the ice divide and the equilibrium line and ice streams. If the bed is thawed beneath the ice divide and beneath the equilibrium line and ice streams, the intervening bed may also be thawed. However, cold ice advected from the ice divide will increase the temperature gradient in basal ice, so the intervening bed may consist of freezing, frozen, and melting zones or freezing and melting zones, in succession. Freezing and melting zones contain a mosaic of frozen and thawed patches. A melting zone consists of isolated thawed patches toward the ice divide and isolated frozen patches toward the ice margin, with a transition in between. A freezing zone consists of isolated frozen patches toward the ice divide, isolated thawed patches toward the ice margin, a transition zone in between, and a basal layer of regelation ice that forms in the thawed portions. The basal regelation ice would pass over a frozen zone that might lie between freezing and melting zones, and regelation ice would be melted away in the melting zone.

The Ice Surface

An ice sheet has a drainage pattern revealed by surface flowlines. Curvature changes along a surface flowline accompany major changes in boundary conditions; transitions from sheet flow to stream flow to shelf flow cause transitions in the surface curvature from convex to concave to almost flat. Sheet flow predominates in the interior where thick ice overrides all but the largest variations in bed topography. Stream flow predominates along the margins where thin ice can be strongly channeled by seemingly minor variations in bed topography. Shelf flow predominates where the ice sheet becomes afloat in deep water beyond the grounded margins. Shelf flow is channeled only by variations in bed topography that create embayments and ice rises where a floating ice shelf is confined laterally and pinned to the bed.

A second boundary condition manifested at the surface is division of the ice sheet into a number of drainage basins separated by ice divides, with secondary ice divides branching from the primary interior ice divide to form ice ridges between adjacent ice streams. Along the interior ice divide of an ice sheet, flow diverges downslope from domes and converges downslope from saddles. Along the grounded margin of an ice sheet, flow converges at the heads of ice streams and diverges between ice streams. Major ice streams have drainage basins that include a portion of the ice divide, whereas the drainage basins of minor ice streams develop closer to the ice-sheet margin. Downdraw in ice stream drainage basins can create ice ridges or even local ice domes between ice streams. Ice flow diverges from these ridges and domes, which are therefore centers of spreading along the grounded margin of an ice sheet. In Antarctica, a whole hierarchy of ice streams and spreading centers exists in the grounded ice sheet.

A third surface boundary condition is the surface mass balance. The surface equilibrium line that separates the interior zone of net ice accumulation from the peripheral zone of net ice ablation is the most prominent manifestation of this boundary condition. All ice sheet models

must include the surface mass balance, because ice-sheet dynamics arise from the surface mass balance, and advance or retreat of an ice sheet is an accomodation to changes in the surface mass balance.

FIRST ORDER GLACIAL GEOLOGY

Interpreting Glacial Geology

Perhaps the most controversial aspect of our geomorphic scheme for reconstructing former ice sheets is making a distinction between what we call first order and second order glacial geology (Hughes, 1981; Hughes and others, 1981). Glacial processes producing the first order glacial geology used as input for our geomorphic model are illustrated in Figure 2. First order glacial geology is linked directly to basal traction in our model. Our interpretation of first order glacial geology is similar to the interpretation by Sugden (1977, 1978) in that it emphasizes the large-scale glacial landscapes described by Sugden and John (1976). Our geomorphic model depends upon the assumption that a nearly steady-state flow regime exists in the core area, at least, of an ice sheet during most of each late Cenozoic glaciation cycle. Glacial isostasy, erosion, and deposition create stable zones in the core. Diagnostic glacial geology is created in each zone during most of a glaciation and is strengthened during subsequent glaciations. Eventually these diagnostic zones of stable glacial activity impart the dominant imprint on the subglacial landscape, and this imprint constitutes the first-order glacial geology. The imprint is legitimate input for a geomorphic model that reconstructs former ice sheets at a glacial maximum, when steady-state flow was approximated most closely.

Our assumption that steady-state glacial activity produces broad zones of first order glacial geology implies that second order glacial geology is less permanent and smaller in scale. Glacial geology traditionally has been concerned with these second order features, which range in size from drumlins and eskers to erratics and striations. Their predominant orientation, distribution, or direction is believed to reflect ice flow near the margin, rather than the interior, of an ice sheet. As directional indicators, therefore, they are most useful in determining ice flow near the margin during the last retreat, and are therefore time-transgressive. However, a distinction between first and second order glacial geology cannot be made if ice sheets were so unstable during a glaciation cycle that ice margins advanced and retreated repeatedly over even the core area. Geomorphic reconstructions of former ice sheets must then depend on theories for producing drumlins (Boulton, 1979), eskers (Shreve, 1985), erratic fans (Shilts, 1980), striations (Hallet, 1979), and other glacial geological landforms of similar scale. Boulton and others (1985) and Fisher and others (1985) have employed geomorphic models using glacial geology on this scale as model input. These features are often found within the first order glacial landforms discussed below and illustrated in Figure 2.

Weathered Rebounding Subglacial Highlands

Subglacial highlands located in the interior of a region covered by a former ice sheet will be weathered and have no record of glacial erosion or

Figure 2. Erosion and deposition beneath an ice sheet. Thin lines are flowline trajectories in vertical cross-section. Dotted lines show eroded debris entrained in basal regelation ice. Dotted areas show steady-state deposition of eroded debris as regelation ice melts. Stippled areas denote bedrock. Light line between bedrock and ice denotes a frozen bed. Heavy line between bedrock and ice denotes a thawed bed.

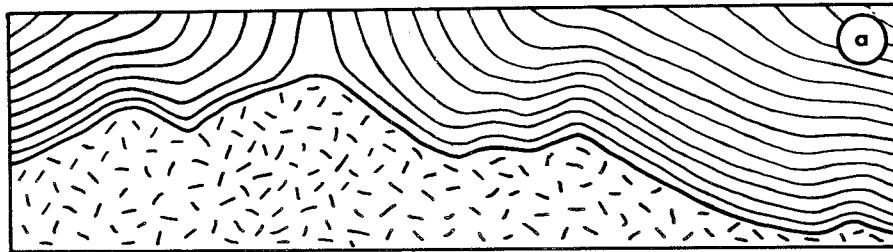

(a) Flow over frozen highlands beneath the central ice divide. Ice flowlines descend to the bed and diverge parallel to the bed, with no motion at the ice-bed interface.

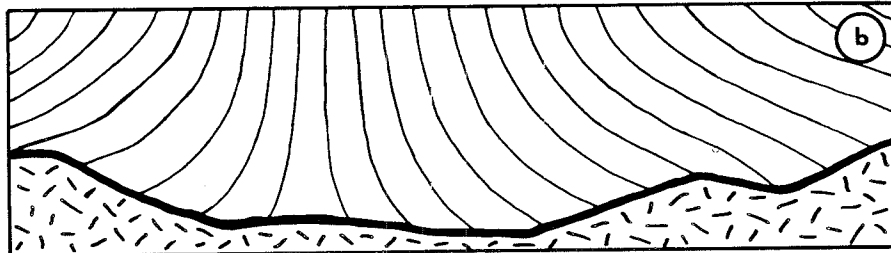

(b) Flow over a thawed basin beneath the central ice divide. Ice flowlines descend and intersect the bed, with sliding at the ice-bed interface.

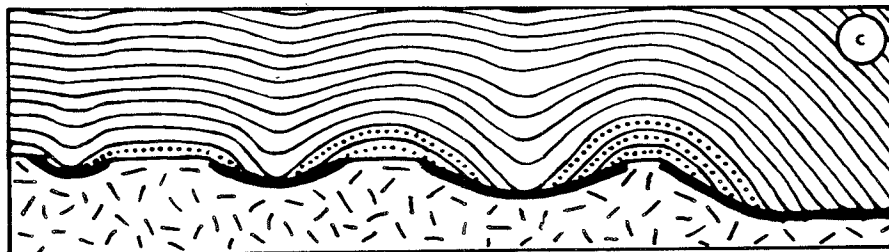

(c) Flow at the inner part of a basal melting zone. Ice melts in the upstream end of isolated thawed patches and the meltwater freezes in the downstream end, creating bands of regelation ice that eventually melt in the outer part of the basal melting zone.

Figure 2. Continued.

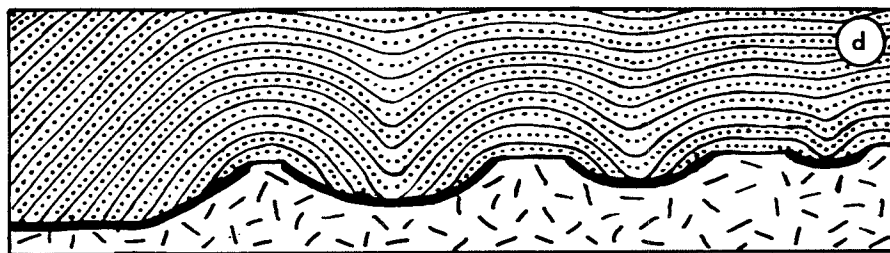

(d) Flow at the outer part of a basal freezing zone. Regelation ice from the inner part of the basal freezing zone melts in the upstream end of isolated thawed patches and the meltwater freezes in the downstream end, creating new bands of regelation ice that lie beneath the older regelation ice. Active steady-state quarrying takes place in the thawed patches shown in (c) and (d), creating pits that become the sites of lakes after deglaciation.

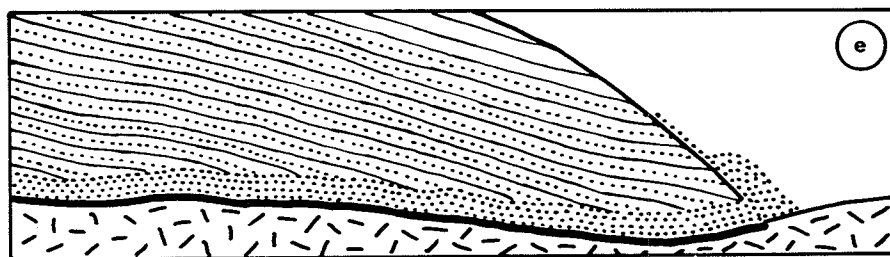

(e) Flow in the outer deposition zone of basal melting near the ice sheet margin. Debris entrained in regelation ice melts out to create a ground moraine across the zone and a terminal moraine along the ice margin.

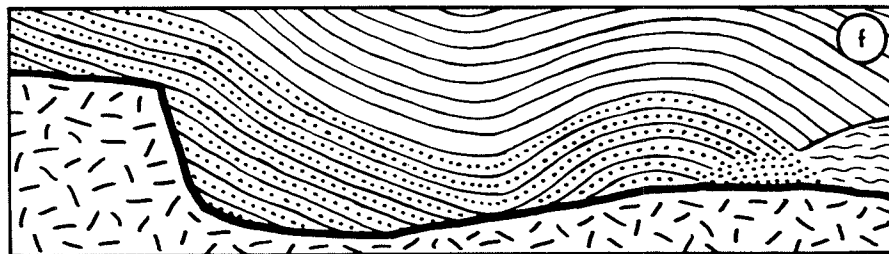

(f) Flow in a fjord occupied by an ice stream. Regelation ice melts above the headwall and the meltwater refreezes on the headwall to create new regelation ice that melts, refreezes, and melts on the fjord floor, leaving an end moraine as a sill.

deposition if a major ice dome was located there and the bed beneath the dome was frozen. Evidence for the dome will be raised marine beaches surrounding the highlands, and highland lakes having old shorelines that tilt away from the dome. A North American region having these conditions is the Queen Elizabeth Islands, and Blake (1970) postulated a late Wisconsin Innuitian Ice Sheet based on the dated pattern of raised marine beaches in these islands. Erosion was impossible because there was no ice motion at the interface with a frozen bed. Deposition was impossible because no dirt or rock enters the ice when it has no motion at the bed. This leaves only isostatic rebound, as recorded by raised beaches and negative gravity anomalies, to document the existence of a former ice sheet. Figure 2a shows this condition.

Scoured Rebounding Subglacial Basin

A subglacial basin in the interior of a region covered by a former ice sheet will be an areally scoured erosion zone if it was thawed and lay beneath the ice divide. Ice flowlines began at the ice divide, and those nearest the ice divide would have intersected the bed if it was thawed, as seen in Figure 2b. Erosion, rather than deposition, occurs because ice can slide over a thawed bed, and ice sliding at the ice-bed interface will be clean because flowlines for this basal ice originated at the ice surface. The only possible deposition is of debris eroded at the ice-bed interface by the sliding action, and deposited as lodgement till where the bed is rough. Otherwise, the eroded material will be ground into glacial flour.

A smooth landscape of areal scouring in the center of a region occupied by a former ice sheet, with only occasional deposits of lodgement till, is proof that the bed was thawed and is a strong indication that the ice divide was located there, especially if bedrock striations show ice motion radiating out of the region. If this central region includes a marine embayment, such as Hudson Bay in the Canadian shield or the Gulf of Bothnia in the Baltic shield, raised beaches will be highest and gravity anomalies will be most negative around the embayment, assuming that here a prolonged heavy mantle of ice caused maximum crustal depression. An ice dome over an interior subglacial basin could collapse during deglaciation, in which case the final pattern of bedrock striations would show ice moving into the basin, especially from flanking highlands such as those in Keewatin and the Ungava peninsula.

Pitted Zone of Net Basal Melting

A pitted erosion zone should exist in the lowlands surrounding highlands where a major dome of the former ice sheet rested on a frozen bed. The lowlands were a zone of net basal melting, across which isolated thawed patches nearest the highlands became bigger and more numerous with increasing distance from the highlands, until they coalesced, leaving isolated frozen patches that became smaller and less numerous toward the outer limit of the melting zone. Erosion occurred in the thawed patches because basal sliding was possible there. Under steady-state conditions, basal water volume was constant in each thawed patch, so basal melting in the upstream half of a patch must become basal freezing in the downstream half. Bands of regelation ice therefore extended downstream from each thawed patch, until they encountered a larger thawed patch where the

regelation ice melted. Debris eroded and entrained in the regelation ice from one thawed patch was then deposited in a thawed patch downstream, where it was either ground into glacial flour or became lodgement till. An increasingly thick basal layer of debris-charged regelation ice therefore formed as ice moved across a melting erosion zone, as shown in Figure 2c, and the entrained rock particles acted as cutting tools that eroded the bed as the regelation ice melted in the next downstream thawed patch. All regelation ice was melted after thawed patches coalesced.

A melting erosion zone can be identified by a deeply pitted landscape in lowlands surrounding a weathered and rebounding highland zone. The postglacial landscape will consist of lakes that become larger and more numerous with distance from the highlands, with each lake being the site of a formerly thawed patch. Even farther from the highlands, separate lakes can no longer be distinguished and hills will be the predominant feature. These hills will be sites of formerly frozen patches, and they will not be striated if the patches remained frozen during deglaciation. If the patches become thawed, the hills may be shaped into drumlins as they are approached by the retreating ice margin, since drumlins are often associated with recessional moraines. A patchy basal till thins across the melting zone. The till sheet was deposited when the debris-laden layer of regelation ice melted during deglaciation.

Pitted Zone of Net Basal Freezing

A pitted erosion zone should also develop in the lowlands surrounding an interior marine embayment over which a major dome of the former ice sheet rested on a thawed bed. Isolated frozen patches existed nearest the embayment, and these patches became larger and more numerous with increasing distance from the embayment. Eventually they coalesced and left isolated thawed patches that became smaller and less numerous toward the outer limit of the zone. Hence, net basal freezing occurred across the zone and erosion occurred where the bed was thawed. The decrease in ice overburden pressure with distance from the ice dome drove basal meltwater from the thawed subglacial basin into the freezing zone, where it refroze to form a basal layer of debris-charged regelation ice. Steady-state flow required that meltwater produced in the upstream half of isolated thawed patches was refrozen in the downstream half, so that bands of debris-charged regelation ice formed downstream from these patches. This situation is illustrated in Figure 2d.

A freezing erosion zone is identified by the lake-spattered landscape associated with isolated thawed patches toward its outer perimeter, and the hilly landscape associated with isolated frozen patches toward its inner perimeter. The freezing zone will be covered by a till sheet that melted out from debris-charged regelation ice formed in the zone. This till sheet will become thicker and more continuous toward the outer limit of the zone, because the layer of regelation ice thickened in that direction. Melting of regelation ice and till deposition took place during deglaciation.

Outer Zones of Net Deposition

A thick layer of regelation ice existed at the outer limit of a zone of

net basal freezing, but not a zone of net basal melting. When a basal melting zone surrounded a frozen bed beneath the ice divide, only clean ice would continue onward across the subsequent basal freezing zone, where dirty regelation ice would form and be transported across a basal melting zone along the equatorward margin of the ice sheet and a basal frozen zone along its poleward margin. When a basal freezing zone surrounded a thawed bed beneath the ice divide, dirty regelation ice that formed in the freezing zone would cross a basal melting zone along the equatorward margin of the ice sheet and a basal frozen zone along the poleward margin. In both cases, the basal layer of regelation ice would be melted in the basal melting zone along the equatorward margin, depositing a thick basal till sheet across the zone. Any regelation ice remaining unmelted at the base would appear in the surface ablation zone, where its entrained debris would form a terminal moraine at the steady-state glacial maximum and recessional moraines during retreat. The outer zone of basal melting along the equatorward margin was therefore a zone of net deposition, and it is illustrated in Figure 2e.

The outer frozen zone along the poleward margin is not a deposition zone during the steady-state glacial maximum, but a debris-charged layer of regelation ice passes over it, so it can become a deposition zone as the regelation ice melts during glacial retreat. The till sheet deposited during retreat would be thin if retreat was rapid. During the steady-state glacial maximum, debris entrained in the regelation ice would either be deposited as a terminal moraine if the poleward margin of the ice sheet ended on land and has a surface ablation zone, or the entrained debris would be funneled into marine ice streams where the poleward margin advanced into deep water on the continental shelf.

Erosion and Deposition in Ice Streams

Debris entrained in basal regelation ice can be deposited in the region of strongly converging flow at the head of ice streams, because much basal frictional heat is generated there. This heat keeps the bed thawed locally, even in an overall frozen basal zone, and it can also melt basal regelation ice being funneled into the region of converging flow. Much debris deposited in the region of converging flow will be ground into glacial flour, but in that process it provides cutting tools that can erode the bed deeply, thereby creating the fore-deepened troughs that are characteristic of ice-stream channels. These troughs exist in virtually all of the inter-island channels of the Canadian arctic archipelago, especially inter-island channels extending to the edge of the continental shelf in the Queen Elizabeth Islands.

Erosion might be replaced by deposition in the outermost part of an ice stream advancing into deep water, because buoyancy eventually uncouples ice from the bed. Basal uncoupling reduces basal frictional heat, so bedrock eroded in the fore-deepened end of an inter-island channel may be frozen into a new layer of regelation ice. If that regelation ice is melted by heat arising from tidal pumping or estuarine circulation where the ice stream becomes afloat, its entrained debris will be deposited as a terminal moraine that forms a basal sill along the grounding line of floating ice.

Channels extending to the edge of the continental shelf often begin at

the headwalls of fjords through coastal highlands, such as those in Labrador and Baffin Island. Ice streams occupying these fjords begin in the region where ice converges on the headwall. Basal meltwater produced in the region of converging flow pours over the headwall and refreezes because frictional heat vanishes. The refreezing rate depends on the rate at which latent heat of freezing is converted into mechanical energy needed for quarrying. The regelation ice frozen onto the headwall as the meltwater refreezes is pulled forward by the overlying ice, thereby producing a strong quarrying mechanism at the headwall. Blocks of rock plucked from the headwall by the regelation ice cause the headwall to retreat, and become powerful cutting tools that sculpt the fjord sidewalls into nearly vertical rock cliffs and fore-deepen the bedrock floor of the fjord. Frictional heat generated by ice shearing along the sidewalls and base of the fjord can melt regelation ice created at the headwall and, above it, regelation ice surviving from the region of converging flow up-glacier from the headwall. Entrained debris in both layers of regelation ice can then be deposited at the mouth of the fjord as the regelation ice melts. This debris forms a sill at the entrance to the fjord. Figure 2f illustrates these mechanisms of erosion and deposition in fjords occupied by ice streams.

Ice streams occupying interisland channels and fjords are marine ice streams. Terrestrial ice streams can develop in river valleys at the equatorward margins of an ice sheet. The DesMoines and James lobes of the Laurentide Ice Sheet occupied valleys of the DesMoines River and the James River, and may have been the termini of ice streams that originated in Lake Winnipeg and Lake Manitoba. Other Laurentide ice lobes formed beyond the long axis of each of the Great Lakes, and may have been extensions of Laurentide terrestrial ice streams that developed in these lakes and were responsible for eroding the lake floors. Basal till and recessional moraines delineating these lobes included rock debris entrained in regelation ice formed in the lake troughs and deposited when the regelation ice melted.

CONCLUSIONS

Figure 1 shows boundary conditions for a generalized ice sheet, and these conditions are related to first order glacial geology in Figure 2. First order glacial geology, being created when an ice sheet most closely approaches true steady-state conditions, gets reinforced by each successive glaciation. Eventually, it makes the dominant glacial geological imprint on a landscape subjected to repeated glaciation by a continental ice sheet. First order features are the central region of postglacial isostatic rebound, whether this region was frozen continental highlands or a thawed marine basin; heavily pitted erosion zones of basal melting and freezing that surround this central region, and where eroded debris is incorporated into a basal layer of regelation ice; an outer zone of deposition where the regelation ice melts, either during steady-state conditions at the glacial maximum or during transient conditions that accompany glacial retreat; and fore-deepened channels that cut across the outer zone and were occupied by either terrestrial or marine ice streams. In Part II, we will show how ice-sheet surface profiles can easily be constructed along flowlines that include all these basal conditions.

REFERENCES CITED

- Blake, W., Jr., 1970, Studies of glacial history in Arctic Canada, I: Pumice, radiocarbon dates, and differential postglacial uplift in the eastern Queen Elizabeth Islands: *Canadian Journal of Earth Sciences*, v. 7, p. 634-664.
- Boulton, G. S., 1979, Processes of glacier erosion on different substrata: *Journal of Glaciology*, v. 23, no. 89, p. 15-38.
- Boulton, G. S., Smith, G. D., Jones, A. S., and Newsome, J., 1985, Glacial geology and glaciology of the last mid-latitude ice sheets: *Journal of the Geological Society of London*, v. 124, p. 447-474.
- Budd, W. F., Jenssen, D., and Radok, U., 1971, Derived physical characteristics of the Antarctic Ice Sheet: Australian National Antarctic Research Expeditions (ANARE) Interim Reports, Series A (IV), *Glaciology*, Publication 120, Issued by the Antarctic Division, Department of Supply, Melbourne, 178 p.
- Budd, W. F., and Smith, I. N., 1979, The growth and retreat of ice sheets in response to orbital radiation changes: *International Association of Hydrological Sciences*, Publication Number 131, p. 369-409.
- Denton, G. H., and Hughes, T., eds., 1981, *The Last Great Ice Sheet*: Wiley-Interscience, New York, 484 pages.
- Fisher, D. A., Reeh, N., and Langley, K., 1985, Objective reconstructions of the late Wisconsinan Laurentide Ice Sheet and the significance of deformable beds: *Geographie physique et Quaternaire*, vol. 39, no. 3, p. 229-238.
- Hallet, B., 1979, A theoretical model of glacial abrasion: *Journal of Glaciology*, vol. 23, no. 89, p. 39-50.
- Hughes, T. J., 1981, Numerical reconstruction of paleo ice sheets, in Denton, G., and Hughes, T. J., eds., *The Last Great Ice Sheets*: Wiley-Interscience, New York, p. 221-261.
- Hughes, T. J., Denton, G. H., Andersen, B. G., Schilling, D. H., Fastook, J. L., and Lingle, C. S., 1981, The last great ice sheets: A global view, in Denton, G., and Hughes, T. J., eds., *The Last Great Ice Sheets*: Wiley-Interscience, New York, p. 263-317.
- Shilts, W.W., 1980, Flow patterns in the central North American ice sheet: *Nature*, v. 286, no. 5770, p. 213-218.
- Shreve, R. L., 1985, Late Wisconsin ice-surface profile calculated from esker paths and types, Katahdin esker system, Maine: *Quaternary Research*, v. 23, p. 27-37.
- Sugden, D. E., 1977, Reconstruction of the morphology, dynamics, and thermal characteristics of the Laurentide Ice Sheet at its maximum: *Arctic and Alpine Research*, v. 9, no. 1, p. 21-47.

Sugden, D. E., 1978, Glacial erosion by the Laurentide Ice Sheet: Journal of Glaciology, v. 20, no. 83, p. 367-391.

Sugden, D. E., and John, B., 1976, Glaciers and Landscape - A Geomorphological Approach: Edward Arnold, London, 320 p.

A GEOMORPHIC METHOD FOR RECONSTRUCTING PALEO ICE SHEETS

PART II: GLACIOLOGY

J. Fastook
Institute for Quaternary Studies
University of Maine
Orono, Maine 04469

and

T. Hughes
Institute for Quaternary Studies
Department of Geological Sciences
University of Maine
Orono, Maine 04469

INTRODUCTION

In Part I, we described the major components of an ice sheet; the ice divide where flow begins, the ice margin where flow ends, the ice bed over which flow moves, and the ice surface which determines the pattern of flow. We also discussed first-order glacial geology created by steady-state erosion and deposition processes; a central region of maximum postglacial isostatic rebound, a surrounding erosion zone heavily pitted by basal freezing and melting conditions, an outer deposition zone where debris-charged regelation ice from the erosion zone is melted, and fore-deepened channels that were occupied by ice streams cutting across the outer zone. In Part II, we present a simple method for computing accurate surface flowline profiles based on this glacial geology. Only the field evidence and a pocket calculator are needed.

A FORMULA FOR COMPUTING FLOWLINE PROFILES

The Basal Shear Stress

The most fundamental formula in glaciology is the expression for basal shear stress τ_o , which depends upon the ice thickness h_I , ice surface slope α , ice density ρ_I , and gravity acceleration g , as follows:

$$\tau_o = \rho_I g h_I \alpha \quad (1)$$

Equation (1) is merely a statement of Newton's law that a force acting on a body is the product of the body's mass and acceleration. All bodies on Earth's surface, including ice sheets, experience the acceleration of

gravity. It is the force of gravity, therefore, that causes an ice sheet to spread under its own weight, and τ_o is merely a measure of the bed traction that resists spreading. The smoother and more lubricated by meltwater is the bed, the smaller is τ_o , and τ_o vanishes altogether when the ice sheet becomes afloat. A floating ice sheet is called an ice shelf, and the Ross Ice Shelf in Antarctica is one example.

Bootstrapping Ice Elevation Computations

Figure 1 shows how flowlines of length L from the ice divide to the ice margin of an ice sheet can be divided into a number of steps having equal length Δx . The ice elevation changes a variable amount Δh at each fixed distance Δx along the flowline. If each Δx step is identified by an integer i, numbered consecutively from the ice margin to the ice divide, then ice surface slope at step i is α_i and is defined by the expression $\alpha_i = \Delta h_i / \Delta x$, where $h_i = h_{i+1} - h_i$ to an acceptable approximation, h_i and h_{i+1} being respective ice elevations at steps i and i + 1. An alternative way to write Equation (1) is, therefore:

$$h_{i+1} = h_i + (\tau_o / h_I)_i \Delta x / \rho_I g \quad (2)$$

Equation (2) is an initial-value, finite-difference, recursive formula, and it allows ice elevation h to be computed at step i + 1 if ice elevation h, ice thickness h_I , and basal shear stress τ_o are all known at step i. Initial values of h must therefore be specified at one step before h can be computed at other steps. Also, values of h_I and τ_o must be known at each Δx step, where Δx is the finite difference $x_{i+1} - x_i$. Recurring applications of Equation (2) allows us to bootstrap calculations of ice elevation along the flowline.

Basal Topography and Isostasy

The flowline passes over a bed which also has elevation variations, and the changing ice thickness along the flowline causes variations in isostatic depression of the bed. These effects are included in the following modified version of Equation (2), in which $h_I = h - h_R$ is obtained by setting $r = 0$:

$$h_{i+1} = h_i + \left[\frac{\tau_o}{(1+r)h - (1+r)^{1/2} h_R} \right]_i \frac{\Delta x}{\rho_I g} \quad (3)$$

Here, h_R is present-day elevation of bedrock above (positive h_R) or below (negative h_R) the margin of the ice sheet for a given flowline, and r is a ratio such that $r = 0$ for no isostatic depression and $r = \rho_I / (\rho_R - \rho_I) \approx 1/3$ for complete isostatic depression, taking $\rho_I \approx 900 \text{ kg/m}^3$ for glacial ice density and $\rho_R \approx 3600 \text{ kg/m}^3$ for mantle rock density. Intermediate isostatic conditions are accommodated by using intermediate values of r.

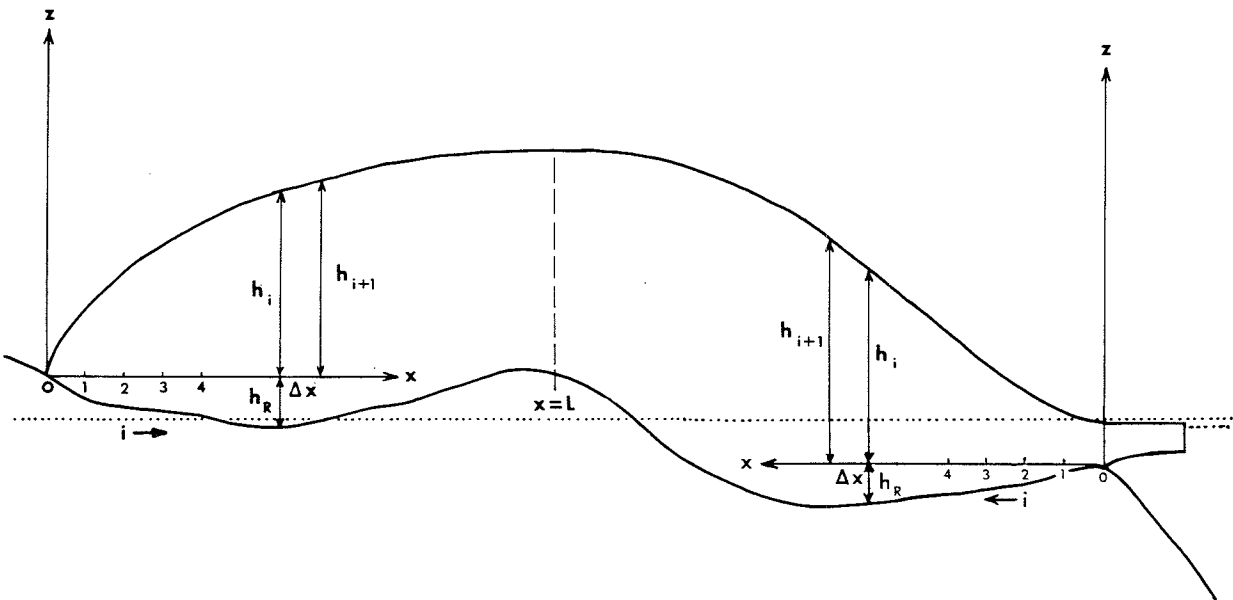

Figure 1. A scheme for reconstructing ice elevation profiles along ice-sheet flowlines from the ice margin to the ice divide. Flowline length L is divided into $i = L/\Delta x$ steps having equal length Δx , with ice elevation h computed from an initial elevation at one step, and known values of bedrock elevation h_R , basal shear stress τ_0 , and degree of isostatic equilibrium r at all steps. Flowline surface and bed elevations are measured with respect to ice margins.

Ice Margin Elevations

In Equation (3), values of τ_o , h_R , and r must be specified at each step i along the flowline, but h need be specified at only the initial step. It is best to take the initial ice elevation one Δx step in from the terminal moraine along a terrestrial ice margin, and at the grounding line of an ice shelf along a marine ice margin. In the absence of specific information, the marine grounding line can be taken as the edge of the continental shelf.

For terrestrial ice margins, if we specify that τ_o is constant and the bed is horizontal along the first Δx step in from the terminal moraine, Equation (1) can be integrated over distance x to give

$$h = h_I = (2 \tau_o \Delta x / \rho_I g)^{1/2} \quad (4)$$

at $x = \Delta x$, where $h = 0$ is ice elevation at the terminal moraine. Taking $i = 0$ at the moraine, h from Equation (4) can be entered for $i = 1$ in Equation (3) as the initial ice elevation that allows the bootstrapping process to begin.

For marine ice margins, the buoyancy condition for floating ice requires that

$$h = h_I = h_W (\rho_W / \rho_I) \quad (5)$$

at $x = 0$, where $h = h_I$ is ice elevation above the grounding line of floating ice and $\rho_W \approx 1020 \text{ kg/m}^3$ is the density of sea water. This value of h can be entered for $i = 0$ in Equation (3) as the initial ice elevation in the bootstrapping process.

The length Δx of steps along an ice-sheet flowline should not be less than 20 km nor more than 100 km. Assumptions made in deriving Equation (1) break down when $\Delta x < 20$ km, and important topographic features can be stepped over when $\Delta x > 100$ km. A good compromise is to let $\Delta x = 50$ km.

BASAL SHEAR STRESS VARIATIONS

Steady-State Flow

An ice sheet advances and retreats when the ice discharge flux across any transverse vertical section of a flow band is balanced by the upstream rates of net ice accumulation and ice thickening (advance) or thinning (retreat). During steady-state flow, net upslope accumulation alone balances the discharge flux, so with no ice thickening or thinning, the ice margin remains in place. In any case, basal shear stress τ_o for sheet flow adjusts naturally to provide basal traction that rises when ice velocity is high and falls when ice velocity is low. Equation (1) was derived for sheet flow and shows that τ_o varies with the product of ice thickness h_I and surface slope n . For steady-state sheet flow, h_I decreases as n

increases and this gives the flowband a convex surface if the bed is smooth. For steady-state stream flow, on the other hand, net upslope accumulation is balanced by a discharge flux controlled by the pulling power of ice uncoupled from its bed, as seen most dramatically in the pulling force acting on an unconfined floating ice shelf (Weertman, 1957a). Since the stream-flow pulling force was ignored in the sheet-flow derivation of Equation (1), it must be accounted for by allowing the traction force to decrease as it increases. A decrease of τ_o in the downslope direction is possible in Equation (1) only if both h_I and α decrease, which gives the ice stream a concave surface for a smooth bed.

In reconstructing former ice sheets, mechanical models must specify rates of ice accumulation and ablation over the surface to determine whether the mass balance is positive, zero, or negative so the ice sheet can advance, halt, or retreat. Ideally, the surface mass balance should also be used to compute the temperature and velocity field through the ice, so that thermal conditions at the bed are obtained as model output (Hooke and others, 1979). Moreover, mechanical models should include the pulling power of ice streams, because ice streams can drain up to ninety percent of the ice. These are nearly impossible tasks, even for the most sophisticated mechanical models, because ice accumulation and ablation rates are unknown, so they must be parameterized to give temporal and spatial mass balance changes for an ice sheet; and the dynamics of ice streams are not understood at all. We can avoid specifying these unknown quantities by letting glacial geology tell us what the variations in basal traction had to be in order to produce the first-order deglaciated landscape. This is the justification for using geomorphic models to reconstruct former ice sheets. Basal shear stress variations deduced from first order glacial geology that was created by sustained steady-state glacial flow are presented below. Variations in rates of surface accumulation and ablation that are compatible with these basal shear stress variations can be computed readily (Fastook, 1984; Hughes, 1985), and are as reliable as those used to parameterize mass balance in mechanical models.

Frozen and Thawed Beds

Basal shear stress beneath a spreading ice sheet is reduced when a frozen bed becomes thawed, because basal meltwater reduces basal traction by lubricating the bed. When the bed is frozen, no sliding motion exists at the ice-bed interface, and all glacial motion is by internal shear within the ice column, where spreading velocity u varies through vertical ice thickness z according to the flow law of ice when laminar flow predominates in the ice column (Glen, 1955):

$$\frac{\partial u}{\partial z} = 2 \left(\frac{\tau_{xz}}{A} \right)^n \quad (6)$$

where $\tau_{xz} = \rho_I g (h - z)\alpha$ is the internal shear stress at height z in an ice column of height h above the ice margin, $n \approx 3$ is the viscoplastic exponent for creep deformation in ice, and A is an ice hardness coefficient

that gets smaller as ice becomes warmer and develops an "easy glide" polycrystalline fabric (Hooke and Hudleston, 1980). An ice sheet can slide over its bed at places where the bed is thawed. In these places, the basal sliding velocity u_o is given by the sliding law of ice (Weertman, 1957b):

$$u_o = \left(\frac{\tau_o}{B} \right)^m \quad (7)$$

where $\tau_o = \rho_I g h_r \alpha$ is the basal shear stress, m is a sliding exponent, and B is a sliding coefficient. In simple sliding theory, $m = 2$ and B gets smaller as the bed becomes smoother. In advanced sliding theories, larger values of m are possible and B varies with hydrostatic pressure in the basal meltwater (Paterson, 1981). Hughes and others (1981) obtained reasonable fits to present-day flowlines in Antarctica and Greenland by allowing A to range between 0.5 and 4.0 bar yr^{1/3} and B to range between 0.01 and 0.04 bar yr^{1/2}.

Equation (6) can be integrated to give an average velocity u in the ice column that can be related to τ_o , which is τ_{xz} at $z = h_r$. At a given distance $x = i \Delta x$ from the ice margin, $u_x = \bar{u} + u_o$ is the velocity of an ice column of height h and width w transverse to the flowline. Under steady-state flow, the ice flux $h w u_x$ at position x must equal the net accumulation of ice over upslope distance $L - x$ from x to $x = L$ at the ice divide. Equating the input ice flux upslope from x to the discharge ice flux at x allows curves of τ_o versus x to be computed from both the flow law and the sliding law for steady-state ice sheets.

The simplest expressions for the variation of τ_o along the flowline are computed when the flowline is the centerline of a flowband having a constant width and a constant accumulation rate along its entire length. Figure 2 gives the τ_o curves for this case, where the flow law leads to $\tau_o = \tau_D$ for a dry bed and the sliding law leads to $\tau_o = \tau_W$ for a wet bed. The τ_D curve lies above the τ_W curve because a frozen bed provides more traction than a thawed bed. For the special case of a flat horizontal bed, so that $h_r = r = 0$ in Equation (3), Figure 1 also shows ice surface profiles that are obtained along the flowline by entering τ_o values at each Δx step in Equation (3) from either the τ_D or the τ_W curve. These are steady-state flowline profiles, subject to the condition that accumulation over distance $L - \Delta x$ is balanced by ablation in the first Δx step. Ablation is primarily melting along terrestrial margins and calving along marine margins.

In Figure 2, the value of τ_o at a given x is specified by values assigned to n , m , A , and B in Equations (6) and (7). There is enough uncertainty in these quantities to allow $\tau_o = 1.0$ bar to be either 0.5 bar or 1.5 bars. The τ_o scale in Figure 1 can therefore be adjusted to reflect this variation from flowline to flowline, just as L can be adjusted on the x scale to accommodate flowlines of different lengths. In subsequent figures, τ_o and x values will not be specified, in order to emphasize this scaling flexibility. However the ratio of τ_o to x/L along all these curves is precise, and should be honored.

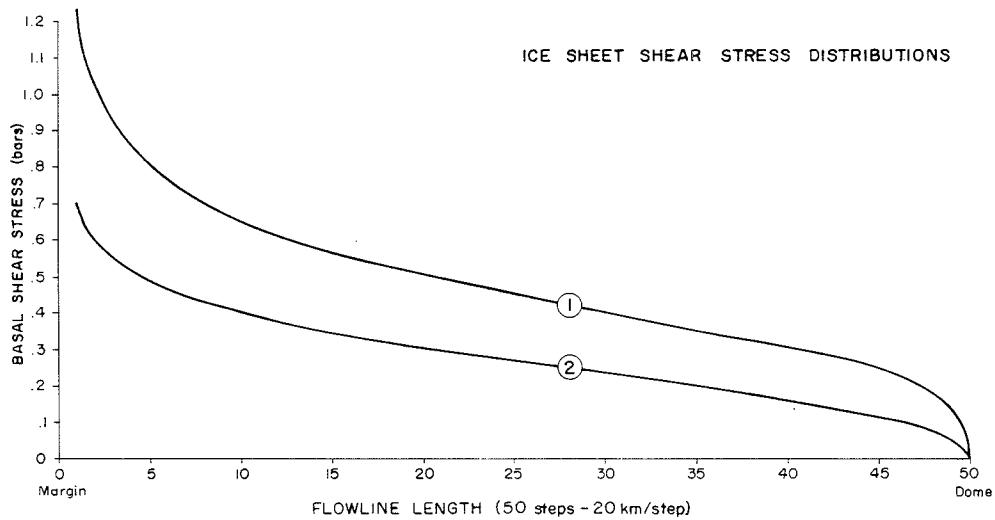
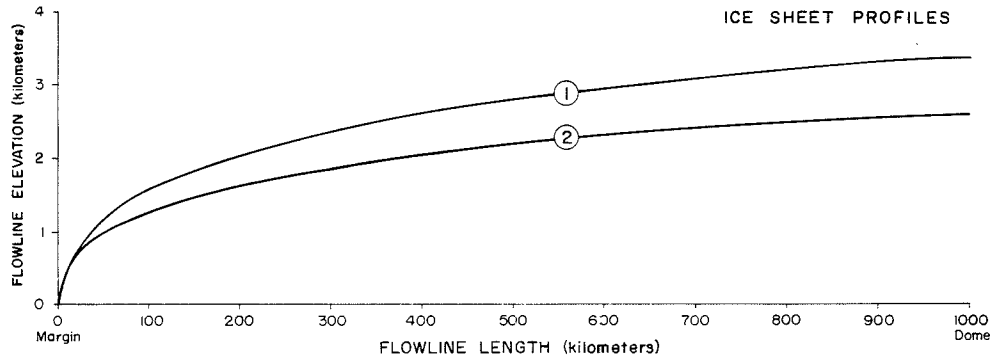

Figure 2: Traction for ice sheets on frozen and thawed horizontal beds. Surface elevation profiles (top) and basal shear stresses (bottom) are shown along a flowline for a frozen bed, curves 1, and a thawed bed, curves 2. The flowline is for a flowband of constant width over which the ice accumulation rate is constant. A basal shear stress of 1.0 bar can be as low as 0.5 bar along warm equatorward margins and as high as 1.5 bars along cold poleward margins, owing to the strong temperature dependence of creep rates.

Melting and Freezing Beds

The basal shear stress for ice passing over melting and freezing beds is simply:

$$\tau_o = f \tau_w + (1 - f) \tau_D \quad (8)$$

where f is the fraction of the bed that is thawed at a given position x along the flowline. Four cases were described in Part I, and the τ_o curves for these cases are plotted in Figure 3. Figure 3a shows the τ_o variation along a flowline that moves equatorward from a frozen central region, across a melting zone, a freezing zone, and a melting zone, in succession. Figure 3b shows the τ_o variation along a flowline that moves poleward from a frozen central region, across a melting zone, a freezing zone and a frozen zone, in succession. Figure 3c shows the τ_o variation along a flowline that moves equatorward from a thawed central region, across a freezing zone and a melting zone, in succession. Figure 3d shows the τ_o variation along a flowline that moves poleward from a thawed central region, across a freezing zone and a frozen zone, in succession. All these curves are for constant flowband width and constant accumulation rates along length $L - \Delta x$.

Ice Streams

In simple basal sliding theory, the basal water layer is a thin film that coats all bedrock projections equally, and the basal sliding velocity is controlled by projections having a critical size (Weertman, 1957b). An ice stream should develop when the basal water layer thickens progressively downstream along a flowline, and progressively drowns the controlling bedrock projections (Hughes, 1981). However, recent studies indicate that ice streams can also lie on a deforming till layer (Rooney and others, 1986) or on a frozen bed (Scofield and Fastook, 1986). Their concave surface profile can be related to the pulling power of buoyant ice (Hughes, 1986). In Figure 4, equivalent cosine variations of τ_o with x along an ice stream are shown for three cases of the pulling force. For a marine ice stream, the pulling force decreases as a half cosine cycle upslope from full buoyancy ($\tau_o = 0$) at the grounding line of its floating ice tongue. For a terrestrial ice stream, the pulling force varies as a full cosine cycle upslope from the terminus of its grounded ice lobe, with two maximum values at the point of minimum surface slope: one for full buoyancy ($\tau_o = 0$) and one for partial buoyancy ($\tau_o > 0$). Constant flowband widths and accumulation rates are assumed in plotting the τ_o curves in Figure 4.

Variable Flowband Widths

Four kinds of sheet flow are possible; flowbands will have nearly constant width downslope from an ice divide having a nearly constant elevation, flowbands will diverge strongly downslope from a prominent dome on the ice divide, flowbands may diverge from a dome and then converge into an ice stream, and flowbands will converge strongly downslope from a prominent saddle on the ice divide. Figure 5 illustrates these four kinds

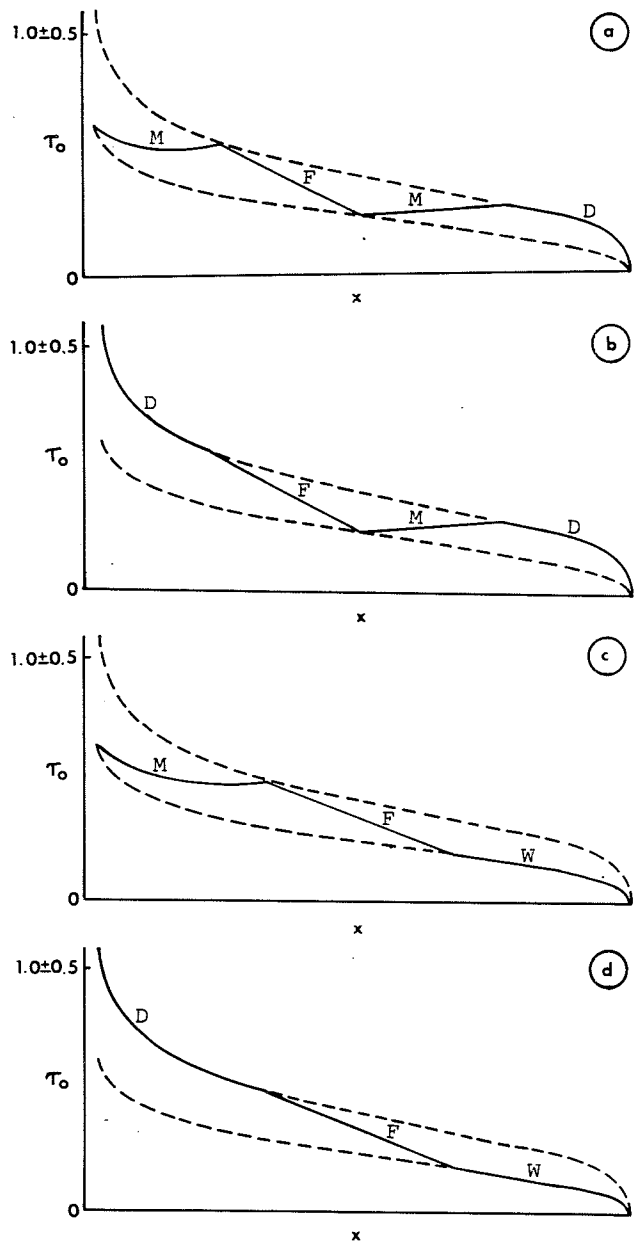

Figure 3: Traction variations across a succession of frozen (D), freezing (F), melting (M), and thawed (W) beds beneath an ice-sheet flowline. From the ice divide to the ice margin, the bed conditions are (a) frozen, melting, freezing, melting, (b) frozen, melting, freezing, frozen, (c) thawed, freezing, melting, and (d) thawed, freezing, frozen. Flowband width and accumulation rate are constant, and units are kilometers for x and bars for τ_0 .

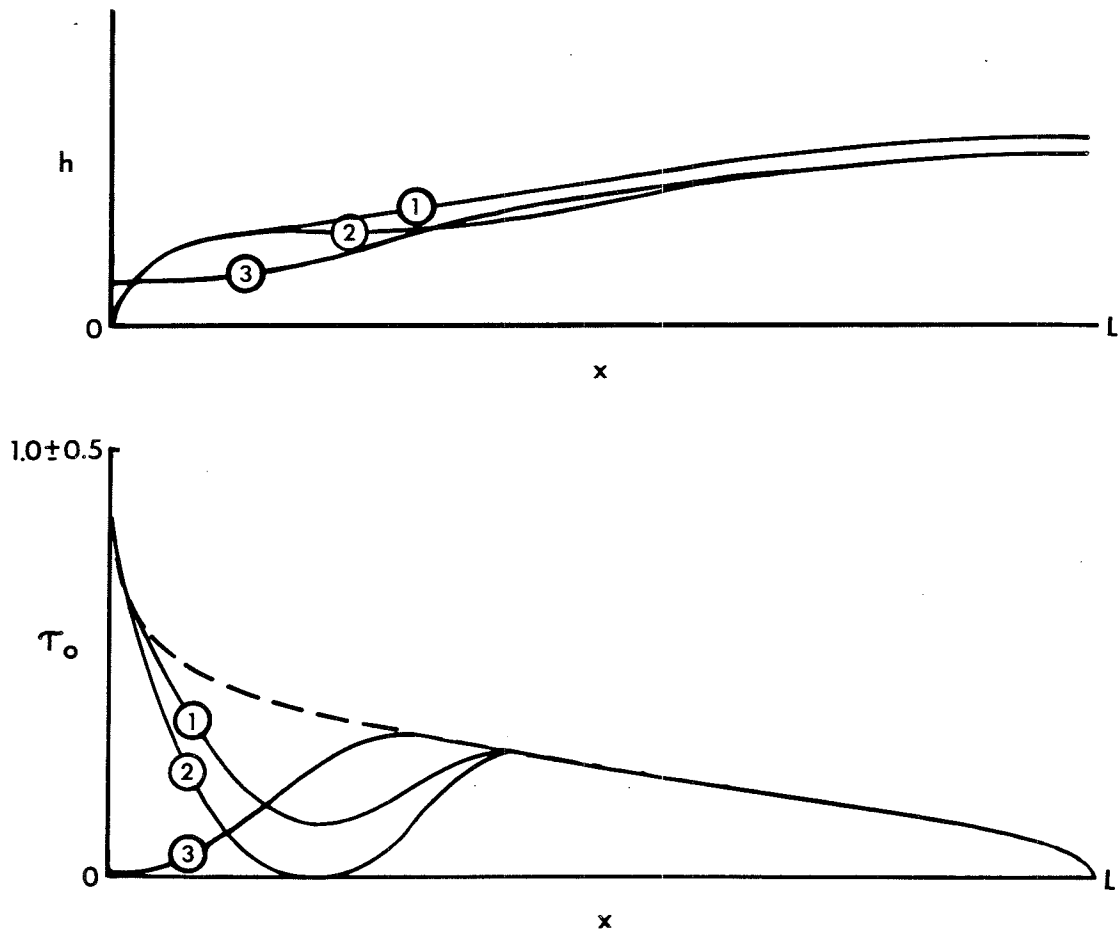

Figure 4: Traction for ice sheets on thawed horizontal beds when stream flow develops toward the margin. Surface elevation profiles (top) and basal shear stresses (bottom) are shown for terrestrial ice streams in which the minimum surface slope occurs where buoyancy is partial (curve 1) and total (curve 2), with buoyancy decreasing as a cosine curve both upslope and downslope; and for a marine ice stream in which the minimum surface slope occurs at total buoyancy, where ice becomes afloat (curve 3), with buoyancy decreasing upslope as a cosine curve. Flowband width and accumulation rate are constant, and units are meters for h , kilometers for x , and bars for τ_0 .

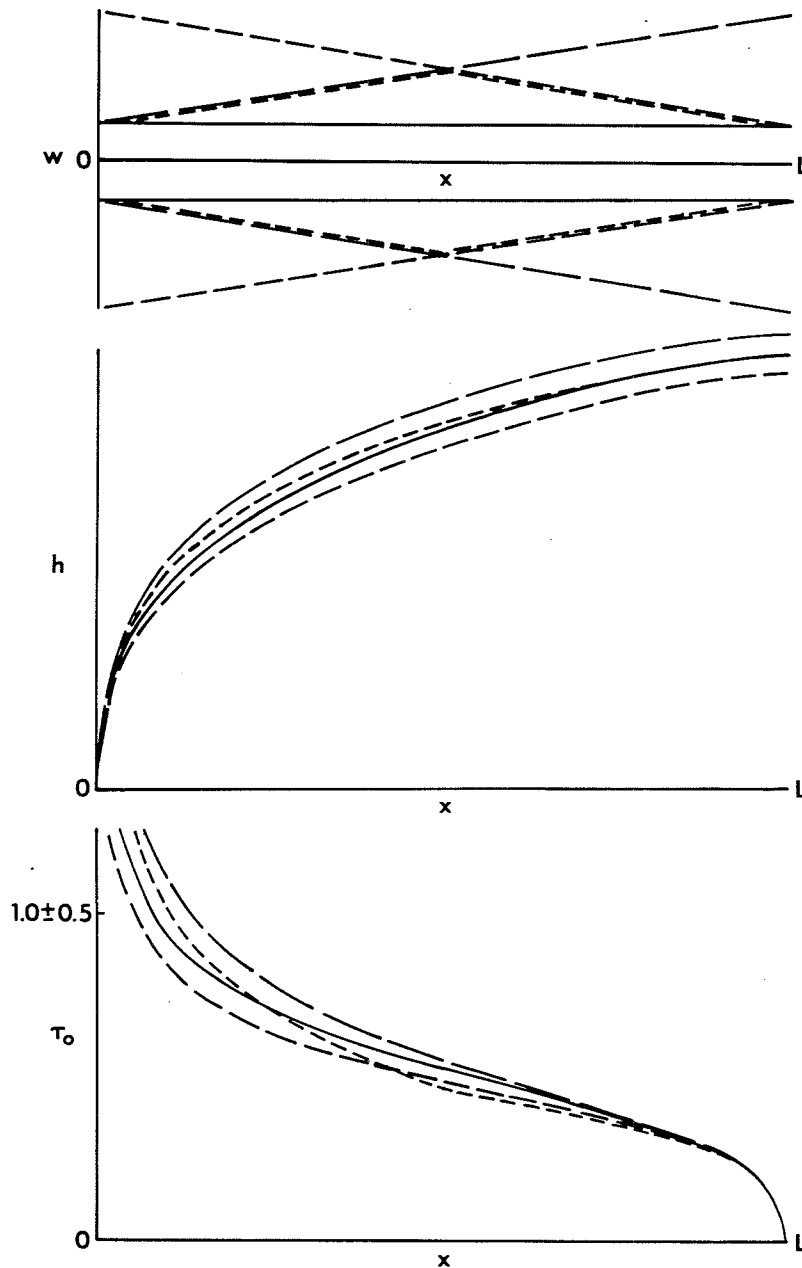

Figure 5. Traction for ice sheets with variable flowband widths. Lines with dashes of different lengths are used to show the effect of parallel (solid), converging (long dashes), diverging (intermediate dashes), and initially diverging followed by subsequent converging (short dashes) conditions of flowbands (top) on ice elevation profiles above a horizontal bed (center) and the basal shear stress (bottom). Units are kilometers for x , bars for τ_0 , and τ_0 curves are for a frozen bed. For a thawed bed, 1.0 ± 0.5 bars should be replaced by 0.6 ± 0.3 bars for these τ_0 curves.

of flowbands, the variations in basal shear stress they produce, and their flowline profiles for ice spreading over a flat horizontal bed.

The ice elevation profile for a flowband that first diverges and then converges is little different from one for a flowband of constant width. However, the ice elevation profile is lowered over five percent for diverging flow and is raised over five percent for converging flow. This means that the flowline from a saddle must be substantially shorter than the flowline from a dome in order for the dome to be higher than the saddle. This requirement favors a dome over Hudson Bay, rather than a saddle, if the Laurentide Ice Sheet had attained steady-state equilibrium at its glacial maximum.

Variable Accumulation and Ablation Rates

Variations of τ_0 in Figures 2 through 5 were for constant rates of ice accumulation along the flowline, with all ablation restricted to the first Δx step in from the ice-sheet margin. Actually, ablation can occur over up to one-third the distance to the ice divide for a flowline terminating at an equatorward ice margin. Also, a peak in the accumulation rate may occur at an ice divide low enough to be crossed by convective storm systems, but peak accumulation rates will occur between the equilibrium line and an ice divide above these storm systems. Figure 6 shows variations of τ_0 , along with variations of h above a horizontal bed, for four conditions of mass balance equilibrium. One has a constant rate of ice accumulation along the entire flowline, with ice ablation restricted to calving along a marine margin. One has constant ice accumulation over the two-thirds of the flowband nearest the ice divide and constant ice ablation over the one-third of the flowband nearest a terrestrial ice margin. One has accumulation decreasing from a maximum at the ice divide to zero at the equilibrium line, and ablation increasing from zero at the equilibrium line to a maximum at the terrestrial ice margin. One has accumulation increasing from zero at the ice divide and the equilibrium line to a maximum in between, and ablation increasing from zero at the equilibrium line to a maximum at the terrestrial ice margin. In these cases, the equilibrium line is one-third the flowline distance from the ice margin to the ice divide, and rates of accumulation and ablation change linearly with distance along a flowband of constant width.

The mass balance variations show that ice elevation climbs much more rapidly near the margin when the equilibrium line is at the margin (marine iceberg calving) than when it is one-third the flowline length in from the margin (terrestrial surface melting). Since these extremes are end members of a continuum, they can be used to scale basal shear stresses for equilibrium lines at intermediate distances in from the ice margin. It is also noteworthy that the ice elevation climbs more slowly near the ice divide when the peak accumulation rate lies between the equilibrium line and the ice divide than when it is at the ice divide. However, the elevation difference at the ice divide is less than five percent of the total elevation for these two cases, whereas both ice divides are some ten percent lower than the ice divide when the accumulation rate is constant to the ice margin. This implies that a flowline to a terrestrial margin must be longer than a flowline to a marine margin, if both flowlines are to have the same elevation at the ice divide. Stream flow at the marine margin and

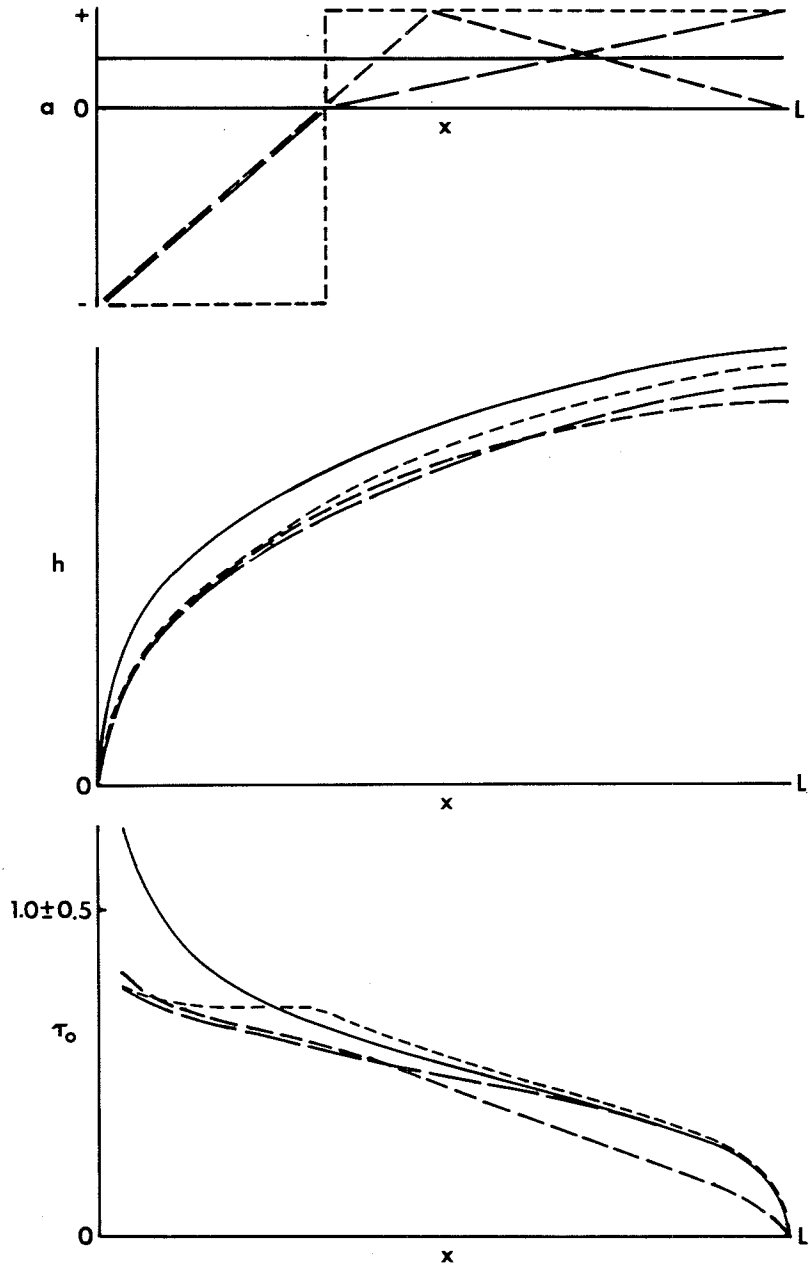

Figure 6: Traction for ice sheets with variable accumulation and ablation rates. Lines with dashes of different lengths are used to show the effect of constant and linear accumulation rates and the equilibrium-line position (top) on ice elevation profiles above a horizontal bed (center) and the basal shear stress (bottom). Mass balance equilibrium exists in all cases, with the equilibrium line at either the ice margin or one-third the flowline length in from the ice margin. Units are kilometers for x , bars for τ and τ_0 curves are for a frozen bed. For a thawed bed, 1.0 ± 0.5 bars should be replaced by 0.6 ± 0.3 bars for these τ_0 curves.

sheet flow at the terrestrial margin can overcome this elevation differential, because an ice stream has a concave surface profile.

CONCLUSIONS

Equation (3) can be used to compute ice elevation profiles quickly and easily along the flowlines of former ice sheets. The flowline trajectory first must be drawn on a contoured topographic map of the glaciated region, using the professional judgement of the glacial geologist, based on field observations. Then the flowline must be divided into equal steps of length Δx , with $\Delta x = 20$ km appropriate for short flowlines over rugged topography and $\Delta x = 100$ km acceptable for long flowlines over smooth topography. Next, ice elevation for the initial step at the ice margin must be specified, using Equations (5) for terrestrial margins and Equation (6) for marine margins. The contoured topographic map is used to determine bed elevation h_R at each Δx step along the flowline, with h_R positive above and negative below the ice margin. A value of r between zero and one-third is chosen, depending on an assessment of the degree of isostatic equilibrium that exists now and at the time when the ice sheet existed. This value of r can be constant for all steps, or can vary from step to step. In general, $r = 0$ is better along the former ice margin and $r = 1/3$ is better beneath the former ice divide. Finally, an interpretation of the glacial geology is made along the flowline in order to decide where the bed was frozen, thawed, freezing, or melting; where surface flow was parallel, converging, or diverging; and where stream flow replaced sheet flow, using criteria presented in Part I. Also, the equilibrium line should be placed along poleward marine margins and up to one-third the flowline length in from equatorward terrestrial margins. Values of τ_o at each Δx step are then specified from the curves in Figures 2 through 6. Ice elevations h at each Δx step can now be computed from Equation (3) using the specified value of h at the initial step and specified values of h_R , r , and τ_o at all subsequent steps. Allowing the maximum τ_o for sheet flow to be scaled between limits of 0.5 bar to 1.5 bar for each flowline, which is equivalent to varying A and B in the flow and sliding laws for ice, allows all flowlines to have compatible elevations at the ice divide. Any remaining mismatch should be eliminated by shifting the ice divide toward the higher flowline.

To illustrate the easy utility of Equation (3) when units for h and h_R are meters above the ice margin, Δx are kilometers, and τ_o are bars, Equation (3) reduces to:

$$h_{i+1} = h_i + \left[\frac{\tau_o}{(1+r)h - (1+r)^{1/2} h_R} \right]_i \frac{\Delta x}{(9 \times 10^{-5} \text{ bar km m}^{-2})} \quad (9)$$

The Cordilleran Ice Sheet and the Laurentide Ice Sheet at their late Wisconsin glacial maxima were close to the two end-member applications of Equation (9). At the Cordilleran extreme, a relatively thin ice sheet covered a relatively rugged bed for a relatively short time, so isostatic depression was minor and bed topographic variations changed rapidly along

flowlines. These requirements are satisfied approximately by taking $r = 0$ and $\Delta x = 20$ km, so that Equation (9) becomes:

$$h_{i+1} = h_i + \frac{(2.22 \times 10^5 \text{ m}^2 \text{ bar}^{-1}) (\tau_o)_i}{(h - h_R)_i} \quad (10)$$

At the Laurentide extreme, a relatively thick ice sheet covered a relatively smooth bed for a relatively long time, so isostatic depression was major and bed topographic variations changed slowly along flowlines. These requirements are satisfied approximately by taking $r = 1/3$ and $\Delta x = 100$ km, so that Equation (9) becomes:

$$h_{i+1} = h_i + \frac{(1.11 \times 10^6 \text{ m}^2 \text{ bar}^{-1}) (\tau_o)_i}{(1.33 h - 1.54 h_R)_i} \quad (11)$$

It is important to remember that h and h_R in Equation (3) are vertical distances above the ice margin, so that elevation above sea level for terrestrial margins and depth below sea level for marine margins must be added and subtracted, respectively, from h and h_R to obtain ice-surface elevations referenced to modern sea level. However, h_w in Equation (6) is referenced to ancient sea level at the time when the ice sheet existed.

The graphical method for reconstructing former ice sheets that is presented here gives reliable reconstructions if the constraints of the method are recognized. These constraints are the boundary conditions that were discussed in Part I. In practical terms, these constraints amount to interpreting glacial geology correctly and then using the appropriate basal shear stress curves in Figures 2 through 6 to plot Equation (9). In these curves, the upper limit of basal shear stress at the ice margin can range from 0.5 bar to 1.5 bars. The lower value is appropriate toward equatorward margins, where ice is warm and surface melting rates are high. The upper value is appropriate toward poleward margins, where ice is cold and surface melting rates are low. A value of 1.0 bar is appropriate for intermediate margins. Surface temperature is more important than surface melting rates in making this judgement, as ice thickness varies with the melting rate raised to the one-eighth power for $n = 3$ in the flow law and to the one fifth power for $m = 2$ in the sliding law (Hughes, 1981, page 249). The choice of r in Equation (9) is also important. In general, r will tend to approach zero toward the ice margin and to approach one-third toward the ice divide of a former ice sheet during its glacial maximum. Intermediate values of r can be entered in Equation (9) for intermediate positions along reconstructed flowlines.

REFERENCES CITED

- Fastook, J. L., 1984, West Antarctica, the sea-level controlled marine instability: Past and future, in Hansen, J.E., and Takahashi, T., eds., Climate Processes and Climate Sensitivity, Fifth Maurice Ewing Symposium: Geophysics Monograph 29, American Geophysical Union, Washington, D.C., p. 275-287.
- Glen, J. W., 1955, The creep of polycrystalline ice: Proceedings of the Royal Society of London, ser. A, v. 228, p. 519-538.
- Hooke, R. LeB., Raymond, C. F., Hotchkiss, R.L., and Gustafson, R.J., 1979, Calculations of velocity and temperature in a polar glacier using the finite-element method: Journal of Glaciology, v. 24, no. 90, p. 131-146.
- Hooke, R. LeB., and Hudleston, P. J., 1980, Ice fabrics in a vertical flow plane, Barnes Ice Cap: Canada. Journal of Glaciology, v. 25, no. 92, p. 195-214.
- Hughes, T. J., 1981, Numerical reconstruction of paleo ice sheets, in Denton, G. H., and Hughes, T. J., eds., The Last Great Ice Sheets: Wiley-Interscience, New York, p. 221-261.
- _____, 1985, The great Cenozoic ice sheet: Palaeogeography, Palaeoclimatology, Palaeoecology, v. 50, p. 9-43.
- _____, 1986, On the pulling power of ice streams: Chapman Conference on Fast Glacier Flow, Whistler Village, B.C., Canada, 4-8 May 1986, American Geophysical Union.
- Hughes, T. J., Denton, G. H., Andersen, B. G., Schilling, D. H., Fastook, J. L., and Lingle, C. S., 1981, The last great ice sheets: A global view, in Denton, G. H., and Hughes, T. J., The Last Great Ice Sheets: Wiley-Interscience, New York, p. 263-317.
- Paterson, W. S. B., 1981, The Physics of Glaciers (Second Edition): Pergamon Press, Oxford, 380 p.
- Rooney, S. T., Blankenship, D. D., Alley, R. B., and Bentley, C. R., 1986, Structure and continuity of a till layer beneath ice stream B., West Antarctica: Chapman Conference on Fast Glacier Flow, Whistler Village, B.C., Canada, American Geophysical Union.
- Scofield, J. P., and Fastook, J. L., 1986, Evidence for a frozen bed, Byrd Glacier, Antarctica: Chapman Conference on Fast Glacier Flow, Whistler Village, B.C., American Geophysical Union.
- Weertman, J., 1957a, Deformation of floating ice shelves: Journal of Glaciology, v. 3, no. 62, p. 38-42.
- _____, 1957b, On the sliding of glaciers: Journal of Glaciology, v. 3, no. 62, p. 205-214.

TILL STRATIGRAPHY AT THE BALD MOUNTAIN MINE SITE, NORTHERN MAINE

William R. Holland
Robert G. Gerber, Inc.
17 West Street
Freeport, Maine 04032

and

Frederick F. Bragdon
Jordan Gorrill Associates
Box 7050 DTS
Portland, Maine 04102

ABSTRACT

Detailed subsurface investigations of sites in northern Maine within the past five years have resulted in the definition of two separate tills, separated locally either by: (a) glaciofluvial and deltaic sands and gravels; (b) glaciolacustrine silty clays; or (c) an intensely weathered zone which may be a paleosol. The thickness of the upper till ranges from 9 m to almost 21 m. The thickness of the lower till ranges from 12 m to 18 m. Similar stratigraphy has been documented along the St. John Valley (Prescott, 1973) and in the Aroostook Valley near Limestone. Although it is impossible to correlate deposits from basin to basin on the basis of facies lithologies, it appears that the thickness of lake clays (particularly along the St. John River) and the possible soil development at depth may record a significant period of time during which the regional land surface was subaerially exposed. A possible candidate for such a nonglacial event might be the Gayhurst Interstadial of southeastern Quebec (Gadd, 1976). Alternatively, if the weathered zone has formed exclusively by ground water circulation and not by lengthy subaerial exposure, the inferred glacial recession and readvance may have been only a minor episode associated with a fluctuating ice margin during late Wisconsinan time. There are no absolute dates on any of the subsurface deposits.

INTRODUCTION

During the early 1970's, a substantial deposit of volcanogenic sulfides and associated precious metals was discovered near Bald Mountain in T12 R8 WELS, Aroostook County. The Minerals Division of Superior Oil Company obtained exploration rights during the later years of the decade, and buoyed by the high copper prices of the day, were poised to develop the deposit during the early 1980's. As part of the preliminary

hydrogeological and geotechnical work conducted at and around the proposed mine site, drilling and geophysical programs were completed by Jordan Gorrill Associates of Portland, Maine (Jordan Gorrill, 1981a, 1981b, 1982).

In the general downturn of mineral commodities in 1982, the price of copper plummeted, and Superior sold their rights to the deposit. Rumor has it that the deposit has changed hands once again within the last two years. Although there have been apocryphal stories concerning the extraction of precious metals from within the gossan, to our knowledge the level of interest in the site has steadily declined to the present day.

This short paper is a summary of the results and interpretations of the various exploration programs at Bald Mountain, as they pertain to questions concerning a drift lithostratigraphy of northern Maine. It is a slightly expanded version of a report which appeared in "The Maine Geologist" (Holland and Bragdon, 1982).

GENERAL BACKGROUND

The work of Brewer, Genes, Lowell, Kite, Newman, and Prescott has shown that the resolution of many key regional problems is to be found in Aroostook County, Maine. Such problems have primarily been related to the presence, extent, direction of flow, and thermal regime of ice caps over northern Maine. Because of the lack of good exposures, the drift stratigraphy for most of northern Maine outside of the St. John Valley has not been well documented.

Based in part on observations at an exposure on the south side of the St. John River near Golden Rapids, and in part on observations in more easterly terranes, Genes and Newman (1980) proposed a three-fold stratigraphy which included a single mid-Wisconsinan till and two late-Wisconsinan tills. The oldest till (St. Francis till) has been described as a gray clayey till with an east-west fabric containing clasts composed primarily of the Devonian slate of the Seboomook Formation (Genes, 1980). The uppermost parts of the two younger tills (termed Mars Hill till and Van Buren till) have been described as brown in color, with a sandier matrix and different clast lithologies than the St. Francis till. The difference between the two younger tills has been suggested as resulting from the relative abundance of granite gneiss erratics derived from the Canadian Shield. The Mars Hill till was believed to contain no granite gneiss, while the Van Buren till contained three to five percent granite gneiss. The two tills were suggested to have been emplaced contemporaneously by either different ice masses or ice with a non-homogeneous internal thermal regime (Genes, 1980). Subsequent work by Newman and others (1985) has indicated the presence of Canadian Shield erratics farther south than was originally believed, so the concept of the Mars Hill-Van Buren drift has been abandoned.

Lowell (1980a, 1980b) and Kite and others (1982) described the till stratigraphy at many of the same sites described by Genes and others, and concluded that although fabric and provenance differences among tills definitely exist, the differences in color are secondary features due to

clast and matrix oxidation, not to differences in clast lithology or provenance.

On the basis of subsurface information gathered during the course of projects throughout northern Maine (including the Bald Mountain site, the Fraser Paper Company landfill site in Frenchville, the Great Northern Paper Company landfill site in East Millinocket, and at Loring Air Force Base in Limestone), it appears that many megascopic features, color most notable among them, are essentially similar between members of apparently unique drift sheets. As a result, the distinction of stratigraphic units in northern Maine tills, either within the same drift sheet, or among different drift sheets, requires more detailed analysis. This paper presents a two-fold till stratigraphy based on such an analysis, as well as on what may prove to be a regional marker unit.

METHODS OF DATA COLLECTION

The majority of the data were gathered from test boring, test pit, and seismic explorations conducted during the geotechnical and hydrogeological field programs at the proposed Bald Mountain mine site. More than 40 borings, all of which penetrated the entire overburden column, were drilled. Standard 1.5-foot split spoon samples were taken for laboratory testing at five-foot intervals; multiple-level ground-water monitoring wells and piezometers were installed; and borehole permeability tests were conducted. In addition, 38 backhoe test pits were excavated above the ore body itself and in the vicinity of the proposed tailings pond embankments. Although they were generally shallow (less than 6 m deep in most cases), the test pits yielded some excellent exposures and samples in areas where no natural exposures existed. Also, 7,830 m of continuous seismic refraction profiling and 29 vertical electrical soundings were accomplished.

All collected samples were inspected visually, and selected samples were analyzed in the laboratory for grain-size distributions, Atterberg limits, permeabilities, and consolidation performance. A sample of clayey silts was sent to Dr. Davida Kellogg of the Institute for Quaternary Studies at the University of Maine for an analysis of the diatom flora.

GENERAL LATE WISCONSINAN SETTING

It is not the function of this paper to present the literature, regional setting, and the current hypotheses concerning the glaciation and deglaciation of northern Maine, and we refer the reader elsewhere in this volume for such a review. It should be noted, however, that the striations at and around the Bald Mountain site indicate that this area lay to the south of the regional ice divide proposed by Kite and others (1982). Also, this area generally lacks thick drift (especially stratified sediments associated with deglaciation), a feature which is typical of much of Aroostook County.

SUBSURFACE SURFICIAL GEOLOGY OF THE BALD MOUNTAIN SITE

It has been recognized for some time that two basic colors are manifest in northern Maine tills. Typically, where fresh exposures are found, an olive unit overlies a gray unit. The problem is whether the change in color can be used as a criterion for distinguishing different till sheets.

Figure 1 is an interpretive cross section based on subsurface exploration at the Bald Mountain site. There are five megascopically discernible units portrayed on the cross-section: (1) a relatively thin, olive-colored surface till; (2) a massive gray till; (3) laminated clay/silt lake-bottom sediments; (4) deltaic sands and gravels; and (5) a highly oxidized zone. A horizon ranging in depth from 18 m to 26 m appears to provide an effective stratigraphic datum. This horizon separates the gray till into two sub-units. The horizon is represented by the lake bottom and deltaic deposits, an intensely weathered zone (buried soil?), and a buried bedrock spillway. It should be noted that the contact between the olive and the gray till is near the surface and does not correspond to this horizon. It is also noteworthy that the apparent source of the stream which deposited the stratified sediments was to the south, and not to the north. Although it is assumed that the stratified sediments are glacial, it is also possible that all of the stratified sediments were deposited by nonglacial streams.

SUMMARY OF LITHOSTRATIGRAPHIC PROPERTIES OF THE PRINCIPAL UNITS

The surface till unit at Bald Mountain is almost exclusively pale brown to dark olive below the upper C-horizon. Munsell classifications range from 10YR 6/4 to 5Y 4/3. According to the Unified Soil Classification, it is a gravelly silty sand to sandy silt with 35 to 50 percent by weight passing the .075 mm (No. 200) sieve. It is generally 3 to 4 m thick, and the contact between this unit and an underlying gray unit is generally gradational over 1 to 1.5 m. Existing moisture contents of the surface till range from 10 to 14 percent, and the average liquid limit and plasticity index are 24 and 6, respectively. Results of standard penetration tests (SPT) range from 20 to greater than 100 blows per foot, indicating that the material is dense to very dense. Laboratory permeabilities range from 10^{-5} cm/sec to 10^{-6} cm/sec. No borehole permeability tests were conducted on this unit. The seismic velocity of the olive till ranges from 914 m/sec to 1,219 m/sec. The unit locally contains lenticular fluvially-bedded sands and gravels which exhibit collapse deformation in some places.

Typically encountered only below the olive till, the gray till at Bald Mountain is exposed at the surface only in a few places, and is generally restricted to areas where bedrock is greater than 5 m deep. The thickness ranges from one meter to several tens of meters. It is generally closer to the surface or at the surface in areas where the water table is high and vertical hydraulic potentiometric gradients are upward. The gray till is typically a slightly gravelly sandy silt; the weight percent passing the 0.075 mm (No. 200) sieve ranges from 40 to 55 percent.

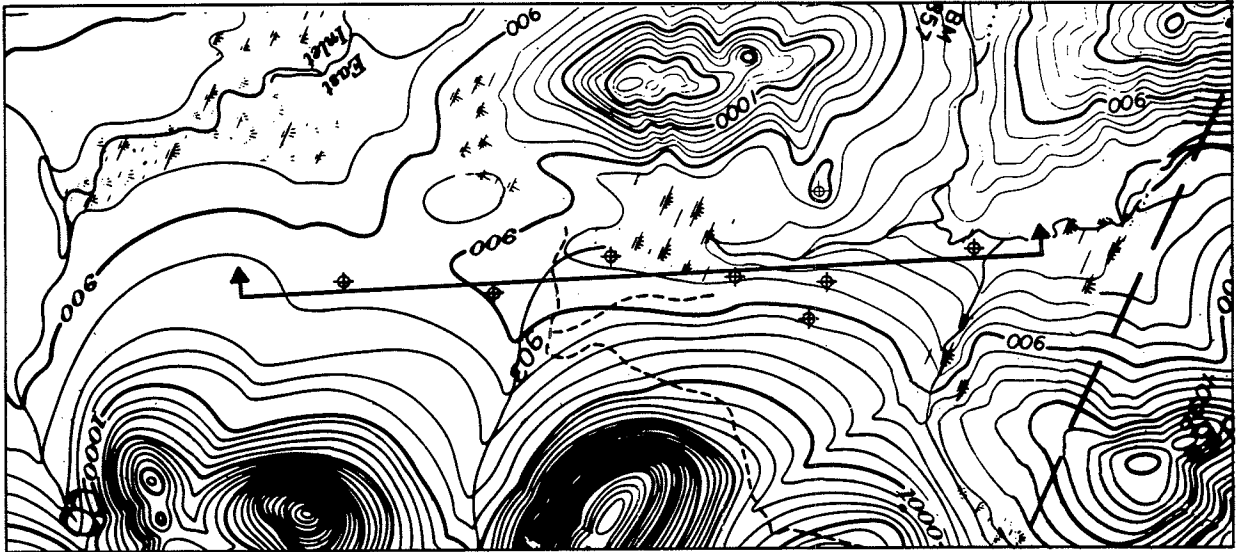

Based on the Greenlaw, Winterville, Mooseleuk Lake & Fish River Lake U.S.G.S. Quadrangles.

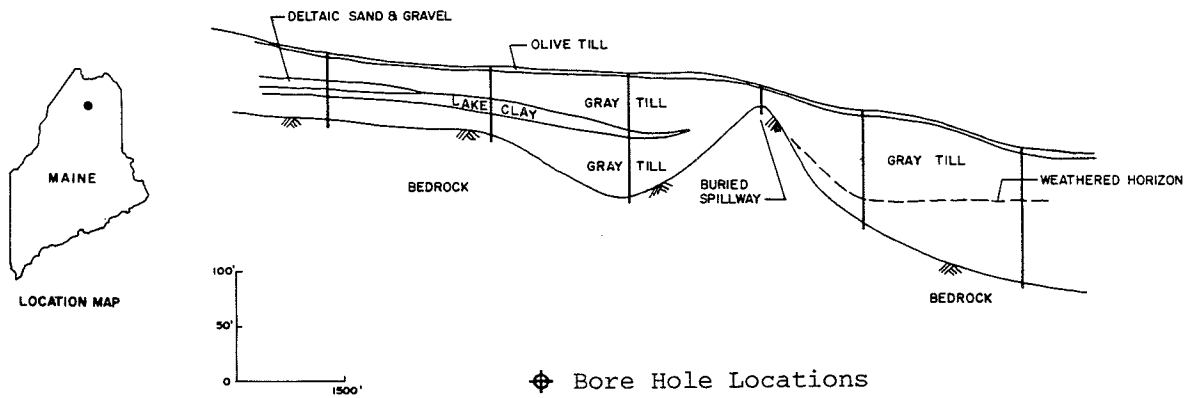

Figure 1. Cross-section taken along Clayton Stream valley, west of the Bald Mountain mine site in T12 R8 WELS.

The range of existing moisture content for the gray till is from 7 to 12 percent, and the average liquid and plastic limits are 24 and 6, respectively. Blow counts range from 20 to greater than 100 blows per foot, indicating that the till is very dense. Results of laboratory permeability tests are similar to those calculated for the olive till. Results of in-situ permeability tests range from 10^{-4} cm/sec to 10^{-5} cm/sec, but the permeability of the upper 3 to 6 m of gray till is within the range given for the olive till. The upper 3 to 6 m also often contain stratified lenses similar to those observed in the olive till. The seismic velocity of the upper 6 to 18 m of the gray till is similar to that of the olive till (914 m/s to 1,219 m/s). Below these depths, the velocities are typically in the 1,829 m/sec to 2,438 m/sec range.

Where vertical electrical soundings (VES) were made, no detectable differences in resistivity within or between any tills were found. Typical values for saturated sediment lie in the 175 to 380 ohm-meter range. This lack of discernible differences in electrical properties is probably a reflection of similar mineralogy throughout the glacial sediment. Whether this suggests similar provenance is not known.

The lake-bottom deposits are as much as 6 m thick and contain small amounts of nonmarine diatom flora of the type found in Antarctic lakes (Borns, H. W., Jr., and Kellogg, D., pers. comm., 1981). Although the presence of diatom flora proves cold subaerial conditions, there is no biostratigraphic evidence that the lake was interstadial. An assessment of the stratigraphic significance of the subsurface features found at the Bald Mountain site hinges obviously on a determination of the length of time that subaerial conditions were experienced. Because there are no absolute dates on any of the subsurface sediment, this determination depends entirely on the genetic interpretation of the weathered materials. Given the data that we currently possess, we cannot say with certainty that subsurface (i.e. ground water) weathering should be ruled out. We consider this explanation to be unlikely because of the low permeability of the surrounding sediments, and because of the proximity of the weathered materials to sediments of proven subaerial affinities.

Considering the proximity of the weathered zone (which is at least 1.5 m thick in places), we deduce that the lake was proglacial, dammed either by advancing ice following a period of subaerial landscape exposure or by retreating ice preceding one. Neither the lake-bottom clayey silts nor the deltaic sands and gravels are weathered, which could suggest that the development of the lake followed the period of weathering. Consolidation testing on lake-bottom deposits shows them to be overconsolidated: the maximum past pressure experienced by the lake-bottom deposits exceeded the strength limits of the consolidation frame (49 kg/cm^2). This property reflects the maximum past pressure experienced, which was most likely caused by overriding by glacial ice. The till above the lake deposits and weathered zone is therefore considered to be a significantly younger unit than the till below.

The color, grain-size distributions, permeabilities and clast lithologies between the two gray till units are similar with the exception of the weathered material between them. However, there is a marked

increase in seismic velocity at the top of the lower till unit. The velocity change may indicate an increase in compression at the contact, which tends to corroborate the interpretation from the consolidation testing results: a readvance of ice over the lower unit of the gray till. The inferred readvance further supports a stratigraphic division between the two gray till units, rather than at the contact between the olive and the gray tills. No seismic velocity changes were observed between the olive and the upper gray till units.

On the basis of over 50 grain-size analyses, it appears that the average mean grain size of the olive till is slightly coarser than that of the gray till, but the textural shift, when observable, does not coincide with the color change. The slight textural change generally occurs well below the color transition. Because of their texture, the shallow materials are susceptible to oxidation except where wholly saturated (i.e. where the ground water is generally high). The indications are that till color is dependent on secondary processes as well as lithology.

Gerber (1982) and Rand and Gerber (1976) have noted similar color patterns in till exposed at the proposed Sears Island nuclear plant, and after heavy metal separation, x-ray diffraction, and petrographic analyses were conducted, concluded that the chief difference between the tills was the color difference, due to the staining of an originally gray colored sediment by iron oxides resulting from the weathering of biotite.

Subsurface exploration of other sites in northern Aroostook suggests that multiple till sections are quite common in the deep bedrock valleys. The stratigraphic units separating the tills may vary from lake-bottom clays to significant accumulations of presumably glaciofluvial sands and gravels. To our knowledge, in none of these cases does an olive/gray color change in tills with depth coincide with a documented stratigraphic datum such as described above.

DISCUSSION

Based on the Bald Mountain data, as well as data collected from other localities in northern Maine, we have formulated two working hypotheses:

1. There are two principal till units of apparently distinctly different ages in northern Maine. The tills are similar to each other in appearance and index properties except where they have been oxidized to a brown or olive color. Both consolidation testing on intervening lake clays and a substantial seismic velocity increase at the contact between the two tills suggests that the lower unit has been more highly compacted than the upper, a reflection of overriding by glacial ice.

2. Because of the presence of what appears to be a buried soil and the widespread distribution of buried stratified deposits in northern Aroostook, there appears to have been at least one regional interstadial in northern Maine previous to late Wisconsinan time. Correlation with the Gayhurst deposits of southeastern Quebec would suggest that this interstadial has a late mid-Wisconsinan age. Such a correlation is based

solely on relative stratigraphic position and is thus quite tentative. It is possible that both till units are associated with the late Wisconsinan glaciation, implying that they are merely separate facies within the same drift sheet. However, the presence of the weathered horizon and lacustrine deposits between the two tills places severe limitations on this interpretation.

There seems to be insufficient corroborative evidence to support a time stratigraphy for northern Maine tills based on megascopic properties alone. There is a paucity of detailed work on the glacial sediment in northern Maine, and we feel that it is premature to assign formal stratigraphic status to northern Maine till units.

REFERENCES

- Gadd, N. R., 1976, Quaternary stratigraphy in southern Quebec, in Mahaney, W. C., ed., Quaternary Stratigraphy of North America: Dowden, Hutchinson and Ross, Stroudsburg, Penn., p. 37-50.
- Genes, A. N., and Newman, W. A., 1980, Wisconsin glaciation of northern Aroostook County, Maine, in Roy, D. C., and Naylor, R. S., eds., New England Intercollegiate Geological Conference Guidebook for Field Trips in Northeastern Maine and Neighboring New Brunswick, p. 179-188.
- Genes, A. N., 1980, Outline of the Pleistocene Geology of Northern Maine, in Roy, D. C., and Naylor, R. S., eds., New England Intercollegiate Geological Conference Guidebook for Field Trips in Northeastern Maine and Neighboring New Brunswick, p. 22-31.
- Gerber, R. G., 1982, One till or two?: The Maine Geologist, v. 8, no. 3, p. 1.
- Holland, W. R., and Bragdon, F. F., 1982, Two tills in northern Maine: The Maine Geologist, v. 8, no. 2.
- Jordan Gorrill Associates, 1981a, Surficial geology of proposed tailings impoundment areas, Bald Mountain site: Report to Superior Oil, Minerals Division, 14 p.
- Jordan Gorrill Associates, 1981b, Preliminary geotechnical/geohydrology exploration program, Bald Mountain site: Report to Superior Oil, Minerals Division, 15 p.
- Jordan Gorrill Associates, 1982, Geophysical survey, Bald Mountain site: Report to Superior Oil, Minerals Division, 8 p.
- Kite, J. S., Lowell, T. V., and Nicholas, G. P., 1982, Quaternary studies in the Upper St. John River basin: Maine and New Brunswick: Guidebook for the 1982 New Brunswick Quaternary Association Field Trip, 55 p.
- Lowell, T. V., 1980a, Evaluation of the mineral potential, Upper St. John River valley, Aroostook County, Maine -- Appendix D: Reconnaissance surficial geology northwest of the St. John River between Allagash, Maine and St. Pamphile, Quebec: Maine Geological Survey, Open-File Report 80-14e, 28p.
- Lowell, T. V., 1980b, Late Wisconsinan ice extent in Maine: Evidence from Mt. Desert Island and the St. John River area: M.S. thesis, University of Maine, Orono, 180 p.
- Newman, W. A., Genes, A. N., and Brewer, T., 1985, Pleistocene geology of northeastern Maine, in Borns, H. W., Jr., LaSalle, P., and Thompson, W. B., eds., Late Pleistocene history of northeastern New England and adjacent Quebec: Geological Society of America, Special Paper 197, p. 59-70.

Prescott, G. C., Jr., 1973, Groundwater favorability and surficial geology of the lower St. John River valley, Maine: U.S. Geological Survey, Hydrologic Investigation Atlas HA-485.

Rand, J. R., and Gerber, R. G., 1976, Sears Island fault investigation - Sears Island, Maine: Report to Central Maine Power Co., Augusta, Maine, 58 p.

GLACIAL DISPERSAL FROM THE PRIESTLY LAKE AND DEBOULLIE PLUTONS, NORTHERN MAINE

Eric F. Halter*
Department of Geological Sciences
State University of New York at Buffalo
Buffalo, New York 14226

INTRODUCTION

Due to extensive forest cover and generally thin till deposits, interpretation of the deglaciation history of northern Maine has been largely restricted to the study and interpretation of bedrock ice-flow indicators such as striations and ice-molded bedrock forms (Lowell, 1980). Some studies have been made on thicker glacial deposits near the Canadian border (Becker, 1982; Kite, 1983; Lowell, 1985), but interior northern Maine has not yielded sufficient till exposure to enable a stratigraphic study of deglaciation.

The work of Chauvin and others (1984), Martineau (1979), LaSalle and others (1977a, 1977b), and Shilts (1981) on late Wisconsinan deposits in eastern Canada has established a relationship between glacial dispersal patterns, other ice-flow indicators such as striations, and paleocurrent indicators in morainal deposits. This study attempts to use dispersal patterns from two igneous plutons in northern Maine to give quantitative documentation to proposed ice-flow histories in the region.

BACKGROUND

Interpretations by LaSalle and others (1977b) of both morainal deposits and directional indicators in the region of southern Quebec adjacent to northern Maine led them to support the theory first proposed by Chalmers (1889, 1890, 1898) that local glaciation may have played a role in shaping the Pleistocene history of northern Maine and adjacent Canada. LaSalle and others (1977b) proposed that localized glaciation took the form of a residual ice mass that was separated from the main body of Laurentide ice by the opening of the St. Lawrence River Valley. Kite and others (1982) speculated that drawdown of ice in northern Maine and adjacent Quebec occurred as the glacier thinned and a calving margin migrated up the St. Lawrence Valley. This is believed to have led to a reversal of ice

*Present address:
Lamont-Doherty Geological Observatory
Palisades, NY 10964

flow (to the northwest) from the southeastward flow of the main Laurentide Ice Sheet (LaSalle and others, 1977b).

Investigation of till localities along the St. John River led Becker (1982) to suggest that the movement of northward flowing ice played a role in depositional processes in the area during late Wisconsinan time, a possibility also suggested by Newman and others (1985). Other investigations in northwestern Maine (Kite and others, 1981, 1982; Lowell, 1980, 1985) further support evidence from adjacent Canada that the late Wisconsinan deglaciation history in northern Maine included the influence of a residual ice mass.

Another method of interpreting ice-flow directions is through the study of the distribution of erratics from distinctive bedrock sources (Flint, 1957, p. 122-130). Debris from these sources can be traced with the result that ice-flow direction can be inferred from the transport and distribution of erratics.

ERRATIC DISPERSAL STUDIES

The bedrock of northern Maine consists primarily of slate, phyllite, graywacke, schist, and quartzite of Cambrian to Devonian age, centered along the axis of the Connecticut Valley-Gaspe Synclinorium (Roy, 1980). Within the Seboomook slate and graywacke outcrop belt, the largest bedrock formation in the region (Boudette and others, 1976), lie two Devonian-age igneous bodies (Figure 1): the Priestly Lake granodiorite (Boudette and others, 1976) and the Deboullie Igneous Complex composed of granodiorite and syenite (Boone, 1958). Material from these two igneous bodies is readily distinguishable from the surrounding country rock and from ice-transported Canadian shield erratics, providing an excellent setting in which to study glacial transport from two unique point sources.

A quantitative study of erratic dispersal in the Priestly and Deboullie areas was undertaken using a system of roadside boulder counting; traditional methods of erratic counting (Shilts, 1973) were found to be impossible due to extensive forest cover. Roadside boulder counting worked well in northern Maine because logging roads in the area are constructed by bulldozing glacial drift with, little material transported to the road from other sources. Therefore, it is assumed that all material found along the roadsides has been derived from immediately adjacent exposures created during road construction.

In this study a boulder was classified as a stone with an intermediate axis of 256 mm or more. Counting of boulder-sized material continued along a roadside equal to the distance required to encounter 500 stones in the Priestly area, or 300 stones in the Deboullie area, and the number of igneous erratics was noted in each count. The number of boulders per count had to be reduced at Deboullie due to a lack of till exposure; this allowed for an equally spaced data set with an average count distance of 1 km in both study areas. A total of 54,000 boulders were recorded, representing 69 counts in the Priestly area and 49 counts in the Deboullie area.

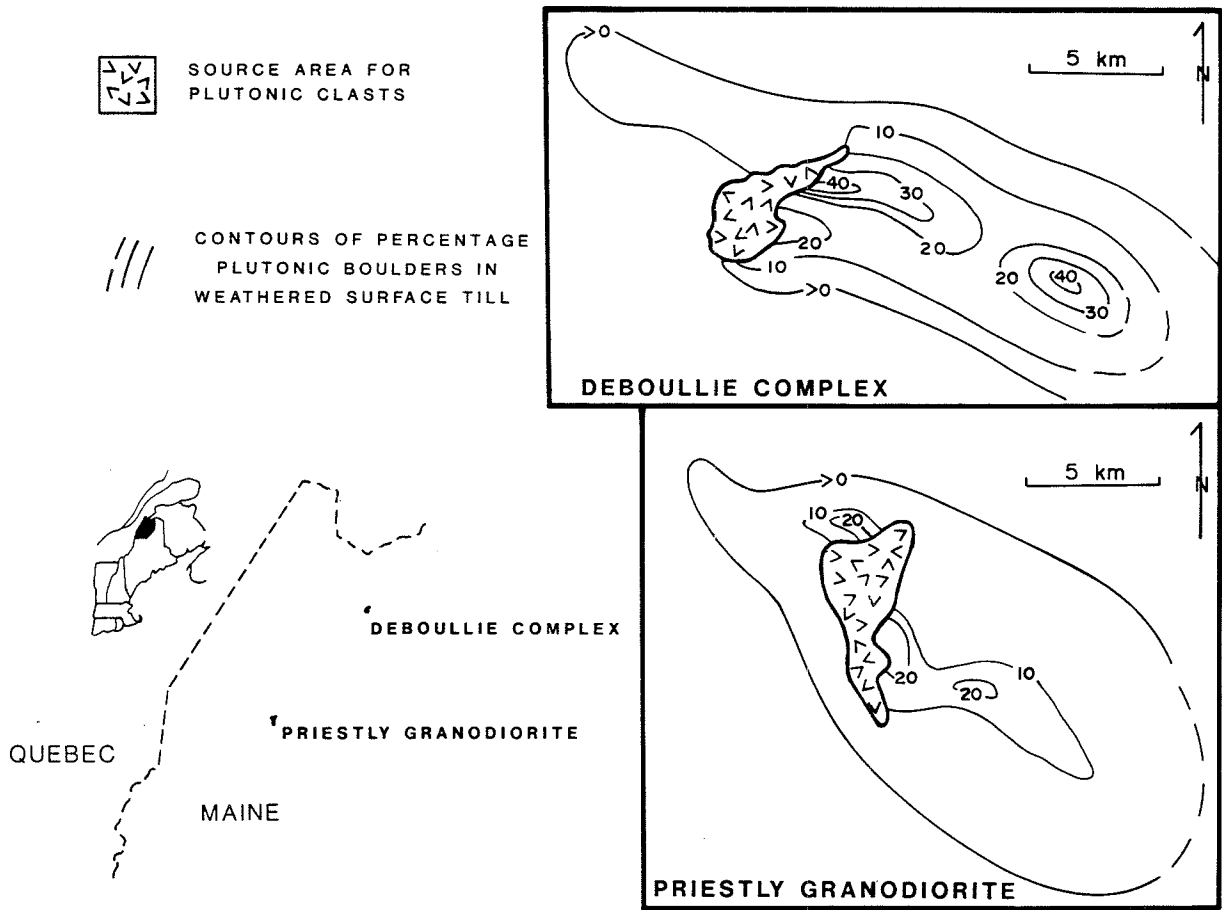

Figure 1. Boulder transport from the Deboullie Igneous Complex and the Priestly granodiorite. Northwestward erratic transport was less than southeastward transport around both plutons.

Figure 1 shows the dispersal pattern of boulder-sized erratics from the Priestly and Deboullie areas. The dispersal patterns from both plutons indicate similar, two-directional trends: a southeast-trending dispersal pattern with azimuths of 115° to 130° and a northwest-trending dispersal pattern with azimuths of 305° to 315° . Southeast dispersal of erratics from both plutons is clearly the dominant pattern, with the longest dispersal trains and the highest percentage of transported igneous material. The southeast-trending train at Priestly has a high of 26.5 percent igneous erratics and extends 13 km (8 mi) at its longest point. The southeast-trending train in the Deboullie area has a high of 41 percent igneous erratics and extends 16 km (10 mi) at its longest point. This southeastward dispersal is considered to be the result of transport by southeastward ice flow late in the area's glacial history.

The magnitude and distance of northwestward erratic dispersal is much less in comparison to the southeastward movement; percentages range from only 4 to 5 percent, distances from 6 to 8 km (Figure 1). This small amount of dispersal could suggest that other possibilities besides glacial transport might account for this northwest trend, such as stream transport, mass wasting, or meltwater transport during deglaciation. However, boulder counts were located so as to eliminate mass wasting and stream transport as a factor, and areas which contained meltwater-related deposits were avoided. Further, traverses into wooded areas off logging roads were made to confirm the existence of glacially transported igneous material. These traverses revealed igneous boulders, many quite large, in loose surface till to the northwest of both igneous bodies. This observation supports the identification of the northwest dispersal pattern as a result of ice transport.

The northwestward dispersal pattern appears to have been controlled to some extent by topography at both locations. Northwestward dispersal from the Priestly Lake granodiorite may have been channeled by Priestly Mountain, since no erratics were found on the western side of the mountain (granodiorite outcrops only on the eastern side). Lack of northwestward dispersal from the southern half of the Deboullie pluton (Figure 1) indicates that some topographic control may have contributed to the dispersal pattern in that area as well.

TILL STUDIES

In addition to boulder counts, 45 samples of unweathered till were collected in the two study areas, 26 around the Deboullie area and 15 around the Priestly area. A limited number of unweathered till exposures exist in the region, but where they do occur (23 of the 45 sample locations), a till sample was collected. The 22 remaining samples were collected from soil pits that were dug to a horizon of unweathered till (C_{ox} horizon), generally 75 to 100 cm in depth. Size analysis was performed by sieve and pipette methods on a 100 g sample of till from all 45 localities. Heavy mineral analysis using bromoform was conducted on the 2.0 to 3.0 phi size of till, since this size material may represent the terminal grade of most heavy minerals in glacial transport (Dreimanis and Vagners, 1971). In addition to till samples, 100 pebbles were collected

from the unweathered horizon at each till sample location for lithologic analysis.

Lithologic analysis of pebbles from till around the two plutons revealed 74 to 97 percent graywacke, slate, phyllite and quartzite. The Seboomook Formation, the primary bedrock source in the region, may have contributed all of these lithologies to the till. Pebble count localities with stones from the Priestly Lake and Deboullie plutons were found only to the southeast of the two igneous bodies; no pebble counts northwest of either pluton included erratic pebbles. A paucity of unweathered till deposits south of the Priestly Lake pluton prohibited defining a pattern of dispersal of erratic pebbles; only two locations showed evidence of igneous pebbles in till. Dispersal of pebbles around the Deboullie pluton was more extensive (Figure 2). Till localities define a pebble dispersal train 6.5 km (4.0 mi) long, with the one sample location showing a high of 20 percent igneous pebbles.

Till sample localities which contained igneous pebbles also showed an influence of igneous material in the fine-grained component of till. Generally, till samples taken southeast of the two igneous bodies showed the influence of incorporation of igneous material in both their grain size and heavy mineral content. In terms of grain size, till samples which contained erratic pebbles also showed a greater sand fraction (-1.0 to 4.0 phi) relative to those tills that did not contain igneous pebbles, giving erratic-bearing tills coarser median and graphic mean grain size. In terms of heavy minerals, no trend could be found in the Priestly area, probably (as with the pebble counts) due to a lack of credible data points. However, heavy mineral content in tills around the Deboullie area showed enrichment trends similar to trends for pebble counts around the pluton (Figure 2). None of the till samples collected north or northwest of the plutons showed a textural influence different from till samples in areas consisting solely of slate and graywacke bedrock.

DISCUSSION

Dispersion of boulder-sized erratics in the Priestly and Deboullie areas parallel the bi-directional striation patterns found in their respective USGS 15-minute quadrangles (Halter and others, 1984). Age and directional relations found in the two quadrangles are similar to those found by other authors in adjacent study areas (LaSalle and others, 1977a, 1977b; Kite and others, 1982; Lowell, 1985). These authors attribute the northwest directional indicators to ice flow from a late Wisconsinan ice mass. The large number of localities showing two striation directions without assignable azimuths within the two quadrangles is compatible with the interpretation that these two plutons lie within the "zone of confusion" of Kite and others (1982; Figure 3). This is a zone which separates dominant 305° to 355° (northwestward) ice flow indicators to the north from strictly 95° to 125° (southeastward) flow indicators to the south.

A pattern of erratic dispersal similar to those mapped at Priestly and Deboullie was found by Martineau (1979) in the Lac Temiscouata region of

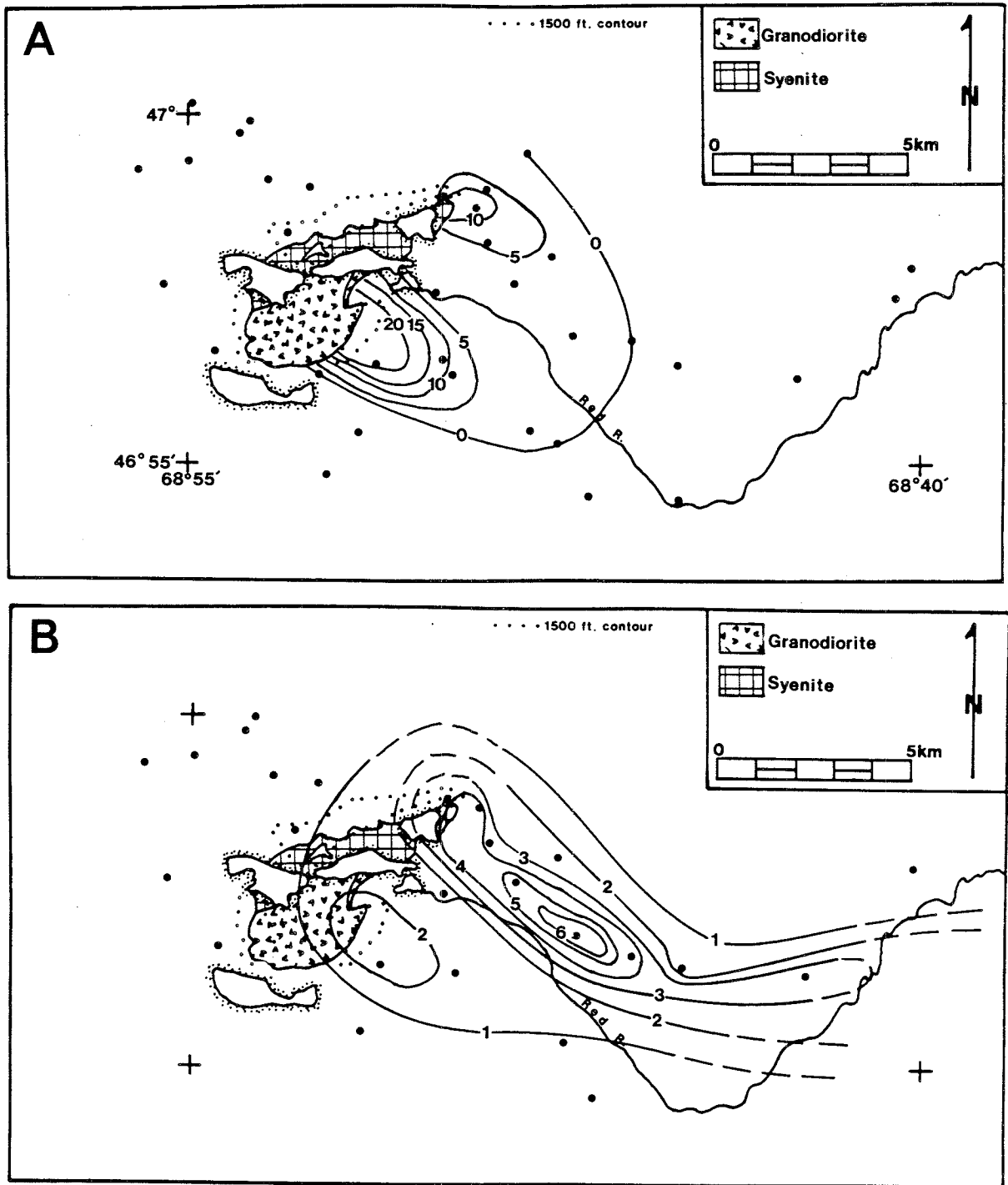

Figure 2. Dispersal patterns in till around the Deboullie granodiorite/syenite. A) Contour map of Deboullie erratic pebbles. Each data point represents a 100-stone count. Contour interval equals five percent. B) Contour map of weight percentages of heavy minerals in the 2.0 to 3.0 phi size fraction of till. Contour interval equals one percent. All samples northwest of the pluton showed less than 1.0 percent heavy minerals.

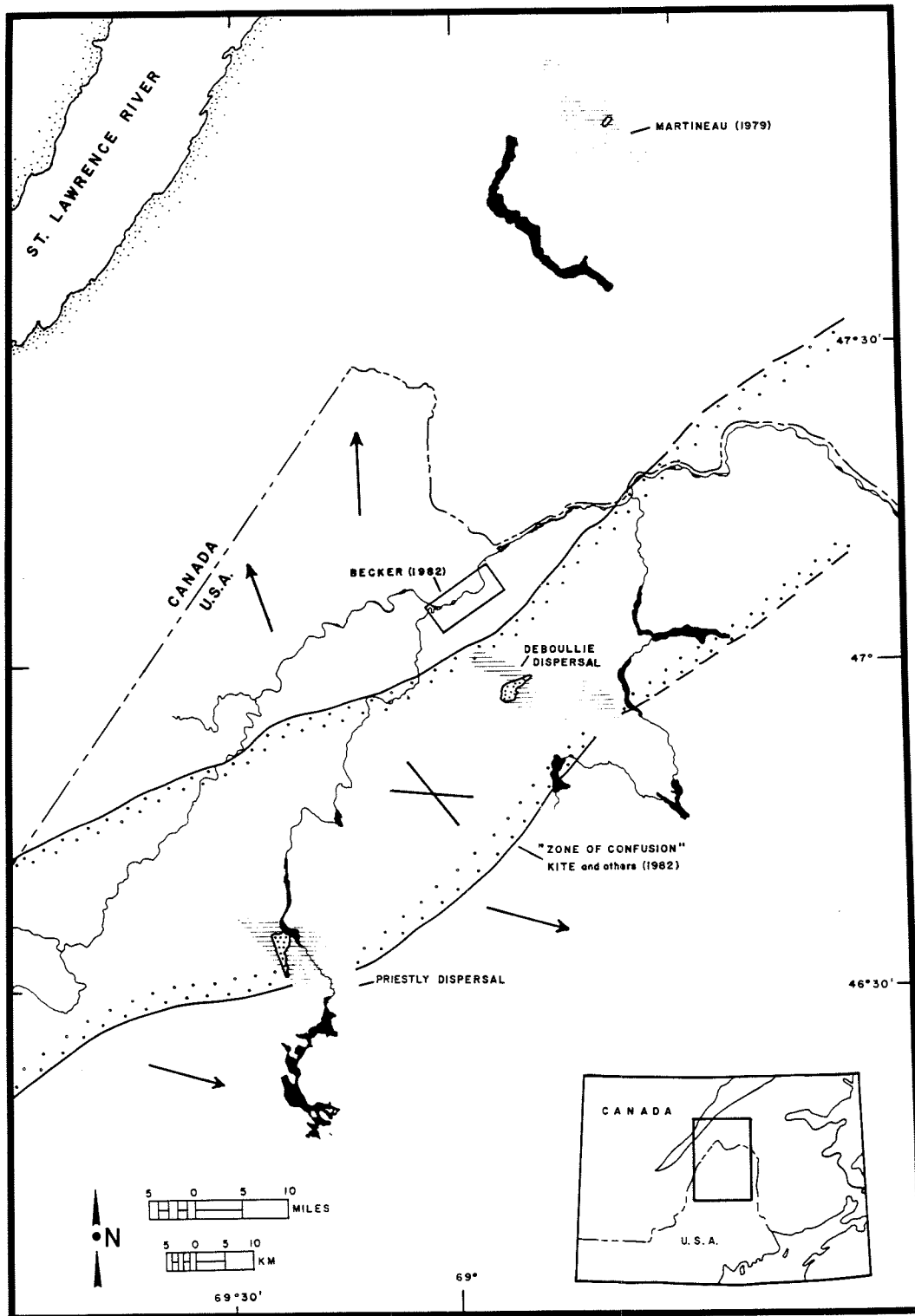

Figure 3. Map of the study area, showing dispersal patterns of this study and that of Martineau (1979) in the line pattern. Stippled boundaries represent striation boundaries of Kite and others (1982). Arrows indicate ice-flow directions indicated by striations; crossing lines represent striation trends (after Kite and others, 1982).

southern Quebec, 55 km north of the Deboullie area (Figure 3). His investigation of erratic dispersal from a point source of quartz diorite shows transport toward the southeast and the northwest; these are parallel to striation trends in the area. Martineau (1979) suggested a similar interpretation of the two-directional dispersal pattern in the Lac Temiscouata region to that suggested here for northern Maine.

Differences between the dispersal pattern of boulders and those of pebble and finer till components seem to indicate that different conditions of deposition caused these varied depositional configurations. At Priestly Lake, pebble counts as well as particle-size and heavy-mineral analyses show a small component of igneous material in till beyond the granodiorite pluton. However, a significant increase in the sand fraction and anomalously high percentages of heavy minerals were noted in tills to the southeast of the Deboullie pluton. Till compositional studies around the Priestly and Deboullie plutons reveal no apparent influence of incorporation of igneous material north or westward from the igneous bodies. In these directions, till compositions are indistinguishable from regional till compositions.

One explanation for the till differences is that boulders used in boulder counting and the till samples collected in this study originated from different surficial units. Some authors (Shilts, 1981; Chauvin and others, 1984) have attributed large erratic boulder concentrations to deposition as ablation till. Such an ablation mantle in the areas of Priestly Lake and Deboullie may be the source of the boulder-sized material counted around them. Igneous material would have to have been injected high into the ice mass as it moved over the plutons and deposited as an ablation mantle during deglaciation. This is supported by evidence from soil pits around the two plutons. In three cases at Priestly Lake and two at Deboullie, erratic boulders were found in the upper (A) horizon of soil pits and till exposures, whereas till analysis in the lowest exposed horizon (C_{ox}) did not show evidence of influence from the igneous bodies.

The weak influence of igneous material in till southeast of the Priestly Lake granodiorite may be due to the sparsity of good till exposure. The pluton lies in an area of numerous kame deposits and possible fluvial influence by the Allagash River; thus very few thick till exposures exist in the area. In addition, the majority of the exposure of the granodiorite is in low-lying areas at the margin of Priestly Lake itself. This topographic effect may have caused isolation of the majority of the pluton from glacial entrainment (see also Shilts, 1981).

CONCLUSIONS

Patterns of dispersal of igneous material from the two plutons in this study further support the model of late Wisconsinan ice-flow history suggested by Kite and others (1982) and Lowell (1985). Southeastward dispersal, based on its strength and extent, is interpreted to be the result of major Laurentide ice flow through northern Maine. This strong flow caused extensive dispersal of erratic material to the southeast of the Priestly and Deboullie plutons. Northwestward dispersal is considered to

be the result of a subsequent and weaker northwest ice flow from an ice divide which was centered, at some point in time, to the south of these two igneous bodies. Lowell (1985) states that during this phase of northward ice movement, local topography may have played a role in diverting ice flow. This seems to be supported by the northwest dispersal patterns from the two plutons.

The apparent lack of erratic material within till to the northwest of the Priestly and Deboullie plutons may tell something about the dynamics of the postulated ice mass. In both cases, boulder-size material is found in loose till at the surface, but no igneous material is found in the associated unweathered till at depth. Becker (1982) in his study of till stratigraphy along the St. John River (Figure 3) attributed the deposition of the uppermost 3 m-thick till unit to northwestward flowing ice on the basis of till fabrics and surficial geological studies. The work of LaSalle and others (1977a, 1977b) also suggests that deposition of significant amounts of glacial debris was accomplished by northwestward flowing ice in adjacent Quebec. The intensity of glacial striation and production of ice-molded (stoss and lee) forms that indicate northwestward flow seems to increase away from the area of the postulated ice divide (Lowell, 1985). This depositional and directional evidence could indicate either that the ice mass near the ice divide caused little erosion and shaping of bedrock, or that as ice approached the calving bay in the St. Lawrence River valley (LaSalle and others, 1977b), flow strengthened and erosive power increased.

ACKNOWLEDGMENTS

This work was made possible by a grant from the Maine Geological Survey as part of their ongoing surficial mapping program. The author wishes to thank Parker Calkin, Thomas Lowell, and Steven Kite for their instruction and encouragement.

REFERENCES

- Becker, D. A., 1982, Late Wisconsin stratigraphy, upper St. John River valley, northwestern Maine: M.A. thesis, State University of New York, Buffalo, 95 p.
- Boone, G. M., 1958, The geology of the Fish River Lake area, northern Maine: Ph.D. dissertation, Yale University, 186 p.
- Boudette, E. L., Hatch, N. L., and Harwood, D. S., 1976, Reconnaissance geology of the upper St. John and Allagash River basins, Maine: U.S. Geological Survey, Bulletin 1406, 37 p.
- Chalmers, R. C., 1889, Glaciation of eastern Canada: *Geology Magazine* (3rd Series), v. 6, p. 211-214.
- _____, 1890, The glaciation of the Cordillera and the Laurentide: *American Geologist*, v. 6, p. 324-325.
- _____, 1898, Surface geology of the St. Lawrence valley: *Geological Survey of Canada Annual Report 1907*, p. 69-71.
- Chauvin, L., David, P. P., and LaSalle, P., 1984, Debris production and glacial transport in the Gaspé Peninsula, Quebec (abs.): *Geological Society of America, Abstracts with Programs*, v. 16, no. 1, p. 8.
- Dreimanis, A., and Vagners, U. J., 1971, Bimodal distribution of rock and mineral fragments in basal tills, *in* Goldthwait, R. P., ed., *Till: A Symposium*: Ohio State University Press, p. 237-250.
- Flint, R. F., 1957, *Glacial and Pleistocene Geology*: John Wiley and Sons, New York, 553 p.
- Halter, E. F., Lowell, T. V., and Calkin, P. E., 1984, Glacial erratic dispersal from two plutons, northern Maine (abs.): *Geological Society of America, Abstracts with Programs*, v. 16, p. 48.
- Kite, J. S., 1983, Late Quaternary glacial lacustrine and alluvial geology of the upper St. John River basin, northwestern Maine and adjacent Canada: Ph.D. dissertation, University of Wisconsin, Madison, 339 p.
- Kite, J. S., Lowell, T. V., and Stuckenrath, R., 1981, Late Wisconsin residual ice cap: evidence from northwestern Maine (abs.): *Geological Society of America, Abstracts with Program*, v. 13, p. 488.
- Kite, J. S., Lowell, T. V., and Nicholas, G. P., 1982, Quaternary studies in the upper St. John River basin, Maine and New Brunswick, *in* Thibault, J., ed., *New Brunswick Quaternary Association field trip guide*, 55 p.
- LaSalle, P., Martineau, G., and Chauvin, L., 1977a, Morainic deposits and glacial striae in the Beauce-Notre Dame Mountains-Laurentide Park area: *Ministre des Richesses Naturelles du Quebec, DPV-151*, 22 p.

- LaSalle, P., Martineau, G., and Chauvin, L., 1977b, Stratigraphy and deglaciation in the Beauce-Notre Dame Mountains-Laurentide Park area: Ministre des Richesses Naturelles du Quebec, DPV-516, 74 p.
- Lowell, T. V., 1980, Late Wisconsin ice extent in Maine: Evidence from Mt. Desert Island and the St. John River area: M.S. thesis, University of Maine, Orono, 112 p.
- _____, 1985, Late Wisconsin ice flow reversal and deglaciation, northwestern Maine, in Borns, H. W., LaSalle, P., and Thompson, W. B., eds., Late Pleistocene history of northeastern New England and adjacent Canada: Geological Society of America, Special Paper 197, p. 71-83.
- Martineau, G., 1979, Geologie des depot meubles, de la region du Lac Temiscouata: Ministre des Richesses Naturelles, Quebec, DPV-618, 18 p.
- Newman, W. A., Genes, A. N., and Brewer, T., 1985, Pleistocene geology of northeastern Maine, in Borns, H. W., LaSalle, P., and Thompson, W. B., eds., Late Pleistocene history of northeastern New England and adjacent Canada: Geological Society of America, Special Paper 197, p. 59-69.
- Roy, D. C., 1980, Tectonics and sedimentation in northwestern Maine and adjacent New Brunswick, in Roy, D. C. and Naylor, R. S., eds., New England Intercollegiate Geological Conference Guidebook for Field Trips in Northeastern Maine and Neighboring New Brunswick, p. 1-21.
- Shilts, W. W., 1973, Glacial dispersal of rocks, minerals and trace elements in Wisconsinan till, southeastern Quebec, Canada, in Black, R. F., Goldthwait, R. P., and Willman, H. B., eds., The Wisconsinan Stage: Geological Society of America, Memoir 136, p. 189-219.
- _____, 1981, Surficial geology of the Lac Megantic area, Quebec: Geological Survey of Canada, Memoir 397, 102 p.

GLACIATION OF NORTHWESTERN MAINE

Thomas V. Lowell
Department of Geology
University of Cincinnati
Cincinnati, Ohio 45221-0013

and

J. Steven Kite
Department of Geology and Geography
West Virginia University
Morgantown, West Virginia 26506

INTRODUCTION

The glaciation history of northwestern Maine is different from that of the rest of New England. One difference is that northward ice flow occurred in this part of Maine during the last glaciation. Evidence of northward flow has also been noted in adjacent Quebec and New Brunswick. Chalmers (1898) was the first to suggest that a system of independent glaciers in the Appalachians caused the northward flow. This concept has undergone a long history of study and refinement since Chalmers' time (see review by Chauvin and others, 1985).

The numerous studies of glaciation in southeastern Canada contrast with the scarcity of work in northwestern Maine. Boudette and others (1976) presented the first data on glacial striations in northwestern Maine, but were not critical in their assignment of ice-flow direction. Prescott (1973) and Genes and others (1981) conducted mapping in areas east of our study area, and Caldwell (1975) conducted work to the south. The present work fills part of the void between southern New England, southern Quebec, and eastern New Brunswick.

The primary objectives of this paper are to provide a summary of studies we have conducted since 1979, and to present some ideas on the relationship of these studies to those in surrounding areas. We view northwestern Maine as part of a larger region; the models suggested here will not explain all available data, but rather propose a regional framework for glaciation. We admit that this approach presents a biased viewpoint, but we hope the models will lead to constructive discussion.

ICE-FLOW PATTERNS AND CHRONOLOGY

Our understanding of the last glaciation of northwestern Maine comes from reconnaissance mapping, with emphasis on collection of striation data.

Although striations and other associated features such as stoss-and-lee forms are generally only secondary lines of evidence in most glacial studies, they form the foundation of our work for three reasons. First, striations and associated features are abundant on bedrock outcrops throughout the study area: more than 2,500 striation sets over an area of >18,000 km² have been measured. "Set" here refers to a number of parallel or nearly parallel striations observed on a single outcrop. The variation of striation orientations within each set does not exceed 10°. Second, striations record ice-flow directions and relative chronology. Third, because the surficial geology of the region was unknown prior to this work, reconstruction of large-scale ice-flow patterns provides a foundation upon which detailed studies of stratigraphic and deglaciation history can be based.

At each outcrop, data collection consisted of measuring the trends of the striation sets, and, if more than one striation set was present, interpreting relative age relationships. About one-half (1,254) of the striation sets possess stoss-and-lee forms, rat-tail striations, or other features that enable determination of specific ice-flow direction. These outcrops are the basis for our analysis of the direction and chronology of ice flow. In the following sections, compass directions used to describe ice flow are the directions toward which the ice flowed. Most relative age determinations were made on outcrops where one striation set could be traced across a groove of another striation set; in a few places, the preservation of striations on lee faces provided the relative-age determination.

The large number and wide distribution of striated outcrops made simple plotting of the entire data set awkward and unmanageable. Therefore, data representation was simplified by considering all striated outcrops within a 5 x 5 km grid, and computing a simple vector mean and strength (Mardia, 1972) for that group. The vector mean represents the average orientation for all of the measurements, and the vector strength is a measure of dispersion. Arrow lengths on Figure 1 are proportional to the calculated vector strength. The short arrows near the north-central part of the study area reflect a large variation in orientation of striation sets within those grids. Because the vector means represent a statistical reduction of many measurements, the grid arrows on Figure 1 may plot in a direction unlike any single measurement recorded in the field. Although Figure 1 does not show the ice-flow history, the changes in vector orientation and dispersion help identify areas with similar ice-flow history.

Data from Figure 1 can be grouped into five zones (Figure 2), delineated on the basis of orientation and strength of the flow indicators. For example, Zones I and II are distinguished by indicator strength. Zone III is differentiated from Zones IV and V because Zone III shows only eastward indicators. The zones (I-V) reflect the distribution of the dominant average flow patterns in northwestern Maine, discussed below. Localized flow events have little impact on the distribution of these zones.

The dominant ice-flow direction in Zone I was toward the north (northeast part of the zone) and toward the northwest (southwest part). However, the ice-flow chronology varies in different areas of Zone I.

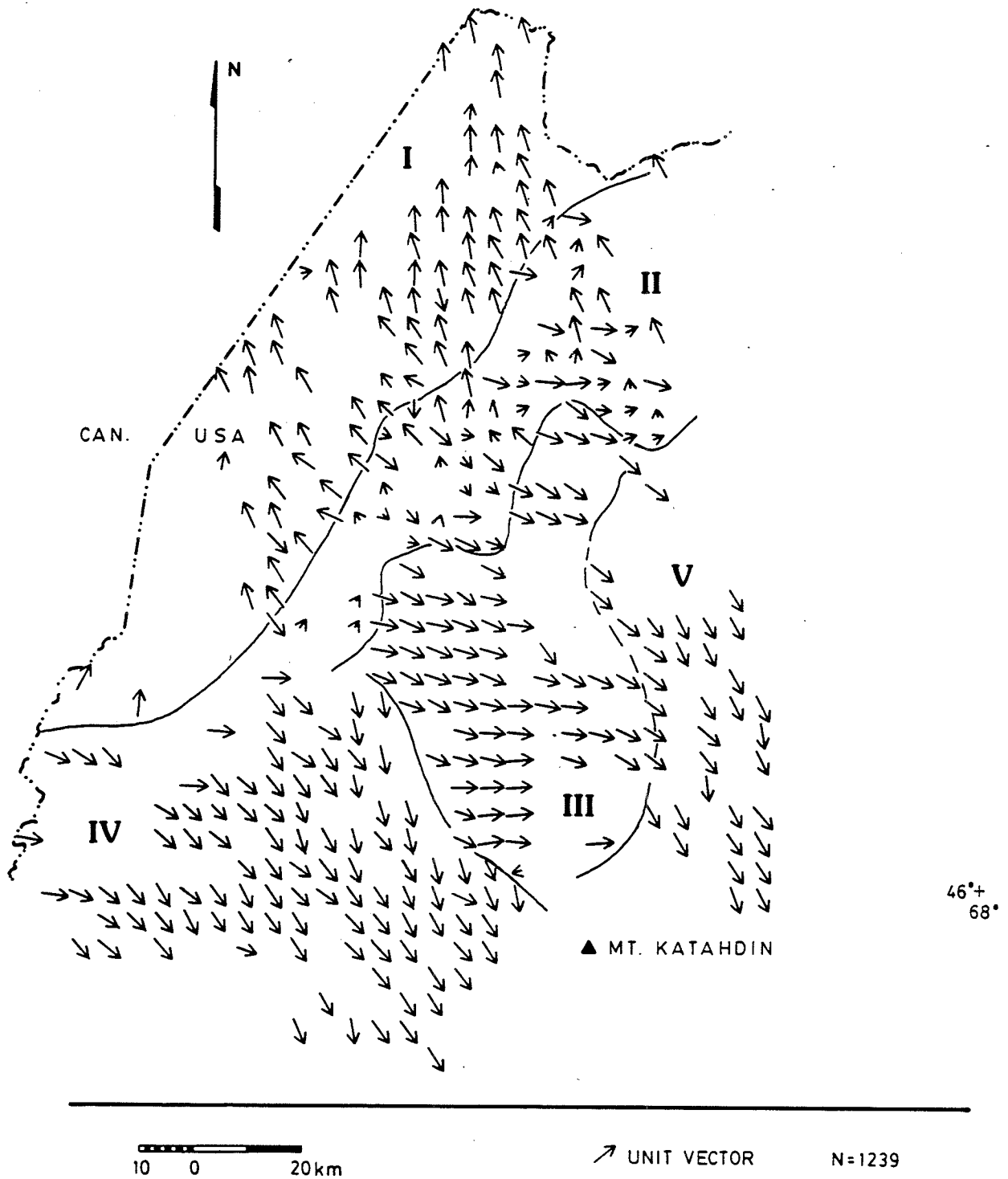

Figure 1. Vector means for all azimuth striations. Orientation of each arrow represents the means of all azimuth striations within a 5 x 5 km grid cell. The length of the arrow is scaled in ratio to the strength of the vector. Thin lines represent zone boundaries as shown on Figure 2. These vectors contain striation sets of all ages. Relative ages of ice-flow directions are shown in Figure 3.

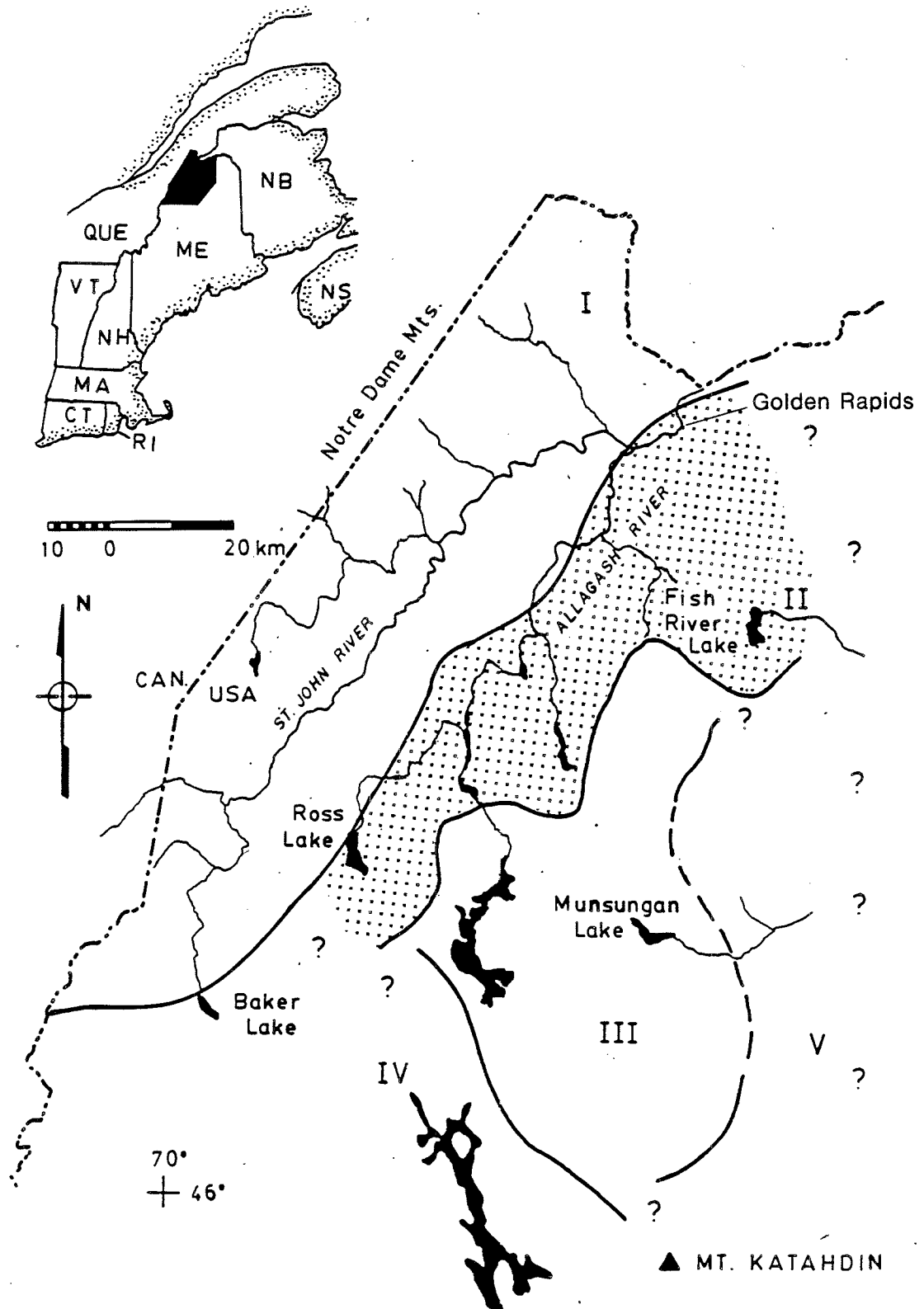

Figure 2. Map of striation zones based on the areal distribution of the flows in Figure 1. Each zone, I through V, represents an area with similar ice-flow histories. Zone II has a pattern overlay to clarify distribution of the zones.

In the northeast area, a northwest flow occurred before the dominant northern flow (Table 1). Furthermore, several outcrops in the southwest portion of the zone indicate that two episodes of northwest flow occurred: one before and one after a northward flow event. All of these north or northwestward flow events are younger than an east-southeastward flow event. The southern limit of Zone I marks the decrease in dominance of the northward flow.

Zone II (Figure 2) is the area with the most complex ice-flow history. A simplified composite sequence is (youngest to oldest): northwest, southeast, and east-southeast. Additionally, a few outcrops show a second northwest flow that is older than the east-southeast flow. This complex history led Kite and others (1982) to name this area "the zone of confusion". Zone II is the southeast limit of indicators of north or northwest glacial movements.

Zone III (Figure 2), in contrast, shows the simplest ice-flow history. Eight-five percent of the 348 striation sets in this zone fall within a 25 degree arc of 105 degrees. The strong uniform flow to the east-southeast parallels that recorded on other outcrops throughout the study area, and this regional event provides a marker with which to correlate the relative ice-flow chronologies in neighboring zones. The few striation sets that deviate more than 25 degrees from the east-southeast direction record a slight shift in ice-flow direction toward the southeast. However, their erosional impact is slight. Zone III is an area that has not undergone significant glacial erosion since the east-southeast event.

The dominant ice-flow direction in Zone IV was toward the southeast (Figure 1). The east-southeast flow remains the oldest event (Figure 3), but toward the southeast its strength becomes subordinate to younger southeast and southward flows. A second east-southeast flow constitutes the last glacial ice flow in Zone IV. The two east-southeast events are separated on the basis of age relationships and the strength of the erosional features; the younger one was faintly draped on surfaces with older striations whereas the older east-southeast flow imparted a strong stoss-and-lee molding onto the outcrops. Zone V (Figure 2) is similar to Zone IV except that Zone V lacks the younger east-southeast flow recorded in Zone IV.

The boundaries between these areas may be abrupt, as between Zones III and IV, or they may be gradual, as between Zones I and II. The position and nature of the junction between Zones I, II, III, and IV is unknown because it lies within an area of relatively thick drift deposits in poorly accessible terrain. The boundary between Zones I and IV extends west of Baker Lake (Figure 2) to include in Zone I several outcrops that show evidence of northward or northeastward ice movement. This appears to be a local event associated with the late east-southeastward movement recorded in Zone IV. Lowell and Kite (this volume) suggest a mechanical cause for this flow.

Figure 3 and Table 1 summarize the relative ice-flow history found in each zone. All of the striations studied display the same degree of freshness. We therefore believe that the relative sequence outlined in Table 1 occurred under a continuous ice cover.

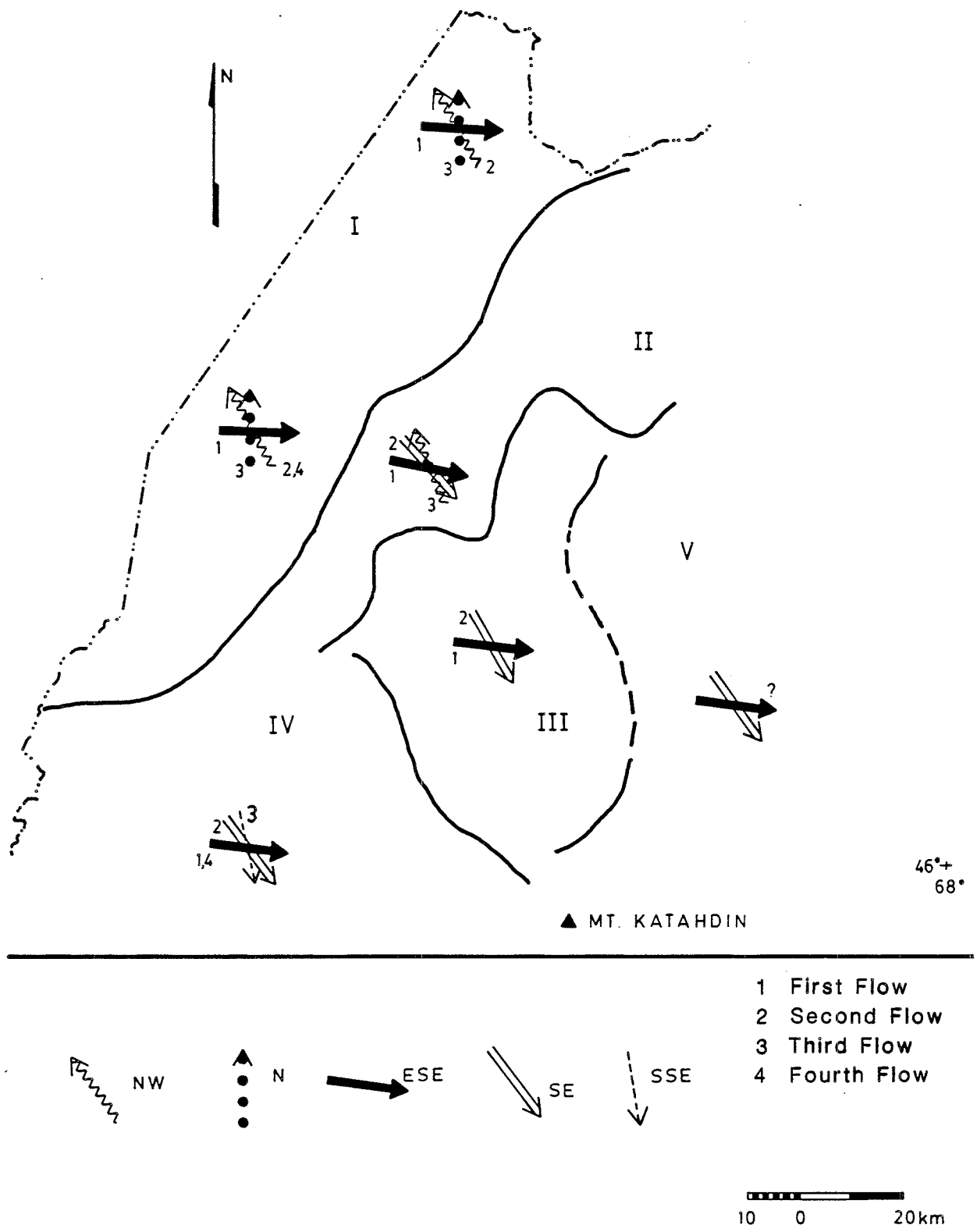

Figure 3. Summary of ice-flow history for Zones I-V, northwestern Maine. Patterned arrows represent the major flow directions. Numbers show the relative age chronology between the flow directions.

Table 1

<u>ZONE</u>	<u>I</u>		<u>II</u>	<u>III</u>	<u>IV</u>	<u>V</u>
	(NE	SW)				
Younger		NE			ESE	
	N	NW	NW	SE	S	SE
	NW	N		SE	SE	SE
	NW	NW	SE	SE	SE	SE
	ESE	ESE	ESE	ESE	ESE	ESE
Older			NW (?)			

DRIFT STRATIGRAPHY

Because of the reconnaissance nature of this study, and because most of the stratigraphic sections are located in the St. John River valley, which is only a small portion of the study area, the drift stratigraphy of northwestern Maine is not well known. Other workers have made preliminary studies of the stratigraphy in northernmost New England (Prescott, 1973; Genes and others, 1981; Becker, 1982; Newman and others, 1985; Lowell and others, 1986; Borns and Borns, this volume; Holland and Bragdon, this volume). However, little agreement exists on the nature and correlation of glacial lithostratigraphic units in the region.

In brief, the exposed stratigraphy, from bottom to top, at several sites in the St. John River valley consists of: stratified gravel or laminated silt; a gray, compact, silty-sandy diamicton; a brown, loose sandy-silty diamicton; and poorly sorted gravel. A thin sand layer (15 cm thick) locally separates the two diamictons. A more complete account can be found in Becker (1982); Lowell and Kite (1986); or Lowell and others (1986).

This stratigraphy represents a sequence of events that began with deposition of gravel in the St. John River valley from water draining northward out of tributary valleys. This water possibly came from a pre-late Wisconsinan deglacial event, or alternatively from meltwater or increased precipitation accompanying the growth of the last ice sheet. New exposures of collapse features at Golden Rapids (Figure 2) (Lowell and Kite, 1986, Stop 1-4) support the first hypothesis.

The second event in the sequence was deposition of basal till (gray compact, silty-sandy diamicton) below an eastward-flowing glacier. Sedimentation from the lower gray diamicton to the upper brown diamicton appears to have been continuous. Pebble fabric data in the upper brown unit at McLean Brook and Golden Rapids (Lowell and Kite, 1986, Stops 1-3, 1-4) suggest that the lower portion of the unit was deposited as a basal till below a northward-flowing ice mass. However, the upper part of the brown till may be related to deglaciation. Poorly sorted gravels overlie the brown till and form a large portion of the landform around McLean Brook. Alluvial processes locally reworked all of these sediments.

It should be emphasized that we suggest a continuous ice cover during the deposition of the gray and brown tills. Except for a sand unit of variable thickness, we have not seen any other sediment between the gray and brown diamictons in northwestern Maine. In contrast, Rampton and others (1984) and Rappol (this volume) report a limited number of exposures around Grand Falls, New Brunswick, showing a gravel unit between gray and brown tills. Clasts of gneiss and granite derived from the Canadian Shield occur in all of the exposed stratigraphic units. These clasts are rare (0.44 percent out of 36,361), but they are widespread (Figure 4).

DISCUSSION

Data on glaciation from northwestern Maine form an important link in the construction of glaciation models uniting New England and adjacent Canada. This is due primarily to the study area's central geographic location between the Gaspé Peninsula (David and Leblond, 1985), New Brunswick (Rampton and others, 1984), the lower St. Lawrence region (Chauvin and others, 1985), southeastern Quebec (Shilts, 1981), and the Maine coast (Smith, 1982, 1985). Given this large area, we feel that one way to develop a regional model of glaciation is through correlation of major ice-flow patterns. The two glacial flow events of primary interest are (1) the early east-southeastward flow and (2) the subsequent flow reversal which accompanied the southward shifts (Table 1). The deglaciation sequence is considered elsewhere (Lowell and Kite, this volume).

The early, east-southeastward flowing ice moved across the area in a manner that produced significant erosion. We find evidence of this event not only in all of northwestern Maine but also in central Maine (Thompson and Borns, 1985) and upstream in adjacent Quebec (Chauvin and others, 1985). The extent of this flow direction, which has a distribution similar to that of Canadian Shield erratics (Figure 4), indicates that the east-southeastward flow was regional in extent. Rampton and others (1984) report what could be evidence of the same event in northwestern New Brunswick.

Although at first glance an east-southeastward flow seems inconsistent with the concept of southeastward flow postulated for this portion of the Laurentide Ice Sheet, for example by Shilts (1981), let us consider a larger perspective from the Gaspé Peninsula to Lake Champlain (Figure 5). The east-southeast flow in northern Maine grades into southeast flow in Quebec (Shilts, 1981) and New Hampshire (Goldthwait, 1970; Drake, 1971). The southeast flow yields to a more southerly direction in Vermont (Stewart, 1961; Larsen, 1972), and ice moved due south through the Lake Champlain-Hudson Lowland (Connally and Sirkin, 1973). It is reasonable to suggest that this radial flow pattern (Figure 5) resulted from a simultaneous event that represented the full influx of Laurentide ice into areas south and southeast of the St. Lawrence River. Others have noted a similar pattern: Hughes and others (1985, Figure 3) for 16,000 yr B.P., and Occhietti (1982) for development of the Nouveau-Quebec Ice Cap. It is not clear how this pattern relates to the Gaspé region, where David and

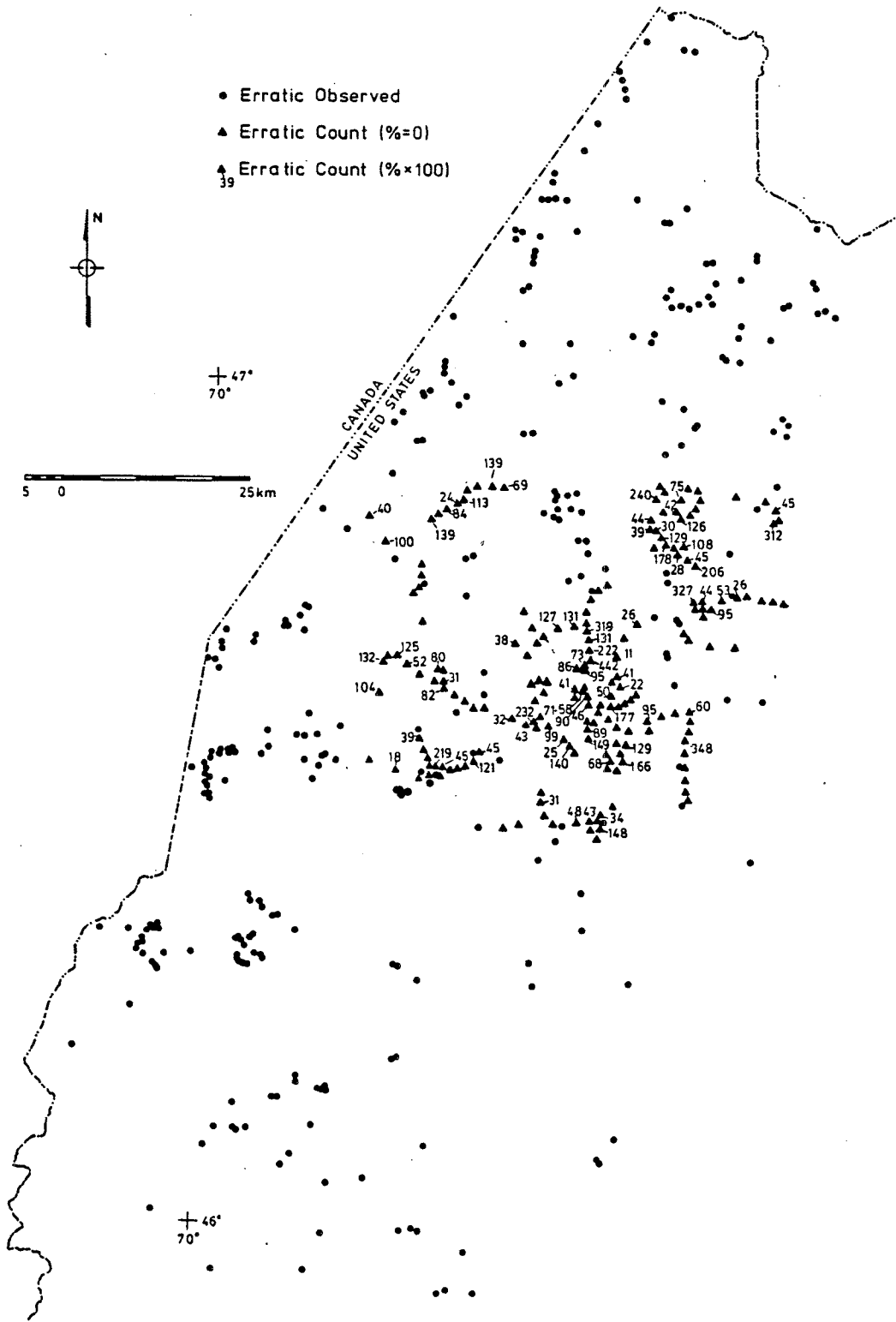

Figure 4. Occurrence of Canadian Shield erratics derived from north or west of the study area. Dots represent observations of the clasts; triangles represent locations where systematic counts of the clasts were made. The numbers accompanying the triangles indicate the percentage of Canadian Shield clasts times 100. (e.g. 26 equals 0.26 percent).

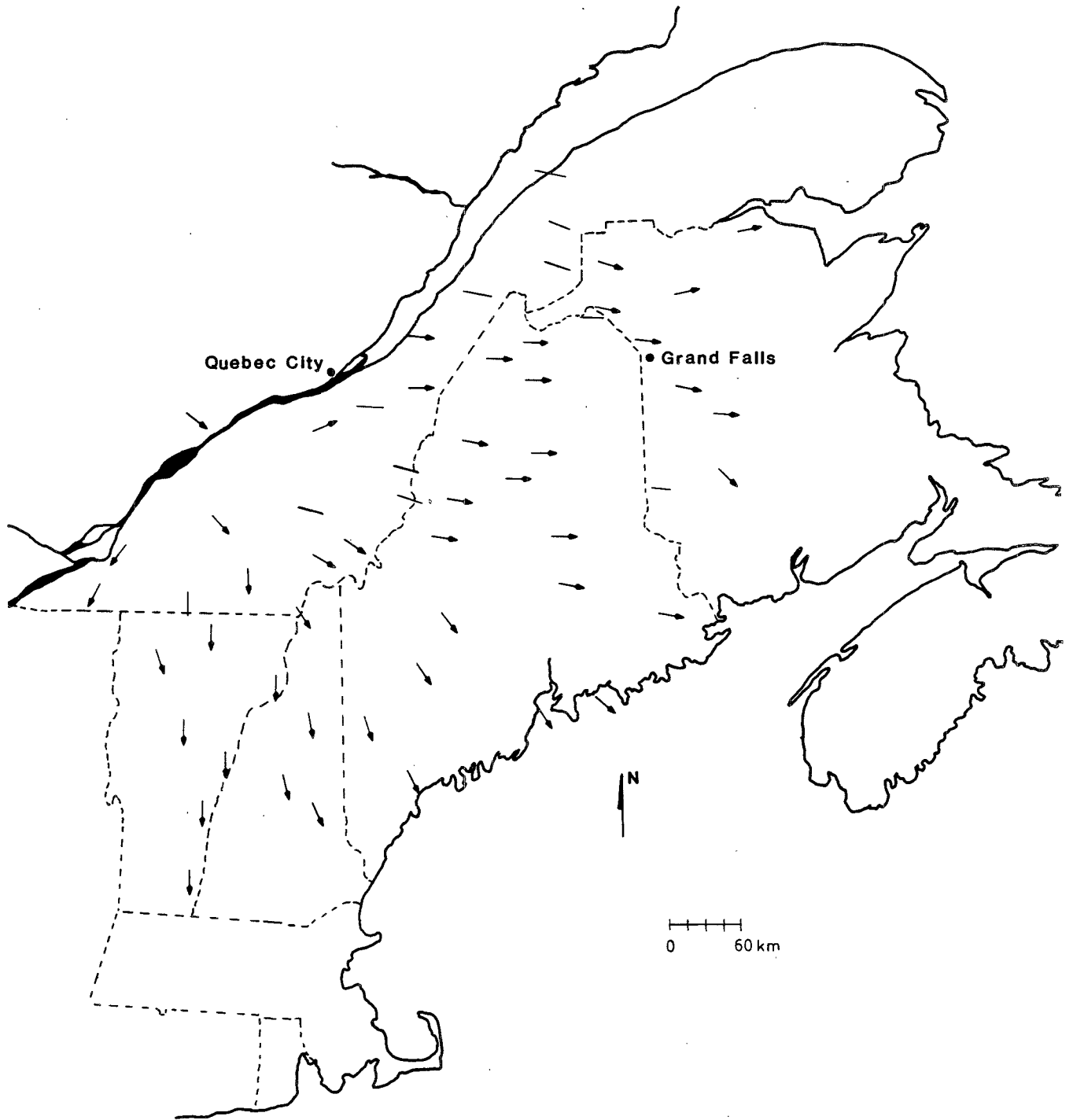

Figure 5. Map showing radial pattern of ice-flow indicators in northern Maine and adjacent areas. Lines without arrowhead represent stations where direction was not assigned by the original worker. Data compiled from the following sources: Thompson and Borns (1985); Locat (1978); Martineau (1979); Chauvin and others (1985); Gadd and others (1971); Gadd (1977, 1980); Stewart (1961); Larsen (1972); Drake (1971); Goldthwait (1970); Rampton and others (1984); Rappol (this volume).

Lebuis (1985) report that the main influx of Laurentide ice came from the northwest.

If radial glacial flow existed as shown in Figure 5, then we postulate that it formed during the early part of the late Wisconsin Stage. Rampton and others (1984) suggest a mid-Wisconsin or older age for the eastward flow based on "fluvial (glaciofluvial) sediments" between two till units. These tills in New Brunswick may correlate with the till sheets in northwestern Maine. Also, Rappol (this volume, Figure 2) reported 8 m of gravel between two tills near Grand Falls (Figure 5). Rappol suggests that the gravel may represent a regional deglaciation; he also indicates that the lower till, which has an east-west fabric, may be as young as late Wisconsin. Chauvin and others (1985) did not comment on the age of the eastward flow. However, Shilts (1981) demonstrated a late Wisconsin age for invasion of Laurentide ice into southeastern Quebec. Our work supports a late Wisconsin age because: (1) the erratic transport from the local plutons (Halter, this volume) indicates that the eastward flow was the major one across the area and that subsequent flows were weaker; (2) the ice-flow sequence agrees with a continuous stratigraphic record showing uninterrupted glaciation since the beginning of the eastward flow; and (3) no evidence has been observed of any weathering interval between erosional indicators of the eastward and subsequent ice flows.

Two inferences can be made from this late Wisconsin, radial ice-flow pattern. First, the convergence of flow indicators shows that the source of this ice was near Quebec City (Figure 5). Thus conditions in southern Quebec and adjacent areas controlled the growth and decay of this sector of the Laurentide Ice Sheet. Second, the radial flow pattern indicates that much of the glacial ice over New England and eastern New Brunswick had its initial source north of the St. Lawrence River, in contrast to Grant's (1977) suggestion of a local ice source.

Testing of the radial flow hypothesis should include at least: (1) determination of the absolute age of the till(s) which represents this flow in the drift stratigraphy of both northwestern Maine and northwestern New Brunswick; and (2) documentation of this flow in northeastern Maine in order to firmly establish a continuous flow line from Quebec into New Brunswick.

Subsequent to the east-southeastward flow, two ice-flow patterns developed in northwestern Maine: northward flow near the St. Lawrence River, and southeastward flow in north-central Maine. In order for the ice to have moved northward, the ice surface must have been higher over north-central Maine than over the St. Lawrence River valley. Such a configuration prevents any ice from north of the St. Lawrence River from reaching the Appalachian region.

If the surface of Appalachian ice was low over both the St. Lawrence River valley and its southern margin, it must have formed a dome over north-central Maine. This dome would have controlled ice flow patterns to the south; one impact was to change the east-southeastward flow to a southeastward flow. Over time the dome moved southeastward and thus forced the ice over most of Maine to move in a southerly direction (patterns shown in Leavitt and Perkins, 1935, and Thompson and Borns, 1985). The nature of

ice-flow indicators in Zones II and III (Figure 2) suggests a limited duration for the southeastward flow in these areas. Erratics displaced from the igneous plutons, which generally parallel the major ice-flow direction, lie to the east-southeast rather than to the southeast of the plutons (Halter, this volume). Also, the eastward flow indicators of Zone III received little erosional modification from either the southeastward or southward moving ice. Perhaps the Mt. Katahdin massif posed a topographic barrier, behind which an ablation zone developed. This could result in flow lines being directed upward, thereby minimizing erosion.

If the formation of southeast and southward flow was a response to the dome development, then these flows were not under the influence of Laurentide source ice. However, the southeastward flow may have left a strong impact on the landscape (i.e. lake basin orientation) because this direction lies perpendicular to bedrock structure and parallel to many bedrock faults and joint sets in Maine. Ice moving parallel to bedrock structure would have increased erosion capacity.

Near the St. Lawrence River, reversal of ice flow to a northward direction accompanied the development of the southward ice flows in central Maine. LaSalle and others (1977), Chauvin and others (1985), and David and Lebuis (1985) all indicated that the northward flow developed in a time-transgressive fashion. The flow reversal migrated up the St. Lawrence River valley (to the southwest) and southeastward away from the valley. In these models, the ice flow reversed at the same time, or just before, invasion of marine waters.

We agree that the ice flow pattern converged into the St. Lawrence River valley, but suggest that development of the flow pattern preceded the actual marine invasion by a long time. Five factors require this.

(1) Outcrops close to the St. Lawrence River valley display a stronger erosional imprint than those farther away; this requires either a stronger erosional force, or a longer time of erosion, or both.

(2) The flow reversal was not restricted to the immediate vicinity of the St. Lawrence River; it also occurred in areas up to 100 km away from the river.

(3) The distribution of erratics northwest of the plutons in Zone II is limited in amount and distance (Halter, this volume). Thus, the northward flow did not persist for long near its southern limits, but considerable time would have been required for the northward flow to migrate the 100 km from the St. Lawrence Valley to the northern Maine plutons.

(4) The areal distribution of northward flow in Maine requires that the ice at some point flowed over the Notre Dame Mountains from a lowland area. Recall that a complex northward flow sequence existed in Zone I (Table 1) south of the mountains. The northwest flow was associated with the initial stages of the flow reversal. The subsequent northward flow took place when the ice divide had migrated south of Zone I. This migration across a wide belt required an appreciable length of time.

(5) Because the southeastward flow in Zone II developed in response to the formation of the dome, it could not have begun there until after the dome formed. The southeastward flow required some time to establish itself and erode the bedrock before the ice divide migrated to the south of Zone II and the northward flow took over.

All of these factors lead us to suggest that flow reversal began well before incursion of the sea in the adjacent St. Lawrence Lowland.

One implication of this model is that drawdown acted for a considerable time between the late Wisconsin glacial maximum and the separation of the ice mass along the St. Lawrence River valley. David and LeBuis (1985, Figure 7) suggest that northward flow and flow convergence began north of the Gaspé at the maximum of the last glaciation. We see no reason why this convergence, or ice stream, could not have formed at that time and slowly worked upstream until separation of the ice sheet occurred. As the effects of the ice stream reached any particular point in the St. Lawrence Valley, all ice southeast of that point would have been cut off from the Laurentide Ice Sheet. In this view the ice stream was a long-term component of the ice sheet rather than a feature formed only at the end of glaciation. Testing of the prolonged drawdown model requires: (1) more striation studies in areas equivalent to Zone II that may occur in northeast Maine, New Brunswick, or Quebec in order to better document the ice-divide migration; and (2) more stratigraphic studies to document the thermal conditions of the ice mass. Mathematical modeling of the ice stream and ice-divide development may provide one way to estimate the duration of such effects.

A second implication of the model involves crustal rebound. If the ice volume began to decrease early in the deglaciation hemicycle, then adjustment of the crust also would have begun early. By the time of deglaciation, the crust may have already achieved a substantial amount of readjustment. Detailed investigations of crustal movements in areas between the St. Lawrence River and the Gulf of Maine may provide one test.

A third implication is that deglaciation would be controlled, on the large scale, by drawdown rather than climatic factors. Further discussion and testing of this concept can be found in Lowell and Kite (this volume).

A fourth implication of this model is that the extensive moraine system on the Maine coast developed under the influence of Appalachian rather than Laurentide source ice. The moraine deposition took place about 12-13,000 yr B.P. (Smith, 1982, 1985), at the same time that moraines formed in the St. Lawrence lowland (Chauvin and others, 1985). However, flow patterns south of the ice divide must have developed well before that time. To test if these moraines were deposited by Appalachian ice requires detailed provenance studies along the flow lines to document the origin and strength of ice flow.

The field data obtained in this work afford a better understanding of the ice-flow dynamics operating in the southeast sector of the Laurentide ice sheet during the last glaciation. Correlation of ice-flow patterns with Late Wisconsin climatic and sea-level changes are necessary, if possible, to appreciate the relative importance of mechanical versus climatic factors in controlling deglaciation of the study area.

REFERENCES CITED

- Becker, D. A., 1982, Late Wisconsin stratigraphy, upper St. John River, northwestern Maine: M.S. thesis, SUNY at Buffalo, Buffalo, 95 p.
- Boudette, E. L., Hatch, N. L., Jr., and Harwood, D. S., 1976, Reconnaissance geology of the upper St. John and Allagash River basins, Maine: U.S. Geological Survey, Bulletin 1406, 37 p.
- Caldwell, D. W., 1975, Surficial geology of the wildlands of the Greenville-Jackman areas, Maine: Maine Geological Survey, Open-File Report 75-6, 54 p.
- Chalmers, R., 1898, Report on the surface geology and auriferous deposits of southwestern Quebec: Geological Survey of Canada, Annual Report, Part J, v. 10, 160 p.
- Chauvin, L., Martineau, G., and LaSalle, P., 1985, Deglaciation of the lower St. Lawrence region, Quebec, in Borns, H. W., Jr., LaSalle, P., and Thompson, W. B., eds., Late Pleistocene history of northeastern New England and adjacent Quebec: Geological Society of America, Special Paper 197, p. 111-123.
- Connally, G., and Sirkin, L. A., 1973, Wisconsinan history of the Hudson-Champlain lobe, in Black, R. F., Goldthwait, R. P., and Willman, H. B., eds., The Wisconsinan Stage: Geological Society of America, Memoir 136, p. 47-106.
- David, P. P., and Lebus, J., 1985, Glacial maximum and deglaciation of western Gaspé, Quebec, Canada: in Borns, H. W., Jr., LaSalle, P., and Thompson, W. B., eds., Late Pleistocene history of northeastern New England and adjacent Quebec: Geological Society of America, Special Paper 197, p. 85-109.
- Drake, L. A., 1971, Evidence for ablation and basal till in east-central New Hampshire, in Goldthwait, R. P., ed., Till: a symposium: Ohio State University Press, p. 73-91.
- Gadd, N. R., 1977, Surficial geology of Saint-Sylvestre map-area, Quebec: Geological Survey of Canada, Paper 77-16, 9 p.
- _____, 1980, Ice flow patterns, Montreal-Ottawa lowland areas: Geological Survey of Canada, Paper 80-1A, p. 375-376.
- Gadd, N. R., McDonald, B. C., and Shilts, W. W., 1971, Deglaciation of southern Quebec: Geological Survey of Canada, Paper 71-47, 19 p.
- Genes, A. N., Newman, W. A., and Brewer, T., 1981, Late Wisconsin glaciation models of northern Maine and adjacent Canada: Quaternary Research, v. 16, p. 48-65.
- Goldthwait, R. P., 1970, Mountain glaciers of the Presidential Range, New Hampshire: Arctic and Alpine Research, v. 2, p. 85-102.

- Grant, D. R., 1977, Glacial style and ice limits, the Quaternary stratigraphic record, and changes of land and ocean level in the Atlantic Provinces, Canada: *Geographie Physique et Quaternaire*, v. 31, p. 247-260.
- Hughes, T. J., Hyland, M. R., Kite, J. S., Lowell, T. V., and Borns, H. W., Jr., 1985, Models of glacial reconstruction and deglaciation applied to Maritime Canada and New England, *in* Borns, H. W., Jr., LaSalle, P., and Thompson, W. B., eds., Late Pleistocene history of northeastern New England and adjacent Quebec: Geological Society of America, Special Paper 197, p. 139-150.
- Kite, J. S., Lowell, T. V., and Nicholas, G. P., 1982, Quaternary studies in the St. John River basin: Maine and New Brunswick, *in* Thibault, J., ed., Guidebook for the 1982 NBQUA field trip: 54 p.
- Larsen, F. P., 1972, Glacial history of central Vermont, *in* Doolan, B. L., and Stanley, R. S., eds., New England Intercollegiate Geological Conference Guidebook to Field Trips in Vermont, p. 296-316.
- LaSalle, P., Martineau, G., and Chauvin, L., 1977, Morphology, stratigraphy and deglaciation in Beauce--Notre-Dame Mountains--Laurentide Park area: *Ministere des Richesses Naturelles du Quebec*, DPV-516, 74 p.
- Leavitt, H. W., and Perkins, E. H., 1935, A survey of road materials and glacial geology of Maine: Vol. II: Orono, Maine, Maine Technology Experiment Station Bulletin 30, 232 p.
- Locat, J., 1978, Le quaternaire de la region de Baie-des-Sables--Trois-Pistoles: *Ministere des Richesses Naturelles du Quebec*, DPV-605, 64 p.
- Lowell, T. V., and Kite, J. S., 1986, Ice flow and deglaciation: northwestern Maine: *Friends of the Pleistocene Guidebook*, Maine Geological Survey, Open-File Report 86-18, 36 p.
- Lowell, T. V., Becker, D. A., and Calkin, P. E., 1986, Quaternary stratigraphy in northwestern Maine: a progress report: *Geographie Physique et Quaternaire*, v.40, no. 1, p. 71-84.
- Martineau, G., 1979, Geologie des depots meubles de la region du Lac Temiscouata: *Ministere des Richesses Naturelles du Quebec*, DPV-618, 18 p.
- Mardia, K. V., 1972, *Statistics of Directional Data*: Academic Press, London, 357 p.
- Newman, W. A., Genes, A. N., and Brewer, T., 1985, Pleistocene geology of northeastern Maine, *in* Borns, H. W., Jr., LaSalle, P., and Thompson, W. B., eds., Late Pleistocene history of northeastern New England and adjacent Quebec: Geological Society of America, Special Paper 197, p. 59-70.

- Occhietti, S., 1982, Synthèse lithostratigraphique et paléoenvironnements du Quaternaire au Québec méridional. Hypothèse d'un centre d'englacement Wisconsin au Nouveau-Québec: *Geographie Physique et Quaternaire*, v. 37, p. 15-49.
- Prescott, G. C., Jr., 1973, Groundwater favorability and surficial geology of the lower St. John River valley, Maine: U.S. Geological Survey, Hydrologic Atlas HA-485.
- Rampton, V. N., Gauthier, R. C., Thibault, J., and Seaman, A. A., 1984, Quaternary geology of New Brunswick: Geological Survey of Canada, Memoir 416, 77 p.
- Shilts, W. W., 1981, Surficial geology of the Lac Megantic area, Quebec: Geological Survey of Canada, Memoir 397, 102 p.
- Smith, G. W., 1982, End moraines and the pattern of last ice retreat from central and south coastal Maine, in Larson, G. J., and Stone, B. D., eds., Late Wisconsin Glaciation of New England: Kendall/Hunt Pub. Co., p. 195-210.
- Smith, G. W., 1985, Chronology of Late Wisconsinan deglaciation of coastal Maine, in Borns, H. W., Jr., LaSalle, P., and Thompson, W. B., eds., Late Pleistocene history of northeastern New England and adjacent Quebec: Geological Society of America, Special Paper 197, p. 29-44.
- Stewart, D. P., 1961, The glacial geology of Vermont: Montpelier, Vermont Development Department Bulletin 19, 124 p.
- Thompson, W. B., and Borns, H. W., Jr., eds., 1985, Surficial Geologic Map of Maine: Maine Geological Survey, 1:500,000 map.

AN UNUSUAL GLACIAL STRATIGRAPHY EXPOSED IN THE AROOSTOOK RIVER VALLEY, NORTHERN MAINE

Harold W. Borns, Jr.
Department of Geological Sciences and
Institute for Quaternary Studies
University of Maine
Orono, Maine 04469

and

Margaret Parker Borns
Orrington, Maine 04474

ABSTRACT

Numerous and extensive exposures in borrow pits in the Aroostook River Valley, distributed from Masardis to Presque Isle in northern Maine, display stratigraphic sections of unweathered ice-contact (?) sand and gravel overlain unconformably by lodgement till which was deposited by ice flowing from approximately N66°W. The borrow pits are distributed within an area of approximately 300 km².

Both the sand and gravel and the till in each pit contain pink granite gneiss clasts derived from the Precambrian Grenville Province of Canada. The available evidence from this area, in conjunction with generally similar sequences reported from elsewhere in northern Maine, suggest that the stratigraphic sequence records the advance of the late Wisconsinan ice sheet across the St. Lawrence Lowland into northern Maine and probably southeastward onto the continental shelf.

It should be noted that this type of stratigraphic sequence, lodgement till overlying sand and gravel, so common in northern Maine, has not been reported from elsewhere in Maine except for one or two isolated localities. The reason for this difference in style of glacial deposits will need to be addressed in the future as the glacial geology and history of Maine is elucidated.

INTRODUCTION

Occurrences of the surface till overlying considerable thicknesses of sand and gravel have been reported from northern Maine (Kite, 1979; Genes and others, 1981). However, the regional distribution and significance of these and other potential occurrences remains an open question.

This paper describes several new stratigraphic sections which were discovered within the Aroostook River Valley of northern Maine from Masardis down river to Presque Isle (Figure 1). These sections, examined during July 1985, appear to be erosional remnants of a more extensive valley fill that existed in early postglacial time, prior to degradation of the Aroostook River.

LOCATIONS OF SECTIONS

In an area about 2.3 km north of Masardis, borrow pits exposing till overlying sand and gravel are clustered in the vicinity of the south end of the International Paper sawmill property and just south of Garfield Road, all on the east side of the river valley. In the Ashland area the pits are located on the west side of Route 11, 1 km north of Ashland. In the Presque Isle area the pits are located on the west side of Parsons Road, approximately 7.1 km northwest of Presque Isle on the Washburn-Presque Isle town line, and on the east side of Parsons Road, approximately 8.2 km northwest of Presque Isle (Figure 1).

SAND AND GRAVEL

The stratified deposits below the basal till predominantly consist of coarse gravels, composed of pebble and cobble-size clasts with scattered boulders up to 2.0 m in diameter. The gravel in each pit generally is poorly sorted and locally contains a high percentage of silt and sand in the matrix.

In general, the larger clasts display well-developed faceting and edge rounding, but rarely are striated. These characteristics indicate that the clasts had been transported earlier in the basal portion of a wet-based glacier. The clasts consist of a wide variety of lithologies, most of which are recognized in the regional bedrock types. All the gravels examined contain erratic clasts of pink granite gneiss, generally thought to be derived from the Precambrian Grenville Province rocks exposed along the north side of the St. Lawrence Lowland. However, these far-traveled rock fragments represent much less than 1% of the total clasts present.

Stratification is usually well developed and is typically discontinuous in nature, with rapid changes in grain-size distribution, both horizontally and vertically. In each pit examined, the sand and gravel deposits show vertical-collapse structures, perhaps caused by melting of buried glacial ice, and horizontal shearing probably related to the overriding of glacial ice which deposited the overlying basal till. It is not clear whether the vertical deformation in the gravel predates or postdates the deposition of the overlying till. The sand and gravel display no visible sign of soil development or significant weathering with the exception of a slight orange-brown oxidation staining, and scattered clasts of rotten granite.

Other than the shear-deformation attributed to overriding ice, the vertical or near-vertical deformation features are most probably due to

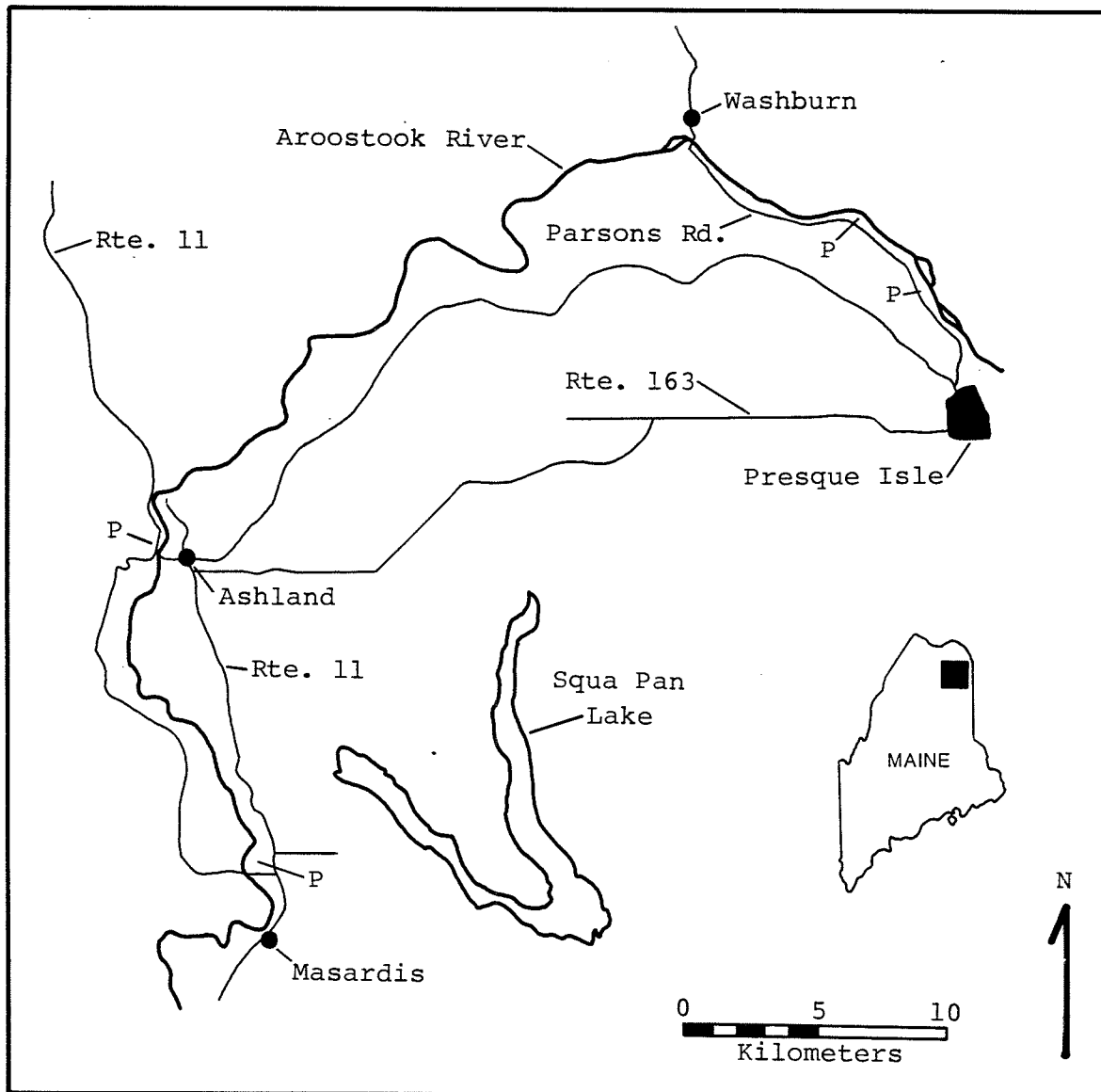

Figure 1. Index map of the field area in northern Maine. The letter "P" indicates the locations of borrow pits described in text.

collapse by melting of underlying ice masses. This factor, coupled with the general sedimentary characteristics, suggests that these deposits as a whole most probably consist of ice-contact stratified drift. However, the depositional environment of the sand and gravel is not clear and requires additional examination.

TILL

In all of the exposures examined, till disconformably overlies the sand and gravel and forms the surface deposit. The till, which is up to 5 m thick, generally contains a high percentage of silt and clay in its matrix. The clasts are predominantly of pebble-to-cobble size with a few boulders up to 1 m in diameter. Overall the till is compact, fissile, and light gray in color. In all exposures the till contains abundant striated and faceted clasts, and glacially streamlined "bullet clasts".

The lithologies of the clasts, like those in the underlying gravel, are highly variable, and for the most part could have been locally derived. However, exotic Precambrian clasts of pink granite gneiss like those present in the underlying gravels occur in the till in volumes of less than 1%. The strongly oriented fabric, including both the azimuths and dips of the long axes of the clasts and the orientation of the "bullet clasts", indicate ice flow from approximately N66°W.

Visible weathering of the till is restricted to the soil development of the upper 1 m. The interface between the till and underlying sand and gravel is in all cases erosional, and in places blocks of the sand and gravel have been sheared up into the till. The fabric, compactness, fissility, shear-structures, and sedimentary characteristics indicate that the till is a basal facies and was emplaced by lodgement.

DISCUSSION

Stratigraphic exposures scattered throughout a 300 km² area of the Aroostook River Valley of northern Maine display deformed sand and gravel at least up to 10 m thick, overlain disconformably by lodgement till up to 5 m thick which comprises the surface till of the area. The characteristics of the sand and gravel and the till allow the following different hypotheses related to their historical significance, listed in descending order of preference:

1. Both the sand and gravel and the till are of late Wisconsinan age. The sand and gravel unit, an ice-contact and outwash sequence, was deposited in a proglacial position and overrun by the late Wisconsinan ice, advancing from the northwest from north of the St. Lawrence River. In this scenario, the sand and gravel and the overlying lodgement till can be considered to be essentially contemporaneous.

2. The sand and gravel unit was deposited during a glacial retreat, perhaps during pre-late Wisconsinan time, and subsequently was overrun by the late Wisconsinan glacial advance. In this case, the difference in age between the sand and gravel and the overlying till may be considerable.

3. The stratigraphic sequence represents a minor, but regional, oscillation of the ice margin during either the general advance or the general recession of the late Wisconsinan ice margin.

4. The entire sequence represents any of the above scenarios, but was emplaced during pre-late Wisconsinan time.

Future research should be designed to locate similar stratigraphic exposures elsewhere in northern Maine. A detailed examination of the characteristics of the sand and gravel unit is necessary to determine its mode of deposition, and to document the nature of the contact between the sand and gravel and the overlying till in order to evaluate the amount of elapsed time between the deposition of these two units. In addition, a search should be made to locate the base of the sand and gravel and to determine the pre-sand and gravel unit events.

ACKNOWLEDGMENT

The field work for this project was supported by a grant from the Maine Geological Survey.

REFERENCES

Genes, A. N., Newman, W. A., and Brewer, T., 1981, Late Wisconsinan glaciation models of northern Maine and adjacent Canada: Quaternary Research, v. 16, p. 48-65.

Kite, J. S., 1979, Postglacial geologic history of the middle St. John River valley: M.S. thesis, University of Maine, Orono, 136 p.

DEGLACIATION OF NORTHWESTERN MAINE

Thomas V. Lowell
Department of Geological Sciences
State University of New York at Buffalo
Buffalo, New York 14226

and

J. Steven Kite
Department of Geology and Geography
West Virginia University
Morgantown, West Virginia 26506

INTRODUCTION

Compared to southern New England, where deglaciation studies have been conducted for over a century, very little is known about the deglaciation of northwestern Maine (Figure 1). Given this contrast, only the broad aspects of deglaciation of northwestern Maine are discussed. Our observations are outlined and placed in a regional framework with related studies to provide the basis for a deglaciation model. This model requires rigorous testing.

Southern Maine displays some of the most striking deglaciation landforms in this portion of North America. The extensive end moraines and their relationship to glaciomarine sediments document the active recession of an ice margin in contact with the transgressing sea (Smith, 1982; Thompson and Borns, 1985). The numerous emerged ice-contact deltas (Crossen, 1984; Thompson and others, in press), the extensive esker systems (Stone, 1899), and the widespread blanket of marine clay indicate that considerable sedimentation accompanied deglaciation of that area. Radiocarbon dates on marine shells and seaweed document that the ice margin retreated past the present coastline about 13,300 yr B.P., and that the accompanying marine waters fell below modern sea level by 11,000 yr B.P. (Smith, 1985).

The deglaciation landforms in the interior of Maine (inland from the marine limit) are less extensive. Esker systems dominate this landscape and extend into the central uplands. Although Stone (1899) first reported this distribution, few studies (except Shreve, 1985) have considered the significance of the systems. One inland area where the style of deglaciation has been studied is the Boundary Mountains of west-central Maine, where Borns and Calkin (1977) reported deglaciation from thinning, separation, and downwasting of the ice. The cirques in this area were not reactivated after the emergence of the mountains, which indicates that the snowline stood above the cirque basins. The few radiometric dates from

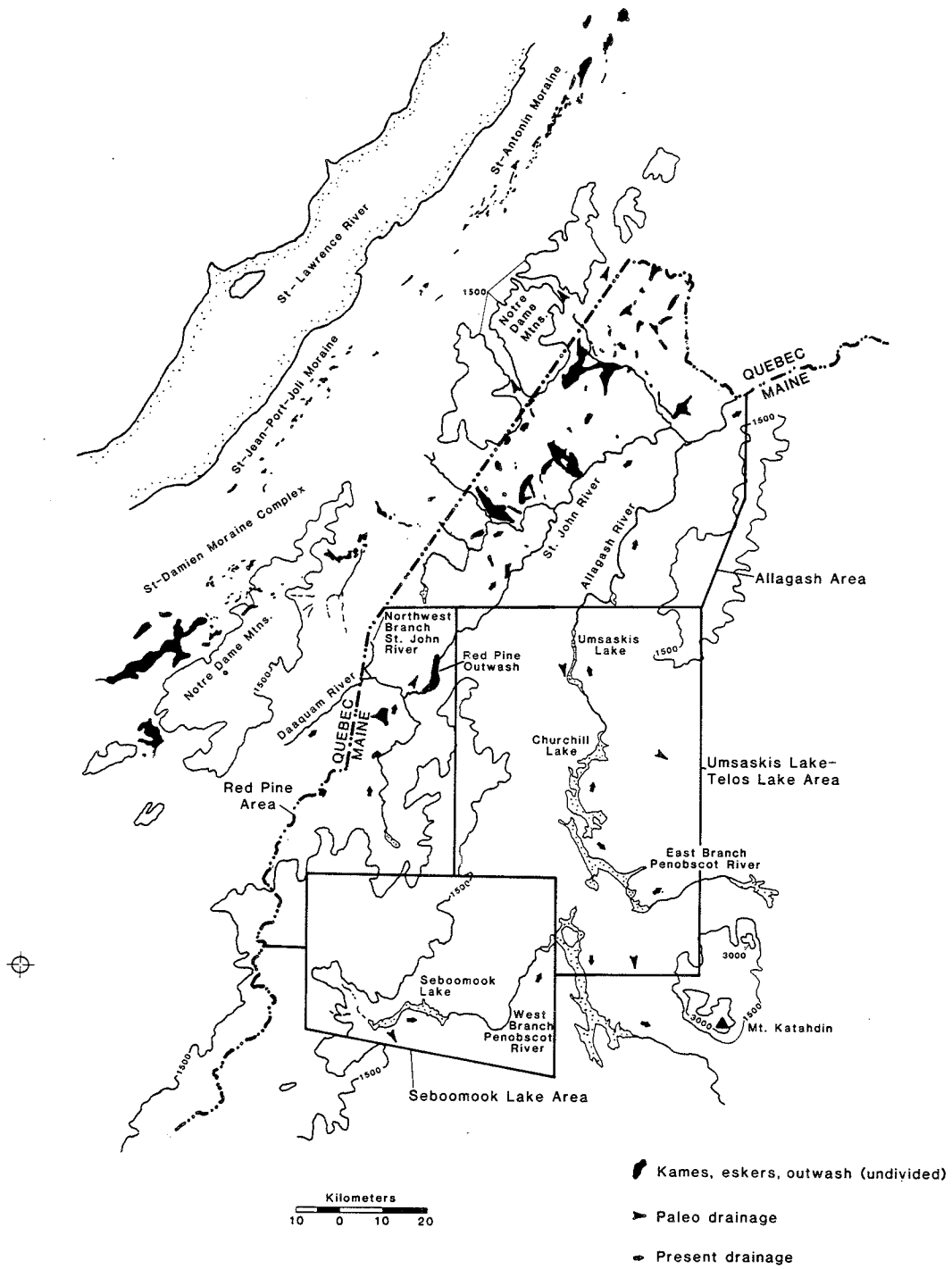

Figure 1. Location map of northwestern Maine and adjacent Canada.

this area suggest it was deglaciated between 12,500 and 11,000 B.P. (Mott, 1977; Davis and Jacobson, 1985). In an adjacent area of southeastern Quebec, Gadd (1983) suggested that ice recession was characterized by irregular, isolated ice masses that downwasted in place. However, alternative deglaciation sequences have also been proposed (Parent, 1984).

The St. Lawrence Lowland contains extensive marine clay deposits which indicate that a marine invasion accompanied deglaciation (Chauvin and others, 1985). However, the moraine and esker systems on the south side of the lowland are less extensive and more poorly developed than those in coastal Maine. Chauvin and others (1985) reported that the terrestrial deglaciation deposits formed as an ice mass broke up over the Notre Dame Mountains. Martineau and Corbeil (1983) noted one indication of active ice recession when they reported striations indicative of northward-flowing ice, and erratics of Appalachian source in ice-marginal deposits north of the St. Antonin Moraine system. The latter deposits were formed after marine waters had separated ice south of the St. Lawrence River from ice to the north of it. Dates from shells in marine sediments indicate that the marine invasion started in the St. Lawrence Lowland about 13,500 to 12,400 yr B.P. (Lee, 1963; Gadd and others, 1972; Lebus and David, 1977). However, the deglaciation sequence in the St. Lawrence Lowland is much more complex than outlined above; a starting point for further details might be Chauvin and others (1985) or LaSalle (this volume).

Rampton and others (1984) and Rampton (this volume) report several ice-marginal positions as the last glacier actively retreated north and west from the coastline of New Brunswick. They suggest that continued ice flow was associated with each of the recessional ice-margin positions (see Figure 1-4, Rampton, this volume), implying active ice during all stages of deglaciation.

Let us return briefly, to the timing of deglaciation for northwestern Maine. The nearly simultaneous timing of the marine invasions in both the Gulf of Maine and the St. Lawrence Lowland means that any ice mass over the region was physically separated from Laurentide ice by 12,400 yr B.P. (Lee, 1963; Smith, 1985). On the other hand, the timing of complete deglaciation in the region is less well known. Davis and Jacobson (1985) suggest virtually ice-free conditions by 10,000 yr B.P. Also, ice flow patterns throughout the region (LaSalle and others, 1977a, 1977b; Chauvin and others, 1985; Rappol, this volume; Lowell and Kite, this volume) produced deglaciation deposits along a southeastward retreating ice margin. Thus any deglaciation model must consider an isolated ice mass acting for a brief time between 12,400 and 10,000 yr B.P.

WHAT MIGHT WE FIND?

It seems to us that three possibilities for deglaciation style and the resulting surficial geology are likely. The first possibility is that the ice mass in northern Maine remained internally active and retreated in a somewhat concentric fashion as proposed for New Brunswick (Rampton and others, 1984). If this was the case, we might expect to find some evidence of the following: (a) ice marginal deposits such as moraines, extending

for considerable distances and most likely in a nested configuration; (b) ice-dammed lakes that formed between local topographic barriers and the ice margin; and (c) local changes in ice-flow directions as the glacier retreated.

The second possibility is that the marine embayments, acting on two sides of the Appalachian glacier, could have removed so much of the ice volume that after the calving and downdraw stopped, the remaining ice mass could not maintain internal flow (see Denton and Hughes (1981) for discussion of this process). Because flow could not be maintained, any remnant ice would simply thin, separate, and stagnate over a wide area. In this case we might expect to find: (a) widespread stagnation deposits like eskers, hummocky moraine, and scattered kames; (b) widely dispersed and irregular lakes formed against a discontinuous ice margin; (c) limited glaciofluvial deposits because only material previously incorporated in the ice could be deposited; and (d) regional ice-flow patterns which resulted only from flow associated with the marine embayments.

The remaining possibility is intermediate between the first two. The receding ice might first form a series of features along a more or less continuous margin. Later, stagnation would follow as the ice mass broke into isolated ice blocks and downwasted in place. In this case we might expect to see ice marginal deposits in a ring around stagnation deposits. We may, or may not, see indications of ice flow in areas dominated by stagnation deposits.

For all three of the above cases, we view the initial ice mass as extending from the marine limit in Maine to the marine limit in the St. Lawrence Lowland, a zone some 230 km wide. This is a fairly large area that would have had as its western side the Boundary Mountains, and its eastern side would have been some as-yet uncorrelated ice margins in New Brunswick.

WHAT DID WE FIND?

During our study we mapped in three primary field areas: the Allagash, the Umsaskis Lake-Telos Lake, and the Seboomook Lake. The Red Pine area received less attention because of its poor accessibility (Figure 1). The principal findings from each area are outlined below.

The Allagash Area

This, the northernmost area (Figure 1), contains the most evidence for ice-marginal positions and proglacial lakes. The deglaciation landforms largely consist of belts of hummocky ground moraine and a few small (< 10 m high) moraine ridges that trend northeast-southwest. These ice marginal features occur as a discontinuous belt on the interfluvies between northwest tributaries of the St. John River (Figure 1). The trend and characteristics of these deposits indicate that they may be a continuation of the St. Damien Morainic Complex (Chauvin and others, 1985) (Figure 1). These landforms represent a stillstand of disintegrating ice rather than a readvance of active ice.

In the Little Black River valley, a northwest tributary of the St. John River (Figure 1), meltwater channels, kame terraces, and extensive fine-grained deposits show a sequence of falling lake levels (Lowell, 1985). The highest ice-dammed lake drained northwest through the Notre Dame Mountains into the St. Lawrence Lowland. Subsequently, water from lower ice-dammed lakes drained, in several routes, northeast across the southern flank of the Notre Dame Mountains. Fluvial drainage of the St. John River became established in its present northeast course after erosion of several ice and drift dams. Additionally, channels show that ponded meltwater in the Big Black River and Shields Branch valleys first drained northwest through a low portion of the Notre Dame Mountains. However, none of the tributaries southeast of the St. John River contain deposits indicative of major ice damming during the last deglaciation.

In summary, the Allagash area has ice-marginal deposits and evidence of ice-dammed lakes trapped between a southeastward retreating ice margin and the Notre Dame Mountains. The apparent continuation of this ice position into southern Quebec strengthens the interpretation that the features formed along a continuous ice margin. However, areas southeast of the St. John River show no evidence for a continuous ice margin with ice to the southeast.

The Umsaskis Lake - Telos Lake Area

This area encompasses the headwaters of the north-flowing Allagash River and the south-flowing Penobscot River (Figure 1). The divide between these systems has been displaced to the north by man-made dam and channel construction; glaciofluvial landforms show that the distribution of late-glacial remnant ice resulted in a drainage divide located even farther north. Several lateral meltwater channels east of Umsaskis Lake (Figure 1), kame deposits below these channels, a delta on the west side of Umsaskis Lake, and several other related features formed at a time when the base-level control for meltwater stood at 305 m.a.s.l. Channel geometry and sedimentary structures within the kames and the delta indicate that meltwater flowed to the south during the formation of these features. However, any subsequent lower lake levels would have drained to the north because of the topography.

Likewise, several channels and deltas between Churchill Lake and Telos Lake (Figure 1) also indicate southward-draining meltwater at elevations above the present lake levels. Several outwash trains on the valley floors on the northwest side of Churchill Lake indicate free meltwater drainage to the south. However, aside from the lateral channels and kame deposits, no ice marginal features have been found. The observed features represent very limited deposition of sediments. Most sand and gravel deposits are less than 5 m thick; deposits more than 2 m thick are quickly exploited for road material because that resource is so scarce in this area.

In summary, the Umsaskis Lake-Telos Lake area shows no continuous ice-frontal deposits. Rather, the margins of independent downwasting ice blocks controlled the meltwater drainage routes in each valley. Only limited amounts of meltwater were available to rework the small volumes of sediment in this area.

The Seboomook Lake Area

The Seboomook Lake area (Figure 1) also shows evidence for extensive fluvial drainage changes due to downwasting ice blocks. In this area relief is greater than in the other areas described in this paper, so deglaciation deposits are even more concentrated in the valleys.

Numerous meltwater channels in this area reflect a deglaciation dominated by vertical downwasting. High col channels eroded as southward-flowing meltwater intersected the bedrock topography. Several esker segments also formed during this time. As more topography was exposed, meltwater routes shifted to lateral positions and drained eastward out of the Seboomook Lake basin. Later in the deglaciation sequence, meltwater routes shifted from lateral to subglacial positions, thus indicating the ice mass could no longer prevent leakage to its base. Ice continued its vertical retreat to the floor of the basin, where ice-contact deltas formed at a minimum of two levels. Lowell and Crossen (1983) outlined additional details of lake lowering and fluvial drainage changes in the Seboomook Lake and adjacent basins.

Several second-order basins retained ice longer than the first-order filled basins. Ice-contact sediments within the small basins can be traced to outwash sediments and finally to fan or delta sediments in the floors of the large basins. Because these subaerial deposits occur below the levels of the paleo-lakes they likely formed after the lakes drained. However, we cannot completely rule out Holocene alluvial reworking of the ice-contact sediments.

In summary, the deglaciation of the Seboomook Lake area was characterized by meltwater erosion in uplands and glaciolacustrine deposition in lake basins. Topography played a major role in controlling deglaciation; lowering ice surfaces influenced meltwater paths in the early phases, but topography dominated the geometry of the ice bodies. Although the amount of all types of deglaciation sediments (e.g. glaciofluvial, outwash, glaciolacustrine) is greater here than elsewhere in northwestern Maine, we have not observed ice-marginal moraines.

The Red Pine Area

Red Pine is the informal name of an extensive outwash surface that occurs east of the confluence of the Northwest Branch and St. John Rivers (Figure 1). The lowland adjacent to the Red Pine outwash lies between two small mountain ranges to the east and west. The Red Pine outwash is associated with numerous meltwater channels, and is the largest single ice-marginal deposit we have observed in northwestern Maine.

A radial, late ice-flow pattern appears to be associated with the Red Pine outwash. In the lowlands southwest of the Red Pine outwash, striations indicate that this late flow was north-northeastward. Parallel striations are reported on the Quebec side of the border (LaSalle and others, 1977a). Farther south, Lowell and Crossen (1983) report that the last glacial flow was to the east. Both of these late flow events in Maine

may correlate with the late westward flow reported around Danville, Quebec (LaSalle, 1984). Age relationships between ice-flow indicators in Maine show that this radial flow pattern was the last glacier movement in northwestern Maine and perhaps the last glacier movement in New England.

Summary of Study Areas

The northernmost study area, the Allagash (Figure 1), shows mostly large-scale ice disintegration interrupted by one stillstand that may correlate with the formation of the St. Damien Morainic Complex (Chauvin and others, 1985) in Quebec. The Umsaskis Lake-Telos Lake area (Figure 1) shows vertical downwasting of ice, which allowed southward flow of meltwater at one stage before the present-day northward drainage. Seboomook Lake (Figure 1) shows that meltwater cut numerous channels into hillslopes and formed ice-contact lakes with a history of continuous lowering. Only at Red Pine (Figure 1), is there evidence for independent ice flow after the major flow patterns reported for northern Maine (Lowell and Kite, this volume).

SO WHAT? (DISCUSSION)

Below, we suggest a regional deglaciation model based on our work in northern Maine. We must emphasize that the ice-flow history (Lowell and Kite, this volume) provides the first-order control on deglaciation in this region. The last-ice flow patterns (such as the ice-flow reversal) set the stage for the final exposure of the land surface: in this case glacial retreat took place from two opposite directions.

A second aspect of the ice flow also controlled deglaciation; the ice-flow reversal (marine downdraw) (Lowell and Kite, this volume) gave the glacier different ice-flow dynamics than those associated with terrestrial ice flow. As transgressing marine waters rose against the ice margin, they produced low basal shear stress, which caused accelerated ice-flow and thinning rates (Figure 2, a-c). Consequently, faster ice flow would have transported large volumes of ice into the sea. The glacier would have rapidly thinned, but its margins would have remained stationary.

The steep portion of the concave profile resulting from downdraw would have moved toward the center of the ice mass until one of two things happened. The first possibility is that the marine waters receded from the margin before most of the ice volume was removed. In this case, accelerated flow would have ceased and normal terrestrial flow could take over after the ice mass had redistributed itself into a convex profile that could drive ice flow (Figure 2, d-f). The second possibility is that the steep portion of the concave profile retreated until it intersected the steep portion of a second concave profile working into the glacier from another direction (Figure 2, g-h). This convergence would produce a nearly flat ice surface, incapable of driving ice flow across the landscape. In this second case, downdraw would have left an ice mass that covered a wide area, but was too thin to maintain significant ice flow (Figure 2, i).

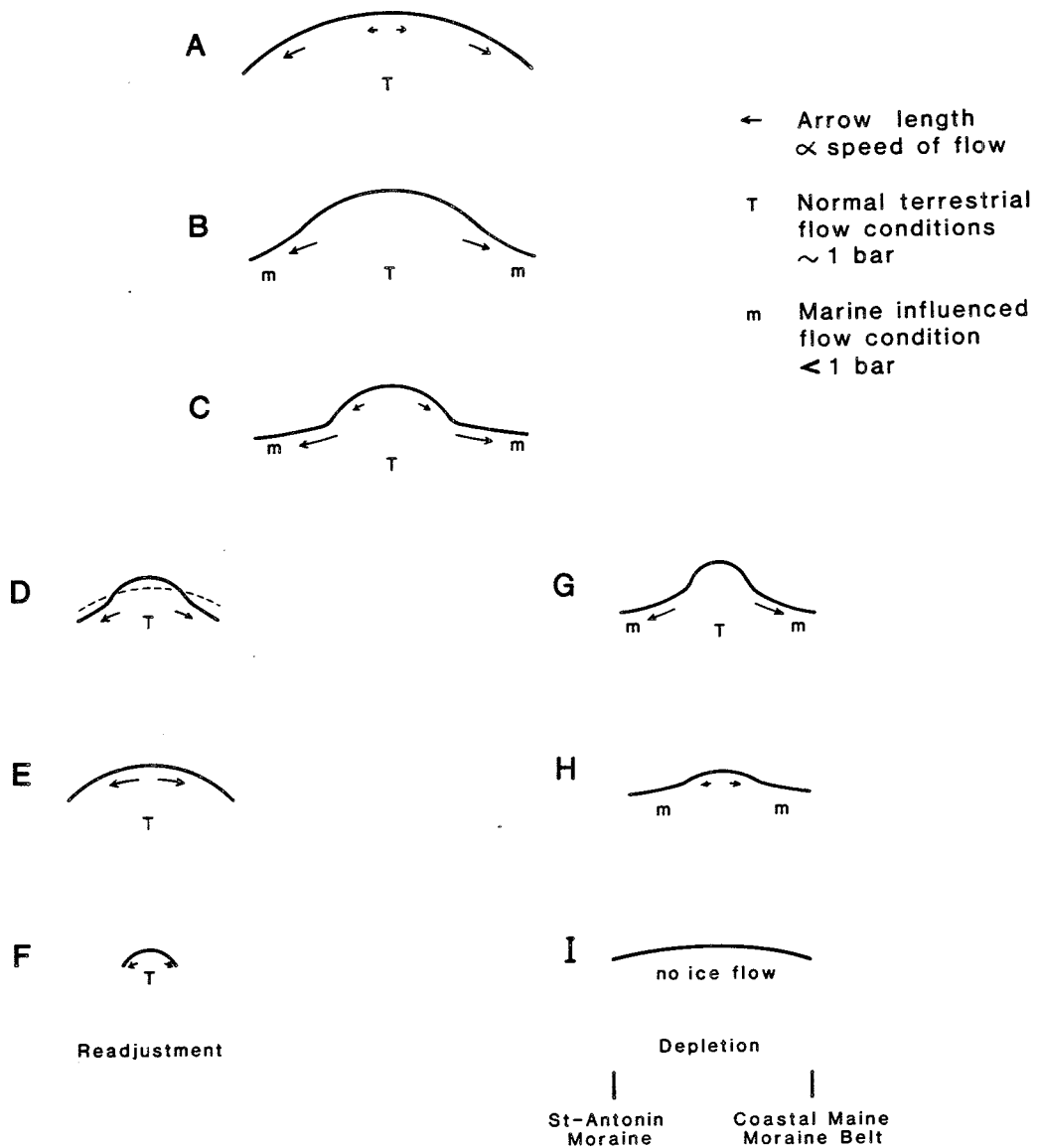

Figure 2. Marine vs. terrestrial ice flow and its relation to deglaciation style. The letters indicate possible steps during deglaciation: (a) completely terrestrial ice mass; (b) terrestrial ice mass with marine influence (ice streams) developing to either side; (c) marine influence fully developed; (d) marine influence removed and profile begins readjustment; (e) ice mass fully readjusted and terrestrial flow continues; (f) concentric recession of terrestrial ice mass; (g) marine influences from opposite sides meet in middle of ice mass; (h) marine flow ceases due to lack of ice; (i) resulting flat profile.

Let us now apply this model to northern New England and adjacent areas. Dendraw, accelerated flow, and the marine invasion allowed marine waters up the St. Lawrence Lowland (Chauvin and others, 1985) and onto the Maine coast (Smith, 1985). However, the process of accelerated ice flow may have been active in two directions for several thousand years prior to actual invasion of marine waters. One way to gauge the amount of dendraw that occurred prior to the marine invasion is to look at the type of ice activity subsequent to the marine recession. If the subsequent activity is extensive, then we may judge the dendraw process to be limited. In this case, dendraw could not have operated long enough to remove most of the ice and give it a flat, inactive surface profile. If, on the other hand, we find little or no suggestion of ice activity subsequent to the marine invasion, then we may postulate that the dendraw process was effective in removing most of the ice volume from the region.

In our investigation we have found only limited evidence of ice activity just inland from the marine limits, and evidence of large-scale disintegration across the central portion of the study area. Deposition of part of the St. Antonin Moraine (Martineau and Corbeil, 1983) may have been one of the final actions of an active Appalachian glacier. The major stillstand that formed the St. Damien Morainic Complex (Chauvin and others, 1985), and its counterpart in Maine, may represent the last coherent recession of the glacier. Other areas, interior to this moraine, have discontinuous ice marginal deposits, which correspond to stagnant ice and topographic control of changing meltwater routes. Thus, we favor a deglaciation style whereby most of the ice volume was removed by dendraw before the actual uncovering of the landscape.

The area southwest of the Red Pine outwash, where limited independent ice activity is observed, is an apparent exception to this style of deglaciation. As noted before, the area lies in a large basin between mountain ranges on either side. This basin lies in a position such that the dendraw processes would remove adjacent ice, but leave the ice within the basin. We propose that the topography of the basin protected the ice while adjacent areas were lowered. After ice in the basin became higher than ice in the surrounding areas, it developed a radial flow pattern, the north-northeastward component of which apparently terminated at the Red Pine outwash. We consider the Red Pine event to have been controlled by ice-flow mechanics rather than climate; cirques in the Boundary Mountains, less than 100 km away, did not reactivate during the latest Wisconsin (Borns and Calkin, 1977), indicating an unfavorable climate for net accumulation of ice mass.

Further testing of this model is needed. Critical items to be addressed are: (1) presence or lack of indicators of active ice-flow, (2) rebound patterns associated with deglaciation of the region, and (3) increased detail in specific areas, for example the Red Pine area. Many details and modifications will likely be made to this model in the near future as more detailed topographic maps become available and research continues.

REFERENCES CITED

- Borns, H. W., Jr., and Calkin, P. E., 1977, Quaternary glaciation, west-central Maine: Geological Society of America, Bulletin, v. 88, p. 1773-1784.
- Chauvin, L., Martineau, G., and LaSalle, P., 1985, Deglaciation of the Lower St. Lawrence region, Quebec: in Borns, H. W., Jr., LaSalle, P., and Thompson, W. B., eds., Late Pleistocene history of northeastern New England and adjacent Quebec: Geological Society of America, Special Paper 197, p. 111-123.
- Crossen, K. J., 1984, Glaciomarine deltas in Southwestern Maine: formation and vertical movements: M.S. thesis, University of Maine, Orono, 121 p.
- Davis, R. B., and Jacobson, G. L., Jr., 1985, Late glacial and early Holocene landscapes in northern New England and adjacent areas of Canada: Quaternary Research, v. 23, p. 341-368.
- Denton, G. H., and Hughes, T. J., 1981, The last great ice sheets: John Wiley and Sons, New York, 484 p.
- Gadd, N. R., LaSalle, P., Dionne, J.-C., Shilts, W. W., and McDonald, B. C., 1972, Quaternary geology and geomorphology of southern Quebec: Excursions A44-C44, XXIV International Geological Congress, Montreal, p. 35-42.
- Gadd, N. R., 1983, Notes on the deglaciation of southeastern Quebec: Geological Survey of Canada, Paper 83-1B, p. 403-412.
- LaSalle, P., 1984, Quaternary stratigraphy of Quebec: a review, in Fulton, R. J., ed., Quaternary stratigraphy of Canada - A Canadian contribution to IGCP Project 24: Geological Survey of Canada, Paper 84-10, p. 155-171.
- LaSalle, P., Martineau, G., and Chauvin, L., 1977a, Morainic deposits and glacial striae in Beauce--Notre-Dame Mountains--Laurentide Park Area: Ministere Des Richesses Naturelles Quebec, DPV-515, 22 p.
- LaSalle, P., Martineau, G., and Chauvin, L., 1977b, Morphology, stratigraphy and deglaciation in Beauce--Notre-Dame Mountains--Laurentide Park Area: Ministere Des Richesses Naturelles Quebec, DPV-516, 74 p.
- Lebuis, J., and David, P. P., 1977, La stratigraphie et les evenements du Quaternaire de la partie occidentale de la Gaspesie, Quebec: Geographie physique et Quaternaire, v. 31, p. 275-296.
- Lee, H. A., 1963, Field trip guide for the Friends of the Pleistocene: 26th Annual reunion, Riviere-du-Loup, Quebec: 29 p.

- Lowell, T. V., 1985, Late Wisconsin ice-flow reversal and deglaciation, northwestern Maine, in Borns, H. W., Jr., LaSalle, P., and Thompson, W. B., eds., Late Pleistocene history of northeastern New England and adjacent Quebec: Geological Society of America, Special Paper 197, p. 71-83.
- Lowell, T. V., and Crossen, K. J., 1983, The Seboomook Lake area became ice free, but how?, in Caldwell, D. W., and Hanson, L. S., eds., New England Intercollegiate Geologic Conference Guidebook for the Greenville - Millinocket Regions, North-central Maine, p. 147-174.
- Martineau, G., and Corbeil, P., 1983, Reinterpretation d'un segment de la moraine de Saint-Antonin, Quebec: *Geographie physique et Quaternaire*, v. 37, p. 217-221.
- Mott, R. J., 1977, Late Pleistocene and Holocene palynology in southeastern Quebec: *Geographie physique et Quaternaire*, v. 31, p. 139-149.
- Parent, M., 1984, Notes on the deglaciation of southeastern Quebec: discussion: Geological Survey of Canada, Paper 84-1B, p. 395-397.
- Rampton, V. N., Gauthier, R. C., Thibault, J., and Seaman, A. A., 1984, Quaternary geology of New Brunswick: Geological Survey of Canada, Memoir 416, 77 p.
- Shreve, R. L., 1985, Late Wisconsin ice-surface profile calculated from esker paths and types, Katahdin esker system, Maine: *Quaternary Research*, v. 23, p. 27-37.
- Smith, G. W., 1982, End moraines and the pattern of last ice retreat from central and south coastal Maine, in Larson, G. J., and Stone, B. D., eds., Late Wisconsin glaciation of New England: Kendall/Hunt Publishing Company, p. 195-210.
- Smith, G. W., 1985, Chronology of Late Wisconsinan deglaciation of coastal Maine, in Borns, H. W., Jr., LaSalle, P., and Thompson, W. B., eds., Late Pleistocene history of northeastern New England and adjacent Quebec: Geological Society of America, Special Paper 197, p. 29-44.
- Stone, G. H., 1899, The glacial gravels of Maine and their associated deposits: U.S. Geological Survey, Monograph 34, 499 p.
- Thompson, W. B., and Borns, H. W., Jr., 1985, Till stratigraphy and late Wisconsinan deglaciation of southern Maine: a review: *Geographie physique et Quaternaire*, v. 39, No. 2, p. 199-214.
- Thompson, W. B., Crossen, K. J., Borns, H. W., Jr., and Andersen, B., in press, The glaciomarine deltas of Maine: indicators of late Pleistocene-Holocene crustal movement, in Anderson, W. A., and Borns, H. W., Jr., eds., Late Quaternary crustal movement in Maine: a multidisciplinary approach: Augusta, Maine, Maine Geological Survey, Bulletin.

DEGLACIATION AND STRATIGRAPHY OF
THE LOWER ST. LAWRENCE VALLEY AND
APPALACHIAN MOUNTAINS OF SOUTHEASTERN QUEBEC

Pierre LaSalle*
Quebec Department of Energy and Resources
1620, blvd. Entente
Quebec City, Quebec
Canada G1S 4N6

Much of the material that is discussed here has been published elsewhere, so these notes are only intended as a review. Some new data, made available recently, will also be reported and discussed. Figure 1 shows tentative correlations of stratigraphic units in the study area.

In the early 1960's, radiocarbon dates obtained on shells related to the earliest part of the late-glacial marine invasion in Maine were falling in the same time range as shell dates related to the inception of the Champlain Sea in the St. Lawrence Lowland (Stuiver and Borns, 1975). This similarity in dates seemed incongruous and puzzling at the time. The ensuing debate caused some workers to question the validity of radiocarbon dates on shells, while others searched for a model of deglaciation that would accommodate the facts as they were recorded. It seemed difficult to explain how the sea could invade the St. Lawrence Lowland at the same time that it transgressed the isostatically downwarped coastal Maine lowland. The model of deglaciation that was most fashionable at the time called for a progressive retreat ("window-blind" model, Clark and Karrow, 1985) of the ice front from New England towards southern Quebec, with coastal Maine being deglaciated first, and the St. Lawrence Lowland perhaps about one to two thousand years later.

It now seems that the prevailing window-blind model was defective. In the early 1970's, numerous small crag-and-tails indicating northward glacial flow were observed by Lamarche (1971; 1974) on bedrock outcrops in the Thetford Mines area. This led to a reappraisal of the old literature (in particular Chalmers, 1899), especially as similar indicators of northward flow were observed over a broad region extending from the Thetford Mines area northeastward to Gaspe, revealing the former activity of a late-glacial ice mass in the northern Appalachians (Lortie, 1976; LaSalle and others, 1977a; LaSalle and others, 1977b; David and Lebus,

*Published with permission of the Deputy-Minister, Quebec Department of Energy and Resources.

1985). This ice mass had been severed from the main Laurentide Ice sheet by a calving bay that had progressed upstream from the Gulf of St. Lawrence at least as far as the present location of Quebec City (Chauvin and others, 1985). The calving bay produced a drawdown of the ice masses on both sides of the St. Lawrence estuary. But on the south side, it resulted in an ice-flow reversal. The latter phenomenon occurred transgressively in time from Gaspé southwestward to the Thetford Mines area.

The early penetration of a calving bay from Quebec City to the Ottawa River Valley area has been proposed (Thomas, 1977; Gadd, 1980) in an attempt to explain an apparently anomalous shell date (GSC-2151; internal fraction, $12,700 \pm 100$ yr BP; external fraction, $12,800 \pm 100$ yr BP, Richard, 1975, 1978). The validity of this date has been questioned by Clark and Karrow (1984; see also Karrow and others, 1975). In fact, this controversy goes back to the publication of a date obtained on wood from a core taken in the harbor at Hamilton (Karrow and others, 1961). This date would suggest that Lake Iroquois was still in existence around 11,500 yr BP and had not yet drained into the Champlain Sea (Y-691, $11,510 \pm 240$ yr BP; Karrow and others, 1961).

Radiocarbon dates GSC-2151 (quoted above) and GSC-1533 ($12,400 \pm 160$ yr BP), obtained on marine shells near Quebec City, tend to corroborate the concept of early penetration of a calving bay in the St. Lawrence estuary, at least from Gaspé up to the Quebec City area. But farther west, the situation is less clear. Even though the Highland Front moraine has been traced as far as the Granby area (Gadd, 1964), there is no evidence that the sea wedged its way between the ice and the Appalachian Highlands to the south. Rather, it seems that as long as the ice barrier was present in the Quebec City area, there existed at the same time a glacial lake that occupied the Champlain Valley, the Ottawa River Valley, the Montreal area, and a large sector east of Montreal, probably as far east as Danville. These conclusions are based on the presence of rhythmites or pseudo-varves underlying the marine sediments in the latter areas (LaSalle, 1981, 1985; Anderson and others, 1985; Prest and Hode-Keyser, 1977).

The maximum elevation reached by that lake (Lake Vermont of Chapman, 1937) or its various phases is better documented in the Champlain Valley (Chapman, 1937; Denny, 1974) than in the St. Lawrence Lowland to the north (Elson, 1962). This is presumably because most of the north shore of the glacial lake was formed by ice (except around some of the Monteregian Hills), so no shorelines were formed in that direction. In accordance with the older marine shell dates quoted above, a few radiocarbon dates obtained on lake-bottom sediments suggest an early deglaciation of the Montreal area (GSC-419, $12,570 \pm 220$ yr BP). However, some of those dates have been questioned because of the presence of carbonates at the base of the cores (GSC-1344, $13,000 \pm 290$ yr BP, 267-271 cm; GSC-1803, $12,400 \pm 170$ yr BP, 263-267 cm, Lowdon and Blake, 1975). In any case, it seems that the seawater coming from the east merged with a large glacial lake in the western part of the St. Lawrence Lowland. The same succession of events occurred in the Quebec City area, where one or more glacial lakes (separate from the one in the Montreal area) occupied areas south of the present St. Lawrence channel, probably as far as Montmagny, before the disintegration of the ice barrier that apparently was located for a time east of

Montmagny. The ice divide for some of the late-glacial Appalachian ice mass was apparently located in Maine, as discussed elsewhere in this volume.

McDonald and Shilts (1971) have proposed a model for the Quaternary stratigraphy of the lower St. Lawrence estuary and the Appalachians of southern and eastern Quebec (see also LaSalle, 1984a). In the Quebec City area, the stratigraphic sequence recorded by LaSalle (1984a) is very similar to the one described by Gadd (1971, 1976; Occhiotti, 1980; Lamothe, 1984) for the central St. Lawrence Lowland. Two major ice advances seem to be well documented. The deposits left by these advances are separated by the St. Pierre interglacial sediments (Anse-aux-Hirondelles Formation in the Quebec City area)(Figure 1). The latter formation is composed of fluvial sands overlying organic silts and sands dated at greater than 42,000 yr BP (GSC-3420, LaSalle, 1984a; Blake, 1984).

Partial deglaciation of the St. Lawrence estuary seems to have occurred as far inland as l'Ile-aux-Coudres around 30,000 yr BP. The dates supporting this retreat were obtained on wood (Brodeur and Allard, 1985), and they seem to agree with shell dates obtained on material collected on Anticosti Island (Bigras and others, 1985). They are apparently related to the Gayhurst partial deglaciation of southeastern Quebec (McDonald and Shilts, 1971). The Gayhurst ice front was situated approximately 50 km south of Quebec City, possibly passing through the Valley Junction area (Gadd and others, 1972). Farther east, it may have trended through northern Maine (Thompson and Borns, 1985), and thence south and around the Gaspé Peninsula. At that same time (which would be correlative with the Cherrytree Stade of the Great Lakes-St. Lawrence region; Dreimanis and Karrow, 1972; LaSalle, 1984a; Fulton and others, 1984), parts of the St. Lawrence estuary including Anticosti Island and Ile-aux-Coudres may have been deglaciated (Grant and King, 1984). For now, however, this is only speculation.

Uranium-Thorium dates obtained on speleothems from the St. Elzéar cave (Roberge and Gascoyne, 1978) in southern Gaspé Peninsula suggest that several nonglacial episodes occurred in the Gaspé Peninsula (LaSalle, 1984b; LaSalle and others, 1986). In eastern Gaspé, there is evidence for at least two episodes of glaciation, one of them being possibly as old as Illinoian (LaSalle and others, 1986). From recently collected field data, it can be assumed that the Gaspé Peninsula has been completely covered by the continental ice sheet at some time in the past and that the ice advanced into the sea well beyond the southern coast of Gaspé (Prest, 1970). The maximum level of the marine invasion in southern Gaspé is at a present altitude of at least about 47 m (but possibly as high as 65 m).

ACKNOWLEDGMENTS

The author is grateful to P. E. Calkin, R. J. Dineen, J. S. Kite and W. B. Thompson for reviewing the manuscript of this paper.

REFERENCES

- Anderson, T. W., Mott, R. J., and Delorme, L. D., 1985, Evidence for a pre-Champlain Sea glacial lake phase in Ottawa valley, Ontario and its implications: Geological Survey of Canada, Paper 85-1A, p. 239-245.
- Bigras, P. J. G., Dubois, J. M. M., and Gwyn, Q. H. J., 1985, Relative sea level fluctuations during the last 35,000 years, Northern Gulf of St-Lawrence, Quebec (abs.): G.A.C.-M.A.C. meeting, Fredericton, N.B., Program with abstracts, p. A-5.
- Blake, W., Jr., 1984, Geological Survey of Canada Radiocarbon Dates XXIV: Geological Survey of Canada, Paper 84-7, 35 p.
- Brodeur, D., and Allard, M., 1985, Stratigraphie et Quaternaire de L'ile-aux-Coudres, estuaire moyen du St-Laurent: Geographie Physique et Quaternaire, v. 39, p. 183-197.
- Chalmers, R., 1899, Report on the surface geology and auriferous deposits of southeastern Quebec: Geological Survey of Canada, Annual Report (1897), v. 10, pt. J., 160 p.
- Chapman, D. H., 1937, Late-glacial and post-glacial history of the Champlain Valley: American Journal of Science, v. 34, p. 89-124.
- Chauvin, L., 1979, Depots meubles de la region de Thetford Mines - Victoria-ville: Ministere des Richesses naturelles, Quebec, DPV-622, 20 p.
- Chauvin, L., Martineau, G., and LaSalle, P., 1985, Deglaciation of the Lower St. Lawrence Region, Quebec, in Borns, H. W., Jr., LaSalle, P., and Thompson, W. B., eds., Late Pleistocene history of northeastern New England and adjacent Quebec: Geological Society of America, Special Paper 197, p. 111-124.
- Clark, P., and Karrow, P. F., 1984, Late Pleistocene water bodies in the St. Lawrence Lowland, New York, and regional correlations: Geological Society of America, Bulletin, v. 95, p. 805-813.
- David, P. P., and Lebus, J., 1985, Glacial Maximum and Deglaciation of Western Gaspé, Quebec, Canada, in Borns, H. W., Jr., LaSalle, P., and Thompson, W. B., eds., Late Pleistocene history of northeastern New England and adjacent Quebec: Geological Society of America, Special Paper 197, p. 85-110.
- Denny, C. S., 1974, Pleistocene geology of the Northeast Adirondack region, New York: U.S. Geological Survey, Professional Paper 786, 50 p.
- Dreimanis, A., and Karrow, P. F., 1972, Glacial history of the Great Lakes-St. Lawrence region, the classification of the Wisconsin(an) Stage, and its correlatives: 24th International Geological Congress (Montreal), Section 12, p. 5-15.

- Elson, J. A., 1962, Pleistocene geology between Montreal and Covey Hill, in Clark, T. H., ed., Intercollegiate Geological Conference Guidebook: 54th Annual Meeting, Montreal, Oct. 5-7, p. 61-66.
- Fulton, R. J., Karrow, P. F., LaSalle, P., and Grant, D. R., 1984, Summary of Quaternary stratigraphy and history, Eastern Canada, in Fulton, R. J., ed., Quaternary stratigraphy of Canada - a Canadian contribution to IGCP Project 24: Geological Survey of Canada, Paper 84-10, p. 194-210.
- Gadd, N. R., 1964, Moraines in the Appalachian region of Quebec: Geological Society of America, Bulletin, v. 75, p. 1249-1254.
- _____, 1971, Pleistocene geology of the Central St-Lawrence Lowland: Geological Survey of Canada, Memoir 359, 153 p.
- _____, 1976, Quaternary stratigraphy of southern Quebec, in Mahaney, W. C., ed., Quaternary Stratigraphy of North America: Dowden, Hutchinson and Ross, Stroudsburg, Penn., p. 37-50.
- _____, 1980, Late-glacial regional ice-flow patterns in eastern Ontario: Canadian Journal of Earth Sciences, v. 17, p. 1439-1453.
- Gadd, N. R., McDonald, B. C., and Shilts, W. W., 1972, Deglaciation of southern Quebec: Geological Survey of Canada, Paper 71-47, 19 p.
- Grant, D. R., and King, L. H., 1984, A stratigraphic framework for the Quaternary history of the Atlantic Provinces, in Fulton, R. J., ed., Quaternary Stratigraphy of Canada - a Canadian contribution to IGCP Project 24: Geological Survey of Canada, Paper 84-10, p. 174-191.
- Karrow, P. F., Clark, J. R., and Terasmae, J., 1961, The age of Lake Iroquois and Lake Ontario: Journal of Geology, v. 69, p. 659-667.
- Karrow, P. F., Anderson, T. W., Clarke, A. H., Delorme, L. D., and Sreenivasa, M. R., 1975, Stratigraphy, paleontology, and age of Lake Algonquin sediments in southwestern Ontario, Canada: Quaternary Research, v. 5, p. 49-87.
- Lamarche, R. Y., 1971, Northward moving ice in the Thetford Mines area of southern Quebec: American Journal of Science, v. 271, p. 383-388.
- _____, 1974, Southward, northward and westward moving ice in the Asbestos area of southern Quebec: Geological Society of America, Bulletin, v. 35, p. 465-470.
- Lamothe, M., 1984, Apparent thermoluminescence ages of St-Pierre sediments at Pierreville, Quebec and the problem of anomalous fading: Canadian Journal of Earth Sciences, v. 21, p. 1406-1409.
- LaSalle, P., 1981, Geologie des depots meubles de la region de St-Jean - Lachine: Ministere de l'Energie et des Ressources, Quebec, DPV-780, 13 p., maps.

- _____, 1984a, Quaternary stratigraphy of Quebec: A review, in Fulton, R. J., ed., Quaternary stratigraphy of Canada - a Canadian contribution to IGCP Project 24: Geological Survey of Canada, Paper 84-10, p. 155-171.
- _____, 1984b, Geological setting and preliminary faunal report for the St-Elzear Cave, Quebec, Canada, in Genoways, H. H., and Dawson, M. R., eds., Contributions in Quaternary vertebrate paleontology: a volume in memorial to John E. Guilday: Carnegie Museum of Natural History, Special Publication No. 8, Pittsburgh, p. 332-346.
- _____, 1985, Geologie des sediments meubles de la region de Lacolle - St-Chrysostome: Ministere de l'Energie et des Ressources, Quebec, Paper 83-21, 13 p., maps.
- LaSalle, P., David, P. P., and Bedard, P., 1986, Illinoian and younger diamicts of eastern Gaspé Peninsula, Quebec, Canada (abs.): Geological Society of America, Abstracts with Programs, v. 18, no. 1, p. 29.
- LaSalle, P., Martineau, G., and Chauvin, L., 1977a, Morainic deposits and glacial striae in Beauce-Notre-Dame Mountains-Laurentide Park area: Ministere des Richesses naturelles du Quebec, DPV-515, 22 p.
- _____, 1977b, Morphology, stratigraphy and deglaciation in Beauce-Notre-Dame Mountains-Laurentide park area: Ministere des Richesses naturelles du Quebec, DPV-516, 74 p.
- Lebuis, J., and David, P. P., 1977, La stratigraphie et les evenements du Quaternaire de la partie occidentale de la Gaspesie: Geographie physique et Quaternaire, v. 31, p. 275-296.
- Lortie, G., 1976, Les ecoulements glaciaires Wisconsinniens dans les cantons de l'Est et la Beauce, Quebec: M.S. thesis, McGill University, Montreal, 200 p.
- Lowdon, J. A., and Blake, W., Jr., 1975, Geological Survey of Canada Radiocarbon Dates V: Geological Survey of Canada, Paper 75-7, 32 p.
- McDonald, B. C., and Shilts, W. W., 1971, Quaternary stratigraphy and events in southeastern Quebec: Geological Society of America, Bulletin, v. 82, p. 683-698.
- Occhietti, S., 1980, Le Quaternaire de la region de Trois-Rivieres - Shawinigan, Quebec: Paleo-Quebec, pub. no. 10, 218 p.
- Prest, V. K., 1970, Quaternary Geology of Canada, in Geology and Economic Minerals of Canada: Geological Survey of Canada, Economic Geology Report No. 1, 5th ed., p. 676-764.
- Prest, V. K., and Hode-Keyser, J., 1977, Geology and engineering characteristics of surficial deposits, Montreal Island and vicinity, Quebec: Geological Survey of Canada, Paper 75-27, 29 p.

Richard, S. H., 1975, Surficial geology mapping: Ottawa Valley lowlands (parts of 31G, B, F): Report of Activities, Part B, Geological Survey of Canada, Paper 75-18, p. 113-117.

_____, 1978, Age of Champlain Sea and "Lampsilis Lake" episode in the Ottawa - St. Lawrence Lowlands, in Current Research, Part C: Geological Survey of Canada, Paper 78-1C, p. 23-28.

Roberge, J., and Gascoyne, M., 1978, Premiers resultats de datations dans la grotte de St-Elzear, Gaspesie, Quebec: Geographie Physique et Quaternaire, v. 32, p. 282-287.

Stuiver, M., and Borns, H. W., Jr., 1975, Late Quaternary marine invasion in Maine: its chronology and associated crustal movement: Geological Society of America, Bulletin, v. 86, p. 99-104.

Thomas, R. M., 1977, Calving bay dynamics and ice sheet retreat up the St. Lawrence Valley system: Geographie Physique et Quaternaire, v. 31, p. 347-356.

Thompson, W. B., and Borns, H. W., Jr., 1985, Till stratigraphy and late Wisconsinan deglaciation of southern Maine: a review: Geographie Physique et Quaternaire, v. 39, p. 199-214.

QUATERNARY GEOLOGY OF MADAWASKA COUNTY, WESTERN NEW BRUNSWICK: A BRIEF OVERVIEW

V. N. Rampton
Terrain Analysis and Mapping Services Inc.
Box 158
Carp, Ontario
Canada KOA 1L0

This short paper describing the Quaternary geology of Madawaska County is abstracted from the Geological Survey of Canada's Memoir 416, Quaternary Geology of New Brunswick (Rampton and others, 1984). The primary sources (including references) of interpretations presented in this paper, and the rationale for these interpretations, can be found in that reference.

The western part of Madawaska County, lying in the Edmundston Highlands (Rampton and others, 1984), is characterized by hilly topography with hill crests between 420 and 532 m, and relief of 120 to 150 m. The northeast-oriented axis of these hills is transected by the broad U-shaped Madawaska River valley. The eastern part of Madawaska County, lying in the Chaleur Uplands, is characterized by an undulating surface with elevations between 270 and 370 m. Adjacent to the Saint John River, dissection by tributaries gives the Uplands a hilly aspect. In the southern part of Madawaska County the central Saint John River valley is characterized by a floodplain and low benches (primarily alluvial) up to 2.5 km wide.

Direct evidence of glaciation predating the late Wisconsinan is elusive, although ice surface profiles required to cover the Miramichi and Caledonian Highlands during pre-late Wisconsinan glaciations would have required ice cover of Madawaska County, presumably ice flowing from central Maine or Laurentide ice moving from the west across the Notre Dame Mountains. Laurentide erratics, which are most abundant in glaciofluvial sediments underlying surface tills in a restricted area of Madawaska County and adjacent Victoria County, were probably deposited during a glaciation predating the late Wisconsinan or during an early phase of the late Wisconsinan. Rampton and others (1984) have observed multiple-till sections at Edmundston, but the chronology of these tills was not established. Unoxidized tills at this locality and other sites along the Saint John River south of Grand Falls may date from early or middle Wisconsinan glaciations. However, in one exposure along the Saint John River an oxidized horizon developed on till is believed to represent an interglacial interval; this implies a pre-Wisconsinan age for this till.

Glaciofluvial strata interbedded with near-surface unoxidized tills in exposures along the Saint John River valley are believed to have been deposited during early to late Wisconsinan nonglacial intervals. A large

mass of glaciofluvial sediments near Blue Bell Lake, just southeast of Madawaska County, is thought to have been deposited as proglacial sediments during the Wisconsinan stage.

The late Wisconsinan was marked by continuous glacial activity in Madawaska County. During the Chignecto phase, tentatively dated between 15 and 18 ka, glacier ice covered most of New Brunswick. It is unclear in northwestern New Brunswick whether most glacier ice during this interval originated from the North Maine Ice Divide and Notre Dame Mountains Ice Centers or whether Laurentide Ice was still moving into the area. However, these northern ice sources must have had limited thickness and strength as that ice was diverted by highlands (unglaciated?) in northern New Brunswick and by ice originating from an ice center in central New Brunswick (Figure 1). During the Bantalor phase, between 12.7 and 13.4 ka, glacial ice flowing east and south from northern New Brunswick definitely had to originate from the North Maine Ice Divide and Notre Dame Ice Centers (Figure 2). The lower Saint Lawrence River valley was deglaciated by this time (Lebuis and David, 1977; Locat, 1977), preventing Laurentide ice from flowing into New Brunswick. With deglaciation of the Saint Lawrence River valley, ice would flow northward from the North Maine Ice Divide and Notre Dame Ice Centers. This general pattern continued to the end of the Millville/Dungarvon phase (Figure 3), at about 12.4 ka. At that time or shortly thereafter, the North Maine Ice Divide and Notre Dame Mountains Ice Centers began to disintegrate into a number of small separate ice caps (Figure 4). A local readvance from the northern edge of the North Maine Ice Divide actually occurred across terrain uncovered by Notre Dame Ice (Figure 4a). By 12.2 ka the largest remaining ice cap was centered over the Saint-Quentin Plateau, with local valley glaciers present in the Notre Dame Mountains (Figure 4c).

As the northern margin of the Saint-Quentin Ice Center (or remnant North Maine Ice Divide) retreated southward, meltwater west of the Madawaska River was diverted westward and northward into the Cabano River system in Quebec. Glaciofluvial deposits were formed subglacially in northwestward trending valleys in this area along the northern ice margin. East of the Madawaska River, meltwater channels carried water eastward into the Restigouche River system. At this time the southern margin of glacial ice in the Saint John River valley probably terminated in Inland Sea Acadia at about 130 m in elevation. This "inland sea" came into existence around 12.3 ka as a result of continued differential isostatic depression in New Brunswick that caused the Reversing Falls at Saint John to rise above relative sea level at that time. Further shrinkage of the Saint-Quentin Ice Center allowed submergence of the central Saint John River valley by Inland Sea Acadia to elevations of near 160 m (the upper elevation of discontinuous clay and sand veneers and lower elevation of sharply-defined kettle holes, eskers and morainic ridges in this area are interpreted to be the upper limit of postglacial submergence). During the interval when a remnant ice mass existed in the Madawaska and Saint John River valleys near Edmundston, glacially dammed lakes to the north of this ice-plug drained across present-day drainage divides at the heads of Riviere Ashberish or Riviere des Aigles, near 182 m elevation, to the Saint Lawrence River. Final melting of remnant ice masses in the Saint-Quentin Ice Center, including the plug at Edmundston, was probably complete by 12 ka.

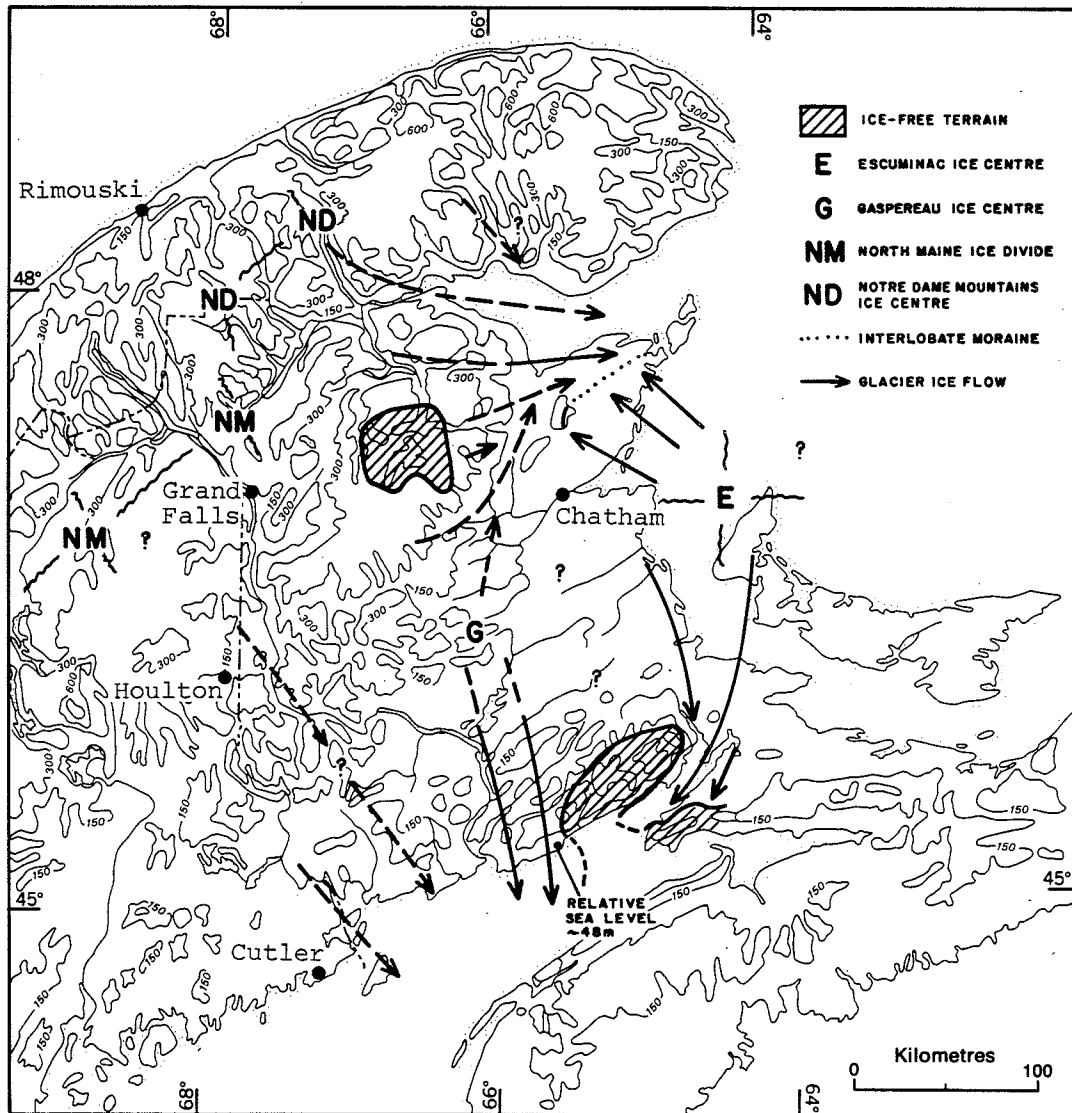

Figure 1. Paleogeography during Chignecto phase (after Rampton and others, 1984).

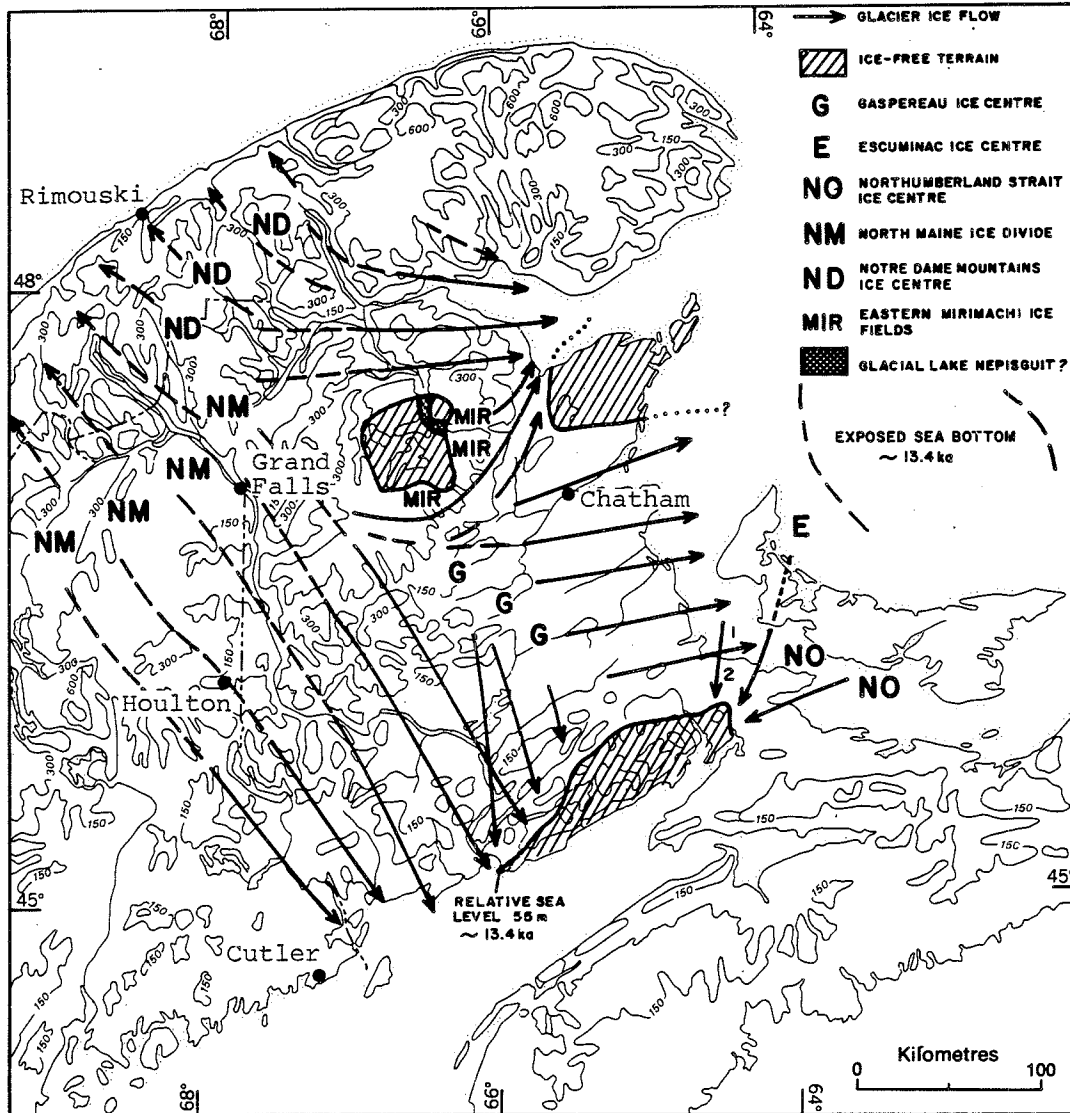

Figure 2. Paleogeography during maximum extent of Bantolor phase ice (after Rampton and others, 1984).

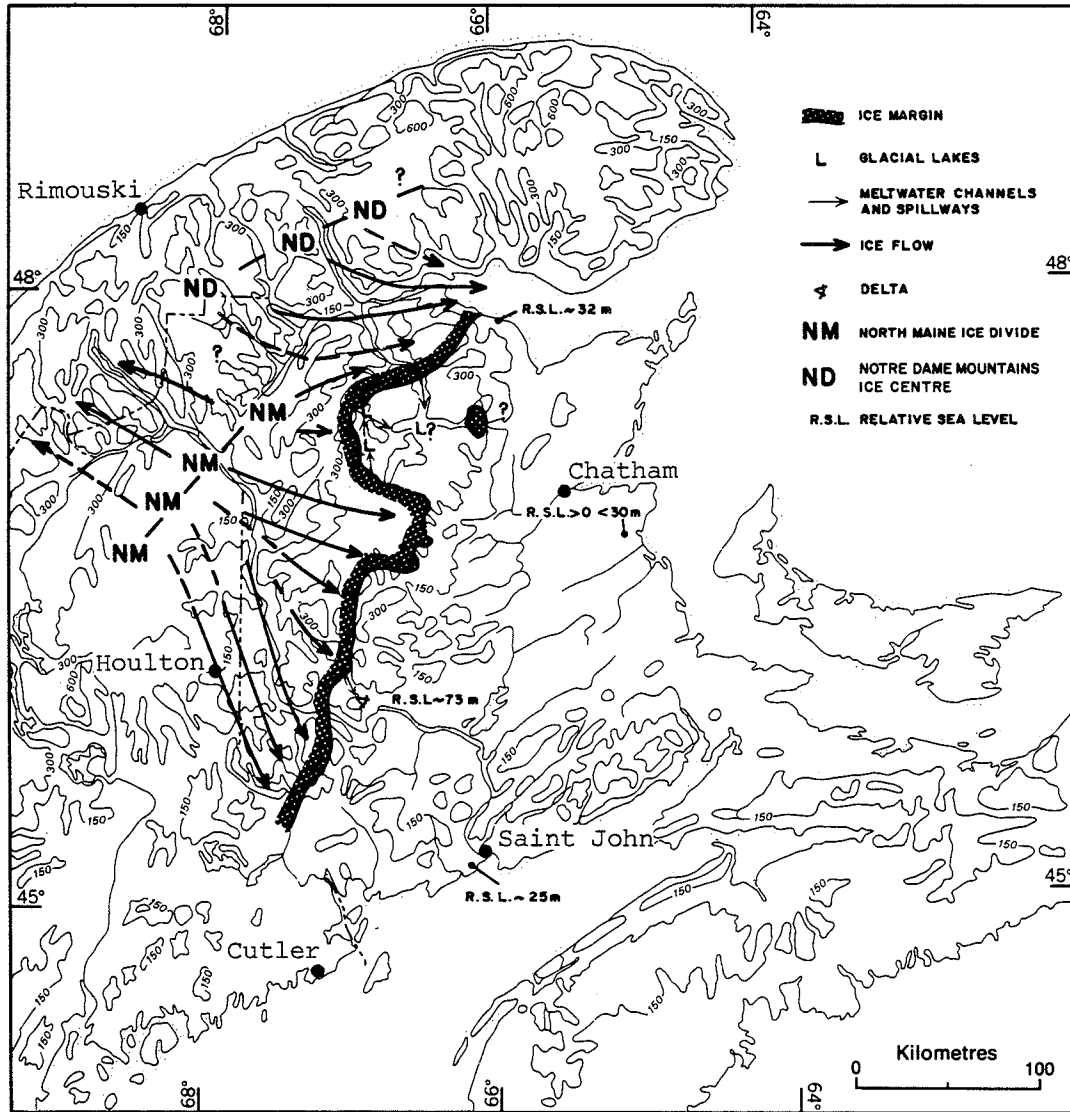

Figure 3. Paleogeography during maximum extent of Millville/Dungarvon phase ice (after Rampton and others, 1984).

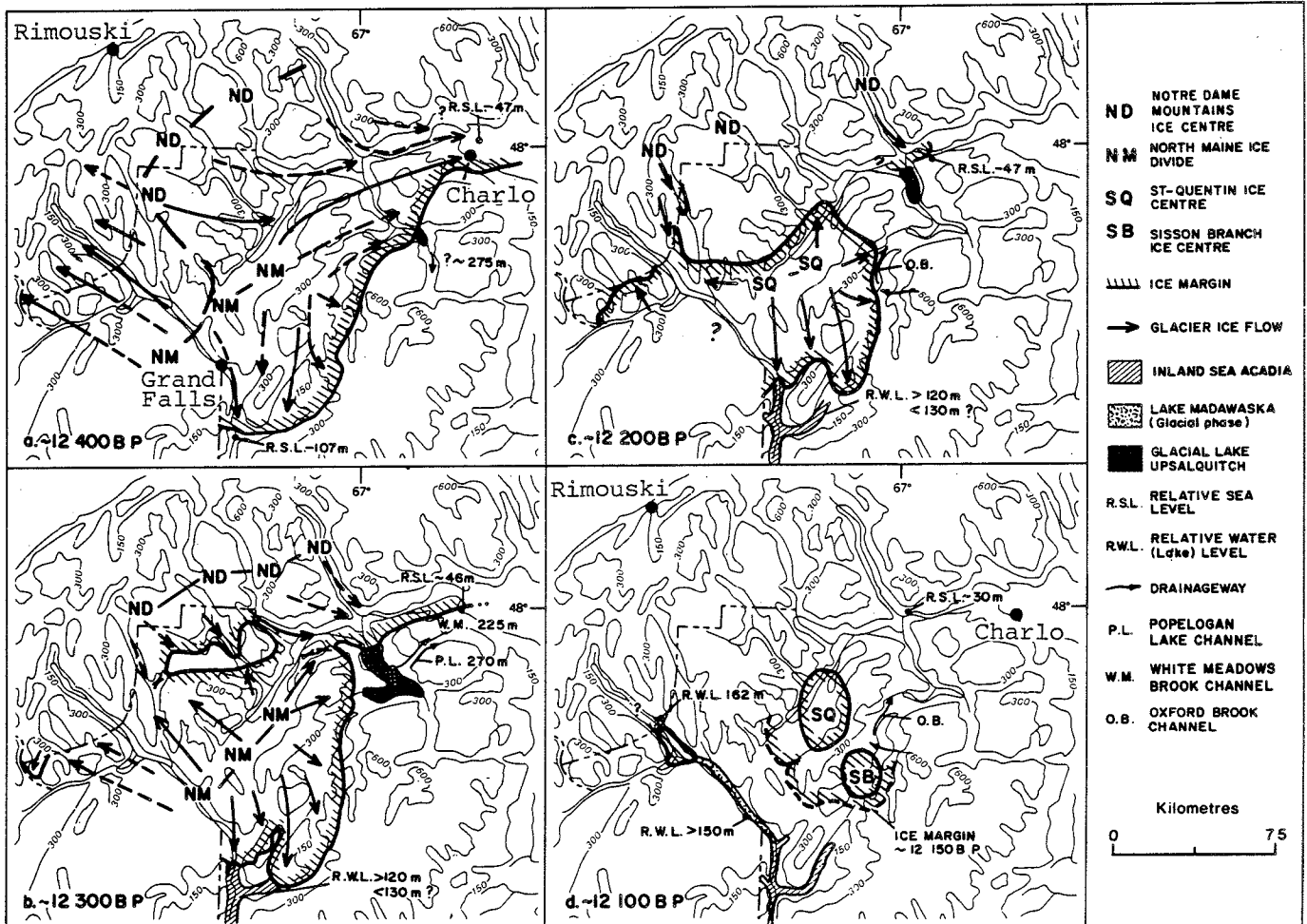

Figure 4. Paleogeography during Plaster Rock and Chaleur phases (after Rampton and others, 1984).

Lake Madawaska, a paleolake that formed numerous beaches and terraces in the Saint John River valley above Grand Falls, came into existence as a separate entity from the remainder of Inland Sea Acadia when postglacial emergence caused water levels in the Saint John River valley to fall below the rock sill at Grand Falls (elevation circa 146 m). The erosion of this rock sill slowed the fall in lake level and allowed the formation of well developed beaches. A sand plain was formed between Edmundston and Lake Temiscouata as alluvium of the Saint John River prograded into Lake Madawaska. Lake Madawaska was largely drained by 10 ka, but alluvial infilling of small remnant lakes may have continued until 8.8 ka.

REFERENCES

- Lebuis, J., and David, P. P., 1977, La stratigraphie et les evenements de Quaternaire de la partie occidentale de la Gaspesie, Quebec: Geographie physique et Quaternaire, v. 31, no. 3-4, p. 275-296.
- Locat, J., 1977, L'emersion des terres dans la region de Baie-des Sables/Trois-Pistoles, Quebec: Geographie physique et Quaternaire, v. 31, no. 3-4, p. 297-306.
- Rampton, V. N., Gauthier, R. C., Thibault, J., and Seaman, A. A., 1984, Quaternary Geology of New Brunswick: Geological Survey of Canada, Memoir 416.

ICE MOVEMENTS IN MADAWASKA AND VICTORIA COUNTIES, NORTHWESTERN NEW BRUNSWICK

Martin Rappol
Geological Survey of Canada
601 Booth Street
Ottawa, Ontario
Canada K1A 0E8

INTRODUCTION

Increased Quaternary research efforts conducted during the past decade in northern Maine, northwestern New Brunswick, and southern Quebec have revealed a complex glacial history in this area (Genes and others, 1981; Kite and Lowell, 1982; Lowell, 1985; Newman and others, 1985; Gauthier, 1980, 1983; Rampton and others, 1984; Lamarche, 1971; Gadd and others, 1972; Martineau, 1979; Shilts, 1981; Chauvin and others, 1985; David and Lebuis, 1985). Most discussion has centered on two issues: (1) the extent and origin of an Appalachian ice divide that developed during late Wisconsinan time; and (2) the relative importance and interaction of the Laurentide and local ice sheets during different glacial periods in the region. A better understanding of these matters in such relatively poorly known regions as northern New Brunswick is critical to a reliable reconstruction of the nature and sequence of glacial events in the entire region of southeastern Canada and New England.

This paper presents some preliminary results from fieldwork carried out in the summer of 1985 in Madawaska and Victoria counties of northwestern New Brunswick. This presentation is limited to a discussion of the different ice flow patterns over the area, and to a discussion of the Quaternary stratigraphy in the area around Grand Falls.

INDICATORS OF ICE FLOW TREND AND DIRECTION

Unequivocal evidence of the local ice flow trend is provided by outcrops of ice-scoured bedrock. Where possible, the direction of ice movement was determined from stoss- and lee-side relationships, small crag-and-tail features (rat tails), and nailhead striations (e.g. Prest, 1983). The relative age of cross-cutting striations could be determined where the younger movement abraded the stoss side of older grooves. The results are plotted in Figure 1, together with other published striation data from sites that were not visited by the author. Some omissions had to be made due to lack of space, but only of data that are similar to those of nearby sites plotted here.

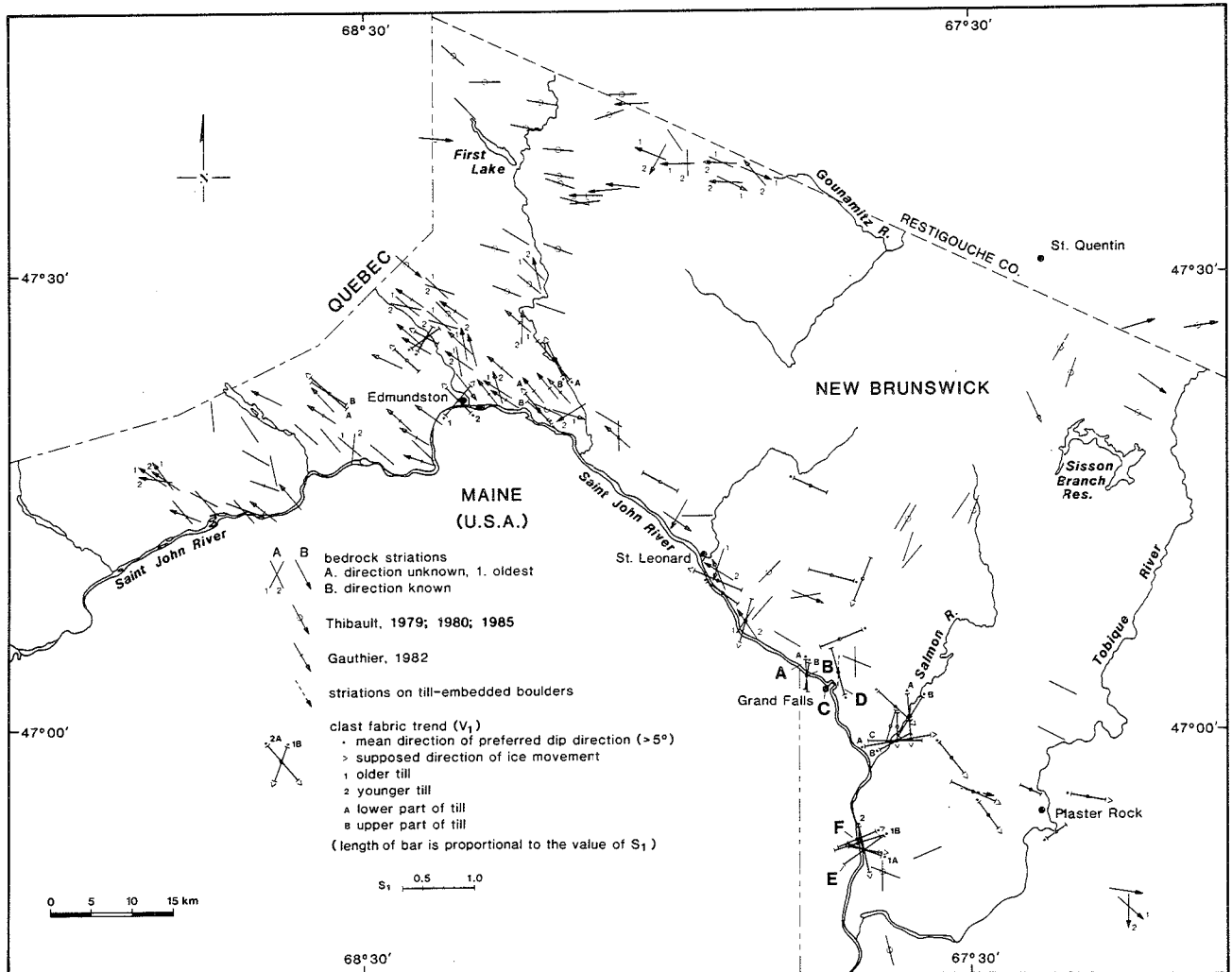

Figure 1. Striations and till fabric trends in the investigated area. Clast fabric trend is given by the principal eigenvector (V_1), with the length of the bar proportional to the value of the normalized eigenvalue (S_1), the latter being an expression of fabric strength. Large capitals A-F indicate the locations of stratigraphic sections shown in Figure 2.

Observations of striations on boulders embedded in till are uncommon, primarily because the local bedrock types are thinly bedded or cleaved, producing unsuitable plate- and blade-shaped stones. Moreover, at several sites bullet-shaped boulders having striated surfaces obviously did not align with local ice movement as indicated by other evidence.

At desired locations, the clast fabric of subglacial till was determined by measuring the orientation and plunge of 50 elongated clasts (a/b-axis ratio greater than 1.4), or two groups of 25 clasts at closely spaced intervals. These data were processed by the eigenvalue method (see for example Mark, 1973; Woodcock and Naylor, 1983).

Although elongated clasts in till tend to be imbricated upglacier, this cannot be taken as an unequivocal criterion for determining direction of ice flow; a small number of the fabric analyses may yield downglacier-dipping fabrics. In Figure 1 the trend of the principal eigenvector is plotted, in some cases with a supposed direction of ice movement indicated where this could be derived from other evidence such as subglacial deformation structures in sub-till sediment, striations on underlying bedrock, or till composition.

An investigation of till composition as an indicator of ice movement is currently in progress. Gauthier (1983) has pointed out that material derived from the Mississippian redbeds around Plaster Rock is not found dispersed in a northern or western direction. Although granites, gneisses and other igneous and high-grade metamorphic rocks of remote provenance are found in the larger part of the area, they seem to be absent from the Plaster Rock area. However, these rock types are of little use as ice flow indicators as the percentages in the examined fractions (4-8 and 8-16 mm) are extremely low (less than 0.5%); in fact these erratics seem to be more common in till associated with the northwest ice movement. This suggests that most of this material has probably undergone several cycles of erosion and deposition (see also Kite and Lowell, 1982).

ICE FLOW PATTERNS

In the northern part of the study area, two more or less opposite directions of ice movement are recorded by bedrock striations. Only in the Gounamitz Valley have these striations been found cross-cutting, indicating an older movement towards the east or southeast, and a younger movement towards the west, northwest, or north. The group of northwest flow indicators is limited to the northern part of the study area (southernmost location at Bellefleur, 13 km northwest of Grand Falls), and seems related to a late Wisconsinan Appalachian ice divide stretching from northern New Brunswick (Rampton and others, 1984) across northern Maine (Lowell, 1985) into southern Quebec (e.g. Gadd and others, 1972; Chauvin and others, 1985). This Appalachian ice divide is generally thought to have developed as a result of drawdown by rising marine waters in the Saint Lawrence Valley, although Rampton and others (1984) suggest it to be a permanent feature throughout late Wisconsinan time.

East of First Lake the younger ice movement was more or less due west; around Edmundston it was towards the northwest; while in northwestern Maine this flow event was predominantly due north. This flow convergence may have resulted from drawdown by a marine incursion in Chaleur Bay, inducing a saddle and northward curve in the ice divide with the result that it could join the ice divide in the Notre Dame Mountains on Gaspé Peninsula.

At many sites, two sets of north or northwest trending striations are found, generally intersecting at an angle of between 15° and 30° . There seems to be no consistency in the direction of azimuthal change between sites. The imprint of the youngest movement is always much weaker than the older, and is limited to abrasion of the stoss sides of grooves that belong to the older movement. The youngest movement probably reflects minor changes in ice movement direction during deglaciation, when flow of thinning ice was more and more influenced by the local bedrock relief and the configuration of the ice body itself.

In the northern part of the investigated area, the clast fabric in the surface till, or in till overlain by late- and postglacial gravels, generally aligns with the orientation of the striations, with the principal eigenvector V_1 dipping towards the southeast. In some places deformation structures indicate ice movement towards the northwest. It is suggested that the surface till in the northern part of the area, either brown yellow (oxidized) or gray, was deposited by the ice movement towards the northwest.

In the north a lower till was observed only at one site in the western part of the town of Edmundston, where it was separated from the surface till by approximately 8 m of layered gravel, sand, and laminated silt. The lower till displays a northeast-southwest trending fabric. The same direction was found in a till exposed in gravel pits northwest of St-Jacques (7 km north of Edmundston), where strong imbrication indicated transport towards the northeast. At another site in the same pit, however, in what appeared to be the same till unit, but exposed higher up the slope on top of a bedrock ledge, a northwest-southeast fabric was measured.

This ice movement towards the northeast is not corroborated by observed bedrock striations, but an older ice movement recorded by clast fabric in a lower till south of Grand Falls (see below) likewise finds minimal support from bedrock striations. It seems likely, or at least possible, that the lower till at Edmundston was deposited during a general eastward ice movement that predates a regional deglaciation in early or pre-late Wisconsinan time (e.g. Rampton and others, 1984; Newman and others, 1985).

An older ice movement towards the east or southeast is recorded by striations throughout most of the study area, and continues far to the east into the New Brunswick Highlands (Rampton and others, 1984). A similar direction of ice movement, synchronous with the younger ice movement towards the northwest, can be expected to have occurred on the southeastern side of the late Wisconsinan Appalachian ice divide. With the absence of good stratigraphic sections and the low density of striation sites, the two events could not be distinguished in the field.

North of Grand Falls, in a zone stretching towards Sisson Branch Reservoir, striations trending south-southwest/north-northeast were recorded by Thibault (1980, 1985). At two sites near Saint-Leonard, these striations were found to be older than the northwest ice movement, and at two sites a direction towards the south-southeast could be determined. This ice movement could be synchronous with, and the up-ice extension of, the southward ice movement recorded around and to the south of Grand Falls. No relative chronology could be established between these directions of movement and the southeast one. At one site southeast of Plaster Rock, striations indicating movement towards the southeast are cross-cut by younger striations indicating ice movement towards the south, but this site is somewhat remote and may simply record a local phenomenon. Evidence of an older ice movement towards the east and more details on the stratigraphy around Grand Falls will be discussed in the following section.

Finally, there is a lack of data in the central part of the area. This may in part be due to the poor accessibility, but more important is the fact that till in this area is absent or thin, and the bedrock is heavily fractured. Similar features have been described from central New Brunswick (Gauthier, 1983) and southwestern Gaspesie (David and Lehuis, 1985), and are commonly accounted for by cold basal ice conditions.

QUATERNARY STRATIGRAPHY OF THE GRAND FALLS AREA

Selected stratigraphic sections from the Grand Falls area are shown in Figure 2. The great thickness and nature of drift in this area were described by Lee (1959, 1961, 1962) and Kite (1979). Lee (1962) refers to the presence of a sub-till non-glacial gravel deposit in one of his boreholes (section C in Figure 2) located in a buried valley beneath the town of Grand Falls. However, there seems to be no mention in his report as to why he interpreted the gravel as non-glacial. Well exposed sections in the Falls Brook gully indeed show two distinctive sub-till gravel bodies, separated by a thin massive silt layer (section D in Figure 2). The lower gravel unit consists almost exclusively of local and angular gravel, with a high matrix content. Within the latter gravel unit a fairly continuous layer of laminated silt is present, locally containing dropstones, suggesting cold conditions. These lower gravels are tentatively correlated with Lee's "non-glacial" gravels, with the implication that at present no definite evidence can be presented as to their origin.

Clasts in the upper sub-till gravel of section D are well rounded and have a more variable lithology. Gravels apparently correlative with this unit are found exposed at many sites in the Saint John River valley, north as well as south of Grand Falls. They are generally covered by a gray and/or yellow till with a north-south fabric. In the Salmon River valley, as well, till with a north-south fabric overlies gravels at several places. On the plateaus bordering the Salmon River valley, however, the surface till exhibits a southeast-northwest fabric, paralleling the southeast ice movement. The relative chronology of these two ice movements is not yet clear.

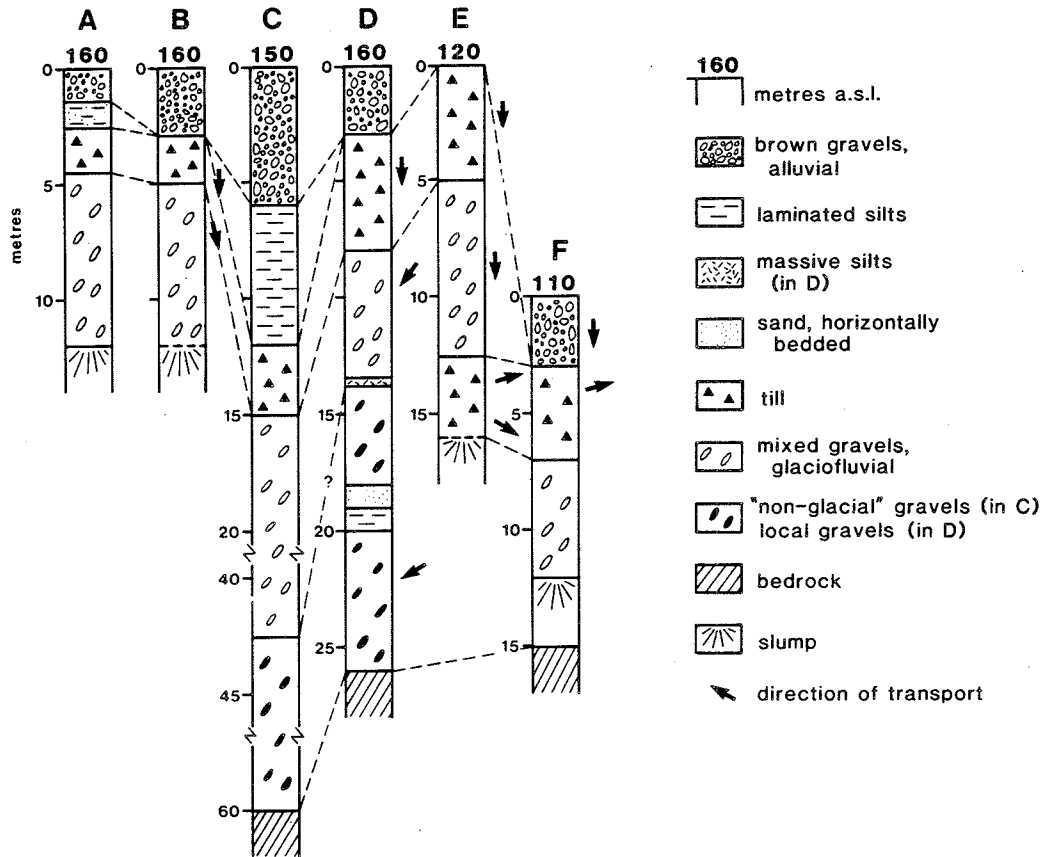

Figure 2. Stratigraphic sections along the St. John River in the area of Grand Falls. For locations see Figure 1. Section C is taken from Lee (1962), and represents the sedimentary sequence in his borehole no. 2. Section E is the same as that described by Rampton and Paradis (1981: location 6 in Figure 11).

Although Rampton and others (1984) indicate at least seven multiple-till sections in the area south of Grand Falls, only one site was found where two tills are separated by a significant amount of stratified gravels (section E in Figure 2). At that section, till with a north-south fabric overlies about 8 m of gravel, which in turn overlies a lower till with an east-west fabric. Exposures along the opposite riverbank show that the lower till also overlies gravel (section F in Figure 2). Although the principal eigenvectors of the lower till dip towards the east, an eastward ice movement is suggested by the absence of indicators from the Mississippian redbeds around Plaster Rock. An east-west fabric was also recorded throughout a 10.m-thick till section exposed in a gully along the Salmon River (Figure 1). Here, strong imbrication, especially in the lower part of the till, indicates ice movement towards the east.

If the lower till south of Grand Falls can be correlated with the lower till at Edmundston, and with possible other subsurface tills in northern Maine (Newman and others, 1985), then the presence of the inter-till gravels suggests a regional deglaciation. Rampton and others (1984) suggest a possible pre-Wisconsinan age for the lower till, while Newman and others (1985) speak of a pre-late Wisconsinan event, on account of the oxidized upper part of the lower till. However, this oxidation is not accompanied by intense weathering (e.g. decalcification), as would be expected in the case of a prolonged surface exposure. It is commonly observed that where porous gravels overlie till, the upper part of the till is oxidized: this is also true of the lower part of a till that overlies gravel. Such oxidation is a subsurface process, and cannot be taken as an indicator of age. In the absence of other evidence, the lower till could be as young as Late Wisconsinan.

The origin of the thick sub-till gravel deposits around Grand Falls remains problematic. Such an accumulation requires a raised base level, due either to blocking of the valley by ice, or to a high relative sea level. The solution to this problem may come from detailed sedimentological analysis, because the geomorphological evidence has been destroyed by the subsequent overriding by ice from the north.

ACKNOWLEDGMENTS

Fieldwork was carried out under the Canada-New Brunswick Mineral Development Agreement 1984-1989 as part of Geological Survey of Canada Project 690095, while the author was holding a postdoctoral visiting fellowship in Canadian government laboratories. M. Lamothe and W. W. Shilts made numerous helpful suggestions for improving the manuscript.

REFERENCES

- Chauvin, L., Martineau, G., and LaSalle, P., 1985, Deglaciation of the Lower St. Lawrence region, in Borns, H. W., Jr., LaSalle, P., and Thompson, W. B., eds., Late Pleistocene history of northeastern New England and adjacent Quebec: Geological Society of America, Special Paper 197, p. 111-123.
- David, P. P., and Lebuis, J., 1985, Glacial maximum and deglaciation of western Gaspé, Quebec, Canada, in Borns, H. W., Jr., LaSalle, P., and Thompson, W. B., eds., Late Pleistocene history of northeastern New England and adjacent Quebec: Geological Society of America, Special Paper 197, p. 85-109.
- Gadd, N. R., McDonald, B. C., and Shilts, W. W., 1972, Deglaciation of southern Quebec: Geological Survey of Canada, Paper 17-47, 19 p.
- Gauthier, R. C., 1980, Existence of a central New Brunswick ice cap based on evidence of northwestward-moving ice in the Edmundston area, New Brunswick, in Current Research, Part A: Geological Survey of Canada, Paper 80-1A, p. 377-378.
- _____, 1982, Surficial deposits, northern New Brunswick: Geological Survey of Canada, Open File 856.
- _____, 1983, Surficial materials of northern New Brunswick: Geological Survey of Canada, Open File 963.
- Genes, A. N., Newman, W. A., and Brewer, T., 1981, Late Wisconsinan glaciation models of northern Maine and adjacent Canada: Quaternary Research, v. 16, p. 48-65.
- Kite, J. S., 1979, Postglacial geologic history of the middle St. John River valley: M.S. thesis, University of Maine, Orono.
- Kite, J. S., and Lowell, T. V., 1982, Quaternary geology of the Upper St. John River basin, in Thibault, J., ed., Guidebook for the 1982 NBQUA field trip: p. 3-16.
- Lamarche, R. Y., 1971, Northward moving ice in the Thetford Mines area of southern Quebec: American Journal of Science, v. 271, p. 383-388.
- Lee, H. A., 1959, Surficial geology of Grand Falls, Madawaska and Victoria Counties, New Brunswick: Geological Survey of Canada, Map 24-1959.
- _____, 1961, Boreholes at Grand Falls, New Brunswick, across a buried channel of ancestral St. John River: Geological Survey of Canada, Topical Report 33, 16 p.
- _____, 1962, Boreholes at Grand Falls, New Brunswick, across a buried channel of ancestral St. John River; Part B: Geological Survey of Canada, Topical Report 59, 18 p.

- Lowell, T. V., 1985; Late Wisconsinan ice flow reversal and deglaciation, northwestern Maine, *in* Borns, H. W., Jr., LaSalle, P., and Thompson, W. B., eds., Late Pleistocene history of northeastern New England and adjacent Quebec: Geological Society of America, Special Paper 197, p. 71-83.
- Mark, D. M., 1973, Analysis of axial orientation data, including till fabrics: Geological Society of America, Bulletin, v. 84, p. 1369-1374.
- Martineau, G., 1979, Geologie des depots meubles de la region de Temiscouata: Ministere des Richesse naturelle du Quebec, DPV-618, 18 p.
- Newman, W. A., Genes, A. N., and Brewer, T., 1985, Pleistocene geology of northeastern Maine, *in* Borns, H. W., Jr., LaSalle, P., and Thompson, W. B., eds., Late Pleistocene history of northeastern New England and adjacent Quebec: Geological Society of America, Special Paper 197, p. 59-70.
- Prest, V. K., 1983, Canada's heritage of glacial features: Geological Survey of Canada, Miscellaneous Report 28, 119 p.
- Rampton, V. N., Gauthier, R. C., Thibault, J., and Seaman, A. A., 1984, Quaternary geology of New Brunswick: Geological Survey of Canada, Memoir 416, 77 p. and map.
- Rampton, V. N., and Paradis, S., 1981, Quaternary geology of Woodstock map area (21J), New Brunswick: New Brunswick Department of Natural Resources, Map Report 81-1, 37 p.
- Shilts, W. W., 1981, Surficial geology of the Lac Megantic area, Quebec: Geological Survey of Canada, Memoir 397, 102 p.
- Thibault, J., 1979, Granular aggregate resources of the Grandmaison (N.T.S. 21N/9) and the Edmundston (N.T.S. 21N/8) map areas: New Brunswick Department of Natural Resources, Mineral Resources Branch, Open File 79-31, 115 p.
- _____, 1980, Granular aggregate resources, Saint-Andre (210/4), Aroostook (21J/13) New Brunswick: New Brunswick Department of Natural Resources, Mineral Resources Branch, Open File 80-6, 27 p.
- _____, 1985, Granular aggregate resources and surficial geology of Sisson Branch Reservoir (210/6): New Brunswick Department of Natural Resources, Mineral Resources Branch, Open File 85-3, 46 p.
- Woodcock, N. H., and Naylor, M. A., 1983, Randomness testing in three-dimensional orientation data: Journal of Structural Geology, v. 5, p. 539-548.

POSTGLACIAL HISTORY OF THE UPPER ST. JOHN DRAINAGE BASIN

J. Steven Kite
Department of Geology and Geography
West Virginia University
Morgantown, WV 26506

and

Robert Stuckenrath
Radiocarbon Laboratory
Radiation Biology Laboratory
Smithsonian Institution
Rockville, MD 20852

INTRODUCTION

From our geographic perspective, south of the glacial margin, it is curious to compare the considerable effort expended in the Northeast by surficial geologists studying the deposits and landforms developed during the few thousand years of deglaciation, versus the meager effort devoted to the geology of streams and lakes over the much longer postglacial interval. Admittedly, glacial landforms and deposits dominate the surficial geology of New England and Atlantic Canada, but this dominance is no excuse for ignoring the varied, widespread array of postglacial deposits and the complex geological history that they represent. Generally, postglacial geology has been left to palynologists and marine geologists. Except for southernmost New England (Patten, 1981), the few comprehensive alluvial studies in the region have focused on river sequences controlled by base level fluctuations, such as changes in sea or lake level (Dionne, 1985; Beblowski, 1981), sequences that give little insight as to what happened along streams in the interior.

The purpose of this paper is to point out the significant changes in the lakes and streams of the upper St. John River basin (Figure 1) since deglaciation. We anticipate that comparably rich postglacial histories are recorded in other upland basins located in northern New England and neighboring Canada, although these chronologies may be very different from that recorded on the St. John.

POSTGLACIAL DEPOSITS

Postglacial deposits of the valley bottoms in the upper St. John River basin are dominated by fine-grained and coarse-grained lacustrine sediments, various alluvial deposits, organic deposits, and colluvial diamictons. We have not studied colluvial diamictons in detail, although these deposits deserve more attention.

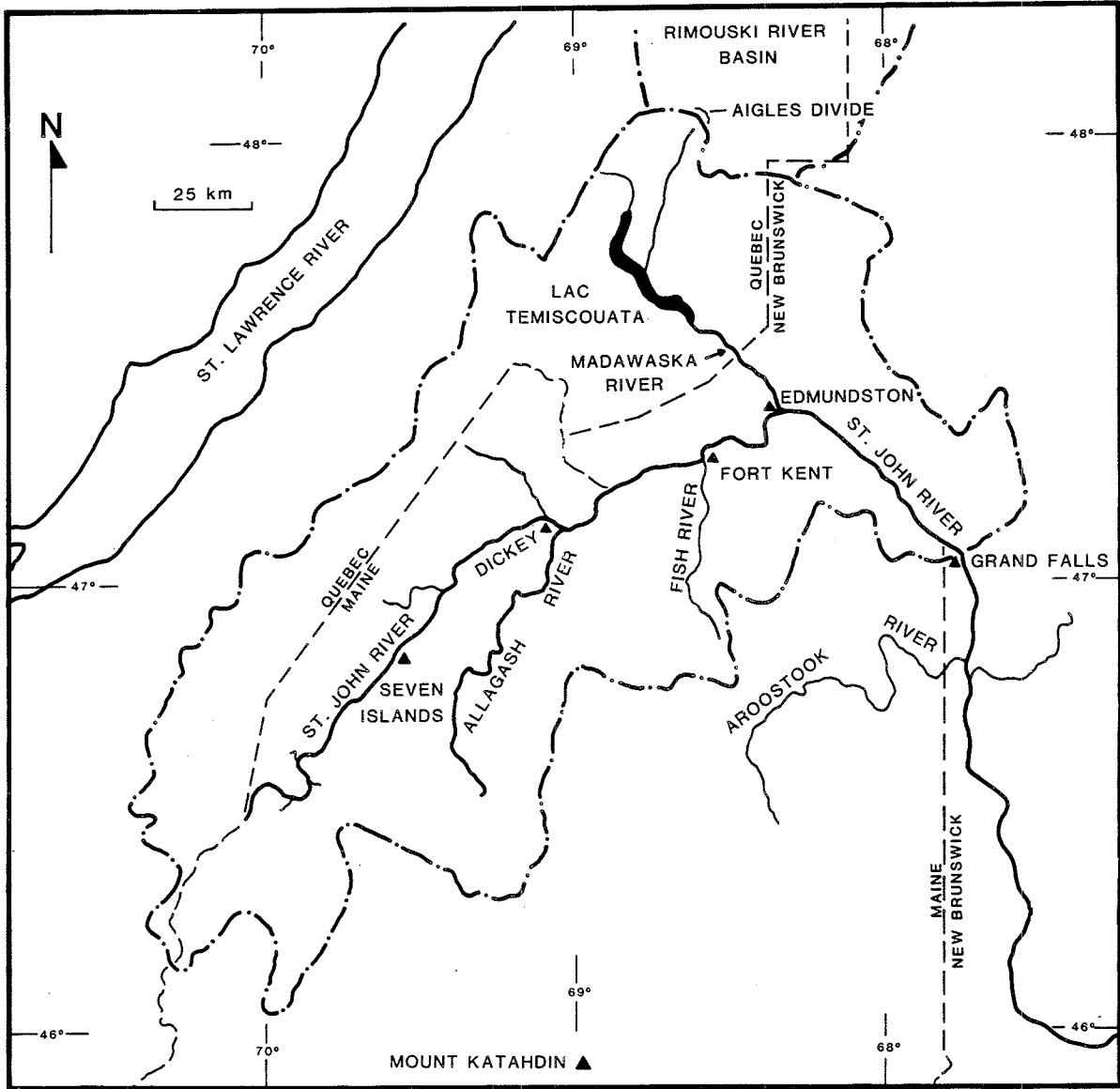

Figure 1. Selected localities in the upper St. John River basin. This study has involved considerable field work in New Brunswick between Grand Falls and Edmundston, but most other detailed work has been in Maine.

Lacustrine deposits

Many exposures of lacustrine silt occur in the upper St. John basin. Generally, this silt is gray, virtually unfossiliferous, and displays 0.2 to 3.0 cm-thick rhythmic bedding. Total thicknesses of 30 m have been reported in wells and boreholes (Prescott, 1971), but outcrops of lacustrine silt are less than 10 m thick. Although lacustrine silt occurs below diamictons interpreted as till at a few localities, a conformable contact with overlying postglacial peat or alluvium occurs at many other localities (e.g. Kite and Borns, 1980, Stops 5 and 11; Kite and others, 1982, Stop 1-5). Thus, although some of the exposed lacustrine silt has been overrun by one or more glaciers, most is postglacial in age.

Coarse-grained lacustrine deposits are not common in the upper St. John River basin. Most mapped deltas are at high levels and suggest meltwater deposition in ice-dammed lakes. Low-level deltas deposited in nonglacial lakes are difficult to distinguish from other alluvial terraces and commonly have been modified by subsequent fluvial erosion and deposition. Small emerged beach deposits consisting of pebbles and sand have been used to reconstruct lake levels in agricultural areas (Kiewiet de Jonge, 1951; Kite 1979), but the beach deposits are too small to be mapped in most of the heavily forested study area.

Alluvial deposits

The nature of alluvium along the St. John River depends upon the type of material from which it is derived, and upon the alluvial facies in which it is deposited. Most upland alluvium is angular channel lag gravel or poorly rounded transitory channel gravel. Commonly, deposition of silt and sand matrix between the boulders and cobbles of these deposits produces a diamicton that is difficult to distinguish from some glacial diamictons. Many large boulders show river-ice abrasion marks; some are transported by ice push during spring-melt floods.

Different alluvial facies are best developed where stream gradients are low and floodplains are wide. The greatest variety of alluvial deposits occurs in the St. John Valley between Edmundston and Grand Falls (Figure 1), where three facies dominate the floodplain stratigraphy: river-channel gravel, channel-fill silt, and overbank silt and sand. All three facies have yielded material for radiocarbon dating, so the alluvial chronology of this 60 km-long reach is much better known than the rest of the basin. Old channel deposits are somewhat finer grained than adjacent modern-day channel alluvium on the St. John River between Edmundston and Grand Falls, but tributary channel alluvium appears not to have varied in particle size with time. The best-exposed alluvial unit is gray channel-fill silt, which commonly occurs in nearly vertical stream banks. This silt appears very similar to lacustrine silt, except for abundant plant fragments, common bivalve shells, and much more poorly expressed bedding in the channel-fill silt. In low-lying areas and where high water tables promote preservation, overbank alluvium includes abundant wood fragments and thin organic lenses. Reverse-graded bedding is common in both modern-day and older overbank alluvium; this sedimentary structure may be produced by the increasing flow velocity that coincides with falling stage during ice-jam break-up events.

Organic deposits

Peat deposits are best developed in swamps ringing large lakes, and in small upland basins. Two buried peat beds are exposed between lacustrine and alluvial units in the Edmundston-Grand Falls area. Peat lenses and reworked peat clasts are known from terrace and floodplain deposits in the same area.

RADIOCARBON DATES

Thirty-six radiocarbon dates obtained in this research project, and seven dates reported in previous works, allow assignment of absolute ages to postglacial events in the upper St. John River basin (Table 1). Locations and descriptions of each date are given in Kite (1983). At least nine dates should be disregarded as inaccurate. Two dates from lacustrine sediments appear much too old, either because of the inclusion of old reworked organic matter or because of the old-carbon effect in carbonate landscapes. Two dates on charred wood associated with a lacustrine beach gave ages that were 4,000 to 7,500 years younger than dates obtained from the top of a nearby lacustrine sequence. The two dates are not internally consistent, and the charred wood may be intrusive.

Reworking of wood and other organic matter on the floodplain is the most likely reason that dates on samples from a single overbank horizon disagree by as much as 4,500 years (e.g. SI-3901A vs. SI-3703; discussed in Kite and Borns, 1980, Stop 11). We believe that at least five dates obtained from overbank deposits are inaccurate because of reworking. Wood fragments derived from organic beds and lenses in the valley-bottom stratigraphy are being reworked by modern streams up to 10,000 years after initial deposition, so it is not surprising to see organic matter of various ages in older alluvial deposits. Our experience suggests that fine-grained organic stringers appear to yield more reliable dates from alluvial deposits than do large wood fragments, because fine organic matter is less likely to survive reworking.

LATE-GLACIAL AND EARLY HOLOCENE LAKES

As discussed elsewhere in this volume, the pattern and style of deglaciation created large lakes on the landscape that is now the upper St. John drainage basin. These lakes were dammed by a disintegrating ice cap to the east and south and by mountains to the northwest. Field reconnaissance and topographic map study suggest that these lakes emptied into the St. Lawrence River basin through modern-day drainage divides, such as the 14 km-long trough between the headwaters of Riviere des Aigles, a tributary to the St. John River, and Riviere du Grand Touladi, a tributary of the Rimouski River. This divide will be called the Aigles divide in this paper (Figure 1; see Canadian Lac des Bais 1:50,000 topographic map 22 C/2).

As the glacial ice cover dissipated, lower outlets opened and drainage shifted progressively to valleys that are now occupied by modern-day

TABLE 1. Radiocarbon dates from the upper St. John drainage basin, after Kite (1983). * marks dates believed to be inaccurate. All dates are on alluvial materials from the St. John River except as noted.

DATES ASSOCIATED WITH LACUSTRINE DEPOSITS:

Date (yr B.P.)	Lab No.	Source of Dated Material
*21,560 ± 480	SI-4295	calcareous concretions in lake silt
*12,160 ± 150	SI-3899	base of peat over Lake Madawaska silts
10,220 ± 350	I(GSC)-2	base of peat over Lake Madawaska silts
10,140 ± 150	GSC-5	base of peat over Lake Madawaska silts
10,070 ± 75	SI-3701	top of Lake Madawaska silts
9,720 ± 70	SI-3702	base of peat over Lake Madawaska silts
9,720 ± 70	SI-3705	base of peat over Lake Madawaska silts
9,665 ± 75	SI-3899A	peat over lake silts; rerun of SI-3899
9,450 ± 350	W-2927	peat over Lake Madawaska silts
*5,585 ± 285	SI-5352A	silty clay under Lake Madawaska beach
*2,460 ± 130	SI-5352B	silty clay under Lake Madawaska beach
1,415 ± 40	SI-4726	unconformable (?) peat over lake silts
1,290 ± 40	SI-4725	unconformable (?) peat over lake silts
1,275 ± 40	SI-4724	unconformable (?) peat over lake silts

DATES ASSOCIATED WITH CHANNEL-FILL ALLUVIUM:

Date (yr B.P.)	Lab No.	Source of Dated Material
10,075 ± 110	SI-5356	near base of channel fill: Grand River
9,830 ± 100	SI-5748	near base of channel fill
9,830 ± 160	GSC-56	near base of channel fill
9,820 ± 130	GSC-18	near base of channel fill
9,450 ± 80	SI-5746	near base of channel fill
8,645 ± 80	SI-5755	near base of channel fill
8,250 ± 200	W-353	near base of channel fill
8,200 ± 300	L-190B	near base of channel fill: Grand River
7,775 ± 85	SI-5745	near base of channel fill
7,375 ± 65	SI-5744	channel fill, 25 cm above SI-5745
7,290 ± 80	SI-5747	channel fill, 115 cm above W-353
2,930 ± 80	SI-5355	near base of channel fill: Aroostook River
1,405 ± 35	SI-5756	near base of channel fill
104% modern	SI-4723	near base of channel fill: Little Black Ri.

DATES ASSOCIATED WITH OVERBANK ALLUVIUM:

Date (yr B.P.)	Lab No.	Source of Dated Material
9,285 ± 70	SI-3706	peat below alluvium contact: Green River
8,855 ± 65	SI-3704	peat below alluvium contact
*8,770 ± 100	SI-3901A	highest terrace, rerun of SI-3901
*8,055 ± 120	SI-5752	eroded terrace, same bed as SI-5751
*6,160 ± 85	SI-3900	highest terrace, resample of SI-3703
*6,080 ± 70	SI-5751	eroded terrace, same bed as SI-5752
*5,795 ± 70	SI-3901	highest terrace, 10 cm below SI-3703
5,345 ± 80	SI-5750	eroded terrace, below SI-5752 and -5751
4,890 ± 55	SI-5754	highest terrace
4,250 ± 50	SI-3703	highest terrace, same bed as SI-3900
2,360 ± 85	SI-5749	highest terrace
2,155 ± 75	SI-4727	highest terrace, assoc. with archaeol. site
815 ± 60	SI-5354	buried soil in highest terrace
101% modern	SI-5757	modern floodplain, 1.2 m below surface
104% modern	SI-5354A	buried modern soil, above SI-5354

streams. However, the development of southeastward drainage out of the upper St. John basin may have been retarded by cross-valley drift dams left after deglaciation. Moreover, because the Laurentide Ice Sheet remained within 100 km of the upper St. John headwaters until nearly 10,000 yr B.P. (LaSalle and others, 1977), isostatic depression was greater in the northwestern headwaters of the basin than in downstream reaches. Interpolation of published regional isobase reconstructions (Andrews and Tyler, 1977, p. 394-395) indicates that the Aigles divide may have been depressed lower than southeastward outlets, such as the highest alluvial surfaces at Grand Falls (Figures 2 and 3). Although these isobase reconstructions do not have the precision required for detailed drainage reconstruction, they do suggest the possibility that much of the upper St. John drainage emptied into the St. Lawrence drainage basin, even after most of the area became ice free.

Lake Madawaska, the largest lake documented in the upper St. John drainage basin (Kiewiet de Jonge, 1951; Lee, 1959; Kite, 1979, 1983) extended 130 km from Grand Falls to beyond Lac Temiscouata, Quebec (Figure 4). One radiocarbon date (10,000 \pm 75 yr B.P.: SI-3701) obtained from the uppermost sediments of Lake Madawaska, and six dates (9,450 \pm 350 yr B.P. to 10,220 \pm 350 yr B.P.) obtained from peat overlying these lacustrine sediments, show that the lake persisted until approximately 10,000 B.P. This may have been over 1,000 years after glacial ice dams disappeared from the upper St. John basin (Davis and Jacobson, 1985); this interpretation is consistent with the 1,200 rhythmites (varves?) estimated at one Lake Madawaska silt exposure (Kite, 1979).

A thick drift accumulation in the ancestral St. John River valley at Grand Falls (Lee, 1959, 1961, 1962) may have dammed Lake Madawaska after the break up of glacial ice in the basin. If the regional isobase reconstructions are correct, and the Aigles divide was lower than the highest fluvial surface at Grand Falls until after 10,000 yr B.P. (Figure 3), then the upper St. John River would have flowed northwest from Edmundston to Lac Temiscouata, opposite the modern-day flow of the Madawaska River. By contrast, streams eroding the drift at Grand Falls would have been small and ineffective. Kiewiet de Jonge (1951, p. 100) and Lougee (1954, p. 38-42) reported northwest-dipping beds in a broad terrace in the Madawaska River valley, which Kiewiet de Jonge called the Madawaska sand plain. It is possible that the Madawaska sand plain was formed by a northwest-flowing St. John River before isostatic adjustments allowed overtopping of the Grand Falls drift dam and initiation of southeastward drainage.

Other hypotheses for the origin of the Madawaska sand plain must be considered. Apparently unaware of the Aigles outlet, Kiewiet de Jonge (1951) and Lougee (1954) suggested that the northwestward flow drained into an enclosed "Salton Basin". It is also possible that the Madawaska sand plain represents a 34 km-long slackwater deposit derived from floods on the St. John (Kite, 1983), similar to deltaic sediments deposited in Maine's Lobster Lake when floods on the West Branch cause temporary flow reversals (Caldwell and others, 1985). Unfortunately, we have no radiocarbon dates from the Madawaska sand plain to determine which of these origins is the most likely. Careful examination of Figure 3 reveals that the Madawaska

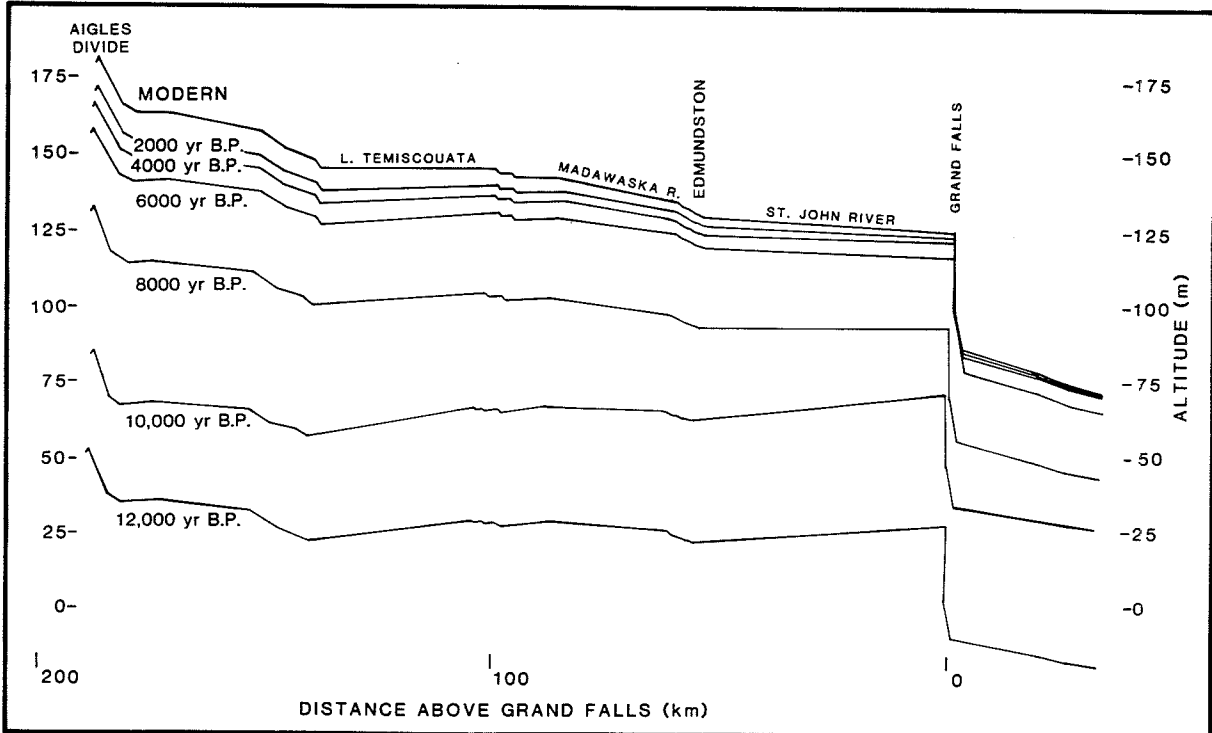

Figure 2. Stream profile reconstructions: Grand Falls to the Aigles divide, based on Andrews and Tyler (1977, p. 394-395). Although considerable rebound occurred between 12,000 and 10,000 B.P., the maximum differential rebound along this transect occurred between 10,000 and 8,000 B.P. Regional isobase reconstructions by Quinlan and Beaumont (1982, p. 2244) show similar patterns, but are not used here because they are based on fewer data collected near the upper St. John River basin.

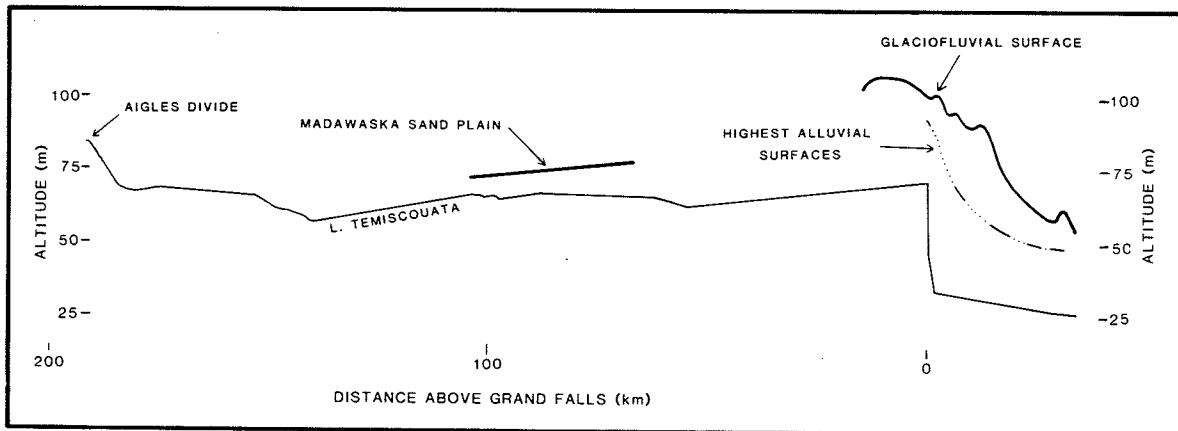

Figure 3. Stream-profile reconstruction for the St. John River from Grand Falls to the Aigles divide at 10,000 B.P. Profile is same as shown in Figure 2, but several important landforms have been added.

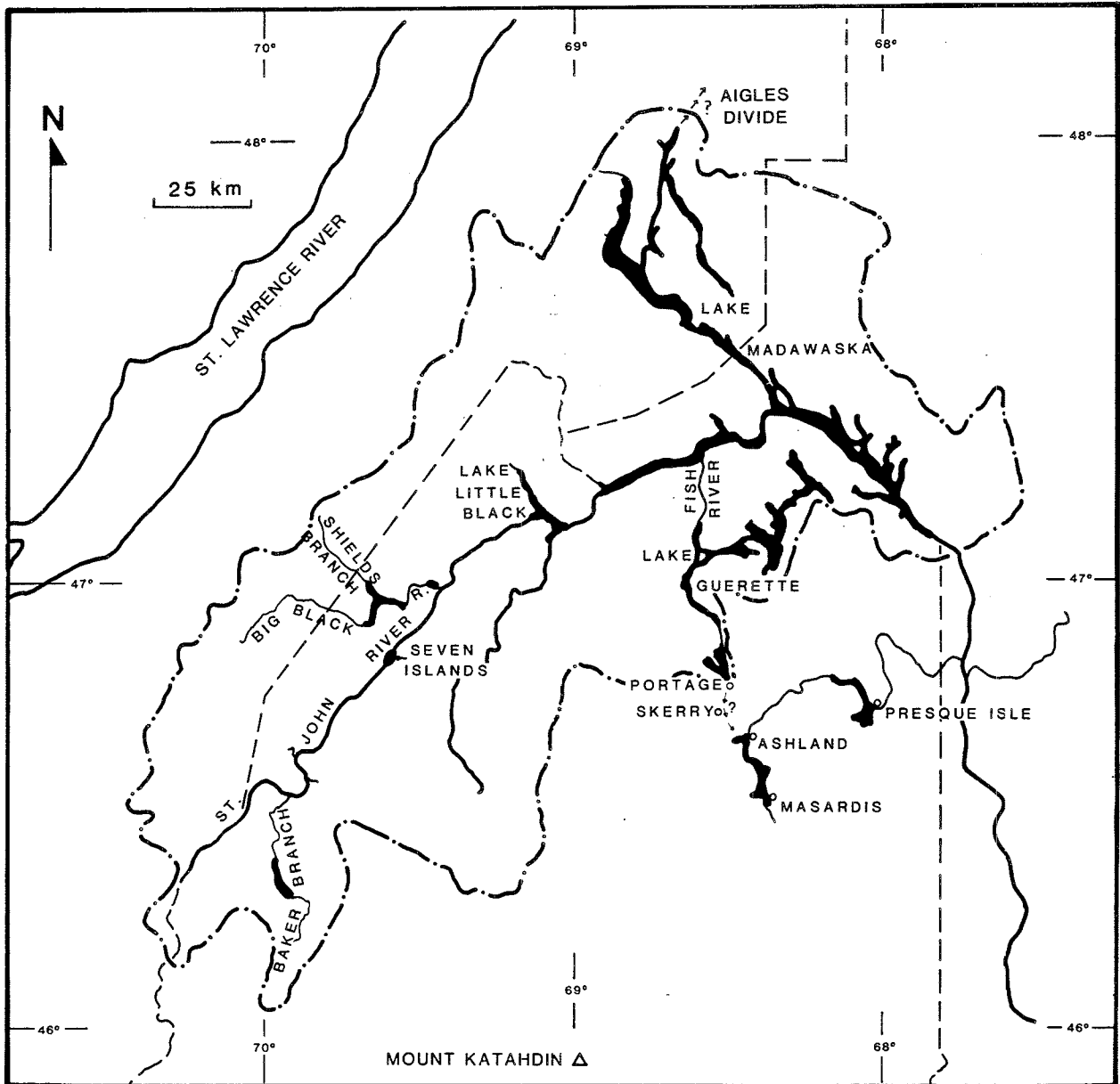

Figure 4. Possible drift-dammed lakes in, or near, the upper St. John River basin. Outcrops of lacustrine silts have been found for each of these lakes.

sand plain may have been graded to a level below the probable altitude of the Aigles divide, supporting the "Salton Basin" or the slackwater hypotheses.

It is difficult to assess how rapidly Lake Madawaska met its demise based on radiocarbon dates from only two localities. However, it is significant that samples representing the transition from lacustrine deposition to peat accumulation at both localities yielded essentially the same radiocarbon age: approximately 10,000 yr B.P., even though the localities are 15 km apart and 8.5 m different in altitude. If most of the upper St. John basin drained through the Aigles divide before 10,000 yr B.P., then one could speculate that Lake Madawaska rapidly disappeared after isostatic adjustments allowed southeastward flow of the St. John River to erode the Grand Falls drift dam.

Other possible reasons why the lake might have met a rapid demise at 10,000 yr B.P. include melting of ice cores within cross-valley drift dams, and changes in hydrology caused by climatic change. Pollen analyses show the plausibility of both causes. Rapid warming between 11,000 and 10,000 yr B.P. (Davis and Jacobson, 1985) may have caused melting of buried glacial ice. Davis and Jacobson (1985) show that this warming produced a shift from tundra vegetation throughout northernmost Maine at 11,000 yr B.P. to a nearly continuous forest by 9,000 yr B.P. High-discharge floods are rare in Canada's modern tundra environments, largely because moist maritime tropical air masses seldom extend that far north. It is possible that the tundra in Maine developed under very different climatic conditions, but if modern tundra streams can serve as analogs, then streams in the upper St. John basin probably lacked sufficient energy to erode large drift dams until after the warming episode.

Efforts to obtain other dates from exposures of lacustrine deposits have not been very successful, largely because of the scarcity of organic matter in the lacustrine sediments. Two samples of charred organic matter from a Lake Madawaska beach deposit gave dates 4,100 and 7,200 years younger than the end of lacustrine deposition as indicated by dates on the peat/lacustrine contact at lower levels. The two dates were taken from shallow samples which may have been intrusive or contaminated by root penetration and organic-matter translocation over thousands of years. T. V. Lowell collected calcareous concretions from silt deposited in Lake Little Black, near Dickey (Figure 4), which yielded an age determination of $21,560 \pm 480$ yr B.P. (SI-4295). These age determinations may not have any bearing on the age of the lake sediments because of old carbon derived from either glacial meltwater, calcareous lake sediments, or bedrock. Near Seven Islands (Figure 4), the base of a 0.5 m-thick peat overlying lacustrine silt yielded three dates between 1,275 and 1,415 yr B.P. Although the three dates are internally consistent, there may have been a significant hiatus before peat accumulation.

Although we have not obtained a clear radiocarbon chronology for the lacustrine sequences other than Lake Madawaska, we hypothesize that some, if not most, of these lakes also lasted until after deglaciation. This hypothesis is based on observations that sediments in other lake sequences are similar to those of Lake Madawaska, and that all of these lacustrine

sequences occur upstream from extensive cross-valley drift accumulations that could have served as dams after glacial ice melted from the landscape. Lacustrine silt in the Little Black River valley includes over 1,000 rhythmic beds. If these beds are true annual varves, then the longevity of the lake makes it more likely that it, like Lake Madawaska, extended into postglacial time.

HOLOCENE ALLUVIAL EVENTS

A time-distribution graph of radiocarbon dates from fine-grained channel-fill deposits exposed on the banks of the St. John River show that most were formed in an episode of channel migration between 10,075 and 7,700 yr B.P. (Figure 5). All of these early Holocene channel-fill dates were obtained on samples collected between Edmundston and Grand Falls. The dates suggest that the St. John's channel migrated laterally because it was developing a meander belt on the fine-grained former lake bottom. Climatic changes that occurred approximately 10,000 years ago could have contributed to channel migration by increasing discharge, which increased the energy throughout the whole fluvial system. Isostatic rebound was probably another contributing factor; the published regional reconstructions suggest that differential warping of the upper St. John River basin was greatest between 10,000 and 8,000 yr B.P. (Figure 2). In addition to possible rerouting of drainage, differential rebound would have increased gradients in southeast-flowing streams throughout the basin, therefore increasing flow velocities, stream power, and peak discharges throughout much of the basin.

Other studies in northeastern North America have reported significant changes in alluvial deposition at approximately 10,000 yr B.P. (Patten, 1981; Kirkland and Funk, 1979; Funk and others, 1983; Scully and Arnold, 1981). The general synchronicity of these events suggests that climatic controls may have been important. However, there are other possible causes for the early Holocene channel migration on the St. John between Edmundston and Grand Falls, so we prefer not to assign major significance to climatic factors acting in northern New England and adjacent Canada.

The deposition of floodplain alluvium was not immediate. At two different localities, dates from the top of a peat bed overlain by alluvium show that the poorly drained lacustrine silt supported a swamp for 500 to 1,000 years before alluvial deposition began on that part of the floodplain. This lag probably represents the amount of time required for the St. John and its tributaries to deliver enough alluvium to cause aggradation at these localities.

Overbank deposition dominated the middle Holocene. Seven samples of organic matter from overbank alluvium yielded radiocarbon dates between 8,770 and 4,250 yr B.P., but the dates are difficult to interpret because of probable reworking. The highest alluvial surface between Edmundston and Grand Falls has been called the Siegas terrace (Kite, 1979; Kite and Borns, 1980; Kite and others, 1982). Dates of $2,360 \pm 85$ yr B.P. (SI-5749) and 815 ± 60 yr B.P. (SI-5354) in the highest organic horizons at two different localities show that vertical accretion on the Siegas terrace continued into the late Holocene.

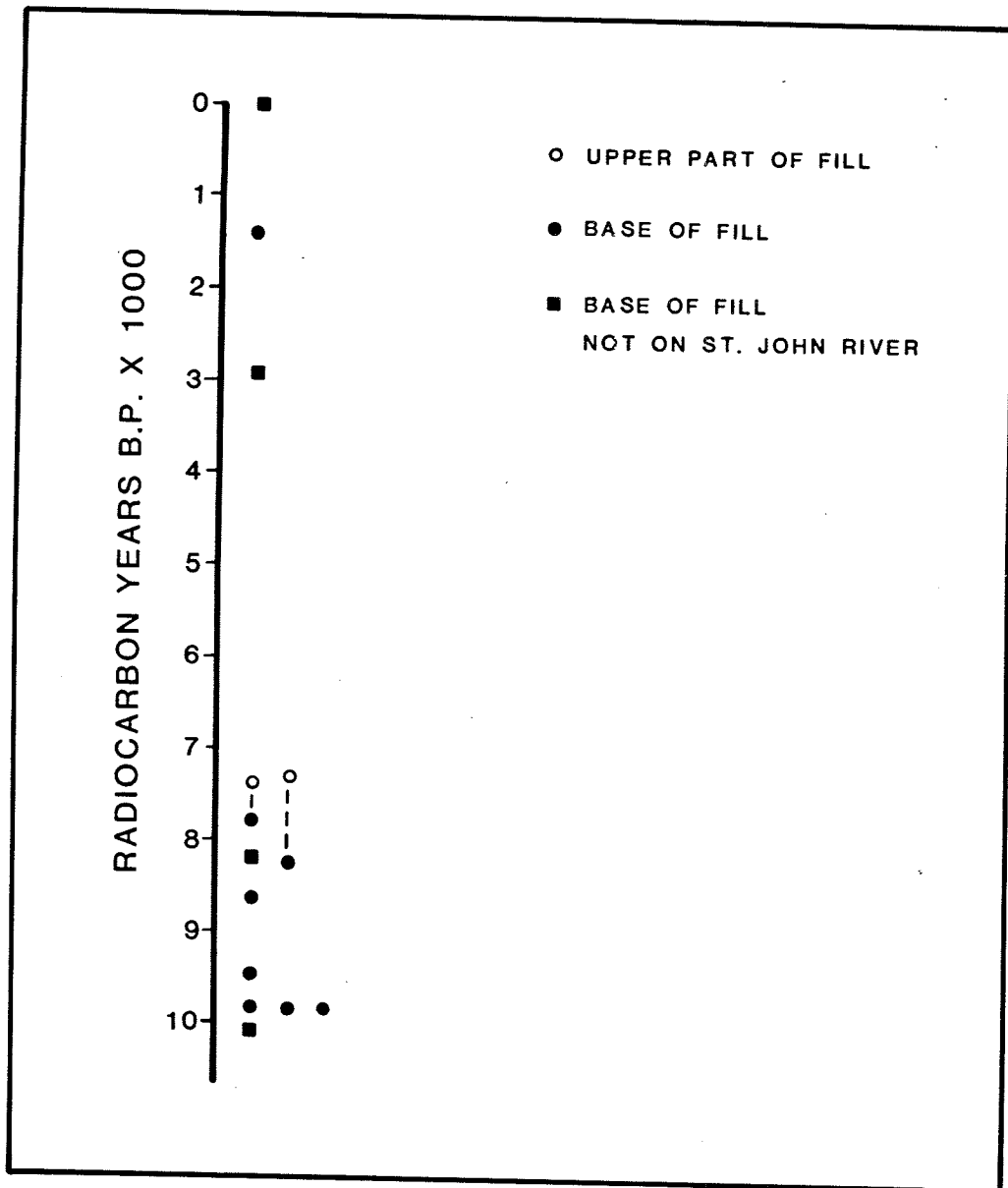

Figure 5. Radiocarbon dates obtained from channel-fill deposits. Dashed lines connect dates from individual channel-fill lenses.

Today, the Siegas terrace is 6 m higher than the greatest flood recorded on the St. John. Where not destroyed by plowing or other disturbance, the terrace shows well-developed Spodosol (Podzol) soil profiles, indicating that the terrace surface has not received significant overbank deposition in centuries.

Either or both of two hypotheses might explain why the terrace experienced deposition as recently as 800 yr B.P. but now appears to be abandoned. Firstly, it is possible that a flood, or floods, two or three times larger than the greatest of record occurred on a floodplain with a configuration similar to the modern floodplain (Kite, 1983, p. 204-211). Secondly, the terrace may represent a floodplain abandoned by recent incision, as suggested by the heights of dated channel-fill deposits above the modern river (Kite, 1983, p. 211-217). The second hypothesis suggests that major changes in the drainage system have occurred very recently and could continue in the near future. Indeed, the configuration of the bedrock threshold at Grand Falls is such that the river is eroding a rock surface that dips upstream. As the waterfall retreats, the threshold is lowered, prompting channel incision upstream from the falls. If the modern 25 m-high falls were to retreat 150 to 200 m, then it would no longer encounter bedrock in its channel, but would be located over the drift-filled ancestral St. John valley. A drift knickpoint would probably retreat upstream rapidly, triggering extensive erosion of the valley fill. Although the limited erosion observed by local residents may seem minor in one lifetime, it may be part of the onset of a major Holocene erosional event.

Channels may have migrated less during the middle Holocene than during the late Holocene. No abandoned channels have been dated between 7,700 yr B.P. and 3,000 yr B.P. Three channel-fills have yielded dates after 3,000 yr B.P., but only one of these dated channel-fill units occurred between Edmundston and Grand Falls. The late Holocene channel fills are much less common than similar early Holocene deposits. However, with so little data, it is difficult to assess whether the few late Holocene channel-fill deposits represent any more channel migration than occurred in the middle Holocene.

IMPLICATIONS FOR POSTGLACIAL EVENTS IN OTHER DRAINAGE BASINS

Major controls of the postglacial evolution of the upper St. John drainage basin probably were isostasy, climate, and intrinsic factors such as bedrock and glacial geology. We cannot accurately determine the relative importance of these controls, largely because they could have produced the same changes at the same time. Although many details of the upper St. John chronology remain unclear, especially middle and late Holocene events, we believe future work should focus on northward- or westward-flowing streams in which isostatic rebound should have decreased gradients and stream power around 10,000 yr B.P. If differential isostatic rebound were the dominant factor affecting drainage events, the history of these streams should be much different than that of the St. John River valley between Grand Falls and Edmundston.

Even if postglacial drainage events throughout the region were caused by one factor, such as climate, there is no guarantee that events were isochronous in different basins, or along different reaches of the same basin. Drainage systems are extremely diverse, particularly in glaciated landscapes underlain by a wide variety of bedrock and surficial materials. A stream's response to extrinsic and intrinsic change may be complex and lead to ambiguous associations between causes and effects. Postglacial events may be so complex that we will never be able to formulate generalizations that can be applied in all basins in the region.

SUMMARY

Some reaches of the St. John River valley have undergone significant changes since deglaciation. The largest postglacial lake identified in the study area, Lake Madawaska, persisted in the St. John valley until approximately 10,000 yr B.P.; other lakes in the basin may have had similarly long postglacial histories. It is possible that nearly all of the upper St. John drainage, including Lake Madawaska, drained northwest from Edmundston into the Madawaska River valley and into the Rimouski River through the Aigles divide, rather than along its modern-day southeastward path. This hypothesis needs to be tested by determining the age of northwest-dipping beds in the Madawaska River valley, by field examination of the Aigles divide, and by study of the alluvial landforms and deposits along the Riviere Grand Touladi and the Rimouski River to see if there is evidence of early postglacial discharges significantly greater than today's.

A Holocene alluvial chronology has been established for the St. John River valley between Edmundston and Grand Falls. Between 10,000 and 7,700 yr B.P. the St. John shifted over the old lake bed, creating most of the silty channel-fill lenses exposed today on river banks. Backswamp peats formed on higher parts of the old lake bottom, but were buried under alluvium within 500 to 1,000 years. During the middle Holocene, overbank deposition dominated the floodplain; no known channel-fill deposits date between 7,700 and 3,000 yr B.P. Floodplain accretion continued into the late Holocene, possibly after 800 yr B.P., creating the highest alluvial surface, the Siegas terrace. There is some evidence of incision and increased channel migration during the late Holocene, possibly because of erosion of the bedrock threshold at Grand Falls.

ACKNOWLEDGMENTS

This study has been supported by the Maine Geological Survey, the U.S. Army Corps of Engineers, a J. Hoover Mackin Grant from the Quaternary Geology and Geomorphology Division of the Geological Society of America, a Geological Society of America Research Grant, a grant from Sigma Xi, the Scientific Research Society of America, fellowships from the University of Maine at Orono and the University of Wisconsin at Madison, and summer field grants from the University of Wisconsin Department of Geology and Geophysics. This study has benefited from discussions with many Quaternary

scientists, but especially H. W. Borns, Jr., D. M. Mickelson, J. C. Knox, G. H. Denton, T. V. Lowell, R. Johnson, and P. Beblowski. This paper benefited from the thoughtful reviews of P. C. Patten, G. R. Brakenridge, H. W. Borns, Jr., and W. B. Thompson; however, any errors in interpretation are our own.

REFERENCES

- Andrews, J. T., and Tyler, K., 1977, The observed postglacial recovery of Quebec and Nouveau-Quebec since 12,000 B.P.: *Geographie physique et Quaternaire*, v. 31, p. 389-400.
- Beblowski, P. L., 1981, The geology of the Winooski site: a stratified middle Woodland site in northwestern Vermont: unpub. manuscript, 23 p.
- Caldwell, D. W., Bartholomae, G., Fitzgerald, D. M., and Belknap, D., 1985, Pleistocene and Holocene sedimentation in Lobster Lake, north-central Maine: *Geological Society of America, Abstracts with Programs* v. 17, no. 1, p. 9.
- Davis, R. B., and Jacobson, G. L., Jr., 1985, Late glacial and early Holocene landscapes in northern New England and adjacent areas of Canada: *Quaternary Research*, v. 23, p. 341-368.
- Dionne, J.-C., 1985, Observations sur le Quaternaire de la Riviere Boyer, cote sud de l'Estuaire du Saint Laurent, Quebec: *Geographie physique et Quaternaire*, v. 39, p. 35-46.
- Funk, R. E., Wellman, B., and Dineen, R. J., 1983, Early postglacial terrace formation and early Archaic sites in the upper Susquehanna valley: *Geological Society of America, Abstracts with Programs*, v. 15, p. 179.
- Genes, A. N., Newman, W. A., and Brewer, T., 1981, Late Wisconsinan glaciation models of northern Maine and adjacent Canada: *Quaternary Research*, v. 16, p. 48-65.
- Kiewiet De Jonge, E. J. C., 1951, Glacial water levels in the St. John River valley: Ph.D. dissertation, Clark University, Worcester, Mass., 116 p.
- Kirkland, J. T., and Funk, R. E., 1979, Archeological chronology and postglacial alluvial regimes in the upper Susquehanna River valley, New York: *Northeastern Geology*, v. 1, p. 60-68.
- Kite, J. S., 1979, Postglacial geologic history of the middle St. John River valley: M.S. thesis, University of Maine, Orono, 136 p.
- _____, 1983, Late Quaternary glacial, lacustrine, and alluvial geology of the upper St. John River basin, northern Maine and adjacent Canada: Ph.D. dissertation, University of Wisconsin, Madison, 339 p.
- Kite, J. S., and Borns, H. W., Jr., 1980, Late-glacial and Holocene geology of the middle St. John River valley: in Roy, D. C., and Naylor, R. S., eds., *New England Intercollegiate Geological Conference Guidebook for Field Trips in Northeastern Maine and Neighboring New Brunswick*, p. 213-231.

- Kite, J. S., and Lowell, T. V., 1982, Quaternary geology of the upper St. John River basin, in Thibault, J., ed., Quaternary studies in the upper St. John River basin, Maine and New Brunswick: Guidebook for the 1982 NBQUA field trip, August 18-20, 1982, New Brunswick Department of Natural Resources, p. 3-16.
- Kite, J. S., Lowell, T. V., and Nicholas, G. P., 1982, Itinerary, in Thibault, J., ed., Quaternary studies in the upper St. John River basin, Maine and New Brunswick: Guidebook for the 1982 NBQUA field trip, August 18-20, 1982, New Brunswick Department of Natural Resources, p. 24-52.
- LaSalle, P., Martineau, G., and Chauvin, L., 1977, Morphology, stratigraphy and deglaciation in Beauce-Notre Dame Mountains-Laurentide Park area: Ministère des Richesses Naturelles du Québec, DPV-516, 74 p.
- Lee, H. A., 1959, Surficial geology, Grand Falls, Madawaska and Victoria Counties, New Brunswick: Geological Survey of Canada, Map 34-1959, sheet 21 J/3.
- _____, 1961, Bore-holes at Grand Falls, N. B., across a buried channel of ancestral St. John River: Geological Survey of Canada, Topical Report no. 33, 16 p.
- _____, 1962, Part B, bore-holes at Grand Falls, N. B., across a buried channel of ancestral St. John River: Geological Survey of Canada, Topical Report no. 59, 18 p.
- Lougee, R. J., 1954, The role of upwarping in the post-glacial history of Canada: *Revue Canadienne de Géographie*, v. 8, p. 3-51.
- Nicholas, G. P., Kite, J. S., and Bonnicksen, R., 1981, Archeological survey and testing of late Pleistocene-early Holocene landforms in the Dickey-Lincoln School reservoir area, northern Maine: Institute for Quaternary Studies, Orono, Maine, 170 p.
- Patten, P. C., 1981, Geomorphic-hydrologic methods for assessing flood potential in southern New England: Department of the Interior, Office of Water Research and Technology, Technical Completion Report A-078-Conn, 29 p.
- Prescott, G. C., Jr., 1971, Lower St. John River area: records of selected water wells, springs and test holes in the lower St. John River valley: U.S. Geological Survey, Maine Basic Data Report no. 6, Ground-water Series, 22 p.
- Quinlan, G., and Beaumont, C., 1982, The deglaciation of Atlantic Canada as reconstructed from the postglacial relative sea-level record: *Canadian Journal of Earth Sciences*, v. 19, p. 2232-2246.
- Scully, R. W., and Arnold R. W., 1981, Holocene alluvial stratigraphy in the upper Susquehanna River basin, New York: *Quaternary Research*, v. 15, p. 327-344.

THE ARCHAEOLOGY OF THE UPPER ST. JOHN RIVER: OVERVIEW AND INTERPRETATION

George P. Nicholas
Department of Anthropology
University of Massachusetts
Amherst, MA 01003
and

American Indian Archaeological Institute
Washington, CT 06793

INTRODUCTION

There is growing evidence to suggest that the interior of Maine was the location of extensive and generally continuous human occupation from the late Pleistocene through the Holocene, a period of about 11,000 years. Traditionally, it has been the coastal region and the major river drainages of southern Maine that were proposed as the primary focus of prehistoric settlement. This view has been modified during the last ten years as more fieldwork has been conducted in central and northern interior Maine as the result of projects directed toward both research and cultural resource management. These projects have also led to an increase in the number of sites identified. The fact that much of this work has been interdisciplinary in nature makes it all the more valuable in studying the complex relationship between human populations and their environments. Recent fieldwork in the upper St. John River basin illustrates the need for the interactive development by various late Quaternary scientists of not only data recovery and interpretative methods, but new ideas about the processes of landscape development, and provides the basis for a brief discussion on how the dynamic landscapes of the late Pleistocene and Holocene affect prehistoric land-use patterns.

This paper addresses two complimentary aspects of the prehistory of the study area. The first is a brief overview of the prehistory of the upper St. John basin, and to a lesser degree of north-central Maine and adjacent Quebec. The second aspect concerns the interpretation of the archaeological record; this is done primarily through a discussion of two environmentally-based models that are being used to explain specific aspects of the prehistoric record elsewhere in the Northeast, and which can provide a baseline for future research in northern New England. Due to space limitations, this paper must remain more general than specific in orientation; detailed discussions of data, field methods, and interpretive models are referenced throughout the text (see also Sanger, 1979, and Snow, 1980, for overviews of northern New England prehistory). Such a general approach, however, allows non-archaeologists to become aware of some of the basic problems that archaeologists in northern interior Maine are currently

addressing, and to which they, as surficial geologists, paleoecologists, and other scientists, can make substantial contributions.

SUMMARY OF PREHISTORIC RESEARCH IN THE UPPER ST. JOHN BASIN

The greatest benefit of the long-controversial and now defunct Dickey-Lincoln School dam and reservoir project, which would have inundated much of the study area (Figure 1), appears to have been the amount of archaeological research it generated. With the exception of Moorehead's early survey of the basin (1922), almost all subsequent fieldwork on the upper St. John River has resulted from the environmental impact studies required during the planning of the Dickey-Lincoln reservoir project. The initial study of the proposed reservoir by Hadlock (1967, 1968) basically followed Moorehead's route, especially in the Big Black and Seven Islands area. Hadlock's conclusions concurred with those of Moorehead, namely that despite the difficulties of archaeological survey in the dense forest there was no evidence of substantial prehistoric settlement in the watershed.

The first systematic survey of the upper St. John basin was conducted by Sanger (1977, 1979) who succeeded in locating 37 prehistoric sites. On the basis of diagnostic materials recovered during this limited testing program, the major prehistoric utilization of the area was thought not to have occurred until after about 3,000 yr B.P. (Sanger, 1979, p. 89). The relatively low number of sites led to the formulation of a model of restricted utilization to explain the settlement pattern recorded. The primary hypothesis was that the basin was used irregularly, primarily as a travel route and for special activity (vs. base camp) uses, such as the procurement of certain types of resources at certain times of the year. Sanger (1979, p. 20) concluded that most of the sites along the upper St. John River were associated in some way with well-established prehistoric transportation routes that linked the St. John to the St. Lawrence, Kennebec, and Penobscot Rivers.

A subsequent survey and testing program was conducted in the area, and was directed specifically to late Pleistocene and early Holocene-age landforms (Nicholas and others, 1981). The development of predictive, early landform-directed survey methods and detailed paleoenvironmental models suggested that resource potential within former glacial lake basins within the area may have supported a more intensive early occupation of the area than had been expected by other researchers. The low number of early sites on the St. John was considered, in part, the result of widespread and substantial erosion of late-glacial and early Holocene landforms. Several high-terrace sites in the study area were identified, including a late Paleoindian/Early Archaic component at the Shields Branch Site (170-1) (Figure 1) (see Kite and others, 1982, p. 41-43).

Research in Adjacent Areas

A major research effort has been directed at the Munsungan Lake-Chase Lake area (Bonnichsen, 1982). This work has demonstrated about 8,000 years of occupation based on a sequence of yet-undated Paleoindian through

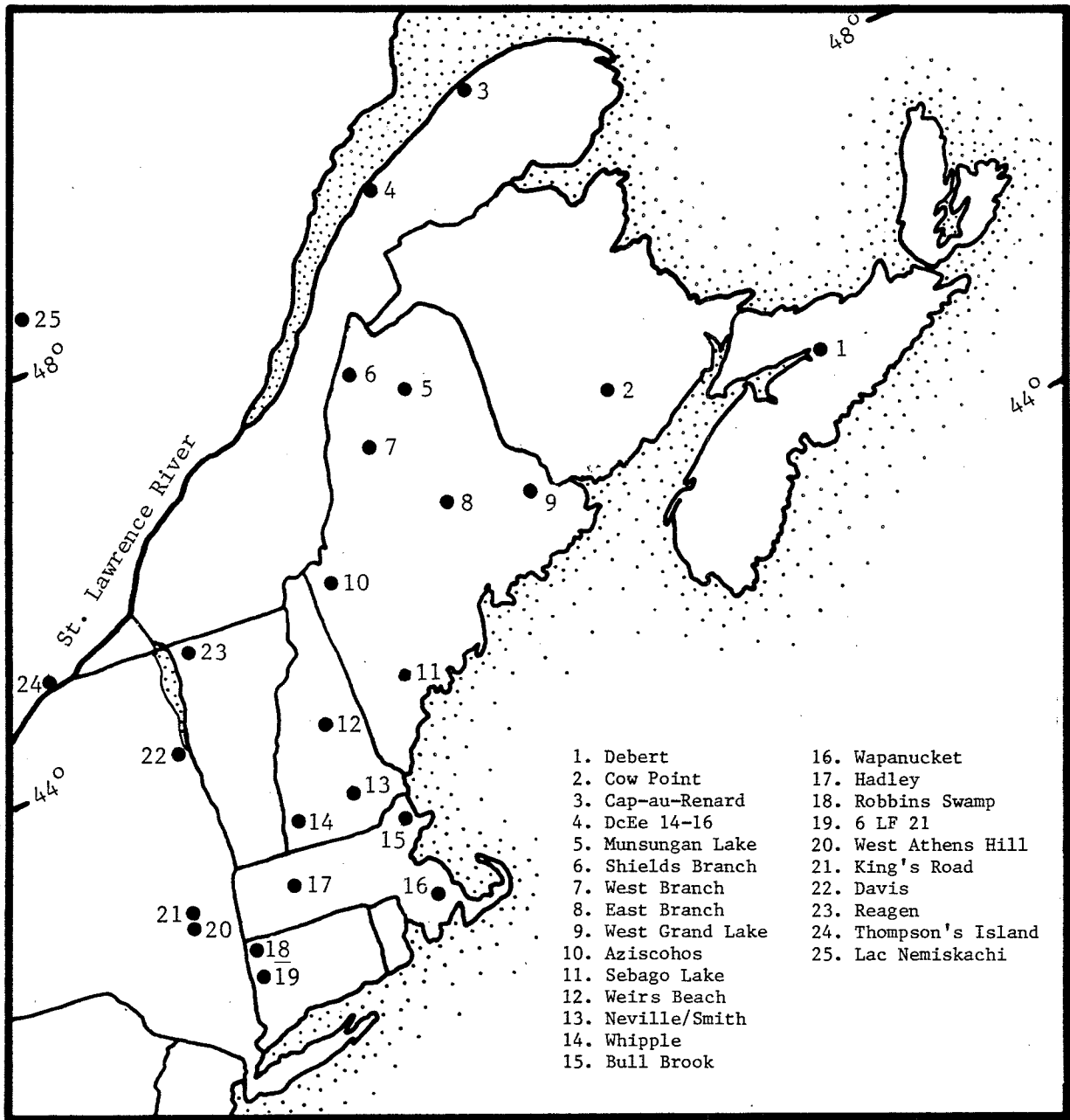

Figure 1. Selected early postglacial sites in the Northeast.

Ceramic component sites. In the area of the so-called "thoroughfare" between the two lakes, early through late sites are associated with high and low terraces, respectively, apparently representing either a step-wise lowering of lake levels, a series of kame terraces (R. Bonnicksen, pers. comm., 1986), or some combination thereof. Outcrops of high-quality Munsungan Lake Formation cherts and metasiltsstones are numerous in the area, and have been proposed as the major focus of human occupation and exploitation (Bonnicksen, 1982). Quarries and lithic workshops are associated with many, if not most, of the cultural periods identified to date in that area.

In 1981, a limited survey was conducted in the Bald Mountain area in the headwaters of the Aroostook and Fish River basins (Nicholas and Kite, 1981), located approximately between the upper St. John basin and Munsungan and Chase Lakes. The surficial geology of the Bald Mountain area indicates that the drainage has been relatively stable since deglaciation. Three sites that may represent a substantial time span were located in both upland and river terrace settings. All appear to represent small, special activity sites that may be related to larger base camps located elsewhere (e.g. Big Machias Lake site (164-33), where artifacts of similar material are present). What is of special interest is that the discovery of metasilstone outcrops at the Sukunka Quarry site (165-1) demonstrated that high-quality lithics were present 40 km to the northeast of the Munsungan Lake region, and that outcrops of this unit or of similar lithology (and of comparable or higher quality for tool manufacture) are probably common throughout the region.

One other project of interest to research in the upper St. John basin is a survey undertaken by Sanger in 1982 along the Aroostook River near Ashland (D. Sanger, pers. comm.). At least 10 new sites associated with old channels of the Aroostook River were identified, representing a presently unknown range of cultural and temporal associations, in an environmental setting that may be comparable to sites associated with the Missisquoi River in northern Vermont (Thomas, 1983). These sites may provide a means to substantially increase resolution of the prehistoric chronology for northern Maine.

Discussion

Most major prehistoric cultural traditions appear to be represented in the upper St. John basin, as well as throughout the northern interior of Maine, although additional fieldwork is required to qualify the "completeness" of this archaeological record. In addition, many of the sites located in the interior consist only of flake scatters and fire-cracked rock and lack diagnostic artifacts, making an association with any cultural period unlikely. The earliest evidence of occupation of the St. John River basin appears to be at the Shields Branch site (170-1), located on an early Holocene river terrace within the glacial Lake Shields Branch basin, where a late Paleoindian or Early Archaic-type point was recovered (Kite and others, 1982; Nicholas and others, 1981; see also Doyle and others, 1985). Other evidence of early postglacial occupation is at Munsungan Lake (Bonnicksen, 1982); Azischohos Lake (Gramley, 1982); and at a

number of other locations in northern New England (e.g. Doyle and others, 1985) and Quebec (e.g. Dumais and Rousseau, 1985). These sites are associated with a wide range of environmental settings and may include both base camps and special activity sites located to exploit floral and faunal resources, as well as lithic outcrops for tool materials. Given the long-cited but infrequently documented association of Paleoindians with megafauna or herd animals such as caribou, it is important to keep in mind that even if evidence of such exploitation is found, it may represent only one aspect of a more complex subsistence strategy. As discussed elsewhere (Nicholas, 1986a), the broader the available resource base is, the more advantageous it is to maintain a generalized economy.

Evidence of Archaic occupation of the upper St. John Valley is limited to several sites at which non-diagnostic but Archaic-like material was recovered, such as at the Big Black (171-1), Seven Islands (170-13), and Seminary Brook (171-11) sites (Sanger, 1977, p. 30). A number of sites in the area represented only by flakes are likely to be Archaic in age.

The majority of diagnostic artifacts recovered from the study area are associated with the Ceramic period (about 3,000 to 400 yr B.P.). Sanger (1977, p. 30) has suggested that the most intensive occupation or use of the upper St. John occurred at about this time, which may be tied into regular forays between the Maine Coast, major interior rivers, and the St. Lawrence River. There is no reason, however, to suggest that "regular forays" between these areas were not occurring much earlier in the Holocene or even the late Pleistocene.

At least two sites in the area, the Big Black (171-1) and the Shields Branch (170-1), show evidence of multiple occupations during the Holocene, perhaps because they are located advantageously at much-used river confluences. The Shields Branch site appears to be extremely large (over 600 m by 100 m) and probably represents repeated use, beginning in the early Holocene, possibly both as a base camp location and for short-term activities. At this site, both Round Mountain-type cherts from the interior and chalcedony-like flakes apparently from near the mouth of the St. John River in New Brunswick were recovered. The presence of such non-local lithics at the site supports various ideas about extensive trade and travel routes on the rivers.

ARCHAEOLOGICAL IMPLICATIONS

What is most evident about the archaeological record of the St. John River basin, and of other parts of interior Maine, is the low number of recorded sites of any age. This is especially evident when compared to the number of sites recorded in southern and central Maine, where extensive professional and amateur fieldwork has been conducted for decades. Fieldwork in the northern interior is extremely expensive and time-consuming, making the location of archaeological sites difficult at best. The degree to which this archaeological record is representative of prehistoric settlement, subsistence, and social patterns, however, raises a number of important questions that must be addressed if archaeologists are to understand the basic prehistoric sequence, let alone examine critically

problems such as how prehistoric populations may have responded to environmental change. Examples of these questions are: was the occupation of the interior during the early postglacial period restricted by low resource-capacity environments?; have there been periods during the Holocene when parts of the interior were more productive (and attractive to humans) than at present?; was prehistoric use of the interior limited primarily to travel routes and specialized resource-exploitative activities?; and is evidence of high site density in the interior limited to areas of high quality lithic outcrops? These and other questions need to be integrated into research designs not only by archaeologists, but by paleoecologists, geologists, and other Quaternary scientists. This approach is, in fact, already underway in a number of studies that have focused on the early postglacial period in northern New England (Doyle and others, 1985; Bonnicksen and others, 1985; Nicholas, 1982; Nicholas and others, 1981). These studies have examined aspects of the above-stated problems through analysis of artifact assemblages, site locations, and environmental reconstruction.

As noted above, a major problem facing archaeologists working in this area is the accessibility of field locations. In addition, with the cancellation of environment-threatening projects such as the Dickey-Lincoln reservoir, important sources of research funding for additional fieldwork in the study area have been lost. However, even with additional fieldwork, simply increasing the number of sites does little to resolve differences between competing models of prehistoric land-use or hypotheses of low vs. high resource-productivity landscapes, both of which are used to direct fieldwork and interpret field data. Studies of long-term land use are particularly important because they represent an appropriate level of interaction between human populations and environmental change, which is normally a gradual process. Attention must also be directed at what individual sites within the larger land-use patterns represent. Problems of interpretation can be addressed, at least in part, by evaluating the "goodness of fit" of available data to detailed models of environmental and cultural change through time and space. Environmental factors affecting site preservation, methodological factors affecting site location, and interpretive biases affecting how the prehistoric record is viewed are discussed in detail elsewhere (Nicholas, 1984, 1986 a,b; Nicholas and others, 1981).

ENVIRONMENTAL CHANGE AND PREHISTORIC LAND-USE PATTERNS

Predictive and explanatory models of cultural and environmental interaction provide one means to determine how accurately the archaeological record represents the actual prehistoric past. In other words, if it is argued that the known site inventory actually represents only a fraction of the range of prehistoric sites on the basis of various empirical or theoretical studies, then (1) how can this inventory be increased?; and (2) how can this increase be interpreted? The following discussion outlines two models that can be applied in interpreting the prehistoric record of the upper St. John River basin, and which can provide a baseline for future, problem-oriented research (whether to prove or disprove particular hypotheses derived from these models). The general

focus of this discussion is on the late Pleistocene-early Holocene period, primarily because this is a time for which traditional models of regional prehistory predict an extremely low number of sites as the result of a limited resource base (e.g. Funk, 1978, p. 16).

The two models described below are particularly appropriate to the present discussion of the Upper St. John River basin because (1) they involve landscape developments occurring within former glacial lake basins, which are extensive throughout the region; and (2) they assume explicitly that the low site density is a direct function of limited survey and environmental biases. While these models were developed to explore land use specifically during the early postglacial period, they are also applicable to middle and late Holocene time.

The Glacial Lake Basin Mosaic Model

The idea that the early postglacial environment was generally inhospitable and ecologically homogeneous is being challenged by both archaeologists and paleoecologists (see Nicholas, 1986 a,b). Much of this work suggests that the limitation of early environments may have been over-estimated, at least in some ecological settings. For example, it can be argued that in some areas of the Northeast, glacial lake basins (existing mainly between 14,000 and 11,000 B.P.) would have provided hydrological settings for the development of extensive lake/pond/wetland/river basin mosaics. Such systems were apparently important foci for early prehistoric settlement (Nicholas, 1983, 1986 a,b; Nicholas and Handsman, 1984, in press).

The primary postulate of the model is that when compared to other parts of the contemporaneous landscape, the lake basin mosaics would have had the highest levels of resource diversity and productivity at the time (see discussion and references in Nicholas 1983, 1986b), even higher than that postulated for some inter-basin riverine systems by Curran and Dincauze (1977). Within these basins, which appear to have been widely distributed across the glaciated Northeast, including the upper St. John River basin, the presence of additional water in shallow ponds, wetlands, and flowing streams created complex mosaics of floral and faunal resources that would have increased the diversity of certain early postglacial environments. In some cases, mosaics may have developed outside of glacial lake basins when a combination of lakes, wetlands, and other features were present. The resource diversity, productivity, and reliability of mosaics would have been capable of supporting particular patterns of land use not normally associated with highly mobile foragers. Thus it is possible that in particular settings a mosaic of early Holocene environments created what were essentially "landscapes of opportunity". Support for the type of land-use pattern predicted by the glacial lake basin mosaic model is provided by archaeological data from across a broad area of New England (see Nicholas, 1986b). For example, a comprehensive study of the distribution of Paleoindian and Early Archaic sites in New Hampshire (Nicholas, 1983) revealed a very strong correlation between glacial lake basins and early sites. In southern New England, systematic survey and testing at Robbins Swamp, a very large glacial lake basin, has produced a

record of about 40 Paleoindian and Early Archaic sites, and hundreds of middle and late Holocene sites (Nicholas, 1986b, in press; Nicholas and Handsman, in press). Site locations include former lake shorelines, upper river terraces, wetland margins, and adjacent upland areas, with many associated with more than one landform type.

It is expected that types and rates of resource productivity and diversity within these basins would have varied considerably both over time and through space. For example, it is unlikely that the resource base associated with Robbins Swamp will be matched in various lake basins in northern Maine due to a variety of environmental, geological, and climatic factors. Nonetheless, relative resource productivity should have been higher within these basins than elsewhere on the local landscape, particularly during the early Holocene, when the otherwise resource-rich coastal plain was negatively impacted by the transgressing sea level. Tentative evidence for early land-use patterns directed to these basins comes from the Shields Branch site in the study area, located within glacial Lake Shields Branch basin, and from other early site/lake associations elsewhere in the region (Bonnichsen, 1982; Doyle and others, 1985). However, caution is required in determining the type of site/landform association. For example, while the Shields Branch site is located on an upper river terrace, it is situated within a former lake basin where a variety of biotic resources would be expected during the early Holocene. This type of model should be used to direct additional systematic survey and testing programs within the study area (e.g. glacial Lakes Little Black, Madawaska, and Shields Branch), as well as elsewhere in the region where lakes and wetlands are present within former glacial lake basins (e.g. Boissonault and others, 1981).

Ecological Leveling

A second model, ecological leveling, is used to examine changes in the composition, productivity, and environmental dynamics of former lake basins, and in the associated cultural patterns of land use. The term itself refers to a postulated reduction of differences (i.e. "leveling") in resource availability between basin and non-basin areas through time. This model is discussed in detail in Nicholas (1986b).

The type of landscape mosaic presented here for glacial lake basins is not considered static. At some point in time, the "uniqueness" of these basins (as measured in terms of resource productivity, reliability, and diversity relative to other parts of the landscape) would have diminished because of landscape composition changes occurring during the Holocene. In northern Maine, the attractiveness of these basins is expected to have been short-lived and restricted to the early Holocene. Resource productivity of the basin mosaics would have been adversely affected by rapid stream system development, by vegetational succession, and by climatic events such as the Hypsithermal episode or changes in the strength of seasonality (Kutzbach, 1984; Kutzbach and Guetter, 1984).

Once a reduction of differences between landscape ecotones occurred, land-use patterns would be expected to have shifted their geographic focus

to other areas of high resource productivity. Such areas could have included parts of both major river valleys, including the St. Lawrence, and the coast. As these areas were more intensively occupied and used, the upper St. John River valley (and the glacial lake basins it contains) may have been used less frequently and for specific types of activities, such as part of a travel network (small, overnight sites) vs. major habitation areas (larger, longer-occupation base camps). Evidence of such land-use shifts would be found in the way that the study area was used at various points during the Holocene.

What is particularly useful about this model is that it is not restricted to either the early postglacial period or to glacial lake basins. It provides a way to examine land-use patterns wherever environmental contrasts occur through time and space. This may be one way to examine changes in land use between the coastal and interior zones of Maine. As with the glacial lake mosaic model, and other environmentally-based models of prehistoric change, continued interdisciplinary research and fieldwork are necessary.

CONCLUSIONS

This brief paper has been used as a vehicle both to present a general summary of recent fieldwork in the upper St. John River basin and, more importantly, to discuss several ways that the available archaeological and paleoenvironmental records for northern New England can be explored. While the utility of these and other models is clearly impeded by the limited number of sites identified in the study area to date, hypotheses derived from these models can be used to direct much-needed additional fieldwork. Without models that evaluate critically the archaeological record for northern Maine and vicinity, archaeologists run the risk of being stuck in the circular reasoning trap of limited site inventory → low site-density models → research designs that expect few sites. In addition, the interpretation of prehistoric land-use patterns requires that field data be correlated with paleoenvironmental data at appropriate scales of interaction (Nicholas and Dincauze, in prep.) and that the mechanisms proposed for environmentally-based culture change be made explicit and rigorously tested.

The length of this review has prevented a more detailed and data-oriented discussion of both the general prehistoric and paleoenvironmental sequences represented in northern Maine and adjacent Canada, and of the glacial lake mosaic and ecological leveling models discussed above, in the interest of conveying to non-archaeologists the type of problem-oriented research to which they can contribute. Hypotheses derived from the two models discussed are currently being evaluated elsewhere (Nicholas, 1986b) and should be tested in the upper St. John basin and elsewhere in the region when the opportunity arises. Other models, such as those developed by Bonnicksen and Sanger to explain land-use patterns in other drainages, may also be applicable to some degree in the St. John basin. In the meantime, basic research and fieldwork must be continued throughout northern Maine, and communication increased between Canadian and American scientists working at the interface between prehistoric populations and their changing environments.

ACKNOWLEDGMENTS

I would like to thank those individuals who contributed in various ways to the fieldwork and ideas discussed in this paper: "Sneaky Pete" Beblowski, Steve Bicknell, Jose Benmouyal, Rob Bonnicksen, Catherine Carlson, Claude Chapdelaine, Stephen Cox, Dena Dincauze, Russell Handsman, Steven Kite, Brad Lepper, Tom Lowell, Pierre Dumais, David Sanger, Art Spiess, Woody Thompson, and John Wilson.

REFERENCES CITED

- Benmouyal, J., 1981, North Gaspé prehistory: a contribution to Quebec archaeology: Ph.D. dissertation, Simon Fraser University, British Columbia, 375 p.
- Boissonnault, P., Gwyn, Q. H. J., and Morin, B., 1981, Le lac proglaciaire Memphremagog: géologie, geomorphologie, archéologie: Bulletin de Recherche, Département de Géographie, Université de Sherbrooke, Québec, No. 55, 40 p.
- Bonnichsen, R., 1982, Archaeological research at Munsungan Lake: 1981 technical report of activities, Institute for Quaternary Studies, University of Maine, Orono, 51 p.
- Bonnichsen, R., Jacobson, G. L., Jr., Davis, R. B., and Borns, H. W., Jr., 1985, The environmental setting for human colonization of northern New England and adjacent Canada in late Pleistocene time, *in* Borns, H. W., Jr., LaSalle, P., and Thompson, W. B., eds., Late Pleistocene history of northeastern New England and adjacent Quebec: Geological Society of America, Special Paper 197, p. 151-159.
- Curran, M. L., and Dincauze, D. F., 1977, Paleoindians and paleo-lakes: new data from the Connecticut drainage, *in* Salwen, B., and Newman, W., eds., Amerinds and their Paleoenvironments in northeastern North America: New York Academy of Sciences, v. 288, p. 333-348.
- Doyle, R. A., Hamilton, N. D., Petersen, J. B., and Sanger, D., 1985, Late Paleo-Indian remains from Maine and their correlations in Northeastern prehistory: Archaeology of Eastern North America, v. 13, p. 1-35.
- Dumais, P., and Rousseau, G., 1985, Trois sites Paleoindiens sur la cote de l'estuaire du Saint-Laurent: Recherches Amerindiennes au Québec, v. 15, no. 1-2, p. 135-149.
- Hadlock, W. H., 1967, A preliminary archaeological survey of the Dickey Dam reservoir area on the St. John River, Maine: University of Maine, Orono, Archaeology Lab, unpublished report, 46 p.
- _____, 1968, An ecological and archaeological study on the upper St. John-Dickey reservoir: University of Maine, Orono, Archaeology Lab, unpublished report, 14 p.
- Gramley, M., 1981, The Vail site: a Paleo-Indian encampment in Maine: Bulletin of the Buffalo Museum of Natural Sciences, v. 30, 169 p.
- Kite, J. S., Lowell, T. V., and Nicholas, G. P., 1982, Quaternary studies on the upper St. John River: Maine and New Brunswick: New Brunswick Quaternary Association, Fredericton, N. B., 55 p.
- Kutzbach, J. E., 1984, The seasonal nature of climatic forcing and responses on Quaternary time scales: AMQUA Abstracts, v. 8, p. 59-61.

- Kutzbach, J. E., and Guetter, P. J., 1984, Sensitivity of late-glacial and Holocene climates to the combined effects of orbital parameter changes and lower boundary condition changes: "snapshot" simulation with a general circulation model for 18-, 9-, and 6000 B.P.: *Annals of Glaciology*, v. 5, p. 85-87.
- Moorehead, W. K., 1922, A Report on the Archaeology of Maine: Andover Press, Andover, Mass., 235 p.
- Nicholas, G. P., 1982, Former glacial lakes and early postglacial settlement: *AMQUA Abstracts*, v. 7, p. 148.
- _____, 1983, A model for the early postglacial settlement of the central Merrimack River Basin, New Hampshire: *Man in the Northeast*, v. 24, p. 43-63.
- _____, 1984, Recommendations for the management of early postglacial archaeological resources: Paper presented at the American Anthropological Association Meeting, Denver, Co.
- _____, 1986a, Rethinking the Early Archaic, *in* Simon, B., and Johnson, E., eds., *Early Archaic Studies in the Northeast*: in preparation.
- _____, 1986b, Ecological leveling: the archaeology of early postglacial prehistoric and environmental dynamics, *in* Nicholas, G. P., ed., *Cultural and Environmental Change in the Northeast*: in preparation.
- _____, in press, Late Pleistocene-early Holocene land-use patterns at Robbins Swamp, southwestern New England, USA: 1983-1985 field season results: *Current Research in the Pleistocene*, v. 3, p. 38.
- Nicholas, G. P., and Dincauze, D. F., in prep., An essay on cultural and environmental change, *in* Nicholas, G. P., ed., *Cultural and Environmental Change in the Northeast*.
- Nicholas, G. P., and Handsman, R. G., 1984, Early postglacial landscape development and archaeology at Robbins Swamp, Northwestern Connecticut: *AMQUA Abstracts*, v. 8, p. 93.
- _____, in press, Early postglacial archaeological land-use patterns at Robbins Swamp, Northwestern Connecticut: *AMQUA Abstracts*, v. 9.
- Nicholas, G. P., and Kite, J. S., 1981, Archaeological survey and testing in the Bald Mountain area, northern Maine: *Institute for Quaternary Studies*, University of Maine, Orono, 90 p.
- Nicholas, G. P., Kite, J. S., and Bonnicksen, R., 1981, Archaeological survey and testing of late Pleistocene-early Holocene landforms in the Dickey-Lincoln School reservoir, northern Maine: *Institute for Quaternary Studies*, University of Maine, Orono, 170 p.
- Sanger, D., 1977, Cultural resource management in the Dickey-Lincoln School reservoir, Maine: Report for the U.S. Army Corps of Engineers, New England Division, Waltham, Mass., 123 p.

Sanger, D., 1979, Discovering Maine's archaeological heritage: Maine
Historic Preservation Commission, Augusta, Maine, 156 p.

Snow, D., 1980, The archaeology of New England: Academic Press, New York,
379 p.

Thomas, P. A., 1983, A cultural resource reconnaissance for the
construction and operation of the Missiquoi River Flood Control
Project in Richford, Vermont: Department of Anthropology Report, no.
43, University of Vermont, 225 p.

USM LIBRARIES

USM LIBRARY-GORHAM
37 COLLEGE AVE
GORHAM, ME 04038-1088

UNIVERSITY OF SOUTHERN MAINE



3 1390 00567927 7