

# Some Notes on Incorporation from Subjects

Yoshihisa Goto

## 0. Introduction

It is possible to incorporate a subject pronoun in VSO languages, as shown in the following Breton examples:

- (1) a. Bemdez e lenn ar vugale eul levr.  
 every.day prt read the kids art book  
 ‘The kids read a book every day.’  
 b. Bemdez e lenn-out<sub>i</sub> t<sub>i</sub> eul levr.  
 every.day prt read-3pS art book  
 ‘They read a book every day.’ (Anderson (1982))

In contrast, it is impossible to incorporate a subject noun even in VSO languages. As shown in Baker and Hale (1990), in Niuean, which is a VSO language, noun incorporation from subjects is not allowed as in (2b), while incorporation of an object noun is allowed as in (3b):

- (2) a. Fa totou he tau faiaoga e tau tohi.  
 hab-read erg-pl-teacher abs-pl-book  
 ‘(The) teachers often read books.’  
 b. \*Fa [totou faiaoga]<sub>v</sub> t<sub>i</sub> e tau tohi.  
 hab-read-teacher abs-pl-book  
 ‘Teachers often read books.’ (Baker and Hale (1990))

- (3) a. kua ta: he tama e tau fakatino aki e malala.  
 PERF draw ERG child ABS PL picture with ABS charcoal  
 ‘The child has been drawing pictures with charcoal.’  
 b. kua ta: fakatino e tama aki e malala.  
 PERF draw picture ABS child with ABS charcoal  
 ‘The child has been drawing pictures with charcoal.’ (Seiter (1980))

The aim of this paper is to give an account of the asymmetry between pronoun incorporation and noun incorporation.

In section 1, I will review Baker and Hale’s (1990) account of this asymmetry and will point out some problems in their analysis. In section 2, an alternative account will be proposed building on Chomsky’s (1992, 1995) checking theory. It will be argued that the possibility of incorporation from subjects crucially rests on the presence of a D (Determiner)-feature, which can check off a D-feature of Tense.

## 1. Baker and Hale’s (1990) Account

In Baker and Hale (1990), it is claimed that the antecedent government of X<sup>0</sup>-traces is

subject to the Relativized Minimality Condition as defined below:

- (4) Z is a potential antecedent governor for Y if and only if  
 a. Y is lexical  $X^0$  category and Z is a lexical  $X^0$  category m-commanding Y, or  
 a'. Y is a functional  $X^0$  category and Z is a functional  $X^0$  category m-commanding Y.

Let us see how the asymmetry between pronoun and noun incorporation can be accounted for in terms of the refined Relativized Minimality Condition. The examples (1) and (2) are assumed to have the structure as follows:<sup>1)</sup>

(5)

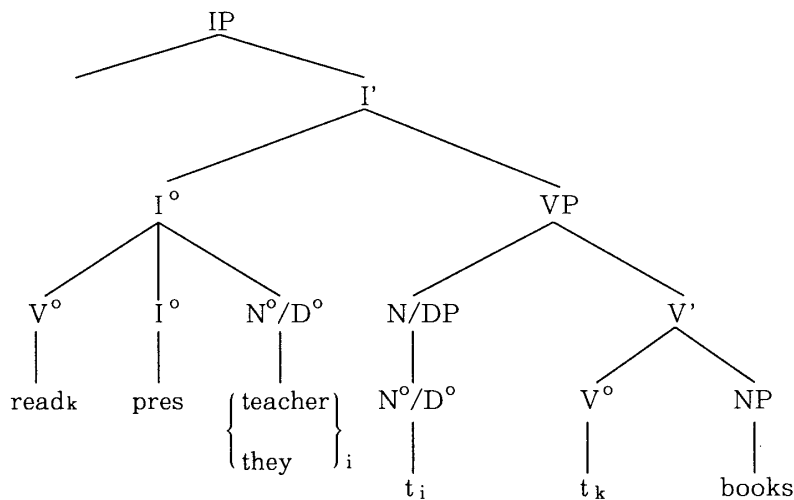

The crucial point here is whether a trace of an incorporated head satisfies the antecedent government condition (4) or not. Since the trace of the fronted verb  $t_k$  m-commands the trace  $t_i$  in the subject position and  $t_k$  is a lexical category, it qualifies as a closer potential antecedent governor for the noun trace, which belongs to the lexical category N. Therefore, the antecedent government relation between 'teacher' and its trace  $t_i$  is blocked by  $t_k$ , and the sentence is predicted to be ungrammatical. On the other hand, since a pronoun trace is a member of the functional category D, the antecedent government relation between 'they' and its trace is not disrupted by  $t_k$ , and grammaticality of pronoun incorporation follows.

Let us now discuss the empirical and theoretical problems with Baker and Hale's (1990) claim that the antecedent government of  $X^0$ -traces is subject to the Relativized Minimality Condition. First, we will examine the validity of the first clause of the refined Relativized Minimality, that is (4a). The following examples are given in Baker and Hale (1990) as the empirical evidence that functional categories do not block  $X^0$  movement of lexical categories.

- (6) a. [Yede seuan-ide] a-mu-ban.  
 that man -suf 2sS/A-see-past  
 'You saw that man.'
- b. [DP Yede [NP [N<sub>i</sub> e]]] a-seuan<sub>i</sub>-mu-ban.  
 that 2sS/A-man-see-past  
 'You saw that man.'

They assume that demonstratives such as *yede* are determiners, and that the N in the object position has been moved into the V, skipping the demonstrative determiner. Then, they argue that since the demonstrative determiner is not regarded as an intervening potential antecedent governor under this assumption, grammaticality of (6b) is predicted. This assumption, however, is denied in Baker (1996), in which it is claimed that polysynthetic languages like Southern Tiwa do not have semantically meaningful determiners of the kind found in English. If Baker's (1996) claim that demonstratives are not determiners in these languages is on the right track, the demonstrative in (6a,b) cannot be regarded as an intervening functional category D. Then the account under the refined Relativized Minimality would lose its strong empirical basis.

The theoretical problem is related to whether the operation Move (or Attract in the framework of Chomsky (1995)) can "see" traces. Baker and Hale's (1990) account is based on the assumption that the trace of the fronted verb blocks the antecedent government relation between the incorporated noun and its trace. Being paraphrased in terms of Attract/Move, the assumption would be that the N cannot be attracted because of the V trace. It is incompatible with the following principle proposed in Chomsky (1995):

(7) Only the head of a chain CH enters into the operation Attract/Move.

Given that the trace of the fronted verb is invisible to Attract/Move, Baker and Hale's (1990) account, in which the trace plays an important role as a potential antecedent governor, faces a serious theoretical problem.

## 2. An Alternative Account of Incorporation from Subjects

### 2.1 NP-features and Chomsky's (1992, 1995) Checking Theory

In Chomsky (1992) it is argued that morphological features of a lexical element can be checked only if the element enters into a specific structural relation with a functional head. For example, he assumes that V-features of verbs are checked against functional heads (AGR and Tense) when a verb adjoins to the functional heads: [<sub>H</sub> F H] configurational relations as shown in (8). On the other hand, NP-features of NPs (or DPs) are assumed to be checked when they enter into [<sub>Spec</sub> H] (i.e., Spec-Head) configurational relations with AGR and Tense as illustrated in (9):

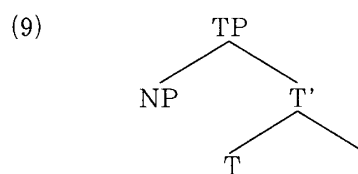
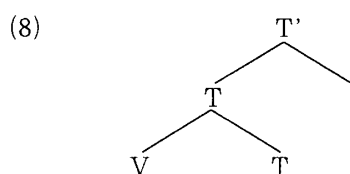

In Chomsky (1992), it is also proposed that these checking relations are defined as the checking domain of a head  $\alpha$ . Let us consider the following structure:

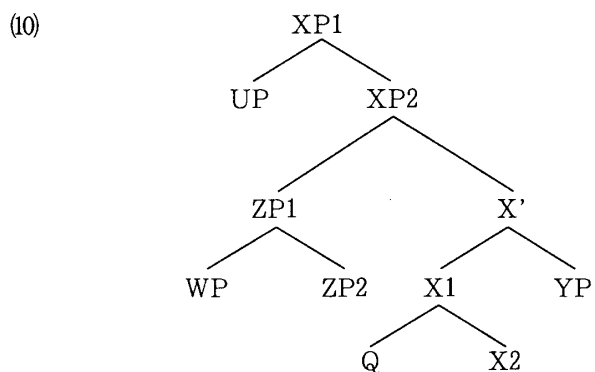

In (10), the checking domain of the two-segment head  $[X1, X2]$  is assumed to be the minimal residue of the head, which is  $\{UP, ZP, WP, Q\}$ .<sup>2)</sup> It is important to note here that Chomsky (1992) divides the checking domain  $\{UP, ZP, WP, Q\}$  into two parts:  $\{UP, ZP, WP\}$  and  $\{Q\}$ , respectively. As pointed out above, NP-features are assumed to be checked only by  $[Spec, H]$  relations, that is, by moving into UP, ZP, or WP but not Q.

However, according to Chomsky's (1992) definitions for the checking domain, it is possible to regard Q as a position where NP-features can be checked. In other words, it is a possible option to check NP-features under  $[_H F H]$  relations like the relation between Q and X2 in (10). Although this issue is taken up in Chomsky (1995), adjunction of NP-features to  $X^0$  is assumed to occur only if it is covert. In this paper we propose that NP-features can be checked under  $[_H F H]$  relations overtly as well as covertly when the head of DPs or NPs is incorporated into an appropriate head.

## 2.2 Incorporation and D-feature

In what follows, we will see that the asymmetry between noun incorporation and pronoun incorporation can be accounted for straightforwardly in terms of Chomsky's (1992, 1995) checking theory. Let us first deal with the possibility of pronoun incorporation from the subject. We assume with Postal (1966) and Abney (1987) that pronouns are projections of D which lack an NP complement, as illustrated below:<sup>3)</sup>

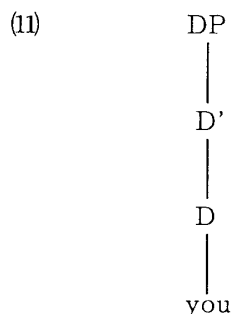

When pronoun incorporation occurs as in (1b), the functional head D is adjoined to  $T^0$ . After V-to-T movement and incorporation of a subject pronoun, the structure of (1b) is (12):

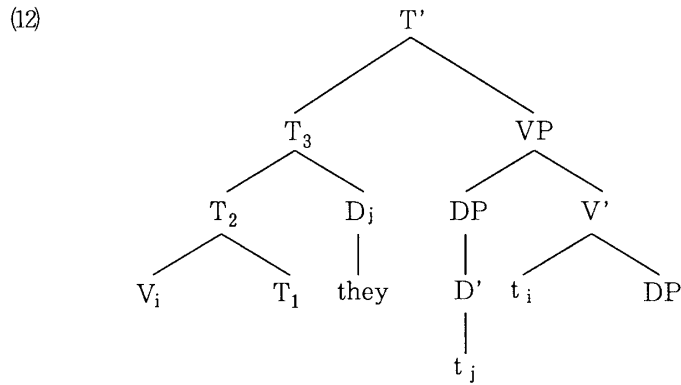

In this paper, we adopt Chomsky's (1995) proposal that the Extended Projection Principle (EPP) is a manifestation of the requirement that Tense must be checked with a D categorial feature. In (12), since  $D_j$ , which is adjoined to  $T_2$ , is in the checking domain of  $T_1$ , the D-feature of T (as well as Case-feature and  $\phi$ -feature) can be checked against that of the incorporated D and the derivation converges.

Let us next turn to noun incorporation. Provided that the N head is directly incorporated into the complex head [V-T] when noun incorporation occurs, the structure of (2b) after the application of the relevant operations is (13):

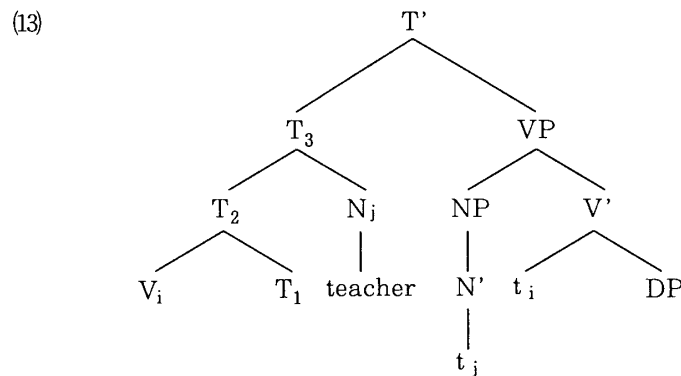

Since the N head has no D-feature as its morphological property, the D-feature of  $T_1$  cannot be checked and the derivation crashes at LF.

In sum, it has been argued that noun/pronoun asymmetry with respect to incorporation follows from the difference between nouns and pronouns with respect to D-features. Since D-features are regarded as properties of D, a D-feature of T can be checked by a D head, not by an N head. Hence, incorporation of a subject pronoun is possible while that of a subject noun is not.<sup>4)</sup>

### 2.3. Noun Incorporation into a Causative Verb

In this section we will see an important advantage of the proposed analysis of incorporation. Consider the following example (14a) from Southern Tiwa whose structure is shown in (14b):

- (14) a. Ti-seuan-p 'akhu-kumwia-' am-ban wisi te-khaba-' i.  
 1s:A-man-bread-sell-CAUS-PAST two 1s:C-bake-SUBORD  
 'I made the man sell the two breads that I baked.'

(Baker (1988))

b.

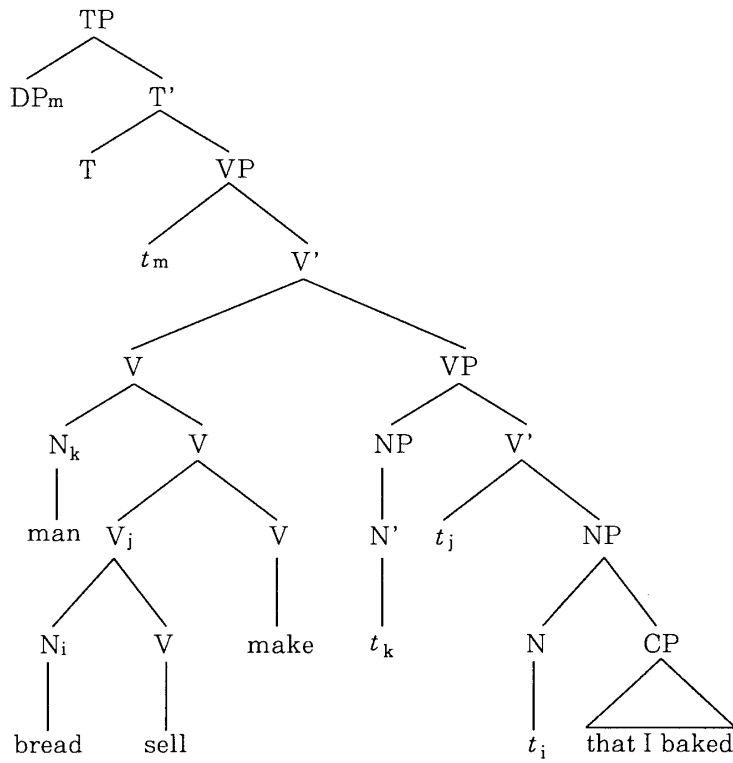

Although we have seen that noun incorporation from subjects of main clauses is not allowed, it is possible to incorporate the subject noun (*man*) of the complement VP of the causative verb (*make*) as in (14). Where does the asymmetry between the matrix subject and the embedded subject come from? It is argued above that incorporation of the matrix subject noun is prohibited since a D-feature of T remains unchecked at LF. In contrast, since verbs do not have D-features to be checked off, it does not matter if the incorporated noun does not have a D-feature. There is no feature which remains unchecked at LF and the derivation converges.

### 3. Conclusion

In this paper we have refined Chomsky's (1992, 1995) checking theory in the following point. NP-features can be checked overtly not only under [Spec H] relation (that is, by movement of maximal projections XPs into the Spec of an appropriate head) but also under [H F H] relation (that is, by incorporation of a head of XPs into an appropriate head). According to the refined checking theory, it has been shown that the asymmetry between noun and pronoun with respect to incorporation from matrix subject positions can be accounted for straightforwardly. The crucial point is that a D-feature of T can be checked properly in the case of pronoun incorporation but not in the case of noun incorporation.

## Notes

1) Chomsky (1992) assumes that VSO word order is derived through V-to-Infl (or T) movement in the overt syntax. While verb movement is forced overtly by the strong V-feature of Infl, subjects and objects remain in their base-generated positions in the overt syntax since NP-features of AGR and T are weak in VSO languages.

2) The minimal residue of a head  $\alpha$  is defined as its minimal domain (i.e., {UP, ZP, WP, YP, Q} in (10)) minus its minimal complement domain (i.e., {YP} in (10)). For the definition of the minimal domain of a head  $\alpha$  and other definitions, see Chomsky (1992).

3) Under the framework of bare phrase structure in Chomsky (1995), structures are represented in terms of lexical items themselves, not in terms of the categorial information such as D and N. Since the issue is not crucial for anything that follows in this paper, I represent structures in terms of the categorial information.

4) In this paper, we assume with Baker (1988) that incorporation occurs in the syntax. In contrast with this, Rosen (1989) argues that noun incorporation derives from word formation rules applying in the lexicon. If noun incorporation occurs only in the lexicon, we cannot give an account of the fact that the subject noun of the complement VP of the causative verb can be incorporated, as shown in section 2.3.

## References

- Abney, S. (1987) "The English Noun Phrase in Its Sentential Aspect," Ph.D. dissertation, MIT.
- Anderson, S. (1982) "Where's Morphology?" *Linguistic Inquiry* 13, 571-612.
- Baker, M. (1988) *Incorporation: A Theory of Grammatical Function Changing*, University of Chicago Press.
- Baker, M. (1996) *The Polysynthesis Parameter*, Oxford.
- Baker, M. and K. Hale (1990) "Relativized Minimality and Pronoun Incorporation," *Linguistic Inquiry* 21, 289-297.
- Chomsky, N. (1992) *A Minimalist Program for Linguistic Theory*, MIT Occasional Papers in Linguistics 1.
- (1995) *The Minimalist Program*, The MIT Press.
- Hale, K. (1990) "Some Remarks on Agreement and Incorporation," *Studies in Generative Grammar* 1, 117-144.
- Postal, P. (1966) "On So-Called 'Pronouns' in English," in D. Reibel and S. Schane, eds., *Modern Studies in English*, Prentice-Hall.
- Rosen, S. (1989) "Two Types of Noun Incorporation: a Lexical Analysis," *Language* 65, 294-317.
- Seiter, W. (1980) *Studies in Niuean Syntax*, Garland.