

Surficial Materials

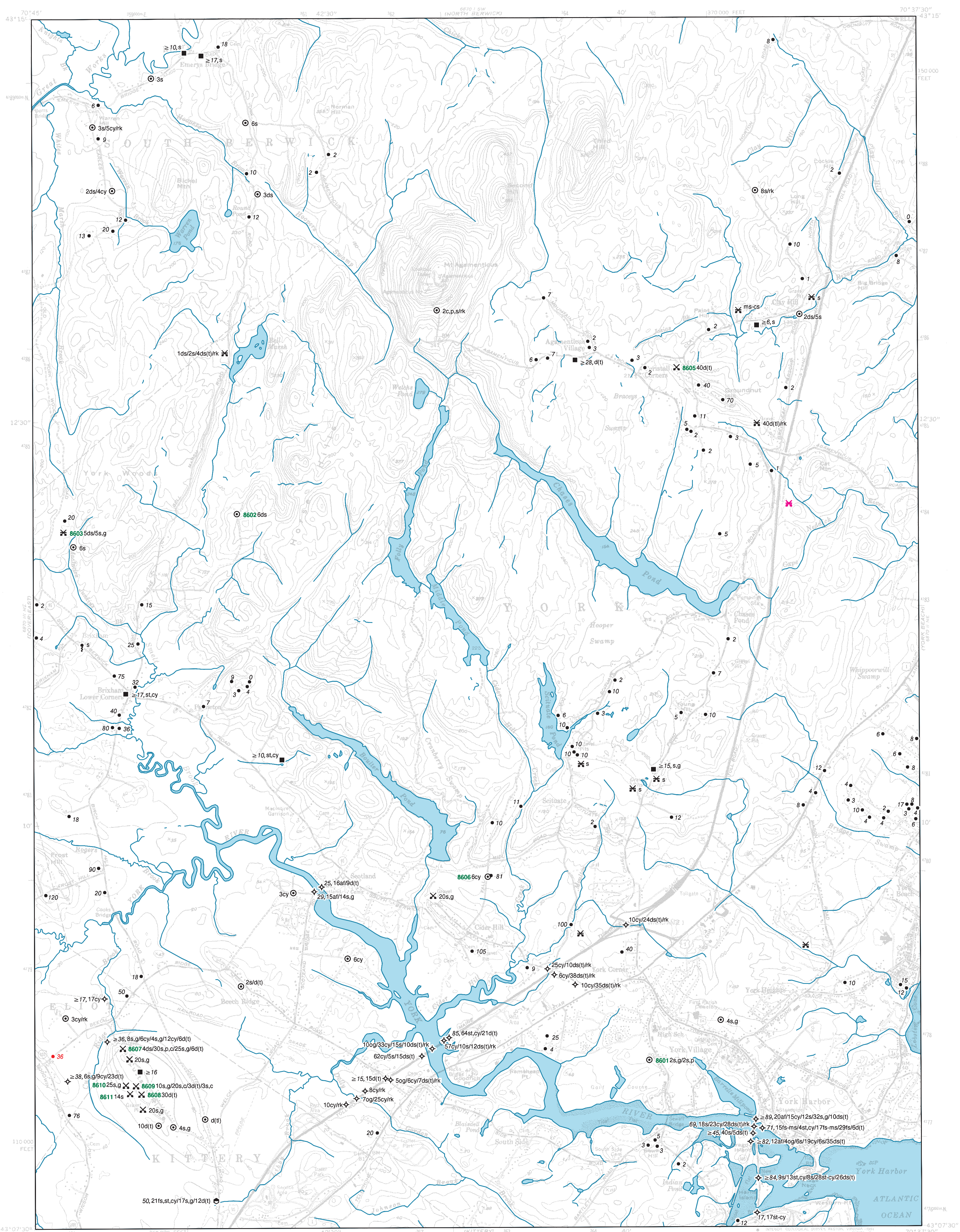

SOURCES OF INFORMATION

Materials mapping by J. M. Clinch and P. B. O'Toole completed during the 1986 field season; funding for this work provided by the U.S. Geological Survey COGEOAMP program. Supplemental materials data were collected by the significant aquifer mapping program during the 1995 field season, funded by the Maine Geological Survey and the Maine Dept. of Environmental Protection. Additional materials data sources include, but are not limited to, municipal water company records, U.S. Geological Survey Basic Data Reports, Maine Geological Survey bedrock, well database and published bedrock geology maps, Maine Dept. of Environmental Protection site files, Maine Dept. of Transportation highway construction records, and the Maine Dept. of Human Services public water supply well database.

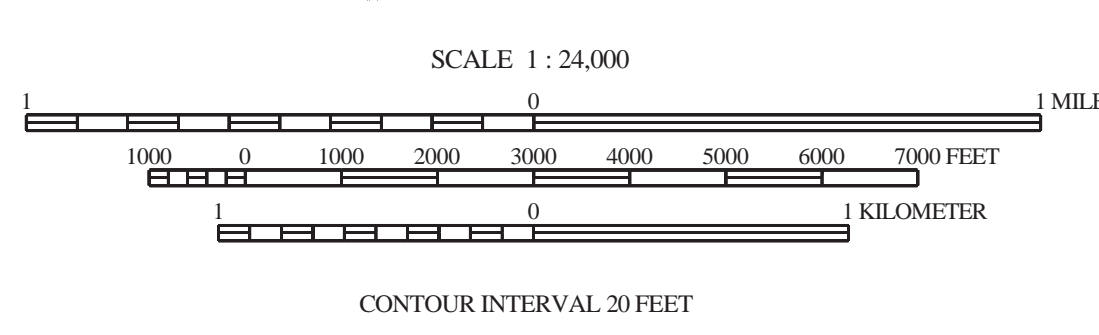

Topographic base from U.S. Geological Survey York Harbor quadrangle, scale 1:24,000 using standard U.S. Geological Survey topographic map symbols. The use of industry, firm, or local government names on this map is for location purposes only and does not implicate responsibility for any present or potential effects on the natural resources.

This map shows the textures of surficial sediments in the quadrangle, independent of interpretations regarding their origin. For example, poorly sorted sediments deposited directly from glacial ice are shown here as "diamiction," although they may be genetically classified as "till".

The symbols listed below indicate materials observed in borrow pits and other surface exposures, as well as subsurface data from various sources. Where more than one textural class is present, materials are separated by commas and listed in decreasing order of abundance (e.g., s, st, cy). Individual materials may occur in distinct layers, or they may be mixed. Hyphens show the ranges of particle sizes present where their relative abundances are uncertain (e.g., st-c). Slash marks indicate superposition of materials. Numbers are observed thicknesses in feet (e.g., 10s/3cy) and in many cases do not indicate the thickness of surficial materials that may exist at greater depths. "±" indicates a significant stratigraphic sequence of interbedded materials. Not all symbols will necessarily be found on the map.

- GRAVEL** g Undifferentiated gravel, used as a general term. Can be subdivided by size as follows:
- b Boulder gravel (>256 mm (10")
 - c Cobble gravel (64-256 mm (2.5-10")
 - p Pebble gravel (2-64 mm (0.1-2.5")
- MIXED UNITS** gs Gravelly sand (this is a special case for sand with lesser amounts of intermixed gravel, i.e. pebbly sand, cobbly sand, or bouldery sand)
- sg Sand and gravel (used only to describe slumped face or other site where relative abundances of sand vs. gravel are unknown)
- SAND** s Undifferentiated sand, used as a general term. Can be subdivided by size as follows:
- vcs Very coarse sand (1-2 mm)
 - cs Coarse sand (0.5-1 mm)
 - ms Medium sand (0.25-0.5 mm)
 - fs Fine sand (0.125-0.25 mm)
 - vfs Very fine sand (0.0625-0.125 mm)
- SILT** st Silt (0.002-0.0625 mm)
- CLAY** cy Clay (<0.002 mm)

- DIAMICTON** d Undifferentiated diamiction (poorly-sorted sediment in which particle sizes may range from clay to boulders). Used as a general term or subdivided as follows:
- dg Gravelly-matrix diamiction
 - ds Sandy-matrix diamiction
 - dt Silty-matrix diamiction
 - dy Clayey-matrix diamiction
- Note: Diamictions of glacial origin may be classified as one of the following varieties of till (shown on the map in parentheses):
- t Till, undifferentiated. Usually of late Wisconsinan age (deposited by the last glacial ice sheet).
 - ta Ablation till. Deposited during retreat of the late Wisconsinan ice sheet. Typically sandy, stony, and not very compact.
 - tl Lodgment till. Inferred to have been deposited at the base of the late Wisconsinan ice sheet. Usually very compact.
 - tf Flowtill. Deposited by slumping adjacent to glacial ice.
 - T Variably weathered till (usually a lodgment facies) of inferred pre-late Wisconsinan age.
- ORGANIC MATERIALS**
- og Organic-rich sediment (can be any organic material, including forest litter, wood, shells, etc.)
 - pt Peat (reserved for actual fibrous peat)
- OTHER MATERIALS**
- af Artificial fill (e.g. road fills, building sites, dumps)
 - bd Scattered boulders; interpreted as till where followed by (t)
 - rk Bedrock (observed in pit floor, boring, or natural exposure)
 - rs Rottenstone, disintegrated or weathered bedrock, saprolite,
 - u Unknown (material unidentified)
 - R Refusal (in test boring or well)
 - (f) Fossiliferous (used to indicate fossiliferous units within a sequence).

- 8s-b Materials data from shovel hole, hand-digger hole, natural exposure, or excavation (other than borrow pit).
- 56 Depth to bedrock from well (± is used to indicate minimum depth to bedrock), in feet below land surface
- Bedrock well
- Drilled overburden well
- Dug well
- ↓ Driven point
- ✦ 20fs,st Observation well with materials data
- ✦ 10gs/rk Test boring with materials data
- ✕ s-b Borrow pit, recently active at time of mapping, with materials data.
- ✕ s-p Borrow pit, evidently abandoned or in long disuse at time of mapping, with materials data where noted in remaining exposures. This symbol also indicates pits that have been reclaimed and no longer exist, but their former locations are evident from earlier reconnaissance work, air photos, or county soils maps published by the U. S. Department of Agriculture.
- ✕ Quarry
- Location of site for which a data sheet is on file at the Maine Geological Survey.
- 56 Depth to bedrock from seismic line, in feet below land surface
- + Bedrock outcrop

OTHER SOURCES OF INFORMATION

- Clinch, J. M., and O'Toole, P. B., 1999. Surficial geology of the York Harbor quadrangle, Maine. Maine Geological Survey, Open-File Map 99-107.
- Neil, C. D. (compiler), 1998. Significant sand and gravel aquifers in the York Harbor quadrangle, Maine. Maine Geological Survey, Open-File Map 98-132.
- Thompson, W. B., 1979. Surficial geology handbook for coastal Maine. Maine Geological Survey, 68 p. (out of print)
- Thompson, W. B., and Borns, H. W., Jr., 1985. Surficial geologic map of Maine. Maine Geological Survey, scale 1:500,000.

York Harbor Quadrangle, Maine

Surficial materials mapping by
J. Michael Clinch and Patrick B. O'Toole

Digital cartography by:
Robert A. Johnston

Robert G. Marvinney
 State Geologist

Cartographic design and editing by:
Robert D. Tucker
Bennett J. Wilson, Jr.

Funding for the preparation of this map was provided in part by the U.S. Geological Survey Cooperative Geologic Mapping (COGEOAMP) Program, Cooperative Agreement No. 14-08-0001-A0381 and the Maine Department of Environmental Protection.

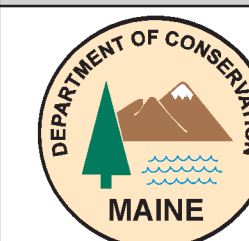

Maine Geological Survey

Address: 22 State House Station, Augusta, Maine 04333
 Telephone: 207-287-2801 E-mail: mgs@maine.gov
 Home page: <http://www.maine.gov/doc/nrmc/nrmc.htm>

Open-File No. 98-166

1998

SURFICIAL MATERIALS

Uses of Materials Maps

The data shown here may be used for a variety of purposes by landowners, planners, teachers, or anyone else wanting to know what lies beneath the land surface. For example, it may aid in the search for economically important deposits such as sand and gravel for aggregate or clay for bricks or pottery. Environmental issues such as the location of a suitable landfill site or the possible spread of contaminants are directly related to surficial materials information. Construction projects such as locating new roads, excavating foundations and utility lines, or siting new homes are also important uses of materials data.

Mapping Surficial Materials

When mapping the surficial geology or the extent of sand and gravel aquifers in a quadrangle, a geologist first makes observations about the surficial materials at a network of points throughout the area. These points of observation may be auger holes, road cuts, gravel pits, stream cuts, or other places where sediments are visible. The geologist describes the materials at each location using the size abbreviations shown in the explanation below the map at left. Sedimentary materials range in particle size from clay (<0.002 mm) to boulders (>256 mm or 10"). The observation points are plotted on the quadrangle and the resulting surficial materials map shows what is known about the distribution, thickness, and texture of sediments in the area.

By combining materials data with well and test hole data, seismic studies, other published information, and analysis of aerial photographs, the geologist then interprets the pattern of these materials to create a geologic map.

Surficial materials maps are often best used in conjunction with related maps such as surficial geology maps or significant sand and gravel aquifer maps. Refer to the list of related publications below at left.

Photographs

The photos below are examples of the various material sizes as they are observed in the field. The photo captions describe the materials and give the abbreviations used to represent them on the map at left. Inspection of the photos will give the map user a better sense of what the map units mean. Note especially the photos at the bottom of the page. These photos show interbedded layers of materials as they may often be seen in the field. Materials in a gravel pit are rarely all a single size, and these examples show their possible complexity.



Till over bedrock: d(t)/rk -- Road cut on Route 17 in Township D, showing thin layer of till overlying glacially eroded bedrock. Dark streaks on the rock face are wet areas.

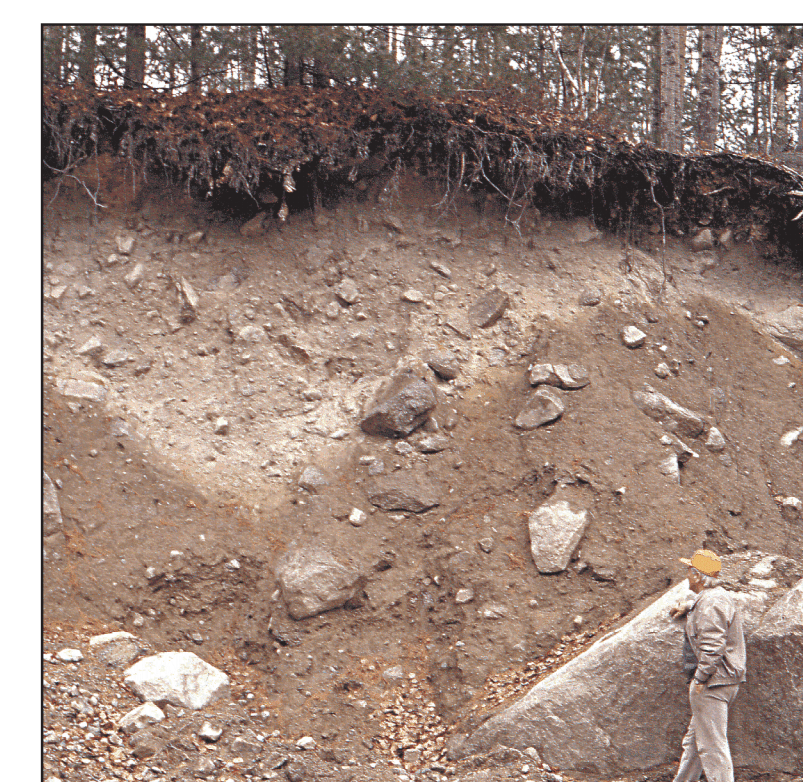

Till: ds(t) -- Borrow pit near Millinocket, exposing sandy, bouldery till. This stony till commonly occurs in areas of granitic bedrock.



Clayey silt over sand with pebble-cobble gravel: st,cy/s,p,c -- Borrow pit in Kennebec River valley, Pittston, showing glaciomarine sea-floor mud (Presumpscot Formation) overlying sand and gravel deposited in submarine fan at glacier margin.



Clay-silt: cy-st -- Coastal bluff in Brunswick, exposing a thick section of well-stratified glaciomarine sea-floor mud (Presumpscot Formation).

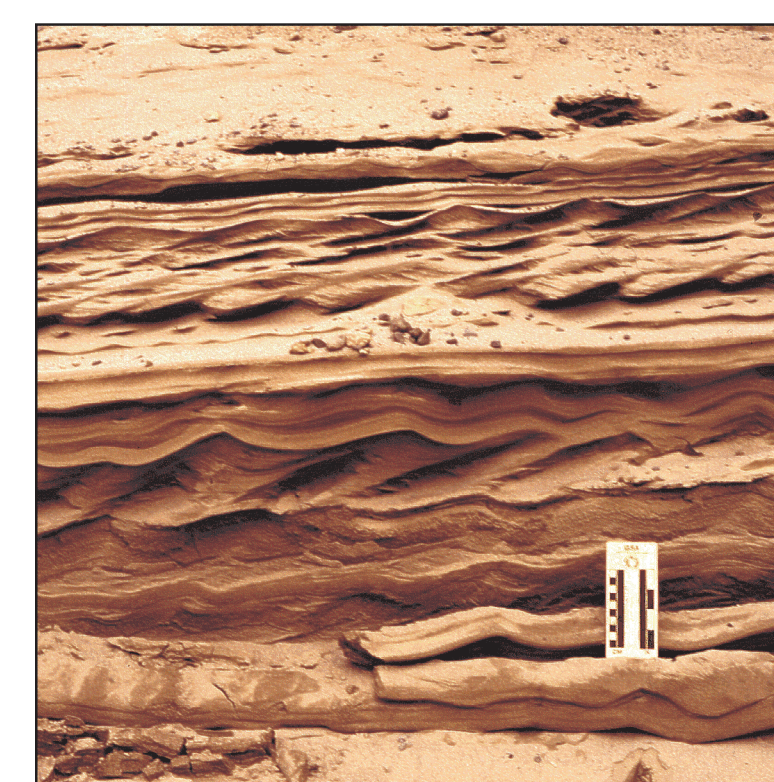

Sand: s -- Close-up of pit face in glaciomarine delta west of Dolby Pond, Millinocket, showing current ripples in sandy delta foreset beds. Scale card is graduated in centimeters and inches.

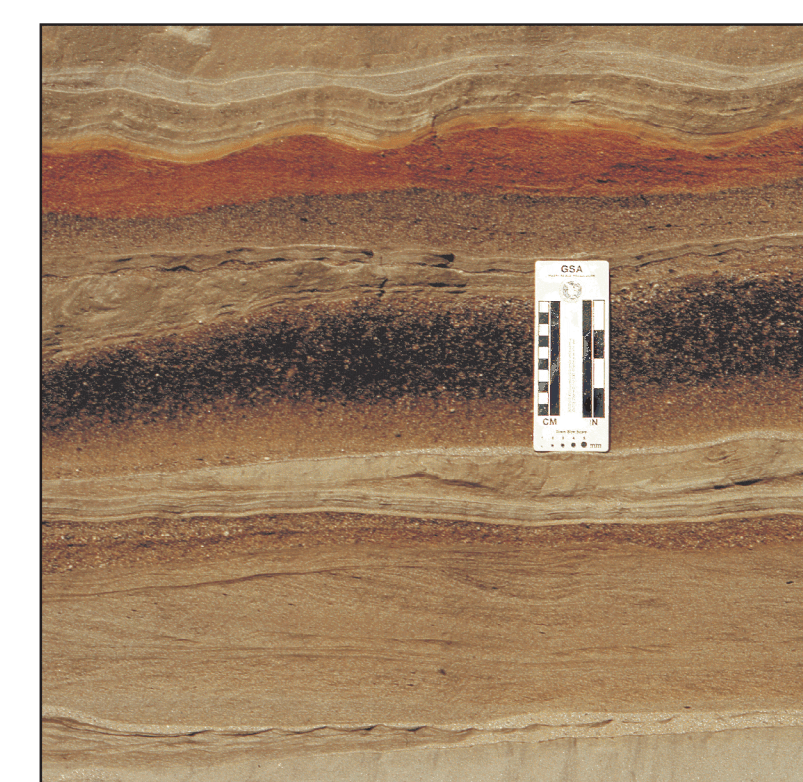

Sand (ranging from very fine-grained to very coarse): vfs-vcs -- Close-up of pit face in well-stratified sand beds deposited in glacial lake at lower end of Bear River valley, Newry.



Pebble to cobble gravel: p-c -- Pit in upper part of glaciomarine delta in Norridgecock, Kennebec River valley, showing massive gravel deposited by meltwater streams flowing across delta top.

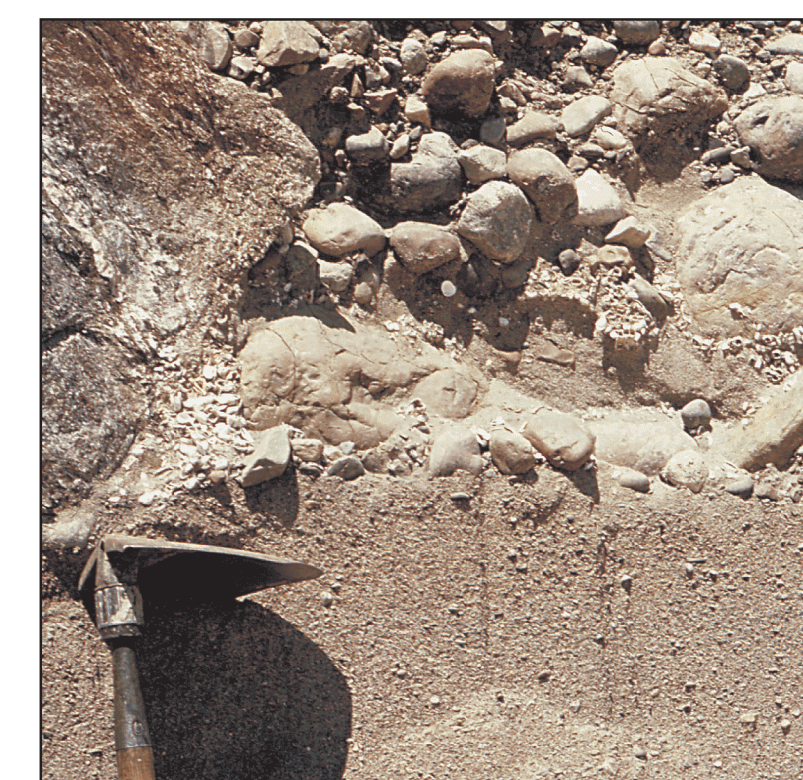

Pebble to boulder gravel (fossiliferous) over gravelly sand: p-b(f)/gs -- Close-up of pit face in marine nearshore deposit with fossil shells and barnacle-encrusted stones.

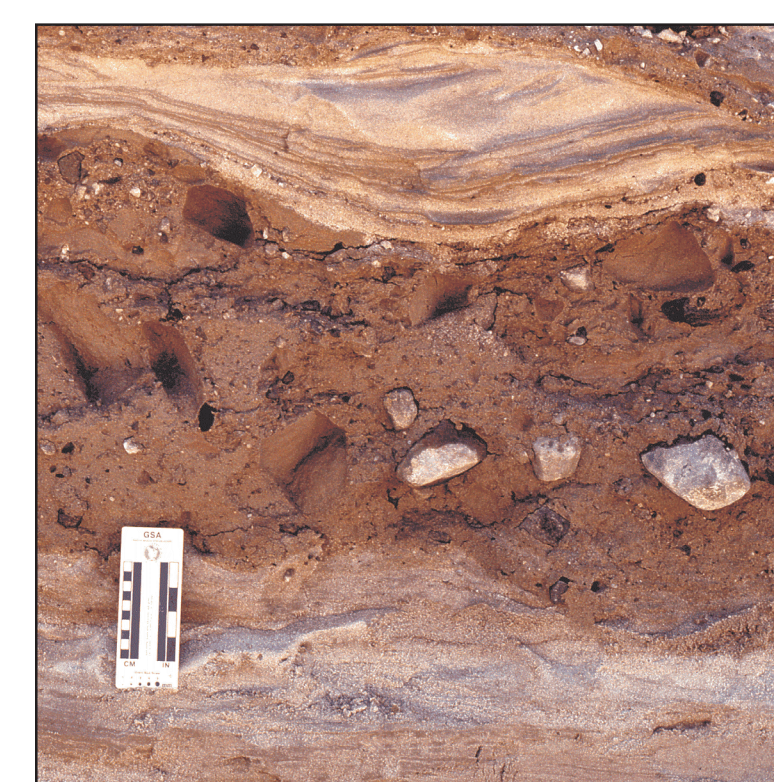

Sand with interbedded flowtill: s±ds(tf) -- Close-up of pit face in an end-moraine, Westbrook, showing part of a stony flowtill lens (center) deposited where glacier margin terminated in the sea.



Gravel over sand over gravel: p-cs/p-c -- Close-up of pit face showing intertill(?) sand unit between pebble-cobble gravel beds in upper part of glaciomarine delta, Columbia Falls.