

Distribution of optimum reactive power in the presence of wind power plant and considering voltage stability margin using Genetic Algorithm and Monte Carlo methods

Nima Khosravi^{1*}, Morteza Beiranvand², Hassan Barati²

¹Department of Electrical and Instrumentation Engineering, Central Office Arp Company, Tehran, Iran; ²Faculty of Electrical and Computer Engineering, Islamic Azad University, Dezfoul, Iran

*E-mail: khosravi.n@arpc.ir

Received for publication: 11 November 2015.

Accepted for publication: 29 July 2016.

Abstract

Network reactive power resources are important factors affecting voltage stability that somehow can have effect on safety margin of system voltage stability. In this study, the question of relationship between distribution of optimum reactive power and voltage stability margin in presence of wind power plant has been performed. For this reason, to minimize the reactive power costs due to the synchronous generator, synchronous condenser and the capacitor bank and also given the importance maximization the voltage stability margin and considering equality and inequality constraints, has been used from a nonlinear programming method. In here, problem by using Genetic Algorithm in order to minimize cost of reactive power and with considering the voltage stability margin based on Monte Carlo simulation method. In MATLAB software has been optimized. Problem simulation over 30-bus network has been solved for two state low load and full load and with two scenarios was run and analyzed.

Keywords: Genetic Algorithms, Voltage stability, Load Distribution of Reactive power, Monte Carlo

Introduction

In recent decades, according to some global challenges such as the environment, energy crisis and recession, renewable sources for electricity production are taken into consideration. Among these renewable sources, wind energy because of easier access has been used always in power generation as a suitable source. The main problem with the use of wind energy, is instability because of uncertainty in the speed and fluctuations of wind. In this study, to resolve this problem, we have used of fixed speed turbines. Power system operators should consider various issues in their planning such as voltage stability, and reactive power market. Ignoring of these parameters will cause a lot of problems such as power system instability. In this study, to minimize the costs of reactive power due to the synchronous generator, synchronous condenser and capacitor banks and also maximization the voltage stability margin and taking into account equal and unequal constraints will be used from a nonlinear programming method. Which ultimately an optimization algorithm will be utilized to minimize the cost of reactive power considering the voltage stability margin based on Monte Carlo simulation method in software MATLAB, and by implementing on 30-bus standard network, simulation results will be extracted and will be analyzed. The purpose of design and operation of a power system, is supply of loads required by the network. Studies of load flow address the calculating electric quantity of power system in steady state for specified and known loads. These quantities include voltage buses, active and reactive power produced by generators and active and reactive power current in transmission lines. In fact design and development of systems

in future due to the growing load and the necessity of adding generators, transformers and new lines in the system is not possible without study of load distribution. Also study of load distribution has fundamental role and is responsible for examining present state of a system and deciding about best conditions operation of that (Kazemi, 1999).

Approximately thirty percent of primary energy resources in the world are consumed for generates electrical energy and almost all of the electrical energy transmitted and distributed by alternating current with a frequency of 50 or 60 hertz. Currently more than ever design and operation of power systems is important with maximum efficiency and highest level of reliability and safety (Kundur, 1997). One of the very important and vital behavioral characteristics for power system is their security. Existence of security for a power system, represents the ability of that system to maintain their stability against the incidence of disorders and disturbances. Voltage instability Phenomena is of important factors threatening security of power systems. Network reactive power resources, network structure and model of network buses active power production are effective factors on voltage stability. Each of these factors, could be affected somehow on safety margin of system voltage Stability and in the other words, for each of them critical situations can be defined.

Review of literature

Evaluate the effect of wind fluctuations in reactive power market considering voltage stability, on a 14-bus system is performed by Monte Carlo method which ultimately leading to a multi-objective function to coordinate between reactive power market and reliability of the power system (kargarin and Raofat, 2011). In order to reactive power management in distribution network using wind power plant, a cost-effective combination of capacitor banks and D-STSTCOM Is being used that results indicate that these compensator cause to increase stability and reducing the cost of reactive power (Roy, et al, 2013). Using the PSO optimization method to combine wind turbines and solar energy for electricity supply of a residential complex independently of the power network and include issues such as Investment expenditures, maintenance and production. The problem of economic load distribution, is one of the most important topics In exploitation and controlling modern power systems. The purpose of the economic load distribution problem solving, is the scheduling of unit production output In such a way that Provide required load demand With minimum operating costs, with satisfying all equality and inequality constraints of unit and system. Another field of the application of PSO algorithm in power systems, is used to solve the problem of optimum load flow or distribution (OPF). Economic load distribution, is an optimization problem that minimize total cost of heating fuel, Total production, total active power losses with satisfy the physical and technical constraints on the network (Mohammadi et al., 2012). Mathematical model of a DFIG under the terms of distorted voltage has been provided. Electromagnetic torque fluctuations and active powers and reactive moment stator Have been described, when the network voltage Is distorted as harmonic. And eventually Four alternative control objective, to improve system response during the harmonic distortion of the network, has been suggested (Jiabing, et al, 2011). Hailiang et al. (2012) has focused on balanced control and capability of DFIG based on the wind turbine in terms of unbalanced and distortion voltage. The mathematical model of DFIG outset is considered negative sequence voltages and a network of low-order harmonic. According to this model, moment active / reactive power and electromagnetic torque defined in detail. A variable speed DFIG based on the WECS, is used simultaneously for power generation with network harmonic filtering. Simulation for WECS with 3 MW power with DFIG, has been implemented at two different speeds (8 And 12 meters per second). The results show that In addition to power

generation, harmonic filterings of network current by using the WECS have decreased approximately 4%. (Kesraoui, et al, 2014).

Problem solving Algorithm

The purpose of this study includes two aspects; In a first aspect, is The optimum reactive power flow management simulation with presence of wind power considering voltage stability indicator; and other aspects, is the performing study of optimum reactive power distribution between compensators and reactive power production resources considering stability of the network voltage according to the necessity of using a compensator devices in reactive power supplying. In here we are facing with an Multi-objective optimization problem, as a first step, the purpose is to reduce cost of system reactive power that these costs include payment costs for reactive power and also reducing of line losses. In the second stage the purpose is to maximize security level and voltage stability of the network. This problem will be analyzed both in definite state and probable state for wind power generation on a 30-bus standard network. But before that, it is necessary to provide explanations about the ways that they are used In implementation of system under study.

Monte Carlo Method

Monte Carlo method is a method of calculating the results, based on probability and statistics techniques from random samples or stoke steak. Monte Carlo method requires a mathematical - statistical model with two determinable and random general component, for the variable under consideration. Monte Carlo methods in general is at first by a generator (here generator is the rand command) series of random numbers is generated from a uniform probability distribution with an initial value. Then we convert random numbers to a series of random numbers with uniform probability distribution between zero and one. We also used these series as input data of relationship to produce variable which its distribution is known. Now we consider probable ranges and assign probability of each interval to a group. Final results represent that desired output are probable. So in here, powers of this units, using the probability that obtained from probability distribution function of wind unit power, put as Monte Carlo problem input and obtain probable production power of Wind unit.

Modeling of wind based on the weibull distribution

Currently, various methods have been proposed to model the wind speed. for example, using time series and Markov transition matrix of wind model is one of these items. (Shahidehpour, et al, 2002) Also wind hourly velocity, using simulated time series where the wind speed per hour, depends on the wind speed In the previous time (Foley, et al, 2010). That in here a realistic assumption is that distribution function of wind blowing speed has Weibull probability distribution. With regard to this probability function of wind blowing, can be achieved to the amount of wind power production based on wind speed. Weibull function in the general case is expressed as equation (1):

$$f(x; \lambda, k) = \begin{cases} \frac{k}{\lambda} \left(\frac{x}{\lambda}\right)^{k-1} e^{-\left(\frac{x}{\lambda}\right)^k}, & x \geq 0 \\ 0, & x \leq 0 \end{cases} \quad (1)$$

In this function, x is random variable, k is shape variable and λ is a scale variable. Figure 1 shows Weibull functions for different values of k.

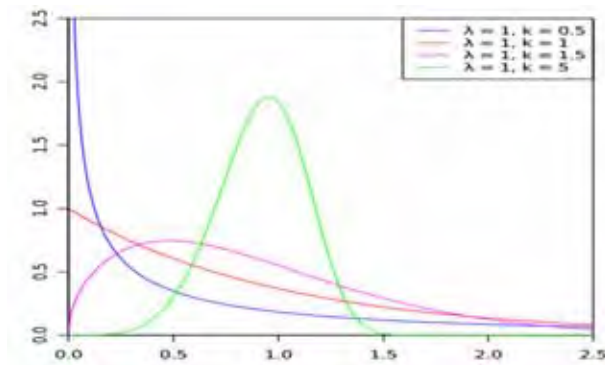

Figure 1: Weibull function for different values of k

Considering wind speed as Weibull probability function, With characteristics of $\lambda = 10$ and $k = 1/8$ Wind power production curve would be as Figure 2. Figure 2 shows sampling process from Weibull probability distribution function and output power of wind turbine. To enter the uncertainty of wind power plants, different occurrence able scenarios and their probability are determined. For determine scenarios for wind power plant production, twenty points from the curve of wind power production, is selected as instance. Occurrence or happening probability of each instance is achieved with the integration of under curved surfaces of Weibull distribution function.

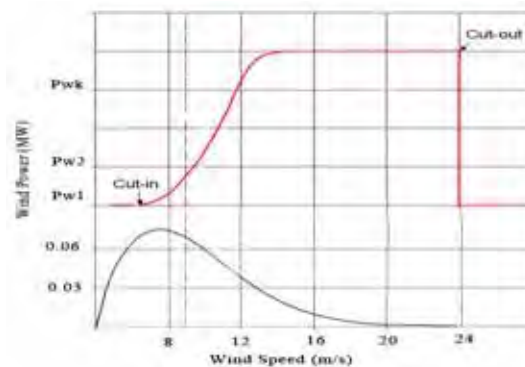

Figure 2: process of wind power sampling

The cost of reactive power

Production sources are reactive power generators, condenser and capacitor banks. The generator cost function is expressed as equation 2:

$$Cost(Q_{gt}) = a_{q,t} Q_{gi}^2 + b_{q,t} Q_{gi} + c_{q,i} \tag{2}$$

Which include cost of exploitation, investment costs and missed opportunity of generator. The coefficients a, b and c in this phrase are indicative operating costs coefficient. Synchronous condenser cost function is expressed as the equation 3:

$$Cost(Q_{ci}) = (\beta_{ci} + \sigma_{ci}) Q_{ci} \tag{3}$$

That in this relation σ is operating costs and β is investment coefficient. Capacitor bank cost function is such as a synchronous condenser but with the difference that cost of its exploitation is very low and can be overlooked from exploitation coefficient σ .

Genetic Algorithm

Genetic Algorithms, perform searching by a population of points which the number of points is also important, this means that high population numbers increase calculations and the optimum solution is slowly approaching and low population numbers does not cover search space well and

may be the algorithm is stopped in a local solution. GA uses of function value in different points of the search space and doesn't need to know derivative of the function or other information of function, indeed GA uses statistical laws and neither of computational laws; GA have been implemented in different ways and various operators. The initial values of mentioned algorithm have displayed in Table 1. Diagram block of GA which is used in our study has displayed in Figure 3. Performing algorithm operations required to implement three steps; These steps include initialization, renewing and at the end replacement.

Table 1: Parameters of Genetic Algorithms

Parameter	value
Mutation rate	30%
Intersection rate	50%
Population numbers of chromosomes	250
The number of algorithm iterations	350

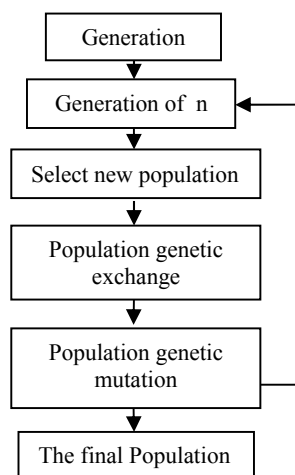

Figure 3: Flowchart of expressed algorithm

The system under study and its characteristics

Intended problem for IEEE 30-bus network are presumed. Figure 4 points out under study network.

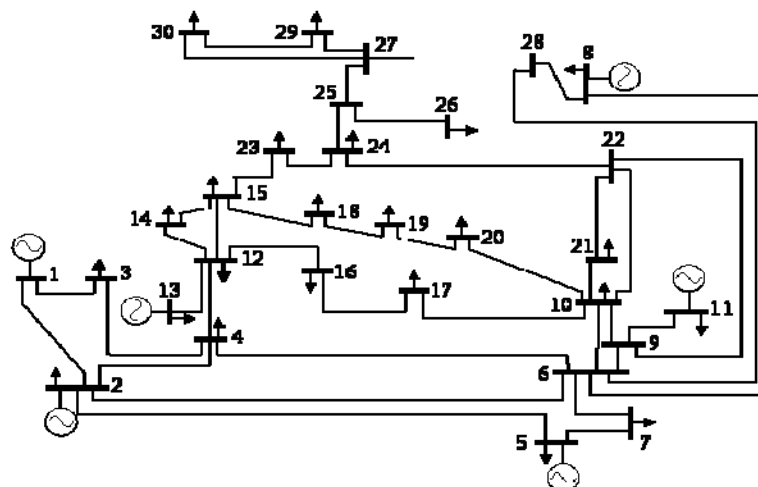

Figure 4: under study 30-bus networks

In this network generators values, transmission lines and buses is expressed in appendix A, synchronous condenser and capacitor banks used in the network, are connected to the buses 22 and 27.

Fixed speed wind turbine (FSWT)

Fixed velocity wind turbines are used extensively in power system and are considered one of the energy production renewable resources. Fixed velocity wind turbines are of clean energy resources that on the other hand, also are the consumer of reactive power. Figure 5 shows the active power generated by units of FSWT according to various studies; That this curve is ratio of power to the wind velocity which is characterized by the turbine production company.

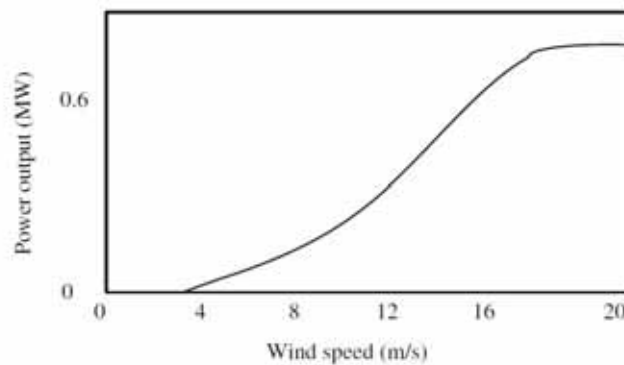

Figure 5: Output power of FSWT

As it is evident active power production of wind units has direct relationship with wind velocity and since the wind velocity is a completely random process, power this units Is a random variable. On the other hand, constant velocity turbines are reactive power consumers in power system which on this basis consumed reactive power relation is expressed as the equation 4:

$$Q_e = \frac{[X_m X_{l2} S^2 (X_m + X_{l2}) + X_{l1} S^2 (X_m + X_{l2})^2 + R_2^2 (X_m + X_{l1})] |V|^2}{[R_1 R_2 + S(X_m^2 - (X_m + X_{l2})(X_m + X_{l1}))]^2 + [R_2(X_m + X_{l2}) + S R_1(X_m + X_{l2})]^2} \tag{4}$$

According to the above equation, we have:

$$S = \min \frac{-b \pm \sqrt{b^2 - 4ac}}{2a} \tag{5}$$

$$a = P_e R_1 R_2 (X_m + X_{l2})^2 + P_e (X_m X_{l2} + X_{l1} (X_m + X_{l2}))^2 - |V|^2 R_1 (X_m + X_{l2})^2 \tag{6}$$

$$b = 2 P_e R_1 R_2 X_m^2 - |V|^2 R_2 X_m^2$$

$$c = P_e R_2^2 (X_m + X_{l2})^2 + P_e (R_1 R_2)^2 - |V|^2 R_1 R_2^2$$

In this relation:

Pe: FSWT unit power

V: voltage in terms of KV

R1, Xl1, R2, Xl2, Xm, Xc are characteristic resistances and reactances of turbine which are set onto following values. Table 2 shows characteristic of FSWT wind turbine used In under study network.

Table 2: Characteristics of FSWT wind turbine

Xc	Xm	Xl2	R2	Xl1	R1	V
2.5561	2.5561	0.127225	0.01690	0.09212	0.05986	0.69

Simulation Results

Simulation results of problem is obtained for two scenarios low load and full load, in first scenario which system load is low, it is also less lines load, energy cost of \$ 15 per MWh, in the second scenario which system load is heavier, the lines load are also heavy, energy cost of \$ 25 per

MWh have been considered. In order to consider behavior of wind unit and importance of proposed probable method, we consider two scenarios for behavior of the wind unit: In the first case, low load (minimum), probability of production is considered for wind unit, which in this scenario of deterministic state, production forecast and Monte Carlo technique are also included. The second state has the same conditions of the first scenario with the exception that the initial conditions of problem At full load (maximum) Has been implemented. Table 3, shows load and power generated by every buses along with voltage and its voltage angle under low load and table 4 shows output of above at full load after solving power flow problem.

Table 3: Load and productivity of buses (Power flow) at low load state

Bus no	V pu	Angle degree	P1 MW	Q1 MW	Pg MW
1	1.0500	0	-1.541	0.373	0
2	1.0500	0.0574	-0.393	-0.403	0.217
3	1.0808	0.1069	0.024	0.012	0.024
4	1.0879	0.1283	0.076	0.016	0.076
5	1.0731	0.1101	0	0	0
6	1.0949	0.1501	0	0	0
7	1.0949	0.1412	0.228	0.109	0.228
8	1.1061	0.1581	0.300	0.300	0.300
9	1.0917	0.2486	0	0	0
10	1.0942	0.3001	0.600	0.020	0.600
11	1.0917	0.2486	0	0	0
12	1.1133	0.2196	0.112	0.750	0.112
13	1.0700	0.1761	-0.37	-0.323	0
14	1.1188	0.2478	0.062	0.016	0.062
15	1.1223	0.2654	0.082	0.025	0.082
16	1.1113	0.2585	0.035	0.018	0.035
17	1.1042	0.2911	0.090	0.058	0.090
18	1.1499	0.3542	0.032	0.009	0.032
19	1.1653	0.4018	0.950	0.034	0.950
20	1.1472	0.3783	0.022	0.007	0.022
21	1.0862	0.2987	0.197	0.112	0.197
22	1.0800	0.2960	0.316	-0.650	0
Bus no	V pu	Angle degree	P1 MW	Q1 MW	Pg MW
23	1.1000	0.2539	0.188	-0.200	0.032
24	1.1417	0.2580	0.150	0.670	0.150
25	1.0907	0.2629	0.010	0	0.010
26	1.1065	0.2692	0.035	0.023	0.035
27	1.0500	0.2589	-0.290	-0.234	0
28	1.0952	0.1634	0	0	0
29	1.1118	0.3690	0.370	0.009	0.370
30	1.1028	0.3470	0.120	0.019	0.120

Table 4: Load and productivity of buses (Power flow) at full load state

Bus no	V pu	Angle degree	P1 MW	Q1 Mvar	Pg MW
1	1.0500	0	-4.432	1.799	0
2	1.0500	0.1779	-0.176	0.022	0.434
3	1.0742	0.3025	0.048	0.024	0.048
4	1.0891	0.3619	0.152	0.032	0.152
5	1.0701	0.3104	0	0	0
6	1.1016	0.4145	0	0	0
7	1.1056	0.3880	0.456	0.218	0.456
8	1.1242	0.4321	0.600	0.600	0.600
9	1.0740	0.6555	0	0	0
10	1.0850	0.7827	1.200	0.040	1.200
11	1.0740	0.6555	0	0	0
12	1.1340	0.6292	0.224	1.500	0.224
13	1.0900	0.5873	-0.370	-0.335	0
14	1.1368	0.6897	0.124	0.032	0.124
15	1.1405	0.7318	0.164	0.050	0.164
16	1.1235	0.7029	0.070	0.036	0.070
17	1.1057	0.7653	0.180	0.116	0.180
18	1.1806	0.8989	0.064	0.018	0.064
19	1.2091	0.9861	1.900	0.068	1.900
20	1.1752	0.9409	0.044	0.014	0.044
21	1.0870	0.7887	0.394	0.224	0.394
22	1.0800	0.7856	-0.316	-0.941	0
Bus no	V pu	Angle degree	P1 MW	Q1 Mvar	Pg MW
23	1.1000	0.7392	-0.156	-0.541	0.064
24	1.1968	0.7266	0.300	1.340	0.300
25	1.1168	0.7311	0.020	0	0.020
26	1.1472	0.7429	0.070	0.046	0.070
27	1.0500	0.7208	-0.290	-0.150	0
28	1.1058	0.4503	0	0	0
29	1.1580	0.9330	0.740	0.018	0.740
30	1.1420	0.8920	0.240	0.038	0.240

Genetic Algorithm Output

Figure 6 shows Genetic Algorithm convergence output (cost decreasing trend) after running the program. As it is evident the algorithm is reached to convergence before repeating 250. We run all steps for described scenario and also 4 modes of consideration wind unit.

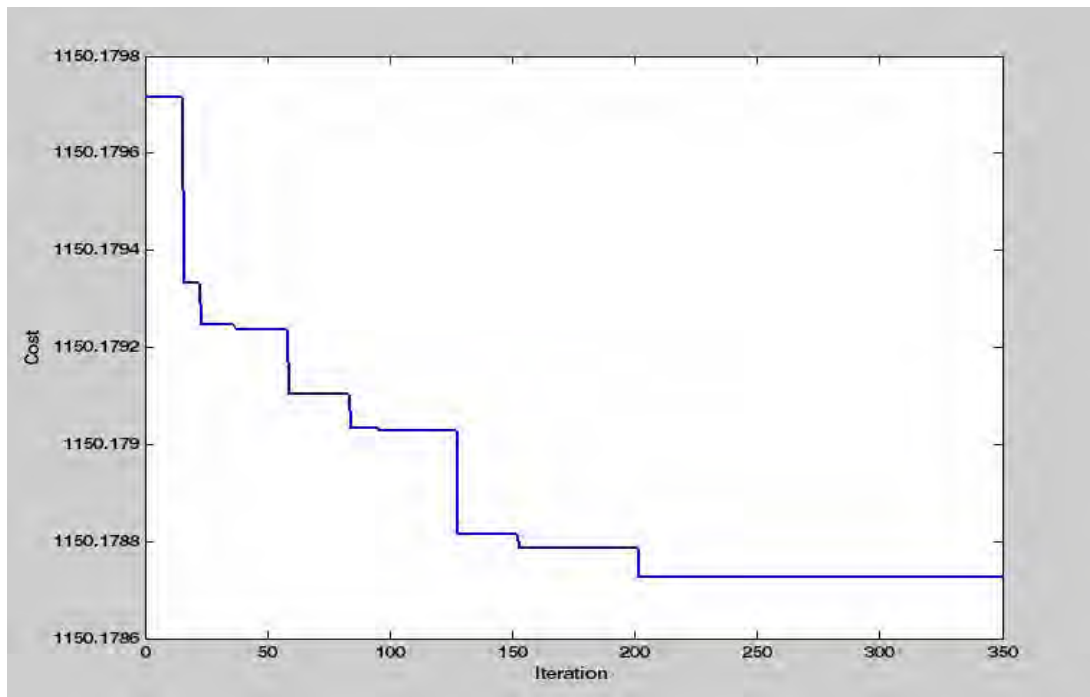

Figure 6: Cost reduction Trends In Genetic Algorithm used In problem

The first scenario

Table 5 of program output, shows the first scenario, for reactive power of 30-bus network shows; Given that the network is in low load state, voltage index is small and the system is stable. Modes 1 to 3 are deterministic states of wind unit production and fourth state is probable state of wind unit production. For producing scenarios of wind unit as stated earlier has been used of Weibull probability distribution function with according to the technique of Monte Carlo its probabilities are specified as in Table 6. To create different scenarios of wind unit behavior It has been assumed that the wind speed at constructed wind power plant has Weibull probability distribution function with scale parameters $m / s^{2/8}$ and the slope is 8.1. For modeling the uncertainty of wind power plants, probable scenarios and probability of their occurrence is determined.

Table 5: Program output for reactive power of 30-bus network in the first scenario

	State 1-1	State 1-2	State 1-3	State 1-4
Generator 1	0.82	0.72	0.91	0.92
Generator 2	0.64	0.27	0.43	0.54
Generator 3	0.2	0.18	0.25	0.27
Generator 4	0.47	0.1	0.24	0.57
Generator 5	0.13	-0.01	0.19	0.1
Generator 6	0.19	0.13	0.33	0.13
Synchronous condenser	-0.3	-0.43	-0.19	-0.33
Capacitor	0.29	0.03	0.28	0.24
The final cost	383.39	437	414.4	389.5
Lmn voltage index	0.174	0.192	0.1934	0.1837

In here for preparation scenarios of wind power plant production, 20 points of turbine power production curve, are selected as sample. According to what is shown in Figure 7, occurrence probability of each sample, Is equal to the integration of Hatch-hit surfaces of Weibull distribution function. With assumption of determining maximum production of 60 MW for wind power plant, wind power production scenarios are obtained as shown in Table 6.

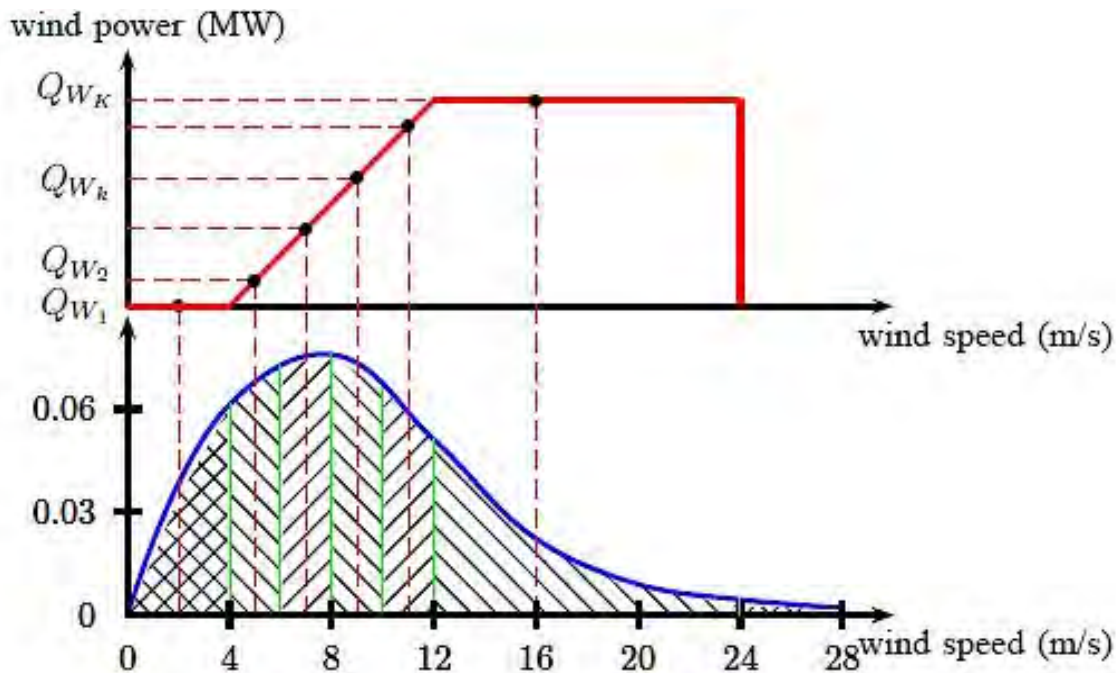

Figure 7: Relationship between probability function of wind turbine output power and wind speed

Table 6: Event Probability of wind unit production Different Scenarios

Scenario Number	1	2	3	4	5	6	7	8	9	10
Production Power	0	1.67	5	8.33	11.66	15	18.33	21.66	25	28.33
Probability	0.2412	0.0423	0.0432	0.0435	0.0434	0.0429	0.0420	0.0408	0.0393	0.0376
Scenario Number	11	12	13	14	15	16	17	18	19	20
Production Power	31.66	35	38.33	40	41.66	45	48.33	51.66	55	60
Probability	0.0358	0.0338	0.0317	0.0295	0.0274	0.0252	0.0231	0.0211	0.0195	0.1364

Now wind unit production probabilities have been involved In problem Using Monte Carlo techniques and we obtain its production as probable or stoke steak. Fourth states of the table shows stoke steak state of wind unit power generation.

The second scenario

In this scenario, network has been in full load and lines endured so much load as a result, voltage stability index has got closer to the one. Also in this scenario states 1 to 3 are shown for deterministic behavior of wind unit and state 4 for its possible behavior in Table 7. In addition, first objective function means cost-minimization and second objective means maximizing voltage stability in index bus Lmn, which is voltage stability index is located in objective function of algorithm and in fact, both the purpose have been pursued. On the other side, stability of the network and system voltage as system basic constraint also has been considered.

Table 7: Program output for 30-bus network reactive power in second scenario

	state1-1	state1-2	state1-3	state1-4
Generator 1	0.97	0.98	0.98	0.96
Generator 2	0.61	0.38	0.58	0.36
Generator 3	0.24	0.24	0.23	0.15
Generator 4	0.45	0.1	0.36	0.29
Generator 5	0.12	0.18	0.36	0.21
Generator 6	0.15	0.13	0.12	0.16
Synchronous condenser	0.1	0.1	0.93	-0.02
Capacitor	0.3	0.3	0.28	0.29
The final cost	450.15	476.79	456.3	448
Lmn voltage index	0.4340	0.5691	0.5357	0.474

Conclusions

In this study, the question of relationship between optimum reactive power distribution and voltage stability margin in presence of wind power plant has been done. For this purpose, to minimize the cost of reactive power due to the synchronous generator, synchronous condenser, capacitor bank and also maximize the voltage stability margin and taking into account equal and unequal constraints was used from a nonlinear programming method. Also problem has been optimized using Genetic Algorithm in order to minimize reactive power costs and voltage stability margin on basis of Monte Carlo method in MATLAB software. Simulation over 30 buses network for two state low load and full load were implemented and analyzed, that simulation results indicate that program output according to the use of Weibull probability distribution function and Monte Carlo method in order to manage 30 buses network reactive power in first scenario, since the network is in a state of low load then index of voltage is low and system is stable. Also for providing wind power plant production scenarios, 20 points of turbine power production curve are selected as sample. Occurrence probability of each sample, is equal to assumption of maximum specified production of 60 MW for wind power, with the integration of Hatch-hit areas of Weibull distribution function, as a result various wind power generation scenarios is obtained. At full load, Lines are bearing heavy loads as a result, voltage stability index is got closer to one; This means that system has not primary stability which had experienced at low load and additional costs is consumed. At the end we hope that one of the challenges for engineers in reactive power flow management and voltage stability margin were placed under review.

Appendix A

Table 8: Values and under study network lines data's

Line number	From bus	To bus	Line impedance (p.u)		Half line charging Susceptance (p.u)	MVA rating	Annual cost ($\times 103\$/hr$)
			Resistance	Reactance			
1	1	2	0.02	0.06	0.03	130	216.6125
2	1	3	0.05	0.20	0.02	130	307.2875
3	2	4	0.06	0.04	0.02	65	509.9500
4	2	5	0.05	0.23	0	130	721.5250
5	2	6	0.06	0.12	0.02	65	168.1750
6	3	4	0.01	0.08	0	130	700.000
7	4	6	0.01	0.09	0	90	474.3000
8	4	12	0	0.21	0	65	554.1250
9	5	7	0.05	0.56	0.01	70	62.2000
10	6	7	0.03	0.08	0	130	130.2000
11	6	8	0.01	0.06	0	32	104.6250
12	6	9	0	0.20	0	65	306.9000
13	6	10	0	0.21	0	32	20.9250
14	6	28	0.07	0.11	0.01	32	210.800
15	8	28	0.06	0.21	0.02	32	54.250
16	9	11	0	0.09	0	65	83.7000
17	9	10	0	0.08	0	65	927.6750
18	10	20	0.09	0.15	0	32	117.8000
19	10	17	0.03	0.14	0	32	167.4000
20	10	21	0.03	0.26	0	32	160.4250
21	10	22	0.07	0.13	0	32	195.3000
22	12	13	0	0.12	0	65	15.1125
23	12	14	0.12	0.12	0	32	30.2250
24	12	15	0.07	0.22	0	32	97.6250
25	12	16	0.01	0.21	0	32	179.0250
26	14	15	0.22	0.19	0	16	124.7750
27	15	18	0.11	0.13	0	16	80.6000
28	15	23	0.10	0.07	0	16	100.7500
29	16	17	0.08	0.21	0	16	146.4750
30	18	19	0.06	0.22	0	16	235.6000
Line number	From bus	To bus	Line impedance (p.u)		Half line charging Susceptance (p.u)	MVA rating	Annual cost ($\times 103\$/hr$)
			Resistance	Reactance			
31	19	20	0.03	0.13	0	32	186.000
32	21	22	0.01	0.18	0	32	166.2375
33	22	24	0.11	0.22	0	16	40.3000
34	23	24	0.13	0.27	0	16	65.1000
35	24	25	0.19	0.33	0	16	210.8000
36	25	26	0.25	0.38	0	16	204.600
37	25	27	0.11	0.21	0	16	83.7000
38	27	29	0.22	0.4	0	16	160.4250
39	27	30	0.32	0.60	0	16	90.6750
40	28	27	0	0.40	0	65	223.2000
41	29	30	0.24	0.45	0	16	216.6125

Table 9: Values and under study network buses information's

Bus Number	Bus Voltage		Generation		Load		Reactive power(MVAR)	
	Magnitude (p.u)	Phase angle (degree)	Real power (MW)	Reactive power (MVAR)	Real power (MW)	Reactive power (MVAR)	Qmin (MVAR)	Qmax (MVAR)
1	1	0	0	0	24.963	-4.683	-20	150
2	1	0	21.7	12.7	60.97	27.677	-20	60
3	1	0	2.4	1.2	0	0	0	0
4	1	0	7.6	1.6	0	0	0	0
5	1	0	0	0	0	0	0	0
6	1	0	0	0	0	0	0	0
7	1	0	22.8	10.9	0	0	0	0
8	1	0	30	30	0	0	0	0
9	1	0	0	0	0	0	0	0
10	1	0	5.919	2	0	0	0	0
11	1	0	0	0	0	0	0	0
12	1	0	11.2	7.5	0	0	0	0
13	1	0	0	0	37	13.949	-15	44.7
14	1	0	6.2	1.6	0	0	0	0
15	1	0	8.2	2.5	0	0	0	0
Bus Number	Bus Voltage	Generation	Load	Reactive power (MVAR)	Bus Number	Bus Voltage	Generation	Load
16	1	0	3.5	1.8	0	0	0	0
17	1	0	9	5.8	0	0	0	0
18	1	0	3.2	0.9	0	0	0	0
19	1	0	9.5	3.4	0	0	0	0
20	1	0	2.2	0.7	0	0	0	0
21	1	0	19.669	11.20	0	0	0	0
22	1	0	0	0	31.59	40.34	-15	62.5
23	1	0	3.2	1.6	22.2	8.13	-10	40
24	1	0	15	6.70	0	0	0	0
25	1	0	1.00	0	0	0	0	0
26	1	0	3.50	2.30	0	0	0	0
27	1	0	0	0	28.91	10.97	-15	48.7
28	1	0	0	0	0	0	0	0
29	1	0	3.659	0.90	0	0	0	0
30	1	0	12.00	1.90	0	0	0	0

Table 10: Regulative values of used generators in under study network

Generator Number	Pmin (MW)	Pmax(MW)	Ai (\$/(MWhr) ²)	Bi (\$/(MWhr) ²)	Ci (\$/hr)
G1	0	80	0.00375	2.0000	0.0000
G2	0	80	0.01750	1.7500	0.0000
G3	0	50	0.06250	1.0000	0.0000
G4	0	55	0.00834	3.2500	0.0000
G5	0	30	0.02500	3.0000	0.0000
G6	0	40	0.02500	3.0000	0.0000

Acknowledgments

In Here we thank Mr. Mohsen Khosravi and M. ghamsari that with their guidance helped us to write this article.

References

- Ahad Kazemi (1999), Electrical power systems, Volume II, University of Science and Technology, Tehran, Iran;
- Foley, AM, ÓGallachóir, BP, Hur, J, Baldick, R, McKeogh, EJ, (2010) A strategic review of electricity systems models Energy, 35-45;
- Hailiang, Xu, Jiabing, Hu ; Yikang, He (2012) Integrated modeling and enhanced control of DFIG under unbalanced and distorted grid voltage conditions , Energy Conversion, IEEE Transactions, 27(3), 725 – 736;
- Jiabing, Hu, Heng, Nian ; Hailiang, Xu ; Yikang, He (2011) Dynamic modeling and improved control of DFIG under distorted grid voltage conditions , Energy Conversion, IEEE Transactions, 26 (1), 163 – 175;
- Kargarin, A, Raoofat, M., (2011) Stochastic reactive power market with volatility of wind power considering voltage security, Elsevier Ltd, Energy, 36, 2565-2571;
- Kesraoui, M., Chaib, A., Meziane, A., Boulezaz, A. (2014) Using a DFIG based wind turbine for grid current harmonics filtering , Energy Conversion and Management, 78, 968–975;
- Mohammadi, M., Hosseian, S.H., Gharehpetian, G.B., (2012) Optimization of hybrid solar energy sources/wind turbine systems integrated to utility grids as microgrid (MG) under, Science Direct, Solar Energy, 86, p 112-125;
- Prabha Kundur, (1997), Stability and Control of Power Systems, Volume II, tr. H. Seifi and khaki Sedigh Ali , Tarbiat Modarres University, Tehran;
- Roy, N.K., Pota, H.R., Hossain, M.J., (2013) Reactive power management of distribution networks with wind generation for improving voltage stability , Elsevier Ltd, Renewable Energy ,58, 85-94;
- Shahidehpour, M, Yamin, H, Li, Z.(2002) Market operations in electric power systems, New York: Wiley.