

## Union College Union | Digital Works

---

Honors Theses

Student Work

---

6-2011

# Micro-PIV of Self-Propelling Bi-Slugs in a Micro Channel

Lilla M. Safford Smith

*Union College - Schenectady, NY*

Follow this and additional works at: <https://digitalworks.union.edu/theses>

 Part of the [Mechanical Engineering Commons](#)

---

### Recommended Citation

Safford Smith, Lilla M., "Micro-PIV of Self-Propelling Bi-Slugs in a Micro Channel" (2011). *Honors Theses*. 1068.  
<https://digitalworks.union.edu/theses/1068>

This Open Access is brought to you for free and open access by the Student Work at Union | Digital Works. It has been accepted for inclusion in Honors Theses by an authorized administrator of Union | Digital Works. For more information, please contact [digitalworks@union.edu](mailto:digitalworks@union.edu).

Micro-PIV  
of Self-Propelling Bi-Slugs  
in a Micro Channel

By

Lilla M. Safford Smith

\* \* \* \* \*

Submitted in partial fulfillment  
of the requirements for  
Honors in the Department of Mechanical Engineering

UNION COLLEGE  
June, 2011

## ABSTRACT

SMITH SAFFORD, LILLA                      Micro-PIV of Self-Propelling Bi-Slugs in a  
Micro    Channel. Department of Mechanical Engineering, June 2011.

ADVISOR: Professor Bradford Bruno

Bi-slugs are fluid entities involving two dissimilar fluids that move “on their own” due to differences in surface tension. At the micro-fluidic scale this sort of motion may be useful to efficiently transport small quantities of fluid from place to place. This study uses Micro-Particle Image Velocimetry ( $\mu$ -PIV) techniques to investigate self propelling bi-slug flows. The bi-slugs examined are made of ethylene glycol and Xiameter PMX-200 Silicone Fluid (5cst and 10cst) and placed in a glass micro-channel of approximately 1mm diameter. The Reynolds number (Re) range considered (based on ethylene glycol in the slug) is 2.54 - 1.07 and the capillary number (Ca) range is  $1.23 \times 10^{-3}$  -  $5.18 \times 10^{-4}$ . In particular, we are interested in the flow field in the region near the interfacial meniscus, and the shear forces along the micro-channel. Quantitative velocity field images and streamline images of the silicon fluid in motion are shown. To the best of the author’s knowledge these  $\mu$ -PIV measurements are the first such measurements made in self propelling bi-slugs. In addition to the velocity field results, methods for creating self propelling bi-slugs, and issues related to the challenges of achieving adequate seeding of the ethylene glycol and silicone fluid with dyed micro-spheres will be presented.

## **Table of Contents**

Background .....	1
Fundamental Concepts .....	3
PIV .....	6
PIV Seeding .....	7
PIV Correlations .....	8
Methods Developments .....	9
Calculations .....	9
Velocity Tests .....	11
Capillary Tests .....	11
Results from Methods Development .....	12
Capillary Results .....	12
Velocity and Calculation Results .....	12
Movement and Visibility Table .....	14
Discussion of Methods Development .....	16
Methods .....	17
Cleaning Glassware .....	17
Making Bi-Slugs .....	17
Micro-Spheres in Ethylene Glycol .....	20
Micro-Spheres in Silicon Fluid .....	21
PIV Set up .....	22
Creating Vectors .....	23
Results .....	24

uPIV Results .....	24
New Findings .....	27
Discussion.....	29
Discussion of uPIV .....	29
Discussion of New Findings .....	35
Future Work .....	35
Bibliography .....	36
Appendix A: List of figures .....	38
Appendix B: Dimensioned Solidworks Drawings .....	40

## **Background**

In the past most fluid transportation studies have focused on moving large or macro scale, quantities of fluids. This type of transport uses pumps, gravity or other methods. Historically, this was the only type of fluid transport ever explored, because of this, this scale has been thoroughly researched. As time has passed, technology has changed and devices have steadily gotten smaller. This shrinking effect, has created a need for research in this field to focus more on gaining micro scale flow information.

This study looks at a specific type of fluid transport that occurs at the micro scale called bi-slug motion. For perspective, the macro scale consists of piping systems in homes or large dams and the micro scale consists of fluid quantities smaller than one drop, off the tip of an eyedropper. Fluids at these two scales behave very differently. One of the most remarkable differences is the effect that surface tension has on micro scale flows. Surface tension can actually cause fluids to move at this small scale. The bi-slug motion is, in fact, a surface tension driven flow. In order to, in the future, control micro-transportation of fluids, studies are performed to visualize the fluid flow. There are many different methods used to visualize fluid flow, but this study uses a specific type of visualization called Micro-Particle Image Velocimetry (uPIV). This type of visualization gathers images used to quantitatively determine a flow field of the motion. These studies provide a clearer image of how the flow behaves.

In the field of Mechanical Engineering micro-fluidics is a relatively new area of study. The motivation behind this new interest in micro-fluidics is primarily due to the potential applications of these micro-fluid systems. An example of a potential use of this new type of technology is a concept called lab-on-a-chip. "Lab-on-a-chip" technology

uses the movement of fluids on the micro-scale, to perform functions that are currently time consuming and costly in terms of materials. Such functions would be, for example, blood testing. The process of testing blood currently requires a person to move relatively large quantities of blood (mLs) to several separate test tubes by hand and to mix the blood with relatively large quantities of reagents. Micro-fluidics could be used to take a few micro drops of blood (Pico-liters) on an object the size of a computer chip and transport the blood to the needed diagnostic locations using just micro-channels, as opposed to human labor. The potential benefits of technology like this are great. Thousands of tests could be performed in parallel using very inexpensive (disposable) lab chips. Such technology could be especially useful in third world countries where access to medical testing is scarce. Currently, lab-on-a-chip devices are still far off. It will take a lot of testing and experimentation with micro-fluidics before practical devices can be manufactured cost effectively, but experiments, such as the one discussed in this paper, are laying the ground work for further understanding and advancement in this field.

Bi-slugs are a small subset of the micro-fluidic transport field that are driven by capillary motion. Capillary motion flows are comprised of one or more tiny drops of

fluid that move due to surface tension. An example of a single slug would be a drop of soda in a soda straw that is surrounded by air on both sides, see figure 1. In this case, gravity and surface tension move the soda down the straw. Bi-slugs are a similar concept to the single slug except there are two fluids. In Bi-slugs the first fluid pulls the second fluid along, like a train, without gravitational forces. This means that a bi-slug can travel in two directions, vertically due to gravity and



**Figure 1: Drop of fluid in a soda straw.**

horizontally using surface tension. In the future there is the potential to use this train motion to transport a fluid without the need for micro-pumps. This experiment explores the bi-slug fluid motion.

### **Fundamental Concepts**

The motion of a bi-slug is driven by the capillary motion resulting from the surface tension of the two fluids and their interaction with the glass channel. In order to understand the concepts of capillary motion due to surface tension certain fluid properties and effects that drive the motion must be explained. These properties and effects include surface tension, pre-wetting, and pressure driven flows.

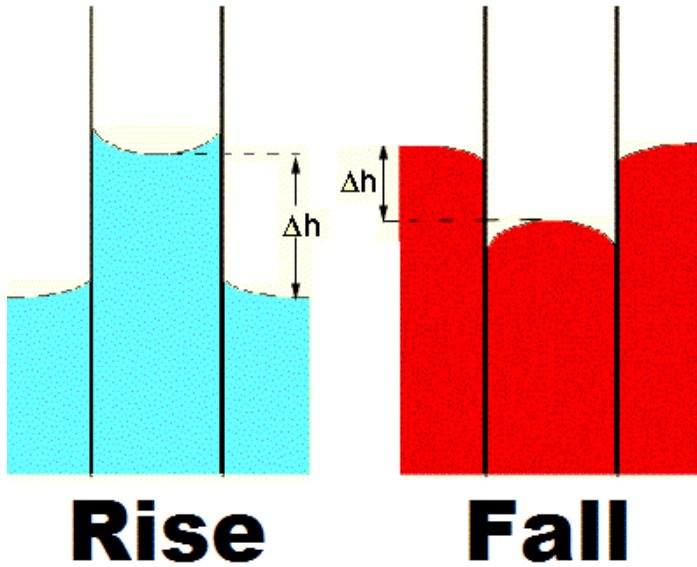
Surface tension is a liquid property that creates an invisible membrane across the surface of a liquid due to intermolecular forces. This membrane allows small insect to walk on water. The force that creates this membrane acts parallel to the surface and is created by the attraction between the fluid molecules. To visualize this effect it is best to think about a fluid on the molecular level. There is always some movement in the fluid at this level and collision of fluid molecules (Albert & Sibley, 2007). A fluid molecule, not on the surface, has on average zero attractive forces, because each has surrounding molecules to balance the forces. There is a symmetry to the pull of one molecule on the



**Figure 2: A picture of a non-wetting (1) and a wetting (2)**

other. At the surface these molecules have are surrounded by another fluid





**Figure 3: Capillary Rise vs Fall**

that they are less attracted to. This reduction in attractive forces removes the symmetry and thus these molecules pull tighter to one another creating this membrane. This is the basic concept of surface tension (Cenegal, 55-57).

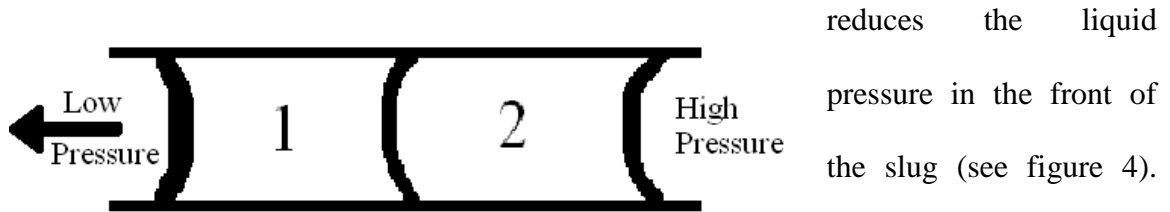
Pre-wetting is a concept that is part of the capillary effect, that is very important to the motion of a bi-slug. Wetting and non-wetting is determined by the contact angle between the fluid and the solid it sits on. If a fluid does not wet that surface the fluid will form a meniscus curving back toward the liquid as seen in figure 2a. If a fluid wets that surface the fluid will form a meniscus curving outward as seen in figure 2b. The effect of wetting is most noticeable in the difference between capillary rise and capillary fall. A fluid that wets a surface will rise in small diameter tube and a fluid that does not wet the surface will be pushed down, see figure 3.

The capillary rise and fall is calculated using the following equation 1.

$$h = \frac{2\sigma_s \cos\phi}{\rho g R} \quad \text{Equation 1}$$

Where h is the height between the surface and the meniscus, shown in figure 3,  $\sigma_s$  is the surface tension,  $\rho$  is the density of the fluid, g is gravity, R is the radius of the tube and  $\phi$  is the contact angle, shown in figure 2a and b. The differences in wetting and the capillary effect changes the pressure of the fluid and causes the bi-slug motion.

For a bi-slug made of ethylene glycol, leading, and silicone fluid, trailing, the meniscus is always facing towards the trailing fluid. This means that the meniscus opposes the motion. This can be explained by the pressure differences in the fluid. In the bi-slug motion the leading fluid (fluid 1) has a higher air-liquid surface tension, which



**Figure 4: A bi-slug with labeled pressure regions**

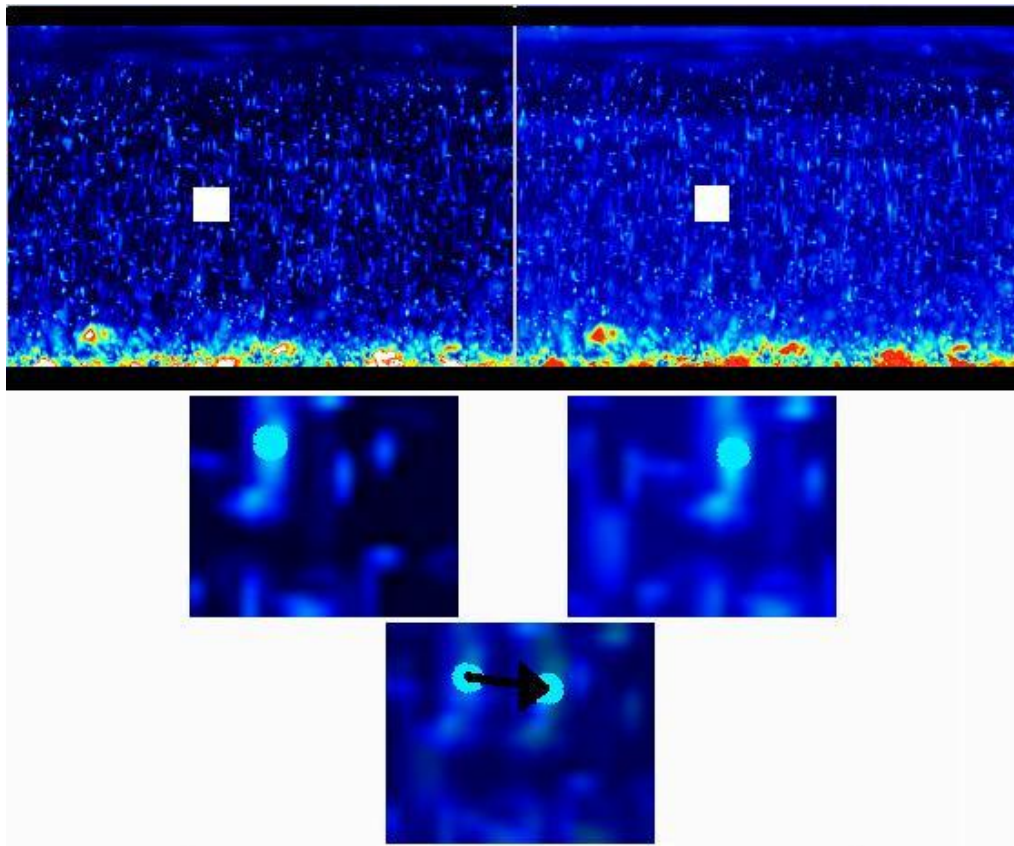
The pressure drops below the pressure of the trailing fluid (fluid 2), allowing for the middle meniscus to face the second fluid, and the pressure difference drives the slug forward (Bico & Quere, 2002). The driving force for this motion is calculated using the following equation:

$$F = 2\pi R(\gamma_1 - \gamma_{12} - \gamma_2) \quad (\text{Bico \& Quere, 2002})$$

Where  $R$  is the tube radius,  $\gamma_1$  and  $\gamma_2$  are the surface tensions of ethylene glycol and silicone oil and  $\gamma_{12}$  is the interfacial tension between ethylene glycol and silicon oil. This equation is only applicable for bi-slugs that pre-wet the channel; if the middle meniscus in figure 4 were reversed a different equation would be necessary. The equation used to describe the forces of the bi-slug only considers the surface tension forces and the driving force on the of bi-slug. This study goes beyond this general mathematical analysis and seeks to develop experimental data on the motion between the two fluids at the interfacial meniscus. To quantitatively determine the velocity fields near this meniscus uPIV was used.

## PIV

Particle Image Velocimetry (PIV) is an optical flow field visualization technique that uses a double-pulsed laser to illuminate, and a camera to track, particles in a flow. By tracking these particles calculations can be made about the velocity of a particle and an overall flow field can be determined. This method is advantageous because it can provide quantitative velocity data through a small cross section of the flow field. PIV works by taking two sequential pictures, as shown in figure 5, where each picture corresponds to a laser flash. In order to track the motion of the fluid small particles that move with the fluid, called seeding particles, are added to the fluid. The first image in figure 4 corresponds to the initial laser pulse, which causes light to reflect off of the



**Figure 5: A uPIV image of a Couette flow in a micro-channel showing the two laser pulse images and the correlation process used to find the velocity of a particle.**

seeding particles. The camera captures the light from the first laser pulse identifying the initial location of particles. The second image in figure 3 corresponds to the second laser pulse reflecting off the new locations of the particles. The images are then correlated to produce a vector field. These are the basic concepts PIV, but at the micro-scale there are changes to the traditional PIV method.

Micro-PIV mimics macro-PIV in technique, but because of the small size of the channels being photographed changes to the traditional PIV process are made. In macro-PIV the sheet of laser light defines the particles being used in the experiment because only the particles in the sheet are illuminated. At the micro-scale the sheet of laser light usually ends up illuminating the entire channel. In micro-PIV because light cannot be the limiting factor the images are limited using the focus of the camera lens (Wereley & Meinhart, Micron-Resolution Particle Image Velocimetry). This is done by tracking only the in focus particles. This becomes problematic because both in focus and out of focus particles are illuminated creating a lot of blur in the PIV images. This problem is unpreventable using the current uPIV system, but the blur can be reduced using optimal seeding particle ratios (Wereley & Meinhart, 2010).

### **PIV Seeding**

Seeding particles in the fluid is a balance between too much light and not enough. In order to create good correlations the images must have defined particles. Good particles accurately move with the flow and have similar specific gravity so they do not fall out of suspension when the fluid moves (Wereley & Meinhart, Micron-Resolution Particle Image Velocimetry). The camera captures the fluorescent glow off of the seeding particles. One of the challenges with seeding particles is using an appropriate

quantity of particles. If there are no particles, there is no movement to track, but with too many particles the camera can be bombarded by too much light, producing an ambiguous mass with no visible individual particle. The seeding density challenge can be overcome by calculating specific seeding ratios or by experimenting with optimal densities until the correct ratio of in focus to out of focus particles is found. (*Note a slug without seeding particles is often referred to as a neat or clean slug and a slug with particles is usually called a seeded slug.*)

### **PIV Correlations**

After PIV images have been captured the data must be altered to improve the final results. In order to make these improvements a general understanding of the correlation process and the interrogation window is necessary. An interrogation window is used when correlating PIV images to calculate velocity vectors. It is a square region that is defined by the user to be a certain amount of pixels, usually 32x32 or 64x64, figure 5 shows two interrogation windows selected from the initial image (DaVis FlowMaster Software Manual for DaVis 7.0, 2004). The basic correlation process takes each interrogation window in the first image and superimposes it onto the second image as seen at the bottom of figure 5. Once this is done each window will be shifted until the particles in the first image are directly on top of the particles in the second image. The number of particles that directly align is counted, as is the required shift to align the particles. The amount of shift in pixels is then translated into a velocity and a direction (Ladommatos & Zhao, 2001).

## **Methods Developments**

In order to take uPIV certain methods, calculations and techniques were developed to enable data acquisition. These methods included calculating fluid properties and theoretically determining the feasibility of micro-spheres staying in solution, using Stokes Law. Velocity measurements and capillary comparisons were also made. All of this data was compiled into a movement versus visibility table that determined what slugs would move, under certain conditions and whether uPIV could be taken of that slug. The methods developed to get to that final table were a series of calculations, as well as, velocity and capillary tests.

## **Calculations**

Before uPIV was taken Reynolds number and capillary number calculations were performed to quantify the type of flow (i.e. low Reynolds number, low capillary number). The Reynolds number is a dimensionless number that relates inertial effects to viscous effects and it is calculated using equation 2.

$$Re = \frac{\rho V D}{\mu} \quad [2]$$

Where  $\rho$  is the density of the fluid,  $V$  is the velocity of the fluid,  $D$  is the diameter of the channel and  $\mu$  is the viscosity of the fluid. A low Reynolds number flow means that the flow will be laminar and will not change as a function of time. The capillary number is a dimensionless number that relates the effect of the viscous forces to surface tension. It is calculated using the following equation 3.

$$Ca = \frac{\mu V}{\gamma} \quad [3]$$

Where  $\mu$  is the viscosity of the fluid,  $V$  is the velocity and  $\gamma$  is the surface tension between the two fluids. The other calculations made helped determine if the micro-spheres added to the two liquids would fall out of solution or stay suspended for the length of the experiment.

Stokes Law uses drag on a sphere to determine the settling velocity of a micro-sphere. The settling velocity is useful in determining if the density of the sphere is going to prohibit the sphere from mimicking the flow field accurately. If a sphere is falling out of suspension instead of moving with the flow then any PIV taken with those spheres will be showing larger gravitational effects than would normally occur in the fluid. This effect will reduce the accuracy of the data. Stokes law only applies to low Reynolds number flows uses terminal velocity to determine settling velocity. Terminal velocity is given by equation 4

$$V_t = \sqrt{\frac{4gD}{3C_D} \left( \frac{\rho_s - \rho}{\rho} \right)} \quad [4]$$

Where  $g$  is gravity,  $D$  is diameter,  $\rho_s$  is the density of the solid sphere,  $\rho$  is the density of the fluid and  $C_D$  is the coefficient of drag on the sphere given by equation 5.

$$C_D = \frac{24}{Re} = \frac{24\mu}{\rho VD} \quad [5]$$

Where  $\rho$  is the density of the fluid and  $\mu$  is the viscosity of the fluid. By combining equation 4 and 5 the final terminal velocity equation 6 is determined to be

$$V_t = \frac{gD^2}{18\mu}(\rho_s - \rho) \quad [6]$$

This was used to calculate the terminal velocity of the two types of spheres in the three types of fluids.

### **Velocity Tests**

The velocity tests were performed using a stopwatch and a micro-channel marked at 10mm intervals. The bi-slugs were made using the methods explained below and the velocity tests. The stop watch was started when the tip of a slug passed by a marker and stopped when the slug reached the next marker. Some slugs were used for multiple velocity tests, but most slugs cannot be run twice. These velocity tests were used in the Reynolds and Capillary calculations.

### **Capillary Tests**

Minimal capillary tests were performed. The capillary test consisted of two bottles with equal amounts of liquid and two clean micro channels. One bottle was full of clean ethylene glycol and the other was full of 7um polystyrene seeded ethylene glycol. One micro channel was placed in each bottle one with clean fluid and one with seeded fluid and the heights were compared measured using a ruler. This experiment was run twice for accuracy.



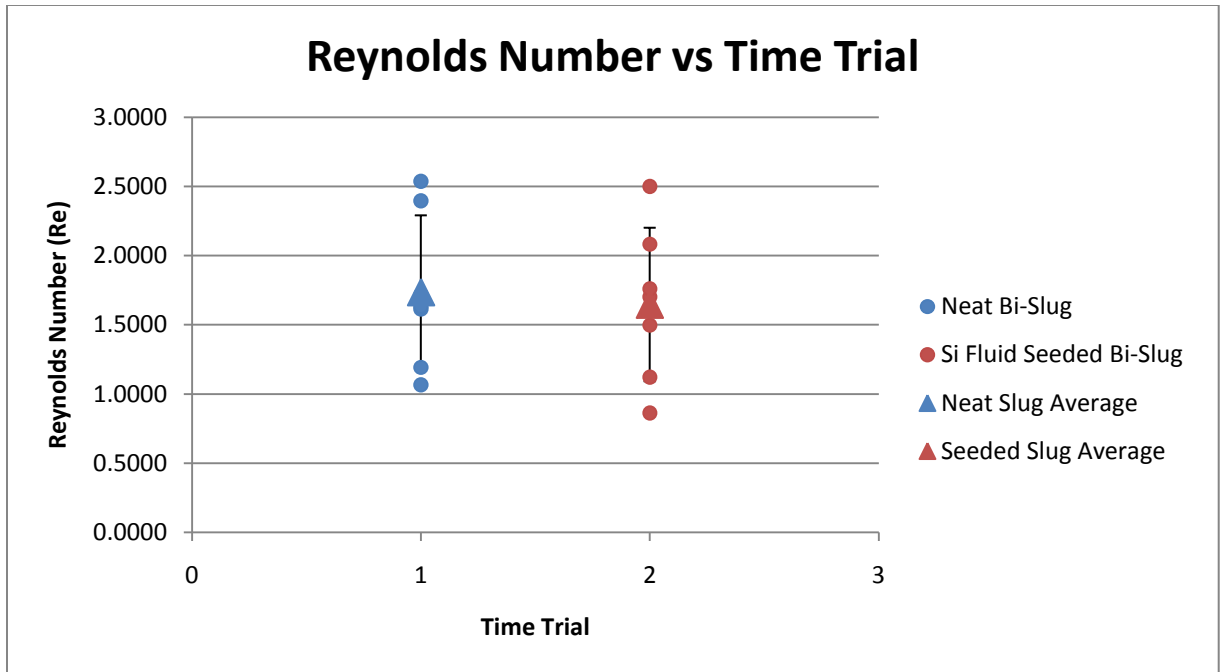
## **Results from Methods Development**

### **Capillary Results**

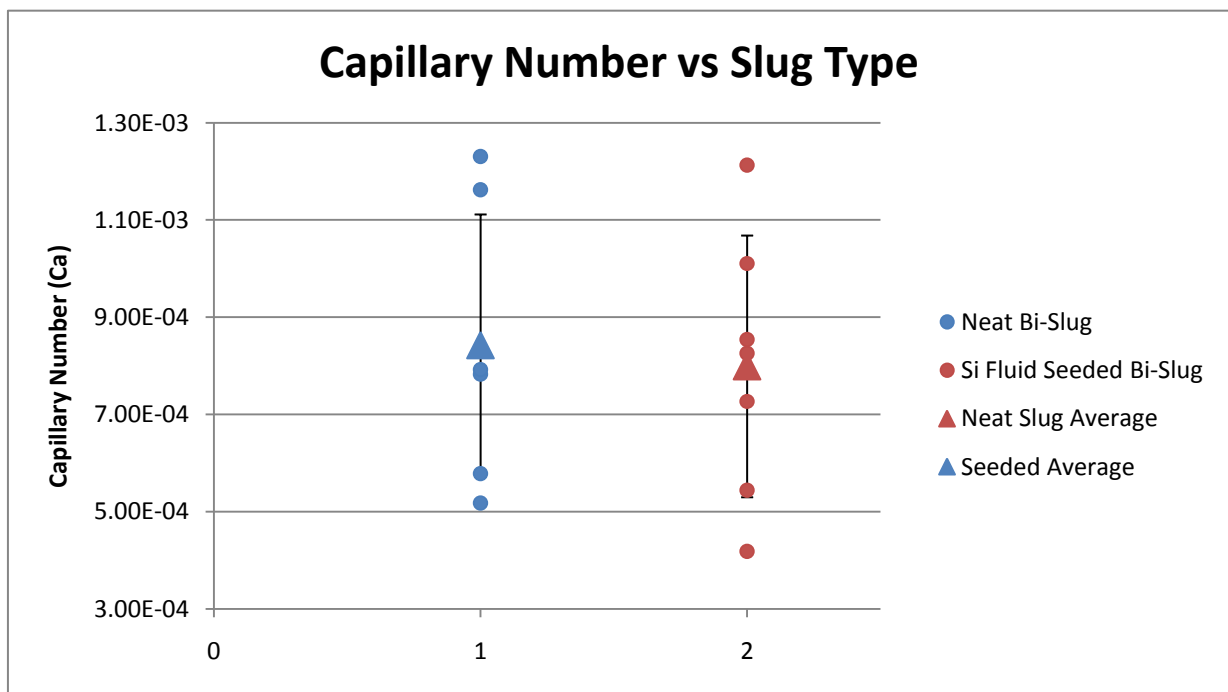
The capillary test resulted in a 1mm loss of capillary height for each test. The heights of the neat fluid were 1.75mm and 1.7 mm and the heights of the seeded fluid were 1.6mm and 1.65mm.

### **Velocity and Calculation Results**

The velocity values for a neat slug and a silicon fluid 5um silica seeded slug were used in the Reynolds and Capillary number calculations. The results are two graphs, figure 6 and figure 7. The graphs showed several trials and used standard deviation to determine the error bars. The average Reynolds number varies between 1.74 and 1.65 for a neat bi-slug versus and seeded bi-slug. The average capillary number varies between 0.00084 and 0.00080 for neat versus seeded bi-slug. These results were used to further analyze the uPIV results.



**Figure 6: The graphical results from the Reynolds number calculations based on the velocity of a neat versus seeded bi-slug.**



**Figure 7: The graphical results from the Capillary number calculations based on the velocity of a neat versus seeded bi-slug.**

## **Movement and Visibility Table**

The movement and visibility table is a result of observations, uPIV tests and the tests described above. Figure 8 shows the results of these tests. The first image in figure 8 represents a neat bi-lug with neat ethylene glycol represented by the shaded region and the neat silicon fluid represented by the empty box. The red crosshatched or checkered area represents the addition of 5um silica red fluorescent microspheres to the fluid and the blue dotted areas represent the addition of 7um polystyrene red fluorescent microspheres. Each number represents a potential "case" or bi-slug option and the table in figure 9 indicates if the bi-slug combination moves or not and it also explains whether that combination of microsphere and fluid can be seen by the camera under the laser.

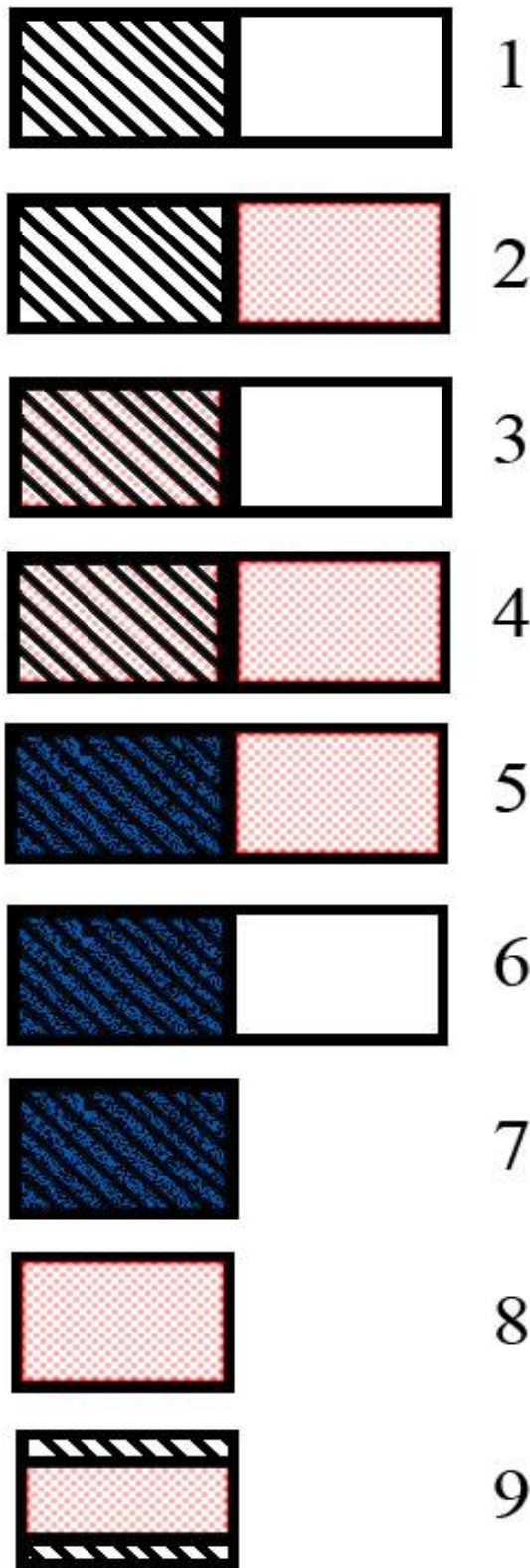


Figure 8: The Movement and Visibility Chart that corresponds to the table shown in figure 9.

	Movement	PIV Visibility
1	Yes	No
2	Yes	Yes, not as bright
3	Yes	No
4	Yes	1/2 of Slug
5	No	Ideal Visibility
6	No	Yes
7	No	Yes
8	Some	Yes
9	Some	Yes, not as bright

Figure 9: The Movement and Visibility table used to describe the flows pictured in figure 8.

## **Discussion of Methods Development**

Once these methods and results indicated above were determined they were analyzed and used to aid in the process of taking uPIV. The movement and visibility table was the most valuable result from the tests performed above. This figure and table created a clear picture of what doesn't work and potentially what does work. All of the uPIV presented in this paper are a combination of seeded silicon fluid and neat ethylene glycol represented as case 2 from figure 8. This is primarily because this slug moved consistently and was visible with this uPIV system. The micro-spheres were not as bright as desired, but they worked well enough to get data. Case 5 from the table is the ideal slug type, if this slug would move consistently it would contain the most interesting and informative data. Case 7, 8 and 9 were used to determine what would fluoresce under the uPIV and what wouldn't. Interestingly, case 8 would fluoresce brightly (400 to 500 counts), but case 9 with ethylene glycol lining the channel would be significantly dimmer (150 to 350 counts). Even with the less bright spheres case 2 moved the best and was the best case to use for the initial testing discussed below.

The other results from the capillary tests and velocity tests indicate other conclusions not shown in figure 8 or 9. The results of the ethylene glycol capillary test indicated a reduction in surface tension once the micro-spheres were added. This may be an explanation for why case 5, and 6 from the movement and visibility chart have inconsistent motion. This is not a conclusive test and there is still hope that a method for making case 5 move will be determined. The silicon fluid on the other hand once seeded became significantly easier to work with than the seeded ethylene glycol. The small differences in Reynolds number and Capillary number indicate that the spheres do not

significantly affect the movement of the bi-slug (i.e. prohibit). The uPIV data determined using these spheres is likely be an accurate representation of the actual flow because the flow is not visibly affected by the spheres. The determination of the type of bi-slug seeding to use resulted in a finalizing the bi-slug making process and taking uPIV.

## **Methods**

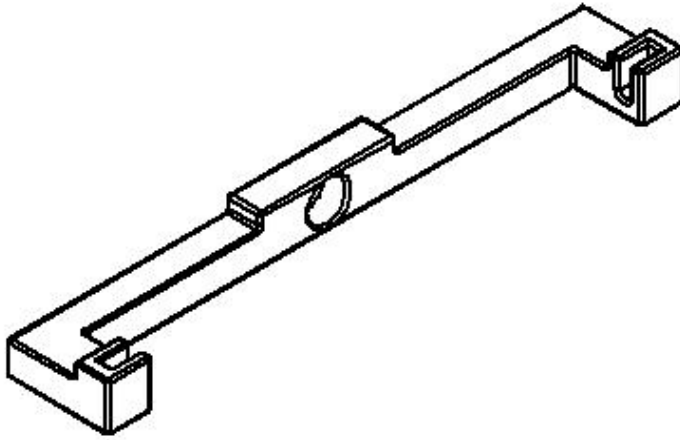
The process required to make and track bi-slug motion is comprised of many small tasks that must all be completed and within a specific time frame to get data. The slugs must move, be well seeded, and the PIV set up must be working correctly.

### **Cleaning Glassware**

The first step to making a bi-slug is cleaning the micro-channel using the ASTM 2274 cleaning method. This method is performed by mixing even quantities of ACS grade acetone, ACS grade methanol and ACS grade toluene to make a tri-solvent. This solvent is used to rinse the micro-channels five to ten times. The channels are then rinsed with water, lab soap, distilled water and then ACS grade acetone – in that order. Finally the channels must be left to dry. *Note it was observed that the channels must be cleaned within one day of use or they may be exposed to dirt that will prohibit motion.*

### **Making Bi-Slugs**

The process of making bi-slugs used for this study was previously developed by Jessica Lord (Lord, 2010). The method for creating bi-slugs uses clean KIMAX-51® Glass channels that are 1mm in diameter and starts by pre-wetting the channel with ethylene glycol. To do this a small slug roughly 1cm in size is put in the channel. This is done by placing a clean channel into a small, 20ml or less, bottle of ethylene glycol and



**Figure 10: Solidworks drawing of the channel holder used to make bi-slugs.**



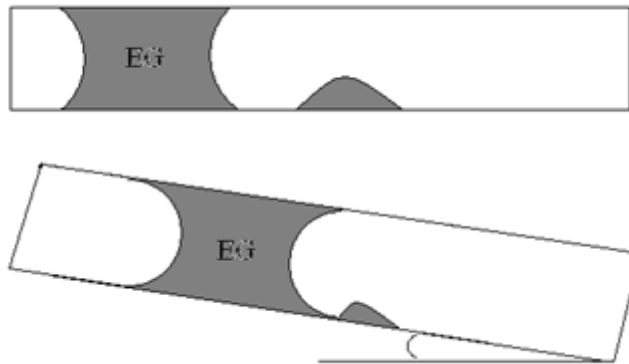
**Figure 11: Image of the channel holder attached to the rotation platform.**

allowing the fluid to be drawn into the channel by surface tension. To stop the fluid from entering the channel either, place a finger over the top of the channel or remove from the fluid. The slug is then placed into a channel holder, see figure 10 for the specification on the channel holder, that is attached to a rotation platform (part number RP01/M Thor Labs), see figure 11 for the set up.

This platform allows for a more accurate production of the slug. The slugs are rotated to a 20 degree angle and the rotated an additional 5 degrees every centimeter until the total angle equals 45 degrees. Once the slug reaches the opposite end of the channel it is then sent back to the beginning of the channel using the same method. This is repeated until the slug moves easily in the channel, approximately 2 to 3 times - down the channel and back. The process is done slowly and with this precision to avoid the formation of small droplets of fluid on the side of the micro-channel, see figure 12. If a droplet forms in the channel this usually indicated that the slug is moving too quickly, an immediate solution is to decrease the tilt

angle. The slug must also be moved back to the droplet and used to remove the droplet from the channel. In order to complete the pre-wetting process the ethylene glycol must move easily and the channel walls must be free from any droplets.

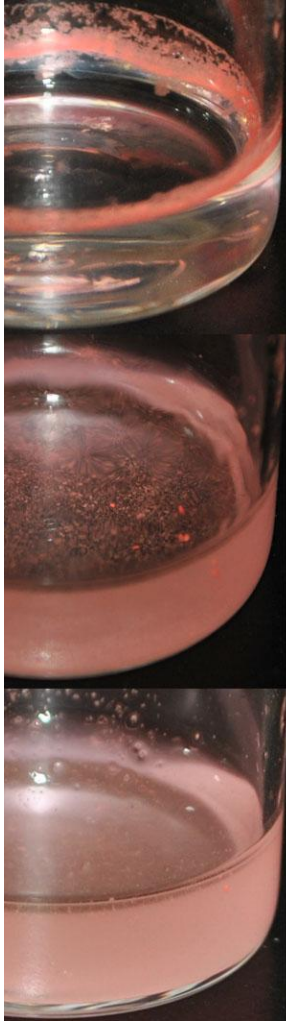
After the pre-wetting process is complete the silicone oil can be added. For this experiment Xiameter PMX-200 5cst silicone fluid was added to the channel using the capillary effect. To do this move the ethylene glycol slug to the end of the channel and place a plug, usually a finger is used as a plug, over the opposite end of the channel. This creates a slight bulge in the fluid at the end of the channel. The channel is then placed in a small bottle, 20ml or less, of silicone fluid that is tipped sideways to an angle of around 45 degrees or less. Once the channel is in the bottle the plug is released. The silicone fluid then slowly enters the channel creating a bi-slug. If the room is cold the channel can be rotated in small circles to aid the entrance of the silicone oil. The amount of fluid added can vary, usually around 1cm is sufficient for motion. As soon as the channel is tilted horizontally the slug will begin moving. Once the slug reaches the end of the channel it can slowly be moved back to the beginning of the channel and it will sometimes travel again. A common challenge with a second motion is the formation of



droplets, shown in figure 12, in the channel, once one of these droplets increases in size and forms a singular slug the bi-slug will not move.

**Figure 12: The drawing depicting the formation of droplets on the micro-channel wall. These droplets will prohibit motion of the bi-slug.**





**Figure 13: Ethylene glycol with 7µm polystyrene microspheres with three different mixing techniques.**

### Micro-Spheres in Ethylene Glycol

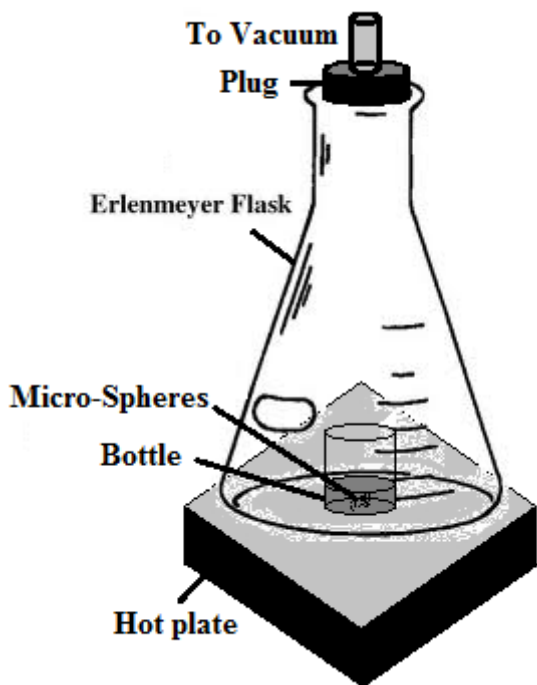
The microspheres added to the Ethylene Glycol are 7µm Duke Scientific Red Fluorescent micro-spheres (supplied by Thermo Scientific). They are made of Polystyrene Divinylbenzene and died with Firefli fluorescent red. Spheres can be added without surfactant using just mixing and sonication to break up clumps. First add the desired amount of spheres to the ethylene glycol in a small bottle, 20ml or less, and then place a secure cap on the bottle. Place the bottle in a Branson 200 Ultra Sonic Cleaner and press the start button. It is important that the bottle remains upright and that water never rises above the bottom of the cap. This will prevent leaking or water entering the ethylene glycol. The process should run for 5 minutes. Once the ultrasonic cleaner is done remove the bottle and observe

the solution, if the spheres are evenly mixed with no visible clumps the process is done. Gently shaking the bottle can help determine if the spheres are mixed, they should move with the fluid and have no clumps or spheres on the glass bottle, examples shown in figure 13. Figure 13 shows three states of the ethylene glycol with micro-spheres. Part a shows, spheres added without surfactant or sonication, part b shows spheres with hand shaking and part c shows a well mixed result after 5 minutes of sonication. If the solution

if left over night the spheres will separate out of solution, gently swirl the ethylene glycol and sonicate to re-suspend the spheres.

### Micro-Spheres in Silicon Fluid

The microspheres added to Xiameter 200X Silicon Fluid 5cst are 5um Microspheres-Nanospheres (a Corpuscular Company) Red Fluorescent micro-spheres (Catalog # 141443-10). They are made of Silica and died with Rhodamine B fluorescent



**Figure 14: Schematic of the vacuum set up used to remove the water from the silica micro-spheres.**

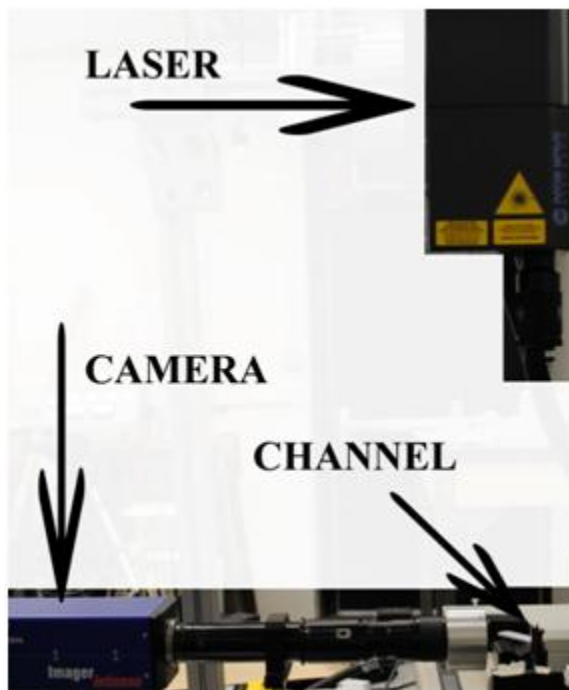
red. The spheres came suspended in water, to remove the water from the mixture a vacuum pump evaporative system was used (see figure 14). This included a hot plate, vacuum pump with a plug and tubing, thick rimmed Erlenmeyer flask, thermometer and small vial with a hole in the top. The vial with the suspended spheres was placed in the flask then the flask was placed onto the hot plate. Finally the vacuum pump was started and the plug was added to the top

of the flask. The pump was started first to avoid any oil in the pump tubing from entering the flask. The hot plate was heated to 50 degrees Celsius and after 30 minutes all of the water was evaporated from the spheres. Silicon oil was then added directly to the spheres without any surfactant. The bottle was then given a new cap without a hole and placed in

a Branson 200 Ultra Sonic Cleaner for 5 minutes. It is important that the bottle remains upright and that water never rises above the bottom of the cap. The solution should look similar to that of ethylene glycol, with no clumps. If there are clumps repeat the cleaner process for another 5 minutes. If the solution is left over night the spheres will separate out of solution, the cleaner is the best method for re-suspending the spheres. It is also recommended that the spheres be kept in a plastic container instead of glass as the spheres appear to adhere to the glass bottles.

### **PIV Set up**

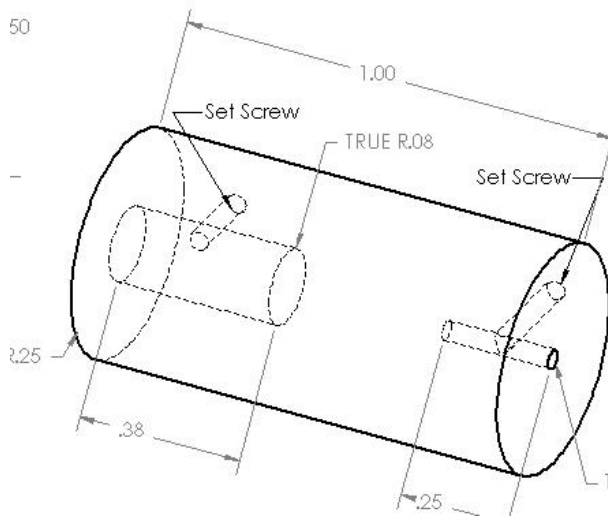
To perform the PIV measurements a New Wave Research Solo III green light laser and a La Vision Image Intense CCD Camera (S/N VC04-0170) were used in conjunction with LaVision DaVis 7.4 software. Figure 15 shows the experimental set up



used for the laser. The laser was programmed to take double frame images (T1A & T1B) at 2.5 hertz. The program was set to record 200 images. These images were then correlated using the methods described below.

**Figure 15: uPIV experimental set up.**

## Stage Set-Up



**Figure 17: Solidworks drawing of the motor mount.**



**Figure 16: Actual image of the final motor mount with hex key.**

In order to take micro-PIV images the channels need to be securely held in front of the camera. The device that I am currently using was previously designed by Jessica Lord and sits on a stage that can move in three directions, which allows for maximum freedom when adjusting the channel. For my project the stage needs to move at approximately the same speed as the slug in order to take PIV images where only the particles appear to be moving. To move the stage a DC motor was attached using a motor mount to the stage in the direction of the slug motion (see figure 16

and 17). This DC motor was then attached to a power source that could be varied based on the slug speed creating an easily adjustable stage movement system.

## Creating Vectors

The vector correlations used to analyze the data were PIV sum of correlation and were created using several still images. Most of the automatic settings were used in the correlations. The main changes were in the preprocessing of the images. The images had

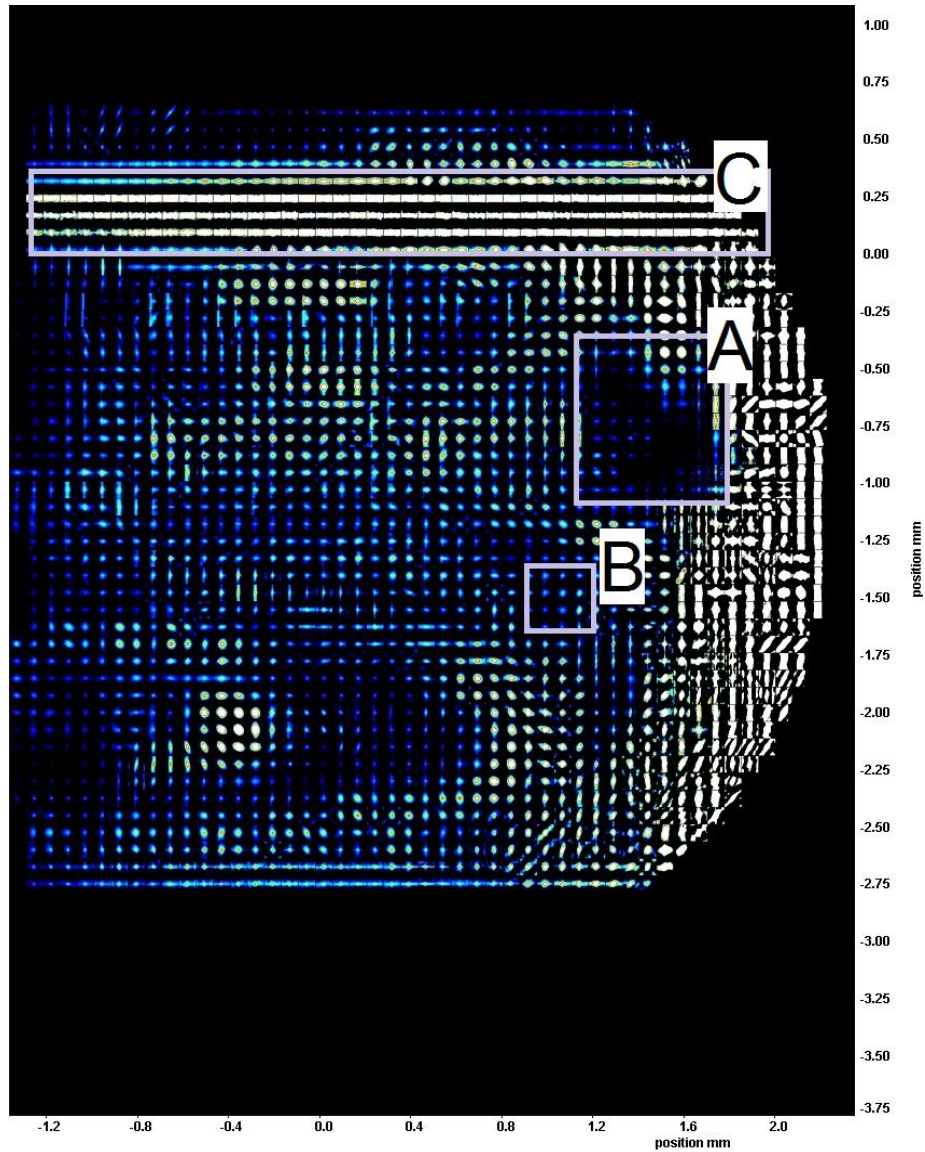
an 80 pixel background correction with an offset of 5 pixels and a normalization of 5 pixels. The correlation was set to multi-pass at 64X64 and 32X32. All other setting remained at the recommended program levels.

## **Results**

The results gained from this uPIV analysis include PIV of a moving slug and a new phenomena yet to categorized. The  $\mu$ PIV results consist of a series of correlation maps and velocity vector images of 5um Silica seeded Xiameter X200 5cst Silicon fluid. The new phenomena is also using silicon oil, but is currently just images.

### **uPIV Results**

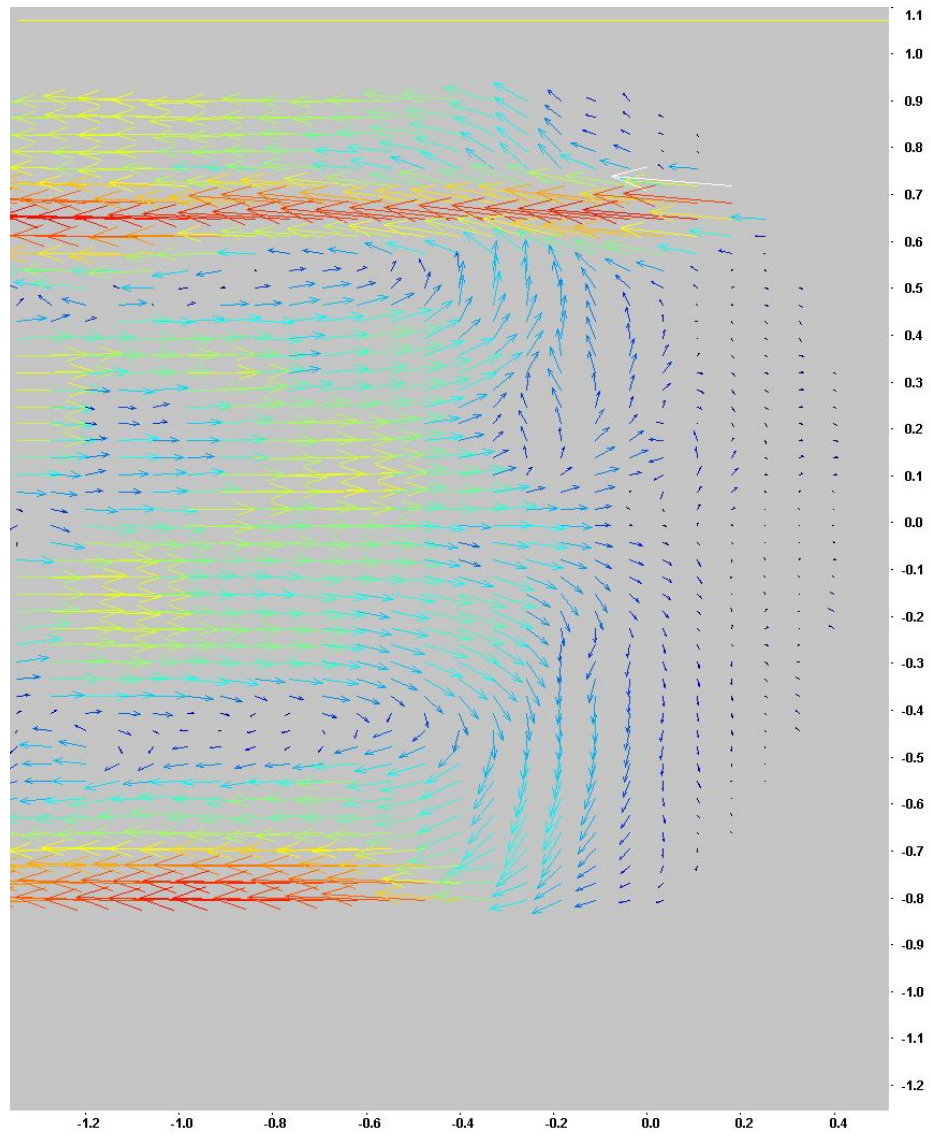
The uPIV results consist of both a correlation map and a velocity vector field. Figure 18 shows a correlation map of a PIV Sum of Correlation. This is the sum of 7 still images taken using the techniques described above. Each dot is in its own box called an interrogation window, that is described above. This correlation map has dark spots indicated in region A, circular peaked spots indicated in region B and lines located along the x direction indicated by region C. These three types of regions are regions of interest in a correlation map.



**Figure 18: Correlation map created from uPIV of 5um seeded silicon fluid.**

Figure 19 shows the vector field produced by the correlation map in figure 18. This vector field also has notable flow characteristics. The rotating motion seen at the bottom left of the figure shows a flow similar to the tracks on a tank. There is also a large strip of red arrows located along the x direction at the top of the image, that shows a very fast velocity. The other interesting feature are the small arrow located right at the

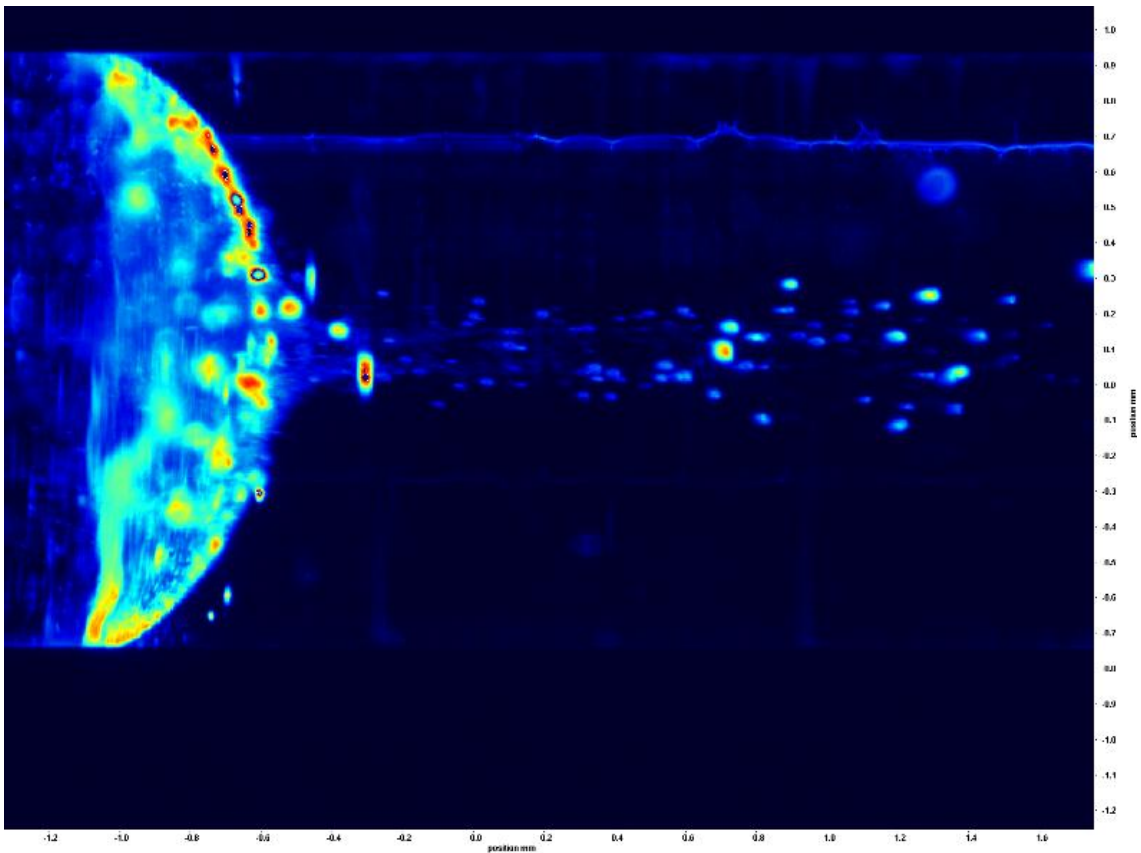
curve of the slug. These results from the correlation map represent the first uPIV images of a bi-slug ever taken.



**Figure 19: uPIV vector field of 5um silica seeded silicon fluid.**

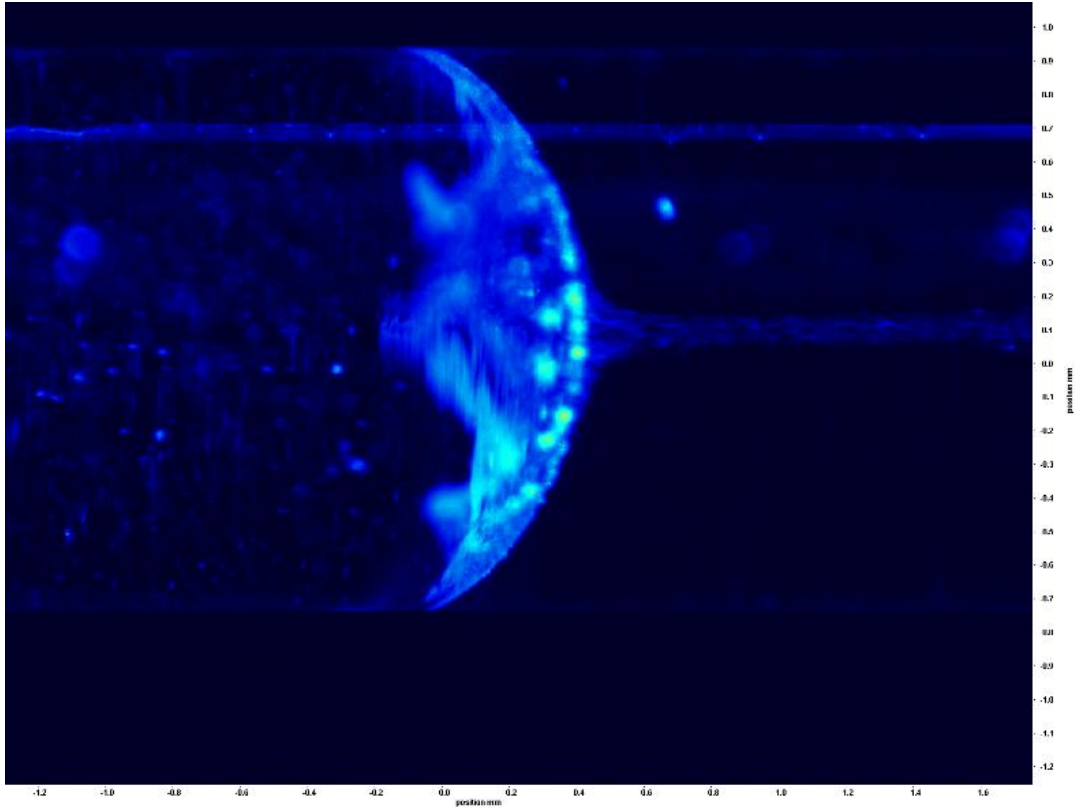
## New Findings

During the process of taking uPIV a new unexpected result was found. uPIV images are shown below, these images were captured in motion, so there is no vector fields of them to date. The seeded fluid on the left is silicon oil and the bright specs coming off of the meniscus are in ethylene glycol. Figure 20 and 21 are from the same slug in the same video and figure 22 is from a different slug. The figures 20 and 21 slug is moving at an average velocity of around 2.2mm/s (estimated from the video) and the slug in figure 22 is moving much slower at a creeping pace of around 0.02mm/s (estimated from video).

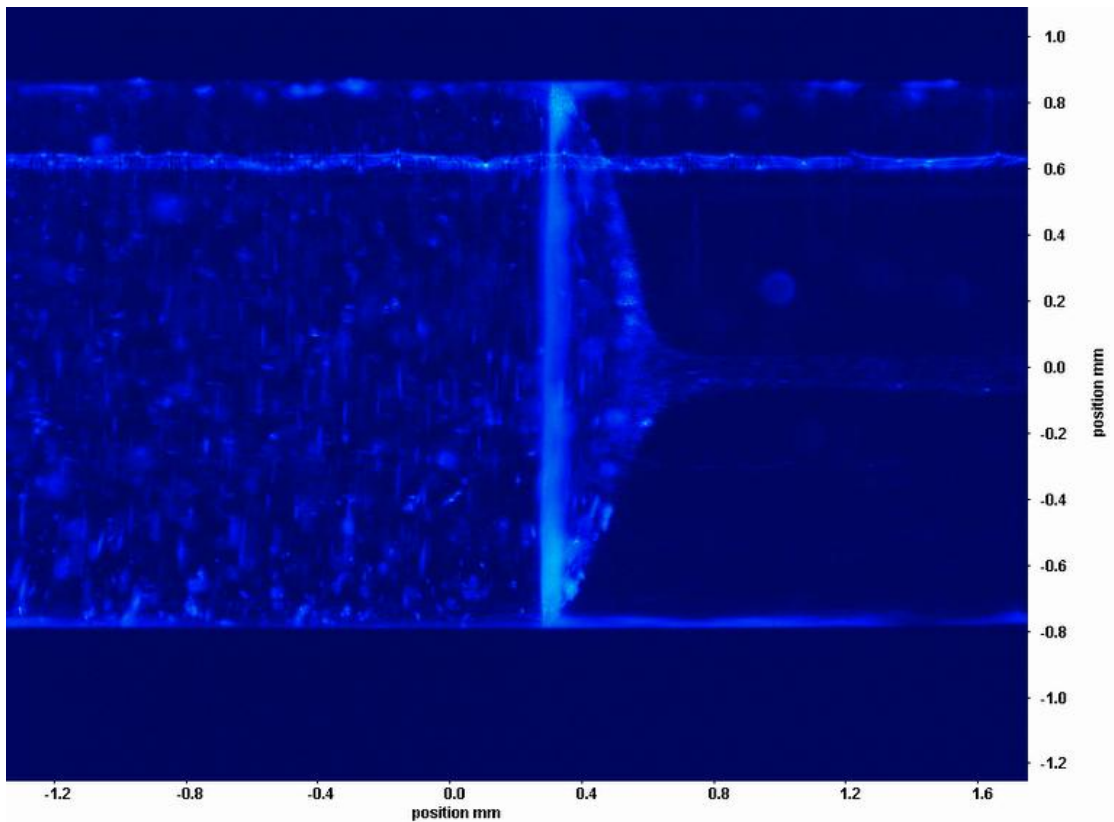


**Figure 20: Still image from a video of 5um silica seeded bi-slug in motion.**





**Figure 21:** Another still image from a video captured of a 5 $\mu$ m silica seeded bi-slug in motion.



**Figure 22:** Third image from a different bi-slug with 5 $\mu$ m silica seeded silicon fluid.

## **Discussion**

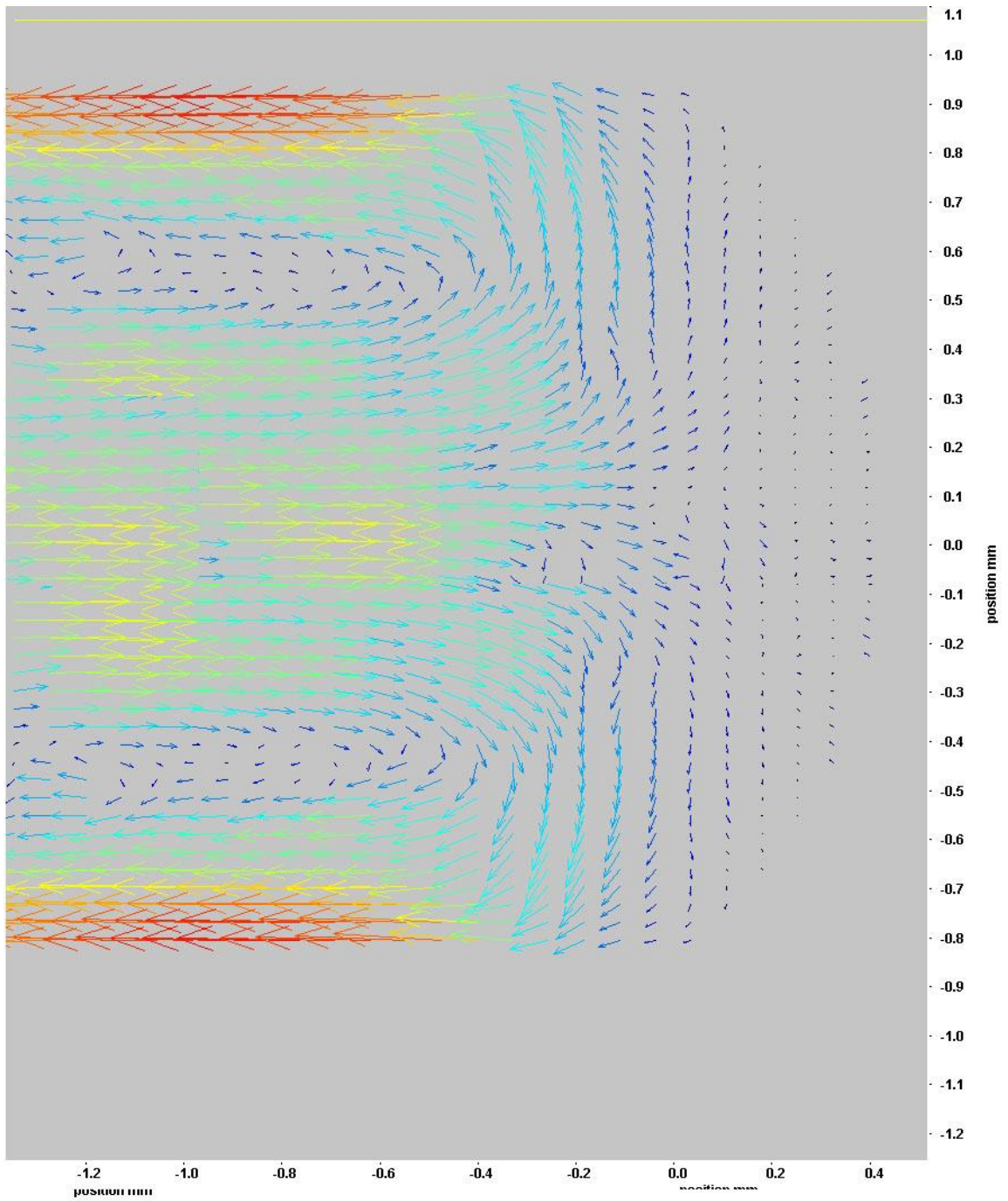
The initial challenge for this term was determining a seeding, figuring out the stage set-up and taking actual uPIV. All of these goals were accomplished and on top of these results a movement table was established and a new uncategorized flow phenomena was discovered.

### **Discussion of uPIV**

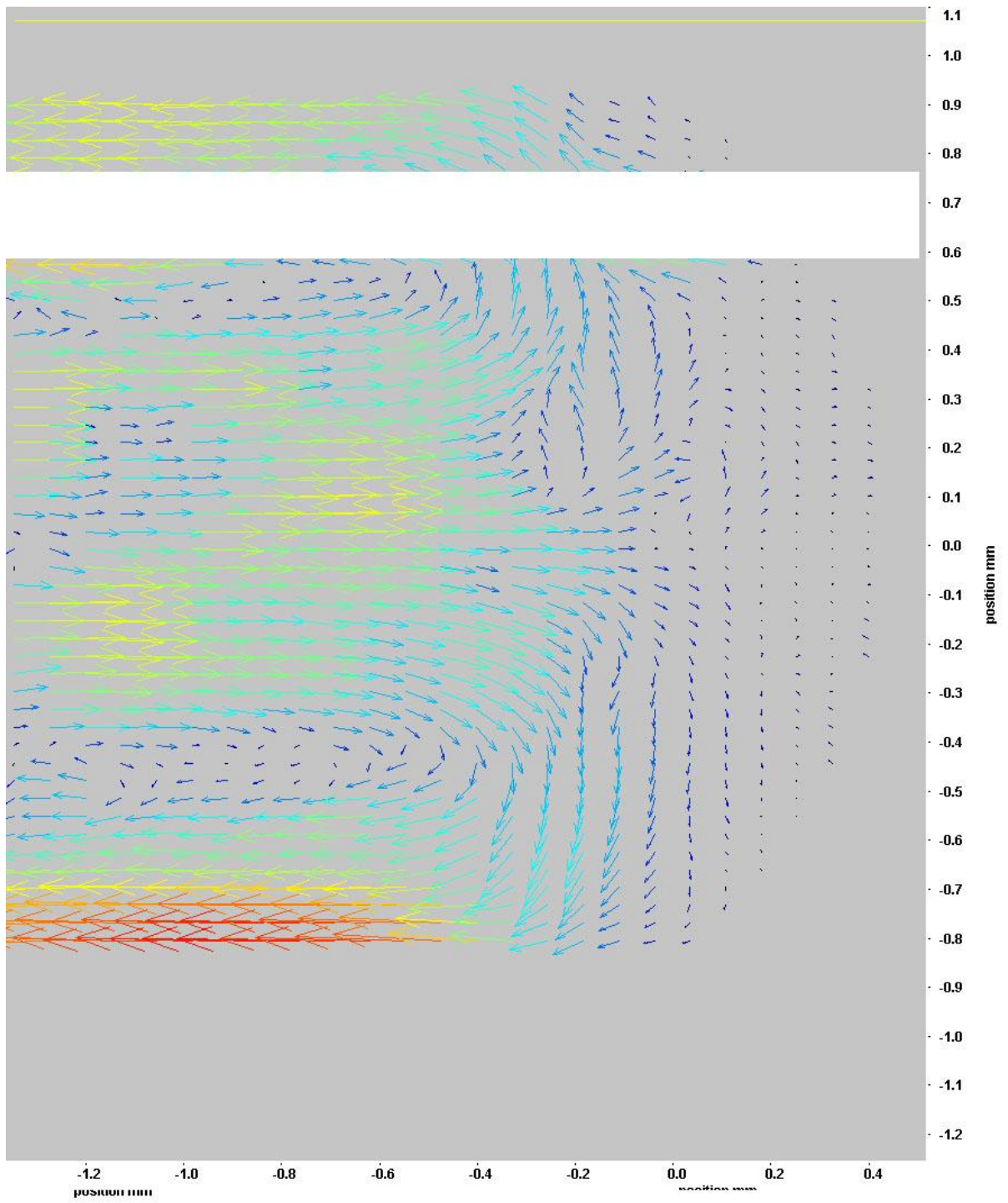
The uPIV of the silicon fluid side of the bi-slug produced expected results. The correlation, in figure 18, map shows that there are some spots with little to no data, some regions with good data and some regions with bad data. The dark regions are interrogation windows with no bright peaks, indicated by the letter A, these interrogation windows will most likely not provide any vectors. Good data has a bright small circle in each interrogation window, indicated by the letter B. Larger circles provide ok data, but small tight circles are ideal. The interrogation windows with lines or the ones that appear to be entirely bright represent bad data and will produce bad vectors, indicated by the letter C. The area indicated in figure 19 with a series of bright red vectors is an area with bad vectors.

These bad vectors can be overcome using two methods one is using symmetry and the other is using area replacement. The symmetry method assumes that the flow on the bottom half of the slug has the same flow pattern and the top half. Figure 23 shows what a symmetry result would look like. It shows that the flow on the top and the bottom are identical and that the flow moves in "tank tracks" or a circulating pattern that is common to slug movement. Overall these results are expected with the symmetry result.

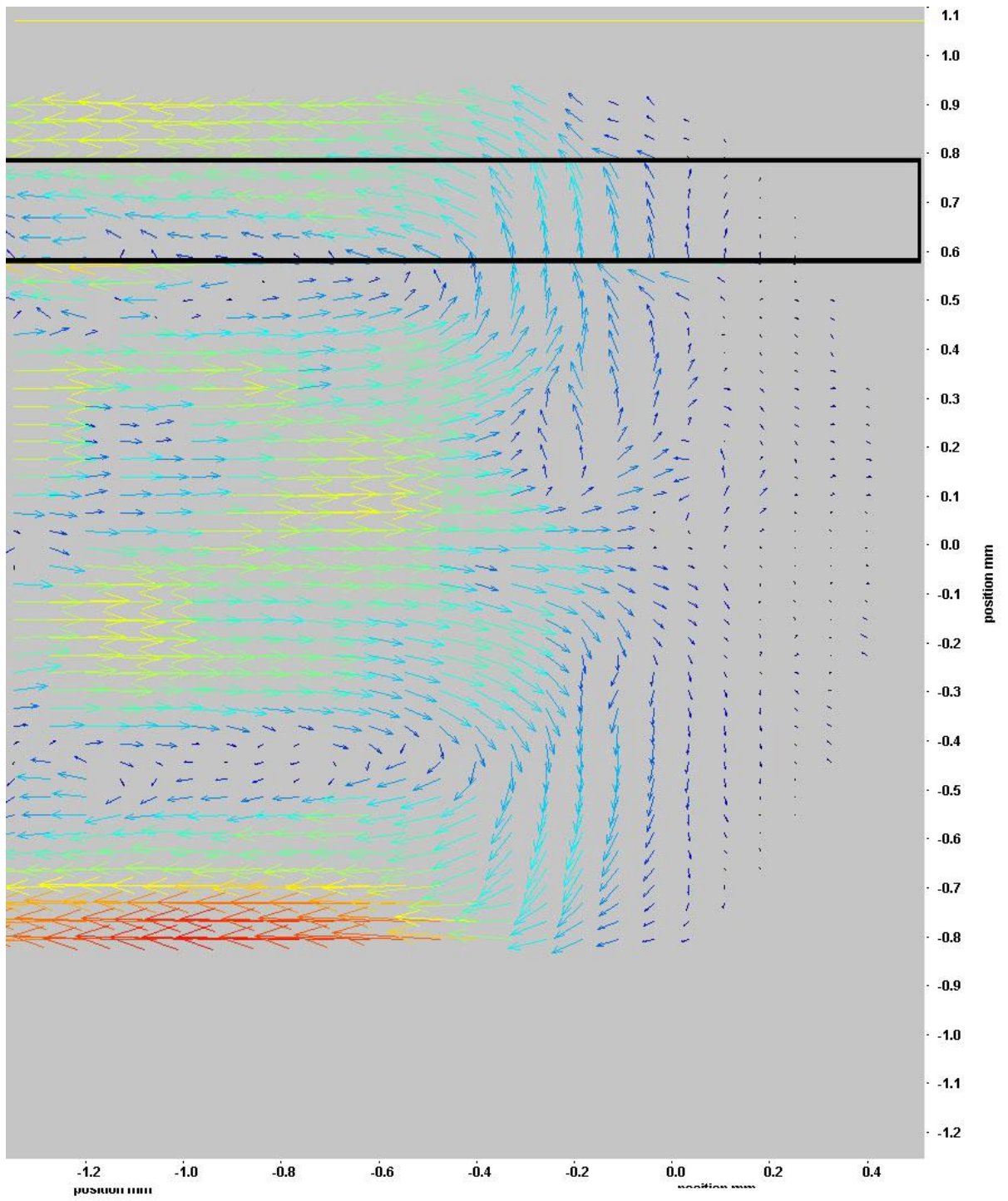
The other method used to fix these bad vectors was a replacement method. This method isolated the bad vector area and removes it, shown in figure 24. This isolated area is then replaced by the same set of vectors from the bottom of the vector field. This method mimics the symmetry method, but utilizes the available good vectors in the top portion of the vector field. The result with the new area boxed is shown in figure 25. The final result is shown in figure 26. This final image closely resembles the symmetry method result. The similarity between figure 23 and 26 implies that there is some symmetry between the top and the bottom of the slug motion.



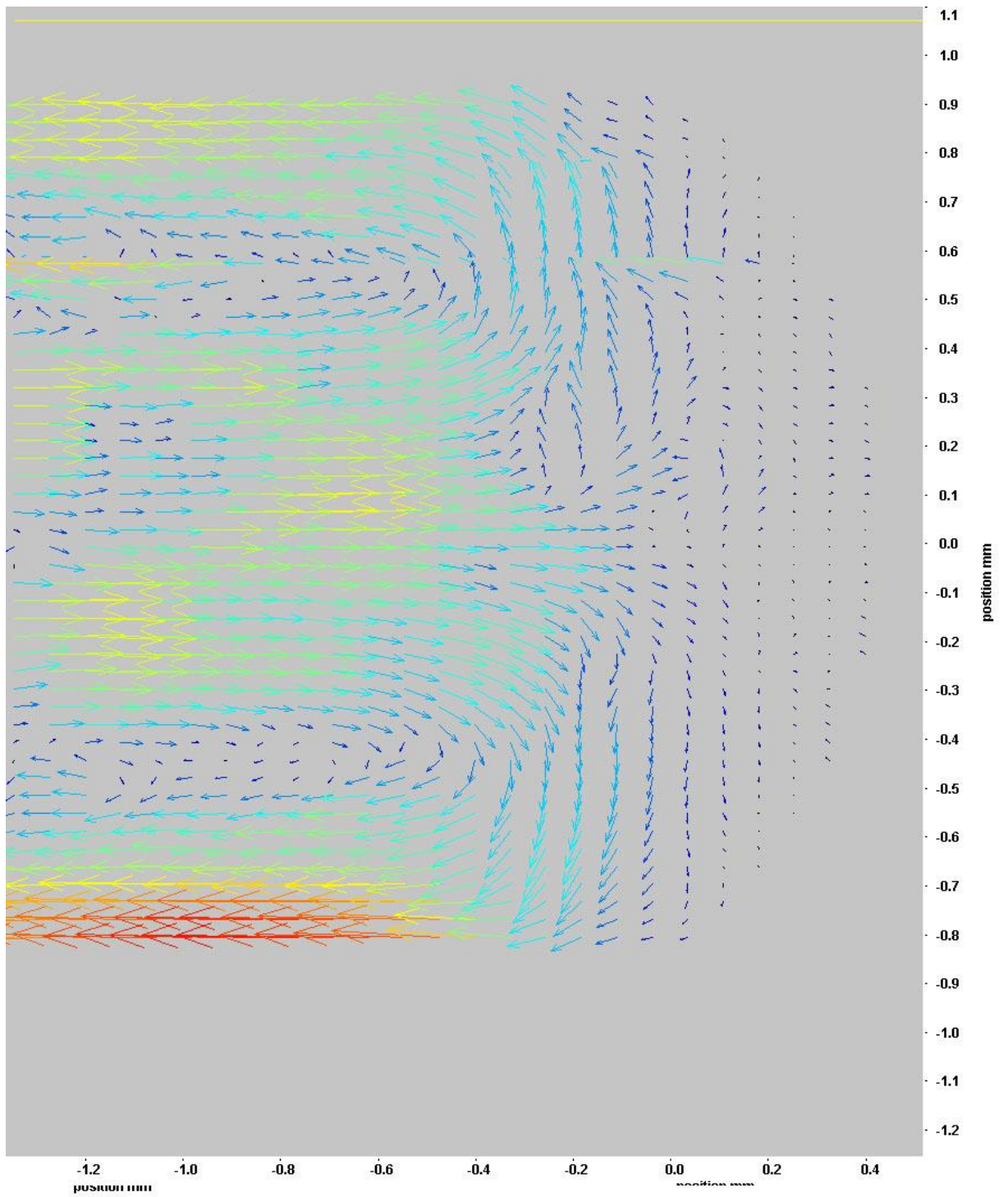
**Figure 23: Final edited image using the symmetry method.**



**Figure 24: The uPIV results with the bad vector area removed.**



**Figure 25: The replaced vector highlighted in a black box.**



**Figure 26: The final resulting vector field with the new replaced vectors.**

At this time due to the relatively new nature of these uPIV images there are no conclusion about what these images tell us about the flow inside of a bi-slug.

### **Discussion of New Findings**

The new finding described above were the most interesting discovery of these experiments. From observation it looks as if the silicon fluid slug is being pulled along by the this thin strip of silicon fluid running down the middle of the ethylene glycol. There is also the possibility that this stream coming off is only micro-spheres, but no fluid. This theory seems less probable because we know that the silica micro-spheres are not visible in ethylene glycol. The motion of the bi-slug is still largely a mystery, even after this study, but this new finding may be the answer to understanding this interesting transportation method.

### **Future Work**

The future work still to be preformed will be the further exploration of these new findings and the continuation of taking bi-slug uPIV. New work should try to get video of this new flow and work on moving the bi-slugs with seeded ethylene glycol. It is also highly recommended to look into oil dyes or dye that can be put into silicon oil. This dye might provide visible evidence of what is going on during the beginning stages of this flow.



## **Bibliography**

1. Albert, R., & Sibley, R. (2007). Surface Tension. In *McGraw-Hill Encyclopedia of Science and Technology* (10th ed.). New York: McGraw-Hill.
2. Benedict S. Gallardo, V. K. (1999). Electrochemical Principles for Active Control of Liquids on Submillimeter Scales. *Science* 283 , 57-60.
3. Bico, J., & Quere, D. (2002). Self-Propelling Slugs. *Fluid Mechanics* , 101-127.
4. Cenegal, Y. a. (2010). *Fluid Mechanics* (2nd ed.). Boston: McGraw-Hill.
5. *DaVis FlowMaster Software Manual for DaVis 7.0*. (2004). Germany: LaVision GmbH.
6. Fair, R. (2003, June). Advances in Droplet-Based Bio Lap-on-a-Chip. *BioChips* 2003 .
7. Junker, D., Schmid, H., Drechsler, W. H., & Michel, B. (2002). Microfluidic Capillary Systems for the Autonomous Transport of bio'chemicals. *Micro Total Analysis Systems* , 952-54.
8. Ladommatos, N., & Zhao, H. (2001). In-Cylinder Flow Field Measurement; Particle Image Velocimetry. In *Engine Combustion Instrumentation and Diagnostics* (pp. 298-332). Warrendale, PA: Society of Automotive Engineers.
9. Lord, J. M. (2010). Self-propelling Bislugs. *Union College Mechanical Engineering* .

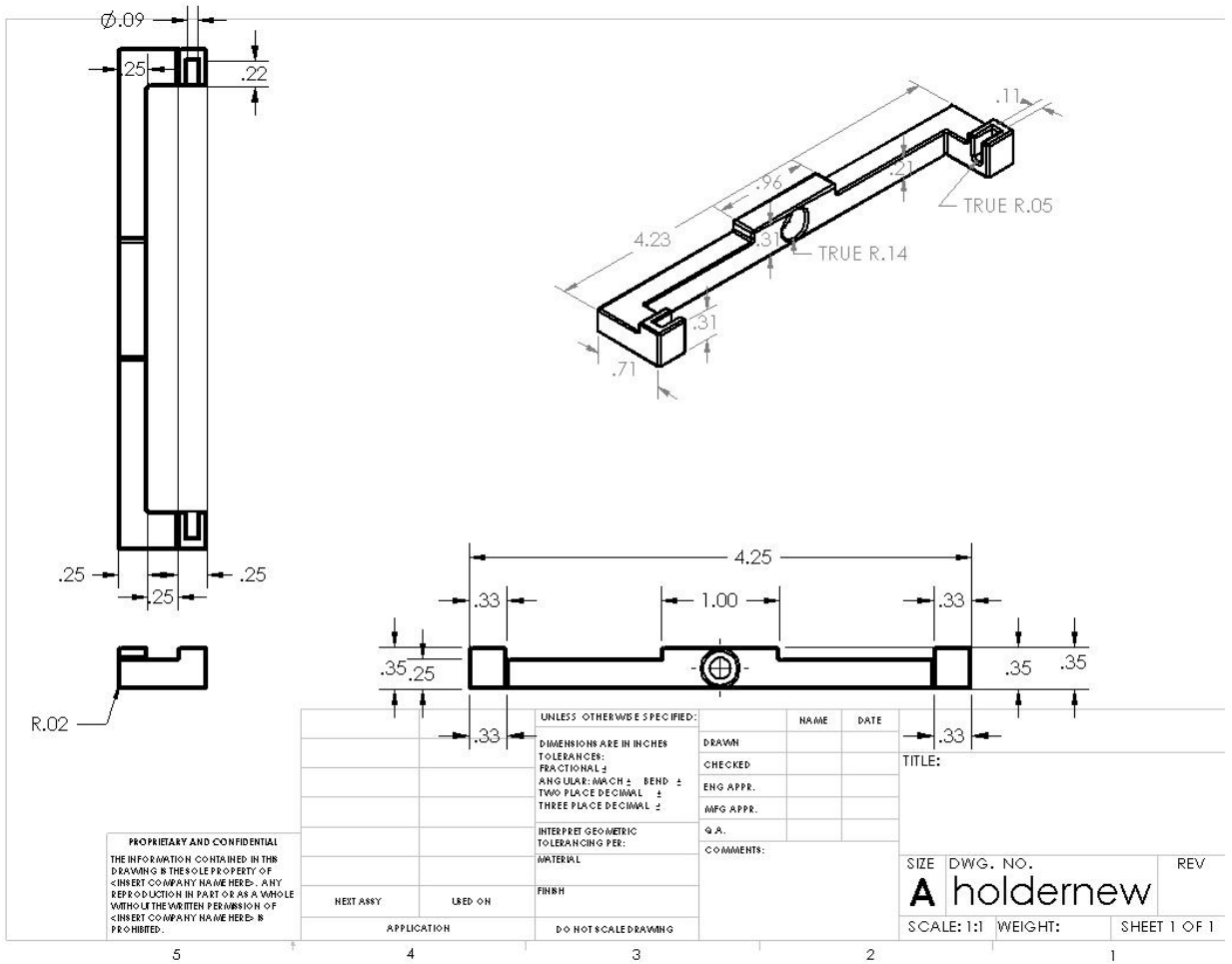
10. Stone, H., Stookey, A., & Ajdari, A. (2004). Engineering Flows in Small Devices: Microfluidics Toward a Lab-on-a-Chip. *Annual Review of Fluid Mechanics* , 381-411.
11. Wereley, S. T., & Meinhart, C. D. (n.d.). Micron-Resolution Particle Image Velocimetry.
12. Wereley, S. T., & Meinhart, C. D. (2010). Recent Advances in Micro-Particle Image Velocimetry. *Annu. Rev. Fluid Mech.* , 557–76.

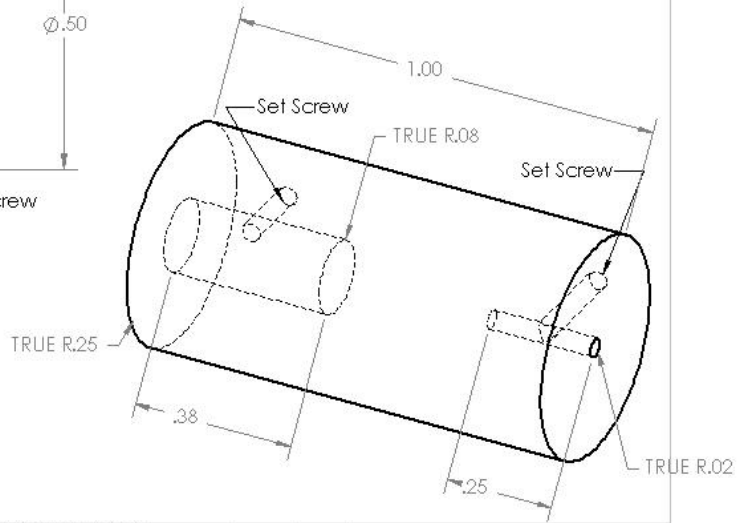
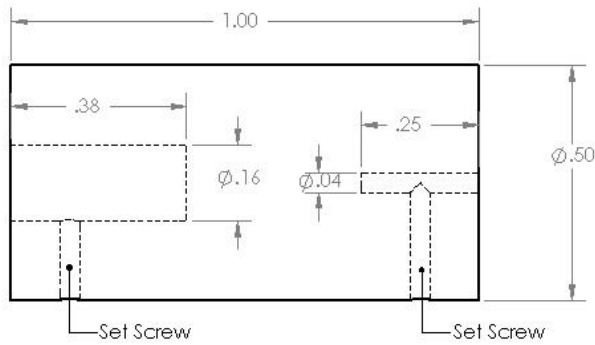
## Appendix A: List of figures

Figure 1: Drop of fluid in a soda straw .....	2
Figure 2: A picture of a non-wetting (1) and a wetting (2).....	3
Figure 3: Capillary Rise vs Fall .....	4
Figure 4: A bi-slug with labeled pressure regions .....	5
Figure 5: A uPIV image of a Couette flow in a micro-channel showing the two laser pulse images and the correlation process used to find the velocity of a particle. ....	6
Figure 6: The graphical results from the Reynolds number calculations based on the velocity of a neat versus seeded bi-slug.....	13
Figure 7: The graphical results from the Capillary number calculations based on the velocity of a neat versus seeded bi-slug.....	13
Figure 9: The Movement and Visibility table used to describe the flows pictured in figure 8.....	15
Figure 8: The Movement and Visibility Chart that corresponds to the table shown in figure 9.....	15
Figure 10: Solidworks drawing of the channel holder used to make bi-slugs. ....	18
Figure 11: Image of the channel holder attached to the rotation platform.....	18
Figure 12: The drawing depicting the formation of droplets on the micro-channel wall. These droplets will prohibit motion of the bi-slug.....	19
Figure 13: Ethylene glycol with 7 $\mu$ m polystyrene microspheres with three different mixing techniques. ....	20
Figure 14: Schematic of the vacuum set up used to remove the water from the silica micro-spheres.....	21

Figure 15: uPIV experimental set up. ....	22
Figure 17: Actual image of the final motor mount with hex key.....	23
Figure 16: Solidworks drawing of the motor mount.....	23
Figure 18: Correlation map created from uPIV of 5um seeded silicon fluid.....	25
Figure 19: uPIV vector field of 5um silica seeded silicon fluid. ....	26
Figure 20: Still image from a video of 5um silica seeded bi-slug in motion.....	27
Figure 21: Another still image from a video captured of a 5um silica seeded bi-slug in motion. ....	28
Figure 22: Third image from a different bi-slug with 5um silica seeded silicon fluid. ...	28
Figure 23: Final edited image using the symmetry method.....	31
Figure 24: The uPIV results with the bad vector area removed. ....	32
Figure 25: The replaced vector highlighted in a black box. ....	33
Figure 26: The final resulting vector field with the new replaced vectors. ....	34

# Appendix B: Dimensioned Solidworks Drawings





PROPRIETARY AND CONFIDENTIAL  
 THE INFORMATION CONTAINED IN THIS  
 DRAWING IS THE SOLE PROPERTY OF  
 AMOTORMOUNT. ANY REPRODUCTION  
 IN PART OR AS A WHOLE WITHOUT THE  
 WRITTEN PERMISSION OF AMOTORMOUNT  
 IS PROHIBITED.

		UNLESS OTHERWISE SPECIFIED:	NAME	DATE	
		DIMENSIONS ARE IN INCHES	DRAWN		TITLE
		TOLERANCES:	CHECKED		
		FRACTIONAL ±	ENG APPR.		
		ANGULAR/MACH ± BEND ±	MFG APPR.		
		TWO PLACE DECIMAL ±			
		THREE PLACE DECIMAL ±			
		INTERPRET GEOMETRIC			
		TOLERANCES PER:			
		MATERIAL:			
		FINISH			
		DO NOT SCALE DRAWING			
	NEXT ASSY	USED ON			SIZE DWG. NO.
					<b>Amotormount</b>
					SCALE: 4:1
					WEIGHT:
					SHEET 1 OF 1

5

4

3

2

1