

Elasticity characteristics of a bio-load of renewable Resources

Mustapha Jammoukh^{1*}, Khalifa Mansouri¹, Bachir Salhi²

1 Laboratory of Signals, Distributed systems and Artificial Intelligence (SSDIA), Hassan II University of Casablanca, Higher Normal School of Technical Education, P.O. Box 159 28 820 Mohammedia, Morocco.

2 Laboratory of Applied Mechanics and Technology (LAMAT), Mohammed V University of Rabat, Higher Normal School of Technical Education P.O. Box 6207, 10 100 Rabat, , Morocco.

Article Info

Received Jun 21, 2018

Keyword:

Bio load
Environment
Material of animal origin
Numerical modeling.

ABSTRACT

The use of composite materials in industry has become more important thanks to the diversity of applications (aeronautics, rail, naval, automobile, etc.). The current concentration is moving towards bio-loading composites due to its environmental, economic and social benefits.

In this work, the numerical modeling by the finite element method has been able to confirm the experimental tests on a material of animal origin with parallel , 45 ° and at 90° in the direction of the fibers.

The results of the numerical simulation have illustrated that moving away from the parallel direction of fibers, the rigidity decreases and the behavior changes, which reinforces the hypotheses of the anisotropy of the material of animal origin studied and the high rigidity in the direction of the fibers due to the Keratin which gives it this behavior.

Corresponding Author:

First Author,
Hassan II University of Casablanca,
Higher Normal School of Technical Education,
SSDIA Laboratory, Mohammedia -MOROCCO,
Email: jammoukh@yahoo.fr

1. Introduction

Several ecological constraints and in terms of sustainable development have pushed us to expand the field of research at the level of the bio-load in order to produce bio composites meeting these requirements. [1] [2]

They can be innovative materials or original combinations of known materials: Materials containing less hazardous substances, materials derived from renewable resources, industrial co-products ... etc. [3]

We aim, through our research topic, to improve these bio-composites by reinforcing their thermo mechanical qualities by a load of animal origin, in this case horn of beef. To obtain results on various variables and to be able to understand the behavior of the materials, a finite element simulation of the experimental tensile test was done using the software "ABAQUS" in parallel directions , 45 ° and at 90° of the direction of the fibers [4].

1. Material and methods

1.1 Material

The horn is composed mainly of different keratins: Proteins rich in sulfur, forming fibers. Keratin macromolecules of helical conformation wrap around each other to form filaments which gives to the horn a fibrous, impermeable and rigid structure, but not enough to not deform under the action of heat and pressure.

1.2 Methods

1.2.1 Experimental evaluation of virgin material

Figures 2 and 4 show the cuts intended for tensile tests which have been made on specimens represented by figure 1 and table 1 with directions of cutting of the specimens parallel at the direction of the fibers (0 °), 45 ° and at 90° [4]. The air and temperature conditions ($\approx 20 \pm 2 \text{ }^\circ\text{C}$) in a machine of Zwick-Roell type with a load cell of $\pm 2.5\text{N}$.

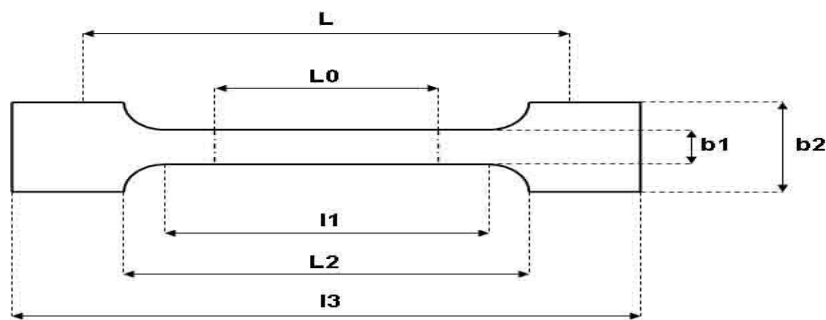

Figure 1: Normalized specimen

Table 1 :Normalized values in millimeters of sample dimensions

ISO 527-2	1BA	I3>75	I1=30±0,5	b2=10±0,5
Haltère	b1=5±0,5	h> 2	L0=25±0,5	L2 +2;L2=5 8±2

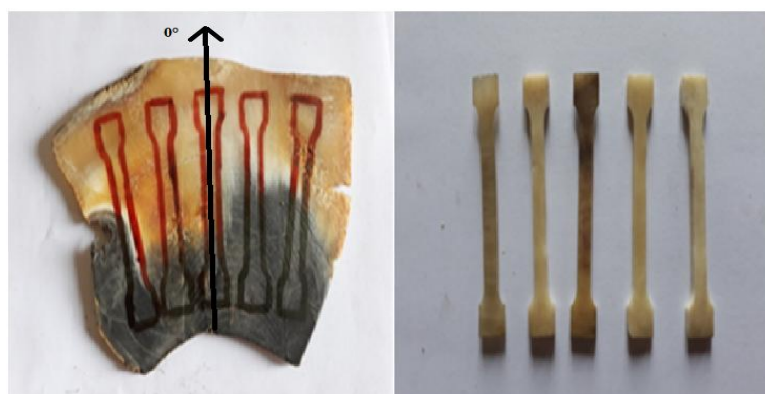

Figure 2: Cutting specimens parallel to the fibers [4]

The tensile curves obtained by the experimental tests at 0 ° are illustrated in the following figure.

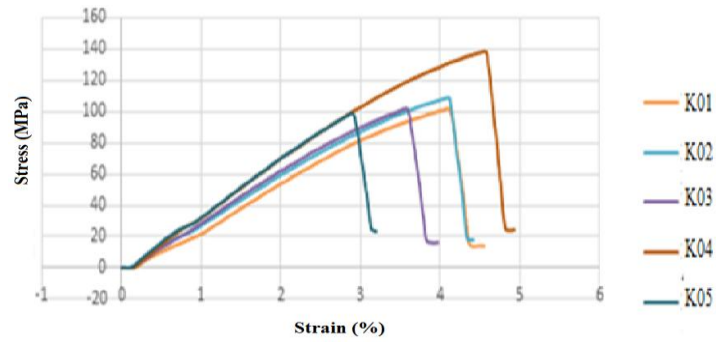

Figure 3: Tensile curves at 0° [4]



Figure 4: Cutting specimens diagonal to the fibers [4]

The tensile curves obtained by the experimental tests at 45 ° are illustrated in the following figure.

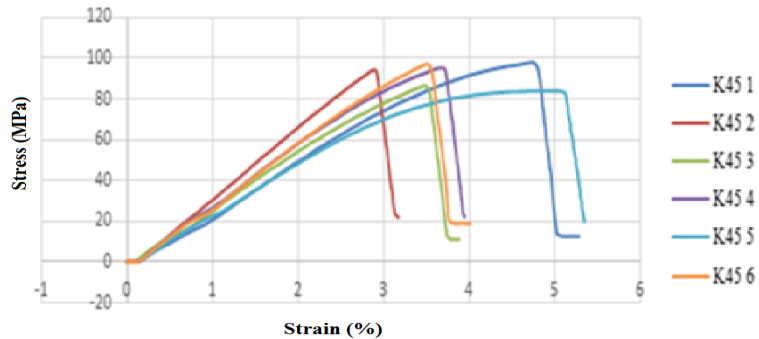

Figure 5: Tensile curves at 45° [4]

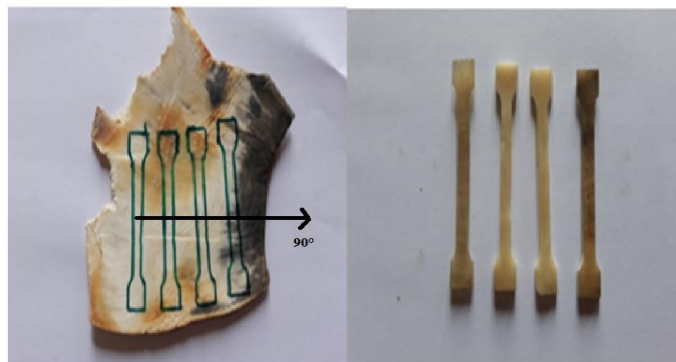

Figure 6: Cutting specimens at 90° [4]

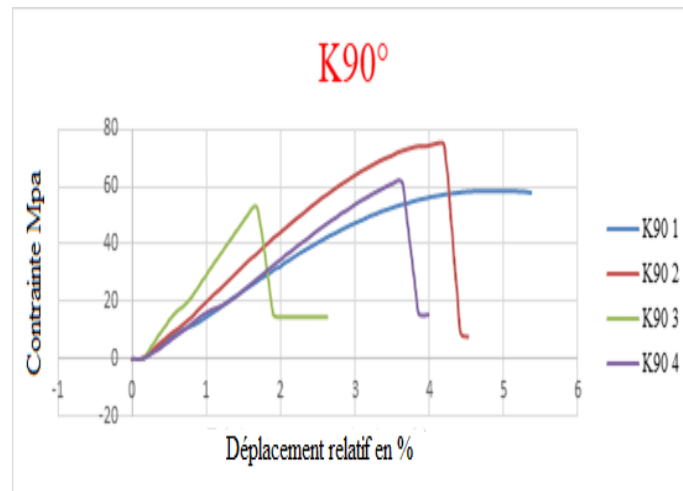

Figure 7: Tensile curves at 90° [4]

1.2.2 Numerical modeling of virgin material

Since the advent of computers more than half a century ago and, particularly in view of the increase in their computing power, numerical simulation has replaced direct experimentation which is too expensive and time-consuming to implement. It is nowadays more than a means of checking machine calculations. Mathematically, numerical simulation essentially requires the numerical resolution of partial differential equations that lead to approximate solutions. There are many methods of approximation that all have advantages and disadvantages; for example, the finite difference method, the finite volume method, the spectral methods, and so on.

We are interested in the finite element method, which is widely used in industry [5], [6], [7], particularly in aeronautics, the automotive industry, meteorology, etc. This method is interesting, given its flexibility of use, in particular with respect to the approximation of the various operators modeling phenomena in physics-mathematics and also for taking into account gradient conditions on the gradients of the function to be calculated [8].

In order to study the anisotropy of the biomaterial used and to confirm the results of the experimental tests [4], the present simulation will be devoted to the orientation of 45° at the direction of the fibers.

- Operating mode

- ❖ Geometry

We will proceed by setting each module of the software in the following order:



Figure 8: Geometry of the specimen

❖ Mechanical properties

The elastic characteristics of the investigated biomaterial represented in figure 5. (Tensile Strength, % of elongation at break and Young's Modulus) are determined using the tensile test performed on the specimens.

❖ Incrementation

We specified a 1ms simulation time with a time scale factor for the automatic incrementation of 1. These two parameters play an important role in solving the simulation so as not to have a distortion of element too important and that the calculation can succeed.

❖ Boundary conditions and loading

Tensile loading were applied to the specimen as shown in the Figure 7.

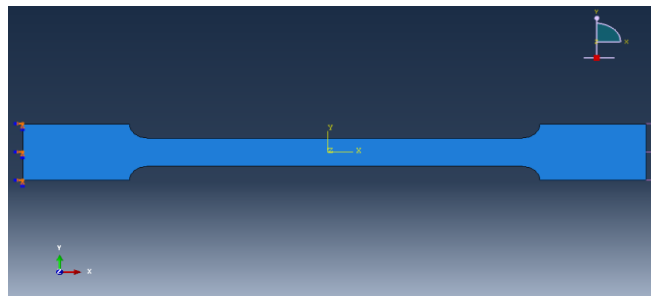

Figure 9: Boundary conditions and loading

❖ Mesh

Our structure has been meshed with elements of type CPS3 "3 linear nodes" and CPS4R "4 bilinear nodes" with a regular distribution in the middle and very refined at the level of leaves in extremities. The number of elements used is 746 and that of the nodes is 835. This mesh is presented by the figure below:

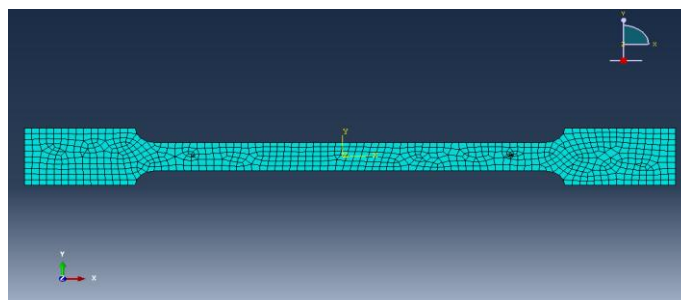

Figure 10: Mesh of the specimen

2. Results and discussion

The results of the tensile tests using numerical modeling by finite element method on several test pieces are shown in Figure 9.

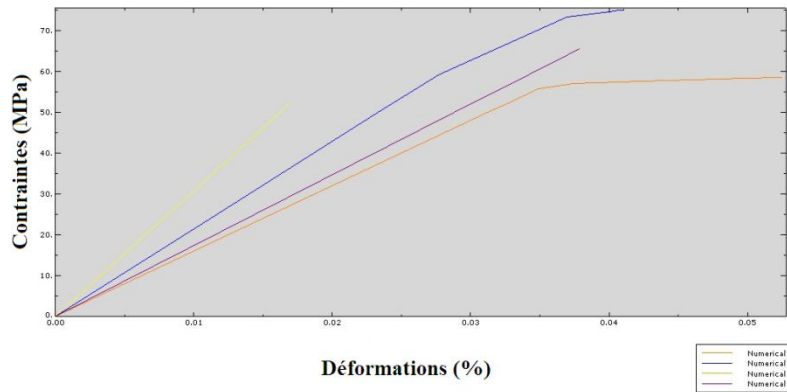

Figure 11: Numerical stress-strain curves at 90° of fiber direction

The mechanical properties obtained are presented in Tables II ,III and IV.

Table II:Parameters recorded using the 0° tensile test [4].

N° Of the specimen	Stress at break (MPa)	% of elongation at break	Young modulus (MPa)
1	95	4.2	2666
2	109	4.1	3000
3	96.5	3.6	3076
4	136	4.6	3500
5	98.1	2.9	3500
Mean	106,92	3,88	3148.4

Table III:Parameters recorded using the 45° tensile test [4].

N° Of the specimen	Stress at break (MPa)	% of elongation at break	Young modulus (MPa)
1	92.1	3.8	2449
2	86.59	2.6	3333
3	84.49	3.1	2727.3
4	90.49	3.01	3010
5	83.39	3.5	2400
6	91.87	3.1	3000
Mean	88.15	3.19	2820

Table IV:Parameters recorded using the numerical modeling at 90° [4].

N° Of the specimen	Stress at break (MPa)	% of elongation at break	Young modulus (MPa)
1	58,7	5,2	1600
2	75,2	4,1	2142
3	52,3	1,7	3076
4	65,7	3,7	1733
Mean	62,97	3,65	2137.75

The analysis and interpretation of the results show us that numerical modeling confirms the results obtained experimentally.

It is noted that in moving away from the direction of the fibers, the rigidity decreases and the stress at break also decreases at 45 ° of the direction of the fibers. At 90° the biomaterial becomes more ductile.

The biomaterial elongates and then begins to plastically deform to a maximum value of the stress at which it breaks completely. This deformation is no longer linear or reversible. This behavior occurs when one moves too far from the origin of the fibers. The appearance of a plastic zone shows that the studied material becomes relatively viscoelastic during the transversal stress.

The observed behavior is anisotropic since it depends on the orientation of the fibers.

It can be deduced that the behavior changes according to the orientation of the direction of the fibers with a reduction of Young's modulus, from where the rigidity is much better in the direction parallel to the direction of the fibers.

3. Conclusion

The evaluation of the tensile test results on a biomaterial of animal origin was done using finite element numerical modeling which offers several advantages such as its great ability to deal with nonlinear problems as well as complex laws.

The analysis of the results showed us that numerical modeling validated the experimental results. The behavior of the biomaterial studied is anisotropic because of its dependence on the orientation of the fibers.

The biomaterial elongates at 90° and then begins to plastically deform to a maximum value of the stress at which it breaks completely. This deformation is no longer linear or reversible. This behavior occurs when one moves too far from the origin of the fibers. The appearance of a plastic zone and the biomaterial becomes more ductile.

The Young's modulus decreases away from the direction of the fibers offering a better rigidity in the direction parallel to the direction of the fibers thanks to the keratin which gives it this rigidity.

References

- [1] K. Halada, R. Yamamoto, *Bulletin Jpn. Inst. Metals* 31, pp.505-512, 1992.
- [2] K. Halada, *Progress of ecomaterials toward a sustainable society, Current Opinion in Solid State and Materials Science* 7, pp.209-216-368, 2003.
- [3] E. Bretagne, J. Bréard, V. Massardier, V. Verney, *Eco-materials: The materials go green*, pp.367-368, 2012.
- [4] M. JAMMOUKH. "Contribution to experimental characterization and numerical modeling of the behavior of a composite material based on bio-charges," Thesis in mechanical engineering, Mohammedia, FST, pp.100-112, 2018.
- [5] K.P. Marimuthu, H.P. Prasad, C.S. Kumar, "Finite element modelling to predict machining induced residual stresses in the end milling of hard to machine Ti6Al4V alloy," *Periodicals of Engineering and natural sciences*, vol.7, no1, pp.1-11, 2019.
- [6] O.Y. Bozkurt, I.C. Dai, O. Ozbek, "The Finite Element Analysis and Geometry Improvements of Some Structural Parts Of Diesel Forklift Truck," *Periodicals of Engineering and natural sciences*, vol.5, no2, pp.202-209, 2017.
- [7] S. Komurcu, A. Gedikli, "Numerical Modelling of the In-Plane loaded Homogenized Masonry Walls," *Periodicals of Engineering and natural sciences*, vol.5, no3, pp.314-321, 2017.
- [8] P. SPITERI, *Variational Approach for The Finite Element Method*, AF503 v1, 2012.