

# A Tunable Microstrip Planar Antenna using Truncated Ground Plane for WiFi/LTE2500/WiMAX/5G/C, Ku, K-Band Wireless Applications

M. F. Khan, S. Ullah\*, W. U. Rahman, Lubna

Department of Telecommunication Engineering, University of Engineering and Technology, Peshawar, Pakistan.

\*corresponding authors: [sadiquallah@uetmardan.edu.pk](mailto:sadiquallah@uetmardan.edu.pk)

---

**Abstract** – Reconfigurable antennas are key candidates for modern wireless communicating devices to perform multiple wireless operations on various frequencies. This paper is introducing a compact yet efficient design of frequency reconfigurable TX-Shaped monopole antenna with truncated ground plane. The substrate used is FR-4 having a height of 1.6mm. Optical reconfiguration technique enables proposed structure to tune to multiple resonant frequencies depending upon ON/OFF state of the switch. In switch ON state, antenna exhibit quad band characteristics in nature by operating at resonant frequencies ranging from (2282-2816MHz), (4525-5053MHz), (11946-14203MHz) and (16200-19180MHz). While in switch OFF state, proposed structure operates at triple bands having frequencies ranging from (2685MHz-3632MHz), (11985MHz-14234MHz) and (16014-19107MHz). VSWR is calculated less than 1.4 with efficiency ranging from 52.5% to 82.6%, while gain of antenna is calculated ranging (1.62dB-3.53dB). Proposed tunable TX-Shaped structure is able to serve wireless services that includes Wi-Fi (2400-2480MHz), LTE2500 (2500-2690MHz), WiMAX (3300-3800MHz), FCC allocated mid band for 5G (2500MHz/3500MHz) and Satellite Communication applications in IEEE bands that includes C-band (2000-4000MHz), Ku-band (12000-18000MHz) and K-band (18000MHz-27000MHz). Proposed frequency reconfigurable TX-Shaped antenna is low cost, low profile, lightweight and can be used in wireless devices i.e. IPADs, Mobile Phones, 5G device, Tablets, Wi-Fi routers etc. Design and evaluation of antennas' parameters is observed and analyzed in CST Microwave Studio using Finite Integration Technique (FIT).

**Keywords:** Bluetooth, FIT, Monopole, Tunable Switches, WiMAX

## Article History

Received 23 January 2019

Received in revised form 21 February 2019

Accepted 21 February 2019

---

## I. Introduction

With modern innovations in the field of wireless technology, multiple wireless applications are needed to be supported by a single electronic device. Wireless technology challenges can be overcome by utilizing a single antenna that performs operation on multiple frequencies. Tunable antenna is potential candidate to meet the requirements of modern wireless communication system. Being highly efficient, low profile, low cost and advanced reconfiguration technique makes tunable antenna considerable for its use in present and future wireless technologies. Researchers in [1] observed and analyzed reconfiguration mechanisms and evaluated respective field as a hot topic for research. Conventional multiband antenna while utilizing multiple frequencies during wireless operations, doesn't consider the fact that it might not be substantial for an end user.

Advance switching techniques like PIN diodes, Optical Liquid Crystals and Micro-Electro Mechanical Systems (MEMS) incorporate in radiating structure which enables conventional and multiband antennas to be operated at a desired band of frequencies while increasing its efficiency.

PIN diodes are embedded in structure of novel antenna in order to achieve multiple frequencies depending upon the state of the switch using electronic switching mechanism for L, S and C-band applications [2].

Reduction of side lobes and improving impedance bandwidth of monopole antenna is reported in [3] for modern wireless and satellite communication. Microstrip antenna having less space requirement, resonating at a frequency of 10.15GHz, is suggested by researchers for future 5G wireless communication in [4].

In [5], an optically tunable monopole antenna is investigated by researchers for wireless services and is summarized in Table I.

TABLE I  
WIRELESS APPLICATIONS AND OPERATIONAL FREQUENCY RANGES

S.no	Wireless Applications	Frequency ranges (MHz)
1	Universal Mobile Telecommunication System (UMTS) [2]	1920-2170
2	World Wide Interoperability and Microwave Access (WIMAX) [2]	2500-2690/5250-5850
3	Wireless Fidelity (Wi-Fi) [2]	2400-2480
4	Bluetooth	2400-2480
5	Long Term Evolution (LTE2500) [19]	2500-2690
6	Fixed satellite (S-E), Mobile, Radio Astronomy, Space research (Passive) [20]	4500-5000
7	Mid Band (5G) [21]	2500/3500
8	Satellite Communication (T.V networks) [22]	4000-8000

In addition, authors in [6] inspected a seven shaped monopole structure by inserting an optical switch and designing a truncated ground plane to increase its efficiency and reducing its cost. Due to unique features of liquid crystal polymer, an antenna structure with electronic reconfiguration is observed in [7] for 5G networks. Conventional multiband antenna without reconfiguration techniques consumes more battery power with reduced performance for wireless operations, which can be solved by using method of reconfiguration (Pattern, Frequency and Polarization). For quad band cellular phones, a two pin diode is utilized to achieve tunable antenna that perform operations at Universal Mobile Telecommunications Service (UMTS) and Global System for Mobile communications (GSM-1900, GSM-1800, GSM-800) as observed in [8]. Features of chip inductors employed along with PIN diodes for UMTS and Wireless Local Area Network (WLAN) applications are discussed in [9]. Tremendous research work increase in Radio Frequency Micro-Electro Mechanical Systems (RF-MEMS) switches utilization to achieve reconfiguration is reported in [10]- [12].

Moreover, a newly designed circular antenna in [13] consisting of an inner and outer circular patch connected through photoconductive silicon switch is designed to achieve frequency reconfiguration and a laser light is provided from source via optical fiber coupled with switch by creating a hole in the substrate; thus improving the performance of frequency reconfigurable antenna and return loss, by increasing the power of laser light. Various reconfiguration mechanisms in [14] led antenna to be used for space applications. Similarly switch ON/OFF states are controlled using IRED's (880nm) to achieve frequency reconfigurable antenna by tuning frequency from 3.9 to

6.2 for cognitive radio applications in [15].

In this paper, a novel frequency reconfigurable TX-Shaped monopole antenna is designed on FR-4 substrate with a height of 1.6mm. Truncated ground plane is designed to enhance its performance and features of microwave circuit. Proposed structure is suitable to be used for wireless applications and also for the applications that includes Worldwide Interoperability for Microwave Access (WIMAX), Long Term Evolution (LTE), International Mobile Telecommunications-Advanced (IMT-A), C-band, Ku-band and K-band for satellite applications. Optical switches have advantage of ease in integration and do not require biased lines as compared to PIN diodes as observed in [16].

In CST Microwave Studio optical switches are incorporated using lumped elements. The values of lumped elements are different depending upon the state of the switch. After excitation through transient solver, a high resistance value in lumped elements shows OFF-state of the switch whereas a low resistance value shows ON-state of the switch allowing flow of current in a certain portion of the radiating patch. Various switching techniques are utilized to achieve tunable antenna of which the frequently used techniques are summarized in Table II.

TABLE II  
SWITCHING TECHNIQUES

S.no	Switching Mechanism	Description
1	Physical Reconfiguration	Alteration in Structure
2	Electrical Reconfiguration	Varactor, RF-MEMS
3	Material Reconfiguration	Ferrites, Liquid Crystals
4	Electronic Reconfiguration	PIN diodes
5	Optical Reconfiguration	Photo detectors, Photo diodes

## II. Design Methodology and Geometry

This section represents the design methodology as well as the geometry of proposed TX-Shaped switchable planer monopole antenna.

### A. Design of Switchable TX-Shaped Monopole Antenna on Truncated Ground plane

The geometry and dimensions of proposed switchable TX-Shaped planer monopole antenna for WIMAX, LTE2500, Wi-Fi, Bluetooth, 5G, C-band, Ku-band and K-Band wireless services is shown (see Fig. 1). Proposed antenna is designed on FR-4 substrate with a thickness of 1.6mm having loss tangent 0.019 and relative permittivity 4.5. FR-4 in humid and dry condition has high electrical insulating and optimum mechanical value. The rate of absorption of water in respective substrate is nearly zero. Due to its low cost and unique features, FR-4 substrate is

used in electronic technology for a wide range of applications.

Radiating element and truncated ground plane is designed using copper as a material to achieve an effective gain and optimum efficiency. Respective monopole is fed via  $50\Omega$  copper microstrip line. Utilizing well known equation from [17] to obtain the width of feed line ( $W_f=3\text{mm}$ ). In front view of designed antenna (see Fig. 1(a)), the lower and upper part of radiating element is connected by line which is an optical switch.

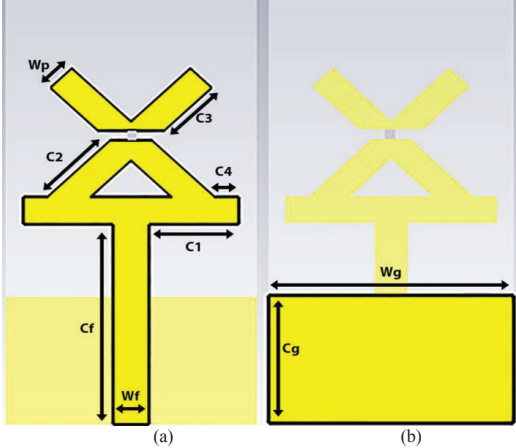

Fig. 1. Design of Switchable TX-Shaped Monopole Antenna on Truncated Ground Plane, (a) Front View (b) Back View

In modern technology optical switch i.e. photodiodes are used as a switch or relay in an electronic system to achieve better performance as compared to electrical switches.

In proposed research work a PDINCC series single InGaAs photodiode (see Fig. 2) having dimension of  $1\text{mm}$  is utilized. Calculated standard optimal range of InGaAs is  $1000\text{-}1650\text{nm}$ . Respective switch is designed in CST microwave studio by utilizing their standard parameters listed in Table III.

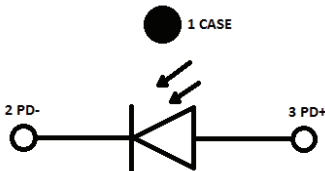

Fig. 2. Schematic Diagram of PDINCC Series InGaAs Pin Photodiode

TABLE III  
SUMMARY OF STANDARDIZED PARAMETERS OF PDINCC SERIES PHOTODIODE

Parameters	Values
Wavelength (nm)	1000-1650
Active Area (mm)	1
Responsivity (A/W)	0.90
Dark Current (nA)	5
Capacitance (pf)	100
Shunt Resistance (M Ohm)	10
Bandwidth (MHz)	30
Reverse Voltage (V)	10
Forward Current (A)	50
Operating Temperature ( $^{\circ}\text{C}$ )	(-40)-(85)
Storage Temperature ( $^{\circ}\text{C}$ )	(-40)-(85)
Input Optical Power (mW)	5
Soldering Temperature ( $^{\circ}\text{C}/\text{Sec}$ )	260/10

Using theory of transmission line model from [18], effective length “C” of proposed antenna is calculated as  $C_{2.50}=52.22\text{mm}$ ,  $C_{4.80}=42.22\text{mm}$ ,  $C_{13.27}=20.46\text{mm}$  and  $C_{18.45}=18.21\text{mm}$ , which include all lengths of the X-Shaped structure in ON-state (Quad band) of a switch. Whereas, in OFF-state a partial portion of “X” and radiating element “T” is responsible for operation on desired frequencies (Triple band) having effective length of  $C_{3.09}=46.59\text{mm}$ ,  $C_{13.27}=20.46\text{mm}$ , and  $C_{18.29}=18.65\text{mm}$ . Given resonant lengths can be written in the form of guided wavelengths  $\lambda_{2.50}$ ,  $\lambda_{3.09}$ ,  $\lambda_{4.80}$ ,  $\lambda_{13.27}$ ,  $\lambda_{18.29}$ ,  $\lambda_{18.45}$  using (1)-(6).

$$C_{2.50} = \lambda_{2.50}/4 \quad (1)$$

$$C_{3.09} = \lambda_{3.09}/4 \quad (2)$$

$$C_{4.80} = \lambda_{4.80}/4 \quad (3)$$

$$C_{13.27} = \lambda_{13.27}/4 \quad (4)$$

$$C_{18.29} = \lambda_{18.29}/4 \quad (5)$$

$$C_{18.45} = \lambda_{18.45}/4 \quad (6)$$

A guided wave length for desired resonant frequency can be calculated from (7).

$$\lambda_{fr} = \frac{c}{f_r \sqrt{\epsilon_e}} \text{ (GHz)} \quad (7)$$

“ $f_r$ ” is the desired resonant frequency, “c” is the velocity of light, “h” shows thickness of substrate, “Wp” is the width of radiating element, “ $\epsilon_r$ ” is the relative permittivity while “ $\epsilon_e$ ” is the effective permittivity of the material and is calculated using (8).

$$\epsilon_e = \frac{\epsilon_r + 1}{2} + \frac{\epsilon_r - 1}{2} (1 + 12h/Wp)^{-1/2} \quad (8)$$

Proposed antenna is conveniently shaped into a small compact size having dimensions  $40 \times 21 \times 1.6\text{mm}^3$ .

Summary of overall dimensions of the proposed antenna (see Fig. 1) is given in Table IV.

TABLE IV  
SUMMARY OF DIMENSIONS FOR FREQUENCY RECONFIGURABLE TX-SHAPED ANTENNA IN FIG. 1

Lengths	Values
$C1$	7.50mm
$C2$	7.42mm
$C3$	5.63mm
$C4$	1.98mm
$WP$	2.5mm
$Cf$	18.75mm
$Cg$	12mm
$Wg=Ws$	21mm
$h$	1.6mm
$Wf$	3mm
$Cs$	40mm

### III. Simulations and Results

In CST Microwave Studio, a numerical Finite integration technique (FIT) from [18] is utilized in order to design and analyze respective microstrip antenna. Thus solution of electromagnetic wave equation is eligible in frequency as well as in time domain. To study antennas' various parameters i.e. scatter parameter, directivity, Voltage Standing Wave Ratio (VSWR), gain, return loss, impedance and efficiency, an excitation is given to proposed antenna by using wave guide port. Open boundary condition and transient solver is used to evaluate respective parameters efficiently.

#### A. Return Loss

In ON state of an optical switch, a resonant frequency at 2.50GHz, 4.80GHz, 13.27GHz and 18.45GHz (WIMAX, LTE2500, 5G, C-band, Ku-band and K-band) is obtained having return loss of -29.36dB, -23.10dB, -16.37dB, -19.44dB in a frequency range 1-20GHz whereas in OFF state of an optical switch, a resonant frequency at 3.09GHz, 13.27GHz and 18.29GHz (S-band, Ku-band, K-band) is obtained as tabulated in Table V.

TABLE V  
SWITCHING STATES AND RESONANT FREQUENCIES

S.no	Switch State	Resonant Frequency (GHz)
1	ON	Quad Band , 2.50, 4.80, 13.27, 18.45
2	OFF	Triple Band 3.09, 13.27, 18.29

Respective antenna operates on multiple bands in each switching state. Table V shows the desired resonant frequency according to ON/OFF state of a switch. Whereas the return loss of simple multiband antenna and optically reconfigured antenna is shown (see Fig. 3). According to the graph, simple multiband antenna showing satisfactory performance radiating at three resonant frequencies whereas the simple version is modified and optically reconfigured in order to achieve best performance by obtaining new resonant frequencies

and improving existing resonant frequencies of simple multiband antenna for modern cellular and satellite applications.

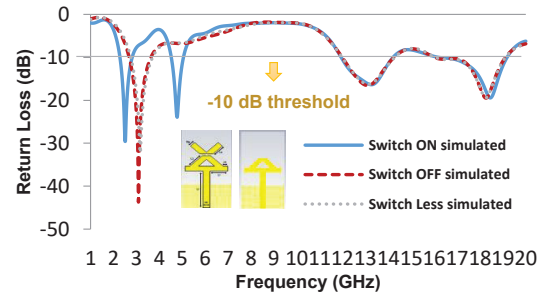

Fig. 3.  $S_{11}$  Parameters-Return loss in Switch ON and Switch OFF state

Furthermore, proposed structure is evaluated with respect to the size of the ground in both switching states. In Switch ON state, performance of antenna at full ground plane is degraded and we observed only one resonant frequency band with poor impedance matching. However, antenna showing satisfactory performance at half ground plane with a shift in resonant frequency (Single band). Hence, over all antenna performance in switch ON state is improved by selecting optimum value of ground plane. Truncated ground plane value is achieved by changing size of ground plane through parametric analysis of proposed structure. It is observed that antenna operates at multiple frequencies (Quad band) utilizing truncated ground plane and can be used for modern wireless applications. Return loss of TX-shaped tunable antenna for different ground plane size is shown (see Fig. 4).

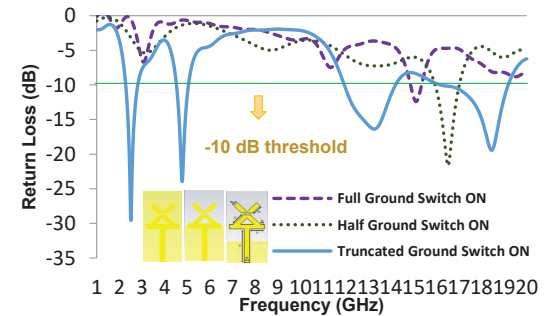

Fig. 4.  $S_{11}$  Parametric Analysis of TX tunable monopole in Switch ON state

In Switch OFF state, antenna performance is degraded at full size and half size ground plane as compared to performance observed using truncated ground plane. Antenna radiates at multiple resonant frequencies (Triple band) with improved parameters (Gain, Directivity, efficiency etc.) whereas single band is achieved in both full and half ground plane is shown (see Fig. 5).

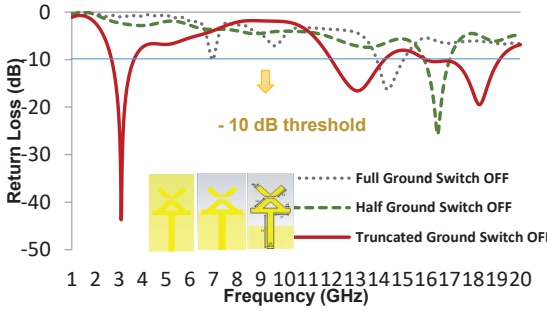

Fig. 5.  $S_{11}$  Parametric Analysis of TX tunable monopole in Switch OFF state

B. Gain Patterns & VSWR

Gain Patterns (E- and H-plane) in switch ON mode of proposed TX-Shaped monopole antenna at 2.50GHz, 4.80GHz, 13.27GHz, 18.45GHz and 3.5GHz are shown (see Fig. 6), having values 1.62dB, 1.46dB, 3.29dB and 3.26dB respectively. A gain of 1.76dB, 3.53dB, 3.38dB is achieved at resonant frequency 3.09GHz, 13.27GHz and 18.29GHz respectively in the switch OFF mode.

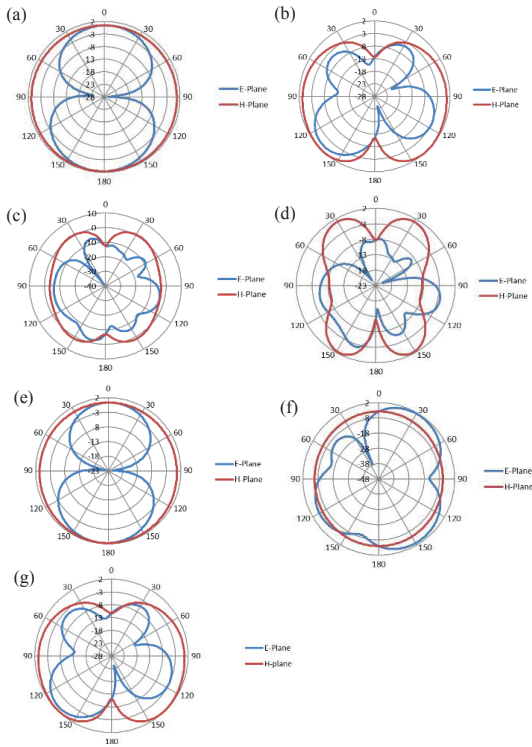

Fig. 6. E and H-Planes in Switch ON-Mode at 2.50GHz, 4.80GHz, 13.27GHz and 18.45GHz respectively. While (e)-(g) shows E and H-Planes in Switch OFF-Mode at 3.09GHz, 13.27GHz and 18.09GHz respectively

Voltage standing wave ratio is a fundamental parameter of antenna which accounts mismatch losses between radiating structure and guiding device. Proposed monopole structure has a VSWR less than 1.4 for the fundamental frequencies in their desired state. It gives a VSWR of 1.07, 1.15, 1.36, and 1.24 in ON mode at a frequency of 2.50GHz, 4.80GHz, 13.27GHz and 18.45GHz respectively. Whereas in OFF mode, VSWR is found to be 1.01, 1.36, 1.24 at frequency 3.09GHz, 13.27GHz and 18.29GHz respectively (see Fig. 7). Antenna is matched properly to the fed impedance.

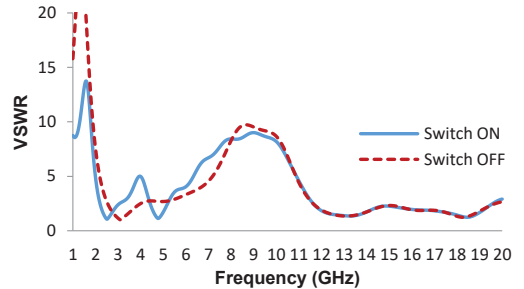

Fig. 7. VSWR in Switch ON & OFF state

C. Surface Currents & Far field Radiation

The distribution of current over radiating structure can be analyzed in both states of the switch. In switch ON condition, whole portion of radiating structure takes part in radiation at defined resonant frequencies. In OFF mode, a half Portion “X” and T-Shape of antenna takes part in radiation. However, radiation observed in upper half portion of X shape in OFF mode is due to electromagnetic radiation coupling. Surface currents of TX-Shaped monopole are shown (see Fig. 8).

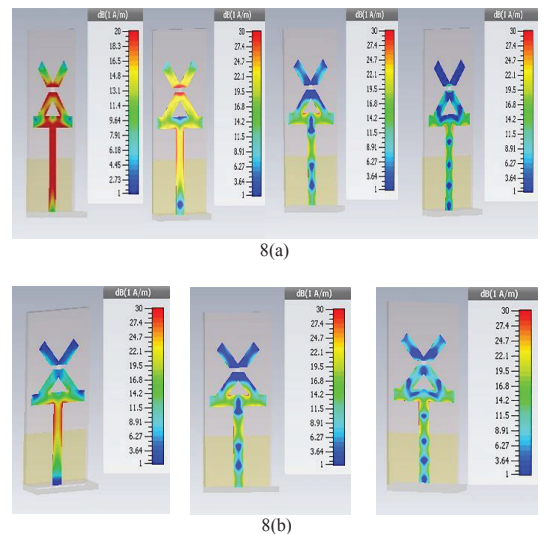

Fig. 8. Surface currents (a) Switch ON-Mode (b) Switch OFF-Mode

Proposed antenna has the following Far-Field Radiation Plots (3D), which are analyzed in CST Microwave Studio using FIT. Radiation patterns are obtained in both states of a switch (see Fig. 9). Directivity values of radiation in ON mode is calculated as 2.44dBi, 4.24dBi, 4.89dBi, 5.70dBi at 2.50GHz, 4.80GHz, 13.27GHz and 18.45 GHz; whereas 2.70dBi, 5.12dBi, 5.64dBi is achieved at 3.09GHz, 13.27GHz and 18.29GHz in OFF mode respectively.

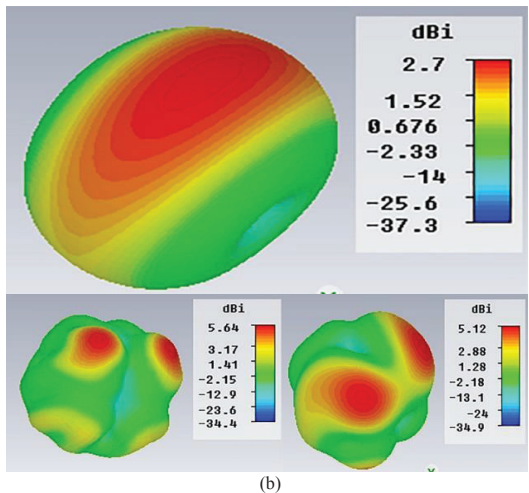
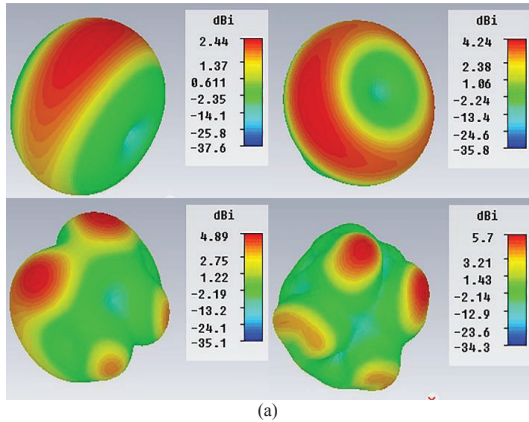

Fig. 9. Far Field Radiation (a) ON State (b) OFF State

D. Size Miniaturization and Summary of Results

TX-Shaped frequency reconfigurable antenna is designed having compact size of 40 x 21mm<sup>2</sup>. Quad band and triple band behavior of antenna is achieved on the basis of employing switching mechanism in radiating structure. Designing a truncated ground plane enables the antenna to perform efficiently while reducing its total cost. TX-Shaped multiband monopole structure is compared, in terms of size and frequency bands, to a previous research work listed in Table VI. Table VII and Table VIII

represents overall summary of the proposed antennas' parameters.

TABLE VI  
COMPARATIVE STUDY OF PROPOSED STRUCTURE WITH PREVIOUS RESEARCH WORK

Reference	Dimension	Frequency range (MHz)	Comments
[2]	40 x 22	2227-2663, 5078-5744	Dual band
[23]	40 x 35	2260-2420, 3290-3600	Large Size, Dual band only
[24]	60 x 60	1550-1570, 2395-2695, 4975-5935	Large Size, Triple band
[25]	67 x 38	863-1049, 1490-2810	Large size, dual band only
Proposed work	40 x 21	(2282-2816, 4525-5053, 11946-14203, 16200-19180) (2685-3632, 11985-14234, 16014-19107)	Quad band and triple band, Optical reconfiguration size miniaturized

TABLE VII  
SUMMARY OF RESULTS IN SWITCH ON-MODE

Parameters	Switch ON			
Frequency	2.50GHz	4.80GHz	13.27GHz	18.45GHz
Directivity	2.44dBi	4.24dBi	4.89dBi	5.70dBi
Gain	1.62dB	1.46dB	3.29dB	3.26dB
Return Loss	-29.36dB	-23.10dB	-16.37dB	-19.44dB
Band Width	21.6%	11.04%	17.33%	16.04%
Efficiency	82.6%	52.5%	67.6%	79.8%
Impedance	53.23Ω	46.63Ω	52.39Ω	56.1Ω
VSWR	1.07	1.15	1.36	1.24

TABLE VIII  
SUMMARY OF RESULTS IN SWITCH OFF-MODE

Parameters	Switch OFF		
Frequency	3.09GHz	13.27GHz	18.29GHz
Directivity	2.70dBi	5.12dBi	5.64dBi
Gain	1.76dB	3.53dB	3.38dB
Return Loss	-43.70dB	-16.26dB	-19.43dB
Band Width	31.07%	16.96%	16.89%
Efficiency	80.46%	67.65%	61.95%
Impedance	50.62Ω	53.75Ω	61.95Ω
VSWR	1.01	1.36	1.24

IV. Conclusion

A multiband tunable TX-Shaped planer monopole antenna for WIMAX, Wi-Fi, LTE2500, S-band, Ku-band and K-band has been designed and investigated in this paper. Respective antenna is reconfigured by utilizing optical reconfiguration technique to operate in different wireless services. Quad band is achieved from proposed structure in switch ON mode. The same antenna operates at three (Triple band) resonant frequencies in its switch OFF mode. A highly efficient monopole is analyzed

having efficiency up to 82.6% using truncated ground plane. Return loss is obtained below -10dB threshold at specified resonant frequencies, with efficient bandwidth, VSWR and better impedance matching. Omni directional far field pattern of TX-Shaped radiating monopole is more flexible to operate in a wireless environment. Proposed Antenna with its own efficient features can be used in wireless applications i.e. WIMAX, LTE, S-band, C-band, Ku-band and K-band satellite applications (Fixed satellite, Radio astronomy, Space research, T.V networks). Proposed TX-Shaped frequency reconfigurable antenna can be used in wireless devices like smart watch, laptops, mobile phones, vehicles and remote control devices.

As a future work, gain of respective antenna can be enhanced by using meta materials in order to be used in 5G devices to operate at FCC allocated mid band for capacity and coverage i.e. 2.5GHz and 3.5GHz respectively. The prototype of the antenna will be fabricated to validate the simulated results.

### Acknowledgements

The authors wish to acknowledge the Higher Education Commission (HEC) of Pakistan, for supporting this research and Telecommunication Engineering Department of UET Peshawar for providing us timely research facilities.

### References

- [1] D. E. Anagnostou, G. Zheng, M. Chryssomallis, J. Papapolymerou, C. G. Christodoulou, J. Lyke and G. Ponchak, Design, Fabrication and Measurements of a Self-Similar Re-Configurable Antenna with RF-MEMS Switches, *IEEE Transactions on Antennas & Propagation*, Vol. 54(Issue 2):422-432, February 2006.
- [2] R. Soloni, H. S. Rajappa and D. N. Chandrappa, Design and analysis of multiband reconfigurable microstrip patch antenna with switchable element, *International Conference on Advances in Computing, Communications and Informatics (ICACCI)*, pp. 288-293, Udupi, 2017.
- [3] L. Meng, W. Wang, M. Su, J. Gao and Y. Liu, Bandwidth Extension of a Printed Square Monopole Antenna Loaded with Periodic Parallel-Plate Lines, *International Journal of Antennas and Propagation*, Vol. 2017:1-10, May 2017.
- [4] S. Verma, L. Mahajan, R. Kumar, H. S. Saini and N. Kumar, A small microstrip patch antenna for future 5G applications, *2016 5th International Conference on Reliability, Infocom Technologies and Optimization (Trends and Future Directions) (ICRITO)*, pp. 460-463, Noida, 2016.
- [5] S. A. A. Shah, M. F. Khan, S. Ullah, A. Basir, U. Ali and U. Naeem, Design and Measurement of Planar Monopole Antennas for Multi-Band Wireless Applications, *IETE Journal of Research*, Vol. 63(Issue 2):194-204, January 2017.
- [6] S. A. A. Shah, M. F. Khan, S. Ullah and J. A. Flint, Design of a multi-band frequency reconfigurable planar monopole antenna using truncated ground plane for Wi-Fi, WLAN and WiMAX applications, *2014 International Conference on Open Source Systems & Technologies*, pp. 151-155, Lahore, 2014.

- [7] S. F. Jillani, B. Greinert and Y. Hao and A. Alomainy, Flexible Millimetre-Wave Frequency Reconfigurable Antenna for Wearable Applications in 5G Networks, *URSI International Symposium on Electromagnetic Theory (EMTS)*, 2016.
- [8] Y. K. Park and Y. Sung, A Reconfigurable Antenna for Quad-Band Mobile Handset Applications, *IEEE Transactions on Antennas and Propagation*, Vol. 60(Issue 6):3003-3006, June 2012.
- [9] R. Gonçalves, P. Pinho and N. B. Carvalho, Compact Frequency Reconfigurable Printed Monopole Antenna, *International Journal of Antennas and Propagation*, Vol. 2012(Article ID 602780):6 pages, 2012.
- [10] K. Topalli, E. Erdil, O. A. Civi, S. Demir, S. Koc, and T. Akin, Tunable dual-frequency RF MEMS rectangular slot ring antenna, *Sensors and Actuators A*, Vol. 156(Issue 2):373-380, 2009.
- [11] A. Grau, J. Romeu, M. J. Lee, S. Blanch, L. Jofre, and F. D. Flaviis, A Dual-Linearly-polarized MEMS-reconfigurable antenna for narrowband MIMO communication systems, *IEEE Transactions on Antennas and Propagation*, Vol. 58(Issue 1):4-17, 2010.
- [12] D. E. Anagnostou, G. Zheng, and L. Feldner, Silicon-etched reconfigurable self-similar antenna with RF-MEMS switches, *IEEE Antennas and Propagation Society Symposium*, Vol. 2:1804-1807, June 2004.
- [13] Y. Tawk, A. R. Albrecht, S. Hemmady, G. Balakrishnan and C. G. Christodoulou, Optically Pumped Frequency Reconfigurable Antenna Design, *IEEE Antennas and Wireless Propagation Letters*, Vol. 9:280-283, 2010.
- [14] C. G. Christodoulou, Y. Tawk, S. A. Lane and S. R. Erwin, Reconfigurable Antennas for Wireless and Space Applications, *Proceedings of the IEEE*, Vol. 100(Issue 7):2250-2261, July 2012.
- [15] A. Andy, P. Alizadeh, K. Z. Rajab, T. Kreouzis and R. Donnan, An optically-switched frequency reconfigurable antenna for cognitive radio applications, *10th European Conference on Antennas and Propagation (EuCAP)*, pp. 1-4, Davos, 2016.
- [16] C. G. Christodoulou, Y. Tawk, S. A. Lane and S. R. Erwin, Reconfigurable Antennas for Wireless and Space Applications, *Proceedings of the IEEE*, Vol. 100(Issue 7):2250-2261, July 2012.
- [17] C. A. Balanis, *Antenna Theory Analysis and Design 2nd Edition*, (New York: John Wiley & Sons, 1997).
- [18] F. Hirtenfelder, Effective Antenna Simulations Using Computer Simulation Technology Microwave Studio, *2nd International ITG Conference on Antennas (INICA-07)*, pp. 239, Munich, Germany, March 2007.
- [19] Y. Hong, J. Tak, J. Baek, B. Myeong and J. Choi, Design of a Multiband Antenna for LTE/GSM/UMTS Band Operation, *International Journal of Antennas and Propagation*, Vol. 2014 (Article ID 548160):9 pages, 2014.
- [20] [https://cdn.rohdeschwarz.com/pws/dl\\_downloads/dl\\_common\\_library/dl\\_news\\_from\\_rs/199/N199\\_70-75\\_services-and-applications-3GHz-300GHz\\_e.pdf](https://cdn.rohdeschwarz.com/pws/dl_downloads/dl_common_library/dl_news_from_rs/199/N199_70-75_services-and-applications-3GHz-300GHz_e.pdf) [accessed on 15 January 2019]
- [21] <https://www.fcc.gov/5G> [accessed on 16th January 2019]
- [22] [https://www.esa.int/Our\\_Activities/Telecommunications\\_Integrated\\_Applications/Satellite\\_frequency\\_bands](https://www.esa.int/Our_Activities/Telecommunications_Integrated_Applications/Satellite_frequency_bands) [accessed on 16th January 2019]
- [23] X. L. Sun, S. W. Cheung and T. I. Yuk, Dual-band monopole antenna with compact radiator for 2.4/3.5 GHz WiMAX applications, *Microwave and Optical Technology Letters*, Vol. 55(Issue 8):1765-1770, 2013.
- [24] T. H. Chang and J. F. Kiang, Compact multi-band H-shaped slot antenna, *IEEE Transactions on Antennas and Propagation*, Vol. 61(Issue 8):4345-4349, 2013.
- [25] D. H. Hsieh, J. W. Wu, Y. W. Cheng and C. J. Wang, ACPW fed meandered-shaped monopole antenna with asymmetrical ground planes, *Proceedings of the IEEE Radio and Wireless Symposium (RWS '15)*, pp. 86-88, San Diego, Calif, USA, January 2015.

