

APPLICATION OF HYBRID SUGAR PALM-FILLED POLYURETHANE COMPOSITES IN CONCEPTUAL DESIGN OF AN AUTOMOTIVE ANTI-ROLL BAR

M.T. Mastura^{1,2}, S.M. Sapuan^{1,3,*}, M.R. Mansor², A.A. Nuraini¹

¹Department of Mechanical and Manufacturing Engineering, Universiti Putra Malaysia
43400 UPM Serdang, Selangor, Malaysia

² Faculty of Mechanical Engineering, Universiti Teknikal Malaysia Melaka,
Hang Tuah Jaya, 76100 Durian Tunggal, Melaka, Malaysia

³Laboratory of Biocomposite Technology, Institute of Tropical Forestry and
Forest Products (INTROP) Universiti Putra Malaysia
43400 UPM Serdang, Selangor, Malaysia

ABSTRACT

*Forest products are important sources of income in developing countries like Malaysia and research on utilizing them has intensified. One of the forest products that is investigated at Universiti Putra Malaysia is sugar palm (*Arenga pinnata*). Bio-composites made from sugar palm fiber and biopolymers have been developed using different types of plasticizers. In addition, sugar palm fiber alone can be a good raw material for various domestic products like brooms, ropes, roofs and headgear, just to name a few. The most recent work on sugar palm bio-composites was devoted to fabricating an automotive component, i.e. an anti-roll bar, from hybrid glass/sugar palm fiber-filled polyurethane composites. The conceptual design of the automotive anti-roll bar was developed and refined. The conceptual design was developed according to the design requirements and characteristics of the sugar palm composite. Reinforcement of the rib in the anti-roll bar's design showed an improvement in terms of the stiffness of the anti-roll bar.*

KEYWORDS: *Forest products; bio-composites; sugar palm; product development*

1.0 INTRODUCTION

Sugar palm, scientifically named *Arenga pinnata Merr.*, is a tropical forest plant mainly found in South Asia including India, Malaysia, Thailand, Vietnam, Indonesia and North Australia. Many products can be produced from this plant such as food products, home appliances, residential construction materials and chemical products. The fiber from the sugar palm tree is contained in the sugar palm frond, bunches and trunk. Fibers from different parts of the tree have shown different mechanical properties, according to work reported by Sahari et al. (2011). Generally, sugar palm fiber is known to be highly durable and resistant to seawater. Moreover, the process of fiber preparation is effortless as the fibers are naturally wrapped around the trunk in a natural woven arrangement (Sahari, Sapuan, Zainudin & Maleque, 2013). Due to this fact, the processing cost of sugar palm fiber is generally lower than for other types of fiber. Regarding the great mechanical

* Corresponding Email: sapuan@upm.edu.my

properties of sugar palm fiber, further application in the automotive industry is going to be the area of focus in this study, in order to widen the application of sugar palm products.

The aim of this study is to determine the ability of the sugar palm-based composite to be used as a replacement for alloy steel in an automotive component. An automotive anti-roll bar is taken as the case study as sugar palm fiber is the primary material in its design. Development of the conceptual design of a hybrid glass/sugar palm fiber-filled polyurethane composites automotive anti-roll bar will be achieved using several tools in design activities. The final conceptual design will be selected according to the design requirements and characteristics of the sugar palm composite.

2.0 SUGAR PALM COMPOSITES

Past researchers have conducted studies on obtaining the properties of sugar palm composites reinforced with different types of polymer. Reinforcement with polymer is required where the application of the sugar palm composites could be wider, as this improves the properties of the sugar palm fiber. Suriani, Hamdan, Sastra and Sapuan (2007) conducted work on the sugar palm reinforced polymer composite and discover the tensile properties of the sugar palm reinforced with different types of polymer. For the sugar palm reinforced vinyl ester composite, the tensile strength and tensile modulus were 46.18 MPa and 4.32 GPa respectively, while the sugar palm reinforced epoxy composite obtained as much as 42.48 MPa and 4.97 GPa for the tensile strength and tensile modulus respectively. They also obtained the value of tensile strength and tensile modulus for sugar palm reinforced polyester, which is 35.15 MPa and 5.43 GPa, respectively. In another study, Leman, Sapuan, Azwan, Ahmad and Maleque (2008) reported work on chopped sugar palm reinforced epoxy composite where the content of the fiber was about 15% by volume. In their study, they found that the lowest tensile stress was with an average stress of 17306.91 kPa and the highest average stress value was 23042.48 kPa. Previously, Leman, Sastra, Sapuan, Hamdan and Maleque (2005) had performed an impact test to evaluate the impact strength of the same composite but in a different orientation. In their study, the fiber that was provided in the form of random orientation obtained 67.26 J/m and 114.27 J/m for long fibers of the sugar palm composite. Moreover, Sapuan and Bachtiar (2012) reported a work on sugar palm reinforced high-impact polystyrene (HIPS). Six fiber contents of 0%, 10%, 20%, 30%, 40 % and 50% (HIPS) were used as the polymer matrix. The average tensile strength for the 30% fiber content was 19.3 MPa. As sugar palm fiber polymer composites have improved the properties of sugar palm fiber, it is necessary for more studies to be conducted with other types of polymer, in order to investigate their use in various applications.

Traditionally, sugar palm fiber is used for home appliances such as brushes and brooms (Sahari, Sapuan, Zainudin, & Maleque, 2012). In addition, people that live near a forest where sugar palm trees are mostly found use sugar palm fiber as roofs for their houses. The fiber's simple preparation process makes it easy to use, as it requires a low level of technology (Ishak et al., 2013). Furthermore, a composite based on sugar palm fiber would enhance the characteristics of the sugar palm fiber and more products could be produced. Misri, Leman, Sapuan and Ishak (2010) reported work on sugar palm composites for small boat application where they added glass fiber to hybrid sugar palm composites. In their study, they found that the addition of glass fiber to sugar palm

composites improved the tensile properties of the composites, and that a compression molding technique is suitable to be used in making a small boat using natural fiber composites.

3.0 A CASE STUDY: A HYBRID GLASS/SUGAR PALM FIBER-FILLED POLYURETHANE COMPOSITE AUTOMOTIVE ANTI-ROLL BAR

One case study has been performed in order to evaluate the ability of a sugar palm composite to be used in automotive applications where most of the automotive products are steel based. In a move to support policies promoting a green environment and sustainability, sugar palm composite gives an advantage in development of the automotive anti-roll bar particularly. The automotive anti-roll bar is known as a device that is subjected to extreme mechanical loading in a suspension system. The anti-roll bar functions as a device that controls the sway movement of a vehicle whilst cornering or on uneven road conditions, and prevents the vehicle from rolling over (Doody, 2013). The anti-roll bar is also known as the sway bar and stabilizer bar. In the anti-roll bar' development, the performance of the component in terms of strength and stiffness is the important parameter in the design requirements, other than cost and weight (Prawoto, Djuansjah, Tawi, & Fanone, 2013). Therefore, the Theory of Inventive Problem Solving (TRIZ) method is introduced in the development of a conceptual design for a hybrid glass/sugar palm fiber-filled polyurethane composite automotive anti-roll bar. The purpose of using TRIZ as a method in the conceptual design development is that TRIZ is proven as a method that could solve design problems in a more systematic and inventive way (Rantanen & Domb, 2014). Commonly, Engineering Contradiction that included in TRIZ method have helped design engineers to design products with new material. Similarly, in the design of a hybrid glass/sugar palm fiber-filled polyurethane composite automotive anti-roll bar, there is a contradiction that the designers have to solve to ensure that the hybrid glass/sugar palm fiber-filled polyurethane composite automotive anti-roll bar would not reduce the performance shown by the conventional steel automotive anti-roll bar significantly.

3.1 Conceptual Design of the Hybrid Glass-Sugar Palm Fiber-Filled Polyurethane Composite Automotive Anti-Roll Bar

The stiffness of the anti-roll bar is defined by the geometry and material properties and strongly depends on the diameter of the anti-roll bar as shown in the Equation (1) (Rill, 2006):

$$c = \frac{G\pi d^4}{32a^2b} \quad (1)$$

where G is modulus of shear, a and b are defined as a distance as in Figure 1 and d is diameter of the anti-roll bar. From the equation, the Engineering Contradiction in the form of improving parameter and worsening parameter is defined. In this case, the Engineering Contradiction is: *“If the diameter of the bar is increased, the stiffness of the bar is improved but it is ultimately gaining more weight”*. This means that, in order to improve the stiffness of the bar, the diameter of the bar should be increased; however, this would require more weight on the bar. So, the improving parameter is Volume of moving object

(#7), Strength (#14) and Reliability (#27). The worsening parameter in this case is Weight of moving object (#1) (San, Jin, & Li, 2009). By referring to the Contradiction Matrix in Table 1, the suggested Inventive Principles are as shown.

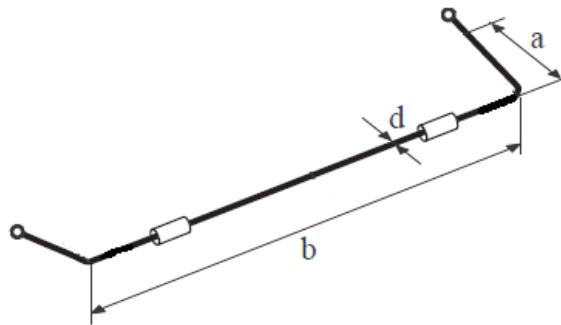

Figure 1. Anti-roll bar (Rill, 2006)

Table 1. Specific solution strategy based on the TRIZ general solution principles

TRIZ general solution principles	Solution descriptions	Specific solution strategy
#2 Taking out	Separate an interfering part or property from an object, or single out the only necessary part (or property) of an object	Cross section of the anti-roll bar could be in a hollow shape or flat plate by taking out unnecessary parts while maintaining the performance of the component (Sharma, Bora, & Sharma, 2012).
#3 Local quality	(a) Change an object's structure from uniform to non-uniform, change an external environment (or external influence from uniform to non-uniform. (b) Make each part of an object function in conditions most suitable for its operation (c) Make each part of an object fulfil a different and useful function	(a) Vary diameter of the component in order to handle the high stress at critical points along the bar. The value depends on the value of stress concentration and safety factor (Bora, 2014). (b) Outer part of the solid bar or inner part of the hollow bar could be designed with ribs to reinforce and strengthen the structure (Mansor, Sapuan, Zainudin, Nuraini, & Hambali, 2014).
#40 Composite materials	Change from uniform to composite (multiple) materials	Use hybrid composition where natural fiber is combined with a high-strength synthetic fiber like glass to increase the mechanical properties of the composite materials.

TRIZ has suggested a few possible general solutions to solve the contradiction. Each Inventive Principle is analyzed and the most appropriate general solutions are then selected. After each Inventive Principle has been defined, the selected Inventive Principles that are considered to be the most appropriate solutions are #2 Taking out, #3 Local quality and #40 Composite materials. In Table 2, specific solution strategies are developed from the TRIZ general solutions for adoption in the problem of design and development of a hybrid glass/sugar palm fiber-filled polyurethane composite anti-roll bar.

Based on the analysis of Inventive Principles suggested previously, the lightweight automotive anti-roll bar is improved, taking into consideration a few design modifications. As shown in Table 1, a few anti-roll bar concepts have been generated according to the general solution suggested from the TRIZ Inventive Principles. Selection of a cross section of the anti-roll bar includes the solid round bar and solid ellipse section, hollow round bar and V-section bar. Besides that, changing the anti-roll bar's geometry to non-uniform is also suggested through the above method. Reinforcement of ribs and selection of hybrid bio-composite may also improve the anti-roll bar's design. Different shape and dimension of the anti-roll bar would impact its performance in handling the sway movement of the vehicle. Details of specific solutions for conceptual designs of the hybrid glass/sugar palm fiber-filled polyurethane composite automotive anti-roll bar are illustrated in the morphological chart in Table 2. In this table, a combination of different solutions for each action would demonstrate the potential of the conceptual design of the hybrid glass/sugar palm fiber-filled polyurethane composite automotive anti-roll bar. Using the morphological chart in Table 2, new designs concept were constructed as shown in Figures 2 to 5. According to the conceptual designs that are generated from the morphological chart, different features and design properties are developed from the concepts. Selection of the final conceptual design for the hybrid glass/sugar palm fiber-filled polyurethane composite automotive anti-roll bar requires an adequate approach in order to satisfy the characteristics of the material. Therefore, Analytic Hierarchy Process (AHP) was introduced at this stage in order to determine the suitable conceptual design.

In selecting the final conceptual design for the hybrid glass/sugar palm fiber-filled polyurethane composite automotive anti-roll bar that would satisfy the requirements of the material characteristics, one hierarchy framework should be constructed according to the design specifications. There are three main criteria for the selection, which consist of six sub-criteria for the 40 alternatives of the conceptual design to be selected. As presented in Figure 6, the main goal of this activity is to select the final conceptual design for the hybrid glass/sugar palm fiber-filled polyurethane composite automotive anti-roll bar. The main criterion for the selection is performance, where the anti-roll bar should have good strength and stiffness. Besides that, the size of the anti-roll bar is one of the main criteria, where it should be lighter with appropriate volume. Lastly, the cost for the whole development process is evaluated to select the conceptual design mainly on the cost of raw materials and cost of manufacturing. A lower cost is better.

Next, the evaluation of each criterion was performed on a comparison pairwise basis using Expert Choice 11.5 software. The evaluation in terms of the weight of the concept designs is shown as in Figure 7 as one of the comparison pairwise examples used in selecting the final conceptual design. Finally, the score for each of the conceptual designs was calculated and the ranking was obtained as in Figure 8. Based on the ranking score

as shown in Figure 8, the basic anti-roll bar design was scored the highest, 0.32, followed by the basic anti-roll bar design featuring a rib, which scored 0.31. Later, all the top four conceptual anti-roll bar designs were analyzed in terms of the value of Von-Mises stress. According to the design properties in Table 3, the anti-roll bar conceptual design that featured a V-rib (Figure 3) obtained the lowest Von-Mises stress, 1332037.625 N/m² compared with the other top four conceptual designs. Thus, the anti-roll bar that featured a V-rib for reinforcement was selected as the final conceptual design for the hybrid glass/sugar palm fiber-filled polyurethane composite automotive anti-roll bar. Finally, this design will undergo several modifications for assembly and manufacturing purposes.

Table 2. Morphological chart

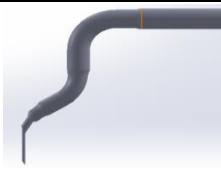
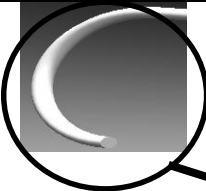
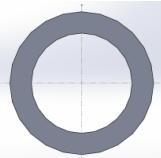
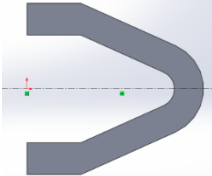
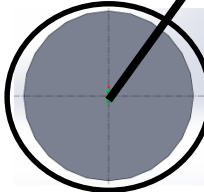
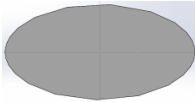
Actions	Solution			
	1	2	3	4
A Critical point that gained the highest stress concentration should be eliminated.				Corner rib
B Numbers of fibers' orientation could be increased for better mechanical properties of the composite materials.	Woven	Uni-directional	Random	Multi-directional
C Cross section of the anti-roll bar could hollow to reduce the weight while maintaining the performance of the component.				
D The bar could be designed with reinforced features to strengthen the structure.	I-rib	V-rib	X-rib	

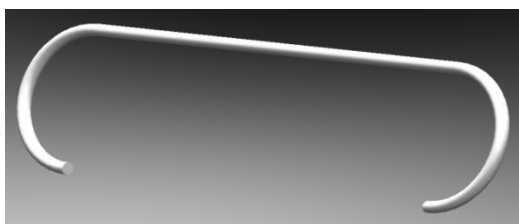

Figure 2. Conceptual design 1 (A3-B4-C3)

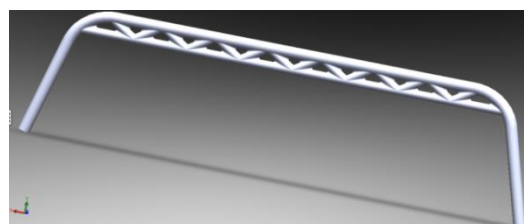

Figure 3. Conceptual design 2 (A1-B3-C3-D2)

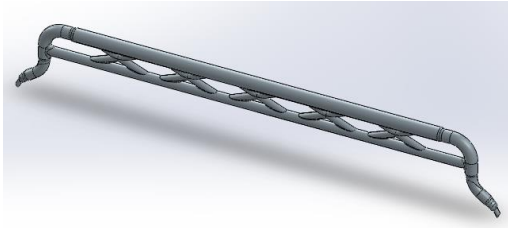

Figure 4. Conceptual design 3 (A2-B2-C3-D3)



Figure 5. Conceptual design 4 (A1-B1-C2)

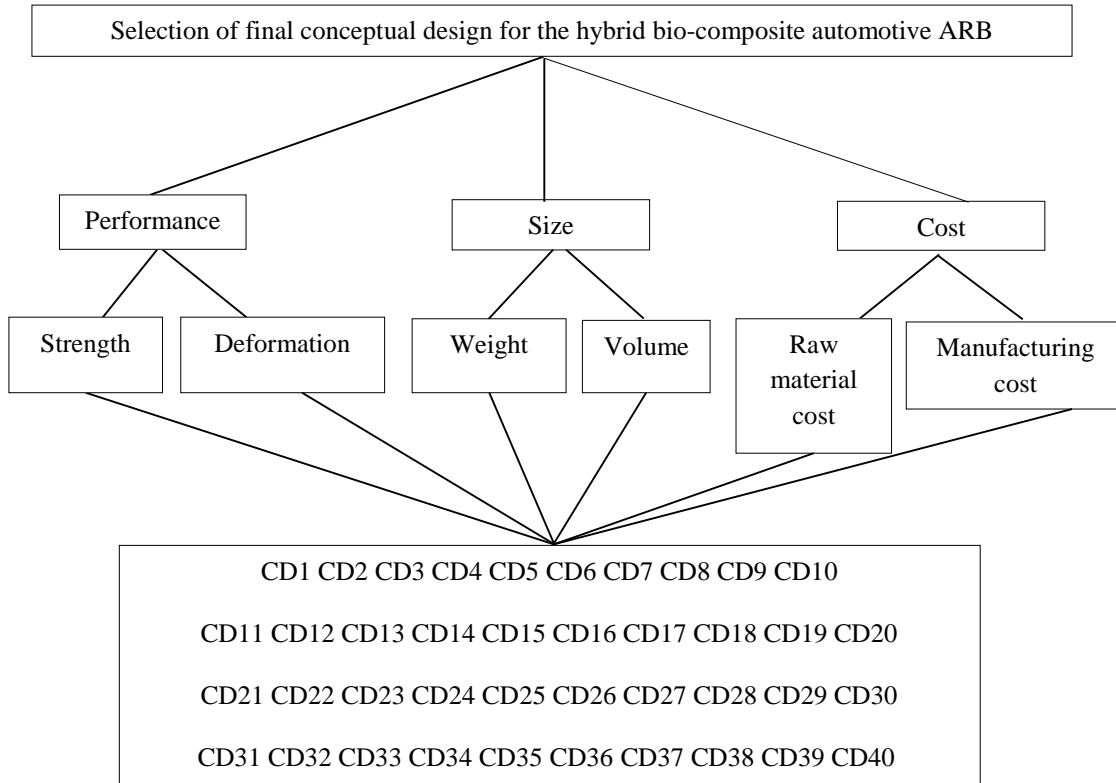

Figure 6. Hierarchy framework for selecting the final conceptual design

Table 3. Design properties of the composite automotive anti-roll bar conceptual designs

CD	Description	*VMS (N/m ²)	Deformation (m)	Weight (g)	Volume (mm ³)	Cost (USD/part)
1	A1-B1-C1	1488125.125	0.00233464	243.18	243181.58	147.76
2	A1-B1-C3	1404133.875	0.00217690	324.24	324242.11	144.50
3	A4-B3-C3	1403001.375	0.00217539	338.74	338736.86	150.00
7	A1-B3-C3-D2	1332037.625	0.00198417	534.48	534482.77	165.99

CD1



Compare the relative importance with respect to: Size \ Weight

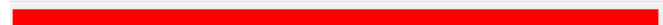

CD2



	CD1	CD2	CD3	CD4	CD5	CD6	CD7	CD8	CD9	CD10	CD11	CD12	CD13	CD14	CD15	CD16	CD17
CD1		1.56	1.33	2.08	1.34	1.38	2.18	1.59	2.6	2.14	2.88	3.31	3.43	3.3	3.28	3.22	
CD2			1.17	1.33	1.17	1.13	1.39	1.02	1.67	1.37	1.85	2.12	2.2	2.11	2.1	2.06	
CD3				1.56	1.0	1.04	1.63	1.19	1.95	1.61	2.16	2.48	2.58	2.48	2.46	2.42	
CD4					1.56	1.51	1.04	1.31	1.25	1.03	1.38	1.59	1.65	1.59	1.57	1.55	
CD5						1.04	1.63	1.19	1.95	1.6	2.16	2.48	2.57	2.47	2.45	2.41	
CD6							1.57	1.15	1.88	1.55	2.09	2.39	2.48	2.39	2.37	2.33	
CD7								1.37	1.2	1.02	1.32	1.52	1.58	1.52	1.51	1.48	
CD8									1.64	1.35	1.82	2.09	2.17	2.08	2.07	2.03	
CD9										1.22	1.11	1.27	1.32	1.27	1.26	1.24	
CD10											1.35	1.55	1.6	1.54	1.53	1.51	
CD11												1.15	1.19	1.15	1.14	1.12	
CD12													1.04	1.0	1.01	1.03	
CD13														1.04	1.05	1.07	
CD14															1.01	1.02	
CD15																1.02	
CD16																	
CD17																	
CD18																	
CD19																	
CD20																	
CD21																	

Figure 7. Comparison on a pairwise basis among the conceptual designs in terms of the weight

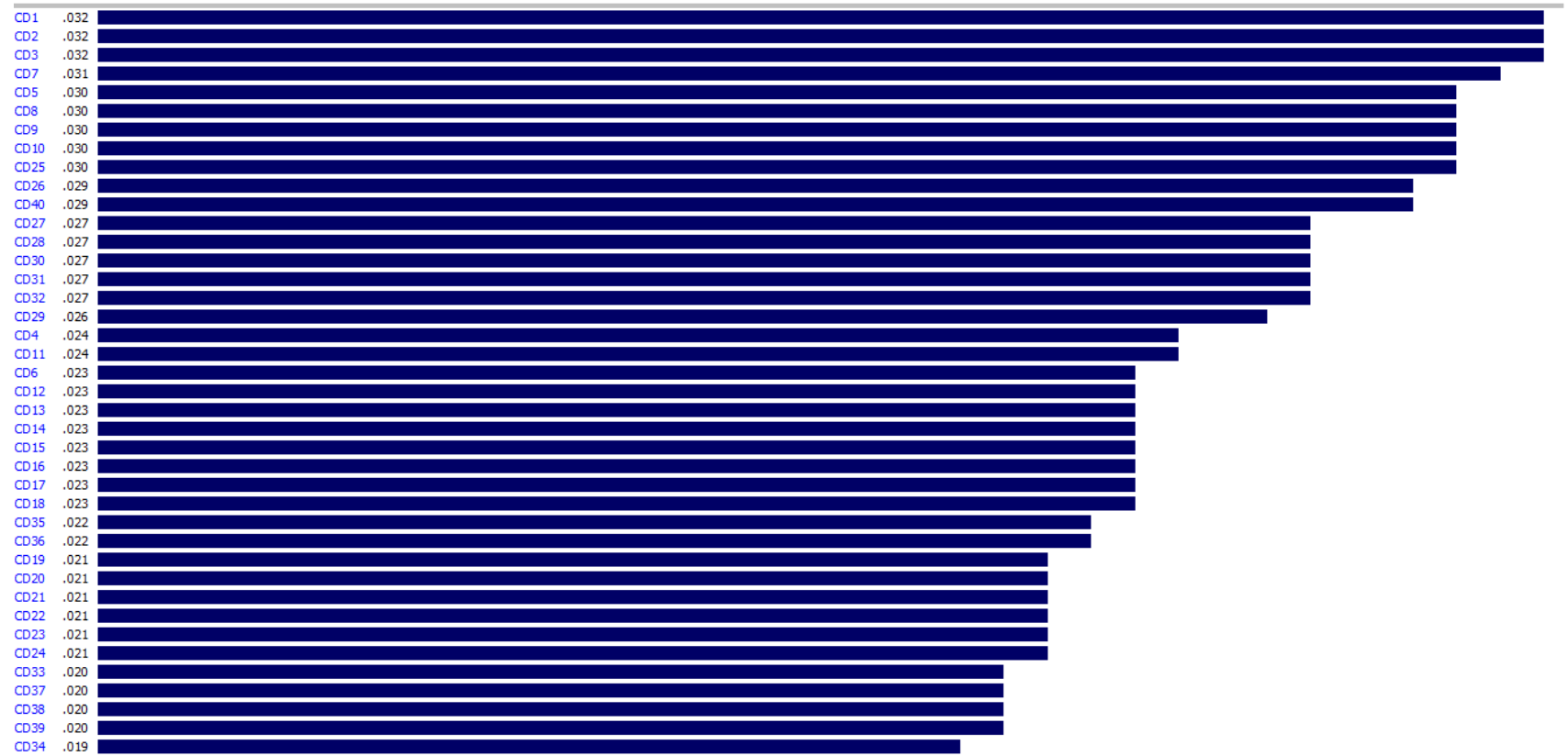

Figure 8. Ranking of the anti-roll bar conceptual designs

4.0 CONCLUSION

In conclusion, sugar palm-based composites are put forward as potential material for automotive components. Due to some issues with the conventional steel automotive anti-roll bar, hybrid bio-composites offer some advantages that may solve the problems related to the development of an anti-roll bar. With the aid of some design tools such as TRIZ, morphological chart and AHP, the whole process of the development has been carried out in a structured and systematic way. TRIZ has solved a problem regarding the geometry determination when the stiffness of the bar should be increased but its diameter would be affected. TRIZ gave specific solutions from its 40 inventive principles.

A morphological chart gathered all the ideas for the concepts according to the specific solutions obtained previously. A combination of all the ideas contributed to the construction of new concept designs to be evaluated to select the best final conceptual design for the hybrid glass/sugar palm fiber-filled polyurethane composite automotive anti-roll bar using AHP. From AHP, the basic anti-roll bar that featured a V-rib for reinforcement purposes was selected as the final conceptual design for the hybrid glass/sugar palm fiber-filled polyurethane composite automotive anti-roll bar. Further study needs to be conducted in order to fit the design to the assembly and manufacturing process.

ACKNOWLEDGEMENT

The authors would like to thank Universiti Putra Malaysia for the financial support provided through the Putra Grant IPB (GP-IPB/2014/9441500) as well as the Universiti Teknikal Malaysia Melaka and Ministry of Education of Malaysia for providing the scholarship award to the principal author to carry out this research project.

REFERENCES

- Bora, P.M. & Sharma, P.K. (2014). Vehicle anti-roll bar analyzed using FEA tool ANSYS. *International Journal of Advanced Technology in Engineering and Science*, 2(7):130–136.
- Doody, M. (2013). *Design and Development of A Composite Automotive Anti-Roll Bar*. (Doctoral dissertation) . Retrieved from Electronic Theses and Dissertations. (Paper 5040).
- Ishak, M.R., Sapuan, S M., Leman, Z., Rahman, M.Z.A., Anwar, U.M.K. & Siregar, J. P. (2013). Sugar palm (*Arenga pinnata*): Its fibres, polymers and composites. *Carbohydrate Polymers*, 91:699–710.
- Leman, Z., Sapuan, S.M., Azwan, M., Ahmad, M.M.H.M. & Maleque, M.A. (2008). The effect of environmental treatments on fiber surface properties and tensile strength of sugar palm fiber-reinforced epoxy composites. *Polymer-Plastics Technology and Engineering*, 47(6):606–612.

- Leman, Z., Sastra, H.Y., Sapuan, S.M., Hamdan, M.M. & Maleque, M.A. (2005). Study on impact properties of *Arenga Pinnata* fibre reinforced epoxy composites. *Journal of Applied Technology*, 3(1):14-19.
- Mansor, M.R., Sapuan, S.M., Zainudin, E.S., Nuraini, A.A. & Hambali, A. (2014). Conceptual design of kenaf fiber polymer composite automotive parking brake lever using integrated TRIZ–Morphological Chart–Analytic Hierarchy Process method. *Materials & Design*, 54:473–482.
- Misri, S., Leman, Z., Sapuan, S.M. & Ishak, M.R. (2010). Mechanical properties and fabrication of small boat using woven glass/sugar palm fibres reinforced unsaturated polyester hybrid composite. *IOP Conference Series: Materials Science and Engineering*, 11(1):1–13.
- Prawoto, Y., Djuansjah, J.R.P., Tawi, K.B. & Fanone, M.M. (2013). Tailoring microstructures: A technical note on an eco-friendly approach to weight reduction through heat treatment. *Materials & Design*, 50:635–645.
- Rantanen, K. & Domb, E. (2014). *Simplified TRIZ: New problem solving applications for engineers and manufacturing professionals*. United Kingdom. Taylor & Francis Group.
- Rill G, (2006) Lecture Notes, Vehicle Dynamics. Retrieved 3rd March 2016 from http://ftp.demec.ufpr.br/disciplinas/EngMec_NOTURNO/TM355/Prof_Jorge_Erthal/Matlab/Dinamica_de_Veiculos/Short_Course_Brasil_2007.pdf
- Sahari, J. (2011). *Physico-chemical and mechanical properties of different morphological parts of sugar palm fibre reinforced polyester composites*. (Masters thesis). Retrieved from University Putra Malaysia Institutional Repository. (ID Code 19718)
- Sahari, J., Sapuan, S.M., Zainudin, E.S. & Maleque, M.A. (2012). Sugar palm tree: a versatile plant and novel source for biofibres, biomatrices, and biocomposites, *Polymers from Renewable Resources*, 3(2):61–77.
- Sahari, J., Sapuan, S.M., Zainudin, E.S. & Maleque, M.A. (2013). Mechanical and thermal properties of environmentally friendly composites derived from sugar palm tree. *Materials & Design*, 49:285–289.
- San, Y.T., Jin, Y.T., & Li, S.C. (2009). *TRIZ: Systematic innovation in manufacturing*. Malaysia: Firstfruits Publishing.
- Sapuan, S.M. & Bachtiar, D. (2012). Mechanical properties of sugar palm fibre reinforced high impact polystyrene composites. *Procedia Chemistry*, 4:101–106.
- Sharma, K., Bora, P. M., & Sharma, P. K. (2012). Hollow cross-section vs. Solid cross-section & increasing the diameter of solid cross-section by using finite element analysis of anti-roll bar. *International Journal of Advanced Research in Science and Engineering*, 1(1):1–11.

Suriani, M.J., Hamdan, M.M., Sastra, H. Y. & Sapuan, S.M. (2007). Study of interfacial adhesion of tensile specimens of Arenga pinnata fiber reinforced composites. *Multidiscipline Modeling in Materials and Structures*, 3(2):213-224.