

DEVELOPMENT OF AN UNMANNED UNDERWATER REMOTELY OPERATED CRAWLER (ROC) FOR MONITORING APPLICATION

M. S. M. Aras^{1*}, Iktisyam Zainal¹, S.S. Abdullah², A.M. Kassim¹ and H.I. Jaafar¹

¹Faculty of Electrical Engineering, Universiti Teknikal Malaysia Melaka, Hang Tuah Jaya, 76100 Durian Tunggal, Melaka, Malaysia,

²Department of Electronic System Engineering, Malaysia-Japan International Institute of Technology, Universiti Teknologi Malaysia KL Campus, Jalan Sultan Yahya Petra, 54100 Kuala Lumpur, Malaysia

ABSTRACT

Underwater vehicles are a type of vehicle that a type of vehicles that able to explore the underwater world. Remotely Operated Crawler (ROC) is one of the Unmanned Underwater Vehicle (UUV) that can be categorized in Remotely Operated Vehicle (ROV) class. The specialty of ROC allows for underwater intervention by staying a direct contact with the seabed. The common issues face for the crawlers are the underwater pressure, maneuverability, power and control. Besides that, the surface of the seabed become one of the problems in that restrict on ROC maneuverability. Designing a ROC that can crawl in any surface conditions is one of the issues emerged in this project. This project is about developing the ROC in order to fulfil a specific mission involving certain tasks. ROC lend themselves to long-term work and offer a very stable platform for manipulating objects and taking measurements better than other ROV. Development the ROC based on wheel mechanism that allows the ROC moves with direct contact with the seabed without any glitch and have an ability to operate in any condition of the underwater environment. The wheel mechanism is adapted based on the tanks which is the chain type wheels. The performance of the ROC will be verified based on experiments conducted on the cluttered condition either on the surface or underwater. The operation of ROC can achieve excellent performance with an unexpected level of environmental condition.

KEYWORDS: *Remotely operated crawler, wheel mechanism, chain type wheels.*

1.0 INTRODUCTION

All the exploration of the oil and gas industries is not concentrated at on the land, but also in the offshore and deep sea as more oil wells found.

Corresponding author e-mail: shahrieel@utem.edu.my

Thus, as offshore explorations have increased the risk taken by human to drill petroleum. There are many cases regarding on the drilling, pipelines, transportation and storage accidents (www.nationalgeographic.com). Even though there are safety measures performed, yet accident can happen anytime without notice. Underwater pipelines have a total length of kilometers. They carry oil, gas, condensate, and their mixtures. Pipelines are among the main factors of environmental risk during offshore oil developments, along with tanker transportation and drilling operation. The causes of pipeline damage can be range from material defects and pipe corrosion to ground erosion, tectonic movements at the bottom of the sea and encountering ship anchors and bottom trawls (www.eia.gov). Statistical data show that the average probability of accidents occurring on the underwater main pipelines of North America and Western Europe is 9.3×10^{-4} and 6.4×10^{-4} , respectively (www.eia.gov), (www.offshore-environment.com), (Hyakudome, 2011). The main causes of these accidents are material and welding defects just like what happened in Russia offshore project Sakhalin-1, in the year of 1994 and cause a huge impact to the arctic ecosystems as the pipeline collapse (Wood et. al, 2013), (Moonesun et. al, 2012), (Welling and Edwards, 2005). Modern technology of pipeline construction and exploitation have been introduced. For example, the usage of ROV and ROC in construction the underwater pipeline connections. Underwater Technology Research Group (UTeRG) from the Faculty of Electrical Engineering, Universiti Teknikal Malaysia Melaka has developed the ROV (Mohd Aras et. al, 2013a), (Mohd Aras et. al, 2013b), (Mohd Aras et. al, 2013c), (Ali et. al, 2013), (Mohd Aras et. al, 2013d). The model of ROV obtained from the system identification technique can be referred to (Mohd Aras et. al, 2013e). This technology eliminates the risk taken by divers to dive into the deep and cold water condition. The ROC used in pipeline inspections and even constructions on the seabed along with other types of ROV and reduce human intervention doing the welding and inspection process. Thus, this kind of incident motivates to study on the ROC design requirement to fulfil underwater inspections based on the project's scope and later there will be innovations in the development of ROC that help to build offshore facilities. One of the ROC design for the task of pipeline construction is the subsea crawler as shown in Figure 1 owned by IHC Marine and Mineral Projects, South Africa. The crawler is owned by Qinetiq North America as shown in Figure 2 which mainly use for Explosive Ordnance Disposal (EOD) Hull inspection. Scopes for this project are limited into few aspects. First, the crawler will have two degrees of freedom (DOF) for the maneuverability. Then, upon completion, the crawler will be tested on the hard surface underwater bed. The motions of the controller will be designed as forward, reverse, left and right movement. The design

specifications are based on the scope drafted which are the operation depth is more or less than 50 meters. The control range of the crawler are strictly depends on the length of the connection cord and the pressure to withstand is about more than 5 bars. The crawler must be water and shock resistance and durability in term of maneuverability and movement, either on the land or underwater.

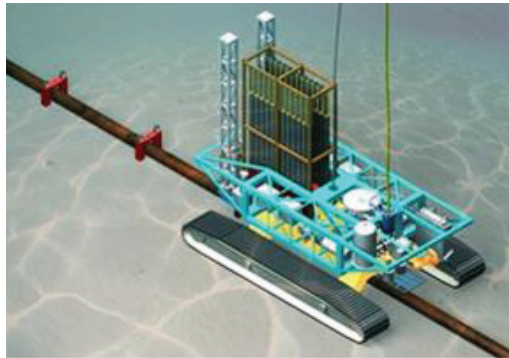

Figure 1. Subsea crawler for oil and gas pipeline constructions. (C.R. Deepak)



Figure 2. Hull Crawler by Qinetiq North America. (Jansen, G.,2013)

2.0 METHODOLOGY

For the development and modelling of unmanned underwater remotely operated crawler (ROC) for monitoring application, it all starts with a project plan. Every detail of the project must be pointed out in term of designs, costs, materials selections, components selections and prototype testing and assembly process. For this project, it is divided into two parts; software and hardware. The first objective which is to design the remotely operated crawler. The design uses the CAD software (Solidwork) and simulations need to be done for different designs and selected with the best design as shown in Figure 3. All

designs have a different chassis design while the wheels, movement mechanisms and controller remain the same. Then, development of the prototype in terms of hardware.

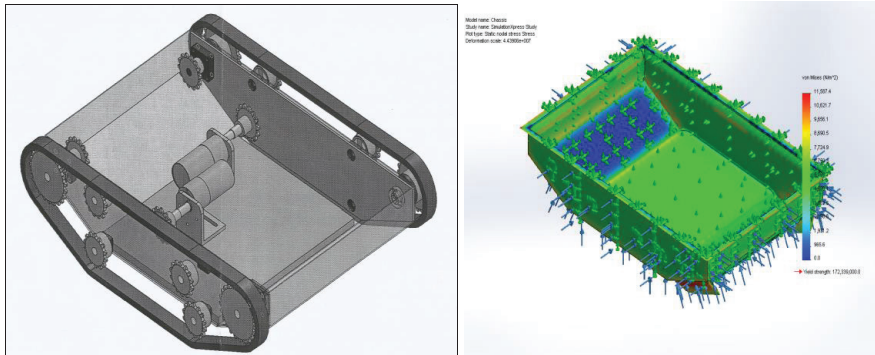

Figure 3. Assembly design of the crawler.

By determining the objectives, research can be done by reviewing journals, conference papers and other research. From the literature review, current problems can be identified and proposed solutions can be made. From the analysis, then came up the solutions which in terms of conceptual design first then goes into detailed designs. The best designs that fulfil every requirement should be chosen to solve current problems. Each design will be simulated in order to identify design's weakness and strength. Then, the development of prototype can be done. The prototype must be tested in the lab and even possible field test. Troubleshooting the prototype will help in determining the error or problems and improves the prototype design. Figure 3 shows the 3D assembly drawing of the crawler using Solidworks. The idea of designing such crawler came out from the mechanism of a tank. With this type of wheels, the crawler can crawl on any surface of the terrain. This will help improving the maneuverability of the crawler. The wheels used sprocket instead of belting and gear. This will reduce the cost in the fabrication process since sprocket is a standard part and available in the market. A little adjustment needed so that the sprocket will fit with the crawler. Figure 4 shows the process flowchart of this project.

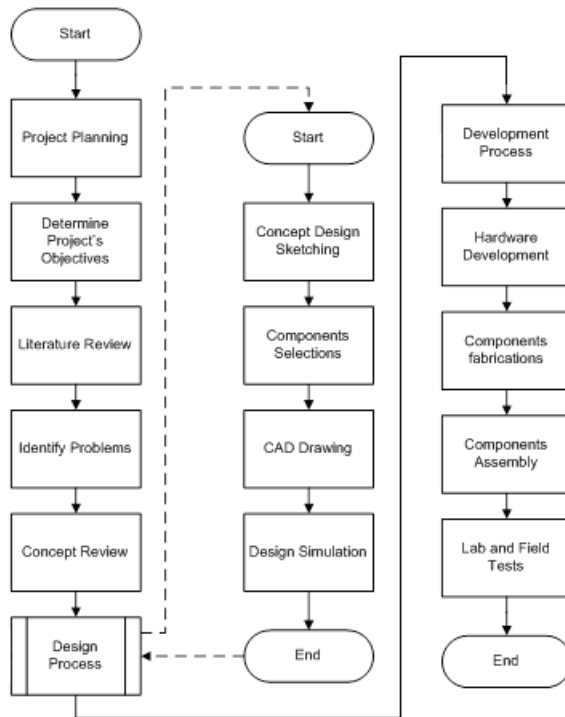

Figure 4. Process flowchart.

3.0 RESULTS AND DISCUSSION

The Remotely Operated Underwater Crawler is an unmanned type vehicle that works underwater seabed. The designs of the crawler are shown in Table 1. All the designs have the same dimensions, type of wheel used, motor, gears configuration and control.

Table 1. The specification of the ROC.

Items	Dimensions
Length	: 450 mm
Height Of The Chassis	: 100 mm
Width	: 297.6 Mm
Height Chassis To The Ground	: \pm 30mm
Type of Wheels	: Track or chain type wheels
Gear Ratio	: 1:1 (Use sprocket and chain)
Motor Type	: DC Geared Motor
Material	: Stainless steel
Weight	: 9.8 kg + 7 kg weighter



Figure 5. The prototype of ROC inside view.

The chassis of the ROC is made of stainless steel as shown in Figure 5. The other components of the ROC are made of steel and also aluminum. The shaft for motors are made of aluminum and the wheels are steel. In order to avoid corrosion, all parts made of steel will be painted later. Inside each sprocket, waterproof bearings are fixed inside the brackets. Brackets will also prevent any water from getting through the chassis as shown in Figure 6.



Figure 6. The brackets hold bearings and waterproofing the chassis.

3.1 The Control Box

The control box is actually a box containing all circuits, battery and PS2 controller as shown in Figure 7 and Figure 8. The box will protect the circuits and other electronics components from shock and provide an exclusive design. The cables for the crawler can be stored inside this box. Control box is placed on the land while the crawler working underwater.



Figure 7. The control box.

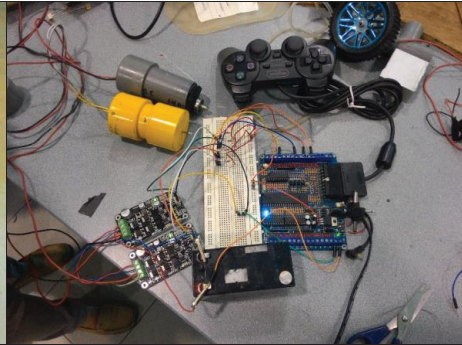

Figure 8. The circuit of the controller.

In this test, the crawler is sealed and all the connections are completely attached. Later, the crawler was dipped into a water tank as in Figure 9. Before any further steps continue, motors are removed and the inside part of the chassis is clean and dry as shown in Figure 9. After a few minutes dipped, the crawler is retrieved back and the chassis is opened. If there is no water or contamination inside the crawler, thus, it is concluded that the crawler is waterproof. The result obtained is, the crawler is waterproof and good to go for underwater operations.

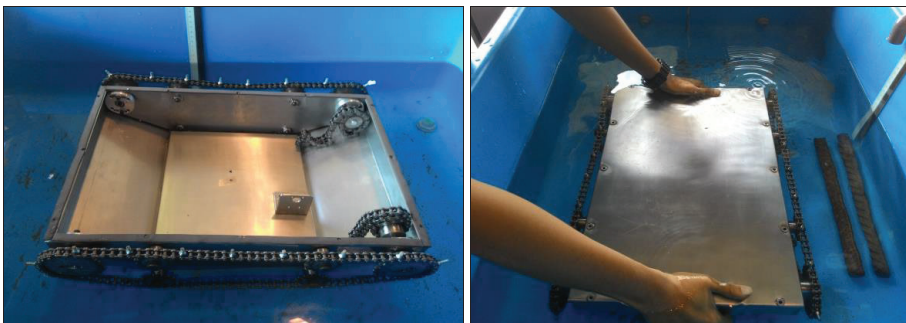

Figure 9. Chassis is submersed to identify any leakage.

The waterproof test is done twice in order to confirm there is no leakage. Since the first test is failed, second test is done. The first test shows a leakage to the body due to improper sealed. The water still can get through the body via the joint of the cover with the chassis. In the second test indicates there is no leakage since more proper sealant is applied.

3.2 Control and Maneuverability Test (Field Test)

This experiment is about testing the ability of the crawler to operate in any terrain. First, the crawler is tested on the land. There are three surfaces that been chosen for the crawler to operate which is on hard surface (cement), dirt and on the grass as shown in Table 2. Time taken for the crawler to complete 3 m distance is recorded as follows:

Table 2. The time taken for the crawler to crawl in a distance of 3 m.

Surfaces	Time Taken (s)					Mean time taken (s)
	Test 1	Test 2	Test 3	Test 4	Test 5	
Cement	56.23	56.35	56.18	56.44	56.87	56.41
Dirt	57.67	57.73	57.46	57.80	58.45	57.82
Grass	59.34	59.56	59.89	60.45	60.13	59.87

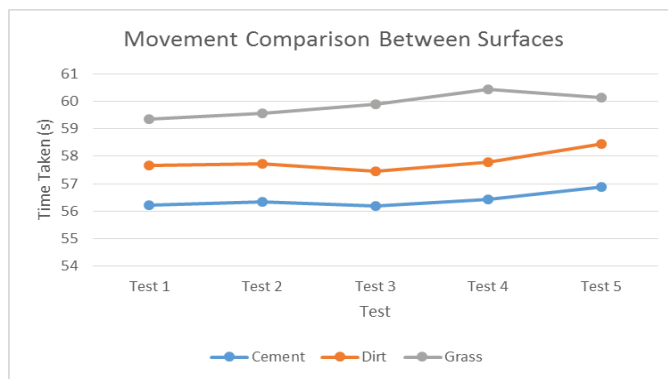

Figure 10. Comparison chart between surfaces against the time taken.

Figure 10 indicates that, the crawler moves slower on the grassy terrain compare to other conditions which is dirt and cemented surfaces. This is because, the crawler exerted more friction on the base of the crawler with the grass. Besides that, grassy surface provides more uneven surface. It is a bumpy ride as we can describe. The cemented surface gives no friction to the base of the crawler. The only frictions come from the wheels spike to the surface. There is a difference in time taken for each test even though tested at the same terrain. This is because other external factor such as, power supplied by the battery is decreasing,

surface interventions and the way the crawler has been controlled. Thus, if this test is done underwater, the time taken will be much higher due to water resistance and the surfaces of the terrain. Obstacles test is done to measure how high and identify the limit of the crawler. The first two tests are carried out on the land and the last test is in the tank filled with water. The time taken for the crawler to climb the obstacles of each height is recorded. Wooden planks are used for this test. Each plank is 0.5 cm thick. The maximum height the crawler can climb is 9.5 cm. The results are as follows in Table 3 and plotted in graph as shown in Figure 11.

Table 3. Table for the crawler to climb the wooden plank.

Test	Height (cm)	Remarks	Time Taken (s)	Descriptions
1	0.5	X	1.35	-
2	1.0	X	2.80	-
3	1.5	X	4.20	-
4	2.0	X	5.43	-
5	2.5	X	6.23	-
6	3.0	X	7.12	-
7	3.5	X	8.34	-
8	4.0	X	9.51	-
9	4.5	X	10.43	-
10	5.0	X	11.35	-
11	5.5	X	13.54	-
12	6.0	X	15.76	-
13	6.5	X	16.48	-
14	7.0	X	18.02	Slightly stuck
15	7.5	X	19.79	Slightly stuck
16	8.0	X	21.78	Slightly stuck
17	8.5	X	23.89	Slightly stuck
18	9.0	X	25.87	Slightly stuck
19	9.5	X	27.78	Stuck but can climb
20	10.0	O	-	The base stuck to the obstacles
21	10.5	O	-	The base stuck to the obstacles

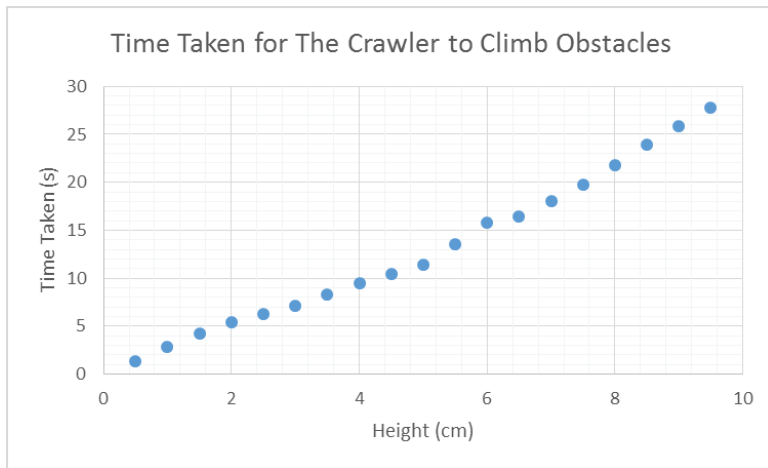

Figure 11. The ability of the crawler to climb chart.

The time taken for the crawler to climb the obstacles of the height of 9.5 is recorded. Wooden platform are used for this test. The results as follows in Table 4.

Table 4. Table for the crawler to crawl over wooden platform.

Test	Height (cm)	Remarks	Time Taken (s)	Descriptions
1	9.5	X	25.28	Able to climb
2	9.5	X	24.79	Able to climb
3	9.5	X	25.44	Able to climb
4	9.5	X	25.56	Able to climb



Figure 12. The crawler climbed the 9.5 cm obstacles.

The crawler can climb up to 9.5 cm obstacles and it is the maximum height it can climb as shown in Figure 12. This is because the bottom base of the crawler stuck to the edge of the obstacles. Spikes on chain help the crawler to have greater tractions and pull the crawler up. This condition can be overcome by having larger sprocket that tied to the chain or weld longer spike to the chain.

3.3 Control and Maneuverability Test (Underwater Field Test)

The first objective is to determine the time taken for the crawler to crawl underwater with the distance covered for 1m. This test is done in water tank with the depth of 0.9m. The following Table 5 is the result for the test. As we can evaluate, the time taken is high for the crawler to crawl and slow. This is because of the design of the wheels which the chain type wheels, weight of the crawler and also resistance as shown in Figure 13.

Table 5. 1m underwater test.

Test	Time Taken (s)
1	16.23
2	16.31
3	16.28
4	16.34
Average	16.29

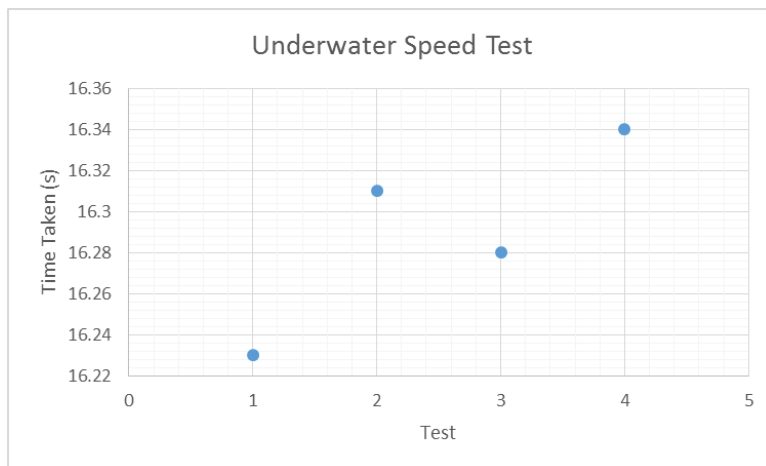

Figure 13. Underwater time result.

The last obstacles test is carried out underwater. Iron column and brick are used for this test. The crawler is submerged and controlled to climb obstacles in the tank which places in a line with the distance of 1m. Time taken for the crawler to climb the obstacles is recorded in Table 6. All the obstacles can be climbed by the crawler. The hardest obstacles for the crawler to climb is the brick. The results as follows:

Table 6. Table for the crawler to crawl over underwater obstacles.

Test	Remarks	Time Taken (s)	Descriptions
1	X	34.67	Able to climb
2	X	42.34	Able to climb
3	X	45.44	Able to climb
4	X	44.65	Able to climb

4.0 CONCLUSIONS

Designing an Unmanned Underwater Vehicle (UUV) gives a lot challenge. The first objective of this project is; to design an unmanned underwater Remotely Operated Crawler (ROC) using CAD. SolidWork is used as the software and platform in designing the crawler. Several simulation test is done using the application available in the software which is the SimulationXpress. Based on the application, the chassis design of the crawler is tested with force of 10N and a pressure of 50000 N/m^2 to imitate the condition of 50m underwater environment and above. The test included the stress, displacement, deformation and factor of safety test. All simulations shows that the design of the chassis plays an important role for the crawler to withstand the underwater environment. As a conclusion, the simulation test help in decision making process. It provide details about the material used, sustainability and simulation when the design is tested in real situation.

Every details must be precise since the ROC will operate underwater. From the design process to fabrication, the ROC is inspected and developed properly. The fabrication process that has been done to develop the ROC are bending, welding and modify the available components to suit the application of the crawler. Sprocket for example is available in the market. But for it can be used in the ROC, some adjustment have been done to them so that it can fit to the shaft that linked with motors. Motors selection also important. The weight of the crawler is determined and suitable motor is chosen. The torque of the motor is 1960 Nm which can carry the weight of the crawler. Waterproofing the crawler also gave a challenge. The body of the crawler is sealed with sealant, chassis is welded perfectly, and components are

designed to fit the chassis so that the body of the ROC is waterproof. This is important to protect motors inside it. The total weight of the crawler once it completed is 9.8 kg.

After the completion of the ROC, analysis the maneuverability of the ROC underwater and on land are tested. Tests are set up to identify the limits and capability of the crawler to operate. In this test, obstacles set up for the ROC to climb. This test is carried out on land and also underwater. The ROC is capable of climbing an obstacles of the maximum height of 9.5 cm. this is because of the design of the chassis and wheels. Other test is carried out is buoyancy test. This test is crucial since crawler need to sink since it will operate on the seabed not floating. From the test, weight of 7kg need to be added to the crawler. Less than 7kg will cause the crawler to have a slightly positive buoyancy. The ROC operates as expected by theory even though there is unexpected problems emerged. One of the problems is the body of the ROC is hollow. Hence, there is air pocket inside it. In theory, 10 kg is quite heavy and the crawler will sink but it won't. Weight need to be added so that the ROC will sink to the bottom. The design of the ROC is based on tank and have a slot modular design. More components can be added and the design can be improvised for future work.

ACKNOWLEDGEMENTS

We wish to express our gratitude to honorable University, Universiti Teknikal Malaysia Melaka (UTeM) especially for Underwater Technology Research Group (UTeRG), Centre of Research and Innovation Management (CRIM) and to the Faculty of Electrical Engineering from UTeM to give the financial as well as moral support for complete this project successfully.

REFERENCES

- Ali, Fara Ashikin and Abdul Azis, Fadilah and Mohd Aras, Mohd Shahrieel and Muhammad Nur , Othman and Shahrum Shah, Abdullah (2013) Design A Magnetic Contactless Thruster of Unmanned Underwater Vehicle. *International Review of Mechanical Engineering*, 7(7). 1413-1420.
- C.R. Deepak, M. A. Shajahan, M. A. Atmanand, K. Annamalai, R. Jeyamani, M. Ravindran, E. Schulte, R. Handschuh, J.Pantheil, H. Grebe, W.Schwarz. Developmental tests on the underwater mining system using flexible riser concept. *ISOPE-OMS-01-MT-02*.
- How much oil is consumed in the United States? (2014, May 13). Retrieved October 29, 2014, from <http://www.eia.gov/tools/faqs/faq.cfm?id=33&t=6>
- Hyakudome, T. (2011). Design of Autonomous Underwater Vehicle. *International Journal of Advanced Robotic Systems*, 8(1), 131-139.
- Jansen, G. (2013). By Land, Sea and Air, Unmanned Vehicles Focus on New Ways to Conduct Pipeline Inspections. *AUVSI*, 14-17.
- M. Moonesun, M. Javadi, P. Charmdooz. (2012, Dec, 5). Evaluation of Submarine Model Test in Towing Tank and Comparison with CFD and Experimental Formulas for Fully Submerged Resistance. *International Conference on Underwater System Technology: Theory and Applications 2012 (USYS'12)*, Shah Alam, Malaysia.
- M Welling, D., & B. Edwards, D. (2005). Multiple Autonomous Underwater Crawler Control for Mine Reacquisition, (*IMECE2005-81716*).
- Mohd Aras, Mohd Shahrieel and Jaafar, Hazriq Izzuan and Anuar , Mohamed Kassim (2013a) Tuning Process Of Single Input Fuzzy Logic Controller Based On Linear Control Surface Approximation Method For Depth Control Of Underwater Remotely Operated Vehicle. *Journal of Engineering and Applied Sciences*, 8(6). 208-214.
- Mohd Aras, Mohd Shahrieel and Abdul Rahman, Ahmad Fadzli Nizam (2013b) Analysis of an Improved Single Input Fuzzy Logic Controller Designed For Depth Control Using Microbox 2000/2000c Interfacing. *International Review of Automatic Control*, 6(6). 728-733.
- Mohd Aras, Mohd Shahrieel and Mohd Shah, Hairol Nizam and Ab Rashid, Mohd Zamzuri (2013c) Robust Control Of Adaptive Single Input Fuzzy Logic Controller For Unmanned Underwater Vehicle. *Journal of Theoretical and Applied Information Technology*, 57 (3). 372-379.
- Mohd Aras, Mohd Shahrieel and Jaafar, Hazriq Izzuan and Razilah , Abdul Rahim and Ahmad , Arfah (2013d) A Comparison Study Between Two Algorithms Particle Swarm Optimization for Depth Control of Underwater Remotely Operated Vehicle. *International Review on Modelling & Simulations*, 6 (5). 1-10.

- Mohd Aras, Mohd Shahrieel and Ab Rashid, Mohd Zamzuri and Azhan , Ab. Rahman (2013e) Development And Modeling Of Unmanned Underwater Remotely Operated Vehicle Using System Identification For Depth Control. *Journal of Theoretical and Applied Information Technology*, 56 (1). 136-145.
- Oil and gas accidents during the offshore exploration and production (Oil and gas accidents during the offshore exploration and production) Retrieved October 29, 2014, from <http://www.offshore-environment.com/accidents.html>
- Short-Term Energy and Winter Fuels Outlook. (2014, October 7). Retrieved October 29, 2014, from http://www.eia.gov/forecasts/steo/report/global_oil.cfm
- Underwater Exploration. Retrieved October 22, 2014, from <http://www.nationalgeographic.com/125/timelines/underwater-exploration/>
- Underwater Exploration - History, Oceanography, Instrumentation, Diving Tools And Techniques, Deep-sea Submersible Vessels, Key Findings In Underwater Exploration - Deep-sea pioneers (- JRank Articles). Retrieved October 22, 2014, from <http://science.jrank.org/pages/7100/Underwater-Exploration.html>
- U.S. Energy Information Administration - EIA - Independent Statistics and Analysis (Short-Term Energy Outlook) Retrieved October 29, 2014, from http://www.eia.gov/forecasts/steo/report/global_oil.cfm
- Wood, S., Harris, W., Ismail, T., Malone, J., Nanney, M., Ojeda, J., Vandedrinck, S. (2013). Hybrid Robot Crawler / Flyer for use in Underwater Archaeology. 1-11.

