

Hybrid Fuzzy-PID Bidirectional Speed Controller for BLDC with Seamless Speed Reversal using Direct Commutation Switching Scheme

Satishrao Pothorajoo and Hamdan Daniyal

Sustainable Energy & Power Electronics Research (SuPER) Cluster, Fakulti Kejuruteraan Elektrik & Elektronik, Universiti Malaysia Pahang, Pahang, Malaysia
satishrao91@gmail.com

Abstract—Brushless Direct Current (BLDC) motors have attracted a lot of attention due to their performance capabilities. The Proportional Integral (PID) controller remained popular due to its simplicity. However, PID's performance deteriorates during nonlinear loads conditions. Controllers have been developed to overcome the limitations of the PID controllers but focused on forwarding motor only. Furthermore, lack of literature regarding the bidirectional speed control of BLDC motor has been reported. In this paper, a Hybrid Fuzzy-PID speed controller for BLDC with seamless speed reversal using direct commutation switching scheme was proposed. The controller uses Fuzzy rule base and the switching scheme for bidirectional operations. MATLAB/Simulink was used to develop and test the controller. The controller was tested for several test cases and compared to a ZN-Tuned PID controller. The controller performed efficiently for all the test cases and has better results compared to the PID controller under same test cases.

Index Terms—BLDC; Speed Controller; Fuzzy-PID; Hybrid; Bidirectional.

I. INTRODUCTION

Brushless Direct Current Motor (BLDC) became a preferable motor in the industry and automation sectors due to low maintenance cost, higher efficiency and high-power density capabilities [1- 3]. An electronic commutation system is used to drive a BLDC motor, where the stator winding is energized in a sequence based on the position of the motor's rotor. This commutation system eliminates the commutator wear problem while reducing the motor losses and maintenance cost [4]. For a sensor-ed BLDC motor, the speed measurements and rotor positions are obtained using three or more hall sensors. Trapezoidal or rectangular voltage coupled with hall sensors drives the BLDC motor [5-8]. In order to ensure a BLDC motor operates at desired direction and speed, a closed loop speed controller is required.

Speed controller techniques such as Proportional (P), Proportional Integral (PI), Proportional Integral Derivative (PID) and fuzzy based techniques were developed over the years to adapt to application needs of BLDC motors [9-11]. Fuzzy based controllers are complex and expensive, this has allowed the PID controller to be preferred [12-14]. However, during nonlinear and uncertainties conditions that occur in the system the PID controller's performance become unstable [10,15-16].

Different types of intelligent control techniques based on fuzzy logic were developed to overcome PID controller's limitations. The author [15], developed Rapid Control for

BLDC motor using Fuzzy while the author [17] developed a controller based on adaptive fuzzy logic scheme to control BLDC motor. Real-time level control using Fuzzy Gain Scheduling of PID controller was contrived by [18] and BLDC motor controller using online fuzzy monitored inference system with coactive neuro-fuzzy was contrived by [19]. In [20], Hybrid Self-Tuned Fuzzy PID was developed. The performance was compared to Self-Tuned Fuzzy PID. The developed controllers in [5, 16-21] were able to surpass the limitation of a PI controller, however, these controllers only focus on motor forwarding mode. The author [22], developed a BLDC motor dsPIC controller that able to operate in four quadrants and in [23] a bidirectional BLDC controller using digital control was developed. However, in both [22-23], the authors are unable to prove and provide an adequate data that the controller was able to operate in reverse motoring mode. Phase lag angle doubles during reversal motoring mode compared to forwarding mode due to position information error was proved in [24]. Therefore, the ideal position of the BLDC motor's rotor during reversal must be determined by the controller [5,22-23, 25].

A Hybrid Fuzzy-PID bidirectional speed controller for BLDC with seamless speed reversal using direct commutation switching scheme was proposed in this paper. By utilizing the Fuzzy PID's fuzzification rules and PID controller, the controller will control the speed based on required speed and directions. Matlab Simulink was used to design and test the system. The proposed controller and Ziegler-Nichols (ZN) Tuned PID Controller was tested with several test cases.

II. BLDC SPEED CONTROLLER

BLDC motor's modelling is similar to a three-phase synchronous motor; however, permanent magnets on the motor's rotor has made some of the dynamic characteristics of the BLDC motor different compared to the synchronous motor [7]. Figure 1 depicts commonly used BLDC Speed Controller. The BLDC motor's mathematical equation can be expressed as follows:

$$\begin{bmatrix} L_a & M_{ab} & M_{ac} \\ M_{ba} & L_b & M_{bc} \\ M_{ca} & M_{cb} & L_c \end{bmatrix} \frac{d}{dt} \begin{bmatrix} i_a \\ i_b \\ i_c \end{bmatrix} = \begin{bmatrix} V_a \\ V_b \\ V_c \end{bmatrix} - \begin{bmatrix} R_a & 0 & 0 \\ 0 & R_b & 0 \\ 0 & 0 & R_c \end{bmatrix} \begin{bmatrix} i_a \\ i_b \\ i_c \end{bmatrix} - \begin{bmatrix} e_a \\ e_b \\ e_c \end{bmatrix} \quad (1)$$

where the phase voltage of the motor is represented by V_a , V_b and V_c while winding resistance of motor's stator is denoted

as R_a, R_b and R_c . Motor's phase current is typified by i_a, i_b and i_c . The $M_{ab}, M_{ac}, M_{ba}, M_{bc}, M_{ca}$ and M_{cb} represents mutual inductances between stator windings. Self-inductance of the motor is typified by L_a, L_b and L_c [21].

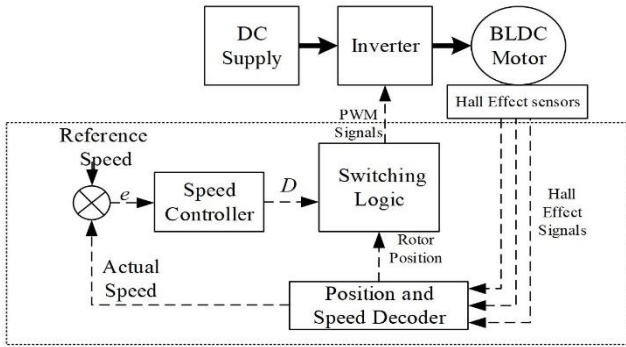

Figure 1: Speed Controller of BLDC Motor

The electro-mechanical torque is represented as

$$T_{em} = J \frac{d\omega_r}{dt} + \beta \omega_r + T_L \quad (2)$$

where J = moment inertia of rotor,
 β = coefficient of friction,
 ω_r = coefficient of angular velocity
 T_L = mechanical load

In order to determine the 3-phase BLDC motor's electromagnetic torque the back-EMF, current and speed of the motor are required. The equation of electro-mechanical torque equation can be also typified as:

$$T_{em} = \frac{1}{\omega_m} (e_a i_a + e_b i_b + e_c i_c) \quad (3)$$

III. PROPOSED CONTROLLER

PID controller is a linear controller and could not perform efficiently during dynamic conditions. To address this problem, a hybrid controller was proposed. Figure 2 shows proposed controller. The controller consists of a fuzzy PID controller and a PID controller. The controller will determine the PWM generator's duty cycle of the based calculated error value $e(t)$ by comparing the actual speed and the desired speed. To compensate for dynamic conditions, the system will select which controller to use based on current error value $e(t)$.

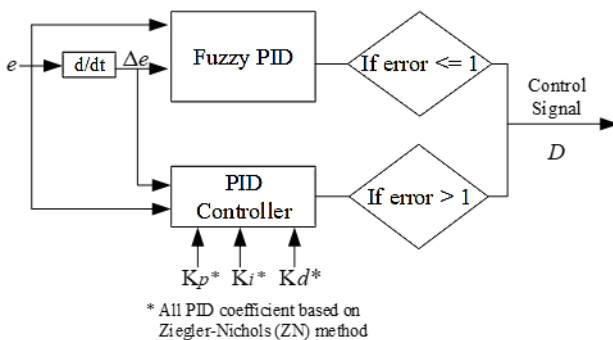

* All PID coefficient based on Ziegler-Nichols (ZN) method

Figure 2: Proposed Controller

PID controller's mathematical equation can be represented as:

$$u(t) = K_p e(t) + K_i \int_0^t e(\tau) d\tau + K_d \frac{\partial e(t)}{\partial t} \quad (4)$$

$$K_p = \Delta K_p + K_p' \quad (5)$$

$$K_i = \Delta K_i + K_i' \quad (6)$$

$$K_d = \Delta K_d + K_d' \quad (7)$$

where K_p proportional gain coefficient, K_i integration time coefficient and K_d derivative time coefficient. Previous sampling time's PID parameters are denoted by K_p', K_i' and K_d' . $\Delta K_p, \Delta K_i$ and ΔK_d are output obtained from the fuzzy. Ziegler-Nichols (ZN) tuning method was used to obtain the PID's coefficients in this paper.

The developed controller uses similar equation as the PID controller to produce the duty cycle to control the PWM generator as shown in Figure 1. The internal structure of the fuzzy for the proposed controller has two inputs and three outputs. The rate of error $\Delta e(k)$ and current error $e(k)$ acts as the inputs and $\Delta K_p, \Delta K_i$ and ΔK_d were the outputs of the fuzzy. Figure 3 represents current error $e(k)$ and rate of error $\Delta e(k)$'s membership functions, where Positive Big (PB), Negative Small (NS), Positive Small (PS), Negative Big (NB), Positive Medium (PM), Zero (ZO), and Negative Medium (NM). Figure 4 represents the membership functions for $\Delta K_p, \Delta K_i$ and ΔK_d . Rule table for Fuzzy PID's membership functions is shown in Table 1. This rule table was used to obtain the 49 set of membership function rules that used in the controller.

The fuzzy PID controller uses the Equation 5-7 and membership functions rules to decide the best value of K_p, K_i and K_d to suit the demand.

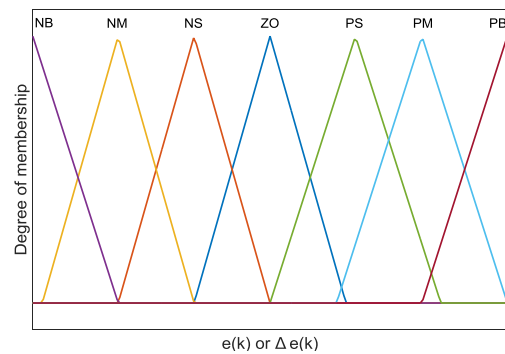

Figure 3: Membership function for $e(k)$ and $\Delta e(k)$

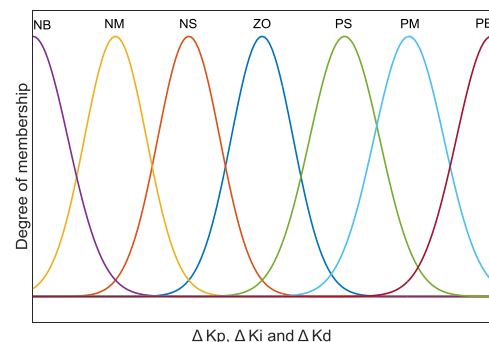

Figure 4: Membership function for $\Delta K_p, \Delta K_i$ and ΔK_d

Table 1
 Fuzzy PID Kp, Ki and Kd Rules

		Error $e(k)$						
		NB	NM	NS	ZO	PS	PM	PB
Change of error $\Delta e(k)$	NB	NB	NM	NB	PB	PB	PM	PB
		PS	PM	PB	NB	NB	NM	ZO
		ZE	PS	PS	NS	ZO	NS	ZO
	NM	PB	NM	NM	PS	PM	NS	PS
		PS	PM	NS	NS	NM	PS	NS
		NS	ZO	NB	NM	ZO	NS	NB
	NS	PB	PM	NS	PS	ZO	PS	NS
NB		NM	PS	NS	ZO	NM	PS	
NM		NB	ZO	NS	PS	NB	ZO	
ZO	PS	PS	PS	ZO	PS	PS	NM	
	NS	NS	NS	ZO	NS	NS	PS	
	NB	NM	NB	ZO	NB	NB	PS	
PS	PS	NS	ZO	NS	PS	NS	NB	
	NS	PS	ZO	PS	NS	PS	PS	
	NB	NS	NS	NS	ZO	ZO	PS	
PM	PM	NS	NS	NS	NM	PM	NB	
	NS	ZO	PS	PM	PS	NM	PB	
	ZO	NM	NS	NS	ZO	ZO	PS	
PB	NS	NS	NS	NS	NB	PB	PB	
	ZO	PS	PS	PS	PS	NS	NB	
	PS	NS	ZO	ZO	ZO	NS	PS	

Figure 5 depicts the Direct Commutation Switching scheme controller. This controller was developed using convoluted mathematical and commutation sequences of a BLDC motor. The BLDC speed controllers under test will be tested using this scheme.

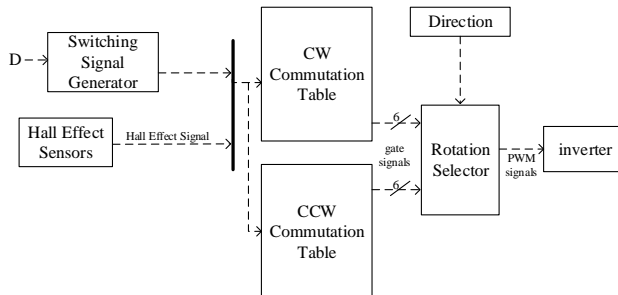

Figure 5: Direct commutation switching scheme controller

IV. SIMULATION RESULTS AND DISCUSSION

The BLDC motor's specification that was used in the Matlab Simulink model is as shown in Table 2. Four test cases were used to test the proposed controller; (1) constant speed during no load condition, (2) constant speed during full load condition, (3) step - changing speed during full load conditions, (4) varying direction during full load conditions. The results of Settling time (T_s), overshoot (M_p), Steady State Error (e_{ss}), and Rise time (T_r) were compared to the ZN-Tuned PID Controller.

A. Constant Speed with No Load Condition

Speed reference of 1500rpm was set for both directions of counterclockwise (CCW) and clockwise (CW). No load was placed during this test case for both directions. The results are depicted in Figure 6 and Figure 7 and for CW direction and CCW direction. Table 3 and 4 show the BLDC motor's feedback for CW and CCW directions respectively. For both the ZN-Tuned PID and Hybrid Fuzzy PID controller, no overshoot was observed during both CW and CCW directions. Comparing both controllers it can be seen that,

despite not having any overshoot the ZN-Tuned PID performed worse compared to the proposed controller. The proposed controller performed faster and has better rise time at 4.8 ms.

 Table 2
 BLDC Motor Specifications

Specifications	Value
Rated voltage (V)	500
Rated current (A)	2.23
Rated speed (rpm)	1500
Stator phase resistance R (Ω)	3
Stator phase inductance L (H)	0.001
Flux linkage (Vs)	0.175
Voltage constant (V/rpm)	0.1466
Torque constant (N m/A)	1.4
Moment of inertia (kg m ² /rad)	0.0008
Friction factor (N m/(rad/s))	0.001
Pole pairs	4

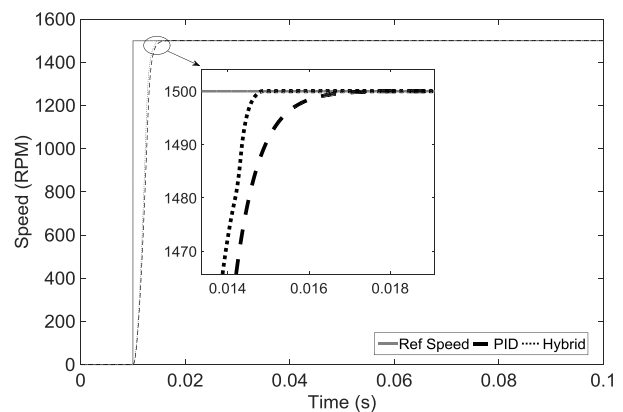

Figure 6: BLDC Motor Feedback during No Load for CW Direction

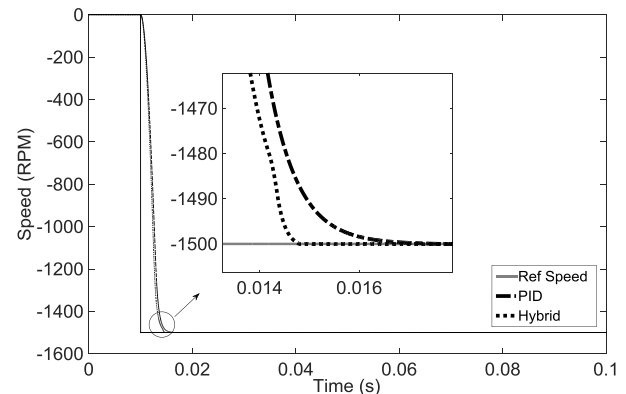

Figure 7: BLDC Motor Feedback during No Load for CCW Direction

 Table 3
 BLDC Motor Feedback for CW during No Load

Techniques	T_r (ms)	M_p (%)	T_s (ms)	e_{ss} (%)
ZN-Tuned PID	7.70	-	7.70	0.00123
Hybrid Fuzzy PID	4.80	-	4.80	0.00059

Table 4
BLDC Motor Feedback for CCW during No Load

Techniques	T_r (ms)	M_p (%)	T_s (ms)	e_{ss} (%)
ZN-Tuned PID	7.70	-	7.70	0.00123
Hybrid Fuzzy PID	4.80	-	4.80	0.00059

B. Constant Speed During Full Load Condition

The BLDC motor feedback for a full load of 3 Nm during CW and CCW directions were represented by Figure 8 and Figure 9 subsequently. The data was tabulated in Table 5 and 6 respectively. For both directions, the Hybrid Fuzzy PID has the fastest rise time of 5.2 ms and smallest e_{ss} of 0.0073 %.

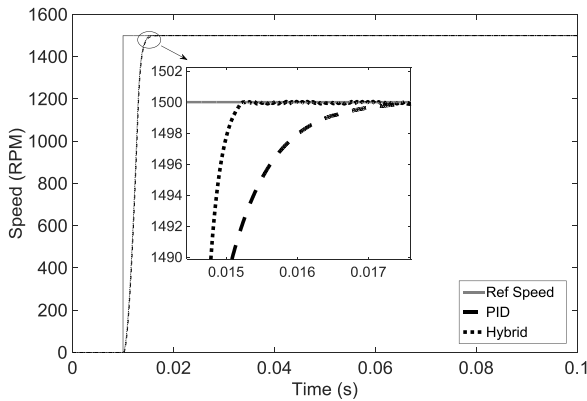

Figure 8: BLDC Motor Feedback during CW Direction for Full Load

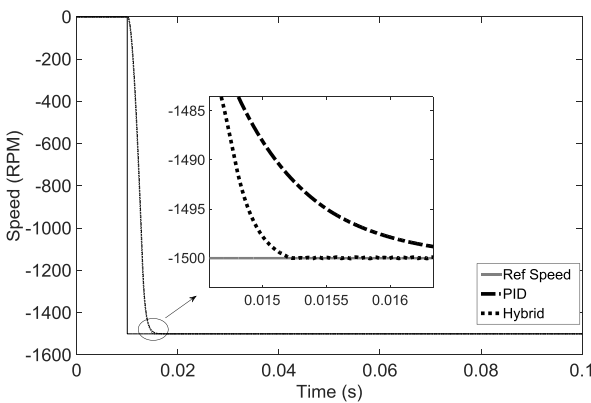

Figure 9: BLDC Motor Feedback during CCW Direction for Full Load

Table 5
BLDC Motor Feedback for CW during Full Load

Techniques	T_r (ms)	M_p (%)	T_s (ms)	e_{ss} (%)
ZN-Tuned PID	8.50	-	8.50	0.01041
Hybrid Fuzzy PID	5.20	-	5.30	0.00730

Table 6
BLDC Motor Feedback for CCW during Full Load

Techniques	T_r (ms)	M_p (%)	T_s (ms)	e_{ss} (%)
ZN-Tuned PID	8.50	-	8.50	0.01040
Hybrid Fuzzy PID	5.20	-	5.30	0.00730

C. Step-changing Speed During Full Load Conditions

Figure 10 shows the BLDC motor's full load of 3 Nm step-changing speed response at $t = 0.05$ s and the motor response was tabulated in Table 7. No overshoot was observed for both controllers as the speed increased from 1500 rpm to 2000 rpm. With both rise time and settling time during the speed increase at 5 ms shows the Hybrid Fuzzy PID has superior performance than the PID controller. Steady state error (e_{ss}) has increased for both controllers, however, the values were under accepted value during the speed change for both controllers.

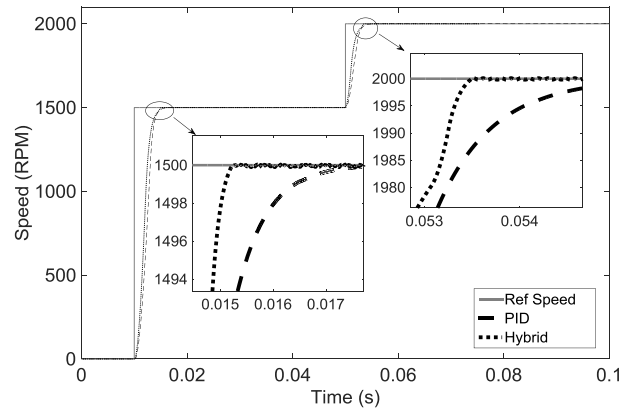

Figure 10: BLDC motor Feedback during CW Direction for Full Load

Table 7
BLDC Motor Feedback for the Step-Changing Speed

Techniques	Step change T_r (ms)	Step change T_s (ms)	Before Speed Change e_{ss} (%)	After Speed Change e_{ss} (%)
ZN-Tuned PID	6.70	6.90	0.0104	0.0135
Hybrid Fuzzy PID	5.00	5.00	0.0073	0.0110

D. Varying Direction During Full Load Conditions

The BLDC motor feedback for varying direction during full load conditions represented by Figure 11 for both controllers under test. Both controllers were able to accommodate the speed and direction changes. The Hybrid PID controller has the shortest settling time of 6.9 ms. However, e_{ss} of Hybrid Fuzzy PID increases as the direction changes but the ZN-Tuned PID's e_{ss} reduces as the direction changes.

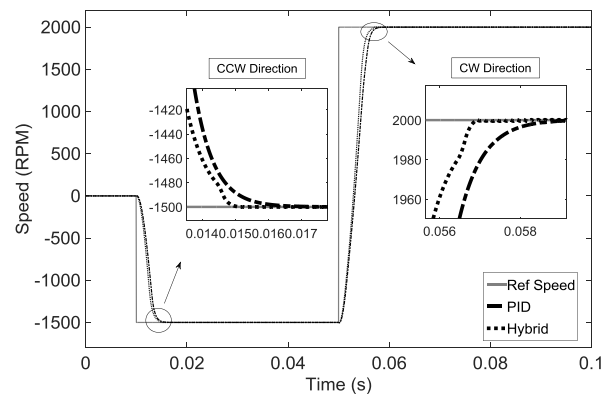

Figure 11: BLDC Motor Feedback during Full Load for both directions

Table 8
BLDC Motor Feedback in Varying Direction for Full Load

Techniques	CW	CW	CCW	CW
	T_r (ms)	T_s (ms)	e_{ss} (%)	e_{ss} (%)
ZN-Tuned PID	9.7	9.7	0.0104	0.0054
Hybrid Fuzzy PID	6.9	6.9	0.0111	0.0112

V. CONCLUSION

In this study, a Hybrid Fuzzy-PID Bidirectional Speed Controller for BLDC with Seamless Speed Reversal using Direct Commutation Switching Scheme was proposed. For all test cases, the proposed controller was able to achieve better results than the PID controller. The Hybrid controller's steady state error was slightly higher compared to its counterpart during full load direction change. Despite having a slightly higher steady-state error, the error was within acceptable region. Hence a BLDC motor can be driven bidirectionally using this controller.

ACKNOWLEDGMENT

This work is supported by Sustainable Energy & Power Electronics Research Lab, Fakulti Kejuruteraan Elektrik & Elektronik, Universiti Malaysia Pahang under research grant MOHE FRGS RDU160137, UMP GRS and UMP PGRS.

REFERENCES

- [1] C. Concari and F. Troni, "Sensorless control of BLDC motors at low speed based on differential BEMF measurement," in *Energy Conversion Congress and Exposition (ECCE)*, 2010 IEEE, 2010, pp. 1772–1777.
- [2] I. F. Davoudkhani and M. Akbari, "Adaptive speed control of brushless DC (BLDC) motor based on interval type-2 fuzzy logic," *2016 24th Iranian Conference on Electrical Engineering (ICEE)*, pp. 1119–1124, 2016.
- [3] G. H. Jang, J. H. Park, and J. H. Chang, "Position detection and start-up algorithm of a rotor in a sensorless BLDC motor utilising inductance variation," *IEE Proceedings-Electric Power Appl.*, vol. 149, no. 2, pp. 137–142, 2002.
- [4] S. Zhang and Y. Wang, "The simulation of BLDC motor speed control based-optimized fuzzy PID algorithm," in *Mechatronics and Automation (ICMA)*, 2016 IEEE International Conference on, 2016, pp. 287–292.
- [5] J. V. Vikkaraga, "Fuzzy based digital Control Strategy for Four Quadrant, 3 Phase BLDC Motor with speed stability," *Int. J. Eng. Dev. Res.*, vol. 2, no. 2, pp. 1437–1440, 2014.
- [6] M. A. Sathar, "Fuzzy PID Controller for Four Quadrant Operation of BLDC Motor."
- [7] D. C. Hanselman, *Brushless permanent magnet motor design*. The Writers' Collective, 2003.
- [8] M. A. M. Azmi, H. Daniyal, and M. S. Bakar, "Three-phase variable speed drive using ARM Cortex-M3," 2014.
- [9] J. Carvajal, G. Chen, and H. Ogmen, "Fuzzy PID controller: Design, performance evaluation, and stability analysis," *Inf. Sci. (Ny)*, vol. 123, no. 3, pp. 249–270, 2000.
- [10] P. S. Londhe, B. M. Patre, and A. P. Tiwari, "Fuzzy-like PD controller for spatial control of advanced heavy water reactor," *Nucl. Eng. Des.*, vol. 274, pp. 77–89, 2014.
- [11] A. Rubaai, M. J. Castro-Sitiriche, and A. R. Ofoli, "Design and implementation of parallel fuzzy PID controller for high-performance brushless motor drives: an integrated environment for rapid control prototyping," *IEEE Trans. Ind. Appl.*, vol. 44, no. 4, pp. 1090–1098, 2008.
- [12] K. Premkumar and B. V. Manikandan, "Bat algorithm optimized fuzzy PD based speed controller for brushless direct current motor," *Eng. Sci. Technol. an Int. J.*, 2015.
- [13] C. Navaneethakkannan and M. Sudha, "An Adaptive Sliding Surface Slope Adjustment in Sliding Mode Fuzzy Control Techniques for Brushless DC Motor Drives," *Int. J. Comput. Appl.*, vol. 54, no. 2, 2012.
- [14] M. Najeeb, M. Shahooth, A. Mohaisen, R. B. Razali, and H. B. Daniyal, "An optimized PID parameters for LFC in interconnected power systems using MSL optimization algorithm," *ARPN J. Eng. Appl. Sci.*, vol. 11, no. 19, pp. 11770–11781, 2016.
- [15] R. N. Tuncay, Z. Erenay, M. Yilmaz, and O. Ustun, "Rapid control prototyping approach to fuzzy speed control of brushless DC motor," in *Proc. Int. Conf. on Electrical and Electronics Engineering-ELECO*, 2003, vol. 3.
- [16] S. Pothorajoo and H. Daniyal, "PID bidirectional speed controller for BLDC with seamless speed reversal using Direct Commutation Switching Scheme," in *Control and System Graduate Research Colloquium (ICSGRC)*, 2017 IEEE 8th, 2017, pp. 7–12.
- [17] K. Premkumar and B. V. Manikandan, "Adaptive fuzzy logic speed controller for brushless DC motor," *Power, Energy and Control (ICPEC)*, 2013 International Conference on, pp. 290–295, 2013.
- [18] A. M. O. Fini, M. B. Gogani, and M. Pourgholi, "Fuzzy gain scheduling of PID controller implemented on real time level control," in *Fuzzy and Intelligent Systems (CFIS)*, 2015 4th Iranian Joint Congress on, 2015, pp. 1–5.
- [19] M. J. Prabu, P. Poongodi, and K. Premkumar, "Fuzzy supervised online coactive neuro-fuzzy inference system-based rotor position control of brushless DC motor," *IET Power Electronics*, vol. 9, no. 11, pp. 2229–2239, 2016.
- [20] A. Ramya, A. Imthiaz, and M. Balaji, "Hybrid Self Tuned Fuzzy PID controller for speed control of Brushless DC Motor," *Automatika*, vol. 57, no. 3, pp. 672–679, 2016.
- [21] K. Premkumar and B. V. Manikandan, "Adaptive Neuro-Fuzzy Inference System based speed controller for brushless DC motor," *Neurocomputing*, vol. 138, pp. 260–270, 2014.
- [22] C. S. Joice, S. R. Paranjothi, and J. S. Kumar, "Practical implementation of four quadrant operation of three phase Brushless DC motor using dsPIC," in *2011 International Conference on Recent Advancements in Electrical, Electronics and Control Engineering, IConRAEeCE'11 - Proceedings*, 2011, pp. 91–94.
- [23] C. S. Joice, S. R. Paranjothi, and V. J. S. Kumar, "Digital control strategy for four quadrant operation of three phase BLDC motor with load variations," *IEEE Trans. Ind. Informatics*, vol. 9, no. 2, pp. 974–982, 2013.
- [24] S.-I. Park, T.-S. Kim, S.-C. Ahn, and D.-S. Hyun, "An improved current control method for torque improvement of high-speed BLDC motor," in *Applied Power Electronics Conference and Exposition, 2003. APEC'03. Eighteenth Annual IEEE*, 2003, vol. 1, pp. 294–299.
- [25] U. Vinatha, S. Pola, and K. P. Vittal, "Simulation of four quadrant operation & speed control of BLDC MOTOR on MATLAB / SIMULINK," in *IEEE Region 10 Annual International Conference, ProceedingsTENCON*, 2008.