

A Cascadable Microcontroller-based Data Acquisition Module for Environmental Data Monitoring with RF and GSM Communication Links for Data Relay

C. Llorente

Department of Electronics and Communications Engineering, De La Salle University, Manila, Philippines
cesar.llorente@dlsu.edu.ph

Abstract—High air and water quality is crucial to life. Maintaining it to ensure a sustainable environment for future generations require constant measurement and monitoring of pertinent environmental parameters to detect degradation. Gathering these data require physical presence in the locality where such measurements are to be made, posing a physical danger to the individual carrying out such task. Technology that performs measurements of environmental data and can transmit these data over radio frequency (RF) communication links are in existence but are hampered by limited range. Data can only be transmitted from the place data is gathered to a location where data can be stored and processed. Moreover, the range is further limited by adverse weather condition such as heavy rains. In this study, a cascadable data acquisition module for gathering environmental parameters such as temperature, humidity and pressure is developed. The RF link is designed to relay information from a data acquisition node to another node until it reaches an end node that is under Global System for Mobile Communications (GSM) service coverage. The end node transmits the data collected by all the nodes in the link to a base station via SMS. The link is composed of three data acquisition nodes and the base station which comprises a laptop computer equipped with a GSM modem. Each node is equipped with Radio Frequency transceivers to relay data gathered from one node to the next node. The end node is equipped with a GSM modem so that data can be sent to the base station in text message format via SMS. Results indicated that under normal conditions, the distance between nodes can reach up to 1200 meters but can shorten down to 600 meters under heavy rain conditions

Index Terms—Data Relay; GSM SMS; Multi-Node Environmental Data Acquisition; RF Link.

I. INTRODUCTION

High level of environmental quality which includes water and air quality is crucial to life and to ensure a sustainable environment for future generations. Measuring these environmental parameters is important to determine the level of quality and degradation.

Human activity and global climate change can bring about changes in the quality of these environmental parameters. Literatures show the effect of climate change to air particulates [1], forest covers [2], agricultural adaptation [3] and [4], level in watershed and wetlands hydrology [5]. Monitoring environmental parameters pertaining to water and air quality can establish baseline information order to

determine any degradation in the environment. This information can be used for policy adoption or stricter implementation of environmental laws and policies.

Gathering of environmental parameters requires onsite measurements which pose risks to the person doing the measurements. Technology can be leveraged to carry out this task effectively and reliably. Many works pertaining to water quality monitoring have been reported in the literature. In [6], water quality is monitored through wireless links. The system is able to monitor the temperature and pH of the water in an artificial lake. Water quality can be monitored and controlled based on desired levels. The work of [7] uses a wireless link to transmit water quality data measured from an aqua farm. A computer processes the data and makes a decision for control action which is sent to wirelessly to affect the control to water parameters in the aqua farm. The work of [8] is similar but it integrated a way to synchronize transmission nodes which provided savings in power consumption. Wireless sensor technology was also applied to monitor environmental parameters [9] and [10], and in precision agriculture applications by [11]. Detailed analysis of the characteristics and performance of wireless sensor networks (WSNs) have been reported in [12]-[16].

RF links have limited range. This range can be further reduced under severe weather conditions such as heavy rain. A study proposed by [17] used RF links transmit data from one node to the next node to extend the effective range of the system. However, data need to be downloaded from one of the end nodes. A Global System for Mobile Communications (GSM) has been available and used by companies for their communication requirements simply because it offers good communication capability. GSM has been proven in terms of low-volume data transfer and universal deployment [18]. However, one of its disadvantages is that certain areas, especially in far remote location, may not be under a GSM service coverage area. Because of this, integrating RF links can provide means of data transfer in locations not covered under GSM-SMS service and to take advantage of the GSM-SMS service to transfer data within the service coverage area.

This paper presents a microcontroller-based data acquisition system for gathering environmental data RF links and GSM-SMS service. Environmental data such as temperature, humidity and pressure are gathered at various points within the operating range of the RF links. Gathered data are transmitted from node to node through this RF links

and transmitted to a database computer through the GSM-SMS service.

II. SYSTEM DESIGN

The Monitoring System using Node to Node Radio Frequency Link is designed to relay information from one station to another. Each node has its own function such as processing and storage that is available to other nodes. Two sections make up the whole system distributing an equal amount of work load to each station, thus optimizing the full performance of the system. There are three transceivers serving as input modules, and a database where all the received information is compiled, stored and displayed for the user.

The system set-up is shown in Figure 1 where three nodes, each comprising of three sensor inputs, an RF link are placed at some distance apart. Nodes 2 and 3 will be placed in an area without network coverage while node 1 will be the only node that will be put in an area with network coverage to have a GSM access. Node 1 will serve as a transfer point of data to a database to check the reliability of the transmitted data.

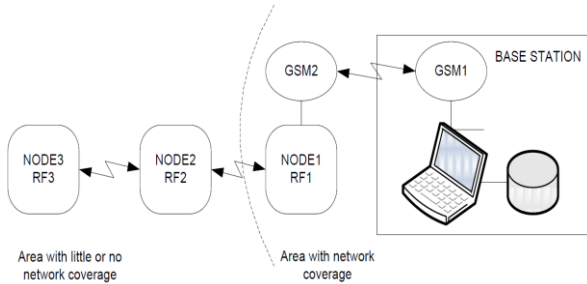

Figure 1: System Block Diagram of the cascable RF links.

A. Data Acquisition Node

The system is composed of data acquisition nodes with RF links to receive and transmit data from or to adjacent nodes that are within range of data transmission. Each node can gather environmental data depending on the sensors that are attached suitable to a given application. For water quality monitoring application, for example, the attached sensors may be composed of water level sensor, flow rate sensor, turbidity sensor, conductivity sensor and temperature sensor. Figure 2 shows an acquisition node with sensors attached for measuring temperature, humidity and pressure. The RF transceiver allows reception and transmission of data to adjacent nodes.

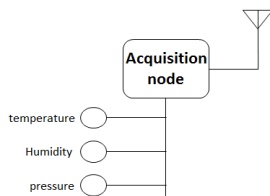

Figure 2: Data Acquisition node with RF link for data reception and transmission.

B. Cascading Data Acquisition Nodes

Several Data Acquisition Nodes can be deployed that will allow acquisition of environmental data over an area or over

a length of a river for water quality monitoring or along a highway to monitor air quality. These nodes are deployed in areas with no GSM coverage. By cascading many acquisition nodes, environmental parameters such as the water/air quality of the entire length of a river/highway can be monitored. This arrangement is illustrated in Figure 3. The leftmost node in the figure is deployed at the farthest end of the river/highway. Another node is installed at the point within the range of the RF transceiver. Additional nodes can be deployed until the desired length is covered and the last node is already under the GSM service coverage. Similar deployment arrangement can be used in an application involving monitoring a body of water such as a lake or a shoreline where discharges from factories of human habitations may impact water/air quality and need to be monitored.

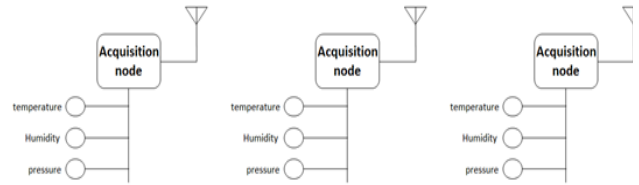

Figure 3: Cascading multiple nodes to gather environmental data over an extended area or a stretch of water line.

C. Data Acquisition Node under GSM Network Coverage

The node at the end of the cascade under the GSM coverage is the same with all the nodes in the cascade. The only difference is that a GSM modem is connected to it through one of its RS232C serial interface. This is illustrated in Figure 4.

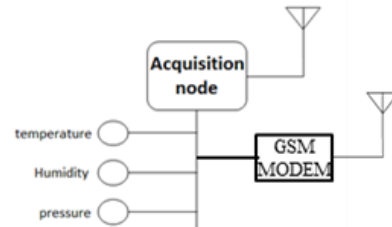

Figure 4: Acquisition Node with GSM modem

D. Base Station

The base station is composed of a computer that runs application software for receiving data sent via SMS and storing it for display and further processing and a GSM modem attached to one of its serial COM ports. Figure 5 illustrates this setup.



Figure 5: Base station setup.

III. HARDWARE DESIGN

Figure 6 shows the block diagram of an acquisition node. It shows the microcontroller connected to the RF transceiver and the GSM modem through the two UARTs UART 0 and UART 1. Also, indicated in the figure is the sensor module that is connected to the analog channels of the Z8 microcontroller.

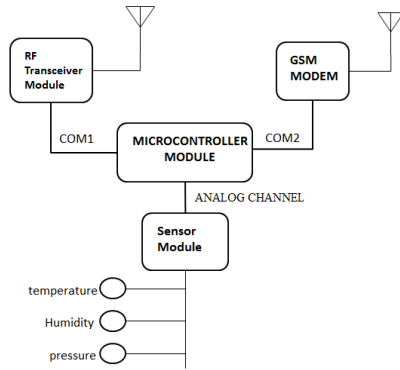

Figure 6: Acquisition Node with GSM Modem Block Diagram

A. Microcontroller Module

The microcontroller module used in the Data Acquisition Node is based on the Z8 Encore! XP Z8F64xx Development Board. Its 10-bit Analog to Digital Converter, which can digitize one among the 12 analog inputs, is sufficient. The microcontroller has two UARTs where the AC4790 RF module can be connected to the Z8 UART 0 (COM1) while the GSM module can be connected to the microcontroller via UART1 (COM2). This is shown in Figure 6.

B. Sensor Module

The sensor module is composed of the signal conditioning circuit and the three sensors, namely temperature, humidity, and pressure sensors. Temperature and humidity sensors outputs are conditioned to satisfy the dynamic range of the Z8 ADC. Outputs of the temperature and humidity sensors are connected to analog channels AN0 and AN1 respectively. For the pressure sensor, it is interfaced to an Arduino board where the conversion process is performed by the Arduino controller and the voltage equivalent of the pressure is presented as a voltage output of a DAC in the Arduino board. This DAC output drives the AN2 input channel of the Z8 microcontroller.

C. Graphical User Interface

The Graphical User Interface in the Base Station computer was developed using Visual Basic Studio 2005 in C language environment. The GUI allows the user to view the status of the system by connecting to the serial port where the GSM device is located. The default bit rate was set to be 57600 bps to connect to the GSM device. Once connected, the GSM is required to be initialized by clicking the initialize GSM button to perform its basic functions such as sending and reading SMS. The GUI handles the sending of requests and displaying of received data. The GUI displays the node numbers with their corresponding readings of the temperature, humidity and pressure sensors attached to the specified nodes. Figure 7 shows the GUI when the GSM modem is being initialized. The communication port where the GSM modem is connected to the data base computer is

set in this GUI as well as the SIM card number of the modem connected to the microcontroller module.

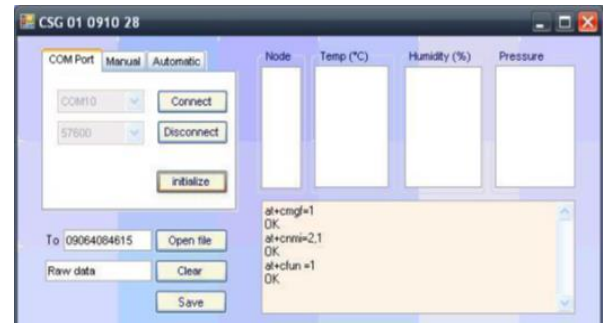

Figure 7: Initializing the GSM Modem

Once the communication link is set, data acquisition can be carried out. This is done by clicking on the Request button. The interaction is shown in Figure 8.

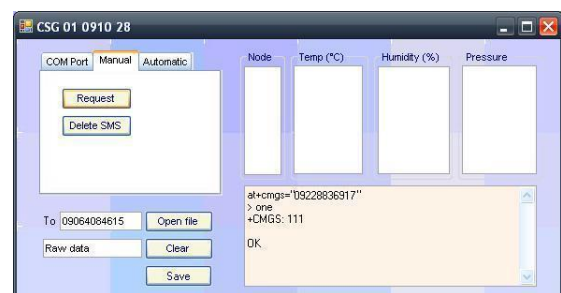

Figure 8: Sending Request

Once data is received, parameter values are displayed. The data can be then saved on a file in the database computer. The GUI is shown in Figure 9.



Figure 9: Receiving and Auto-saving Data

IV. DATA AND RESULTS

A. Sensor Measurements

Table 1 shows the accuracy of the measurements made in the three nodes for three sensors. For the temperature sensor, sensor readings are compared with the measured temperature using a thermometer placed near the sensor. Thermometer readings are considered as the standard and the error is computed. For Humidity, each humidity sensor has its corresponding dew point temperature. The accuracy is determined by comparing the measured relative humidity to the computed relative humidity. To test the accuracy of the pressure sensor, the measured pressure is compared to the computed values in the Standard Atmosphere Table computed according to the 1959 ARDC standard atmosphere model.

Table 1
Accuracy of Sensors

Node	Temperature	% Average Error	
		Humidity	Pressure
1	0.78	4.85	0.60
2	1.33	6.97	0.90
3	1.00	2.30	0.71

B. Range Test under Good Weather Condition

Table 2 lists down the results of the test to determine the distance between two adjacent nodes for a successful data transmission. Successful transmission is accomplished with distances between the nodes of 1200 meters.

C. Range Test under Bad Weather Condition

Table 3 lists down the results of the test to determine the distance between two adjacent nodes for a successful data transmission. Successful transmission is accomplished with distances between the nodes of 600 meters.

Table 2
Range Test under Good Weather Condition

Distance (Meters)	TRIAL1	TRIAL2	TRIAL3	TRIAL4	TRIAL5
20	OK	OK	OK	OK	OK
50	OK	OK	OK	OK	OK
100	OK	OK	OK	OK	OK
200	OK	OK	OK	OK	OK
300	OK	OK	OK	OK	OK
400	OK	OK	OK	OK	OK
500	OK	OK	OK	OK	OK
600	OK	OK	OK	OK	OK
700	OK	OK	OK	OK	OK
800	OK	OK	OK	OK	OK
900	OK	OK	OK	OK	OK
1000	OK	OK	OK	OK	OK
1100	OK	OK	OK	OK	OK
1200	OK	OK	OK	OK	OK
1300		OK	OK	OK	OK
1400			OK		
1500			OK		
1600					

Table 3
Range Test under adverse Weather Condition

Distance (Meters)	TRIAL1	TRIAL2	TRIAL3	TRIAL4	TRIAL5
20	OK	OK	OK	OK	OK
50	OK	OK	OK	OK	OK
100	OK	OK	OK	OK	OK
200	OK	OK	OK	OK	OK
300	OK	OK	OK	OK	OK
400	OK	OK	OK	OK	OK
500	OK	OK	OK	OK	OK
600	OK	OK	OK	OK	OK
700	OK		OK		OK
800					

D. GSM Service Delays under Good Weather

Table 4 shows the delay when data is transmitted from the acquisition node to the database computer via the GSM-SMS service under good weather condition has an average delay of 6 seconds.

E. GSM Service Delay under Bad Weather

Table 5 shows the delay when data is transmitted from the acquisition node to the database computer via the GSM-SMS service under heavy rain conditions. Even with five trials carried out, the delay in transmission is very high with an average delay of 22.80 minutes.

Table 4
GSM Service Delays under good weather condition

Trial	Distance at 100 meters		Delay (seconds)
	Time Sent	Time Received	
1	4:05:51 PM	4:05:57 PM	6
2	4:06:17 PM	4:06:24 PM	7
3	4:07:24 PM	4:07:31 PM	7
4	4:09:03 PM	4:09:10 PM	7
5	4:09:38 PM	4:09:45 PM	7
6	4:05:51 PM	4:05:57 PM	6
7	4:07:00 PM	4:07:06 PM	6
8	4:07:15 PM	4:07:22 PM	7
9	4:07:30 PM	4:07:35 PM	5
10	4:07:42 PM	4:07:48 PM	6
Average Delay			6

Table 5
GSM Service Delays under bad weather condition

Trial	Distance at 100 meters		Delay (minutes)
	Time Sent	Time Received	
1	12:01:00 PM	12:30:06 PM	29.00
2	1:08:00 PM	1:25:06 PM	17.00
3	2:12:00 PM	2:34:06 PM	22.00
4	3:00:00 PM	3:18:06 PM	18.00
5	4:27:00 PM	4:55:06 PM	28.00
Average Delay			22.80

V. CONCLUSION

In this work, a cascaded RF and GSM data transmission link for transmitting data that can be used for multi-node environmental data acquisition was designed and implemented. A microcontroller using the Z8 Encore was used to gather environmental data from the interfaced sensors, and transmit this data to adjacent nodes. A GSM module was interfaced to the first node in the cascade under the GSM coverage. A range test was conducted to characterize the transceiver's performance in transmitting and receiving data that are free from errors under good and adverse weather conditions. Based on the test done under good weather condition, the effective distance recorded between each node is 1200 meters, thus the overall effective distance is 2400 meters with three nodes in the cascade. However, under heavy rain conditions, the maximum distance between nodes is 600 meters, limiting the overall length to 1200 meters. Additional nodes can be added in cascade extending the length of the coverage.

Through the GSM module, data collected from the nodes can be transmitted to the database computer. Under heavy rainfall, it was observed that GSM experiences service unavailability. Thus, the base station receives the data with a massive delay. Under good weather conditions, the average delay to transmit data over the GSM network is 6 seconds. But under adverse weather condition, the average delay is 22.8 minutes.

REFERENCES

[1] J.R. Horne and D. Dabdub, "Impact of global climate change on ozone, particulate matter, and secondary organic aerosol concentrations in California: A model perturbation analysis," *Atmospheric Environment*, In Press, Accepted Manuscript, Available online 28 December 2016.
 [2] M. Zhang, N. Liu, R. Harper, Q. Li, K. Liu, X. Wei, D. Ning, Y. Hou, and S. Liu "A global review on hydrological responses to forest change across multiple spatial scales: importance of scale, climate, forest type

- and hydrological regime,” *Journal of Hydrology*, In Press, Accepted Manuscript, Available online December 26, 2016.
- [3] A. Ali, O. Erenstein, “Assessing farmer use of climate change adaptation practices and impacts on food security and poverty in Pakistan,” *Climate Risk Management*, In Press, Accepted Manuscript, Available online December 23, 2016.
- [4] [25] S. Chalise and A. Naranpanawa, “Climate change adaptation in agriculture: A computable general equilibrium analysis of land-use change in Nepal,” *Land Use Policy*, In Press, Accepted Manuscript, Available online December 31, 2016.
- [5] [24] M. Fossey and A.N. Rousseau “Can isolated and riparian wetlands mitigate the impact of climate change on watershed hydrology? A case study approach,” *Journal of Environmental Management*, In Press, Accepted Manuscript, Available online December 15, 2016.
- [6] P. Jiang, H. Xia, Z. He, and Z. Wang, “Design of a Water Environment Monitoring System Based on Wireless Sensor Networks”, *Sensors*, 2009, pp. 6411-6434.
- [7] M. Zhang, D. Li, L. Wang, D. Ma, and Q. Ding, “Design and Development of Water Quality Monitoring System Based on Wireless Sensor Network in Aquaculture,” *Advances in Information and Communication Technology*, Springer, Berlin, Heidelberg, 2011, vol. 347, pp. 629-641.
- [8] L. Jinfeng and C. Shun, “A ZigBee-based Aquaculture Water Quality Monitoring System,” *International Journal of u- and e- Service, Science and Technology*, vol.8, no. 10, 2015, pp.367-376
- [9] S. Ferdoush and X. Li, “Wireless Sensor Network System Design Using Raspberry Pi and Arduino for Environmental Monitoring Applications,” *Procedia Computer Science*, vol. 34, 2014, pp.103-110.
- [10] [9] M. Delamo, S. Felici-Castell, J.J. Pérez-Solano, and A. Foster, Designing an open source maintenance-free Environmental Monitoring Application for Wireless Sensor Networks,” *Journal of Systems and Software*, vol. 103, May 2015, pp. 238-247.
- [11] M. Srbinovska, C. Gavrovski, V. Dimcev, A. Krkoleva, and V. Borozan, “Environmental parameters monitoring in precision agriculture using wireless sensor networks,” *Journal of Cleaner Production*, vol. 88, February 1, 2015, pp. 297-307.
- [12] X. Li, Q. Tang, C. Sun, “The impact of node position on outage performance of RF energy powered wireless sensor communication links in overlaid deployment scenario,” *Journal of Network and Computer Applications*, vol. 73, September 2016, pp. 1-11.
- [13] W. Wei and Y. Qi “Information Potential Fields Navigation in Wireless Ad-Hoc Sensor Networks,” *Sensors*, 2011, 11(5): pp. 4794-4807.
- [14] W. Wei, X.L. Yang, P.Y. Shen, and B. Zhou, “Holes detection in anisotropic sensor networks: Topological methods,” *International Journal of Distributed Sensor Networks*, Hindawi Publishing Corporation, 2012.
- [15] S.T. Ozyer, B. Tavli, K. Dursun, and M. Koyuncu, “Systematic investigation of the effects of unidirectional links on the lifetime of wireless sensor networks,” *Computer Standards & Interfaces*, vol. 36issue 1, November 2013, pp. 132-142.
- [16] W. Wei, Xu, Q. Su, L. Wang, X. H. Hei, P. Shen, W. Shi, and L. Shan, “GI/Geom/1 queue based on communication model for mesh networks,” *International Journal of Communication Systems*, November, 2014, Vol. 27, Issue 11, pp.3013-3029.
- [17] G. Mappatao, C. Aragonés, P.D. Elpa, D.M. Pangan, and Q. Santos, “Scalable Remote Water Monitoring System Using Radio Frequency Links,” in *Theory & Applications of Applied Electromagnetics: APPEIC 2015*, pp.13-23.
- [18] Wireless Data Transmission over GSM Short Message Service (GSM-SMS), EACOMM Corporation Embedded Systems Division. Retrieved from <http://www.eacomm.com/downloads/products/textbox/wdtgsm.pdf>