

Development of Microstrip Monopole Antenna Integrated with Light Emitting Diode (LED)

S.N.Kamarudin, M.T.Ali, S.Subahir and H.Yon

*Antenna Research Group (ARG), Fakulti Kej. Elektrik, Universiti Teknologi Mara (UiTM), Shah Alam, Malaysia.
hidayah.kama@gmail.com*

Abstract—This paper presents the integration of Microstrip Antenna with Light Emitting Diode (LED). The objective of this design is to have a dual application in one single antenna, which is for wireless communication and illumination. Based on the result, the frequency is inversely proportional to the increase of the antenna size. The LED itself acts as a conductance for the antenna as it is also a part of the antenna. The antenna design is based on the structure of monopole antenna at 3.6 GHz. To design the antenna structure, Computer Simulation Technology (CST) was used with the permittivity, $\epsilon_r = 4.3$ thickness, $h = 1.6$ mm on FR4 substrate. The SMD5050 LED was used to integrate the antenna structure in parallel connection. The effects of integrating the LED into the antenna structure of antenna were determined through the performance of antenna in terms of return loss, gain, directivity and the efficiency. The results are 3.88GHz during the OFF state for the resonant frequency with -23.88dB return loss, whereby the results during the ON state are 3.75 GHz and -21.2 dB, respectively.

Index Terms—Integration; Light Emitting Diode (LED); Microstrip Antenna; CST.

I. INTRODUCTION

Wireless technology is going through expansive research and development. Thus, it is important to develop innovative antenna design as it is the fundamental of wireless system. One type of antenna, which can fulfill the requirement for wireless system is the microstrip antenna. In antenna research and development, microstrip antenna has variety of configurations and it is currently the most active field in this area. In addition, the usage of microstrip antenna does give a lot of benefits and increase a wide range of application in wireless communication system, which has been used in mobile devices, satellite application and biomedical application [1,2, 3]. Based on the requirement from users and service providers they usually request antennas that are small and compact as well as cost effective to be manufactured. However, the conventional antenna, such as microstrip antenna is only capable as agent of transmitting and receiving electromagnetic waves; thus, making this type of antenna is limited to a single application. Due to the variety of shapes and sizes of microstrip patch antenna, it can take the advantage of integration to other devices by intermixing with other components with different applications.

There has been a rapid development for plasma antenna due to the interests in its applications. One of the reasons for the attention towards plasma antenna is due to its dual application use, where it can become solely antenna and as a source of lighting. The conventional antenna usually uses metallic conductor as the antenna, while the plasma antenna uses the gas inside the fluorescent tube. When the gas inside the plasma tube is ionized to a plasma state, the gas becomes

conductive where it can replace the metals, which are usually used in the traditional antenna [4]. In terms of the antenna performance, plasma antenna has a very high directivity and gain compared with the traditional antenna. The directivity of the plasma antenna is high due to the high negative dielectric, which is a constant of the plasma antenna. [5] The Plasma antenna is suitable to used for military organization because of its invisibility to the radar. For the radar itself, it is difficult to detect the plasma when the plasma is switched OFF. Besides, the plasma antenna can be used in space communications considering that it is lighter than the traditional antenna [6]. Although the antenna performance of plasma antenna is better than the traditional antenna, there are some difficulties of the plasma antenna, such as power consumption, size and weight [7]. In addition, there are safety concerns due to the materials used to construct the lamp, when using the fluorescent lamp for plasma antenna. Glass that is prone to breakage could cause serious injuries, while the mercury inside the antenna could cause poisoning if it is consumed or touched. Therefore, the abovementioned problems can be addressed by using microstrip antenna, namely the integration of microstrip antenna with Light Emitting Diode (LED) [8,9]. The use of LED supports green technology, which is environment friendly. For the next generation, LED is adopted to replace incandescent and fluorescents lamp since the power consumption of LED is lower than the incandescent and the fluorescents lamp. The other benefits of using the LED compared to the existing light sources is that the LED has long-life expectancy, high illumination, more efficient and easy to maintain [10,11]. In this paper, the integration of microstrip antenna with Light Emitting Diode is proposed. This integration will produce dual functionality of the antenna, which can transmit/receive signal and function as illumination at the same time.

II. ANTENNA DESIGN

The basic design of the proposed antenna was drawn upon the base structure of monopole antenna. Figure 1 shows the steps of the design of the proposed antenna from a to c. Figure 1a) shows the first stage of the monopole antenna design. At the first stage of the design, the monopole antenna consists of the main patch, which was designed at 3.6 GHz by using the FR4 substrate with permittivity of 4.3 and thickness of 1.6 mm. The gap between the patch was used to locate the LED and the size of the gap is dependent on the size of LED. The details of the parameters and the dimension of the proposed antenna are tabulated in Table 1.

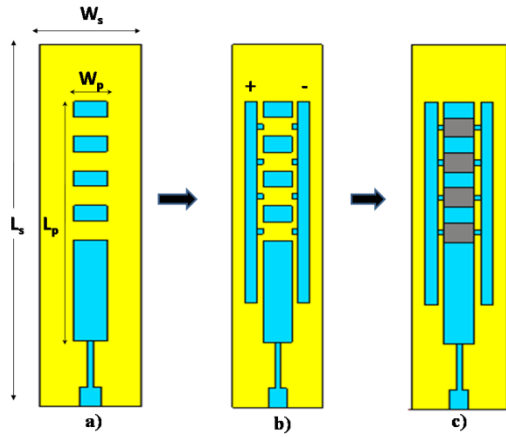

Figure 1 : The steps of the integration in simulation, (a) No LED, (b) No LED with parasitic (c) LED with parasitic.

Table 1
Parameters of the Antenna

Parameters	Dimension (mm)
Width of patch (W_p)	5.0
Length of patch (L_p)	47.72
Width of substrate (W_s)	15.0
Length of substrate (L_s)	72.07
(+)	Anode
(-)	Cathode
Width of SMD LED (W_d)	5.0
Length of SMD LED (L_d)	5.0

The two parasitic elements was added, as shown in Figure 1b) and 1c). The purpose of adding the parasitic element as shown at Figure 1 is to represent the anode and the cathode for the LEDs since all LEDs were mounted in parallel connection. The addition of the parasitic element affects the resonant frequency at the main patch, which changed from 3.6 GHz to 4.0 GHz. To investigate the effects of integrating LED with antenna, four numbers of the SMD LEDs were used and placed in between the parasitic elements. The type of the LEDs in this design is SMD 5050 LED, which is white LED, as shown in Figure 2a. Figure 2b is the size of the LED in simulation configuration. The size of the LED in simulation and in fabrication is the same and its dimension are presented in Table 1.

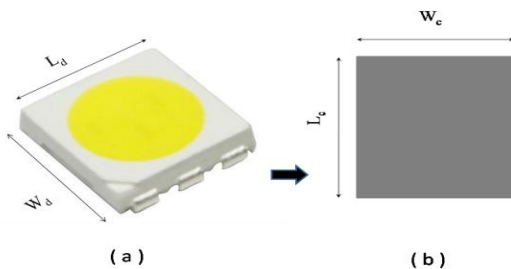

Figure 2: (a) Real SMD5050; (b) LED in simulation

Since the LEDs were connected in parallel connection, the required total voltage is small as compared those in series connection. The total voltage required to switch on all the LEDs is 3.4 V.

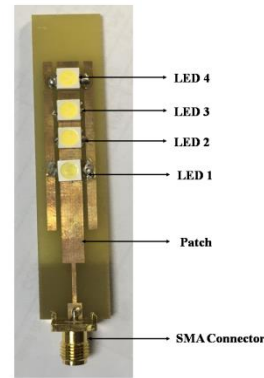

Figure 3: Structure of the antenna with LED

III. RESULT AND DISCUSSION

To study the effects of integration between the microstrip antennas with LED, the proposed antenna was successfully fabricated and measured, as shown in Figure 3. The performance of the antenna was analyzed in terms of its return loss, gain, directivity gain and efficiency. Figure 4 shows the comparison result of the return loss for the different number of LED. The one-by-one addition of the LED into the antenna structure causes the excitation of the resonant frequencies. Table 2 shows the changes of resonant frequency from zero led until LED 4. The value of return loss is above -10dB. By increasing the number of LEDs, the frequencies are being shifted from high to low. This is due to increase in the length of antenna; the resonant frequency shifts at a lower frequency.

Table 2
Measurement Result for Return Loss

Number of LED	Frequency (GHz)	Return Loss (dB)
NO LED	4.10	-20.13
LED 1	3.97	-14.57
LED 2	3.93	-21.23
LED 3	3.90	-21.76
LED 4	3.88	-18.87

Measurement of LED1-LED4-Parallel

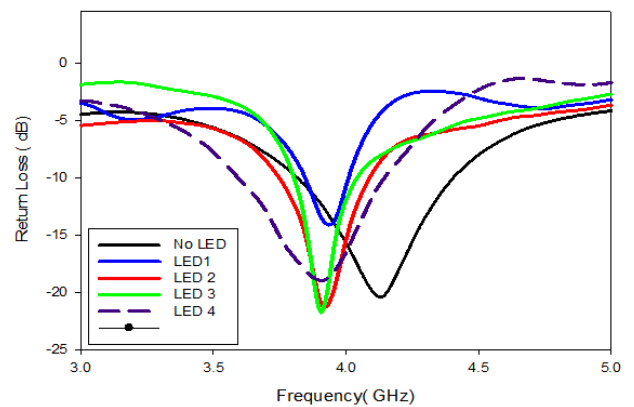

Figure 4: The measurement result of return loss

The performance of the proposed antenna in terms of the return loss during the ON and OFF states of the LEDs is shown in Figure 5. The changes of the condition ON/OFF show the excitation of the resonant frequency. The difference of resonant frequency between the ON and OFF of the LED

is only at 3.3%. Table 3 shows the tabulating data for the performance of antenna for the gain, directivity and efficiency, which has been divided into three conditions (No LED, OFF and ON). Based on the value of gain during the OFF and ON state, it shows that the difference in the gain during the ON state is much lower than the OFF state, which is about 72%. This may due to the interruption of DC current (during ON) to the antenna.

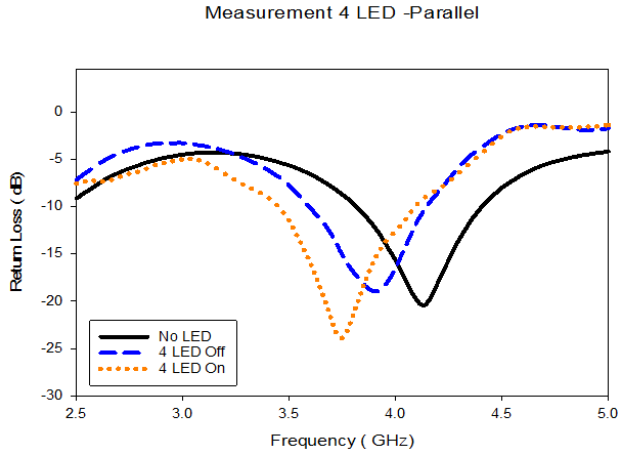

Figure 5: The measurement result for conditions ON/OFF

Table 3
Measurement for ON/OFF Conditions

	No LED	OFF	ON
Frequency (GHz)	4.10	3.88	3.75
Return Loss (dB)	-20.13	-23.88	-21.12
Gain (dBi)	3.56	3.1	0.86
Directivity Gain (dBi)	6.57	5.65	4.39
Efficiency (%)	50	55.59	44.36

Radiation pattern of the antenna was measured in anechoic chamber. The radiation pattern during the ON and OFF state for the 4 LEDs are shown in Figure 6. It clearly shows that the entire radiation pattern for the three conditions has a slight difference in terms of the radiation pattern. The results show that this antenna structure produce the omnidirectional pattern since the ground of the antenna is partial ground. The radiation pattern for the ON state is smaller than the OFF state, which it is related to the value of gain, as shown at the Table 3.

IV. CONCLUSION

This paper presents that the proposed antenna design in which the integration microstrip antenna with LEDs was successfully simulated and fabricated. The effects of integrate the LEDs show the shifting of the frequency. As the size of the antenna increases, the frequency will be lower. The LEDs itself can be represented as the conductor of the antenna, where it can act as a part of the antenna. For future work, some methods are needed to enhance the gain of the antenna since the gain during the ON state drops drastically. Overall, this integration proves that the LED can be integrated with the antenna, and it can be as a dual application as well as an illuminator.

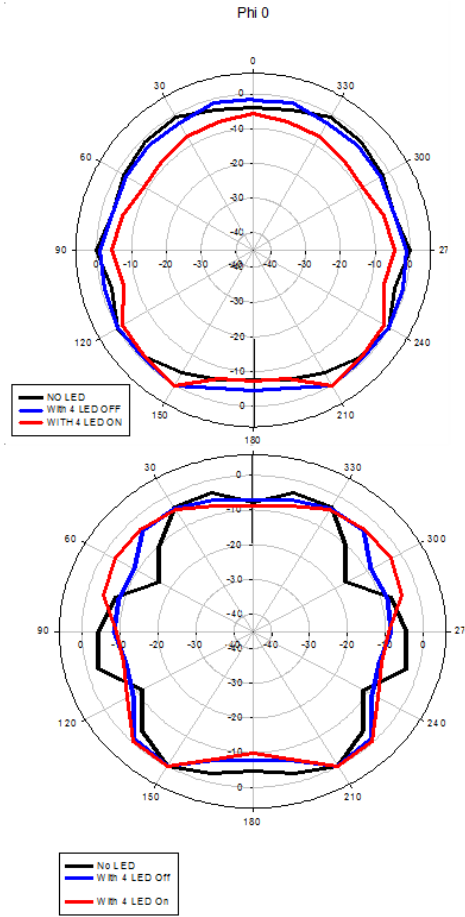

Figure 6: The radiation pattern for antenna

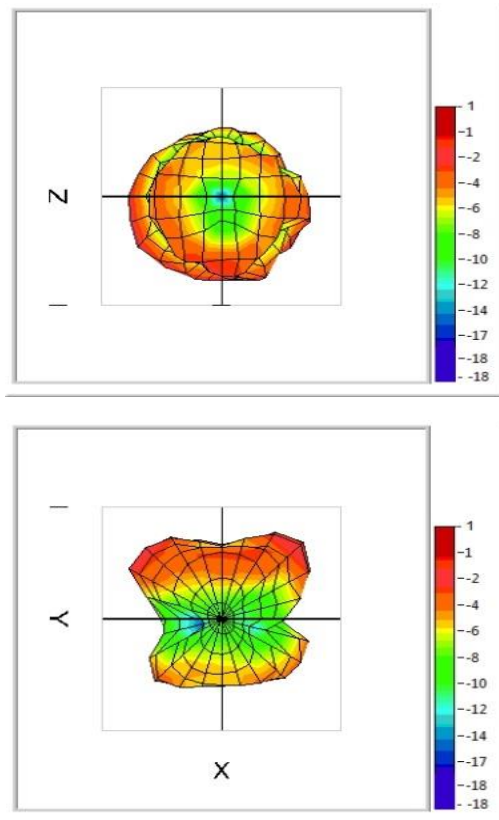

Figure 7: 3D Radiation pattern

ACKNOWLEDGEMENT

The authors would like to convey the deepest gratitude to Fakulti Kejuruteraan Elektrik, Universiti Teknologi Mara, Malaysia for support and guidance.

REFERENCES

- [1] V. R. Ekke and P. L. Zade, "Gain enhancement of Microstrip patch Antenna Array by using substrate integrated waveguide for wireless communication system," 2016 International Conference on Automatic Control and Dynamic Optimization Techniques (ICACDOT), Pune, India, 2016, pp. 1017-1019.
- [2] M. B. Hossain and S. Datto, "Improvement of antenna performance using stacked microstrip patch antenna," 2016 2nd International Conference on Electrical, Computer & Telecommunication Engineering (ICECTE), Rajshahi, Bangladesh, 2016, pp. 1-4.
- [3] Christodoulou, C.G.; Tawk, Y.; Lane, S.A.; Erwin, S.R., "Reconfigurable Antennas for Wireless and Space Applications," Proceedings of the IEEE, vol.100, no.7, pp.2250-2261, July 2012
- [4] Chintan Patel, Nadeem Masani , Tushar Parekh. "Plasma Antenna", International Journal of Engineering Trends and Technology (IJETT), V15(6),275-277 Sep 2014. ISSN:2231-5381
- [5] P. Russo and G. Cerri, "Analysis of a reconfigurable plasma antenna," 2016 10th European Conference on Antennas and Propagation (EuCAP), Davos, 2016, pp. 1-5.
- [6] A. N. Dagang, N. F. Ramli, N. S. Alias and M. T. Ali, "Effect of Plasma Parameters on Monopole Plasma Antenna Performance," 2016 International Conference on Computer and Communication Engineering (ICCCE), Kuala Lumpur, 2016, pp. 434-438.
- [7] J. Sun, Y. Xu and H. Sun, "Experience on plasma antenna technology," 2015 Asia-Pacific Microwave Conference (APMC), Nanjing, 2015, pp. 1-3.
- [8] H. Yon, A. H. Awang, M. T. Ali, S. Subahir and S. N. Kamaruddin, "Parametric Study of Integrated Stacked Microstrip Antenna with Light Emitting Diode (LED) for Wi-Fi Application," 2016 International Conference on Computer and Communication Engineering (ICCCE), Kuala Lumpur, 2016, pp. 9-12.
- [9] S. Subahir, M.T. Ali, N.A. Ramli, S.N. Kamaruddin, A.H. Awang, M.R. Kamaruddin, "Development of Rectangular Loop Microstrip Antenna Integrated With Light Emitting Diode (LED) for Wi-fi Application", The International Electrical Engineering Congress (iEECON 2015), March 2015.
- [10] Sinnadurai, R.; Khan, M.K.A.A.; Azri, M.; Vikneswaran, V., "Development of white LED down light for indoor lighting," Sustainable Utilization and Development in Engineering and Technology (STUDENT), 2012 IEEE Conference on, vol., no., pp.242,247, 6-9 Oct. 2012
- [11] Rehman, M.M.U.; Shabbir, H.; Rehman, S.A.; Sheikh, S.K.; Zaffar, N., "A Comparative Analysis of Electrical and Photo Characteristics of LED Lights," Frontiers of Information Technology (FIT), 2012 10th International Conference on, vol., no., pp.219,224, 17-19 Dec. 2012