

Distress Signal Tracker Using GPS and SMS Technology: A Prototype

Neil P. Balba¹, Ralph H. Balingasa¹, Maria Tricia Camille R. Bilog¹, Jonnelle Klenn D. Castillo¹, Jerome M. Perez¹, Agnes F. Terrible¹, and Rionel Belen Caldo²

¹Computer Engineering Department, Lyceum of the Philippines University-Laguna (LPU-L), Laguna, Philippines.

²Electronics and Communications Engineering Department, De La Salle University (DLSU), Manila, Philippines.
neilbalba@lpulaguna.edu.ph

Abstract—There is no time in history that tracking has become a part and parcel of almost everyone's lives than it is today. Due to the need of a device that enables easy access in locating a particular person, things or vehicles, the proponents aim to develop a study which comprises of the communication between a distress signal tracker incorporated in a server through mobile communication (SMS) that contributes to public safety, delivers accurate location of the user to the corresponding recipients and provides a real-time monitoring system using VB.Net and MySQL. The method of research used, in this study, is experimental method which involves the identification of response time and availability of the network signal. A series of testing was performed in 30 different locations in Calamba, Laguna demonstrating the versatility and accuracy of the device and server under various circumstances. Based from the evaluation of the data gathered, the results are proved to satisfy the required objectives and specifications of the study.

Index Terms—Distress Signal Tracker; Accurate Location; Real-time Monitoring; VB.net; MySQL.

I. INTRODUCTION

As this world seems to be a big place for everything, it is best if people can track the exact location of things, people, vehicles and assets and not to lose control of them; that is why tracking has become a part and parcel of almost everyone's lives in this century. Manual tracking of location such as the use of landmarks, old maps and even the position of the stars are considered outdated and may cause a lot of misunderstandings and uncertainties. Thus, the shortcomings of the old way of tracking and the immense popularity of tracking numbers of people paved way to the implementation of innovative tracking systems starting from the early years of technological advancement.

The emergence of Global Positioning System (GPS) gives tracking units the sense of power and modification which helps one to identify the exact location, time and speed of a person, vehicle, pets and other things including one's assets to which the unit is attached to. Moreover, the development of a compact, portable and economical GPS device or receiver has made a lot of difference in today's living; aside from GPS devices, GPS can also be implemented in mobile phones and computers with Internet [1]. When it comes to its value, GPS is a benefit to almost all areas -- agriculture, military, maritime, automotive, surveying, aviation and forestry, environmental and public safety [2]. This can also be applied to mobile phones through the creation of Global Positioning System navigation via online applications such as Waze and Google Maps Navigation and offline applications including iGo and Maverick [3].

Although GPS started to dominate important aspects and areas particularly in the Philippines, there are issues that still have not received much favor from it -- one of these is the surge of criminal cases nationwide. According to the report of Philippine National Police (PNP), the total crime volume rose in the first five months of 2014 from the corresponding period last year. The dramatic rise in numbers is brought by varying practices in counting crime incidents in which crime rate has not been properly reported or recorded by the authorities as explained by PNP spokesman Chief Superintendent Reuden Theodore Sindac [4].

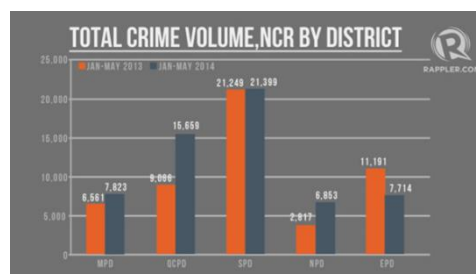

Figure 1: PNP DIDM NCR Crime Volume



Figure 2: PNP DIDM NCR Crime Statistics

The figures released by PNP demonstrated an upsurge of 17.86% in the crime volume from January to end of May 2014 -- from 245,347 incidents in 2013 to 289,198 in 2014. The total crime volume, as shown in the statistics above, is the sum of reported index (murder, homicide, robbery and theft) and non-index crimes (estafa, prostitution, kidnapping and car napping) [5].

Index crimes have increased across the board compared to the statistics gathered in 2013, based on the report, with incidences of theft rising the most. There have been 25,354 index crimes as of 2014, 19.3% higher than the 21,252 recorded the other year, which include Murder (412 from 296), Homicide (400 from 386), Physical Injury (8,455 from 7,597), Rape (450 from 369), Robbery (5,189 from 4,510), Theft (9,170 from 7,109) and Car napping (1,278 from 985).

According to PNP, these index crimes are crimes “which are serious in nature and which occur with sufficient frequency and regularity” that they can be used as an indicator of the crime situation in an area [6].

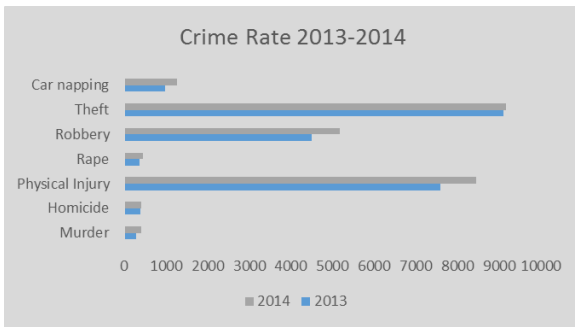

Figure 3: PNP 2013-2014 Crime Rate

With the growing cases of crimes everywhere, one might not feel secure when going outside and even at home. The availability of police stations in almost every place does not guarantee the avoidance of crime since it often occurs unexpectedly without having the time to call a police. It is often unnecessary to bring out the phone and call someone for help as the crime is taking place since it might cause a lot of trouble.

As the technological advancement brought the availability and affordability of cellphone in today’s century, the immense popularity of texting has been an unstoppable phenomenon that completely altered the way people communicate. The development of text promos such as unlimited texting and the emergence of the popular “group messages” or “GM” in which users can send same messages to more than one contacts for that matter paved way for the Philippines to be hailed as the “Texting Capital of the World” for the year 2013 alone with an average of 600 text messages per month (43% more than their counterparts in United States) based from the Short Message Service (SMS) statistics aggregated from various sources including New York Times [7]. With this, the use of cell phone, whatever unit it may be, as well as texting are indeed becoming part of everyday life of vast Filipino people [8].

With these observations and research, the proponents came up with the idea of developing a project entitled “Distress Signal Tracker using GPS and SMS Technology” which serves as an innovation to public safety. This project implements an easy and convenient way to inform the people of the community the exact location of a certain person who is in danger and for them to provide aid and safety through Global Positioning System (GPS) and Short Message Service (SMS) via Global System for Mobile Communications (GSM) technology. Furthermore, this provides a sense of security that whenever the user of the device is in danger, a particular receiver will acquire notification of the exact location of the user and most likely he can do something to provide immediate service.

Due to the need of a device that will help establish a safe and secured community, this study primarily aims to develop a system that can be used for tracking the user when in danger. Specifically, this study aims to:

- Develop a server that will be able to obtain accurate location of the user, around Calamba area only, to be transmitted by a tracking device.

- Develop and design a software using VB.net that will convert the corresponding coordinates into the specific location through Google Map, will provide real-time tracking and system monitor-ing to the server administrator and will send SMS notification to immediate family.
- Test and evaluate the functionality, accuracy and reliability of the system.

II. METHODOLOGY

A. Block Diagram

Figure 4 shows the process as to how Distress Signal is interpreted. The system flow begins during the GPS tracking device activation. Once activated, the Device will then send a particular message understood by the main server through several codes in VB.net. Once the message is received by the Main Server, through the instruction sets enlisted on its codes, it will send specific bits of information that will trigger the indicators of Buzzer and the Buzzer notifying the Main Server that the user is under undesirable circumstances. Furthermore SMS will be automatically sent to the necessary recipient of the user letting them know of the danger.

As an added function, the user’s corresponding recipient can continually monitor the whereabouts of the user by texting a code recognized by the device commanding it to send its coordinates to the Server without even pressing the panic button.

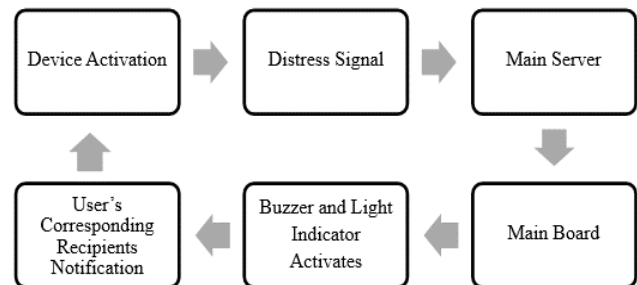

Figure 4: Distress Signal Tracker Block Diagram

B. System Flowchart

The proponents used system flowchart as shown in Figure 5 to represent the overall flow of the system; from recognizing a distress signal, continuous real-time tracking and the notification of both the server and recipients when the user is in distress.

C. Proposed Design

The project is subdivided into various key components as shown in Figure 6. The main server continuously request for the GPS’ location in the form of coordinates. Given there is both GPS and 2G network available the device, via SMS, will send its coordinates accessed from the nearest GPS satellite to the main server; under the circumstances that GPS signal is available the main server will prompt the administrator that the device has no GPS signal through the activation of indicator. Once the server receives the necessary information needed it will then plot the coordinates in Google Map enabling a visual representation about the device’s whereabouts; simultaneously, it will record the event to its log for security purposes.

Under the circumstances that the SOS button on the GPS device is pressed for 3 seconds. The device will then send a

notification, via SMS, of a distress call to the main server. At the same time the main server will send information to the Main board activating the Buzzer and the Blinker which indicated that the user is sending a distress call. Once the task are done the main server will then send, via SMS, notification that the user has send a distress signal and the last location the device was last located to specific recipients denoted by the user.

In case of long term casualties, specific individuals can access the user's location by texting specific code to the main server via SMS. Once the text message is recognized by the server it will then relay the device's last location it was traced to the sender. This function of the device can also be used as to locating certain things, specifically vehicles, given that the device is in the thing/vehicle itself.

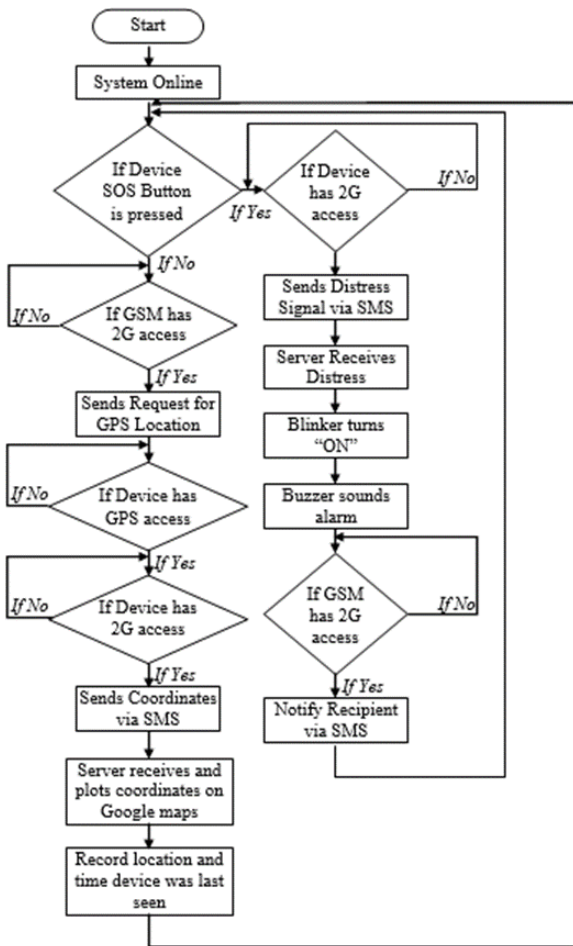

Figure 5: Distress Signal Tracker Flowchart

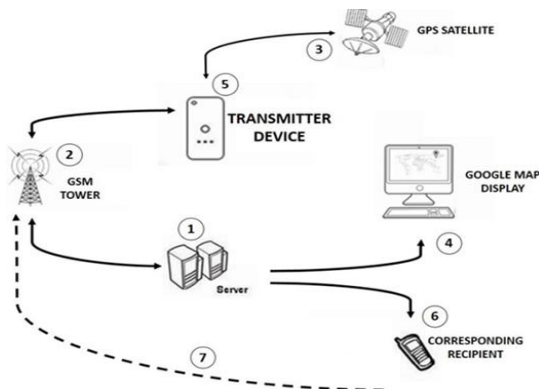

Figure 6: System Overview of the Research

III. DESIGN CONSIDERATION

A. Hardware

The hardware consists of several components:

1. Main Server. Serves as a workstation containing all the software needed to execute the entire system of the study. It is in charge of receiving the information: coordinates, battery status, and GPS status of the device given by the Main board conceded from the GPS Tracking device. The main server is composed of a Core 2 Duo processor (2.6 Ghz), 2-Gb of memory, and a dual display video graphics accelerator (VGA).
2. Dual Display VGA. The main server uses a dual display VGA which provides a better utilization of the software. Display 1 would show the overall status of the program while it is being executed as while Display 2 would continuously display the real-time tracking, via Google Map, of the current location of the device given that it has access to GPS signal.
3. USB (2.0) Port. A standard communication port which serves as the main communication between the Main board and the Main Server. It delivers asynchronous communication which interfaces the information given by the main board. It is composed of 4-pin namely: Vcc, Gnd, Rx, Tx which transfers 400-Mb/sec.

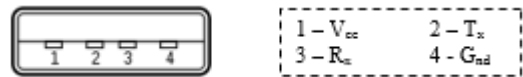

Figure 7: USB Pin Configuration

4. GPS Tracking Device Acts as the main access to the GPS satellites to locate its coordinates. The GPS device transmits the location data in real-time via the same cellular data network used by mobile phones. The GPS sends the coordinates to the GPS receivers (server) which converts location and the time information into a useful display format like that of a website for real-time location mapping. GPS needs to access to the open sky to be able to get a signal from the cellular network and to capture the satellite signals. This also needs a power source.
5. Main Board

Governs the overall flow of bits of information for the activation of the relay switches connected to the indicators. The main board schematic diagram is as shown in the Figure 8.

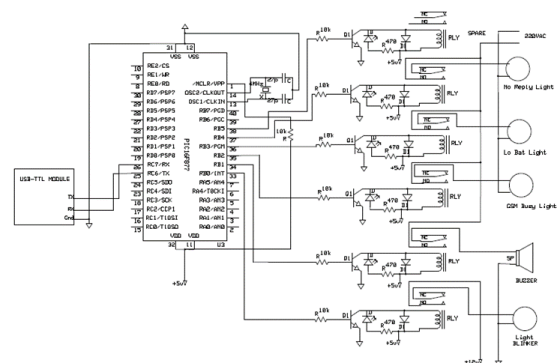

Figure 8: Main Board Schematic Diagram

6. GSM Module

The core communication of the system is a wireless communication that uses a GSM Module. After receiving the converted coordinates of the user, the GSM Module will send SMS to the relatives of the user which are saved in the database of the system to notify the location of the user.

B. Software

Software used in the project:

1. MySQL

Serves as the main relational database of the software containing information about the records as to where the GPS tracking device was located in Google Map.

2. PICKIT

Works as the instructions sets encoded in PIC as to how it will function given the varying conditions delivered by the main server.

C. Test and Evaluation the system

Using experimental method, the proponents will conduct series of testing that held in different places of Calamba, Laguna to determine the credibility and functionality of the device in transmitting distress signals to the server. The said server will be placed in Castillo's residence in Brgy. Saimsim, Makiling, Calamba Laguna which will serve as the police station and will be checked also to see if it can perform its function. Aside from the functionality, the device will undergo testing to identify the places that are within its coverage and its corresponding coordinates and time. All testing operations, when received by the server, will be recorded in the database. Results will be tabulated and will further be evaluated by the proponents.

D. Improvements on the system

After the proponents analyzed the functionality of the device and the server, the proponents will then further improve the shortcomings that will exist in the whole system to provide desirable results. Modification of the device and server will take place once uncertainties occur within the system. Furthermore, the whole system will try and test another network carrier if the current network carrier will be proven to have weak signal strength in most of the areas.

E. Implementation of the system

The Distress Signal Tracker and the tracking device will be implemented using GSM module to establish two-way transmission of notification between the device and the server. The device is also integrated with GPS module to track its location on real time. As for the server, VB.net and MySQL platforms will be applied for the construction of the main software and the database, respectively. The server is also proposed to implement in police stations if possible.

IV. CONCLUSION

The development of a Distress Signal Tracker in connection with a tracking device is focused in this study. The distress signal tracker has the ability to determine the status of the whole system, which includes the tracking device and the distress signal tracker, as displayed through the indicators. The indicators were calibrated to test if the microcontroller can able to operate these according to their respective functions.

Through the integration of GSM and GPS modules, the device and the tracker can send and receive the corresponding coordinates to the tracker and from the device, respectively. This was verified as these two have established successfully a two-way communication through SMS and in fact, have acquired a minimum average time of 1 minute and 8 seconds and maximum average time of 3 minutes and 45 seconds, which do not exceed to the time difference limit, throughout the simulations. As the signal strength of Globe Telecom weakens in a certain area, the delay in the response time of the server lengthens; thus the response time varies for different locations.

Aside from obtaining coordinates, tracking is also made possible in this study since the tracking device is connected to GPS satellites. Through the developed software, the user's location can be viewed in a specific place in Google Map based from the corresponding coordinates. As supported by the data in Chapter 5, the shortest delay from the time the coordinates were received to the time the user's location was plotted on the map is 1 minute & 15 seconds and the longest delay, on the other hand, is 1 minute and 36 seconds. In places where there is no stable signal of the GPS such as in congested areas and inside a building, there is a tendency to have a delay in the display of location and much worst, there is a possibility that the tracking device will transmit notification with no indicated coordinates. Aside from that, GPS signal may also be weakened during rainy days.

In accordance to our interview with SP01 Emil Janairo, Calamba Municipality Police, he stated that: "The system would deeply help the police crime operation given that we would fast track instances of casualties. And if ever we are ask for absorbing the system we would be more than glad to adopt it".

Given the statement above the implementation of Distress Signal Tracker using GPS and SMS Technology would intensely benefit the Police in responding to the crime rate undergoing in Calamba. Not only would they easily know as to when a crime is undertaking, likewise they would be knowledgeable as to its whereabouts.

With all these, it was proven that the Distress Signal Tracker can be used to track the user in danger and might as well keep him/her from being a victim of potential crimes. The only way for these to be done is through a press from SOS button. Given that the system acquired good and favorable network and GPS signal strength, the whole system was verified to have functioned properly and was determined to be reliable as this acquired accurate results including the time and the location of the user. However, the consistency of the system regarding its accuracy and reliability may possibly change since these are all up to the strength of the network and GPS signal.

V. RECOMMENDATION

In lieu of the aforementioned projections, the proponents are prompted to formalize their expectations into two parts:

1. Those based on the research findings/data of the study.
2. Those that will grow out of the study, requiring further related studies

A. Expectation based on Findings/Data of the Study

This study aims to develop a distress signal tracker integrated with GSM and GPS module along with a main server which will be implemented in a police station. If future

researchers would want to add modification for further improvement of the present study, the following are the recommendations that might greatly help them:

1. The network carrier employed for both the device and the server during a series of testing is Globe Telecom. For further researchers, it is advisable if they can use different network carriers for testing to evaluate and determine the best network carrier for the device and the tracker in the locale of the study. Moreover, it would be great and efficient if the SIM card to be inserted is subscribed to postpaid plan with unlimited text promo in order to avoid running out of load in times of danger.
2. Since the proponents were not able to conduct testing in other areas of Calamba due to time constraints, researchers, who are planning to continue and support this study in the future, are recommended to conduct testing to all areas in Calamba most especially to remote areas considering that there is an available network and GPS signal.
3. It is more preferable if the server, during testing, is implemented in a police station with installed internet connection in order to determine if a police station is really capable to handle the system and to better satisfy the objective of this study.
4. Considering that the proposed system is subjected for one device only for it is meant to be a prototype and due to the inadequacy of Google Map to display location of two or more different GPS devices at the same time, the future researchers are recommended to pursue on a platform which supports multiple devices and employ a web mapping service application which displays locations from different devices, or they can make their own application for the system.

B. *Expectation beyond the Context of the Study*

Other limitations of the study, specifically the tracking device and the server, could also be enhanced through the following:

1. The tracking device used in this study is a ready-to-use tracking device in which the proponents have programmed according to its functions. The future researchers could go beyond that by developing their own tracking device based from what they want for their device to offer or they could purchase a high-end tracking device instead. They can provide additional functions including the ability to inform the police what is the specific crime the user is concerned with by adding buttons for each crime.

2. As the tracking device is small in size, there is a possibility that the user might left it in places where it is hard for it to find; with that, it is recommended to develop a tracking device that can be used as an accessory in order to avoid being misplaced; this can be a watch, a necklace or any other personal accessories that can be worn by the user.
3. In connection to the previous recommendation, the future researchers can also integrate the tracking device into mobile phone since it is also a part of a person's everyday life. They can create an application that will perform functions similar with that of the tracking device. Instead of clicking the app itself, the future researchers could probably employ algorithms to launch the app and automatically transmit notification just by long-pressing a certain button of the phone.

ACKNOWLEDGEMENT

The proponents would like to express their deepest gratitude to the following which have made the project possible to be accomplished; firstly to God Almighty Father as the source of courage, strength, wisdom during endeavors in the project; to their parents for providing unconditional support and words of motivation. They also would like to thank the College of Engineering and Computer Studies (COECS) and Research and Statistics Center of Lyceum of the Philippines University – Laguna (LPU-L) for funding the dissemination and publication of this research.

REFERENCES

- [1] [Online]. Available: <http://www.gmat.unsw.edu.au/snap/gps/pdf/gps-article2.pdf> [Accessed: Nov. 21, 2014].
- [2] [Online]. Available: [http://www.extension.umn.edu/youth/mn4-H/projects/docs/geospatial-science technology-GPS.pdf](http://www.extension.umn.edu/youth/mn4-H/projects/docs/geospatial-science%20technology-GPS.pdf) [Accessed: Nov. 21, 2014].
- [3] [Online]. Available: <http://www.academia.edu/4579217/Gps> [Accessed: Nov. 21, 2014].
- [4] [Online]. Available: <http://www.manilatimes.net/crimevolu-me-up-in-first-5-months-of-2014-pnp/107301/> [Accessed: Nov. 24, 2014].
- [5] [Online]. Available: <http://www.rappler.com/nation/61798pnp-crime-stats-2014> [Accessed: Nov. 24, 2014].
- [6] [Online]. Available: <http://www.gmanetwork.com/news/story/367656/news/nation/pnp-crime-up-by-17-percent> [Accessed: Nov. 24, 2014].
- [7] [Online]. Available: <http://jatps.hubpages.com/hub/ThePhilippines-is-Still-the-Undisputed-Text-Capital-of-the-World> [Accessed: Nov. 24, 2014].
- [8] [Online]. <http://www.interaksyon.com/infotech/20-yearson-sms-remains-king-in-the-texting-capital-of-the-world> [Accessed: May 7, 2014].