

# Experimental Study on Efficiency of DC and AC Power Supply Travel Kit using Solar Panel

Wafi Aziz<sup>1,3</sup>, Muzaffar Kadir<sup>1,3</sup>, Norain Rahim<sup>2,3</sup>, Zaidi Tumari<sup>1,3</sup>, Wan Norhisyam Abd Rashid<sup>2,3</sup>, Ainol Sheqal<sup>3</sup>

<sup>1</sup>Centre for Robotics & Industrial Automation, Universiti Teknikal Malaysia Melaka, 76100 Durian Tunggal, Melaka Malaysia

<sup>2</sup>Centre for Telecommunication Research & Innovation, Universiti Teknikal Malaysia Melaka, 76100 Durian Tunggal, Melaka Malaysia

<sup>3</sup>Faculty of Engineering Technology, Universiti Teknikal Malaysia Melaka, 76100 Durian Tunggal, Melaka Malaysia  
wafi@utem.edu.my

**Abstract**— The paper presents an experimental study on the efficiency of an assembly-kit of a standalone AC and DC power supply that is suitable for people who appreciate outdoor activities such as travel, jungle tracking, camping and so on with one major setback which is the limited electricity power source. The kit uses photovoltaic (PV) system to generate electricity from sunlight that will charge the controller to then stored generated energy in the battery. An inverter is used to convert DC power from battery to AC power for supplying power to AC appliances. Two places which are Bukit Beruang and Marina Beach in Melaka, Malaysia were chosen for the experiment to be conducted. Data of voltage produced by the PV system at these two places are taken and recorded. Charging handphone and power up lamp is used to test the DC and AC power consumption of the travel kit. Result obtained demonstrates the effectiveness of the travel kit in supplying AC and DC power for lite usage.

**Index Terms**—Power Supply, Solar Panel, Travel Kit.

## I. INTRODUCTION

Nowadays, electricity becomes one of the basic need for peoples in daily life. Most of the home appliances need electricity to function. People need electricity to make their life easier. There are times when people wanted to go to places where electricity is very limited but still in need of electricity for their daily activities for instant charging hand phone and power up the lamp. Normally, this happens when people go camping, fishing, jungle tracking or doing research in the rural area. At these places people need an alternative power supply. One of the alternative power to generate electricity at these places is sun light.

Sun light is the most suitable renewable energy that can be used for this system. Sun light provide energy to sustain life in our solar system. In terms of renewable energy, solar energy is the ultimate source. It is an energy that will never run out and environmental friendly which not directly result in pollution to the environment [1]. Malaysia has sunshine throughout the year is very favorable to the system. The annual average daily solar radiation is 4.21-5.56 kWh/m<sup>2</sup>. The highest solar radiation is estimated at 6.8 kWh/m<sup>2</sup> in August and November, and the lowest is 0.61 kWh/m<sup>2</sup> in December [2].

A photovoltaic (PV) system, consist of several solar cells that convert light energy into electricity. It generates electricity directly from the sun without using fuel and has no concern for environmental impact. Currently in Malaysia, solar energy application is for the domestic hot water

system, water pumping and sell to TNB Berhad. Current market price of PV system in Malaysia is quite expensive that makes it not favorable. Malaysia does not have local solar cell manufacturer and all the PV module are imported from advance countries such as Germany and Japan.

There are two types of solar panel system which are grid-tied solar PV and stand-alone solar PV system. The stand-alone system consists of a battery, PV module, charge controller and inverter. PV module can generate DC voltage when it has been exposed to the sunlight by capturing solar radiation [3][4]. The battery is used to store all the output DC voltage from the solar panel for future use. To get AC power, the inverter can be used to convert DC power to AC power.

## II. SYSTEM DESIGN

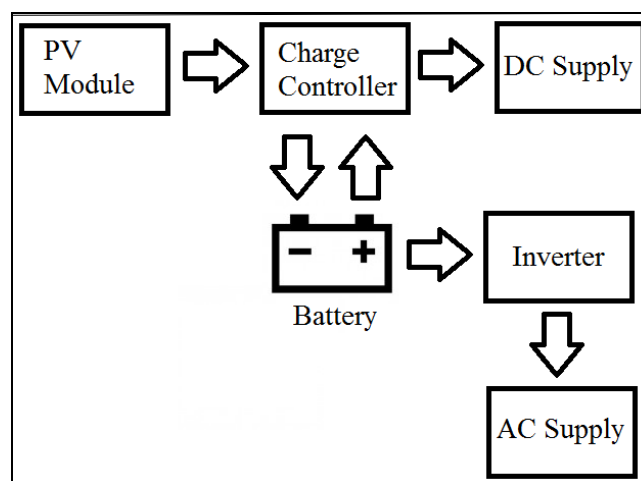

Figure 1: Block Diagram of PV System

Figure 1 shows a simple solar electric system that consists of four parts which are PV module, battery, charge controller (control unit) with DC supply and inverter with AC supply. PV module is used to generate electricity from sunlight. Generated electricity then will be transferred to charge controller to charge battery and supply DC power. Other functions of charge controller are to protect the batteries and wiring, switch the loads manually or automatically, give warnings when faults happen in the system and monitor the performance of the system. There is simple PV system that does not have control unit. For this system, the battery is directly connected to the solar module. Normal size for battery been used is a 12V Lead-acid

battery which used to store the electricity. The stored electricity is then being distributed in 12V to 24V DC. Electrical appliances that require DC supply can directly get the supply from the charge controller. For AC supply, it needs an inverter to convert DC supply to AC supply. According to Syed et al, 2012 operation of the solar system does not produce any air pollution and health environmental, but safety issue needs to be considered [5].

**A. PV Cell**

Electricity is generated directly from the sunlight using solar cell; also known as Photovoltaic (PV) cells. PV cells, by their nature, convert radiation to electricity. PV is noiseless and works without mechanical or chemical processes. No fuel is required and it can last for at least 20 years. Most of the solar cells are made from silicon which is a crystalline and thin film. Crystalline consists of two types, which are mono-crystalline and poly-crystalline. Light emitted by the sun that touches on the surface of the silicon been converted to electric power by “photovoltaic effect” process.

One solar cell can only produce around 0.4V which is not high enough. To solve this problem, solar cell is connected in series to sum up the output voltage to the required amount. According to Manoj et al, 2014, efficiency of solar cell concerned as the amount of the light that can be converted into the usable format of electricity [6].

**B. Charge Controller**

A charge controller or charge regulator is basically a voltage regulator that has a function to protect batteries from over charge and discharge [7-9]. It regulates the voltage output from the solar panel before being used to charge the battery. Output voltage generates by the solar panel varies depending on the radiation of the sun light. Over voltage can cause damage to the battery. A suitable voltage to fully charge the battery is around 14V to 14.5V. There are many types of regulation algorithm available such as, on-off regulator, single stage or multi stage regulator, pulse width modulated (PWM) regulator, array maximum power point tracking (MPPT) regulator and so on. To choose a good charge regulator, parameters such as maximum battery current, a maximum open circuit (input) voltage and rated solar/load current are important to be considered. In this paper PWM type regulator is chosen.

PWM type regulator can achieve constant voltage battery charging by switching the solar system controller [10]. A PWM is not DC to DC transformer. It acts like a switch which connects the battery with the solar panel. When in condition closed circuit, the panel and battery will be at nearly same voltage. If the battery is fully charged, the PWM controller will disconnect the panel to prevent overcharge. Example picture of PWM charge controller in Figure 2.

**C. Battery**

The battery consists of one or more electrochemical cells that have the capability to store and convert chemical energy into electrical energy. There are two types of batteries which is primary batteries or disposable batteries and secondary battery or rechargeable batteries. Disposable batteries are designed to be used only once and then been discarded while rechargeable batteries are been designed to be recharged and reused for multiple times. For PV system, the

rechargeable battery is suitable since the system will store the generated electricity by charging the battery. Example of secondary batteries is lead-acid battery and lithium-ion battery. In this paper, the lead-acid battery is used due to its best benefit-cost-ratio [11].

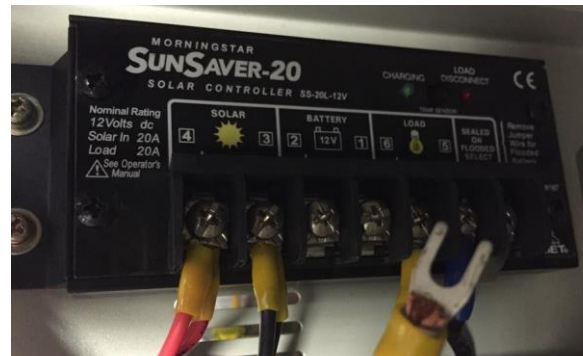

Figure 2: PWM charge controller

Lead-acid is the oldest type of rechargeable battery that was made since 1859. Generally, this lead-acid battery has a big size and heavy. It also suffers from a shorter cycle life and has Depth of Discharge (DOD) only 20% usable power. This lead-acid battery suitable for higher power with the intermittent load's application.

In charging mode, reversed electro-chemically convert the lead sulfate and water into lead dioxide (positive plate), lead (negative plate) and sulfuric acid. In discharge mode, lead sulfate, water and energy is created by the reaction of lead dioxide and lead. The charge time of this battery, normally in 12-16 hour up to 36- 48 hour for large stationery batteries. Example picture of a lead-acid battery in Figure 3.



Figure 3: Lead-acid battery

During day time, a load connected to the kit is directly been powered by the PV module. If the generated electricity is higher than the load power requirement, the excess energy will be stored in the battery. During night or when the generated electricity is lower than the load power requirement, the energy stored in the battery will be used to supply power to the load. Matching the battery to the optimum power line of the PV module is a critical action. To do that, the State of Charge (SOC) can be referred. Where if SOC approaches 100%, less energy been transferred to the battery. The efficiency of the whole system can be determined by the ratio between the energy that transferred to the battery and the energy generated by the PV modules itself provided that it was loaded at its optimum power point. This battery is one of the important components of this PV system. This will affect the efficiency of the PV module to recharge the battery and

efficiency to discharge for AC and DC appliance. This battery will store the amount of energy depending on the size and power [12].

D. Inverter

A power inverter is a device that converts DC power to AC power. DC power from the battery is converted to AC power by the inverter. In this paper, 12V DC power from the battery is converted to 220V AC power. Appliances required AC power can directly get the supply AC power from this inverter. Figure 4 shows a picture of inverter used in this paper.



Figure 4: Inverter

E. Step Down Converter

This paper is using battery size 12V with capacity 7.2Ah. Target application for DC supply is to charge handphone which only required 5V DC supply. Because of that, step down converter or Buck Converter is needed. Buck Converter is functioned to reduce 12V DC power from battery to 5V DC output power supply. A buck converter is the simplest way to reduce the voltage of a DC supply. Buck converter can be remarkably efficient where the efficiency is 95% or higher. Figure 5 shown the physical of the buck converter.

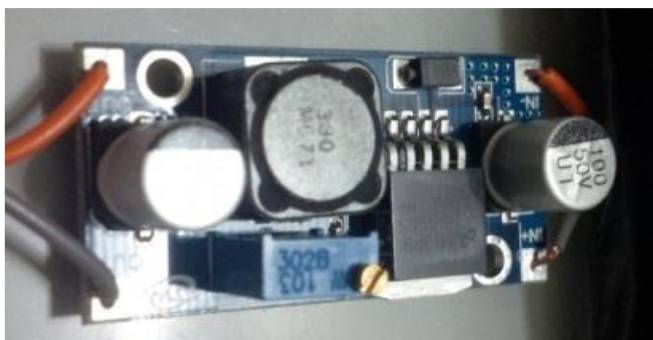

Figure 5: Step Down Converter

III. RESULT AND DISCUSSIONS

One of the objectives of this paper is to analyze the efficiency of solar panel for portable travel kit AC and DC supply. For this research, the locations that have been chosen are Bukit Beruang and Pantai Marina which are both located in Melaka, Malaysia.

A. Data Weather

Malaysia is located on the equator on the surface of the earth. On this line, Malaysia will have the same temperature throughout the year and weather remain almost the same. Although Malaysia is not experiencing climate change, there is monsoon season. Malaysia temperature depends on the distribution of average rainfall distributions. They are between 200mm and 300mm monthly. The seasonal variation of rainfall in Peninsular Malaysia is one of these three main types:

(a) Northeast wind monsoon will hit the east coast during the months of November, December and January. At this time, Peninsular Malaysia will experience the maximum rainfall. Meanwhile June and July are the driest months.

(b) Other than the southwest coast of peninsular Malaysia, there are two rainy months whereby it is a maximum of two months with minimum rainfall. Normally maximum rainfall occurs in October to November while the minimum in April to May.

(c) The pattern of rainfall that often prevails from May to August recognized as the southwest monsoon which emerged from Sumatra. October and November are the months with maximum rainfalls while February is the month with the minimum rainfall. Meanwhile, June and July have minimum rainfalls and misty.

Table 1  
Data sunrise and sunset in Melaka

Date	Sunrise	Sunset	Length
03/08/2017	07:11	19:23	12:12
-1 day	07:11	19:24	12:13
-1 week	07:11	19:24	12:13
-2 weeks	07:10	19:24	12:14
-1 months	07:08	19:23	12:15
-2 months	07:02	19:17	12:15
-3 months	07:02	19:14	12:12
-6 month	07:24	19:25	12:01

Table 1 shows data of sunrise and sunset in Melaka from August to 6 months before. From the data, it shows that the average length of time for the sun shine is about 12 hours. Without considering other factors such as rain, cloud, temperature and wind this length is long enough to generate electricity.

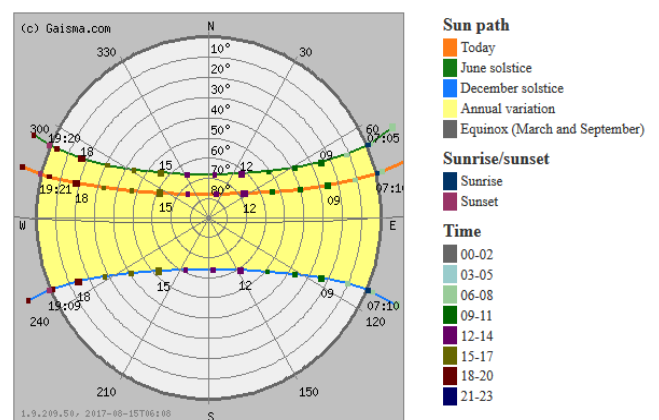

Figure 7: Sun path diagram at Melaka

Figure 7 shows sun path diagram at Melaka which indicates when the sunlight will shine your site and building throughout the year. Sun path diagram can be used to read solar azimuth and altitude for one location. They can be like



a photograph of the sky. The path of the sun at the different time of the year can then be projected onto this flattened hemisphere for any location on Earth.

**B. Solar Panel Data**

The solar panel is used to generate electricity, but it depends on the radiation and sun light. For this paper, data is taken at Bukit Beruang and Pantai Marina where these two places are good for hiker and fishing activities. Solar panel 4 watts can generate 12V with tolerance  $\pm 5\%$  when radiation in  $1000 \text{ w/m}^2$ . But in Malaysia, cloudy environment block radiation and make the required amount of radiation cannot be achieved. The radiation will affect the generation of electricity by the solar panel. Because of that, the solar panel is tilt  $45^\circ$  face to sun light to get maximum exposure as illustrate in Figure 8(a) and Figure 8(b) for data taken at Pantai Marina and Bukit Beruang respectively.

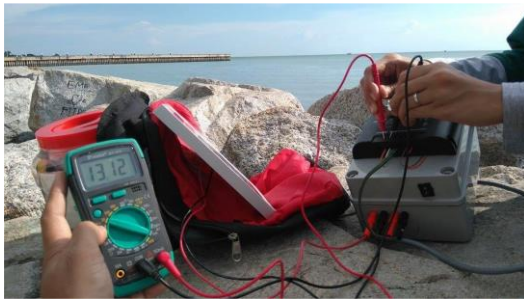

Figure 8(a): Data taken at Pantai Marina



Figure 8(b): Data taken at Bukit Beruang

Figure 9(a) and Figure 9(b) shows the graph of temperature versus time and an output voltage versus time respectively for data taken at Pantai Marina and Bukit Beruang.

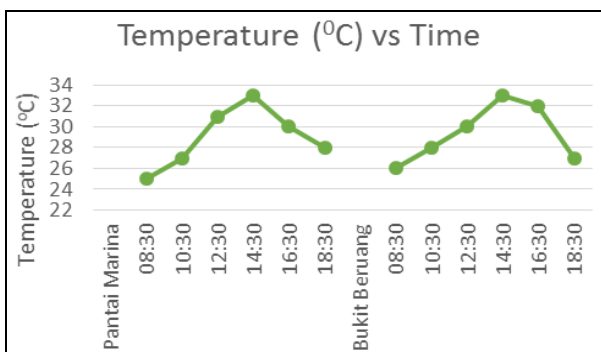

Figure 9(a): Graph temperature vs time

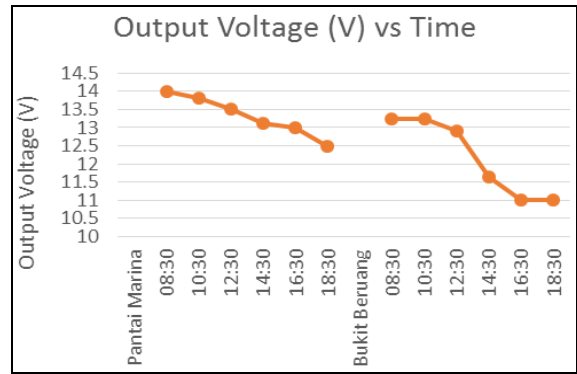

Figure 9(b): Graph output voltage vs time

**C. Data Usage for AC and DC Supply**

To test the DC supply, this paper uses the method of charging a mobile phone. Two types of mobile phone are chosen which are Blackberry Z10 and Sony Xperia Aqua M4. These phones are using battery type which is Li-ion with capacity 1800mAh and 2400mAh respectively. For charging the phone, USB cable is used to make the connection from the prototype to the mobile phone. The number of fully charge each mobile phone for a full charge battery is recorded as shown in table 2. A number of fully charge for Blackberry Z10 mobile phone is three time while for Sony Xperia Aqua M4 is two times. It is because Blackberry Z10 has a smaller capacity of battery compared to Sony Xperia Aqua M4.

Table 2  
Data charging for each phone

Type of Phone	Battery Capacity (mAh)	No of Fully Charged
Blackberry Z10	1800	3
Sony Xperia Aqua M4	2400	2

To test the AC supply, this paper use method of power up lamps with different watt. Two different watts of the lamp is used which is 15W and 35W. The total time for each lamp can be light up with fully charge battery is recorded as shown in table 3. From the table, it shows that lamp with power consumption 15W has longer time light up which is 10 hours compared to the lamp with power consumption 35W which is only 7 hours. As before, the different is due to the different in power consumption where higher power consumption needs more power.

Table 3  
Data usage of the different type of lamp

Power consumption (W)	Time (hours)
15	10
35	7

**IV. CONCLUSION**

Energy is needed to ensure electrical equipment will work accordingly. Although energy cannot be touched or observed by eyesight, but its effect can be observed, monitored and utilized. The demand for energy from solar is increasing. It generates electricity using the natural source. Since the other energy supply such as fossil fuel source become limited. From the data taken, it can be concluded that the travel kit power supply using solar panel can be

done. Although the generated power can only be used for low power appliances, it will still be significant especially at a place where electricity is limited. This solar panel can generate electricity depending on temperature and radiation of sun light. This is suitable for the tropical climate of Malaysia that have nearly consistent temperature and solar radiation throughout the year. Last but not least, PV system is the technology that is able to generate electricity with safety and ease.

#### ACKNOWLEDGMENT

The authors would like to thank UTeM for sponsoring this work under the short-term grant, UTeM, PJP/2015/FTK (5C)/S01405.

#### REFERENCES

- [1] Mose, Douglas; Mandes, Evans; and Metcalf, James (2010) "Off-Grid Photovoltaic System In A Temperate Climate Greenhouse In Virginia," *Proceedings of the Annual International Conference on Soils, Sediments, Water and Energy*: Vol. 14 , Article 4.
- [2] S. N. Kamaruzzaman, H. Abdul-Rahman, C. Wang, S. B. Abd-Karim, and T. Yee Lee, "Solar technology and building implementation in Malaysia: A national paradigm shift," *Maejo Int. J. Sci. Technol.*, vol. 6, pp. 196-215, 2012.
- [3] R. S. Sarban Singh, S. Subramaniam, S. Anas, and T. Chee Fai, "Low Power Passive Photovoltaic System Development to Assist Inconvenient Grid Connection Locations," *Energy Power Eng.*, vol. 5, pp. 411-415, 2013.
- [4] T. Stockley, K. Thanapalan, M. Bowkett and J. Williams, "Design and implementation of OCV prediction mechanism for PV-lithium ion battery system," *2014 20th International Conference on Automation and Computing*, Cranfield, 2014, pp. 49-54.
- [5] S. S. Alam, N. A. Omar, M. S. Ahmad, H.R. Siddiquei, S. M. Nor " Renewable Energy in Malaysia: Strategies and Development" *Environmental Management and Sustainable Development*. Vol. 2, No. 1, pp. 51-66, 2013.
- [6] M. K. Panjwani and G. B. Narejo, "Effect of Humidity on the Efficiency of Solar Cell (photovoltaic)," *Eng. Res. Gen. Sci.*, vol. 2, no. 4, pp. 499-503, 2014.
- [7] ShaoWei Xie and FuBing Jin, "Low power consumption solar PV Charge Controller for telemetry system," *2016 IEEE Advanced Information Management, Communicates, Electronic and Automation Control Conference (IMCEC), Xi'an*, 2016, pp. 1132-1136.
- [8] Arjy Adhara Pradhan, S.M All, Sthlt A Prajna Mishra, Subhranga Mishra, "Design of Solar Charge Controller by the use of MPPT Tracking system," *International Journal of Advanced Research in Electrical, Electronics and Instrumentation Engineering*, Vol.1 . No.4, pp. 256-261, 2013.
- [9] Gao Yun, "Study on Solar Charging Controll er", *Thesis for Master degree.Beijing Jiaotong University*, 2009.
- [10] A. Gandhar, A. Jindal, V. Srivastava and U. Agarwal, "Renewable energy sources based power converter with voltage and load angle control," *2016 Second International Innovative Applications of Computational Intelligence on Power, Energy and Controls with their Impact on Humanity (CIPECH)*, Ghaziabad, 2016, pp. 96-100.
- [11] A. França *et al.*, "A new approach to estimate SoH of lead-acid batteries used in off-grid PV system," *2016 IEEE International Telecommunications Energy Conference (INTELEC)*, Austin, TX, 2016, pp. 1-7.
- [12] IEEE Guide for Selecting, Charging, Testing, and Evaluating Lead-Acid Batteries Used in Stand-Alone Photovoltaic (PV) Systems," in *IEEE Std 1361-2014 (Revision of IEEE Std 1361-2003)* vol., no., pp.1-39, June 16 2014.