

TECHNICAL TRANSACTIONS

CZASOPISMO TECHNICZNE

MECHANICS

MECHANIKA

1-M/2013

KAMILA JAGOSZ*, KRZYSZTOF LALIK*

HUMAN ENDOPROSTHESIS DESIGN USING FINITE ELEMENT METHOD AND RAPID PROTOTYPING

PROJEKTOWANIE ENDOPROTEZY PRZY POMOCY METODY ELEMENTÓW SKOŃCZONYCH I SZYBKIEGO PROTOTYPOWANIA

Abstract

The paper presents the application of the Finite Element Method (FEM) in the analysis of the stress state in artificial hip prosthesis. A virtual model of hip prosthesis was made using computer aided design systems (CAD). A better construction of this component was developed in combination with numerical analysis. Virtual model allows manufacturing the real workpiece using Rapid Prototyping technology. The article describes also the hardware and software-aspects of the RP technology.

Keywords: CAD systems, Finite Element Method, Rapid Prototyping

Streszczenie

W artykule przedstawiono wykorzystanie metody elementów skończonych w analizie stanu naprężeń w endoprotezie stawu biodrowego. Za pomocą programów komputerowo wspomagających projektowanie (CAD) stworzono wirtualny model endoprotezy, co w połączeniu z analizą numeryczną pozwoliło na opracowanie lepszej konstrukcji elementu. Wirtualny model pozwolił na stworzenie modelu rzeczywistego dzięki wykorzystaniu technologii Rapid prototyping. W artykule zostały opisane także sprzętowe oraz softwarowe aspekty technologii szybkiego prototypowania.

Słowa kluczowe: Systemy CAD, Metoda elementów skończonych, Rapid Prototyping

* Jagosz Kamila, MSc. Krzysztof Lalik, AGH University of Science and Technology, Faculty of Mechanical Engineering and Robotics, Department of Process Control.

1. Introduction

The civilization progress has caused a significant prolongation of human life. The problems so far not present occur with aging of the population and with change of human life mode. Some of them are a variety of defects and degenerative diseases of the human skeleton system. The hip joint is one of the most perishable elements of this system. Sedentary lifestyle and low physical activity will exacerbate this situation in future. Medicine is able for a long time to help patients with degeneration of the hip joint using artificial prosthesis. The mechanical and materials engineering comes also with help. Very intensive research on new materials and constructions of the implants are carried out currently. Modern engineering and biomechanics are trying to develop the shape of the prosthesis as close as possible to the shape of the bone marrow cavity. It would allow for uniform stress distribution in prosthesis by matching it to the natural shape of the marrow cavity. Even stress transmission will result in longer hip prosthesis exploitation. It would prevent the bone osteolysis, which is the process, which due to the bone dissolving and resorption is causing bone loss.

According to official statistics about 6000 hip implantation surgeries are performed in Poland per year. Unofficial data are saying about demand even five times greater. In addition, the life of the already implanted hip joint prosthesis is 7 to 15 years, depending on its type and on the condition of the patient bone tissue. As a result, apart from people waiting for their first implantation surgery, there are also people in line waiting for reimplantation surgery. In addition, all secondary implantation surgeries are much more expensive and time consuming. The implant materials are not the cheapest. Computer-aided design can be useful for elimination all of those problems. CAD systems allow to reduce the costs of prototyping and of endurance tests of prostheses. Creation of optimal implant shape is possible using analysis based on Finite Element Method. This will reduce the size of the prosthesis, and thus reduce the consumption of expensive material. Smaller size of the prosthesis will also reduce the size of the surgical intervention in human body. It will allow for a quick return to health and will improve patients comfort.

2. Finite Element Method modeling

The prosthesis model was made in CAD system in two versions. The first version (Fig. 1a) presents the prosthesis model immediately after the surgery, when the prosthesis is attached only by two bolt screws. The second model (Fig. 1b) presents the endoprosthesis, which is conjoined with the bone marrow cavity. The difference between the models lies in the mounting conditions and explains the importance of a good prosthesis fit to the shape of the bone marrow cavity.

The model was designed based on standard ISO 7206-4:1995, which defines basic parameters and range of some dimensions of the endoprosthesis. The change suggested by the authors is located in section between the head and the mandrel of the model. This shape is different from the shape proposed by the standard. Preliminary simulations showed that the greatest stress is located in this area. Suggested change in cross-section area will result in a large increase in cross-section moment of inertia I . The results of numerical simulation

using Finite Element Method are shown in Figure 2a for the model immediately after the surgery, and in Figure 2b for the model of the prosthesis conjoined with the bone marrow cavity. Detailed image of stress distribution in fixing bond for the first model is shown in Figure 3. The solid element was used for numerical computation.

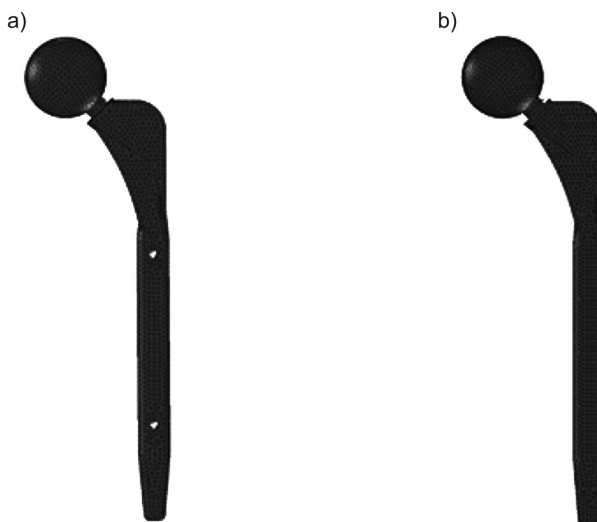

Fig. 1. 3D model of human hip joint endoprosthesis performed in SolidWorks 2011
 Rys. 1. Model 3D endoprotezy ludzkiego stawu biodrowego wykonany w programie
 SolidWorks 2011

The stress around upper hole increase significantly for the model with two fixing bolts. The boundary conditions are changed after conjoining with the marrow cavity. It reduces significantly the stresses in the prosthesis. The stress concentration in the top of mandrel is still noticeable despite of the modification in construction between the head and the mandrel of the prosthesis. The “a priori” modification of this section is not possible, since it depends on the patient bone degeneration condition. However, the shape of the mandrel branching can be individually developed after medical consultation for the patient.

The analysis was performed assuming an isotropic material, and it is assumed that the material behavior is linear and consistent with Hooke’s law. In addition, it was assumed that the change in the stiffness of the material due to the load may be excluded because of the small displacements. The judgments on the element could not be based only on the basis of data provided by even most accurate numerical analysis. Those information can be used only in conjunction with experimental data. Operational tests are necessary for the verification of the final design. CAD programs with additional packages for numerical analysis can be useful to decrease the time required to obtain the final product by reducing, but not eliminating the tests. Authors suggest therefore to performance from the virtual model a real prototype in the form of a ready foundry pattern made from model obtained from Rapid Prototyping technology.

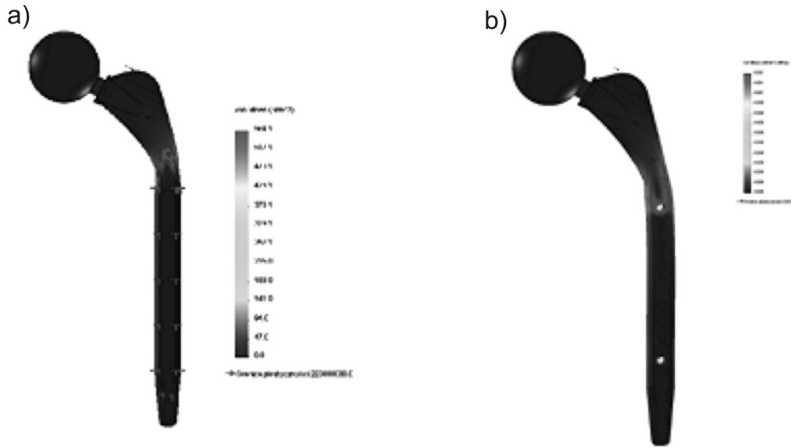

Fig. 2. Distribution of stresses in the hip joint endoprosthesis for different kinds of boundary conditions

Rys. 2. Rozkład naprężeń w endoprotezie stawu biodrowego dla różnych warunków brzegowych



Fig. 3. Detailed image of stress distribution in fixing bond

Rys. 3. Szczegółowy obraz rozkładu naprężeń w węźle mocującym

3. Virtual i Rapid Prototyping

Virtual prototyping is a technology based on virtual model testing, which allows modeling and simulation with realistic visualization. The work starts with the construction of geometrical models of designed products, and then the computer simulations are carried out. The designer is able in this way to determine whether will meet all criteria and requirements, for example – ergonomic criteria. A model observation in virtual reality allows engineers to

perceive many construction errors. Virtual prototyping of all aspects of the newly created products plays a crucial role in fast realization of the best designed product or process. Additionally, due to the fact that design is a process which has almost no limits, the VP technology allows the designer to analyze various types of solutions and enables fast and not expensive prototyping of new, often unconventional projects. It reduces also the time needed to product final market arrival, improves the quality, as well as helps to reduce the cost of its development. [1]

Virtual prototyping technique allows to transition from concept, through design in CAD system and various stages of the construction, up to virtual testing of final product. It allows approving for production a built structure, tested complete in the virtual world, using easy available engineering software. [3, 5, 7]

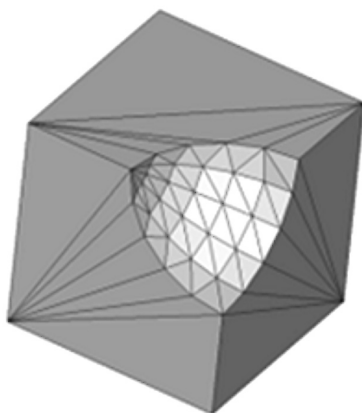

Fig. 4. 3D model surface saved in STL format [2]

Rys. 4. Powierzchnia modelu 3D zapisana w formacie STL [2]

Independently of the used method, rapid prototyping starts with creation of a 3D virtual model of the new structure in any available CAD system.[6]. In the next step, the model is transformed in the numerical process into RP appropriate data. In practice, it means converting of a 3D model to STL format (Standard Triangulation Language). This format is

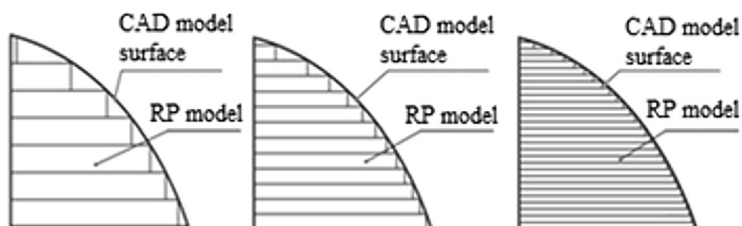

Fig. 5. Influence of film thickness for the model surface finish [2]

Rys. 5. Wpływ grubości warstwy na wykończenie powierzchni modelu [2]

an informal language of the RP technology. STL is a triangular surface mesh defined as a set of vertices, edges and triangles [4]. They are connected with each other in such a way that each edge as well vertex is common for at least two adjoining triangle in according to vertex-to-vertex rule. In other words, the grid of triangles represents approximately model surfaces described in STL format (Fig. 4.).

The next step after creating a triangle model mesh is the transversal slitting to even thin layers (XY plane) [8, 9]. The thickness of the layers depends on the accuracy which a designer wants to get and as well on the type of used RP method (Fig. 5.).

The model prepared in this way is sent to machine, which is a 3D RepRap printer, and a prototype of the designed item is formed.

4. Production of the prototype

Foundry model of the human hip joint endoprosthesis was manufactured using a 3D RepRap printer, designed in Department of Process Control UST AGH (Fig. 6).

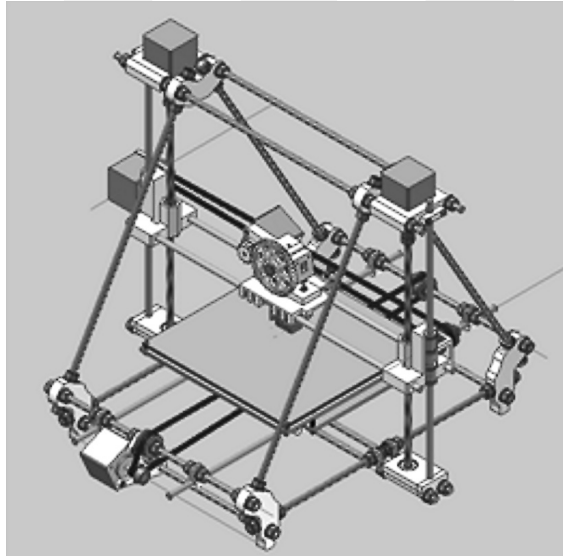

Fig. 6. The assembly of the 3D RepRap printer

Rys. 6. Rysunek złożeniowy drukarki 3D typu RepRap

Basic parameters of the print can be entered using the Slic3r – it is a dedicated software for the 3D printers. They are fundamental to the quality of the prints. Couple printouts for different printing configuration parameters are presented in Figure 7 The left prosthesis was performed with 40% fill density and layer thickness of 1 mm. Its manufacture time was about 6 minutes. The left prosthesis was performed with 100% fill density and layer thickness of 0.3 mm. Its. The execution time was 1 hour and 12 minutes.

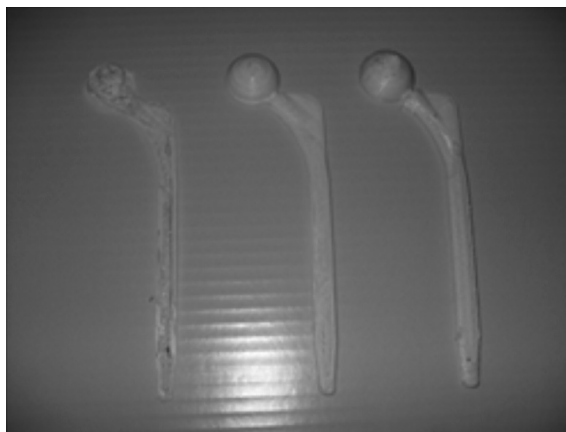

Fig. 7. Human hip joint endoprosthesis printout for various configurations of printing parameters

Rys. 7. Widok modeli endoprotezy stawu biodrowego w zależności od konfiguracji parametrów drukowania

Subsequent steps of foundry model production are showed in Figure 8. There are possibilities to print the hip joint endoprosthesis foundry model together with casting gating system, which would accelerate even more the production of the final metal structure.

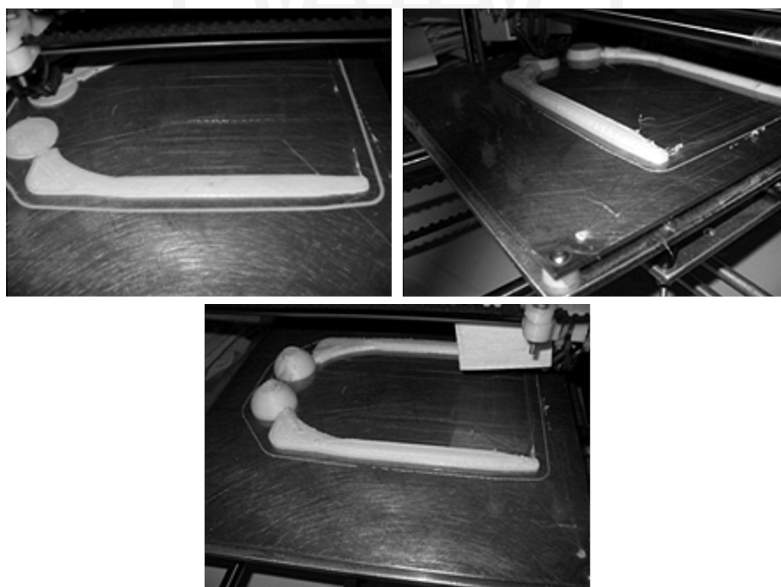

Fig. 8. The next stages of human hip joint endoprosthesis production using Rapid Prototyping technology

Rys. 8. Kolejne stadia wytwarzania endoprotezy stawu biodrowego w technologii RP

5. Conclusions

Prosthetic arthroplasty is a major surgical intervention, but in this moment, a good long term alternative solution simply does not exist. The price of hip joint prosthesis implantation is about 8 thousand dollars.. According to official data, extension of the life of hip bone endoprosthesis only for one year would result in saving over 70 million dollars per year at the current demand in Poland. However, the demand will rise. Constant improvement and development in design of implant has therefore a great importance.

This paper presents the application of CAD systems in virtual designing of the shape of the hip joint endoprosthesis. Application of the Finite Element Method (FEM) allows to show the distribution of stresses in prosthesis and thus, to virtual redesign of its shape reducing their concentration. The real casting model can be also performed using specialized software. It would help in experimental confirmation of the numerical analysis results.

Computer-aided system allows reducing the cost of manufacturing and testing of prototypes, which significantly affects the price, quality and durability of the final product. This provides to significantly enhance of patient comfort after hip joint prosthetic arthroplasty.

References

- [1] Bubicz M., *Cyfrowe czy jednak fizyczne, Projektowanie i Konstrukcje inżynierskie*, 1(01)/2007, 2007, 27-30.
- [2] Sitek M., Sacha M., *Projekt Wieloosiowego urządzenia drukującego przestrzennie do szybkiego prototypowania*, KAP AGH, 2012.
- [3] Bubicz M., „Drukowanie”...nożem?, *Przegląd współczesnych technologii szybkiego prototypowania cz. I, CADblog.pl*, 1(11)/2010, 2010, 26-32.
- [4] Bubicz M., *Raport: szybkie prototypowanie. Przegląd dostępnych rozwiązań...*, *Projektowanie i Konstrukcje inżynierskie*, 4(07)/2008, 2008, 27-30.
- [5] Budzik G., Budzik W., Magniszewski M., Pająk D., *Metody szybkiego prototypowania*, *Stal*, numer 1/2011, 2011, 78-80.
- [6] Budzik G., Pacana J., Sobolak M., *Obróbka i przygotowanie danych pod potrzeby urządzeń szybkiego prototypowania*, Rzeszów, Oficyna Wydawnicza Politechniki Rzeszowskiej, 2009.
- [7] Budzik G., Skoczylas L., *Znaczenie i przebieg inżynierii odwrotnej w procesie przygotowania produkcji*, *Ekonomika i Organizacja Przedsiębiorstwa*, 9(704)/2008, 2008, 38-40.
- [8] Gebhardt A., *Rapid Prototyping*, Monachium, Carl Hanser Verlag 2003.
- [9] Grochowiak A., *Rapid prototyping i rapid tooling*, *CADCAM Forum*, 7/2000, 2000, 23-30.