



Missouri University of Science and Technology
Scholars' Mine

Electrical and Computer Engineering Faculty
Research & Creative Works

Electrical and Computer Engineering

01 Feb 2001

A Comparison of the Dynamic Performance of FACTS with Energy Storage to a Unified Power Flow Controller

Lin Zhang

Shen Chen

Zhiping Yang

Aysen Arsoy

et. al. For a complete list of authors, see https://scholarsmine.mst.edu/ele_comeng_facwork/773

Follow this and additional works at: https://scholarsmine.mst.edu/ele_comeng_facwork

 Part of the [Electrical and Computer Engineering Commons](#)

Recommended Citation

L. Zhang et al., "A Comparison of the Dynamic Performance of FACTS with Energy Storage to a Unified Power Flow Controller," *Proceedings of the IEEE Power Engineering Society Winter Meeting, 2001 (2001, Columbus, OH)*, vol. 2, pp. 611-616, Institute of Electrical and Electronics Engineers (IEEE), Feb 2001. The definitive version is available at <https://doi.org/10.1109/PESW.2001.916919>

This Article - Conference proceedings is brought to you for free and open access by Scholars' Mine. It has been accepted for inclusion in Electrical and Computer Engineering Faculty Research & Creative Works by an authorized administrator of Scholars' Mine. This work is protected by U. S. Copyright Law. Unauthorized use including reproduction for redistribution requires the permission of the copyright holder. For more information, please contact scholarsmine@mst.edu.

A Comparison of the Dynamic Performance of FACTS with Energy Storage to a Unified Power Flow Controller

L. Zhang, C. Shen, Z. Yang, M. Crow
Electrical & Computer Engineering
University of Missouri-Rolla
Rolla, MO 65409-0040

A. Arsoy, Yilu Liu
Electrical & Computer Engineering
Virginia Polytechnic Inst. & State U.
Blacksburg, VA 24061-0111

S. Atcitty
Energy Storage Systems
Sandia National Laboratories
Albuquerque, NM 87185

ABSTRACT – The integration of an energy storage system into FACTS devices may lead to a more economical and/or flexible transmission controller. Various energy storage systems have received considerable attention in power utility applications due to their characteristics that range from rapid response, high power, high efficiency, and four-quadrant control. The enhanced performance of combined FACTS/ESS may have greater appeal to transmission service providers. Integrating an energy storage system into a FACTS device can provide dynamic decentralized active power capabilities and much needed flexibility for mitigating transmission level power flow problems. This paper presents a comprehensive comparison between the dynamic performances of a StatCom, a StatComBESS, an SSSC, an SSSC/ESS and a UPFC.

I. INTRODUCTION

In bulk power transmission systems, power electronics based controllers are frequently called Flexible AC Transmission System (FACTS) devices. The use of FACTS devices in a power system can potentially overcome limitations of the present mechanically controlled transmission system. By facilitating bulk power transfers, these flexible networks help delay or minimize the need to build more transmission lines and power plants and enable neighboring utilities and regions to economically and reliably exchange power. Although relatively new, the stature of FACTS devices within the bulk power system will continually increase as power electronic technologies improve and the restructured electric utility industry moves steadily toward a more competitive posture in which power is bought and sold as a commodity. In decentralized control of transmission systems, FACTS devices offer increased flexibility. As the vertically integrated utility structure is phased out, centralized control of the bulk power system will no longer be possible. Transmission providers will be forced to seek means of local control to address a number of potential problems such as uneven power flow through the system (loop flows), transient and dynamic instability, subsynchronous oscillations, and overvoltages and undervoltages. Several FACTS topologies have been proposed to mitigate these potential problems, but transmission service providers have been reluctant to install them, usually due to cost and lack of systematic control.

The integration of energy storage systems (ESS) into FACTS devices, however, may lead to a more economical and/or flexible transmission controller. The enhanced performance will have greater appeal to transmission service providers. The problems of uneven active power flow, transient and dynamic stability, subsynchronous oscillations, and power quality issues can be impacted more effectively by active power control. Integrating an energy storage system, such as batteries, SMES, or super-capacitors, into a FACTS device can provide dynamic decentralized active power capabilities. Power conversion systems required for ESS are similar to the power electronics topologies of FACTS devices; a combined FACTS/ESS system can have a comparable cost and provide better performance than separate stand-alone ESS or FACTS devices.

Currently there is a general lack of understanding of how to effectively incorporate ESS into existing FACTS topologies. While the FACTS/ESS combination has been proposed in theory [1], the development of FACTS/ESS combination has lagged far behind that of FACTS alone. Considerable attention has been given to developing control strategies for a variety of FACTS devices, including StatCom, the SSSC, and the UPFC, to mitigate a wide range of potential bulk power transmission problems. However, a comparable field of knowledge for FACTS/ESS control is sparse. In addition, numerous complex models for FACTS control have been proposed, but have not been experimentally verified. Therefore, this paper will discuss the enhancement of power transmission system operation by integrating a Battery Energy Storage System (BESS) into FACTS devices. Specifically, this paper will

- ◆ propose control strategies for voltage control, dynamic stability, and transmission capability improvement,
- ◆ compare simulation and experimental results of an integrated FACTS/BESS system, and
- ◆ compare the performance of different FACTS /BESS combinations.

II. INTEGRATION OF BATTERY ENERGY STORAGE WITH A STATCOM

The static synchronous compensator, or StatCom, is a shunt-connected device. The StatCom does not employ capacitor or reactor banks to produce reactive power as does the Static Var Compensator (SVC). In the StatCom, the capacitor bank is used to maintain a constant DC voltage for the voltage-source inverter operation. Common StatComs may vary from six-pulse topologies up to forty-eight-pulse topologies that consist of eight six-pulse inverters operated from a common dc link capacitor [2][3]. The displacement angle between two consecutive six-pulse inverters in a multipulse inverter configuration is $2\pi/6m$ where m is the total number of six-pulse inverters. Phase adjustments between the 6-pulse inverter groups are accomplished by the use of appropriate magnetic circuits. Using this topology, the angle of the StatCom voltage can be varied with respect to the AC system voltage. By controlling the angle, the StatCom can inject capacitive or inductive current at the system bus.

Although the ability of a StatCom to improve power system performance has been well accepted, very little information regarding its dynamic control has been published [4]. The StatCom is best suited for voltage control since it may rapidly inject or absorb reactive power to stabilize voltage excursions [2][4][5] and has been shown to perform very well in actual operation [3]. Several prototype StatCom installations are currently in operation[3][6]. The ability of the StatCom to maintain a pre-set voltage magnitude with reactive power compensation has also been shown to improve transient stability [4] and subsynchronous oscillation damping [7][8][9]. However, a combined StatCom/ESS system can provide better dynamic performance than a stand-alone StatCom. The fast, independent active and reactive power support provided by a StatCom/ESS can significantly enhance the flexibility and control of transmission and distribution systems. The integrated StatCom/ESS is shown in Figure 1.

The traditional StatCom (with no energy storage) has only two possible steady-state operating modes: inductive (lagging) and capacitive (leading). Although both the traditional StatCom output voltage magnitude and phase angle can be controlled, they cannot be independently adjusted in steady state, since the StatCom has no significant active power capability. Thus it is not possible to significantly impact both active and reactive power simultaneously. For the StatCom/ESS, the steady state operation is extended to all four quadrants. The available modes are inductive with DC charge, inductive with DC discharge, capacitive with DC charge, and capacitive with DC dis-

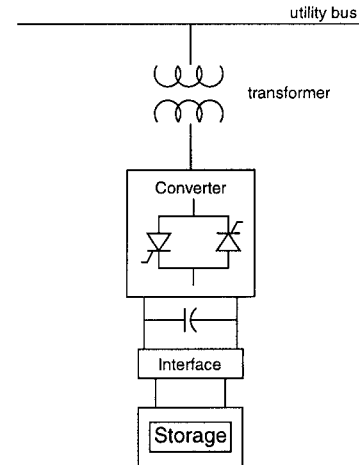

Figure 1 – Integrated StatCom with Energy Storage

charge. Due to the nature of ESS, the StatCom/ESS cannot be operated infinitely in one of the four modes (i.e., the battery cannot continuously discharge); therefore these modes represent quasi-steady-state operation. However, depending on the energy output of the battery or other ESS, the discharge/charge profile is typically sufficient to provide enough energy to stabilize the power system and maintain operation until other long-term energy sources may be brought on-line.

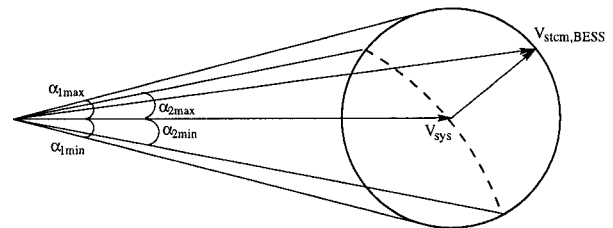

Figure 2 – StatCom/BESS Voltage Characteristics

Figure 2 shows the steady state operational voltage characteristics of the StatCom/BESS output. Note that in steady state, the output voltage of the traditional StatCom is in one dimension only, and must lie along the dashed line, whereas the output voltage of a StatCom/BESS can take on any value within the circle. This gives the StatCom/BESS an additional degree of operating freedom that provides the enhanced performance and impact. The dashed line of the traditional StatCom operational curve separates the StatCom/BESS operating region into two regions. The upper right region represents the BESS discharge area and the lower left region is the charging area. The angles α_{1max} and α_{1min} are the maximum and minimum output voltage angles of the StatCom/BESS. The angles α_{2max} and α_{2min} are the maximum and minimum output voltage angles of the traditional StatCom. These angles are dependent on the system voltage, equivalent impedance and the maximum current limit of the StatCom/BESS.

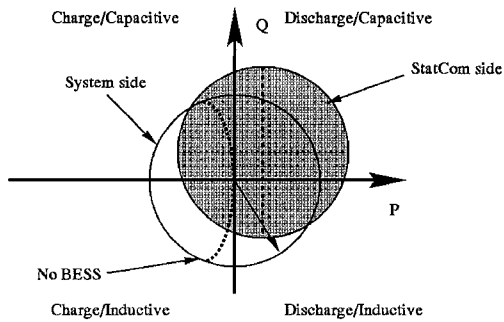

Figure 3 – StatCom/BESS Output Power Characteristics

Figure 3 illustrates the active and reactive power characteristics under constant terminal voltage. The StatCom side is the converter side of the transformer shown in Figure 1. The two circles represent the possible output power of the StatCom side (shaded region) and the system side. Note that the center of the StatCom circle is shifted from the origin by I^2Z where Z represents the equivalent impedance of the StatCom and transformer. The dashed lines represent the possible output power of the traditional StatCom. Note that on the system side of the traditional StatCom (the dashed arc), the active power is always negative to indicate that the StatCom will always draw active power from the system to compensate for any losses. Under ideal conditions, the StatCom/BESS can be operated anywhere within the circular region.

III. INTEGRATION OF BATTERY ENERGY STORAGE WITH AN SSSC

The static synchronous series compensator (SSSC) typically has the same power electronics topology as the StatCom. However, it is incorporated into the AC power system through a series coupling transformer as opposed to the shunt transformer found in the StatCom. The series transformer is used to inject an independently controlled voltage in quadrature with the line current for the purpose of increasing or decreasing the overall reactive voltage drop across the line and thereby controlling the transmitted power. In essence, the SSSC may be considered to be a controllable effective line impedance [10] much like the earlier power electronics series devices, the thyristor-switched and thyristor-controlled series compensators (TSSC and TCSC). The TSSC and TCSC must rely on the imbedded inductors and capacitors to achieve reactive power compensation, whereas the DC capacitor of the SSSC is used to maintain the DC voltage rather than as a direct reactive power source. This provides the SSSC with the ability to increase the transmitted power across the line by a fixed fraction of the maximum power, independent of the phase angle. The TSSC and TCSC can only increase the transmitted power by a fixed

percentage of that transmitted by the uncompensated line [10]. As a result of the SSSC's ability for reactive power generation or absorption, it makes the surrounding power system impervious to classical subsynchronous resonances. With an energy storage system as shown in Figure 4, effective damping of power oscillations can be achieved by modulating the series reactive compensation to increase and/or decrease the transmitted power and by concurrently injecting an alternating positive and negative real impedance in antipathy with the prevalent machine swings [10].

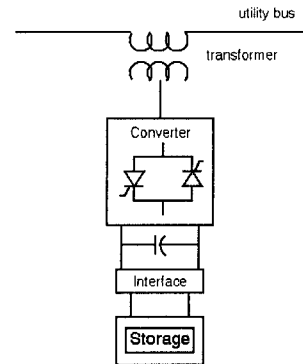

Figure 4 – Integrated SSSC with Energy Storage

IV. FACTS/BESS CONTROL

The objective of the FACTS/BESS is to maintain system performance according to some pre-set or user defined scheme. The control objective may be voltage control, power flow control for oscillation damping, or transient stability improvement. A control scheme for active and reactive power flow control has been implemented on a laboratory FACTS/BESS system.

A. Experimental FACTS/BESS System

Both StatCom and SSSC hardware set-ups have been constructed at the University of Missouri-Rolla. With funding from Sandia National Laboratories Energy Storage Systems Department, the experimental FACTS devices were interfaced with a battery set that consists of 34 VLRA super-gel batteries in two strings supplying 204 V dc. A data acquisition system was constructed to monitor the battery voltage and string currents. A signal interface board provides the digital and analog isolation and converts the current signals into voltage signals and filters the high-frequency noise. The monitoring and control system for the integrated StatCom/BESS system consists of two M5000 boards; one for data acquisition and pre-processing and the other for PWM signal generation. Similarly, two M5000 boards provide monitoring and control for the SSSC/BESS system. The A/D boards measure the

system frequency within 0.01Hz. They are also used to calculate various state variables such as P , Q , V_{RMS} , and I_{RMS} to export to the PC for the control algorithm. It also provides error detection/correction and digital filtering. The system controllers are fully programmable so that new controls can be implemented rapidly. The StatCom/BESS is rated at 3kVA and the SSSC/BESS is rated at 2.5kVA.

B. Transmission Capacity Control

The controller provides an active and reactive power command to achieve the desired system response. The controller converts the commanded powers into PWM switching commands for the FACTS device to regulate the modulation gain and angle. For optimal control of transmission capacity, it is desired to have a controller that can achieve independent active and reactive power response. To accomplish this goal, a decoupled PI controller is proposed which can produce the desired switching commands from independent active and reactive power commands.

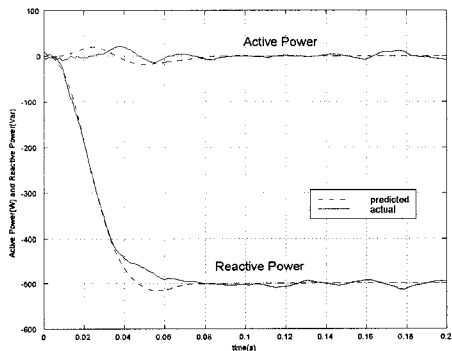

Figure 5 – Step Change in Reactive Power

The effectiveness of this control for a StatCom is illustrated in Figures 5-6, where the active and reactive powers are independently commanded to make step changes. The results of the simulated control are shown concurrently with the experimental results, where the solid lines indicate the measured power dynamics and the dashed lines indicate the predicted dynamics. In Figure 5, the reactive power is commanded to change from 0 to -0.5kVar (a step change of 0.17 per unit) while holding the active power at zero. Similarly, Figure 6 shows a 0.17 per unit step change in active power while holding the reactive power at zero. In both cases, the independent nature of the control is evident, since a commanded change in one power causes only a small response in the other. Both the active and reactive powers achieved their target values within 0.1 seconds, which is the desired response time. Also the simulated response predicts the experimental behavior very well.

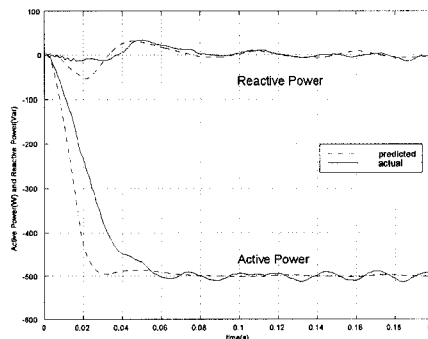

Figure 6 – Step Change in Active Power

The slight oscillation in both experimental responses is due to the imbalance of the ac system voltages. The control was developed based on the assumption of a three-phase balanced system. However, even in the case of system imbalance (which occurs often in practice), the controller responds well. The slight responses in the powers being held at zero is due to the linearized control process, since the active and reactive powers are not truly fully decoupled in the nonlinear system.

C. Control For Oscillation Damping and Voltage

The independent control of both active and reactive power of a FACTS/BESS system make it an ideal candidate for many types of power system applications. Possible applications of a FACTS/BESS include voltage and transmission capacity control, frequency regulation, oscillation damping, and dynamic stability improvement. These requirements may change based on the size and placement of the FACTS/BESS within the power system. In this section, two applications of a FACTS/BESS are presented: voltage control and oscillation damping. The system under consideration is the system shown in Figure 7 (StatCom) and 8 (SSSC) where the system data is the same as in [11]. At 0.01 seconds, one of the parallel transmission lines between buses 5 and 6 is opened. This results in a system wide drop in voltage and causes a low frequency interarea power oscillation between the two areas. The interarea oscillation exhibits a lightly-damped mode at 1.4 Hz.

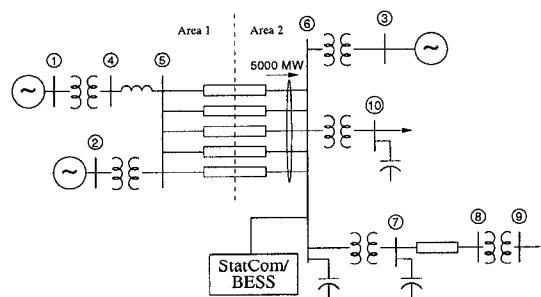

Figure 7 – Example System for Comparison of StatCom Controls

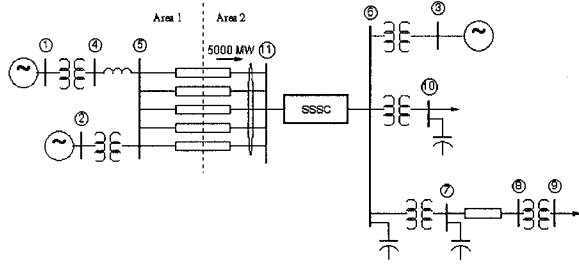

Figure 8 – Example System for Comparison of SSSC Controls

For an even comparison between controllers, the same control approach was applied for both the FACTS and the FACTS/BESS system. The active power flow was controlled using a scheme similar to the one described in the previous section. However, the FACTS output power is not set to a constant reference setting (as in the previous section) but rather is required to compensate for the sudden change in line flow. Thus, $P^* = P_{65} - P_{65, \text{scheduled}}$. Since the reference setting in this example is a “moving target,” the response time will be significantly longer than the 0.1 seconds of the previous example, which had a constant reference value.

The FACTS/BESS have two control signals with which to achieve the control objectives - the phase angle α and the modulation gain k . Therefore, the voltage control objective was assigned to the modulation gain k signal, and the oscillatory mode was assigned to phase angle α control. Conversely, the only control signal a traditional StatCom has is the phase angle α , and the only control the SSSC has is the modulation gain k . Therefore, these single signals must simultaneously achieve voltage control, and mitigation of the interarea oscillatory mode using only locally available signals for feedback. A comparison of the effectiveness of the controls is shown in Figures 9-14.

The presence of the lightly-damped oscillatory mode can be observed in the inter-area power flow waveforms shown in Figures 9-11. Immediately following the loss of one of the parallel lines, the active power flow from area 1 to area 2 drops. This sudden topology change perturbs one of the interarea oscillation modes, resulting in a lightly-damped active power oscillation on the remaining lines. However, since the total power demand and generation in the system do not change, the power flow from area 1 to area 2 will return to the scheduled value over time. To fully mitigate the resulting oscillations, the low frequency oscillatory mode must be sufficiently damped by the FACTS controllers. Note that in both power and voltage cases, the StatCom/BESS is more effective than the StatCom and the SSSC/BESS is more

effective than the SSSC. This is due to the additional degree of freedom in control and the presence of active power capabilities, especially in the oscillation damping control. Since the FACTS/BESS have two degrees of control freedom, both control objectives can be met independently, whereas the StatCom and SSSC control must be optimized to achieve both the oscillation damping and the voltage control objectives with a single input. Both the StatCom/BESS and SSSC/BESS also exhibit superior performance to the UPFC shown in Figure 11.

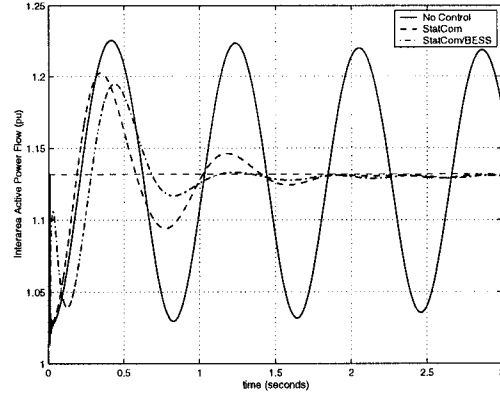

Figure 9 – Active Power Flow Between Areas (-no control, -- StatCom, -.- StatCom/BESS)

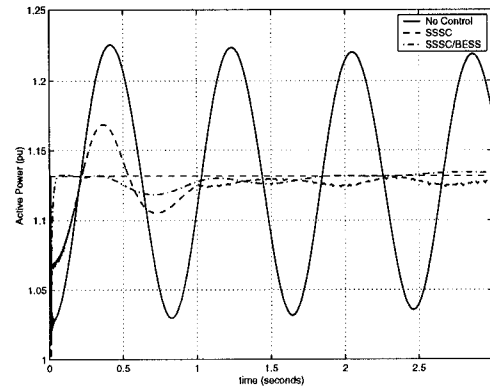

Figure 10 – Active Power Flow Between Areas (-no control, -- SSSC, -.- SSSC/BESS)

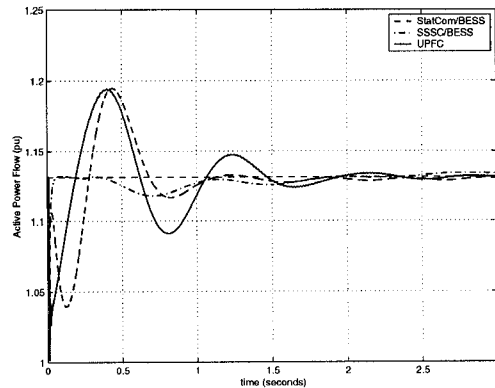

Figure 11 – Active Power Flow Between Areas (-UPFC, -- StatCom/BESS, -.- SSSC/BESS)

Figures 12-14 show the voltage at Bus 6 at the end of the parallel transmission lines. Both the StatCom and StatCom/BESS are effective in maintaining the voltage at the reference voltage setting, but the StatCom/BESS is able to achieve nearly constant voltage in approximately one second, whereas the StatCom takes nearly three seconds. The SSSC is unable to achieve the required voltage setting. The SSSC/BESS achieves the desired voltage in roughly three seconds. The UPFC response shown in Figure 14 exhibits a large voltage excursion compared with the StatCom/BESS, but does have better performance than the SSSC/BESS.

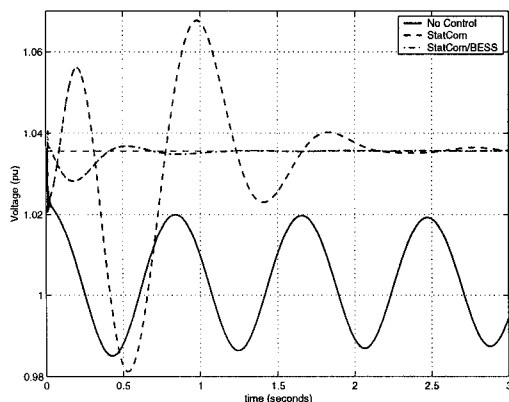

Figure 14 – Voltage at Area 2 Bus (- no control, -- StatCom, -.- StatCom/BESS)

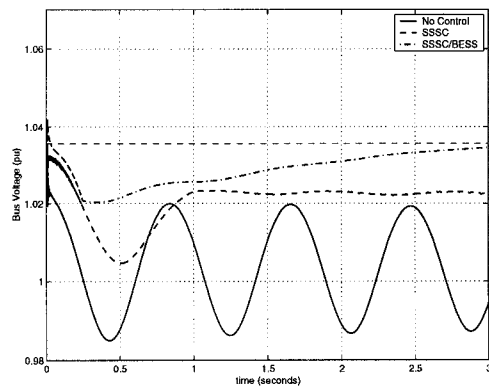

Figure 15 – Voltage at Area 2 Bus (- no control, -- SSSC, -.- SSSC/BESS)

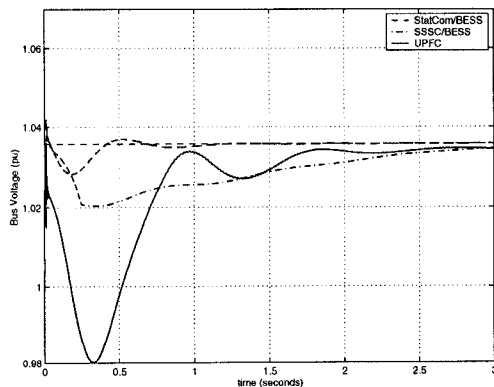

Figure 16 – Voltage at Area 2 Bus (- UPFC, -- StatCom/BESS, -.- SSSC/BESS)

V. CONCLUSIONS

These preliminary results firmly establish the viability of using FACTS/BESS to enhance bulk power system operation. Several controls were proposed that have been shown via simulation and experimental verification to be effective in transmission capacity control, voltage control, and oscillation damping. The FACTS/BESS exhibits increased flexibility over the traditional FACTS with improved damping capabilities due to the additional degree of control freedom provided by the active power capabilities. Both FACTS/BESS exhibit superior performance over the UPFC as well.

VI. ACKNOWLEDGEMENTS

The authors gratefully acknowledge the financial support of Sandia National Laboratories under BD-0071D, and the University of Missouri-Rolla Intelligent Systems Center.

REFERENCES

- [1] IEEE Power Engineering Society FACTS Application Task Force, *FACTS Applications*, IEEE Publication 96TP116-0, 1996.
- [2] C. Schauder, et. al., "Development of a ± 100 MVAR Static Condenser for Voltage Control of Transmission Systems," *IEEE Transactions on Power Delivery*, vol. 10, no. 3, July 1995.
- [3] C. Schauder, et. al., "Operation of ± 100 MVAR TVA StatCom," *IEEE Transactions on Power Delivery*, vol. 12, no. 4, October 1997.
- [4] P. W. Lehn, M. R. Iravani, "Experimental Evaluation of StatCom Closed Loop Dynamics," *IEEE Transactions on Power Delivery*, vol. 13, no. 4, October 1998.
- [5] P. Rao, M. L. Crow, Z. Yang, "StatCom Control for Power System Voltage Control Applications," *IEEE Transactions on Power Delivery*, PE-294-PRD (to appear).
- [6] C. Schauder, et. al., "AEP UPFC project: Installation, Commissioning and Operation of the ± 160 MVA StatCom (phase I)," *IEEE Transactions on Power Delivery*, vol. 13, no. 4, October 1998.
- [7] K. V. Patil, et. al., "Application of StatCom for Damping Torsional Oscillations in Series Compensated AC Systems," *IEEE Transactions on Energy Conversion*, vol. 13, no. 3, September 1998.
- [8] B. Han, G. Karady, J. Park, S. Moon, "Interaction Analysis Model for Transmission Static Compensator with EMT," *IEEE Transactions on Power Delivery*, vol. 13, no. 4, October 1998.
- [9] R. Koessler, B. Fardanesh, M. Henderson, R. Adapa, "Feasibility Studies for StatCom Application in New York State," in *FACTS Applications*, IEEE Publication 96TP116-0, pp. 8.52-8.58, 1996.
- [10] L. Gyugyi, C. Schauder, K. K. Sen, "Static Synchronous Series Compensator: A Solid-State Approach to the Series Compensation of Transmission Lines," *IEEE Transactions on Power Delivery*, vol. 12, no. 1, January 1997.
- [11] C. W. Taylor, *Power System Voltage Stability*, McGraw-Hill, New York, 1994.