



Missouri University of Science and Technology  
Scholars' Mine

---

International Specialty Conference on Cold-Formed Steel Structures

(2008) - 19th International Specialty Conference on Cold-Formed Steel Structures

---

Oct 14th, 12:00 AM

## Strength of Arc Spot Welds Made in Single and Multiple Steel Sheets

Gregory L. Snow

Samuel Easterling

Follow this and additional works at: <https://scholarsmine.mst.edu/isccss>

 Part of the [Structural Engineering Commons](#)

---

### Recommended Citation

Snow, Gregory L. and Easterling, Samuel, "Strength of Arc Spot Welds Made in Single and Multiple Steel Sheets" (2008). *International Specialty Conference on Cold-Formed Steel Structures*. 9.

<https://scholarsmine.mst.edu/isccss/19iccfss/19iccfss-session9/9>

This Article - Conference proceedings is brought to you for free and open access by Scholars' Mine. It has been accepted for inclusion in International Specialty Conference on Cold-Formed Steel Structures by an authorized administrator of Scholars' Mine. This work is protected by U. S. Copyright Law. Unauthorized use including reproduction for redistribution requires the permission of the copyright holder. For more information, please contact [scholarsmine@mst.edu](mailto:scholarsmine@mst.edu).

## **Strength of Arc Spot Welds made in Single and Multiple Steel Sheets**

Gregory L. Snow<sup>1</sup> and W. Samuel Easterling<sup>2</sup>

### **Abstract**

The primary focus of this research was to investigate how arc spot welding is affected by arc time (flash time). Weld sizes of 3/4 in. and 5/8 in. nominal diameter were formed using three different arc times (full-time, 2/3-time and 1/3-time). Each weld was formed in a single-, double-, or quadruple-layer of sheet steel ranging from 16 gauge (0.057 in.) to 22 gauge (0.028 in.) in thickness. Test results include weld dimensions determined from weld sectioning, weld shear strengths and comparisons made with the 2001 AISI Specification.

### **1. Introduction**

There are several methods for attaching cold-formed steel roof deck to structural steel in use today. Perhaps the most common means of attachment is through the use of arc spot welding. Arc spot welds are produced by striking an arc on the upper sheet, forcing a hole to form, while the lower unit is raised to fusion temperature. With the attainment of proper temperature, the electrode is moved in a circular pattern until the hole is filled and fusion attained on the arc-puddle perimeter (Luttrell, 2004).

Arc spot weld shear strength equations currently in use by the 2001 AISI Specification are based on research conducted at Cornell University by Teoman Pekoz and William McGuire (1980) and by Omer Blodgett (1978) of the Lincoln Electric Co. The research showed that as long as adequate end and edge distances are provided, arc spot welds will fail under either weld shear failure or sheet tear failure. Of the 126 arc spot welds tested by Pekoz and McGuire, 31

---

<sup>1</sup>Graduate Student, Virginia Tech, Blacksburg, Virginia

<sup>2</sup>Professor, Virginia Tech, Blacksburg, Virginia

failed in weld shear failure. Many of these 31 failures contained substantial pitting and porosity (Pekoz & McGuire, 1980). The area of weld remaining after each failure was determined and equations used to predict the effective diameter and shear strength of the weld were developed. These equations are both used by the 2001 AISI Specification and are listed in this document as Equations 1 and 2.

$$d_e = 0.7d - 1.5t \quad (\text{Eq 1})$$

$$Pu = \left( \frac{\pi \cdot d_e^2}{4} \right) \cdot \left( \frac{3 \cdot F_{xx}}{4} \right) \quad (\text{Eq 2})$$

Where:  
d = The visual diameter  
t = The total sheet steel thickness  
F<sub>xx</sub> = The weld tensile strength

The equations used to predict the sheet tear failure mode were first developed analytically by Blodgett (1978) and then later verified through the testing performed by Pekoz and McGuire (1980). Blodgett pointed out that the stress in the material is a tensile stress at the leading edge, becoming a shear stress along the sides, and eventually becoming a compressive stress at the trailing edge of the weld (Yu, 2000). Blodgett also observed that when the average diameter to sheet steel ratio was large, the sheet would buckle behind the compression side of the weld during failure, providing little resistance to any sort of movement. Using this information, Blodgett developed Equations 3 and 4. Pekoz and McGuire (1980) later developed a transition equation, Equation 5, based on their research. All of these equations are used by the 2001 AISI Specification for estimating the ability of arc spot welds to resist sheet tear failure.

$$\text{For } \frac{d_a}{t} < 0.815 \sqrt{\frac{E}{F_u}}$$

$$Pu = 2.20t \cdot d_a \cdot F_u \quad (\text{Eq 3})$$

$$\text{For } \frac{d_a}{t} \geq 1.397 \sqrt{\frac{E}{F_u}}$$

$$Pu = 1.40t \cdot d_a \cdot F_u \quad (\text{Eq 4})$$

$$\text{For } 0.815 \sqrt{\frac{E}{F_u}} \leq \frac{d_a}{t} \leq 1.397 \sqrt{\frac{E}{F_u}}$$

$$Pu = 0.28 \left( 1 + \frac{960t}{d_a \sqrt{F_u}} \right) t \cdot d_a \cdot F_u \quad (\text{Eq 5})$$

Where:  $d_a$  = the average diameter = the visual diameter minus  $t$   
 $t$  = the average net sheet steel thickness  
 $F_u$  = the ultimate strength of the sheet steel

The performance of arc spot welds subjected to shear in typical laboratory conditions is generally well documented and well understood. Time constraints imposed by the construction schedule, however, often cause welds made in the field to be produced in a fraction of the time spent in the laboratory. The primary objective of this research was to document how arc time effects weld dimensions, weld penetration and weld shear strength in an effort to better understand the behavior of arc spot welds as they are created in today's construction industry. Comparisons were made between the observed dimensions and shear strength and those estimated using the 2001 AISI Specification.

## 2. Test Setup

### 2.1 Summary of Test Matrix

A research study was established at Virginia Tech in which 155 arc spot weld specimens were tested to determine their shear strength, dimensions, and penetration. The test matrix used in the research encompassed a broad variety of weld sizes, arc times, sheet steel thicknesses and sheet steel layers, so as to gain insight into how arc spot welds behave in a wide range of welding scenarios.

Tests were performed on both 3/4 in. and 5/8 in. nominal diameter welds, all formed using a 1/8 in. diameter E6010 electrode. Current settings varied between 105 and 200 amps, depending on the thickness of the sheet steel being attached. The sheet steel used for each specimen was ASTM A653 Grade 33 galvanized sheet steel, which was arranged in single-, double-, and quadruple-layers. The thicknesses of sheet steel included 16, 18, 20, and 22 gauge material.

Every unique combination of nominal weld size, sheet steel thickness and layer arrangement included three test series, each utilizing a distinct arc time. The first series tested was always the full-time series of welds. Each full-time series was comprised of a minimum of five specimens with two arc spot welds per specimen. The time required for making each weld and the current setting (burn off rate) used were both determined by an AWS certified welder such that the weld cross sectional dimensions were consistent with those required by the 2001 AISI Specification. This arc time was then recorded using a standard stop watch and averaged for each of the minimum ten welds in every full-time series.

The second and third test series consisted of 2/3-time welds and 1/3-time welds, respectively. The time used by the welder to complete every 2/3-time weld was limited to two-thirds of the average time used to complete a full-time weld with the same combination of nominal weld size, sheet steel thickness and layer arrangement. Similarly, the time allotted for 1/3-time welds was limited to one-third of the average time used to complete a full-time weld.

## **2.2 Lap Shear Tests**

As illustrated in Figure 2-1, each lap-shear test specimen consisted of two arc spot welds, two hot-rolled steel flat bars, and either a single-, double-, or quadruple-layer of ASTM A653 Grade 33 galvanized sheet steel. The 2.5 in. end distance and 1.5 in. edge distances used comply with section E2.2.1 of the 2001 AISI Specification for preventing tear out and net section failure of the connection.

A minimum of three specimens from every test series were loaded in shear beyond their ultimate load, so as to gain an accurate representation of the arc spot weld behavior. If any of the specimen's shear strength deviated by over ten percent from the mean strength, an additional specimen was tested.

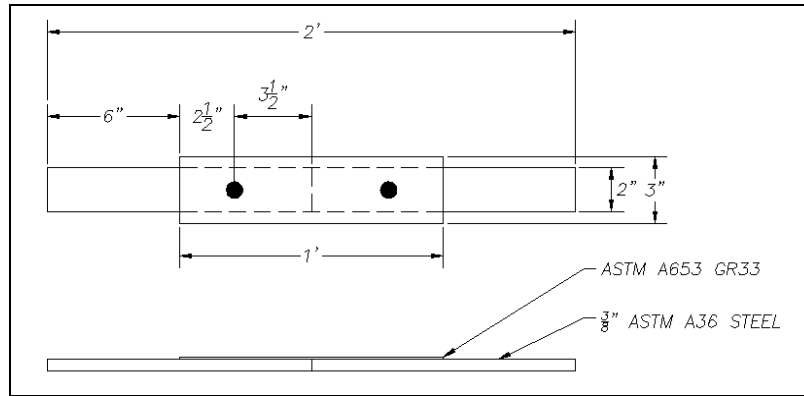

Figure 2-1: Test Specimen Configuration

### 2.3 Specimen Sectioning

Weld sectioning was performed on every test series to document weld dimensions and weld penetration. The weld dimensions that were recorded included the average diameter (the diameter of the weld at a location halfway through the sheet steel thickness) and the effective diameter (the diameter of the weld located at the top of the hot-rolled steel).

A single weld was sectioned from every full-time series and three welds were sectioned from every 2/3-time and 1/3-time series. Sectioning of the full-time series weld always occurred directly after the first full-time specimen was welded. If the specimen met the minimum dimensional requirements of the 2001 AISI Specification, the welder would continue constructing specimens using the same current setting. If the specimen did not meet the minimum AISI dimensional requirements, it would be discarded and the welder would construct another specimen after adjusting the current setting.

## 3. Results

### 3.1 Arc Time Results

Every full-time series was comprised of five specimens, each with two welds. The times spent making these ten welds were recorded and averaged. 2/3 and 1/3 of this average were then used as the time cutoffs for the 2/3-time and 1/3-time series, respectively. Figure 3-1 displays the arc times used to form both 3/4 in. and 5/8 in. diameter full-time welds. Full-time 3/4 in. welds took an average of approximately 12.8 seconds to form while full-time 5/8 in. welds took an average of approximately 8.1 seconds to form.

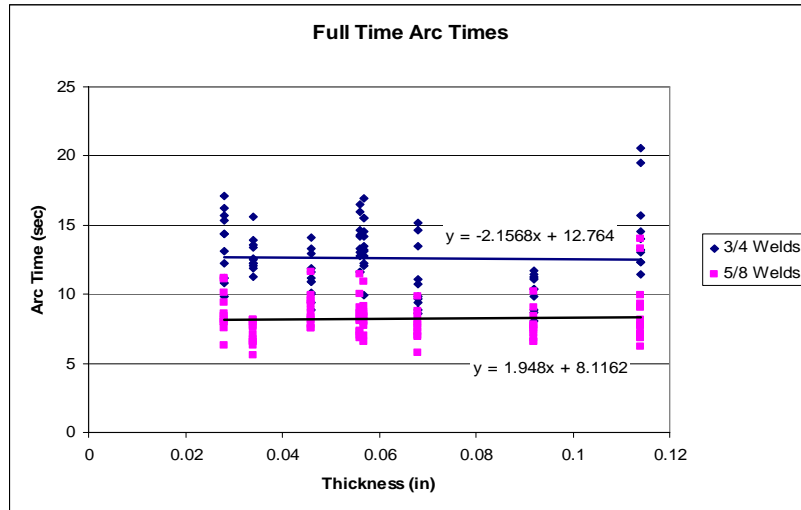

Figure 3-1: Arc Times for full-time Welds

### 3.2 Weld Sectioning Results

Every test series indicated a direct correlation between the weld dimensions and arc time regardless of the thickness of the sheet steel or the number of layers being tested. It was discovered while welding the 2/3 and 1/3-time series welds that the welder had to adjust his technique to form a visual diameter as consistent as possible with the nominal weld diameter. This adjustment was to form a smaller hole while initially burning through the sheet steel. The time saved burning a smaller hole allowed the welder to spend more time on the crown of the weld, which includes both the visual and average diameter.

The majority of 2/3-time welds tended to have visual and average diameters similar to those seen in full-time welds. However, because of the smaller initial hole in the sheet steel, they also tended to have smaller effective diameters. Full-time welds had visual diameters that were an average of 7 percent higher than those measured in the 2/3-time weld series. Effective diameters however, were an average of 22 percent higher in full-time welds. Figures 3-2 and 3-3 illustrate the difference between the full-time, 2/3-time and 1/3-time weld diameters. Note in Figure 3-2 that the diameter,  $d$ , is a nominal value (e.g. 5/8 in. or 3/4 in.), while all values of " $d$ " ( $d$ ,  $d_a$ ,  $d_e$ ) in Figure 3-3 represent actual or measured values.

Despite saving time by starting with a smaller initial hole, most of the 1/3-time welds were found to be considerably undersized. The smaller initial hole meant that the effective diameter was undersized by an average of 36 percent when compared to full-time welds, while the visual diameter was undersized by an average of 21 percent.

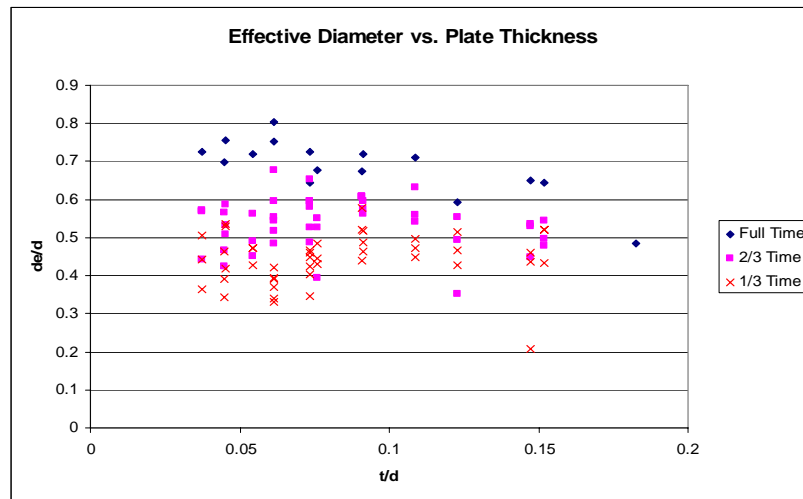

Figure 3-2: Measured Effective Weld Diameters

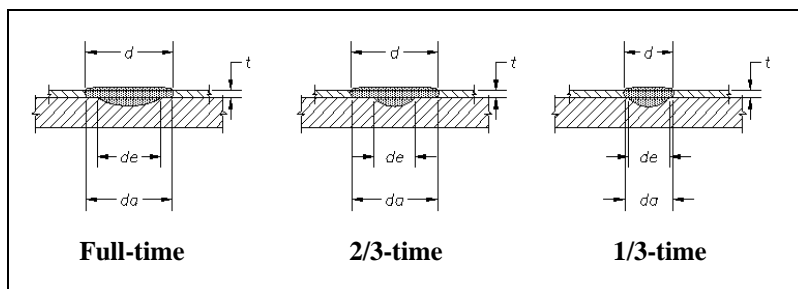

Figure 3-3: Common Weld Cross Sections

During the weld sectioning portion of the evaluations, it was found that some welds could not be satisfactorily created in certain layer configurations. When 5/8 in. welds were attempted in 16 gauge double layer conditions, three specimens had insufficient penetration and failed while sectioning. In an



attempt to remedy the situation, the current was increased. Increasing the current however, also increased the initial hole, making it impossible to create any weld smaller than 3/4 in. in diameter. For this reason only the full-time series of 5/8 in. welds were tested for the 16 gauge double-layer configuration. Similarly, none of the four-layer configurations showed sufficient penetration into the structural steel underneath. The lack of penetration was a result of too much heat being absorbed by the sheet steel and layers of air between sheets. With the current already set at 200 amps (beyond the limit for a 1/8 in. diameter electrode), it was determined that neither a 5/8 in. or 3/4 in. diameter arc spot weld could be sufficiently formed through four layers of sheet steel. It should also be noted that AWS will not certify welders to form arc spot welds through more than two layers of sheet steel.

### **3.3 Weld Sectioning Results Compared with 2001 AISI Specification**

Using the measured visual diameters and section E2.2.1 of the 2001 AISI Specification, calculated average diameters were determined. The calculated average diameters were then compared with the measured average diameters obtained during the weld sectioning tests. Figure 3-4 illustrates the ratio of measured to calculated average diameters for full-time, 2/3-time and 1/3-time welds. Full-time welds had the lowest average ratio at 0.91 followed by 2/3-time welds at 0.92 and then by 1/3-time welds at 0.94. Standard deviation values for full-time, 2/3-time and 1/3-time welds were 0.08, 0.06 and 0.10, respectively. The relatively low standard deviation and ratios close to 1.0 suggest that the 2001 AISI Specification adequately predicts average diameters for both full-time and reduced time welds, given the known value of the visible diameter.

The effective diameters of all welds were evaluated using a process similar to the one used for average diameters. Using measured visual diameters and E2.2.1 of the 2001 AISI Specification, calculated effective diameters were determined for each sectioned specimen. Next, effective diameters measured during the weld sectioning procedure were compared to the calculated values. Figure 3-5 illustrates the differences between the measured and calculated values for full-time, 2/3-time and 1/3-time weld effective diameters. The measured to calculated effective diameter ratio for full-time welds averaged 1.3 for both 3/4 in. and 5/8 in. welds with a standard deviation of 0.11, indicating that the calculated values were slightly conservative. The effective diameter ratios for 2/3-time welds averaged approximately 1.0 with a standard deviation of 0.13 for both 3/4 in. and 5/8 in. welds. The value of 1.0 indicates that the measured effective diameters are consistent with those calculated using the 2001 AISI Specification, and are also slightly less than the ratio observed in full-time

welds. The effective diameter ratio varied substantially more for 1/3-time welds than it did for either the full-time or 2/3-time welds. Although the average ratio was close to even at 1.1, the standard deviation increased to 0.26.

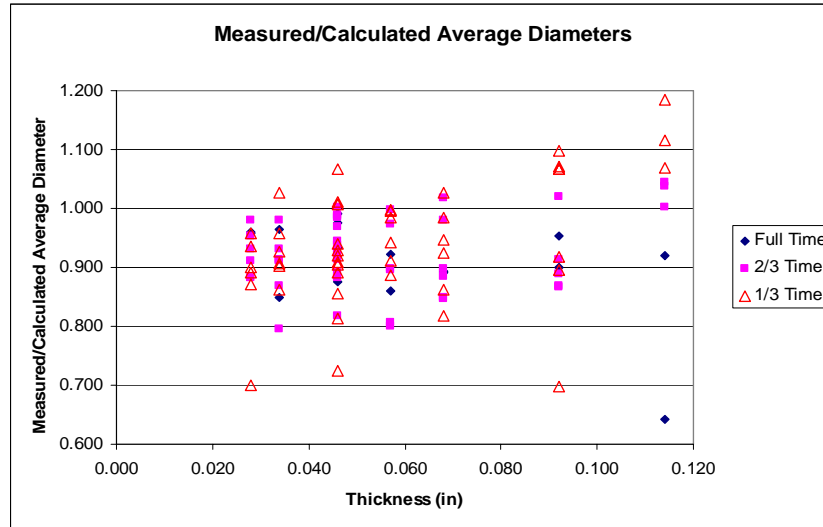

Figure 3-4: Measured/Calculated Average Diameters

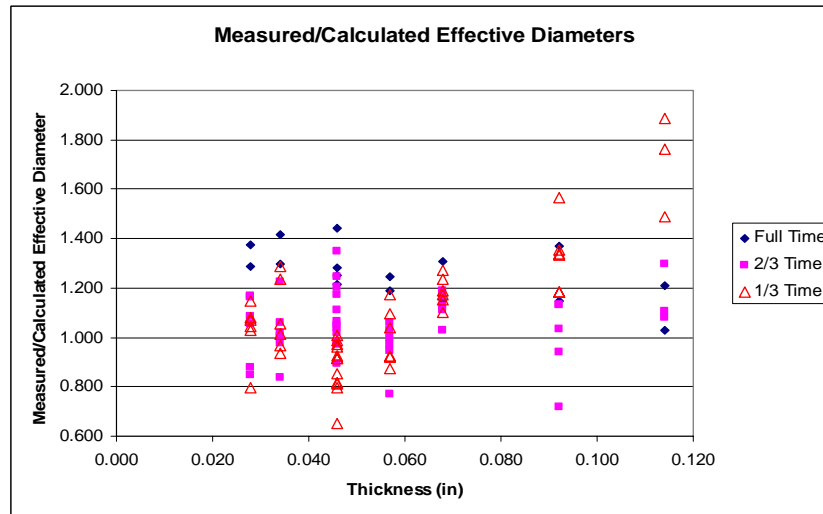

Figure 3-5: Measured/Calculated Effective Diameters

### 3.4 Weld Shear Strength Results

Along with impacting arc spot weld dimensions, arc time also had a significant influence on weld shear strength. As Figures 3-6 through 3-9 indicate, full-time welds were consistently stronger than both 2/3-time and 1/3-time welds, regardless of the thickness of the sheet steel or the nominal weld size. Overall, full-time welds were an average of 11 percent stronger than 2/3-time welds and 44 percent stronger than 1/3-time welds.

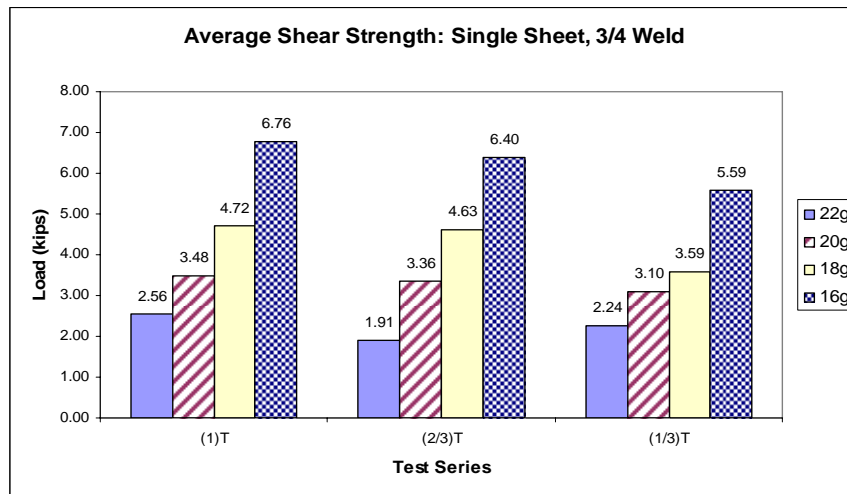

Figure 3-6: Average Shear Strength of 3/4 in. Welds in Single Sheets

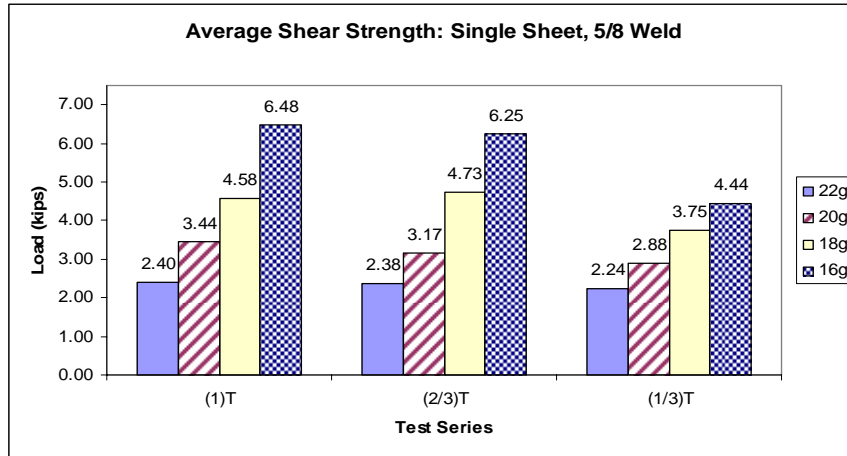

Figure 3-7: Average Shear Strength of 5/8 in. Welds in Single Sheets

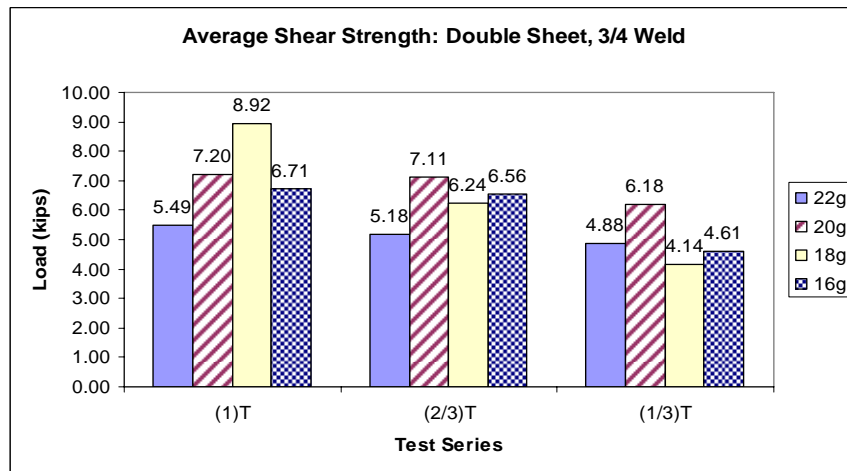

Figure 3-8: Average Shear Strength of 3/4 in. Welds in Double Sheets

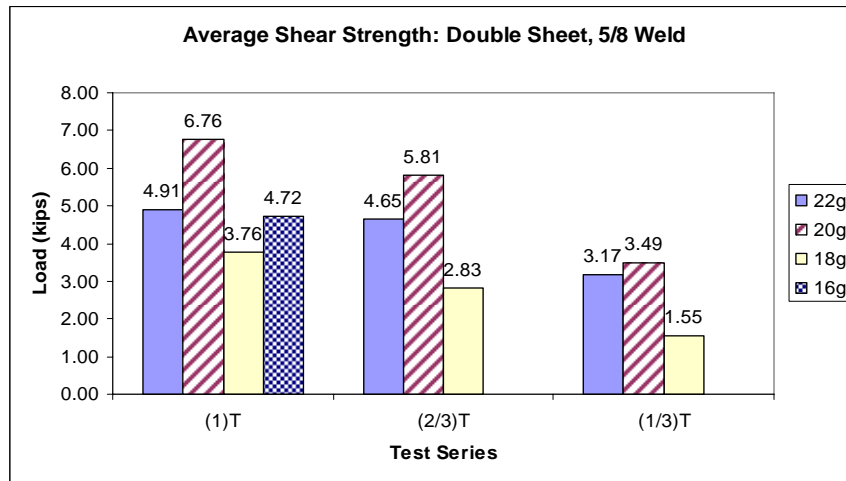

Figure 3-9: Average Shear Strength of 5/8 in. Welds in Double Sheets

### 3.5 Weld Shear Strength Comparisons with the 2001 AISI Specification

Although considerable shear strength differences were observed between full-time, 2/3-time and 1/3-time welds, each difference was proportional to the overall weld size. Full-time welds were the strongest because they were consistently larger in diameter than either the 2/3-time or 1/3-time welds. This reduced strength was sufficiently predicted by the equations given in section E2.2.1 of the 2001 AISI Specification, provided that the measured visual diameter of the reduced-time welds was used in the equations. Conversely, if the nominal visual diameter were to be used, the equations would have over estimated the shear strength of each reduced-time arc spot weld. For full-time welds, the average ratio of measured to calculated shear strength was 1.31 with a standard deviation of 0.26. The 2/3-time welds had an average ratio and a standard deviation of 1.25 and 0.26, respectively, and 1/3-time welds had an average ratio of 1.39 and a standard deviation of 1.56.

## 4. Conclusions

### 4.1 Weld Arc Time

- The three variables having the greatest influence on weld arc time were sheet steel thickness, current setting and weld size. A greater thickness of sheet steel requires more arc time than a thinner sheet for a given current setting and weld size. Higher current settings form larger welds

in a smaller amount of time. And smaller weld sizes generally take less time to form than larger weld sizes.

- Tests show that the time required to form full-time arc spot welds varies little with respect to the sheet steel thickness. This near constant behavior can be attributed to higher currents being used in thicker steel sheets. Because thicker sheets increase required arc time and higher current settings decrease it, the two essentially offset each other, leaving weld size as the only variable to have an effect on the required arc time.
- Tests indicate that the average time required to form a 3/4 in. weld is 12.8 seconds and that the average time required to form a 5/8 in. weld is 8.1 seconds.

#### **4.2 Weld Size and Penetration**

- Arc time has a significant impact on the overall size of a given weld. When the current setting and the electrode type are held constant, a reduction in arc time will always result in a smaller weld being formed, often far less than the intended nominal size. Measured visual diameters were an average of 7 percent smaller in 2/3-time welds and 21 percent smaller in 1/3-time welds than those seen in full-time welds.
- Specimen sectioning indicated that penetration is not directly affected by weld arc time. If the current setting is properly set for the amount of sheet steel being attached, proper penetration can be achieved.
- Every quadruple-layer specimen had unsatisfactory penetration into the supporting hot rolled steel. The sum thicknesses of the sheet steel together with the added layers of air and galvanized coatings all drew too much current away from the electrode to adequately fuse with the hot rolled steel.

#### **4.3 Comparisons between Measured Dimensions and the 2001 AISI Specification**

- Although reducing the weld arc time significantly reduces the overall weld size, it has very little effect on the basic weld shape. Both 2/3-time and 1/3-time welds have approximately the same visual diameter to average diameter and visual diameter to effective diameter ratios as

those observed in full-time welds. Using the measured visual diameter, comparisons were made between the measured average and effective diameters and those calculated using the 2001 AISI specification. The comparisons prove that the specification adequately estimates average and effective weld diameters regardless of arc time, given a known visual diameter.

#### **4.4 Weld Shear Strength**

- Arc time had a significant impact on weld strength. Full-time welds were an average of 11 percent stronger than 2/3-time welds and 44 percent stronger than 1/3-time welds.
- Differences between the strength of full-time welds and reduced time welds increase as the sheet steel thickness is increased. This can be attributed to the slightly smaller effective diameter noticed in reduced time welds.

#### **4.5 Comparisons between Observed Shear Strength and the 2001 AISI Specification**

- The lower shear strength observed in reduced time welds is directly proportional to the decreased size of the welds. Using the measured visual diameter and not the nominal diameter, the 2001 AISI specification satisfactorily estimates the strength of full-time welds, 2/3-time welds, and 1/3-time welds.

### **5. Recommendations**

#### **5.1 Requirements for Weld Arc Time**

This research has proven that arc time has a tremendous influence on arc spot weld shear strength. It is therefore imperative that measures be taken to insure welds formed in the field are completed using the proper arc time.

Currently, welders must be certified at the beginning of each project they undertake that involves deck welding. The welder must form the weld using the same exact electrode and current setting that he/she will be using on the remainder of the project. This weld is then inspected by an AWS certified professional who deems the quality of the weld to be sufficient or insufficient. Provided the weld is sufficient, the welder is allowed to proceed with welding arc spot welds for the project. The chief recommendation concerning the certification process is that it be modified to include arc time. This would give

the welder three items to hold constant; the electrode, the current setting and the arc time (within a certain tolerance). Holding these three items constant would ensure that welds consistent in quality with the initially inspected weld are formed throughout the project.

### **5.2 Welds formed in Quadruple-Layered Sheet Steel**

The 2001 AISI Specification states that arc spot welds should not be formed in sheet steel totaling more than 0.15 in. in thickness. This research suggests that while single and double layered sheets may be satisfactorily welded up to 0.15 in. in thickness, quadruple layers can not be. Insufficient penetration was observed from welds made in quadruple layer sheets as thin as 0.112 in. (4-layers of 22 gauge). The additional layers of air and surface coatings draw too much heat from the electrode, preventing it from fusing with the supporting hot rolled steel. Due to lack of penetration, it is recommended that arc spot welding not be attempted in situations involving four or more layers of sheet steel.

## **6. References**

1. American Iron and Steel Institute, AISI (2001). "North American Specification for the Design of Cold-Formed Steel Structural Members," 2001 Edition, With 2004 Supplement, Washington D.C.
2. Blodgett, O.W. (1978). "Report on Proposed Standards for Sheet Steel Structural Welding," Proceedings, Fourth International Specialty conference on Cold formed Steel Structures, University of Missouri – Rolla.
3. Luttrell, L.D. (2004). "Diaphragm Design Manual." Third Edition. Steel Deck Institute. Fox River Grove, IL.
4. Pekoz, T. and McGuire, W. (1980). "Welding of Sheet Steel," Proceedings, Fifth International Specialty Conference on Cold-Formed Steel Structures, St. Louis, Missouri.
5. Yu, Wei-Wen (2000). Cold-Formed Steel Design. Third Edition. New York, New York: John Wiley and Sons, Inc.



