



Missouri University of Science and Technology
Scholars' Mine

International Specialty Conference on Cold-Formed Steel Structures

(2014) - 22nd International Specialty Conference on Cold-Formed Steel Structures

Nov 6th, 12:00 AM - 12:00 AM

Effect of Stressed-Skin Action on the Behaviour of Cold-Formed Steel Portal Frames

A. M. Wrzesien

James B. P. Lim

R. M. Lawson

Follow this and additional works at: <https://scholarsmine.mst.edu/isccss>

 Part of the [Structural Engineering Commons](#)

Recommended Citation

Wrzesien, A. M.; Lim, James B. P.; and Lawson, R. M., "Effect of Stressed-Skin Action on the Behaviour of Cold-Formed Steel Portal Frames" (2014). *International Specialty Conference on Cold-Formed Steel Structures*. 3.

<https://scholarsmine.mst.edu/isccss/22iccfss/session09/3>

This Article - Conference proceedings is brought to you for free and open access by Scholars' Mine. It has been accepted for inclusion in International Specialty Conference on Cold-Formed Steel Structures by an authorized administrator of Scholars' Mine. This work is protected by U. S. Copyright Law. Unauthorized use including reproduction for redistribution requires the permission of the copyright holder. For more information, please contact scholarsmine@mst.edu.

Effect of Stressed-Skin Action on the Behaviour of Cold-Formed Steel Portal Frames

A.M. Wrzesien¹, James B.P. Lim², R.M. Lawson³

Abstract

This paper describes six full-scale laboratory tests conducted on cold-formed steel portal frames buildings in order to investigate the effects of joint flexibility and stressed-skin diaphragm action. The frames used for the laboratory tests were of span of 6 m, height of 3 m and pitch of 10°; the frame spacing was 3 m. The laboratory test setup represented buildings of length of 9 m, having two gable frames and two internal frames. Tests were conducted on frames having two joint sizes, both with and without roof cladding. It was shown that as a result of stressed-skin diaphragm action, under horizontal load the bending moment at the eaves was reduced by approximately a factor of three, relative to the bare frame. It was also shown that as a result of stressed-skin action, the deflection of the internal frame reduced by 90%, and that the stiffness was independent of joint flexibility. On the other hand, owing to redistribution of bending moment from the eaves to the apex, the effect of joint flexibility was shown not to be significant on the overall failure load of the frame.

¹ PhD student, Department of Civil Engineering, University of Strathclyde, Glasgow, UK

² Senior Lecturer, Department of Civil Engineering, University of Auckland, Auckland, New Zealand

³ Professor, Department of Civil Engineering, University of Surrey, Guildford, GU2 7XH, UK.

Introduction

For portal frames with spans of up to 20 m, buildings composed entirely of cold-formed steel can be a viable alternative to conventional hot-rolled steel frames (Lim, Nethercot 2003). Uses of cold-formed steel portal frames include, light industrial, sports and agricultural buildings. In such light-weight steel portal frames, channel-sections are used for the column and rafter members, and top-hat sections for the purlins and side rails (see Figure 1). Top-hat sections are more efficient than conventional zed-purlins for cold-formed steel portal frames where the frame spacings (or purlin spans) are typically in the range of 3 m to 4.5 m, compared with 6 m for conventional hot-rolled steel frames.

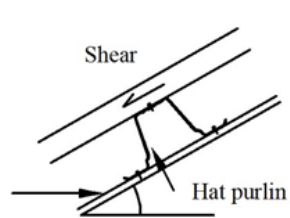

Figure 1: Drawing of top-hat sections acting as purlins

Under horizontal loading, the metal roof cladding panels are known to act as a shear diaphragm (see Figure 2) (Davies 1973) (Davies, Bryan 1982). This stiffening effect, referred to as stressed-skin / or diaphragm action, explains why a clad frame behaves differently from an unclad frame. The shear stiffness of the panel depends on factors including the deformation of the cladding due to distortion of the roof profile, slip in the sheet-purlin fasteners, slip in the seam fasteners between adjacent sheets, and distortion in the purlin-rafter connections.

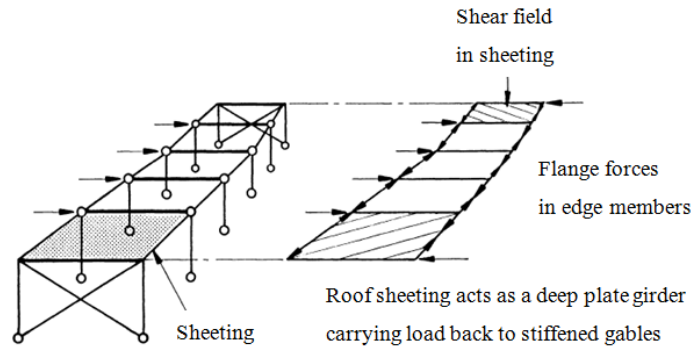

Figure 2: Stressed-skin action under horizontal load buildings (Davies, Bryan 1982)

Previous research has focused on hot-rolled steel portal frames in which haunched eaves and apex joints can be assumed to be rigid at serviceability loads. However, the joints of cold-formed steel portal frames are known to be semi-rigid. Details of the eaves and apex joints considered in this paper are shown in Figure 3; such joints are typically used for cold-formed steel portal frames in practice. As can be seen, the joints are formed through brackets that bolted between the webs of the cold-formed steel channel-sections being connected. The flexibility of the joints is due to elongation of the bolt-holes as a result of bearing of the bolt-shanks against the bolt-holes (Lim, Nethercot 2004)

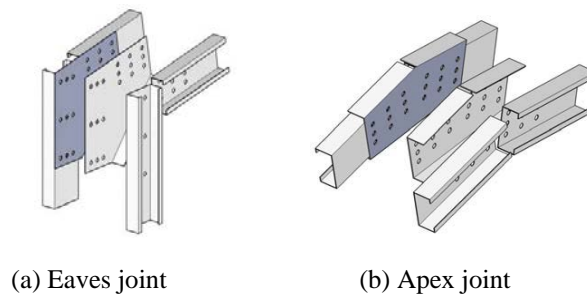

Figure 3: Details of joints for cold-formed steel portal framing system

Although the effects of stressed-skin action are often ignored in the design of hot-rolled steel portal frames, for the case of cold-formed steel portal frames with flexible joints, they should not be ignored as they can lead to an increase in

serviceability deflections. More importantly, as top-hat purlins can be expected to be stiffer than zed-purlins in terms of transferring shear load to the cladding, ignoring stressed-skin effects in design at elastic serviceability load can potentially lead to tearing of the fixings and leakage of water into the building (Lawson, Davies (1999)).

In this paper, the results of six full-scale tests on cold-formed steel portal frame buildings are presented. Two different bolt-group sizes are considered for the joints, with each bolt-group size (and therefore bracket size) having a different rotational stiffness. Firstly, tests on frames without cladding are described, with vertical loading reported in one set of tests, and horizontal loading reported in another set of tests. Secondly, for the case of horizontal loading only, the frame tests are repeated with cladding to determine the effect of stressed-skin action. For both the cladding and the joints, component tests are described separately.

Experimental investigation

Details of frames

Table 1 summarises the six portal frame building tests conducted. The frames used in all six buildings have a span of 6 m, height of 3 m, and pitch of 10°. The results of the building tests are intended to represent the behaviour of a building of length 9 m, having two braced gable frames and two internal frames, with a frame spacing of 3 m between all frames. The column bases are pinned.

Table 1. Summary of full-scale frame tests

Test	Joints	Bolt-group size	Load direction	Sheeting
A1	A	160 mm x 80 mm	Vertical	No
A2			Horizontal	Yes
A3				
B1	B	280 mm x 80 mm	Vertical	No
B2			Horizontal	Yes
B3				

The nominal depth, breadth and thickness of the channel-sections were 150 mm, 60 mm and 2 mm, respectively. In the internal frames, the channel-sections are placed back-to-back; in the gable frames (including the gable posts) the channel-sections are used singly. Figure 4 shows the nominal dimensions of the single skin deck profile used for the roof cladding. As can be seen, the panel has a

depth of 30 mm and a thickness of 0.65 mm. The depth of the top-hat purlins are 61 mm and the thickness is 1.0 mm.

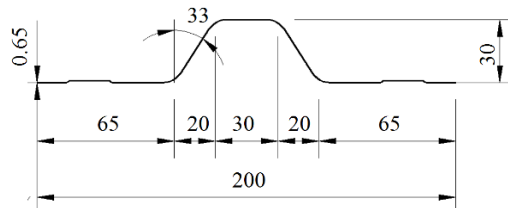
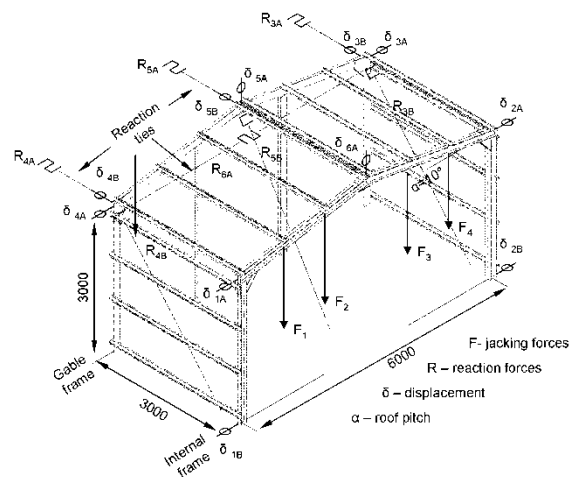
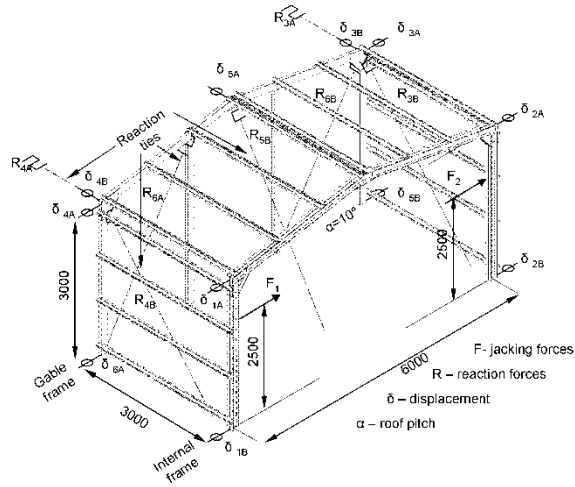

Figure 4: Nominal dimensions of roof cladding used for building tests

Details of the test general arrangement are shown in Figure 5. As can be seen, owing to symmetry, only one gable frame and one internal frame were required for each building test.



a) Vertical load



b) Horizontal load

Figure 5: General arrangement of full-scale test frame

From Table 1, Tests A1 to A3 all used a bolt-group size of 160 mm x 80 mm for the joints and the eaves and apex joints of these buildings are referred to as Joints A. Figure 7 shows details of Joints A; as can be seen, the size of the brackets were detailed to suit this bolt-group size. For each connection, 12 bolts were used: nine bolts in the web and three bolts in the flanges. Fully threaded M16 bolts were used in 18 mm diameter bolt-holes. Similarly, Tests B1 to B3 used a bolt-group size of 280 mm x 80 mm for the joints; the eaves and apex joints of these buildings are referred to as Joints B.

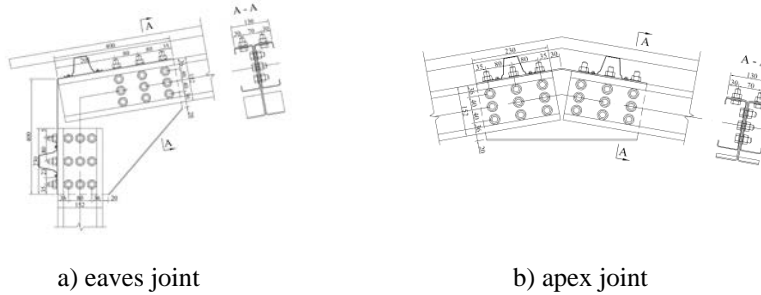

a) eaves joint

b) apex joint

Figure 6: Details of Joints A

From Figure 5, it can be seen that out-of-plane restraint was provided to the gable frame through a set of ties. Load was applied only to the internal frame. The reaction force in each tie was measured through load cells. Linear displacement transducers were used at key positions around the frame.

For each of Joints A and B, one building test was conducted with vertical loading and two tests with horizontal loading. For the case of the frames with vertical loading, all tests were conducted without cladding, as the effect of stressed-skin action for vertical loading can be expected to be negligible. For the case of horizontal loading, one test was conducted with cladding, while the other test was conducted without cladding.

It should be noted that for the case of the building tests conducted without cladding, no load is transferred to the gable frames from the internal frames to which the load is applied. The results of the tests on the internal frame can therefore be assumed to be identical to a bare frame test.

Joint component tests

Table 2 summarises the joint component tests. For the case of Joints A, tests in both the upward and downward directions were conducted. For the case of Joints B, only a single test in the upward direction was conducted.

Table 2. Summary of full-scale frame tests

Joints	Direction of loading	$S_{i,ini,exp}$ (kNm/rad)	F_T (kN)
A	Downwards	601	36.33
	Upwards	591	32.46
B	Downwards	1229	40.61

For the case of Joints A tests, details of position of the bolt-holes are shown in Figure 7. Table 3 summarises the dimensions of the cold-formed steel components. The yield and ultimate strengths of the cold-formed steel, taken from the average of three coupon tests, were 507 N/mm² and 544 N/mm², respectively.

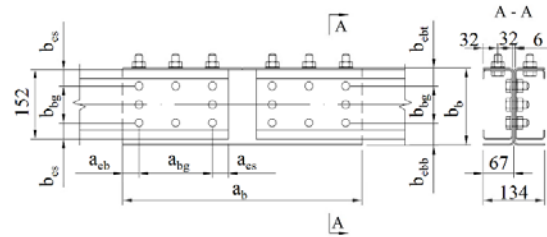

Figure 7: Details of joint component test of Joints A

Table 3 Average dimensions of channel-sections in component tests

Joints	Direction of loading	Depth (mm)	Breadth (mm)	Lip (mm)	thickness (mm)
A	Downward	152.2	64.6	20.3	1.98
	Upward	152.6	64.4	20.2	1.98
B	Downward	152.7	65.2	19.9	2.01

Figure 8 shows details of the general arrangement of the test which were conducted under four-point-bending. The total length of specimen tested for both Joints A and B was 3 m; lateral restraints were provided at the supports, load points and at mid-span. Consistent with the frame tests, fully threaded M16 bolts were used in 18 mm diameter bolt-holes.

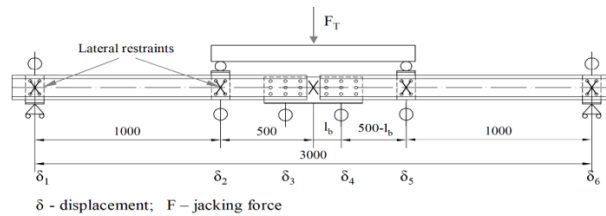

Figure 8: Details of general arrangement of joint component tests

Figure 9 shows the variation of moment against rotation for Joints A and B. For both joints, the rotation was calculated relative to the deflection of a continuous beam.

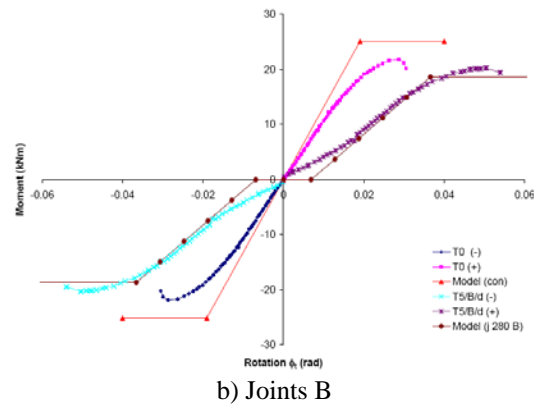
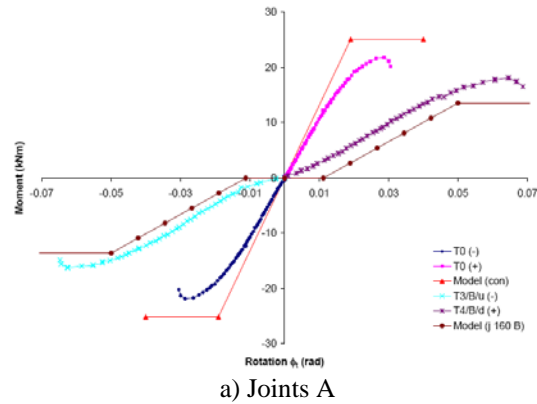

Figure 9: Variation of moment against rotation for joint component tests

The initial stiffness and strength of the three joint component tests are also summarised in Table 2. As can be seen, the initial stiffness for Joints A is similar for both downwards and upwards loading. However, the failure load is approximately 10% higher for the case of loading in the downwards direction, when the flange bolts transmit load in tension as opposed to compression.

Roof panel component tests

Figure 10 shows details of the laboratory test setup used to determine the strength and stiffness of the roof panels. The test procedure described in BS 5950-9 (1994) was adopted. The panel was subjected to three initial loading and unloading cycles before being loaded to failure.

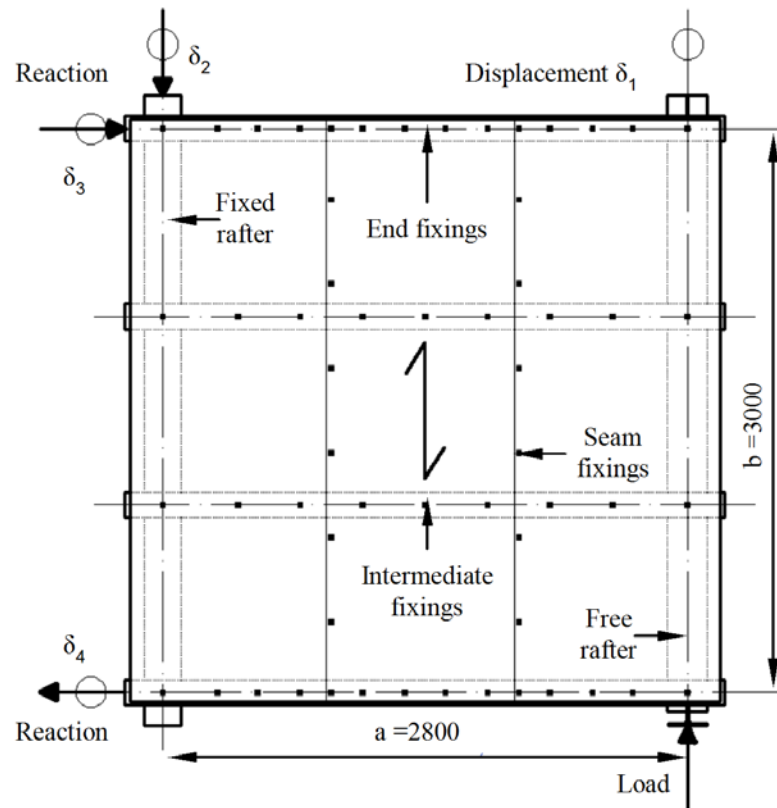

Figure 10: Plan view of the cantilever test arrangement

The average measured yield and ultimate tensile strength of the cladding was 280 N/mm^2 and 378 N/mm^2 , respectively. The average measured yield strength of the top hat sections was 635 N/mm^2 .

Self-drilling self-tapping screws of 5.5 mm diameter, having washers and seals, were used for fixing the cladding to the purlins. Self-drilling self-tapping screws of 6.3 mm diameter, both with and without washers, were used for fixing the seams and fixing the purlin to the rafters.

Figure 11 shows the experimental load deflection curve for the cladding. As can be seen, the mode of failure was a combination of end sheet to purlin connection failure and seam failure. The theoretical shear strength and stiffness was calculated in accordance with Davies and Bryan (1982), and is also shown in Figure 11. There is good agreement between the experimental test results and the theoretical results.

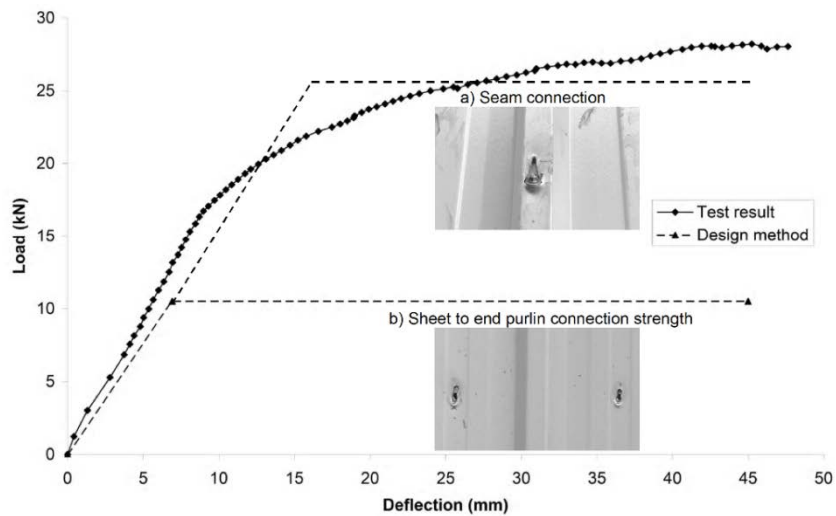
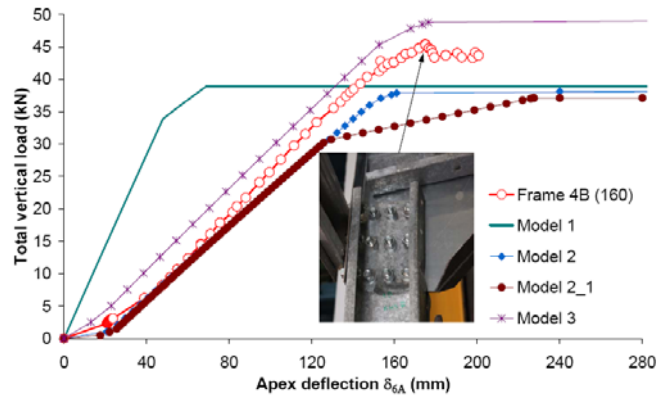

Figure 11: Load-deflection curve for the cladding profile

Full-scale frame test results

Load cycles to eliminate the initial bolt slip from the frame were not conducted, as any bolt-hole elongation would not be recoverable. All bolts were lightly tightened with a spanner to minimise the effects of friction. The same load was applied to each jack until the failure of the building. The load was applied in steps of approximately 0.5 kN. At the end of each load step, readings were taken.

Figure 12 shows the variation of load against apex deflection for the case of vertical loading. As can be seen, the failure load is independent of the bolt-group size, with both frames failing at a total load of approximately 45 kN. However, in terms of stiffness, the frame with Joints B was approximately 60% stiffer than the frame with Joints A. Once the failure load is reached, the eaves joint failed on the column side, owing to the bimoment in the column. The similar failure loads is as a result of the semi-rigidity of the joints, and the redistribution of load from the eaves to the apex. Fig.16 also shows the predicted failure load if the joints were rigid. As can be seen, with a rigid joint assumption, the frame with the smaller bolt-group failed at a load of 40 kN whilst the frame with the larger bolt-group fails at a load of 58 kN.



(a) Joints A

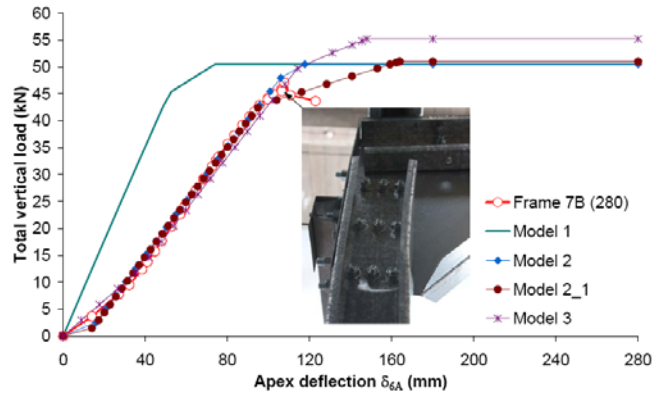

(b) Joints B

Figure 12: Variation of load against deflection for frame loaded in vertical direction

Figure 13 shows the variation of load against horizontal deflection for the case of horizontal loading with no roof cladding. There is little difference in the failure load of the frames; the frame with Joints A failed at a load of 19.5 kN, while the frame with Joints B failed at 18.5 kN.

Figure 14 shows the variation of load against horizontal deflection for the case vertical loading with roof cladding. There is again little difference in the failure load of the frames; the frame with Joints A failed at a load of 53 kN, while the frame with Joints B failed at 58 kN. However, compared with the failure load of the frame with no roof cladding, the failure load has increased by almost a factor of 3. Furthermore, the stiffness of the clad frame has increased by almost a factor of 10.

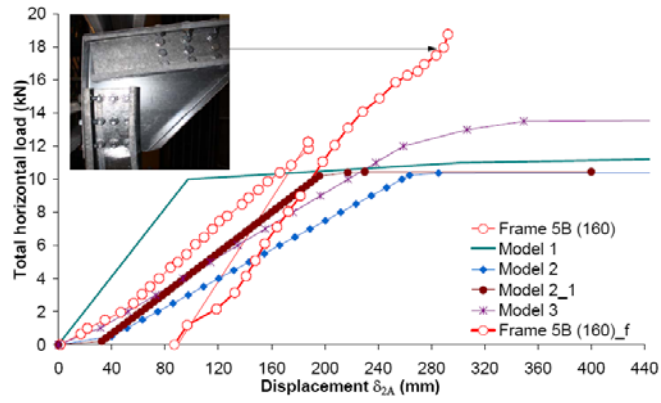

(a) Joints A

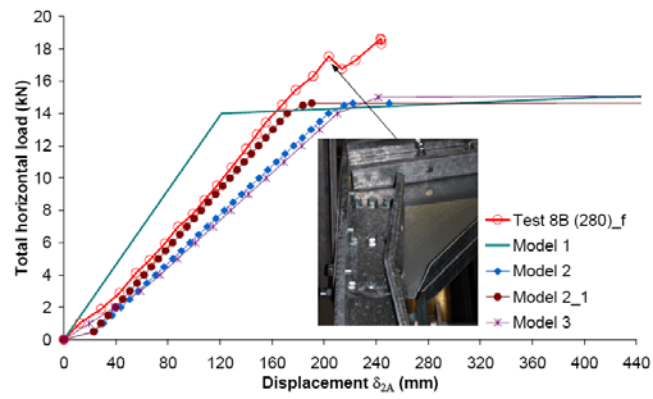

(b) Joints B

Figure 13: Variation of load against deflection for building with no cladding loaded in horizontal direction

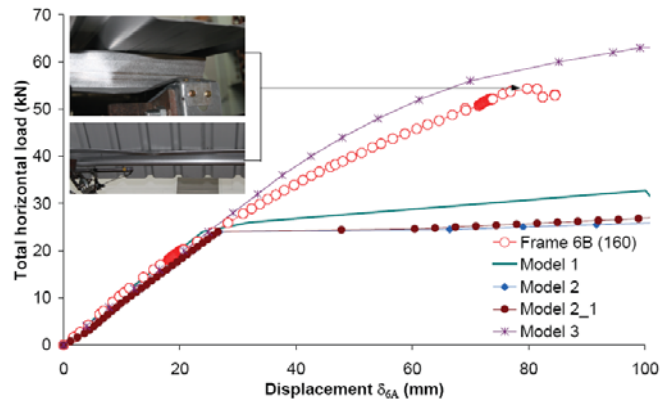

(a) Joints A

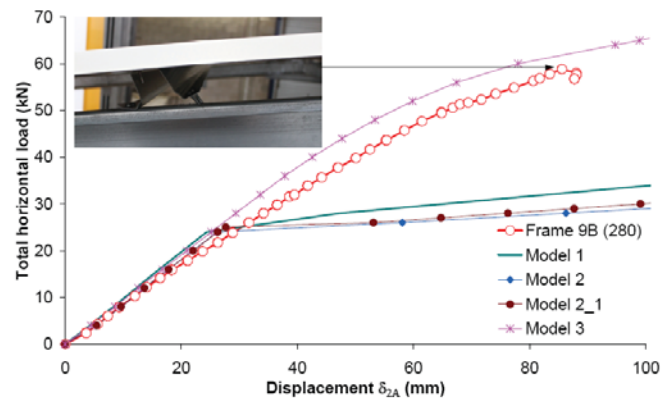

(b) Joints B

Figure 14: Variation of load against deflection for building with cladding loaded in horizontal direction

Conclusions

Six full-scale portal frame buildings have been tested in the laboratory. The frames were of span of 6 m, height of 3 m and pitch of 10°; the frame spacing was 3m. The laboratory test setup represented buildings of length of 9 m, having two gable frames and two internal frames. Tests were conducted on frames having two joint sizes, both with and without roof cladding. Figure 12 to Figure 14 show the results of the building tests. Superimposed on these tests are the results of a frame analysis that use the results of the component tests for the stiffness of the joints and cladding. It can be seen that frame analysis can be used to predict the experimental test results.

The full-scale tests show that as a result of stressed-skin action, under horizontal load, the bending moment at the eaves are reduced by approximately a factor of three, relative to the bare frame. It was also shown that as a result of stressed-skin action, the deflection of the internal frame reduced by 90%, and that the stiffness was independent of joint flexibility. Joint flexibility was shown not to be significant on the overall failure load of the frames.

Acknowledgements

The authors would like to thank Steadmans Ltd for providing all test materials and specimens. The authors would also like to thank Capital Steel Buildings Ltd. for funding this project through an EPSRC CASE award.

References

- BRITISH STANDARDS INSTITUTION, 1994. "BS 5950: Structural use of steelworks in building. Part 9. Code of practice for stressed-skin design Code of practice for stressed-skin design."
- DAVIES, J.M. and BRYAN, E.R., Manual of stressed skin diaphragm design. (1982), London, Granada.
- DAVIES, J.M., 1973. The plastic collapse of framed structures clad with corrugated steel sheeting. *ICE Proceedings*, **55**, pp. 23-42.
- LAWSON R.M. and DAVIES, J.M., 1999. Stressed skin action of modern steel roof systems. *The Structural Engineer*, **77**(21), pp.30-35.

- LIM, J.B.P. and NETHERCOT, D.A., 2003. Serviceability design of a cold-formed steel portal frame having semi-rigid joints. *Steel and Composite Structures*, **3**, pp. 451-474.
- LIM, J.B.P. and NETHERCOT, D.A., 2004. Stiffness prediction for bolted moment-connections between cold-formed steel members. *Journal of Constructional Steel Research*, **60**(1), pp. 85-107.