

01 Jan 1979

Structural stability research council: proceedings 1979

Structural stability research council

Follow this and additional works at: <https://scholarsmine.mst.edu/ccfss-library>



Part of the [Structural Engineering Commons](#)

Recommended Citation

Structural stability research council, "Structural stability research council: proceedings 1979" (1979).
Center for Cold-Formed Steel Structures Library. 221.
<https://scholarsmine.mst.edu/ccfss-library/221>

This Technical Report is brought to you for free and open access by Scholars' Mine. It has been accepted for inclusion in Center for Cold-Formed Steel Structures Library by an authorized administrator of Scholars' Mine. This work is protected by U. S. Copyright Law. Unauthorized use including reproduction for redistribution requires the permission of the copyright holder. For more information, please contact scholarsmine@mst.edu.

About the Council

The Structural Research Council's mission and its functions to provide economic and technical solutions to the problems of the building industry.

The Council's specific functions are defined in its constitution and its main purpose is to provide for Metal Structures critical design information.

The members of the Council are representatives of the building industry, structures, and the Council's "Members-at-Large" from Corresponding Members who contribute to the Council's work. Members-at-Large are consulting engineering firms.

The Annual Technical Report, published with up-to-date information, indicates the progress of structural research and the Annual Report of the Council is a permanent record of the Council's activities. It is a primary source of information on structural design and technical progress.

CCFSS LIBRARY Fritz Engineering Foundation
19 5 * 4914 STRUCTURAL RESEARCH COUNCIL
1979 PROCEEDINGS

CCFSS LIBRARY Fritz Engineering Foundation
19 5 * 4914 STRUCTURAL RESEARCH COUNCIL
1979 PROCEEDINGS

DATE	ISSUES

ly Column
he confu-
e in sol-
d promote

and
and re-
sing
through
criteria
at is a
eld.

ed rep-
ncerned
or metal
tion,
ing

These
and
Mem-
esigners,
onsult-

signer
t also
erstand-
product
a a
esent
ions
ished

STRUCTURAL STABILITY RESEARCH COUNCIL

(Established in 1944 by Engineering Foundation)

Proceedings 1979

The Council has its Headquarters at:
Fritz Engineering Laboratory #13
Lehigh University
Bethlehem, Pennsylvania 18015

Supported by a grant from the National Science Foundation (PFR 7902613)

Table of Contents

	<u>Page</u>
FOREWORD	v
THE SSRC EXECUTIVE COMMITTEE 1979.	1
ANNUAL TECHNICAL SESSION AND MEETING	3
Program of Technical Session.	4
Task Group Reports.	10
Panel Discussion.	55
1979 Annual Business Meeting.	94
Attendees	100
LIST OF PUBLICATIONS	102
SSRC CHRONOLOGY.	104
FINANCE.	105
Cash Statement and Budget	105
REGISTER	108
Officers.	108
Executive Committee	108
Standing and Ad Hoc Committees.	108
Task Groups	109
Task Reporters.	113
Sponsoring Organizations.	114
Participating Organizations	114
Participating Firms	116
Members-At-Large.	117
Corresponding Members	118
Life Members.	119
SSRC Addresses.	120
BY-LAWS.	139
RULES OF PROCEDURE	146



Jerome S. B. Iffland
Present SSRC Chairman

George Winter
Past SSRC Chairman

Foreword

During the past year in a letter to members of the Council I noted that SSRC is essentially a voluntary organization and that we can be proud of accomplishments achieved by the contribution of our time and collective abilities to Council activities. As my first year as Chairman is completed, it is worthwhile to review our recent accomplishments. Our cumulative record over the years is reflected in the status and respect SSRC enjoys throughout the world.

The Second International Colloquium of The Stability of Steel Structures was organized and developed during the Chairmanship of George Winter. The final report of this Colloquium is now being completed and represents a major Council effort. A suggested title for this report is "Stability of Metal Structures: A World View." It is an international effort of SSRC members and their colleagues around the world and will detail item by item, comparisons of stability practices between four world regions: Eastern Europe, Western Europe, North America and Japan. The final document will reach book length and could be the forerunner of a uniform International Guide for Stability Design Criteria for Metal Structures. The editors, Duiliu Sfantesco, Gerald W. Schulz, Riccardo Zandonini, Theodore V. Galambos, Otto Halasz, Ben Kato, Lynn Beedle, as well as all the members who worked with them, can justifiably be pleased with this document. It was Past Chairman, George Winter and Director, Lynn S. Beedle, who conceived the Comparison/Summary Report approach. The Headquarters Group at Lehigh continues to provide motivation and leadership for this report as it is being completed.

Another project initiated during George Winter's Chairmanship is also nearing completion. This is the Report on Research Needs prepared by the Committee on Research Priorities consisting of Reidar BJORHOVDE, Samuel J. Errera, Theodore V. Galambos, Robert M. Meith and myself. This truly represents an entire Council effort since all Task Groups contributed to its preparation. The final draft for publication is being coordinated by Reidar BJORHOVDE.

A relatively short but an extremely important report which was completed this year is Technical Memorandum No. 5, "General Principles for the Stability Design of Metal Structures." This was prepared by an Ad-hoc Committee on Column Problems consisting of Theodore V. Galambos, who, as Chairman, also prepared the first and second drafts, Reidar BJORHOVDE, Wilfred F. Chen, Edward H. Gaylord, John Springfield, Joseph A. Yura, and myself. The entire membership of the Council also contributed to this document by submitting critical comments. John Springfield accomplished the very difficult task of resolving these comments into a final draft which was then critically edited line by line by the Executive Committee. This document updates and re-establishes our basic philosophy and will be our guideline for the coming years and especially for the preparation of the Fourth Edition of the Guide now being initiated.

A major hiatus in structural design specifications that has always frustrated practitioners has been lack of a rational and equitable method of designing composite columns. This is no longer a problem. Task Group 20, Composite Columns, under the leadership of Chairman S. H. Iyengar and George Winter, working together with the SSLC Committee chaired by George Winter, have developed a design specification consistent with both reinforced concrete and structural steel specifications. The initial draft was developed by Richard W. Furlong. This group initiated and completed their task in less than one year. The SSRC Executive Committee has recommended that the document be published in the AISC Engineering Journal. It is now being processed by the Journal editors and publication in an early issue is anticipated.

Task Group 6, Test Methods for Compression Members, has completed another SSRC publication. This is Technical Memorandum No. 6, "Determination of Residual Stresses." This significant and useful report was prepared under the direction of Teoman Pekos, Chairman, and Samuel J. Errera. Members of Task Group 6 are to be commended for this effort.

These are some of our important accomplishments that have come to fruition during this past year. We can view all of them with pride. There are many other efforts and programs in progress and others that are being initiated within our numerous task groups. As many of these tasks are completed in the coming year, we can look ahead to more reasons for being proud to be members of the Structural Stability Research Council.

On the administrative side, the Technical Secretary, Dr. Riccardo Zandonini, had to return to Italy and the position was taken over by Dr. Sritawat Kitipornchai who is on leave from the University of Queensland, Australia.

In closing I want to thank the Headquarters staff, and particularly Lynn Beedle and Lesleigh Federinic, for their assistance and guidance to me in my first year as your Chairman.



Jerome S. B. Iffland
Jerome S. B. Iffland
SSRC Chairman
1979

SSRC Executive Committee

J. S. B. Iffland, Chairman	- Iffland Kavanagh Waterbury
J. L. Durkee, Vice Chairman	- Consulting Structural Engineer
L. S. Beedle, Director	- Lehigh University
W. J. Austin	- Rice University
S. J. Errera	- Bethlehem Steel Corporation
G. F. Fox	- Howard Needles Tammen & Bergendoff
T. V. Galambos	- Washington University
R. R. Graham, Jr.	- United States Steel Corporation
T. R. Higgins	- Consultant
B. G. Johnston	- Consultant
R. M. Meith	- Chevron U. S. A. Inc.
W. A. Milek, Jr.	- American Institute of Steel Construction
J. Springfield	- Carruthers and Wallace Limited
G. Winter	- Cornell University



Back row: G. F. Fox, W. J. Austin, J. S. B. Iffland, R. M. Meith,
L. S. Beedle, L. G. Federinic
Front row: S. J. Errera, T. V. Galambos, B. G. Johnston, G. Winter,
R. R. Graham, S. Kitipornchai

Annual Technical Session

One of the purposes of the Council is to maintain a forum where problems related to the design and behavior of columns and other compression elements in metal structures can be presented for evaluation and discussion. The Annual Technical Session provides an opportunity to carry out this function.

The 1979 Annual Technical Session was held on April 24 and 25 at The William Penn Hotel in Pittsburgh, Pennsylvania. Eighty-five persons attended the Session and twenty-seven papers were delivered.

A panel discussion on "Stability of Space Frame Structures" was held in the evening of April 24, 1979. The panelists were R. S. Loomis, D. T. Wright, and E. P. Becker. The moderator was J. L. Durkee.

In conjunction with the Technical Session, an Annual Business Meeting was held for the purpose of electing new officers and members, and discuss financial and other business matters.

Summaries of the technical papers, the panel discussion and minutes of the business meeting are recorded in the following pages. The attendance list is also included.



PROGRAM OF TECHNICAL SESSION

Tuesday, April 24, 1979

8:00 a. m. - REGISTRATION

9:00 a. m. - MORNING SESSION

Presiding: G. Winter, Cornell University

INTRODUCTION

J. S. B. Iffland, Chairman, SSRC

TASK GROUP REPORTS

Task Group 23 - Effect of End Restraint on Initially Crooked Columns

Chairman, W. F. Chen, Purdue University

The Strength of Initially Curved Restrained Aluminum Columns

J. Chapius and T.V. Galambos, Washington University

End Restrained Sway Columns: Preliminary Studies on Effective Length

R. Zandonini, Lehigh University

The Analysis of Frames with Semi-Rigid Connections - State-of-the-Art-Report

S. W. Jones, P. A. Kirby, and D. A. Nethercot, Sheffield University
Presented by J. S. Springfield

Task Group 1 - Centrally Loaded Columns

Chairman, R. Bjorhovde, The University of Alberta

Starred Angle Compression Members

M. C. Temple, J. A. Schepers, and D. J. L. Kennedy, University of Windsor

Strength of Welded Built-Up Box Columns

R. Zandonini and L. Tall, Lehigh University

10:15-10:35 a. m. - BREAK

Ad-Hoc Committee on Research Priorities

Chairman, J. S. B. Iffland, Iffland Kavanagh Waterbury

SSRC Research Needs

R. Bjorhovde, The University of Alberta

Task Group 3 - Columns with Biaxial Bending

Chairman, J. Springfield, C. D. Carruthers & Wallace Ltd.

The Elastic - Plastic Behaviour of Restrained Columns

D. C. Stringer, Dominion Bridge Company, Ltd.

Horizontal Test Rig to Study the Spatial Stability of Beam - Columns with Imperfections

S. Vinnakota, Swiss Federal Institute of Technology, Lausanne

Task Group 7 - Tapered Members

Chairman, A. Amirikian, Amirikian Engineering Co.

Report on Tapered Member Project at Buffalo

G. C. Lee, State University of New York at Buffalo

Lateral - Torsional Buckling of Tapered Members, Using Finite Element Analysis

C. J. Miller and M. Kayum, Case Western Reserve University

12:00 Noon - Group Luncheon

1:00 p. m. - AFTERNOON SESSION

Presiding: J. S. B. Iffland, Iffland Kavanaugh Waterbury

Task Group 11 - International Cooperation on Stability Studies

Chairman, D. Sfintesco, Lamorlaye, France

Vice-Chairman, W. A. Milek, Jr., American Institute of Steel Construction

International Colloquium on Stability Comparison/Summary Studies

D. Sfintesco, R. Zandonini, Coordinating Editors

T. V. Galambos, Regional Editor

Task Group 15 - Laterally Unsupported Beams

Chairman, T. V. Galambos, Washington University

Task Group 16 - Plate Girders

Chairman, W. Hsiong, MTA Incorporated

Ultimate Strength of Plate Girders

S. Vinnakota, Swiss Federal Institute of Technology, Lausanne

Task Group 6 - Test Methods for Compression Members

Chairman, T. Pekoz, Cornell University

Task Group 12 - Mechanical Properties of Steel In Inelastic Range

Chairman, R. B. Testa, Columbia University

Task Group 14 - Horizontally Curved Girders

Executive Committee Contact Member, J. L. Durkee, Consulting Structural Engineer

2:15 p. m. - 2:35 p. m. - BREAK

Task Group 20 - Composite Members

Chairman, S. H. Iyengar, Skidmore, Owings, and Merrill

Task Group 21 - Box Girders

Chairman, R. C. Young, Morrissey & Johnson

Task Group 22 - Stiffened Cylindrical Members

Chairman, C. D. Miller, Chicago Bridge & Iron Company

Task Group 17 - Stability of Shell-Like Structures

Chairman, A. Chajes, University of Massachusetts

A General Analysis of Space Frame Stability and Geometric Nonlinearity

C. H. Yoo, Marquette University

Task Group 4 - Frame Stability and Effective Column Length

Chairman, J. S. B. Iffland, Iffland Kavanagh Waterbury

Lessons Learned from a Collapse Analysis of the Hartford Coliseum Roof

E. A. Smith and H. I. Epstein, University of Connecticut

Influence of Joint Translation of End Bending Moments

R. L. Ketter, State University of New York at Buffalo

Nonlinear Analysis of Portal Frames

G. J. Simitzes and J. Giri, Georgia Institute of Technology
A. N. Kounadis, National Technical University of Athens

Analysis of Inelastic Space Frames Subject to Multi-Component Seismic Inputs

F. Y. Cheng, University of Missouri-Rolla

Torsional Buckling Study of the Hartford Coliseum

R. S. Loomis, Loomis and Loomis, Inc.

4:45 p. m. - RECEPTION
COSPONSORED BY UNITED STATES STEEL CORPORATION

6:00 p. m. - PANEL DISCUSSION: STABILITY OF SPACE FRAME STRUCTURES

Moderator: J. L. Durkee, Consulting Structural Engineer

Panelists: Robert S. Loomis, Loomis and Loomis, Inc.
Douglas T. Wright, Ontario Deputy Minister of Culture &
Recreation
Edward P. Becker, Lehigh Structural Steel Company

8:00 p. m. - ADJOURN

Wednesday, April 25, 1979

8:30 a. m. - MORNING SESSION

Presiding: B. G. Johnston, Consulting Engineer

Task Group 8 - Dynamic Stability of Compression Elements

Chairman, D. Krajcinovic, University of Illinois at Chicago Circle

Load Correlation factors in Dynamic Stability

D. Krajcinovic, University of Illinois at Chicago Circle

The Effects of Joint Stiffness and the Constraints on the Type of Instability
of a Frame Under a Follower Force

A. N. Kounadis and E. P. Economou, National Technical University of
Athens

Stability Boundaries for Reticulated Domes

S. M. Holzer, R. H. Plaut, and S. H. Shen, Virginia Polytechnic
Institute & State University

Dynamic Stability Under Step Loads: One-Degree-of-Freedom Models

G. J. Simites, Georgia Institute of Technology

Column Bending Under Cyclic Loading

E. Popov, University of California, Berkeley
Presented by T. V. Galambos

10:10 a. m. - 10:30 a. m. - BREAK

Task Group 13 - Thin-Walled Metal Construction

Chairman, W. W. Yu, University of Missouri-Rolla

Buckling of Cold-Formed Steel Diaphragms

C. J. Miller, Case Western Reserve University

Plate Collapse in Compression--Review of Recent Work in U. K.

C. D. Bradfield and J. B. Dwight, University of Cambridge

Task Group 18 - Unstiffened Tubular Members

Chairman, D. R. Sherman, University of Wisconsin-Milwaukee

Local Buckling Tests on Tubular Columns (36-50-100 ksi)

A. Ostapenko, Lehigh University

Task Reporter 15 - Curved Compression Members

W. J. Austin, Rice University

Curved Compression Members

W. J. Austin, Rice University

11:30 a. m. - SSRC ANNUAL BUSINESS MEETING

12:00 NOON - ADJOURN



J. B. Dwight

B. G. Johnston



W. A. Milek, Jr.

D. Sfintesco

"That slide is just too crowded"

T A S K G R O U P R E P O R T S

TASK GROUP 23 - EFFECT OF END RESTRAINT ON INITIALLY CROOKED COLUMNS

Chairman, W. F. Chen, Purdue University

The Strength of Initially Curved Restrained Aluminum Columns

Jacques Chapuis and T. V. Galambos, Washington University

This report is part of a research project on the strength of aluminum columns as a function of different parameters such as the material properties, the cross-sectional properties, the geometry characteristics (initial imperfections) and the boundary conditions.

In this study, the stress-strain curve for aluminum is described by an equation with three parameters, i.e., the modulus of elasticity (E), the conventional yield stress ($\sigma_{0.2}$) and a parameter describing the hardening of the material (n). The tangent modulus load which is assumed to be the ultimate strength of a straight pinned column can thus be computed on the basis of the stress-strain curve.

The strength of crooked pinned columns is determined by assuming a sinusoidal shape for both the initial imperfection and the deflection under loading.

The case of equal end restraints and no sidesway is studied in computing the actual shape of deflection for different values of the axial load. This is done in integrating along the length, iterating on the end slope and using the symmetry conditions at mid-height.

Typical results are presented in the following figure. They concern columns with a column-type I-shape cross-section, weak axis bending, initial crookedness $v_{o1}/L = 0.001$ and a non-heat-treated alloy.

In the upper part the strength of different cases of columns is presented as a function of the slenderness ratio $\lambda = \frac{L}{r} \frac{1}{\pi} \sqrt{\frac{\sigma_{0.2}}{E}}$. The strength is given by the ratio $\sigma/\sigma_{0.2}$ where σ is the average normal stress.

The amount of restraint is described by the parameter $\gamma = 2 EI/\alpha L$ where α is the rotational stiffness of the springs, L is the length of the column and I is the moment of inertia. For a straight column in the elastic range, γ can be related to the "effective length factor" K . For example, $K = 0.9$ and 0.8 correspond to $\gamma = 3,256$ and $1,232$ respectively.

The cases presented are:

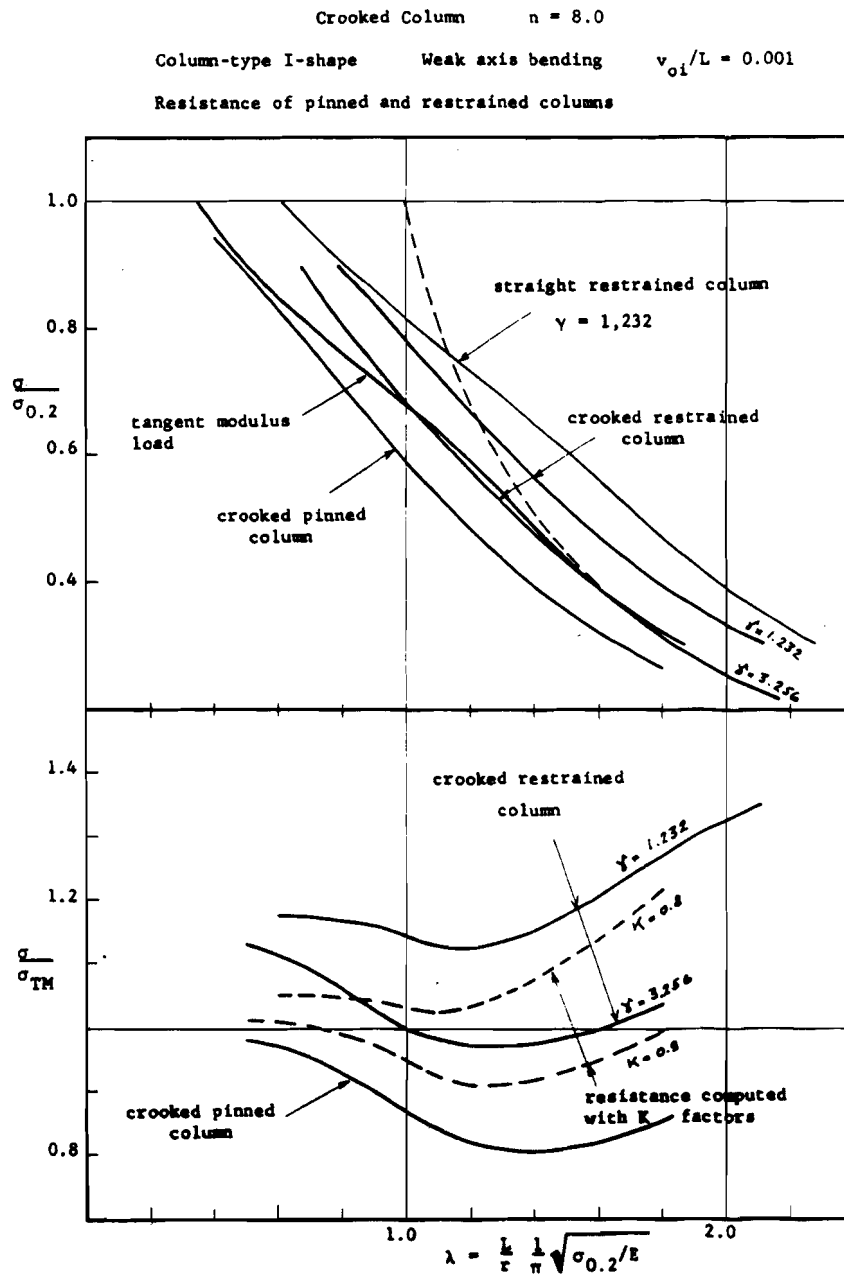
- a) pinned straight column (tangent modulus load)
- b) pinned crooked column
- c) restrained straight column ($\gamma = 1,232$)
- d) restrained crooked column ($\gamma = 1,232$ and $3,256$).

TASK GROUP REPORTS

In the lower part of the figure the ratios of the strength of cases b and d to the tangent modulus load σ_{TM} (case a) are shown as function of λ .

For a pinned crooked column, a strength based on the tangent modulus load is unconservative and does not offer a constant safety index as λ varies. However, the introduction of a slight amount of restraint ($\gamma = 3,256$) compensates for the reduction due to the initial imperfection.

An approximation of the strength of a crooked restrained column can be based on the strength of the pinned crooked column with the same initial imperfection and in using the effective length factor. The two dashed lines in the lower part of the figure present these estimations which are shown to be conservative.



TASK GROUP REPORTSEnd Restrained Sway Columns: Preliminary Studies on Effective Length

R. Zandonini, Lehigh University

Most of the studies on centrally compressed columns are related to the pin-ended case. This case has been widely studied both using the bifurcation theory (as to perfectly straight columns) and computing strength taking into account the initial geometric imperfections.

The effective length "KL" has then been introduced to take into account the fact that the columns usually have different end restraints. The effective length concept has its origin in the bifurcation theory of elastic members and frames. A large range of columns collapse in the inelastic range, so attempts have been made to extend this concept to inelastic members. These attempts remained in the limits of the bifurcation theory, so that they are strictly applicable to initially perfectly straight columns. Actual members or frames always have geometrical imperfections such as load eccentricities or out-of-straightness which influence their behavior: bending starts at onset of the loading process, and the strength of the column will be reached corresponding to instability of equilibrium.

For a sway member the moment distribution during the loading process will present the maximum values at the ends so that when the member enters the inelastic range, its stiffness is reduced, not through all the column but in these limited zones. Therefore, although it has to be expected that the stiffness reduction enhances the effect of the restraint by the girders, on the other hand, the moment that is transmitted through the connection is also affected and limited by the value of the plastic moment of the column section under the applied load. If this moment is achieved, the connection is no longer effective for the further load increases.

The problem is a very complicated one. I feel that only a numerical approach suitable to follow the column behavior through all the loading process could help to better understand the problem and also to check if the use of the elastic effective column length to enter the column curve is conservative, and to what extent. The study is now underway and the preliminary results are related to the member of Figure 1a, that can be considered as a column of a one-story frame. A numerical approach has been first set up for the study of the behavior of that column.

A schematic model is made of the strut with a finite degree of freedom (Fig. 1b), made up of rigid members and elementary cells in which all the flexibility, both axial and flexural, is concentrated. A rotational spring of stiffness α_t takes into account the interaction between the horizontal members and the column. The equivalence between the model and the actual member consists in equating the respective Euler load P_e and the elastic limit moment of the section \bar{M} . The load P is the independent variable and is increased step by step; at each step the equilibrium configuration is found in terms of the relative rotations ϕ_i : in the elastic range solving

TASK GROUP REPORTS

a system of linear equations (P is given) and in the inelastic range solving a differential problem to initial values with an interactive process. The values of the P - M - ϕ relationship and of its derivatives are computed for every cell at each step of the interaction.

The strength of the column is considered reached when the derivative of the P - Δ curve is $1/1000$ the initial one. This approach allows to take into account in a simple but reliable way geometrical and material nonlinearities.

Coming back to the effective length problem, it seems correct to define it as the length that if used to enter an appropriate column curve gives as a result the same strength as the actual end-restrained column. Therefore, to compute the inelastic values of the effective slenderness ratio, the following path has been followed:

- 1) Compute the column curve for the pin-ended member with imperfections.
- 2) Compute for given values of the elastic end restraint at the top the maximum strength P_{\max} of the actual column, with imperfections consistent with the one chosen at the previous point.
- 3) Enter with this P_{\max} in the column curve and determine the value of the effective slenderness and, therefore, of K .

These computations have been done for the European WF HE200A. The results for the bending about the minor axis are shown in Figure 2. The values of K computed taking into account the inelastic behavior of the column are lower than elastic ones. The reduction is very dependent upon the slenderness ratio L/r of the column and upon the value of the end-restraint. Results related to the strong axis pointed out that the axis of bending is also a factor. This reduction is limited, however, so it seems that the elastic values of the effective length give not only a conservative but also, at least in most cases, a close evaluation of the action one.

These are only preliminary results and different combinations of end-restraint need to be investigated as well as nonlinear behavior of the restraint due to the nonlinear behavior of the connections or to the yielding of the girders.

TASK GROUP REPORTS

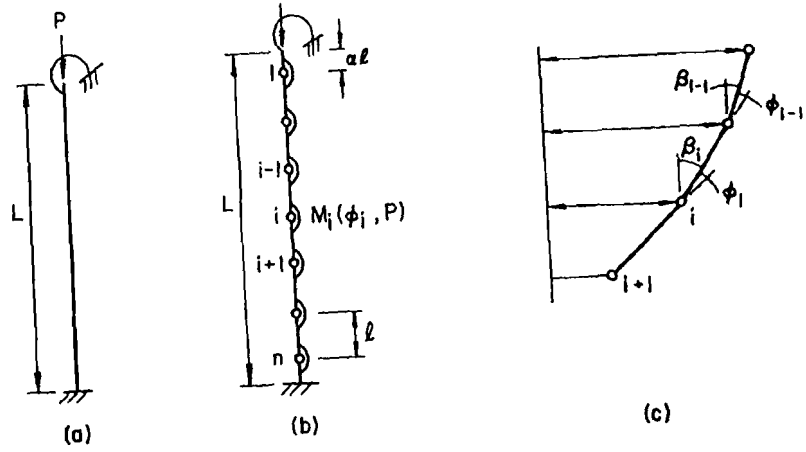


FIGURE 1

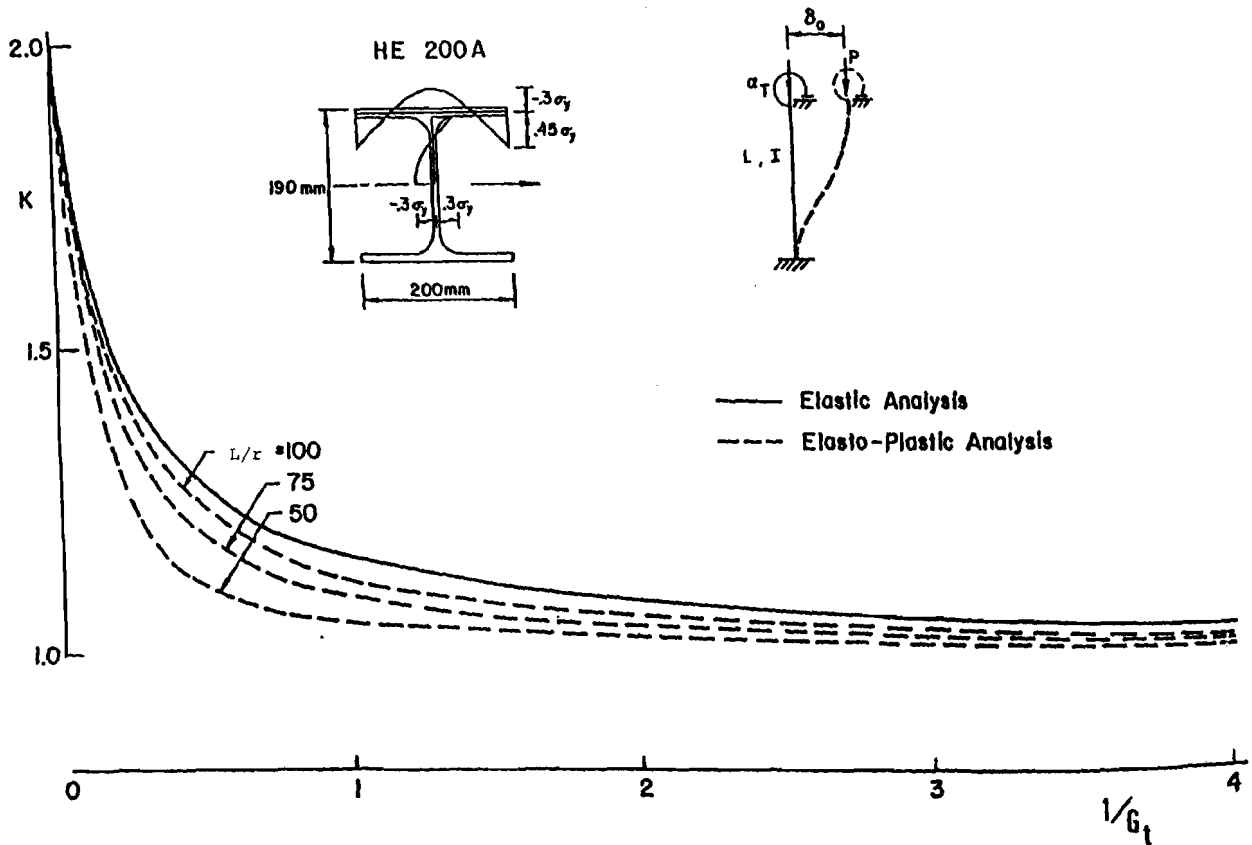


FIGURE 2

TASK GROUP REPORTS

The Analysis of Frames with Semi-Rigid Connections - A State-of-the-Art Report

S. W. Jones, P. A. Kirby, D. A. Nethercot, Sheffield University

Introduction. Virtually all currently used methods for the design of steel frames are based on the initial assumption that the joints will behave either as pin-connections or that they will provide full rotational continuity between adjacent members. Similar assumptions also form the bases of most methods of frame analysis. This approach is suggested in a number of codes and has even been continued in the revision to B.S. 449: 1969, "The Use of Structural Steel in Buildings," in which the terms "simple construction" and "continuous construction" are used. Experimental investigations of actual joint behavior conducted during the past fifty years have clearly demonstrated that the type of connections which are normally assumed to provide "simple support" do possess a certain amount of rotational stiffness and that some degree of flexibility often exists in nominally "rigid" connections. Therefore, it would be more correct to consider all steel frames under the heading of "semi-rigid construction."

The most obvious advantage of a design utilizing semi-rigid connections is that beam moments are reduced leading to lighter beams. For an isolated beam with simple connections, the span moment is critical; whereas when rigid connections are assumed, the end moments are critical for beam design. If semi-rigid connections are assumed, these two moments may be more nearly balanced. Another possible source of economy lies in the columns where a better understanding of actual restraint conditions and end moments may well lead to more rationally based, less conservative methods of design.

The aim of this paper is:

- (i) to review methods of incorporating semi-rigid end restraint into conventional analytical methods,
- (ii) to review experimental data available on the behavior of common types of structural connection, and
- (iii) to discuss methods of modelling this experimental data within analytical procedures.

Summary and Conclusions

1. The importance of the end restraint provided by semi-rigid connections was realized over fifty years ago.
2. Most early investigations assume a linear moment-rotation relationship.
3. Possible economies of as much as 20% have been estimated from early investigations.
4. Many conventional methods of frame analysis have been modified to allow for semi-rigid end restraint. These methods include: Slope Deflection, Moment-Distribution, and Matrix Stiffness methods.

TASK GROUP REPORTS

5. The beam-line method uses the actual $M-\phi$ relationship and so finds an accurate value of end restraint without assuming linear $M-\phi$ behavior, but the method requires experimental $M-\phi$ data to be available for every connection analyzed.
6. Much research and development has been conducted into structural fasteners during the past thirty years. Riveting has been replaced by bolting, both "black" and High-Strength Friction Grip and welding has been developed to become a principal form of making structural connections.
7. Existing methods of analysis have proved to be too tedious and cumbersome for most designers. The advent of the electronic digital computer stimulated research in the 1960s using matrix methods and made it possible to incorporate systematic procedures into methods of analysis and to give a better representation of true connection behavior.
8. The stability of frames and the effective lengths of members within frames with semi-rigid connections have been considered recently.
9. Experimenters have reported much data on the in-plane flexural behavior of connections; however, little data appears to be available on connection behavior in all other degrees of freedom.
10. The 3-dimensional behavior of members with semi-rigid connections has received little investigation.
11. The load-deflection and stability behavior of structures containing semi-rigid connections is generally unknown and investigation is required to take full advantage of any possible economies due to real end restraint conditions.
12. The best description of the flexural behavior of a connection is its moment-rotation curve.
13. The behavior of a connection is very complex and its $M-\phi$ relationship is rarely linear. Most $M-\phi$ curves are nonlinear over the complete loading range.
14. Moment-rotation relationships have been modeled by linear or bilinear curves for many years. Recently attempts to improve the modeling of the true connection behavior, using polynomial and B-spline curve fitting techniques, have been proposed.
15. Care must be taken to ensure that correct connection rotation values are measured in experiments.

TASK GROUP 1 - CENTRALLY LOADED COLUMNS

Chairman, R. Bjorhovde, The University of Alberta

Starred Angle Compression Members

M. C. Temple, J. A. Schepers, and D. J. L. Kennedy, University of Windsor

The use of double-angles as web members in trusses and for bracing members is quite common. The most frequent arrangement of the angles is with the legs back-to-back forming basically a "tee" section. Another method of arranging the angles is heel-to-heel to form a starred-shape angle compression member. This arrangement has the advantage that all surfaces are accessible for maintenance. This is important when the atmosphere in a building causes corrosion or where building cleanliness is important such as in the food or pharmaceutical industry.

A study of several specifications for the design of steel structures indicates that the requirements for inter-connecting these angles vary greatly. The Canadian and US Codes simply require that the slenderness ratio between points of inter-connection must be no greater than the slenderness ratio of the built-up member. The British Code, on the other hand, has basically four requirements: (1) the slenderness ratio between points of inter-connection cannot exceed 40 nor 0.6 times the maximum slenderness ratio of the strut as a whole; (2) a minimum of two inter-connectors spaced equidistant along the length of the strut must be used; (3) there are shear and moment requirements for the inter-connectors, and (4) the inter-connectors must be in pairs.

These specifications indicate the extremes in the requirements for the inter-connection of the elements of starred angle compression members. The Canadian and US Specifications have only a slenderness ratio requirement. The British Code has stringent slenderness ratio plus other requirements.

Preliminary tests conducted by Stringer and Pauls of Dominion Bridge indicate that the number and type of inter-connectors does affect the load-carrying capacity of these struts. Further tests conducted at the University of Windsor indicate that the failure mode is a complex one of flexural and torsional-flexural buckling.

Research is continuing on starred angle compression members with the objective of developing suitable design rules for the inter-connection of the elements of starred angle compression members.

Strength of Welded Built-up Box Columns

R. Zandonini and L. Tall, Lehigh University

Starting from the late '50s a number of studies on the influence of residual stresses on the column strength have been carried out, principally at Lehigh University, under the guidance of CRC Task Group 1. The results related to wide-flange columns have been the background for the well-known CRC basic column formula, still adopted in most of the North American codes.

TASK GROUP REPORTS

Further research work on welded shapes pointed out that due to the presence of larger geometrical imperfections, the tangent modulus load is unconservative when compared with test results. In general, it seemed a more realistic approach to compute the strength of a column taking into account the initial geometrical imperfections that are always to be expected in an actual column.

Years of study also pointed out that the variation of column strength is so broad that it could be questioned if a single column curve is the most appropriate for design purposes. The variation in strength from the single curve could be as much as 20% in each direction.

For that reason, at the beginning of this decade, the practicability of the multiple column curve approach was studied. Three curves were then proposed on a statistical basis and these curves have been introduced in the Guide. So far, the SSRC curves have not been adopted in any North American codes or specifications for two main reasons:

1. Their use leads to a greater complexity for designers.
2. There is still too little information on the strength of a great variety of columns.

Concerning this last point, for instance, no information is available on most of the welded built-up columns. To fill, at least partially, this lack of information, a research study is now under way at Lehigh University to investigate the behavior and strength of welded box and box-type columns. The box column has been chosen as a starting point because of its wide use and the limited information available from the previous studies.

The first part of the research is related to welded box columns built up from thin plates, that is, with thickness less than 1". The first step of the research concerns the definition of residual stress patterns suitable to give representative boundary values for welded box shapes.

A large amount of experimental data on residual stresses in welded box shapes and welded plates is available from the research work carried out all over the world and especially at Lehigh University and Cambridge University. These data have been collected and analyzed. At the same time, a theoretical study has been carried out on the influence on column strength both of the residual stress pattern and magnitude. Although some previous work is available on this influencing factor, it seems that most of the studies paid little attention to it.

The residual stress distribution in welded box columns is usually that with high tensile stress (at least equal to σ_y) at the welds and compressive residual stresses at the center part of the component plates, whose value depends mainly on the weld size and geometry of the plate itself. This kind of pattern can be well represented for a single plate by a linearized one.

TASK GROUP REPORTS

The influence of the choice of one of these patterns has first been checked. Assuming the tensile stress at the corners equal to σ_y , the column curves for different values of σ_{rc} ranging from 0.05 to 0.95 σ_y have been computed. The assumptions made are the usual ones for the study of the strength of practical columns, in particular the initial out-of-straightness of the column is sinusoidally distributed with a mid-height value of 1/1000 of the column length.

One of the results was that a change of σ_{rc} from 0.45 to 0.95 σ_y has no practical influence on the column curve. The influence of the residual stress pattern becomes significant only for boxes with full penetration welds, i.e. with high values of σ_{rc} . The same conclusion can be made as to the value of the tensile stress at the welds which can be as much as 50% higher than the yield stress of the parent metal, due usually to the presence of the weld material.

The residual stress distributions chosen made it possible to study the strength of welded box columns with different geometry and weld size. Envelopes of column curves for square box sections with narrow component plates made of ASTM A36 steel were computed for box shape with medium-to-wide component plates and for different steel grades, with σ_y up to 65 ksi. A comparison with the SSRC recommended multiple column curves was made.

In summary:

- A) The purpose of this study is to investigate the strength of welded box columns;
- B) An appropriate choice of the residual stresses has been made as a first step;
- C) The ultimate strength of welded box columns has then been computed taking into account the variation of the geometry, steel grade, and weld size;
- D) It has been concluded that the SSRC Curve 2 can be used for whatsoever welded box column with yield strength less than 65 ksi.

AD-HOC COMMITTEE ON RESEARCH PRIORITIES

Chairman, J. S. B. Iffland, Iffland Kavanagh Waterbury

SSRC Research Needs

R. Bjorhovde, University of Alberta

The Structural Stability Research Council in 1975 established a Committee on Research Priorities that was charged with the task of conducting a survey of subjects in need of detailed and systematic research. The members of the committee were: J.S.B. Iffland, Chairman, R. Bjorhovde, S.J. Errera, T. V. Galambos, and R.M. Meith.

TASK GROUP REPORTS

The committee recognized at the outset that in some cases only relatively broadly described topics could be identified, observing that these problems had not been studied in detail in the past. Nevertheless, whether the subjects were to be narrow or broad in scope, it was felt that the results of the survey would be of significant benefit to structural engineers. The excellent potential of the Council was realized through the involvement of the many Task Groups that make up the technical core of the organization. Drawing on the knowledge of the many members of the Task Groups, a compilation of data on a wide variety of subjects resulted, the scope of which would have been difficult for any individual to cover.

In the presentation, the subject matter has been divided into a number of topic areas, and individual problems within each of these are described and analyzed in fair detail. The major areas have been chosen as the listing below indicates:

1. Strength and stability of columns
2. Laterally unsupported beams
3. Stability of steel building frames
4. Stability of shells and shell-like structures
5. Thin-walled metal structures
6. Plate-, box-, and curved girders
7. Miscellaneous research areas

The last item in the list covers subjects such as dynamic stability, composite columns and mixed construction, mechanical properties of steel in the inelastic range, local buckling, and stiffened plates.

TASK GROUP 3 - COLUMNS WITH BIAxIAL BENDING

Chairman, J. Springfield, C. D. Carruthers & Wallace, Ltd.

The Elastic-Plastic Behaviour of Restrained Columns

D. C. Stringer, Dominion Bridge Company, Ltd.

Double curvature bending of columns by major axis beams may result in the formation of end plasticity in the columns. The effect of the end plasticity on the subsequent stability of the column was investigated for cases where the axial load was above the Euler load.

An experimental program was conducted, involving seventeen tests on columns rotationally restrained by minor axis beams. The influence of the following variables on the behaviour of the columns was investigated:

1. Axial load
2. Minor axis beam stiffness
3. Minor axis beam load
4. Load path.

TASK GROUP REPORTS

Some test results are shown in Figure 1. For cases where the axial load is too close to the elastic critical load, instability of the column occurs soon after the formation of end plasticity. However, when the axial load is less than approximately 60% of the elastic critical load, the moment-rotation curve of the column exhibits a flat-topped appearance. Minor axis beam loads which produce single curvature flexure of the column may significantly reduce its major axis rotation capacity.

An analytical investigation was carried out, based on the idealisation that the restrained column remains elastic except at the ends where biaxial plastic hinges are assumed to form. Theoretical moment-rotation curves were obtained by simultaneously solving the differential equations governing the minor axis flexure and the torsion of the restrained column. Finite difference method was used.

Design charts were developed from which the required minor axis restraint could be obtained for a given column subjected to double curvature major axis bending and axial load. The derivation of the charts was based on the elastic critical load of an idealised (deteriorated) column in which hypothetical structural hinges in alternate flanges replace the plastic zones which actually form in a column of this type. The charts are applicable to cases where minor axis beam loads produce no out-of-balance moments on the column.

References

- (1) Horne, M. R., "Failure Loads of Biaxially Loaded I-Section Columns Restrained about the Minor Axis," Engineering Plasticity, ed. by J. Heyman & F. A. Leckie, Cambridge University Press, 1968.
- (2) Stringer, D. C., "The Elastic-Plastic Behaviour of Restrained Columns," Ph. D. Thesis, University of Manchester, 1972.

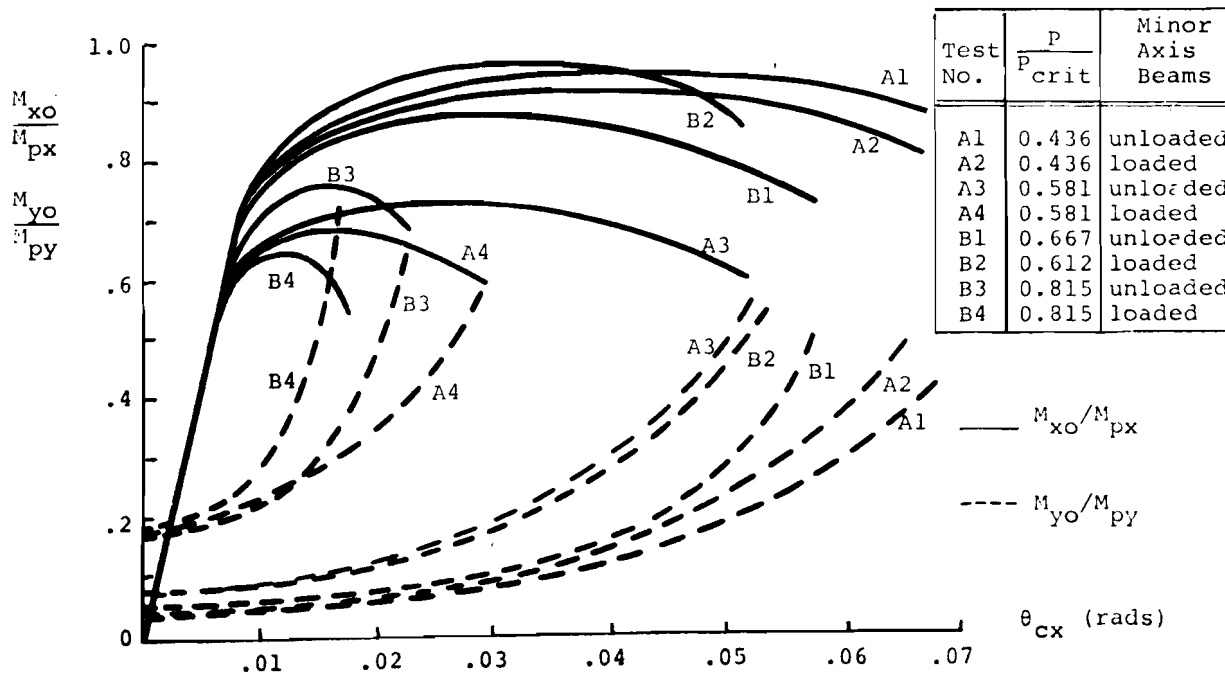


Fig. 1

TASK GROUP REPORTSHorizontal Test Rig To Study The Spatial Stability of Beam-Columns
With Imperfections

S. Vinnakota, University of Wisconsin-Milwaukee, Previously at Swiss Federal Institute of Technology, Lausanne.

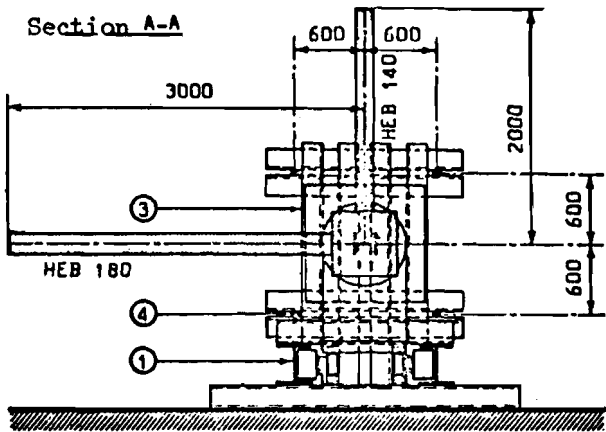
During the last ten years the reporter has developed a general theory to study the flexural-torsional stability of open-section steel beam-columns that includes the influence of material non-homogeneities and initial crookedness. In order to verify the validity of the theory, it is planned to conduct a series of full scale tests on biaxially loaded I-section columns. The general arrangement of the test rig, developed at the Institute of Steel Construction of the Swiss Federal Institute of Technology, is shown in Figures 1 and 2.

The test column and beam assemblage is held horizontally between two support frames ② and ③ connected to a floor beam ①. By varying the distance between these two frames, columns 0.8 to 4 meters long could be tested. The moving support frame ③, holds a hydraulic jack of 2000 kN capacity and moves along the floor beam on ball bearings as the column deforms under the load. The actual load applied on the column is measured by load cells at the fixed support of the test column. The connection between a column end and the corresponding support frame is by means of a rectangular box open on one side that holds a double knife edge support assembly. Thus, free bending rotations will be allowed at the supports while twisting and twisting rotations are prevented.

The columns of standard HEA 200 rolled section with imperfections will be tested with HEB 180 major axis beams and HEB 140 minor axis beams as shown in Figures 1 and 2. The major and minor axis beams are provided with two independent double-acting hydraulic jacks of 100 kN capacity, while the ends of the two minor axis beams are connected through a single, double-acting hydraulic jack of same capacity. Load cells are provided to measure the actual forces applied by these jacks. The two support frames are connected by four DYWIDAG high strength steel rods so that the system forms a closed loop.

The main hydraulic jack of 2000kN capacity is servo controlled, so that either load increments or deformation increments could be applied. This enables the complete load-deformation response of the beam-column assemblage to be determined. The first series of tests is underway at the time of presentation.

TASK GROUP REPORTS



- ① : Floor Beam
- ② : Fixed Support Frame
- ③ : Moving Support Frame
- ④ : Tension Rods
- ⑤ : Hydraulic Jaek (2000kN)
- ⑥ : Load Cells (2000 kN)

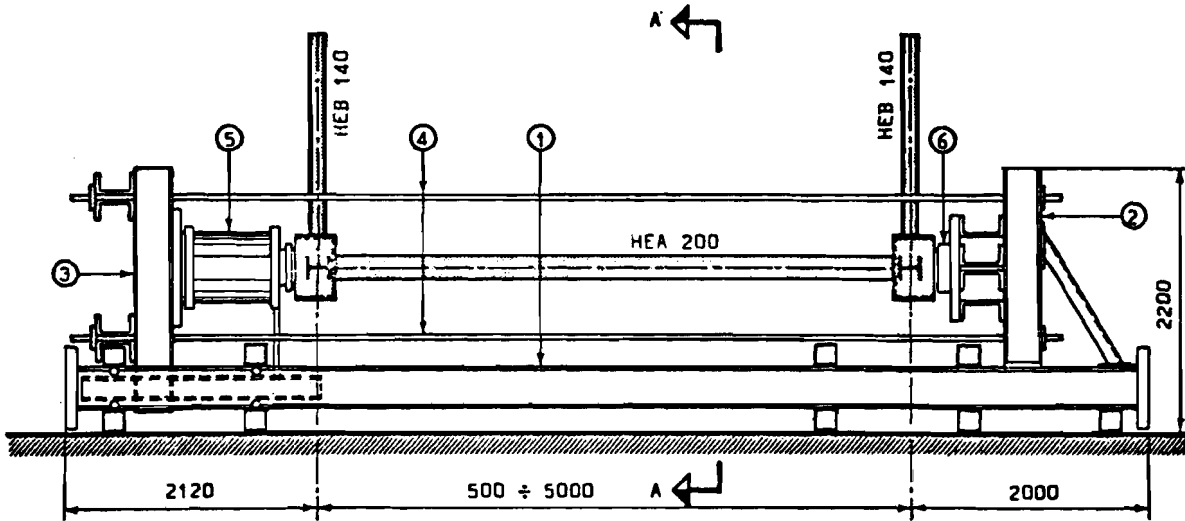
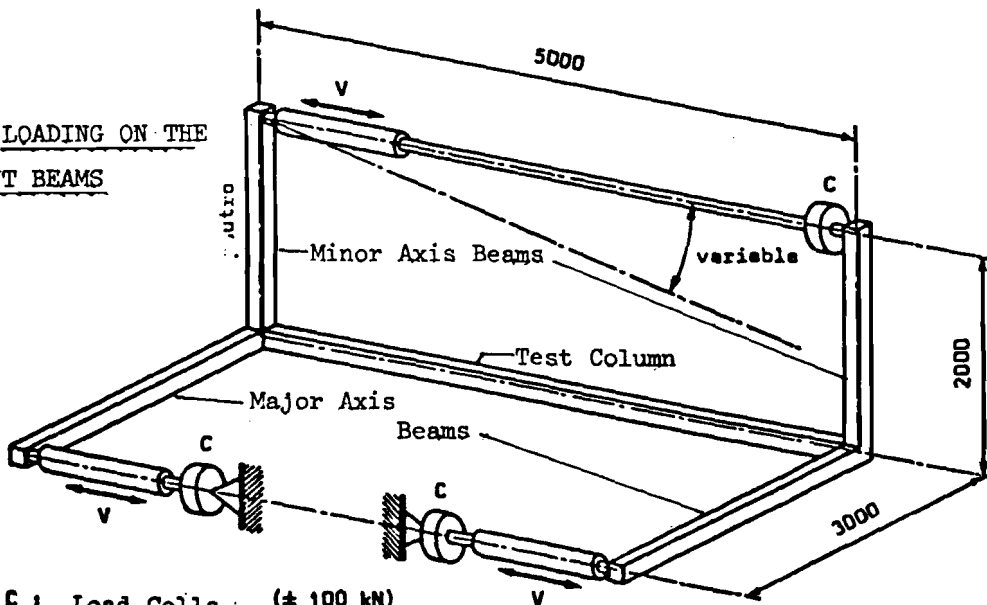


FIG. 1.- HORIZONTAL TESTRIG FOR BEAM-COLUMN SUB-ASSEMBLAGE

FIG. 2.- LOADING ON THE ADJACENT BEAMS



- C : Load Cells (± 100 kN)
- V : Hydraulic Jacks (± 100 kN)

TASK GROUP REPORTSTASK GROUP 7 - TAPERED MEMBERS

Chairman, A. Amirikian, Amirikian Engineering Company

Report on Tapered Member Project at Buffalo

George C. Lee, State University of New York at Buffalo

During the year 1978/79, research on tapered members at Buffalo can be described as follows:

1. Design interaction equations for tapered columns

The project investigators devoted a considerable amount of effort to formulate suitable interaction equations for the case of combined bending and compression of tapered members. The tapered members under consideration may have unequal flanges and may be either laterally unsupported or discretely supported along the tension flange. One of the results is to provide design curves for the estimation of end restraints in a lateral-torsionally continuous beam. This information is used in the determination of the allowable bending stress in the interaction equations.

2. Rigid frame design book

Under the sponsorship of the Metal Building Manufacturers Association and the Naval Facilities Engineering Command, a book dealing with the various aspects of single-story rigid frames consisting of tapered members has been prepared. This book principally will summarize most of the previous research activities on the subject of tapered members that are relevant to present-day engineering practice. The publication date of this book is probably in the spring of 1980.

Lateral-Torsional Buckling of Tapered Members, Using Finite Element Analysis

Craig J. Miller and Mohammed Kayum, Case Western Reserve University

Stiffness and geometric stiffness matrices for a web-tapered wide-flange member have been formulated. First, the total potential energy expression has been found. Assuming third-order polynomial functions for the displacement fields and incorporating the variations of the cross-sectional properties, these matrices have been obtained. They are expressed in terms of the small end, a parameter indicating the degree of taper, and the forces in the element.

Since these matrices are based on a correct potential energy expression, the solution accuracy is independent of the degree of taper. Only a few elements are necessary for a reasonable degree of accuracy, thus saving considerable time and labor. Results are presented for single-span beams with various end conditions subjected to axial force, end moments and transverse loads. This accuracy is compared with the available solutions and shown to be very good. Solutions are also given for single-span members which have segments with differing tapers, such as are frequently used as rafters in pre-engineered metal buildings.

TASK GROUP REPORTS

The formulation makes it easy to take into account the position of the transverse loads with respect to the centroidal axis of the member. The matrices derived here can also be used to solve continuous beam and frame stability problems.

TASK GROUP 16 - PLATE GIRDERS

Chairman, W. Hsiung, MTA Incorporated

Ultimate Strength of Plate Girders

S. Vinnakota, University of Wisconsin-Milwaukee, previously at Swiss Federal Institute of Technology, Lausanne

At present there exist confusingly too many ultimate strength models meant to be used for steel plate girder design. They all consider the post buckling strength of web developed through tension field action, in addition to the shear field action. Some also incorporate the reserve strength produced by frame action of stiffeners and flanges, and by panel mechanism. In general, they are based on assumed failure mechanisms and do not take continuity conditions into account. So, it is difficult to judge as to what is (are) the best model(s). Comparison with test results was not very helpful either, as the number of variables that effect the test results are too many. A better approach could be to compare the behavior assumed in these failure models with that obtained by step-by-step, second-order, elasto-plastic limit load analyses using numerical techniques now available.

Using STAGS (Structural Analysis for General Shells) computer program developed by Lockheed, two plate girders of similar dimensions except for their flange dimensions (Fig. 1) were studied up to failure and some of the results are presented in Figures 2 to 5. For the application of the finite difference technique each web panel was divided into 10x10 divisions, flange width into 4 divisions and the thickness of plates into 4 layers. Material considered was elastic-perfectly plastic with a yield stress of 235 kN/mm². The compressive flange of the plate girder was assumed to be supported laterally at the four stiffener locations, to prevent lateral torsional buckling. Nominal initial out-of-plane deformations for web plate were included in the calculations. Also shown in the figures are the ultimate strengths predicted by the models proposed by Basler, Ostapenko, and Rockey. Note that these models do not give any indication of the deformations.

It was observed that the principal tensile stresses in the panel are oriented essentially parallel to the panel diagonal, for both examples. Stresses normal to the top edge of the web plate acting on the compressive flange were found to be small, except naturally at the load points (Fig. 5). Failure of the girder G2 with thinner flange was due to extensive plastification in the compressive flange in the central panel, whereas the failure of girder G1 was due to excessive deformations and plasticity in the side panel.

FIG. 1
DIMENSIONS OF GIRDERS

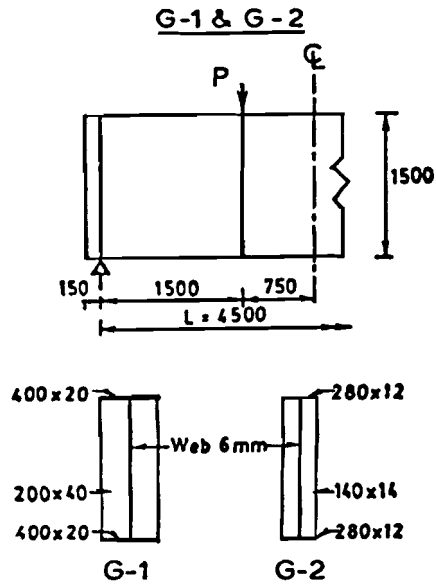


FIG. 2
LOAD VERSUS OUT-OF-PLANE DISPLACEMENTS OF WEB
(POINT E IN THE END PANEL)

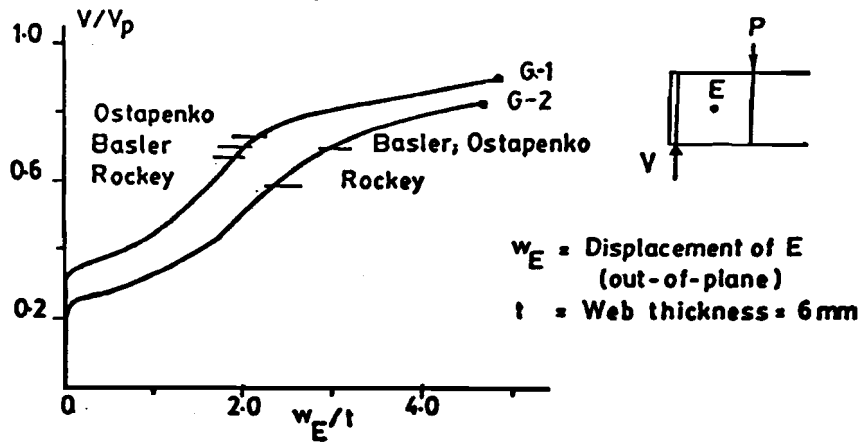


FIG. 5
STRESSES NORMAL TO THE TOP-EDGE OF WEB PLATE

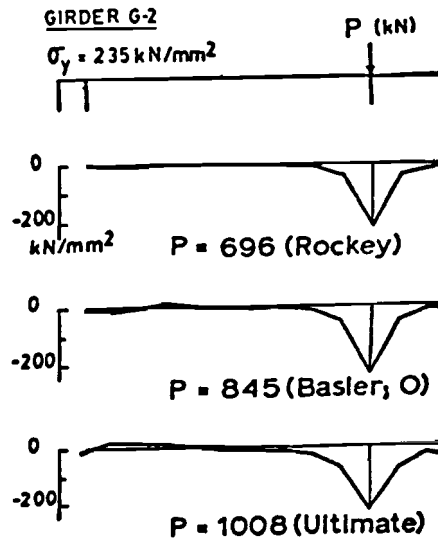


FIG. 3
LOAD VERSUS VERTICAL DEFLECTION OF LOAD-POINT

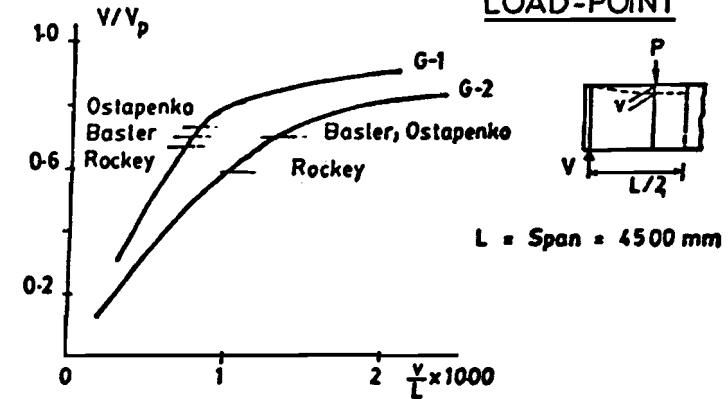
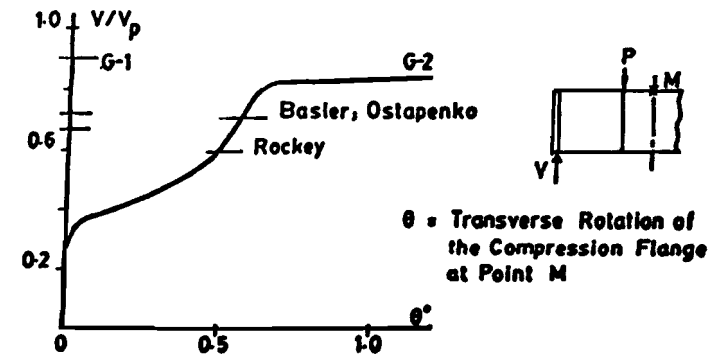


FIG. 4
TWIST OF THE COMPRESSION FLANGE



TASK GROUP REPORTSTASK GROUP 17 - STABILITY OF SHELL-LIKE STRUCTURES

Chairman, A. Chajes, University of Massachusetts

A General Analysis of Space Frame Stability and Geometric Nonlinearity

C. H. Yoo, Marquette University

A finite element formulation for general space frame stability and geometric nonlinearity based on the minimum potential energy principle is presented. The element stiffness and stability matrices were derived with and without degrees of freedom associated with warping torsion. The contribution of bimoment toward stability of unsymmetrical sections is included. The choice of displacement field functions is based on the assumption that the static deformation modes are similar to the buckling shapes. Hence, based on that assumption, the static analysis gives exact solutions regardless of the grid refinement and the eigenvalues are extremely fast converging upper bounds. The formulation has been programmed for use in digital computers and several appropriate examples are analyzed. The obtained eigenvectors for translations and rotations are indeed trigonometric waves as used in the classical solution technique. The examination of a wide variety of examples reveals that the bimoment contributions to axial and lateral torsional buckling are so small that they can be neglected safely for all practical purposes. It is also observed that the inclusion of warping degrees of freedom is not warranted in stability analysis in light of the computer time associated with the inverse iteration scheme in the eigen routine. The obtained eigenvalues with and without warping degrees of freedom do not differ more than 1% for all examples analyzed. The geometric nonlinearity due to amplification has been analyzed by incremental loading using the stability matrix derived.

TASK GROUP 4 - FRAME STABILITY AND EFFECTIVE COLUMN LENGTH

Chairman, J. S. B. Iffland, Iffland Kavanagh Waterbury

Lessons Learned from a Collapse Analysis of the Hartford Coliseum Roof

Erling A. Smith and Howard I. Epstein, University of Connecticut

The failure of the 2.4-acre coliseum roof of the Hartford Civil Center has been an economic as well as a psychological setback to the revitalization of downtown Hartford, Connecticut. Miraculously, the early morning roof collapse of January 18, 1978 into the empty coliseum caused no personal injuries. Only a few hours earlier that evening, several thousand spectators had been watching a basketball game.

Within days of the collapse, the city of Hartford retained engineers and formed a special committee of the city council to investigate the cause. The mayor commissioned an Academic Task Force to conduct an independent investigation. The authors were members of this task force. The Investigation Committee of the city filed its report in August, 1978. The initiating cause of the collapse of the space truss roof was found to be a design deficiency related to the inadequate bracing of top chord compression members.

TASK GROUP REPORTS

As with all structural failures, there are lessons that should be learned by the profession. It is sad to see errors in design, especially in a structure of such magnitude. However, the way in which the structure collapsed and the ability to be able to predict such a collapse and design against it, are the main lessons that should emanate from this failure.

This paper presents the major design errors found in the investigation, but only briefly. The main thrust of the article is to describe the collapse of the structure and to present an analytic model which predicts it. The model shows how the interaction of failed compression members and their bracing appears to have played an important part in the redistribution of the load, and in the eventual collapse of the structure.

Nonlinear Analysis of Portal Frames

G. J. Simitzes and J. Giri, Georgia Institute of Technology
A. N. Kounadis, National Technical University of Athens, Greece

A kinematically nonlinear analysis of an unbraced, rigid-jointed portal frame, which is elastically restrained at the base against rotation and loaded by eccentric concentrated and/or uniformly distributed loads, is presented.

The equilibrium equations are expressed in terms of the displacement components u_k (in-plane) and w_k (transverse) for all three bars ($k = 1, 2, 3$). The general solutions are expressed in terms of six constants for each bar (18 total). These constants can be evaluated by using the six boundary conditions of 18 equations in 18 constants, is then reduced to two nonlinear equations in two constants, through elimination of the remaining constants. These two equations are then solved by the simplex method of Nelder and Mead (Ref. 1). For details see Refs. 2 and 3. In addition, the buckling equations are derived and solved. The solution to the buckling equation is only used to establish which equilibrium position corresponds either to a bifurcation point or a limit point. Since the horizontal bar can be either in tension or in compression, the solution procedure distinguishes between these two cases.

Results are generated and presented for a number of geometries and load cases, in order to enhance our understanding of elastic behavior of frames (including postbuckling considerations) and to assess the effect of certain parameters such as amount of rotational restraint $[\beta = \beta l_1 / (EI)_1]$, bar slenderness ratio $[\lambda_k = l_k / \rho_k; \rho_k^2 = I_k / A_k]$, load eccentricity $[e = e / l]$, all for a square, uniform geometry frame ($l_k = l$; $(EI)_k = EI$; $A_k = A$ etc.). (See also Fig. 1).

Figure 1 is typical of the presentation of the generated data. In this figure the equilibrium positions are plotted as load, \bar{Q} versus the upper left joint rotation $\phi_1 (=W_{3,X})$, for a simply supported square frame, loaded symmetrically with various eccentricities. Note that the primary path for $e = 0$ is the \bar{Q} axis. Note also that the postbuckling paths are stable.

TASK GROUP REPORTS

On the basis of the data generated one may list the following important conclusions:

- 1) The effect of slenderness ratio ($\lambda_k = \lambda = 40, 80, 120, 1000$) on the non-dimensionalized response characteristics (including critical loads) is negligibly small.
- 2) The postbuckling response is stable (the frame is insensitive to initial imperfections).
- 3) The larger the amount of rotational restraint, $\bar{\beta}$, the larger the sway-buckling critical load (bifurcation point).
- 4) The horizontal bar can be either in tension or in compression.
- 5) For symmetrically but eccentrically loaded frames, as the load moves toward the centerline the bifurcation load decreases (for $\bar{e} = 0$), $\bar{Q}_{cr} = 1.821$; for $\bar{e} = 0.1$, $\bar{Q}_{cr} = 1.782$).

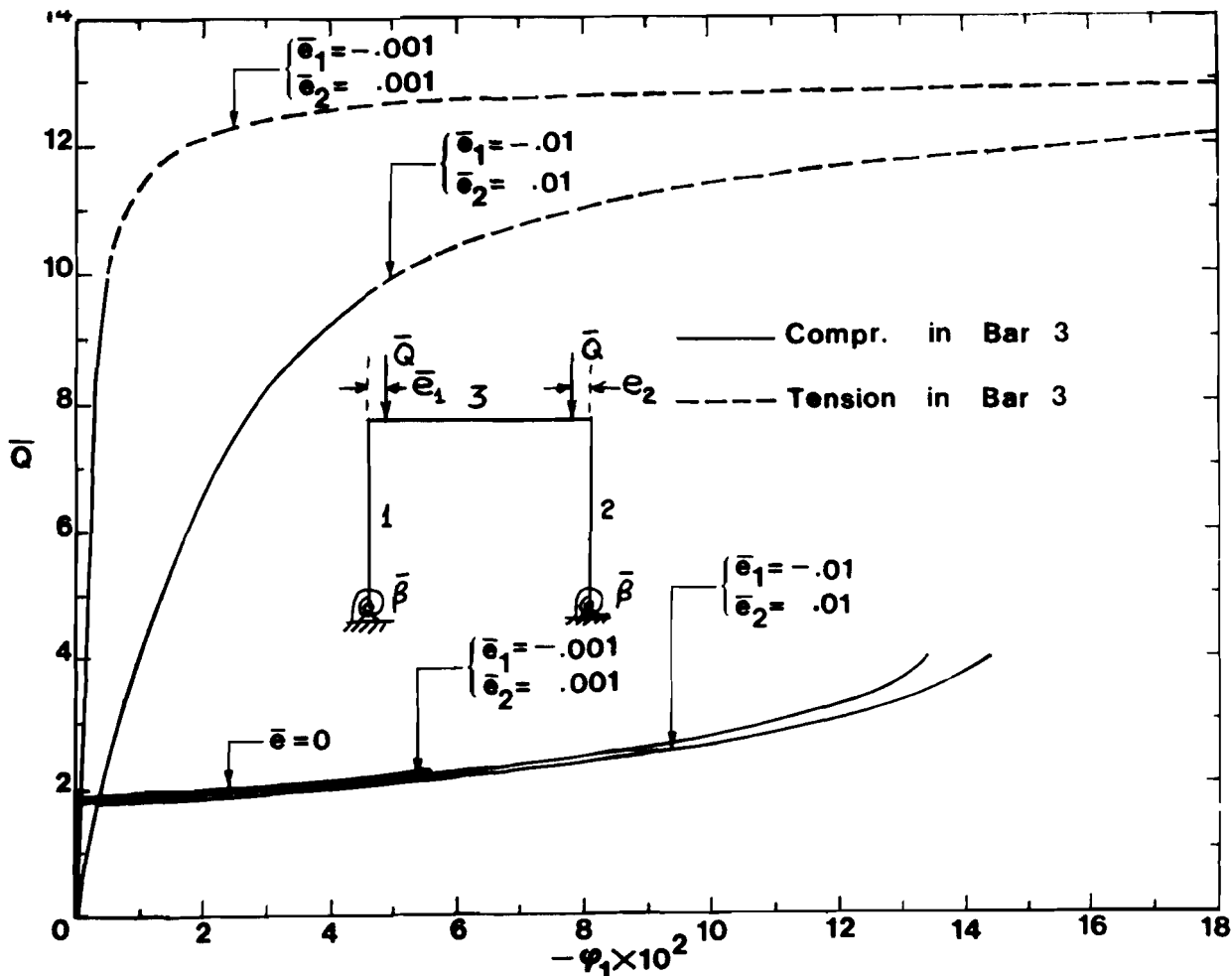


Figure 1. Equilibrium Response for a Symmetrically Loaded, Simply Supported Square Frame ($\lambda_k = 1,000$; $\bar{e} = 0$; $r_k = \mu_k = 1$).

TASK GROUP REPORTSACKNOWLEDGEMENT

The work is supported by the National Science Foundation under NSF Grant ENG-77-22443. This support is gratefully acknowledged.

References

- (1) Nelder, J. A., and Mead, R., "A Simplex Method of Functions Minimization," Computer J., Vol. 7, 1964, pp. 308-313.
- (2) Simitzes, G. J., Kounadis, A. N., and Giri, J., "Nonlinear Stability Analysis of an Eccentrically Loaded Two-Bar Frame," J. Applied Mechanics, Vol. 44, No. 4, December 1977, pp. 701-706.
- (3) Simitzes, G. J., Kounadis, A. N., and Giri, J., "Nonlinear Buckling Analysis of Imperfection Sensitive Simple Frames," Stability of Structures Under Static and Dynamic Loads. (Proceedings of the International Colloquium on the Stability ----). Published by ASCE, 1977, pp. 158-179.

Analysis of Inelastic Space Frames Subjected to Multicomponent Seismic Inputs

F. Y. Cheng, University of Missouri-Rolla

A numerical method has been developed for the transient response of inelastic space frames. The dynamic loading may consist of earthquake accelerations and time-dependent nodal forces. The constituent members are subjected to biaxial bending, torsion, and axial force for which the effects of interaction are included in the yielding surface formulation.

The incremental stiffness formulation has been employed for consideration of both nonlinearity and stress reversal. The nonlinearity considered in this work includes geometry and Ramberg-Osgood material behavior. An integration technique based on the Newmark-Beta approach has been employed for the dynamic response analysis.

The response behavior of various structural systems is expressed in terms of nodal displacements, internal forces, ductilities, and excursion ratios. The ductility and excursion are formulated on three different concepts of energy, rotation, and curvature.

This proposed presentation resulting from an NSF research project involves the dynamic parametric instability analysis of inelastic three-dimensional frameworks subjected to either dynamic forces or interacting earthquake motions. The paper will consist of mathematical formulations, numerical techniques, and numerical examples. The numerical examples to be presented will show the response behavior of ductility, stability, and energy absorption capacity of various structures influenced by parametric motions. The presentation will be particularly focused on the significant effect of multicomponent earthquakes on the internal forces of columns.

TASK GROUP REPORTSTorsional Buckling Study of the Hartford Coliseum

R. S. Loomis, Loomis and Loomis Inc.

The space truss system was 360 ft. by 300 ft. in plan and consisted of top and bottom chords running north-south and east-west, each spaced at 30 ft. o.c. and with the top chords offset 15 ft. from the bottom chords. The diagonals were at 45° in plan. An intermediate bracing system tied the midpoints of adjacent diagonals emanating from each bottom panel point and also tied these midpoints to the adjacent top chord midpoints. Members were made of four angles, heel to heel, to form a cruciform. Short struts from this system carried the roof beams and decking above. The structure was supported on four concrete columns, 45 ft. from the edges.

The collapse occurred in early morning during a rain on snow cover. A weight of 14-19 lbs./sq. ft. was on the ground and about 13 lbs./sq. ft. was estimated on the roof. There was a major fold running north-south just east of the centerline for the full width. A second line ran east-west just inboard from the northerly supports for the full length and a third line ran east-west just inboard from the southerly supports but only from the east edge to the north-south fold line. The roof beams were badly buckled. The struts were universally twisted and torn loose. The truss system that had been 21 ft. deep was reduced by two-thirds with twists and bends of every description.

In our study of the field conditions we noted so much twisting that we decided to check out torsional buckling. Using the theory set forth in Bleich (1952) and in Gaylord and Gaylord (1972) we calculated an equivalent radius of gyration for torsion for the four angle cruciforms. To obtain this we used an effective length factor, K_T , of 0.5. The critical loads on this basis were close to the lateral critical loads at a 30 ft. length. Based on an elastic STRUDL run, it appeared that 74 members were buckled under dead load so we substituted critical loads for members and re-analyzed the structure. The calculated deflection of 11.7 inches was close to the 12 to 13 inches measured in the field during construction but more members appeared buckled. A run with 90 buckled members had a 17-inch deflection.

We then sectioned the structure at midspan on a north-south line and calculated a total uniform load that would exist when all top chords were at their critical loads. For the space truss alone, this load was 50 lbs./sq. ft. and with allowance for compression in roof beams it was about 60 lbs./sq. ft. A section around the columns, cut through 11 compression diagonals, could carry 60 lbs./sq. ft. at critical loads. The dead load of 49 lbs./sq. ft. would therefore allow for about 12 to 15 lbs./sq. ft. of live load.

Our conclusion is that the collapse initiated just south of the northwest support when the compression diagonals in that region had reached their critical loads torsionally. The northeast corner then left its bearing and the center folded in.

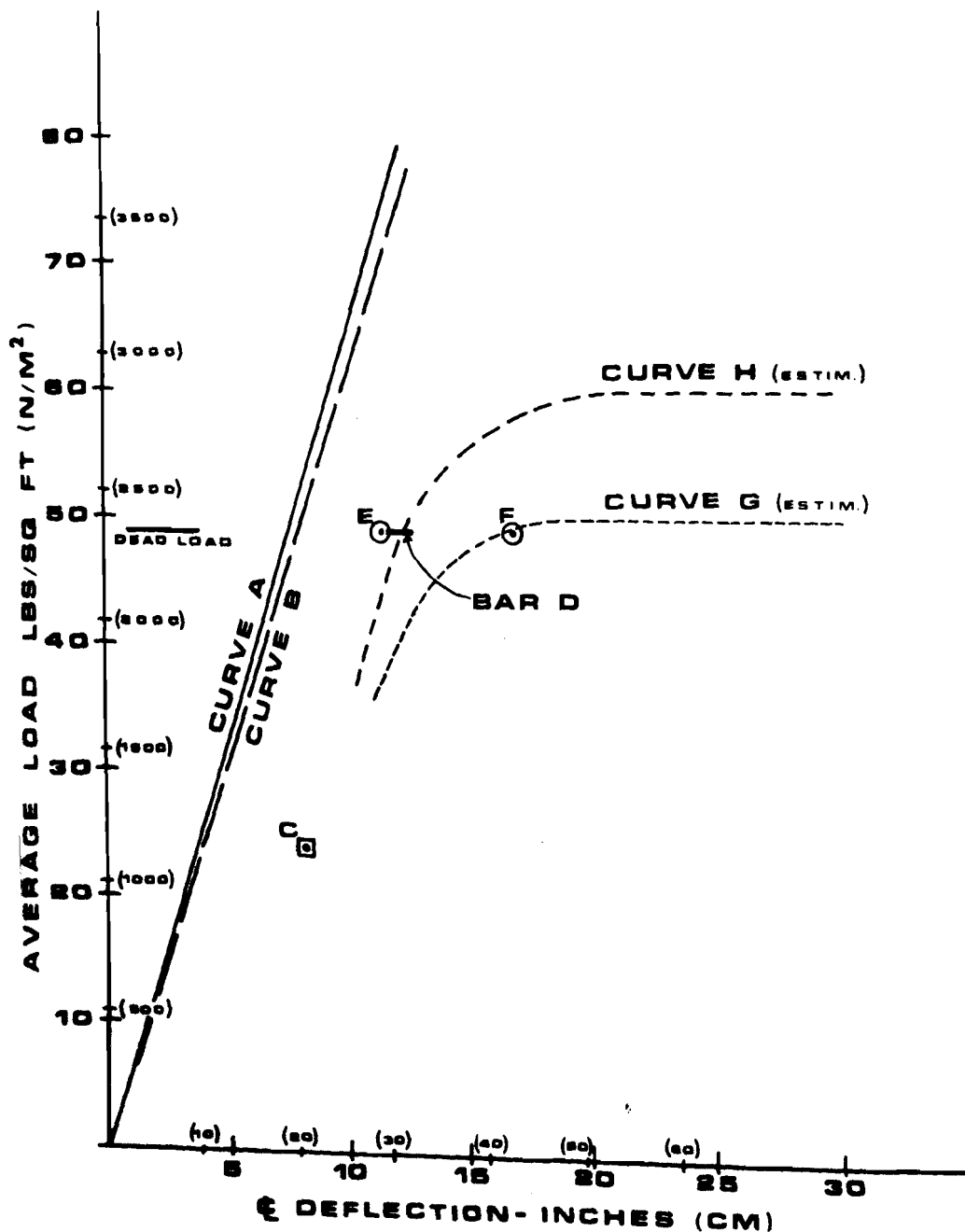
On the "LOAD-DEFLECTION PLOTS," curves A & B are elastic analyses; points C & bar D are field-measured deflections; points E & F are our

TASK GROUP REPORTS

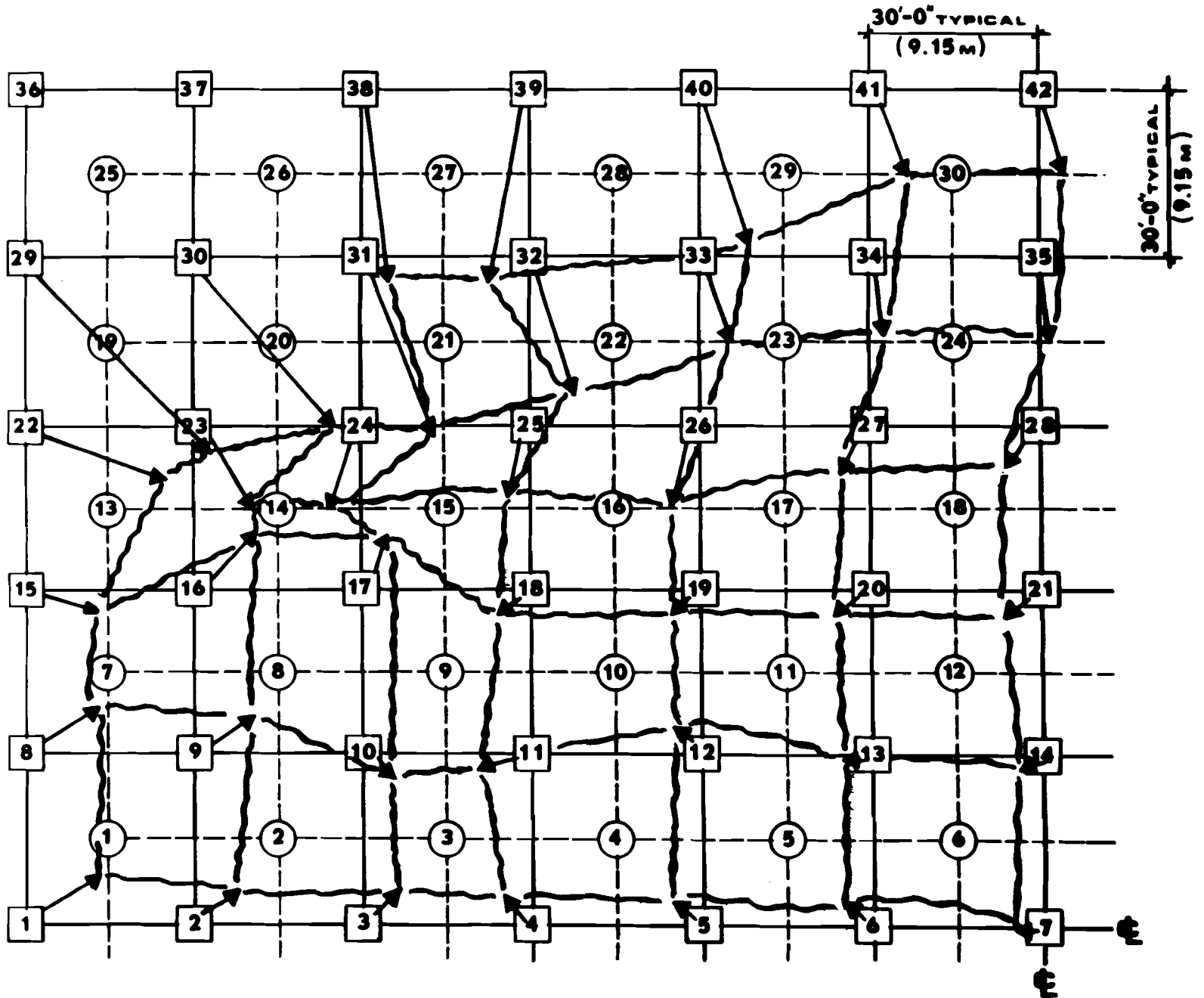
STRUDL runs with 74 and 90 members buckled. Curves G & H are our estimates of the behavior of the space truss alone and of the system with the roof members.

The mapping of the northwest quadrant shows how the top chord panel points moved towards the circled joint 14. The circled joint 20 is the support in this quadrant.

While we were able to obtain an excellent correlation between theory and actual field conditions, we hope that some testing of members similar to those in the Coliseum structure will be made to confirm or contradict our findings.



LOAD-DEFLECTION PLOTS



- NORTHWEST QUADRANT

TASK GROUP REPORTSTASK GROUP 8 - DYNAMIC STABILITY OF COMPRESSION ELEMENTS

Chairman, D. Krajcinovic, University of Illinois at Chicago Circle

Load Correlation Factors in Dynamic Stability

D. Krajcinovic, University of Illinois at Chicago Circle

The onset of instability of elastic structures under the action of dynamic loads depends not only on the geometry of the structure and the maximum intensity of the load but also on the load-time history. In other words, the two loads with identical maximum intensity will in general elicit different response of the structure if their load-time histories are different.

Therefore, it appears desirable to correlate a load with an arbitrary time history to the simplest case of a rectangular pulse (with constant intensity over a defined time duration). The benefits derived are quite obvious. Firstly, in many cases only the case of a rectangular pulse is amenable to an analytical solution. Secondly, in many cases the load-time history is not well known (or indeterministic) necessitating reasonable simplification even in case of purely numerical analyses. Finally, in experimental analyses it may not even be feasible to try to duplicate the actual pulse shape in the laboratory.

The Effects of the Joint Stiffness and of the Constraints on the Type of Instability of a Frame Under a Follower Force

A. N. Kounadis and A. P. Economou, National Technical University of Athens

In this paper the type of instability of a T-form frame with joint mass M subjected to a follower compressive force P applied at the joint is investigated on the basis of the dynamic (variational) and static approach. It is shown that the frame loses its stability through divergence and its critical load is independent of the joint stiffness when the support of the compressed bar is hinged; in contrast, if this support is fully fixed, the frame, depending on the joint stiffness, may lose its stability either through divergence or through flutter. However, the region of flutter-type instability is very limited which shows that the divergence instability is the rule and not the exception and accordingly, the simple static (stability) approach is applicable. Moreover, it is found that the presence of a concentrated mass has no effect upon the limit of stability of a non-conservatively loaded frame which may lose its stability through divergence.

Thus, a better insight for the actual mechanism of loss of stability of non-conservatively loaded frames is gained.

TASK GROUP REPORTSStability Boundaries for Reticulated Domes

S. M. Holzer, R. H. Plaut, and S. H. Shen, Virginia Polytechnic Institute

The stability of reticulated domes subjected to multiple independent loads is investigated with the aid of stability boundaries. The loads are represented by independent vectors and loading parameters, which define the spatial distributions and magnitudes of the loads, respectively. The stability boundaries separate regions of stability and instability in the load space, whose axes correspond to the independent loading parameters. A loading ray emanating from the origin of the load space defines a specific load combination (proportional loading). As the loads increase along this ray, a critical point may be reached that is associated with an initial loss of stability of the dome. The locus of these critical points forms the stability boundary. Accordingly, the stability boundary is a critical load interaction diagram.

The reticulated domes are represented by elastic, geometrically nonlinear, discrete models capable of predicting the nonlinear prebuckling deformations characteristic of shallow domes. Nonlinear programming techniques are used to construct the stability boundaries. On the basis of the stability boundaries, the effects of various load combinations and distinct element arrangements on the stability of the domes are studied. Numerical results are presented for four different domes.

Dynamic Stability Under Step-Loads; One-Degree-of-Freedom Models

G. J. Simitzes, Georgia Institute of Technology

The concept of dynamic stability of one-degree-of-freedom mechanical systems under suddenly applied loads of finite duration is presented. The systems considered are representative of structures with geometric imperfections and eccentrically loaded structures (see Fig. 1).

Concept. Since the system is conservative, the sum of the total potential (U_T^P) and the kinetic energy (T^P) (under load) is a constant (zero)

$$U_T^P + T^P = 0 \quad 0 \leq \tau \leq \tau_0 \quad (1)$$

where τ_0 is a time parameter, characterizing the load duration time.

Similarly for time greater than τ_0 (zero-load) the following equation can be written

$$U_T^O + T^O = U_T^O(\tau_0) + T^O(\tau_0) \quad (2)$$

The concept of dynamic stability is based on the following observations (see Fig. 2). (a) The zero-load total potential U_T^O has stationary values at $\theta = 0$ (stable) and at $\theta = A$ (unstable). (b) At the instant the load is released (τ_0) there is continuity in kinetic energy, or

$$T^P(\tau_0) = T^O(\tau_0) \quad (3)$$

TASK GROUP REPORTS

(c) A critical condition exists, if a load p (load parameter) applied for τ_0 time has imparted sufficient energy into the system so that the system can reach the zero-load unstable point on the total potential, $U_T^0(A)$, with zero kinetic energy. If this happens the motion can include positions $\theta > A$ and thus becoming unbounded.

Note that from Eq. (1)

$$T^P(\tau_0) = -U_T^P(\tau_0) \quad (4)$$

and thus

$$U_T^0(\theta = A) = U_T^0(\tau_0) - U_T^P(\tau_0) \quad (5)$$

This equation relates the applied load, p , to the displacement position θ (see Fig. 2) corresponding to the release time τ_0 . (d) Moreover, from Eq. (1) it is possible to find the expression for the velocity $\left(\frac{d\theta}{dt}\right)$ in terms of the load (p), position (θ), and geometry. Finally, solving for dt and integrating from zero to τ_0 , one obtains an integral equation relating τ_0 , θ , and load p . This equation in conjunction with Eq. (5) yield a system of two equations in p , τ , and θ .

Thus, critical conditions are obtained by either assigning τ_0 values and solving for p and θ , or by assigning p values and solving for τ_0 and θ . Because of the nature of the two equations, it is more convenient to assign values for θ and solve for p {from Eq. (5)} and τ_0 from the integral equations.

The two equations for the models considered are given by:

Model "A"

$$\left(\sqrt{2} - \sqrt{1 + \sin\theta_0}\right)^2 = p(\cos\theta_0 - \cos\theta) \quad (6a)$$

and

$$\tau_0 = \int_{\theta_0}^{\theta} \frac{(1/3 + \sin^2\theta)d\theta}{\left[p(\cos\theta_0 - \cos\theta) - (\sqrt{1 + \sin\theta} - \sqrt{1 + \sin\theta_0})^2\right]^{1/2}} \quad (6b)$$

Also for this model, the input equations are

$$U_T^P = KL^2 \left[(\sqrt{1 + \sin\theta} - \sqrt{1 + \sin\theta_0})^2 - p(\cos\theta_0 - \cos\theta) \right]$$

$$T^P = \frac{mL^2}{3} (1 + 3\sin^2\theta) \left(\frac{d\theta}{dt}\right)^2 \quad \text{where } p = 2P/kL^2.$$

m : the mass of each bar and $\tau = t\left(\frac{k}{m}\right)^{1/2}$: time parameter.

Model "B"

$$\frac{1}{2} = p(1 - \cos\theta) + \frac{e}{L} \sin\theta \quad (7a)$$

$$\tau_0 = \int_0^{\theta} \frac{d\theta}{\left[2p(1 - \cos\theta) + \frac{e}{L} \sin\theta - \sin^2\theta\right]^{1/2}} \quad (7b)$$

TASK GROUP REPORTS

where $U_T^P = ka^2 \left[\frac{1}{2} \sin^2 \theta - p(1 - \cos \theta + \frac{e}{L} \sin \theta) \right]$ $p = PL/ka^2$

$$T^P = \frac{1}{2} I \left(\frac{d\theta}{dt} \right)^2$$

I: moment of inertia about the hinge, and

$\tau = t \left(\frac{ka^2}{I} \right)^{1/2}$: time parameter. Note that the critical condition can be characterized by P_{cr} for each τ_0 or $(P\tau_0)_{cr}$, critical impulse, for each τ_0 .

Conclusions.

A) The ideal impulse ($\tau_0 \rightarrow 0$) and infinite duration ($\tau_0 \rightarrow \infty$) problems are special cases of the step load problem.

B) For small τ_0 , the corresponding p_{cr} value is very large. This suggests that there is a critical condition in material behavior, rather than in system response.

C) In deflection limited designs, ($\theta_{limit} < A$ see Fig. 2), critical conditions can be established if $U_T^O(A)$ is replaced by $U_T^O(\theta_{limit})$ in Eq. (5).

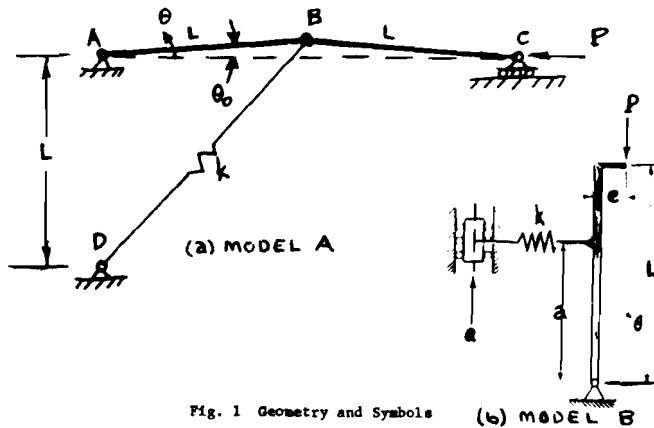


Fig. 1 Geometry and Symbols

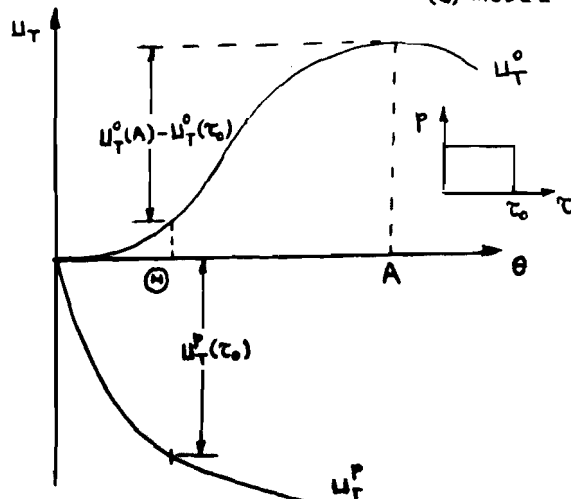


Fig. 2 Total Potential versus Displacement

TASK GROUP REPORTSInelastic Column Buckling Under Cyclic Loading

E. P. Popov, University of California, Berkeley

Diagonal bracing is widely used in structural frames for resisting lateral forces. In some applications, light members, such as rods, are employed. However, in larger structures, the braces are designed to resist both tensile and compressive forces. This is the preferred method of bracing for resisting seismic forces. In such situations, a brace may become sequentially buckled and stretch inelastically a number of times. This gives rise to the basic problem of inelastic column buckling under cyclic loading. The rate of load application in such cases is sufficiently slow to study the problem from experiments with axial cyclic forces applied in a quasi-static manner. In other words, the dynamic problem of the column itself need not be considered as would be essential in a study of forces caused, for example, by a blast. The behavior of an individual brace has a dominant effect on the overall structural response of a frame.

Based on experimental results, the phenomenon of inelastic column buckling of an individual member under cyclic loads is reasonably well understood. For example, see Ref. 1 where the behavior of a strut during a complete inelastic cyclic excursion is explained in qualitative terms. The behavior of a typical strut subjected to several cycles of load applications is shown in Fig. 1. The initial buckling load of approximately 200 kips for this pin-ended W6 x 20 10-ft. strut is in close agreement with the conventional AISC formula, providing the actual yield strength of the material is used and no factor of safety is applied. However, a dramatic decrease in the carrying capacity of this strut is observed after a complete cycle of reversed loading. The buckling load is only one half as large as it was initially.

By using refined cyclic stress-strain relations, with the aid of the finite element method, this highly nonlinear problem appears to be tractable. However, the solution would be complex, and it may not be evident why the column capacity decreases with an increasing number of inelastic cycles. An alternative analytical approach is suggested in Ref. 2, which helps to clarify the observed behavior.

Two main effects contribute to the precipitous decrease in the column capacity for inelastic cyclic reloadings. These are the Bauschinger effect exhibited by steel under reverse loading, and the induced curvature of a member caused by plastic deformations occurring during previous cycles. These two parameters can be used to establish the reduction factors, which can be used to modify the initial buckling capacity of a column depending on the previous loading history. This approach has been applied to three identical struts (the results for one of them are shown in Fig. 1) which were subjected to different histories of loading. For each strut, the first three cycles were analyzed in the above manner. Comparisons between the experimental results and the predicted ones are given in Table 1. For struts #3 and #4, the conventional AISC formula without a factor of safety was used to determine the first buckling loads. For strut #5, a correction for the first buckling load was necessary, since this strut initially was

TASK GROUP REPORTS

subjected to a tensile force causing yield of the material. For all other cases listed, both the Bauschinger effect and the plastically induced eccentricity effect reduction factors were applied. More details on this approach may be found in Ref. 2. Further research in this general area is needed.

Strut No.	3			4			3		
	1	2	3	1	2	3	1	2	3
Buckling Load No.									
Measured Axial Stress σ_a (ksi)	34.1	16.3	13.8	34.1	26.8	24.6	25.8	12.7	13.5
Predicted Axial Stress σ'_a (ksi)	32.3	13.1	10.4	32.4	24.9	21.7	27.3	11.6	11.7
σ'_a/σ_a	0.95	0.80	0.75	0.95	0.93	0.88	1.06	0.91	0.87

TABLE 1. Three Consecutive Buckling Loads for W6 x 20 10-Ft Struts with ℓ/r of 80

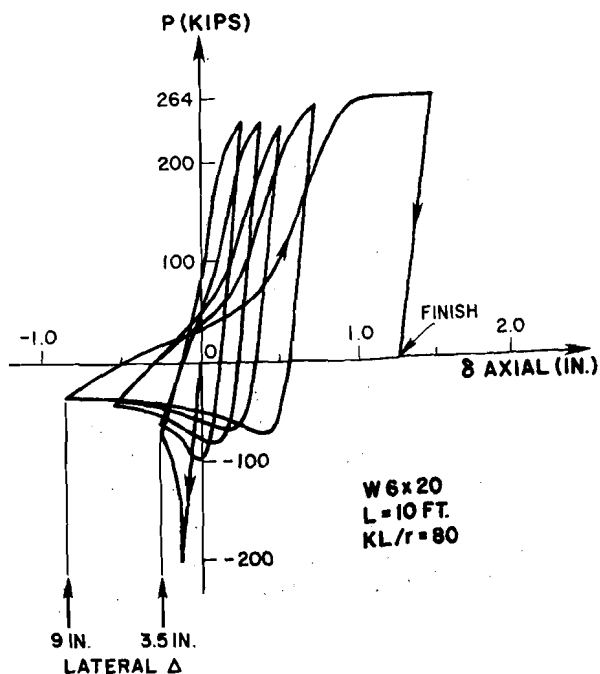


Fig. 1 Hysteretic Strut Behavior

TASK GROUP REPORTS

This work was supported by the National Science Foundation under Grant #ENV 76-04263 with Dr. S. C. Liu as Project Manager. The author is grateful for NSF's support of this work.

References

- (1) Popov, E. P., and Bertero, V. V., "Seismic Analysis of Some Steel Building Frames," 1979, ASCE Spring Convention, Preprint 3599, pp. 37-58.
- (2) Popov, E. P., "Inelastic Behavior of Steel Braces Under Cyclic Loading," Proceeding, Seventh U. S. National Conference on Earthquake Engineering, Aug. 1979, Stanford University, CA, (in press).

TASK GROUP 13 - THIN-WALLED METAL CONSTRUCTION

Chairman, W. W. Yu, University of Missouri -- Rolla

Buckling of Cold-Formed Steel Diaphragms

Craig J. Miller, Case Western Reserve University, Cleveland, Ohio

Cold-formed steel-corrugated diaphragms are widely used to resist in-plane loadings in pre-engineered metal buildings. The design of such diaphragms is controlled either by the strength of the fasteners, if they are widely spaced, or by buckling of the diaphragm acting as a plate loaded in shear if the fasteners are closely spaced. Calculation of the buckling loads for corrugated diaphragms has generally been done assuming the diaphragm behaves as a thin plate with orthotropic properties subjected to a pure shear field in its own plane. The analysis is normally done using the Rayleigh-Ritz technique with an assumed displaced shape for either simply supported or fixed boundary conditions. Such analyses assume the sheet to be a single piece; the fasteners connecting the sheet together are ignored.

The present work involves calculation of the critical load for corrugated diaphragms using the finite element technique. For calculation of the stress field prior to buckling, the plate is modelled by orthotropic, linear quadrilateral plane stress elements, with the connectors modelled as linear springs. This stress field is used as input to calculate geometric stiffness matrices for the calculation of the critical load. For the bending analysis, the sheet is modelled using 12-degree-of-freedom rectangular plate-bending elements. In the bending portion of the analysis, the connectors are ignored.

Results are presented for some small diaphragms without fasteners for comparison with previous work. As shown in the table below, the calculated critical loads correlate very well with those calculated using the method of Easley (1975). Results are presented for a large diaphragm with a variety of seam fastener spacings to demonstrate the influence of fastener spacing. It appears as if even a very wide spacing of fasteners is sufficient to cause the diaphragm to behave as if the sheet were fully connected along the seams.

TASK GROUP REPORTS

Table 1
Comparison of Present Results and Easley's Results

Case	Dimensions			Stiffnesses			Calculated N_{CR}		Exp. N_{CR}
	a	b	q	D_y	D_x	D_{xy}	Easley	Present	
	in	in	in	lb/in	lb/in	lb/in	lb/in	lb/in	
1	30	30	6.01	2070	2.92	6.05	16.0	15.4	20-22
2	30	30	3.48	3850	2.65	6.68	23.6	22.0	27-28
3	30	30	2.33	5350	2.38	7.42	31.1	28.2	30-40

Reference: Miller, C. J. and Springer, D. R., "Buckling of Plates Composed of Discretely Fastened Sheets," to be presented at The Third International Conference in Australia on Finite Element Methods, Sydney, July 1979.

Plate Collapse in Compression - Review of Recent Work in U. K.

C. D. Bradfield (Nuclear Power Company) and
J. B. Dwight (University of Cambridge)

The problem is to determine the ultimate strength of plate elements under longitudinal compression (Figure 1). Current effective width rules in both heavy and light gauge codes, are empirically based. A rigorous theoretical approach, such as that employed in recent column studies, has been lacking. The analysis of a plate is more difficult and must properly allow for:

1. Membrane action (large displacements).
2. Progressive spread of yield.

Important parameters to consider are:

3. Initial out-of-flatness (Figure 1).
4. Residual stress due to edge welds (Figure 2).
5. Shape of stress-strain curve (Figure 3).
6. Restraint conditions at longitudinal edges.

Research workers have in the past used elastic large-deflection analyses, taking edge yield as the criterion of failure. This relatively simple approach gives good results for unwelded plates having a sharp yield. But it is of limited practical value, because it is unable to handle satisfactorily the effects of residual stress (present in heavy construction)

TASK GROUP REPORTS

or of a curved stress-strain curve (light-gauge components).

We would draw attention to recent work in Britain in this field. Five authors have developed successful large-deflection elasto-plastic analyses which properly allow for items 1 through 4 above, the major features being:

<u>Author</u>	<u>Method</u>	<u>Yield Criterion</u>
Moxham ⁶	Energy Method, Ritz procedure	von Mises
Crisfield ²	Finite element	Modified Ilyushin
Frieze ³	Finite difference, dynamic relaxation	Ilyushin
Harding ⁴	Finite difference, dynamic relaxation	von Mises
Little ⁵	Energy method, Ritz procedure	von Mises

All assume that the material is elastic-perfectly plastic, with a sharp yield, so that the results relate more to welded plate structures than to light-gage construction.

The five conducted parametric studies, covering a range of w/t , out-of-flatness, residual stress, edge conditions. The results were not identical because of different simplifying assumptions in their theories. Figure 4, from a recent review¹, nevertheless shows a high degree of consistency. At the current stage of refinement Little's method is possibly the most reliable.

A new programme of individual plate tests was recently performed at Cambridge in a special 100-ton capacity plate testing rig, which provides precise conditions on the unloaded edges - either simply supported or clamped. 60 specimens were tested in 0.25 inch hot-rolled high yield steel. The initial out-of-flatness was carefully controlled, by appropriate pre-deformation of the plate; also the level of residual compressive stress, by laying welds of specified heat input along the unloaded edges. The results were generally in good agreement with the theoretical findings. At very low w/t the predictions of the theories were found to be a little pessimistic, and this is ascribed to the fact that they neglect strain hardening.

Figure 5 compares the current (1968) AISI effective widths with those obtained from Little's theory, for simply supported unwelded plates. The AISI values are seen to fall nicely between the theoretical

TASK GROUP REPORTS

curves for small and big out-of-flatness, suggesting that they will give satisfactory predictions when applied to material with a sharp yield. But light-gage material, unlike hot-rolled plate, often has a rounded knee to its stress-strain curve (Figure 3), which is an adverse factor in terms of local buckling performance - especially near $\beta = 1$, where the elastical critical and the yield stress are equal. One is therefore tempted to ask whether the increased effective widths in the 1968 code, compared with the 1981 edition, were fully justified.

The authors realize well that the AISI rules are founded on years of research and that the exact choice of effective width may, in any case, not be too critical in terms of overall member behaviour. But at the same time they make bold to suggest that in any future revision of the AISI code this fundamental data might be considered along with other evidence. They also believe that heavy-gage Americans might take note.

REFERENCES

1. Bradfield, C. D. and Chladny, E. "A review of the elastic-plastic analysis of steel plates loaded in in-plane compression", University of Cambridge, Department of Engineering, Report CUED/D-Struct/TR.77 (1979).
 2. Crisfield, M. A. "Full-range analysis of steel plates and stiffened plating under uniaxial compression", Proc. Instn. Civ. Engrs., V 59, December 1975, pp. 595-624.
 3. Frieze, P. A., Dowling, P. J. and Hobbs, R. E. "Ultimate load behaviour of plates in compression" in 'Steel Plated Structures' proceedings of a conference held in London, 1976, published by Crosby-Lockwood-Staples.
 4. Harding, J. E., Hobbs, R. E. and Neal, B. G. "The elasto-plastic analysis of imperfect square plates under in-plane loading", Proc. Instn. Civ. Engrs., V-63, March 1977, pp. 137-158.
 5. Little, G. H. "Rapid analysis of plate collage by live energy minimisation", Int. J. Mech. Sci., v19, pp. 725-744.
 6. Moxham, K. E. and Bradfield, C. D. "The strength of welded steel plates under in-plane compression", University of Cambridge, Department of Engineering, Report CUED/C-Struct/TR.65 (1977).
-

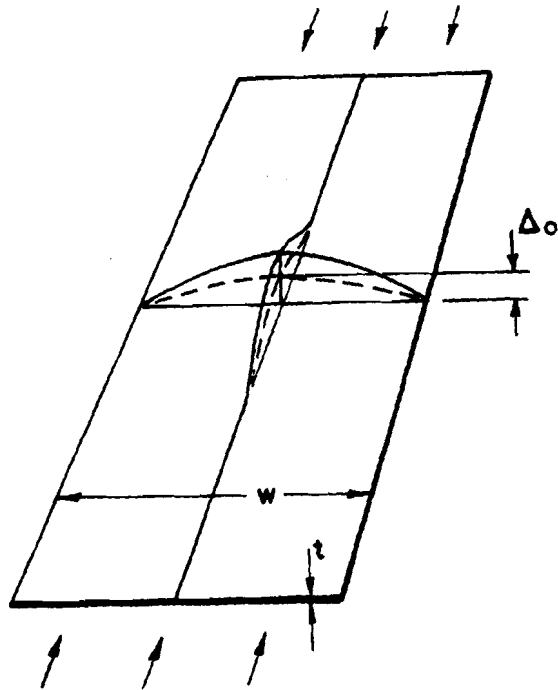
TASK GROUP REPORTS

Fig. 1 Plate element in longitudinal compression.
 Δ_0 = initial out-of-flatness (ripple component).

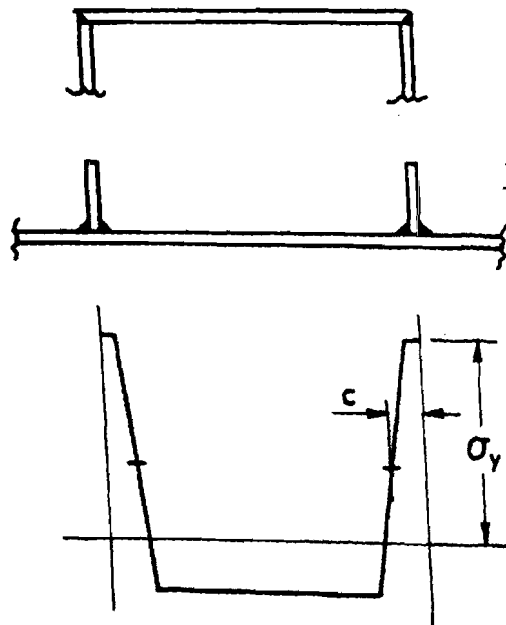
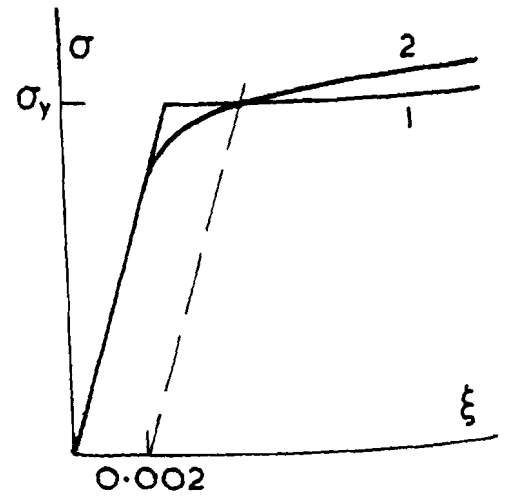


Fig. 3 Types of stress-strain curve
 1. Heavy gage (hot-rolled)
 2. Light gage

Fig. 2 Typical pattern of longitudinal residual stress in a plate element with edge welds. Material adjacent to welds is in yield tension.

TASK GROUP REPORTS

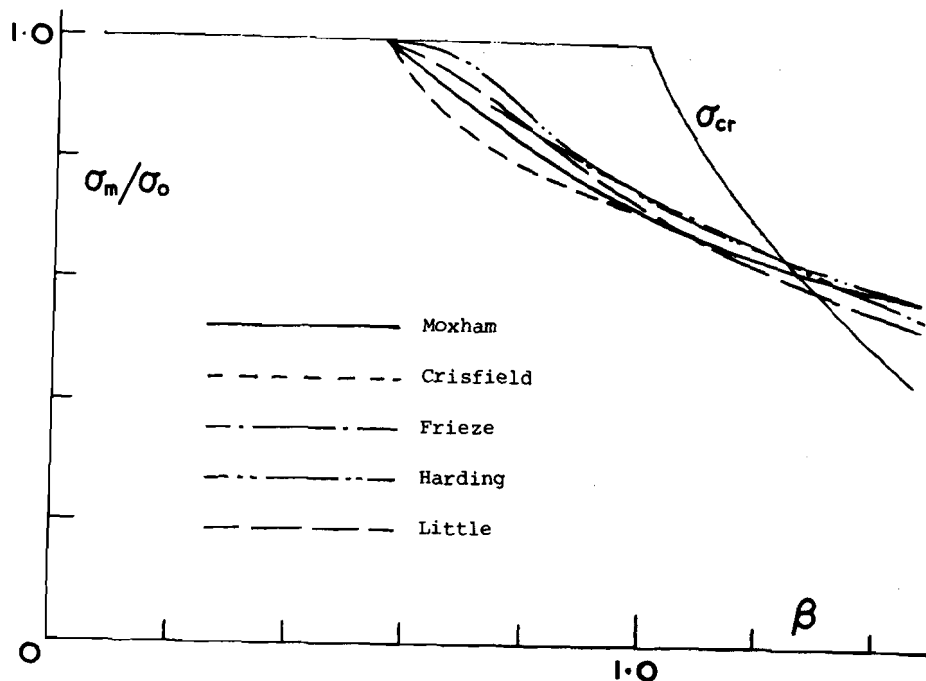


Fig. 4 Comparison of theoretical results for simply supported welded plates: $c = 3t$, moderate imperfection ($\Delta_0 = b/1000$). Better consistency was obtained for non-welded plates.

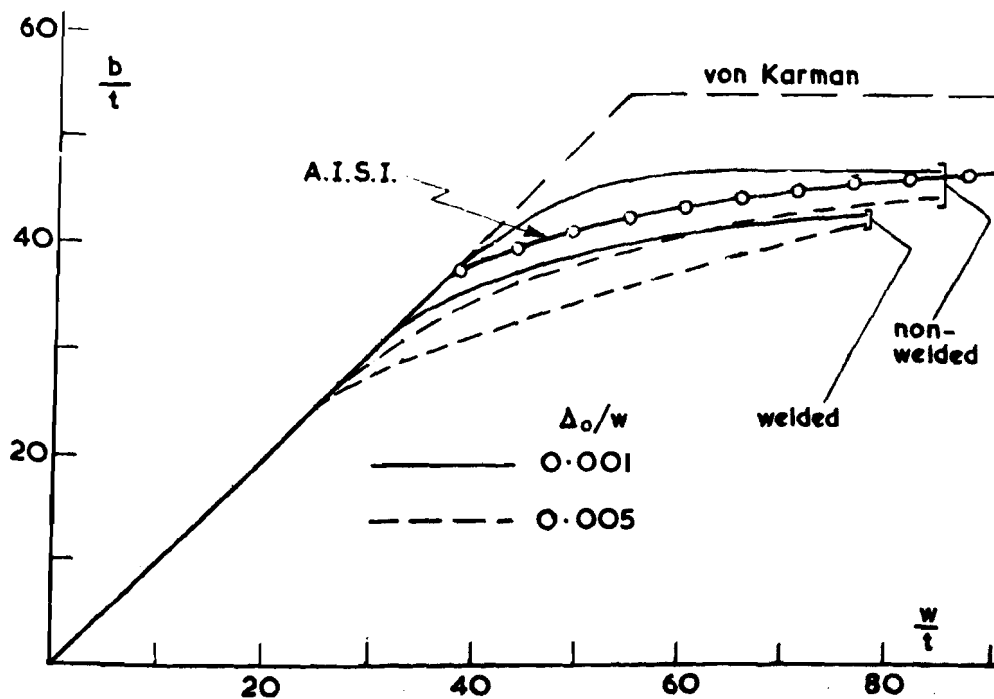


Fig. 5 A.I.S.I. effective widths for $\sigma_y = \text{ksi}$ compared with Little's theoretical findings.

TASK GROUP REPORTS

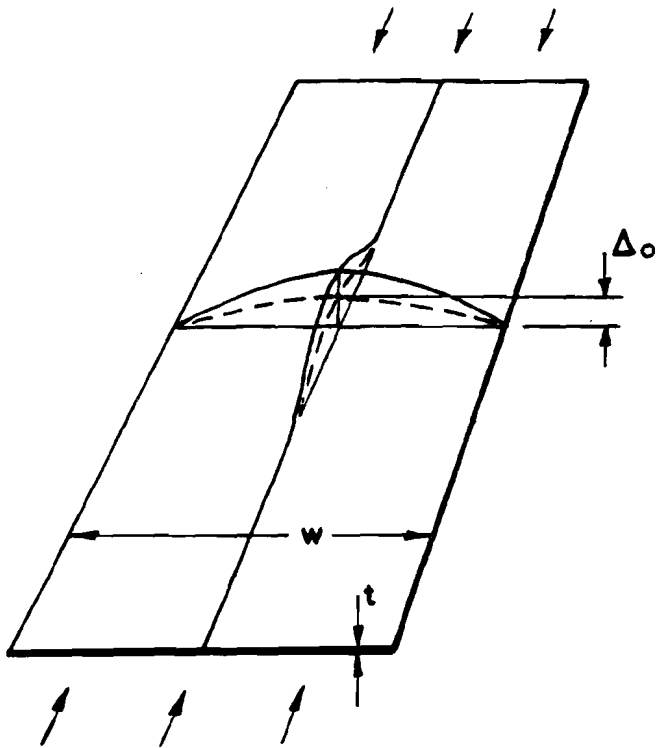


Fig. 1 Plate element in longitudinal compression.
 Δ_o = initial out-of-flatness (ripple component).

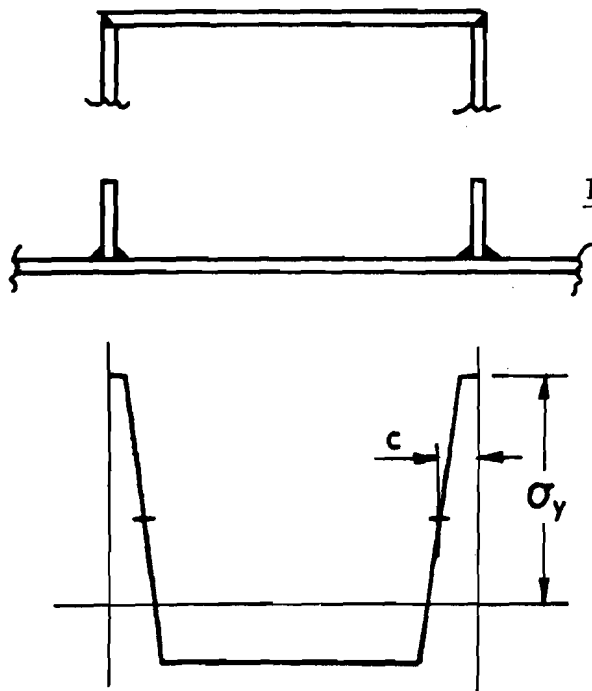
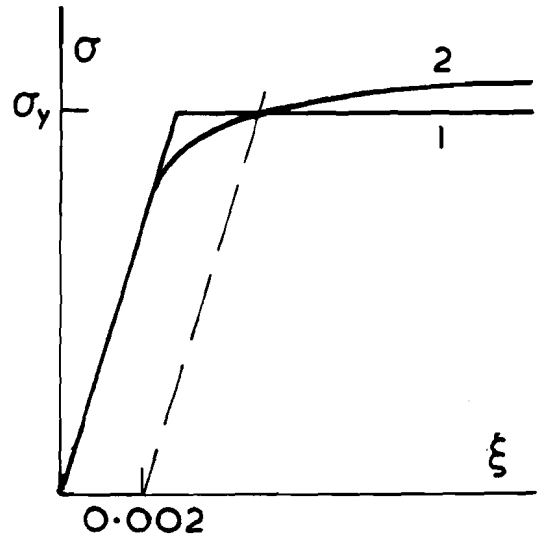


Fig. 3 Types of stress-strain curves:
 1. Heavy gage (hot-rolled).
 2. Light gage

TASK GROUP REPORTS

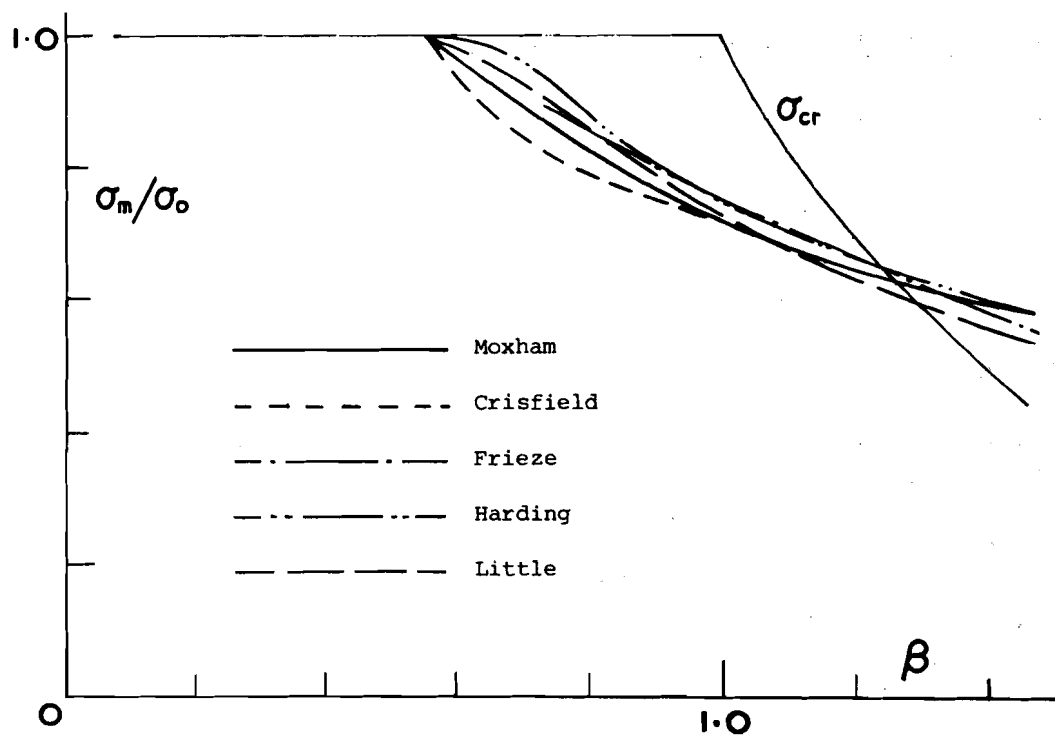
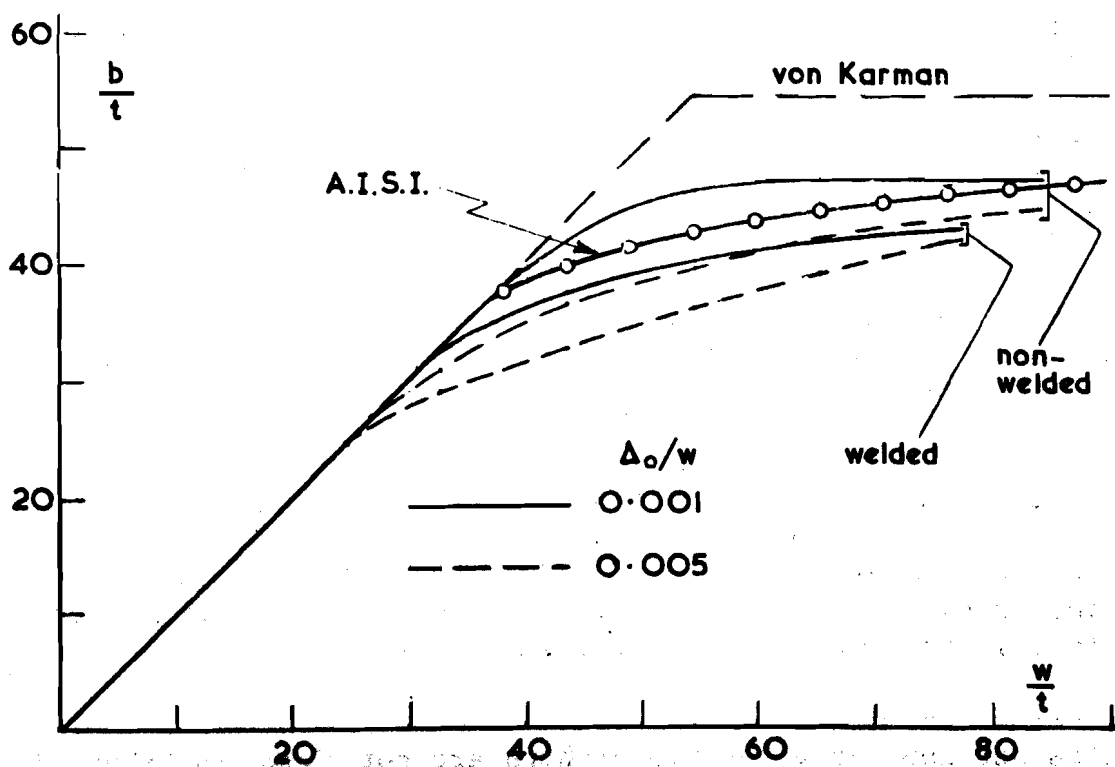


Fig. 4 Comparison of theoretical results for simply supported welded plates: $c = 3t$, moderate imperfection ($\Delta_o = b/1000$). Better consistency was obtained for non-welded plates.



TASK GROUP REPORTS

TASK GROUP 18 - UNSTIFFENED TUBULAR MEMBERS

Chairman, D. R. Sherman, University of Wisconsin - Milwaukee

Local Buckling Tests on Tubular Columns (36-50-100 ksi)

A. Ostapenko, Lehigh University

Tests and Design Formula

Local buckling of tubular columns above the proportional limit has been considered to depend on the diameter-to-thickness ratio (D/t), the yield stress (F_y), the intensity and distribution of residual stresses, initial imperfections, and on the plate thickness. The current design rules range from the conservative API specification (1) to a very optimistic DNV specification (2). For example, for some ranges of D/t , the local buckling stress according to the DNV specification is twice as high as according to the API specification.

Previous tests on tubular columns have given results with considerable scatter and this apparently led to the inconsistent specifications.

Of particular interest in this current study have been tubular columns fabricated by cold-rolling and welding and having the plate thickness over 1/4 inch (6 mm), as used in offshore towers, elevated storage tanks, transmission poles, etc. A systematic series of tests on tubular column specimens made of 345 MPa (50 ksi) steel and having diameters from 0.7 to 1.8 m (28 to 70 inches) (Refs. 3,4,5) lead to a formula which was in good agreement with the tests results (6). This year, four tests were completed on tubular specimens made of 250 MPa (36ksi) steel and two tests on specimens made of 690 MPa (100 ksi) steel. Figure 1 shows a typical test specimen. The results of these three sets of tests are shown in Figure 2, non-dimensionalized with respect to the static yield stress F_{ys} . The points deviate very little from the curve previously developed^{ys} for $F_{ys} = 345$ MPa (50 ksi).*

Although there was considerable variation in initial imperfections (out-of-roundness and local indentations) and in the intensity and pattern of residual stresses, no systematic effect of these parameters could be detected in these tests.

This, the formula for local buckling previously proposed for tubular members made of 345 MPa (50 ksi) steel (6) can be now considered as verified to be applicable to members made of 250 MPa (36 ksi) steel and, conservatively to those made of 690 MPa (100 ksi) steel. With a small coefficient adjustment this formula follows and is shown in Figure 2.

*Test results obtained by other researchers are not shown in Figure 1, mainly because of the difficulty in interpreting the level of the static yield stress; however, in general, they support this curve also.

TASK GROUP REPORTS

when $c < 0.07$

$$\frac{F_c}{F_{ys}} = 38c - 480c^2 + 2020c^3 \quad (1)$$

when $c > 0.07$

$$\frac{F_c}{F_{ys}} = 1.0 \quad (2)$$

Where:

$$c = \sqrt[3]{\frac{E}{F_{ys}}} \cdot \frac{1}{(D/t)} \quad (3)$$

F_c = local buckling stress

F_{ys} = yield stress

E = modulus of elasticity

D = diameter

t = wall thickness

Effect of End Conditions

In all the previous local buckling tests the specimens were compressed between two parallel surfaces, thus forcing the development of buckles around the full circumference. In a long column, however, local buckles would be mainly developing on the concave side rather than around the circumference. To determine whether or not the local buckling stress formula based on the parallel end (fixed end) tests was applicable to long columns, a total of twelve tests were conducted on 0.1, 0.2 and 0.25 m (4, 8 and 10 inch) diameter, 0.2 m (8 in.) long specimens.

Some of these tests had non-rotating parallel (fixed) ends and the others had one end fixed and the other supported on a system of plates and rollers which allowed free rotation and lateral translation. Although the distribution of buckles was different for the two groups, the local buckling stress intensity was practically the same.

The conclusion is thus that the formula proposed above may be used for determining the local buckling stress of long tubular columns.

TASK GROUP REPORTS

References

1. American Petroleum Institute, Division of Production, "API Specification 2B, " 2nd ed., API Specification for Fabricated Structural Steel Pipe, October 1972.
2. "Rules for the Design, Construction, and Inspection of Fixed Offshore Structures, " Det Norske Veritas, Oslo, 1974.
3. Ostapenko, A. and Gunzelman, S. X., "Local Buckling of Tubular Steel Columns, " Proceedings, Methods of Structural Analysis, Vol. II, ASCE, New York, N. Y., 1976, pp. 549-568.
4. Marzullo, M. A. and Ostapenko, A., "Tests on Two High-Strength Steel Large-Diameter Tubular Columns, " Paper 3086, Proceedings of the 10th Offshore Technology Conference, Houston, Texas, May 1978.
5. Ostapenko, A. and Gunzelman, S. X., "Local Buckling Tests on Three Steel Large-Diameter Tubular Columns, " Proceedings of the Fourth International Conference on Cold-Formed Steel Structures, St. Louis, Missouri, June 1978.
6. Ostapenko, A., "Local Buckling of Welded Tubular Columns," Proceedings of the International Colloquium on Stability of Structures under Static and Dynamic Loads (Washington, D. C., May 1977), ASCE, New York, 1977.

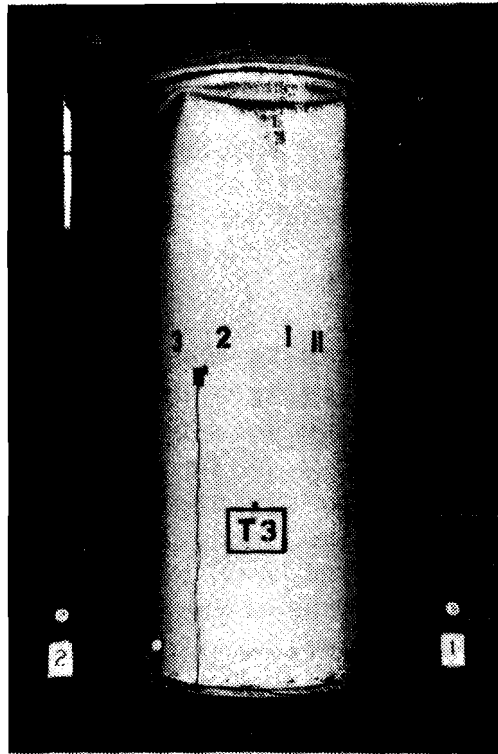
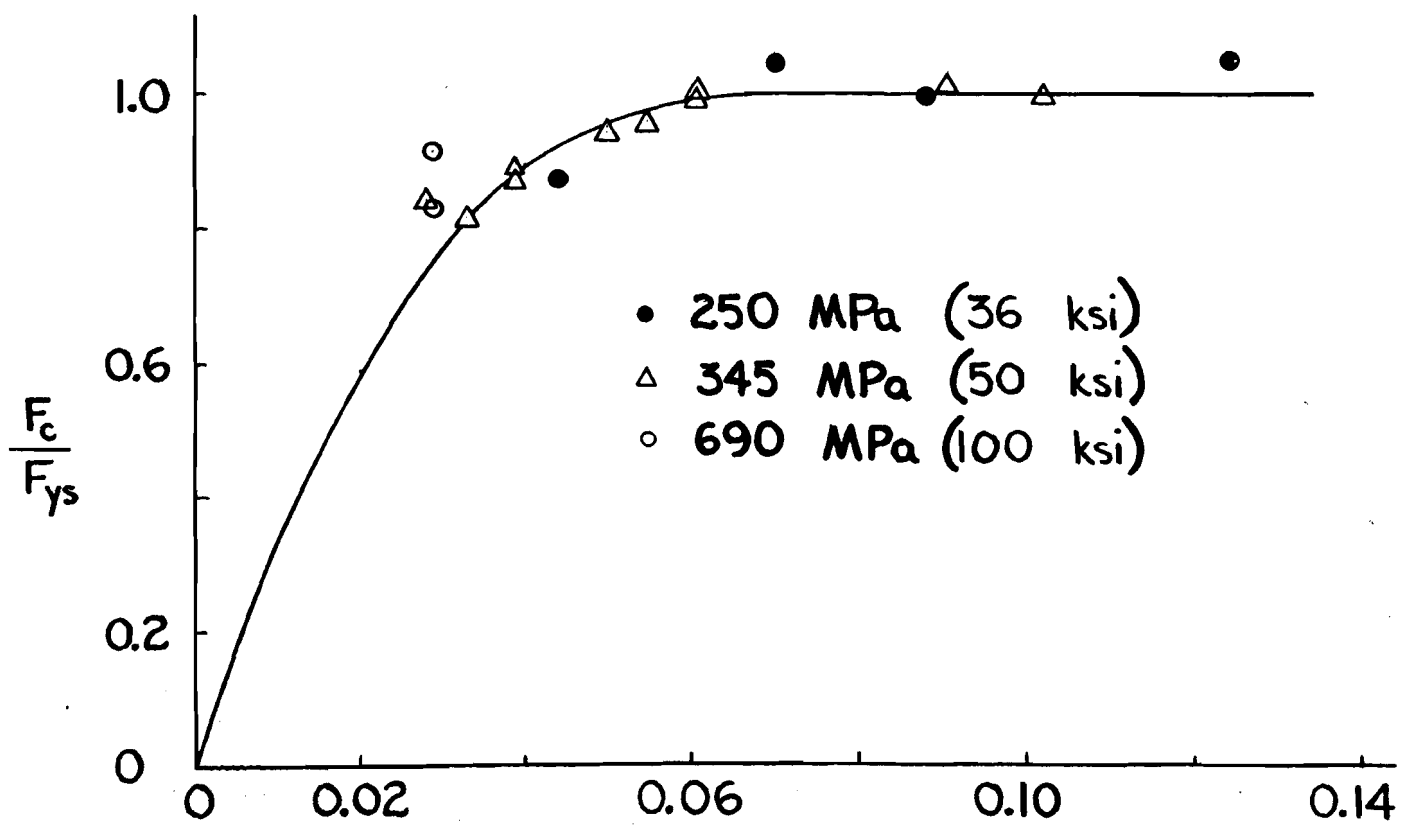


Figure 1 Typical Local Buckling Test



$$c = \sqrt[3]{\frac{E}{F_{ys}}} \cdot \frac{1}{D/t}$$

T A S K R E P O R T E R STASK REPORTER 15 - CURVED COMPRESSION MEMBERS

W. J. Austin, Rice University

Elastic Behavior of Arches

The object of this study was to obtain information and develop concepts that are useful in the elastic design of slender arch bridges. The concepts developed herein require only the data from first order analyses.

This study is restricted to symmetric parabolic arches of constant cross-section with hinged or fixed ends and of moderate or low rise (≤ 0.25 span). The arch is acted upon by a uniform dead load and a uniform live load which extends from the left support a variable distance. The dead and live loads are of uniform intensity on a horizontal level. The problem considered is shown in Fig. 1. Live/dead load ratios of 0.15 and 0.33 have been investigated. The following slenderness ratios are considered; for hinged arches: 50,100,200 and 300; and for fixed arches: 100,200,300 and 400. To reduce the number of parameters the distance from the neutral axis to the extreme fiber is assumed equal to 1.25 times the radius of gyration of the symmetrical box or I-type section. The loading considered and the proportions adopted are representative of long-span, steel highway arch bridges. A second order elastic numerical analysis which accurately treats large deflections was used. The arch axis was divided into 48 equal segments in the analysis.

Of special concern in this study is the determination of the least magnitude of loading which produces initial yielding, neglecting residual stresses. The yield loading is an upper limit for validity of these elastic solutions and, therefore, it provides a severe test for approximate formulas. Also, the yield loading may be regarded as an approximate failure loading for design purposes. To find the yield loading requires that the length of live loading which minimizes the load be determined as well as the point on the arch axis where yielding first occurs under this load. It was considered in the search procedure used that the live load always ends at a node point and stresses were calculated only at node points. Since 48 segments were used it is believed that these approximations did not introduce appreciable error.

The live load length which minimized the yield load was always roughly one-half the span. In a study limited to $L/r = 100$ and 200 for hinged arches and $L/r = 200$ and 300 for fixed arches it was shown that using one-half span live load resulted in a yield load magnitude which was less than 1 percent off the minimum value for hinged arches and less than 3 percent for fixed arches. Initial yielding occurred at the ends for fixed arches and near the quarter point of the arch axis (Not quarter point of span) for hinged arches. If for hinged arches a half span live load is used and stresses found at the quarter point the resulting yield load will be less than 1 percent greater than the absolute minimum.

TASK REPORTERS

The study gave a comprehensive verification of the common assumption that the axial thrust, P, and the corresponding stress, P/A, are always closely approximated by the values obtained by first order theory. The error in using first order theory values is less than 1 percent for 50 ksi yield and less than 2 percent for 100 ksi yield.

Bending moments (and the corresponding stresses) by first order analysis are conveniently classified as those due to rib shortening and those caused by the non-uniform live load distribution. The moments caused by rib shortening are symmetrical and roughly proportional to the total load. First order solutions give suitable approximations for moments due to rib shortening for all cases, even for slender arches. For slender arches, these moments are relatively small.

First order bending moments due to the partial live load are roughly anti-symmetrical and they cause approximately anti-symmetrical deflections similar in shape to the corresponding lowest buckling mode. In slender arches the axial thrusts interact with these deflections, thereby increasing the moments and deflections. The behavior is very similar to that of beam-columns. The following formulas give excellent approximations to the total moments.

For hinged arches,

$$M = M_s + \frac{(M_1 - M_s)}{(1 - W/W_{c,1})} \quad (1)$$

in which M_1 = total moment found by a first order analysis, W = sum of dead and live load intensities, Fig. 1, and $W_{c,1}$ = classical critical value of the load, i.e. the magnitude of load required to sustain a small perturbation from the undeflected position in the shape of the lowest buckling mode. In Eq (1) M_s = moment due to rib shortening, approximated for a parabolic arch with constant cross section by Eq(2).

$$M_s = \frac{0.13W_e L^2 (1 - 4z^2/L^2)}{\left\{ 1 + \frac{8}{15} \left(\frac{f}{L}\right)^2 \left(\frac{L}{r}\right)^2 \right\}} \quad (2)$$

in which f = rise, r = radius of gyration of cross section, z = horizontal distance to generic point from crown, and W_e = average load = total load/L.

TASK REPORTERS

For fixed arches, the corresponding formulas are as follows, for the fixed end.

$$M = M_s + \frac{(M_1 - M_s) (1 - 0.40W/W_{c,1})}{(1 - W/W_{c,1})} \quad (3)$$

and

$$M_s = \frac{-0.118W_e L^2}{\frac{3}{2} + \frac{2}{15} \left(\frac{L}{r}\right)^2 \left(\frac{f}{L}\right)^2}$$

When these formulas are used to compute the maximum total stresses due to axial and bending stress at the quarter point with half span live load, the maximum error for hinged arches is 2.78 percent for $\sigma_y = 50$ ksi and 8.2 percent for $\sigma_y = 100$ ksi. The maximum error in the total stresses at the end of fixed arches due to half span live load is 5.8 percent for $\sigma_y = 50$ ksi and 10.9 percent for $\sigma_y = 100$ ksi. These results are restricted to slenderness ratios, L/r , of 100 and 200 for hinged arches and L/r equal to 200 and 300 for fixed arches.

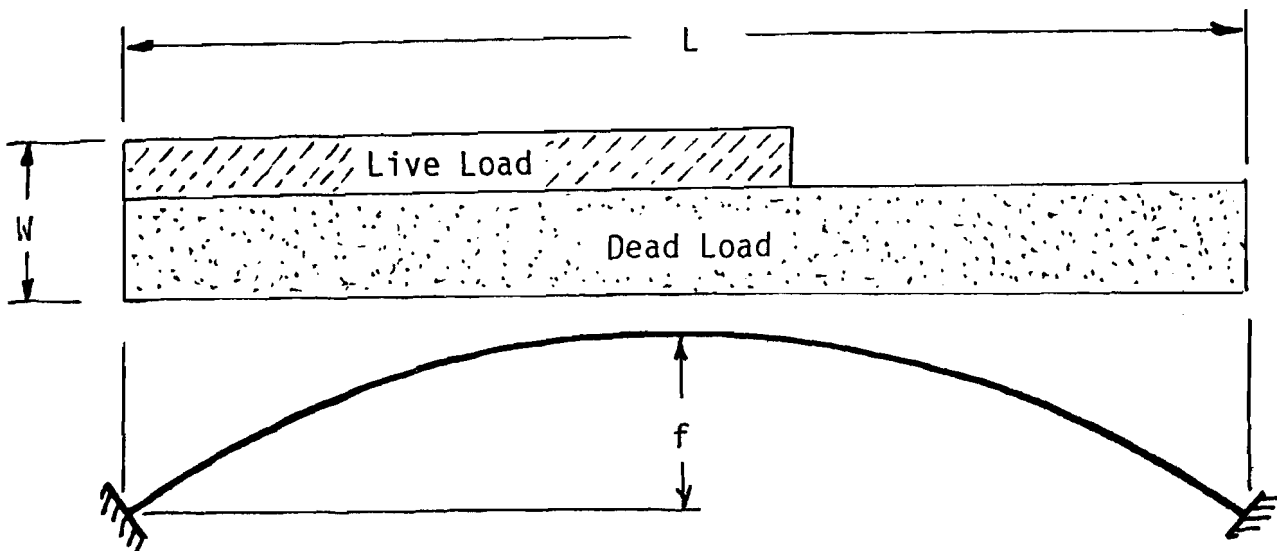


FIG 1 NOMENCLATURE



J. L. Durkee, E. P. Becker, D. T. Wright, R. S. Loomis

P A N E L D I S C U S S I O N

STABILITY OF SPACE FRAME STRUCTURES

MODERATOR: Jackson L. Durkee, Consulting Structural Engineer

PANELISTS: Robert S. Loomis, Loomis and Loomis, Inc.
Douglas T. Wright, Ontario Deputy Minister of
Culture and Recreation
Edward P. Becker, Lehigh Structural Steel Co.

* * * *

Jackson L. Durkee

This panel discussion type of presentation was first put on by the SSRC 10 years ago this month. So this is what we might call the 10th Anniversary panel. The first was held at New York University in 1969 and, just by coincidence, I was the moderator. So here we are 10 years later. The subject in those days was "Building Column Stability" and the prime motivation of the panel discussion was that we felt that it was time to have a session where the practitioners did the talking and the researchers did the listening. Now, please understand that we have nothing against researchers ... some of our best friends are researchers. But it seemed as though it would be opportune to have a session of "feedback," and so we did and it has been a custom since then; and I trust will continue.

One of the speakers in that first seminar was a young gentleman named Jerry Iffland, and, as has already been remarked, he has moved along in Council circles, and now serves as our chairman. So I would warn the speakers this evening to watch out for these extracurricular speaking duties; you can end up getting involved beyond your expectations.

Our first speaker, Robert S. Loomis, whom we have already heard from, will be speaking in place of Richard Tomasetti of Lev Zetlin Associates. Dick called in ill earlier today, so we are fortunate in having Bob Loomis to pick up his spot on the program. Bob Loomis is a graduate of M. I .T. with two degrees in the 1940s, and has been a principal of the firm of Loomis and Loomis, of Windsor, Connecticut, from 1958 to present. His firm is consulting in the areas of structural engineering and soil mechanics. He says it's a small family office specializing in structures for architects.

Bob will reconstruct some of Lev Zetlin's findings on the Hartford Coliseum investigation, and present some further comments of his own. It is intended that each speaker will present his views for about fifteen minutes, and then during the second hour we will have the customary questions, discussion and hopefully some argument.

PANEL DISCUSSIONRobert S. Loomis

I just found out about my participation on this panel late this afternoon so I don't really have anything prepared and I don't have slide demonstrations.

Our firm did work with Lev Zetlin Associates on the investigation of the Hartford Coliseum collapse. I think most of you know that it went down in January of last year. It went down in the early morning hours when nobody was in it. It had about thirteen pounds per square foot of snow load at the time, at best estimates. There was 14 to 19 psf of snow lying on the ground around the area. The structure was 360 ft. in the east-west direction, 300ft. north-south and was supported on four concrete columns that were about 7ft. square. It was a space truss. The members were made up of four angles, back to back in a cruciform section. Top and bottom chords were 30 ft. on center and they were offset 15 ft. When we first came on the scene, of course, it was a mess. Everything was pretty much hanging loose.

Our first job was to secure the general area and to be sure that people who had to go in and out to get equipment and various other things, were operating under safe conditions. The hardest part was that, in coming down, the roof had broken some cantilever concrete roof sections loose, but not completely off. And there were shops in the building along two sides, to the south and east sides of the Coliseum structure. These members were dangling on some damaged block walls, and we had to go in and pick the pieces apart, hopefully without throwing them through sheet rock walls into the adjacent shops. We were stopped in the middle of that work by a rather nasty snow storm. Things were left dangling for a day or two. It was kind of a hairy time for those first few days. A hairy time that fortunately, the press never picked up on. Only those of us working at the site really understood how bad some of those things were lodged. As far as the roof structure itself was concerned, the most obvious factors from above were a major north-south fold line just to the east of the center section; an east-west fold line that was one bay inboard from the northerly supports all across the structure, and a shorter east-west fold line that went from the east edge into the north-south fold line down in the southeast corner. There were several places where plates that connected members were torn. Generally we decided that those were pretty much a matter of what happened during the fall. There were some very badly bent connections plates in the center section. These were 3/4 in. plates that measured about 3 ft. across that had folded over 180 deg. on themselves. The top chords running east-west broke loose from these joints and the member ends shot past each other by fifteen feet under the compressive forces. The roof structure was above the truss system. There were beams running in the east-west direction that spanned 30 ft. and framed into girders that were running in the north-south direction over the top chords of the truss, and there were very little struts, 15 ft. on center that carried the girder reactions down to the truss

PANEL DISCUSSION

systems. The beams of the superstructure near the middle were very badly bent indicating that there was a good deal of force in them and the struts that supported them were virtually demolished. The system apparently, and I say apparently, because we had no idea what the designer had done, but apparently he designed as though the compression members were 15 ft. long. In fact, they were 30 ft. long with a bracing system at their midpoint. The bracing system, as most of you who were here this afternoon saw in Prof. Howard Epstein's slides, was an eccentric brace. There were some bent plates which went up between the angles at the cruciform and the bracing members were connected well away from the angles. I think there was something like 11 in. of eccentricity. Lev Zetlin's office analyzed the effectiveness of the bracing and did evaluate the spring constants. As I recall, they found that the effective length of the members ranged anywhere from 15 to around 25 ft. This was for lateral buckling in the elastic range. They then went through a very careful and rather elaborate computer study in which they evaluated the post-buckling behavior of the truss members. They analyzed the relationship between the axial forces and the chord shortening for all members in compression. They increased the load step by step on the truss as they found members buckled. They substituted an equivalent buckling load at that point, and they also allowed for the post--buckling effect of each of these members. I can't go into much detail on this because I didn't work with them on it, but I know that was their basic approach. On that basis, they came to a very similar conclusion as that which Professor Epstein showed this afternoon. They were getting lateral buckling on top chord members at loads of under 70 psf. In the official report I believe that all of the top chords were finally buckled at the third bay from the east end at a 20 psf live load, whereas Professor Epstein showed that they were in the fifth and sixth bays. This, I believe, is fundamentally a difference in evaluation of some of the bracing and how far you model the end restraints. Obviously, not everyone is going to look at it in quite the same way. So their conclusion was that it collapsed at about 70psf total load. They had a dead load of around 54 psf., I believe, which would give about a 16 psf live load on the structure at the time it became unstable and collapsed. And it was attributed pretty much to a top chord buckling failure on those chords that ran in the east-west direction, which was the long way of the span.

I'm trying to recall some of the details of the report. It was last August when I last read it. Had I known that I was going to be here I would have been better prepared and better able to explain more of the main points. I have described fundamentally the mode of the collapse and the approach of the investigation. The final positioning of the structure, of course, was on the floor. It fell from a height of about 80 ft. above the main floor. The bottom chord landed on the main floor at the middle and followed the shape of the seats going around the Coliseum. There were a number of very odd breaks as far as concrete work is concerned. There was one steel member that actually broke off and penetrated a reinforced concrete wall, there were other localized places where members had double over and broken through

PANEL DISCUSSION

the concrete seating causing some concrete damage as well. Each of the four supports for the space truss system had a shoe attached to the truss. This shoe had a concave spherical surface which sat on the matching convex surface of a loose intermediate plate which in turn sat into a recess in the bearing plate which was anchored to the concrete pier. There was a very slight lip around the bearing plate. All four corners were free to rotate. The north-west corner was restrained laterally in both directions since the intermediate plate fit tightly to the lips on the base plate on four sides. The two easterly bearings provided for an east-west movement and the southerly bearings for a north-south movement. The intermediate plate in the southwest corner stayed in place, it never moved. That southwest corner of the truss just drifted down. In the northwest corner the intermediate plate moved slightly out of line, jumped over onto a little platform just to the west. The one in the northeast was forcibly ejected from the top of the pier. You could identify where it had hit a steel railing and then it dropped back on the floor. The one in the southeast corner just popped off a little bit to the west. And I think that pretty well sums up the general factors.

I will now repeat some of what I presented this afternoon. It is in no way intended as a criticism of the excellent work done by Lev Zetlin Associates. It is an additional point of view.

We worked, of course, with Lev Zetlin Associates on the investigation, and as a result of what we saw, we became pretty well convinced that torsional buckling was a factor. That was the subject of the paper I presented earlier. There was a very definite funneling of the structure just south of the northwest corner which could best be explained by failure of a diagonal member just inside that northwest corner. We, by using torsional theory concluded that those members were torsionally weak. At about a 60 pound per square foot loading, which would have been around a 12 to 15 psf live load, using our dead load computations, and allowing for material and construction variations, these diagonals should have buckled. We also evaluated the top chords through the center line section again for torsion, and we found that if only the truss structure was considered, the limit was about 50 psf, where the dead load was around 49 psf. If we allowed for the truss structure and the superstructure of the roof to carry the load, we then could get to more like 60 psf, which was the same capability that we found around the column section. We went into Bleich and also into Gaylord & Gaylord and we followed their approach using an equivalent radius of gyration for torsion. We took an effective length factor of 1/2 for the torsion and came up with an equivalent radius of gyration, and using that we compared it with the actual radius of gyration to determine whether torsional or lateral buckling controlled. Our conclusion was that the critical loads for torsion were very close to the critical buckling loads which you would get at a 30 ft. unbraced length. For that reason, we didn't even try to get into an evaluation of spring constants for the rest of it. It had been handled so beautifully by Lev Zetlin's office anyway that

PANEL DISCUSSION

we couldn't have matched or done better if we'd tried. Using the critical torsional buckling loads, we found from an elastic analysis that we had 74 buckled members at dead load. A few more overloaded members showed up when we ran elastically with those buckled members, so we concluded between 70 and 90 members were apparently buckled under dead load. And I say between, because, again we didn't have a way of evaluating the effect of the roof structure as far as our deflection analysis was concerned. We did find a deflection of 11.7 in. at dead load with 74 buckled members and there was a report of their having measured between 12 and 13 in. in the field during construction. These are rough measurements because we don't know how true the structure was at the middle and we don't know how much the roof super structure helped. Somewhere between 70 and 90 buckled members appear logical from our deflection and load considerations. But it was really our sectioning of the structural at critical loads that, combined with the deflections, gave us reason to think that it probably was a torsional failure. You can work through a theory, apply it to what you know happened, and find the two match. It's either a monumental coincidence, or the analysis is correct. We think we have found something. We hope that someone will run some tests along this line to see if this cruciform configuration does have critical loads, extreme caution should be exercised by anyone planning to use cruciform shapes.

Durkee

Thank you Bob Loomis, for that fine summary on a very short notice. Our next speaker, Douglas Wright, took degrees at the Universities of Toronto, Illinois and Cambridge. He subsequently worked as a structural engineer, and he taught at Queens University, then later at the University of Waterloo where he was the first Head of the Department of Civil Engineering, and the first Dean of Engineering. He has done research and design work in space frame structures. He has been active in research with the Structural Stability Research Council, that's where I first met him. He has worked for the government of Ontario since 1967, first as Chairman of the Committee on University Affairs, then as Deputy Secretary for Social Development, currently as Deputy Minister of Culture and Recreation. Doug Wright's interest in space frame structures has survived all of this administrative load; and he will discuss the experience that he has gained from both failures and research studies, and comment upon design practices.

Douglas T. Wright

Thank you, Mr. Chairman. Gentlemen. It is indeed a very great pleasure to be here. I haven't been to a meeting of the Council in a few years and it is a delight to renew old acquaintances.

PANEL DISCUSSION

I am particularly interested in the topic chosen for discussion. It's not only timely; I think it's very relevant because of its importance in the advancement of our understanding of structural behavior. I'd like to speak briefly on some general questions of behavior. I'll skip the mathematics and so on, and talk concepts, and then after these introductory comments, I'll run through a few slides which illustrates examples, including failures. When dealing with space frames and structures we can differentiate between so-called single layer three-dimensional frameworks, and double layer frameworks. With these, we can develop either slab-like or shell-like structures. Plates or slabs as in the Hartford case, take the form of three-dimensional trusses. They can be analyzed fairly readily (albeit, in that case incorrectly) and designed accordingly to more or less conventional methods. Their overall behavior is a reflection of the behavior of the individual members or elements which can be designed along with the connections and so forth in fairly conventional ways.

There have been some interesting efforts in the last few years to apply the Johanssen fracture-line theory, which was of course developed to design reinforced concrete plates, to the design of three-dimensional metallic space frames. I was fascinated by Mr. Loomis' comment on what he termed fold lines, because of course, such fold lines are yield lines, and characteristic of a plastic analysis of a plate structure. To my knowledge, the principal work on this as applied to space frame structures has been done at the University of Melbourne under the direction of Len Stevens, and there have been some publications arising from that work. Clearly, the utility of that approach as a basis for design is restricted because of the limited capacity, with the ordinary range of slenderness, of members to resist compressive loads while achieving a suitable yield condition. Only in the case of either very slim members, or stubby members, is one able to have a sustained load-carrying capacity after the achievement of critical load.

Turning now to shell-like skeleton structures, it is still a matter of wonder to me, having been involved now for some 20 years in the design of these structures, what an advance they represent. One thinks of the shift from post and beam construction to skeleton frame and what a change that made possible in terms of height and lightness. Then one thinks of the application of reinforced concrete to shell construction. It seems that the three-dimensional single layer skeleton or reticulated shell, as a metallic construction, combined the efficiencies of the shell with those of the metallic skeleton. An egg shell has a ratio of radius of curvature to thickness of about 75. It's an easy matter to achieve a passable design in a single layer metallic framed shell with a ratio of radius to thickness of the order of 300. In fact, there have been some successful shells built in the range of 800 to 900. That is approximately a tenth of the effective thickness of an egg shell.

PANEL DISCUSSION

The double layer space frame shell, characterized by the Fuller Dome at Expo in Montreal or the Sports Palace built in Mexico for the Olympics in '68 has a potential span up to at least 1500 feet.

The single layer shell has a potential spanning capacity up to above 400 feet in a roof structure.

One of the great features of the space frame shell is, of course, that it opens up new forms. In concrete, shell forms have been limited to those which are simply generated for forming; spherical segments and hypars. But of course with a space frame shell not only are those shapes available, but also elliptical paraboloids, toroids, hybrids, and even shells of arbitrary shape are practicable. This is because of the absence of forming and the ability to erect, in most cases, without falsework.

Further, to earlier comments about research needs, it is clear that the extension of our capability to build structures to new forms has created a need for study and research. One can calculate bar forces in space frame shells fairly readily, either by modern computer methods or by using some of the simple transformations that relate bar forces to membrane stresses; but what is unique about these structures is that it turns out that there is a macro behavior that is not revealed as one does the ordinary structural analysis to determine member and joint forces and moments. It is this phenomenon, I think, that led to the failure experiences in the last decade or so. As we look further at the taxonomy of these structures, particularly in stability analysis, it is useful to consider the Gaussian curvature, which is simply the algebraic product of the two principal curvatures. Where the Gaussian curvature is negative, as in the hyper, then instability may still arise, but it is not associated with any deterioration of load-carrying capacity. In fact, the behavior is quite analogous to the plate girder web which, after buckling, still has an unreduced load-carrying capacity.

There has been some experience with the failure of such structures. One case was the Mexican Pavilion build for Expo in 1967. It was originally intended that this structure would be taken down and rebuilt in Mexico, but the Mexican government was persuaded to leave the structure in Montreal. Some four or five years later it failed, exhibiting both this sort of wrinkling failure and a failure as a tension membrane under the ponding effect of accumulated melting snow and ice. The design load was about 20 psf. At failure, and the failure was not catastrophic, it was carrying something better than 200 psf.

In the case of positive Gaussian curvature, that is where the two principal radii are of the same sign, a very interesting form of elastic instability is possible. Recalling what I said about the thinness of such

PANEL DISCUSSION

shells, this behavior is rather like the phenomena of a hat turning inside out. I'll show you in a few minutes an example of a major structure in which that was the result. The problem of dealing with this analytically is difficult, but there has been approximation achieved which seem to have satisfactory utility for design, although I don't think they're fully perfected in research terms.

There were debates in the solid mechanics field for many years about the stability of a spherical shell segment. Solutions were proposed in the first couple of decades of this century, but only in 1939 did Von Karman and Tsien produce a solution based upon considerations of non-linear elastic stability. In this solution the critical load is a simple function of the product of the modulus of elasticity of the material and the square of the ratio of shell thickness to radius of curvature. As always in these things, there was a modifying factor. For over thirty years there was a debate about the value of that factor. The conclusion of the debate was delayed because of the difficulty and expense in machining good test specimens, and as well as seems clear now from column research, there was inadequate appreciation of the effect of the residual stresses left in the specimens after machining. A consensus was finally reached reflecting a substantial volume of experimentation. Only shells with gross irregularities fail to reach this level, and, in fact, under ideal conditions values significantly larger have been experienced.

It proved to be possible to express the characteristics of a space frame shell as a continuum analogue and thus apply the Von Karman solution to the estimate of the critical buckling load of such shells. There are some structures of this sort built in Canada in the late '50's, and early '60's. With some hesitancy, I designed based on this theory but without any direct experimental verification from tests on space frame shells. Then, as it happened, we had the most superb kind of verification. As Mr. Loomis said a few moments ago, when one gets that kind of confirmation between a full-scale actual structure collapsing under load and one's calculations, one may be disposed to regard it as coincidence, but it really is a great deal more. In 1961 a great exhibition hall was built in Bucharest, Romania -- a spherical segment about 309 ft. in plan diameter with a rise of 63 ft. In 1962 there was a conference in Paris of the International Association of Shell Structures and there was presented a very detailed paper with all the calculations on the Bucharest dome, which turned out to be very interesting because in 1963, under a light snow, the dome collapsed turning inside out. The designers thought that they had a critical load at failure of approximately 150 psf. It inverted under the dead load of about 11 psf and a live load of about 20 cm of fresh snow, not entirely uniform, which weighed about 20 psf. Our calculation, according to the theory we had developed, estimated critical load capacity of 25 psf. We were able to accept that as an affirmation of the work we had done.

PANEL DISCUSSION

In a plate or shell there are really only two physical properties-- the modulus of elasticity of the material and thickness. It becomes a matter, then, of trying to find effective values for these in the case of skeleton structures. The approach that we took was to determine an effective value of a hypothetical value of Young's modulus and thickness which for the skeleton and its properties and joint characteristics, would produce both the same elongation and flexural behavior as a hypothetical uniform material. The results turned out to be interesting. Usually the effective thickness is substantially larger than the diameter of the tubes used. The E-modulus, is, however, very much lower than that of the members.

Since the first confirmation which we got in 1963 there has been a good deal more experimental evidence including test work done at the University of Waterloo, and in Czechoslovakia at Brno by Professor Lederer. As well as the failure in Bucharest and test results, there have been some other experiences with failures. A couple of examples in Britain have come to my attention, and I have photographs from one of them. And about the same time as the Hartford failure, there was a failure of the C. W. Post College Dome on Long Island in New York. There are still no published reports on that experience.

In summary then, it seems to me that we have achieved a reasonably satisfactory basis for designing domes, that is shells of spherical shape, and large numbers have been built and served satisfactorily. To turn to the agenda of this meeting and talk about research opportunities I think we need to know more about the behavior of such structures under non-uniform loading. We have had a good deal of experience with this in Canada. Snow, particularly on a roof of curved profile, does not fall uniformly; it falls on the lee side, quite asymmetrically.

We don't know very much yet about the treatment of shell surfaces that are not spherical. I have designed a few using the product of the two different principal curvatures and experience with that has been good. It certainly seems reasonable that the product of the principal curvatures should be a good measure, but again, I think this is a subject for research that would be well worth consideration. And then, as a third topic, more research is needed on the effects of edge conditions on space frame shells.

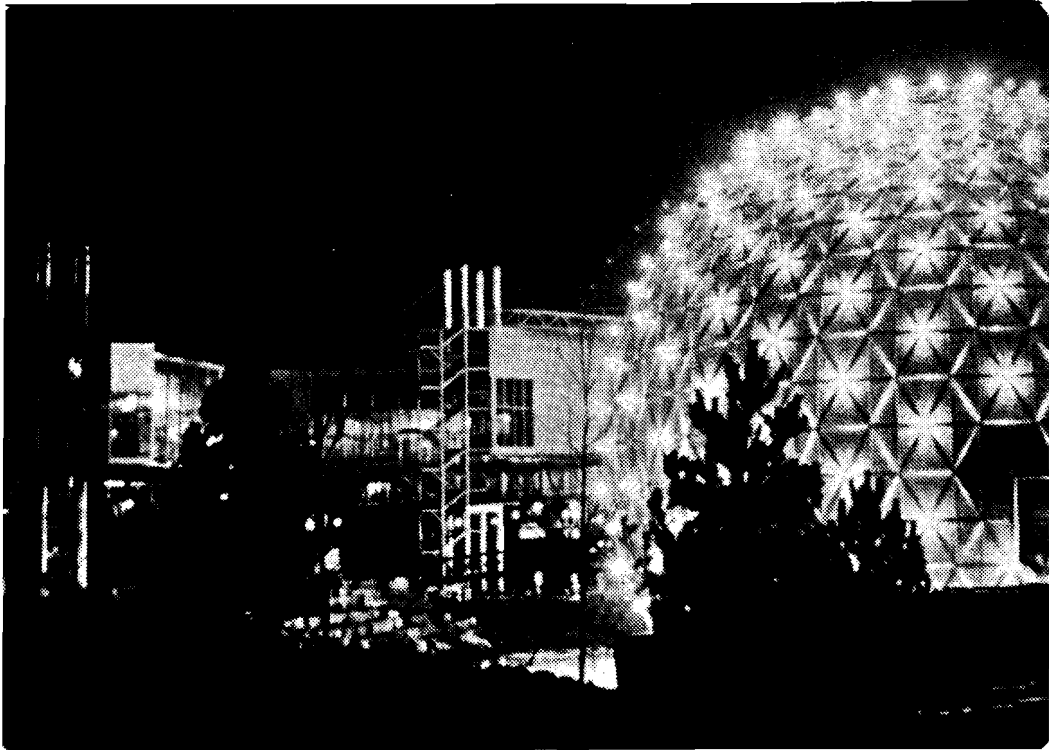


Fig. 1. Triodetic Space Frame Dome at Ontario Place, Toronto, 1970

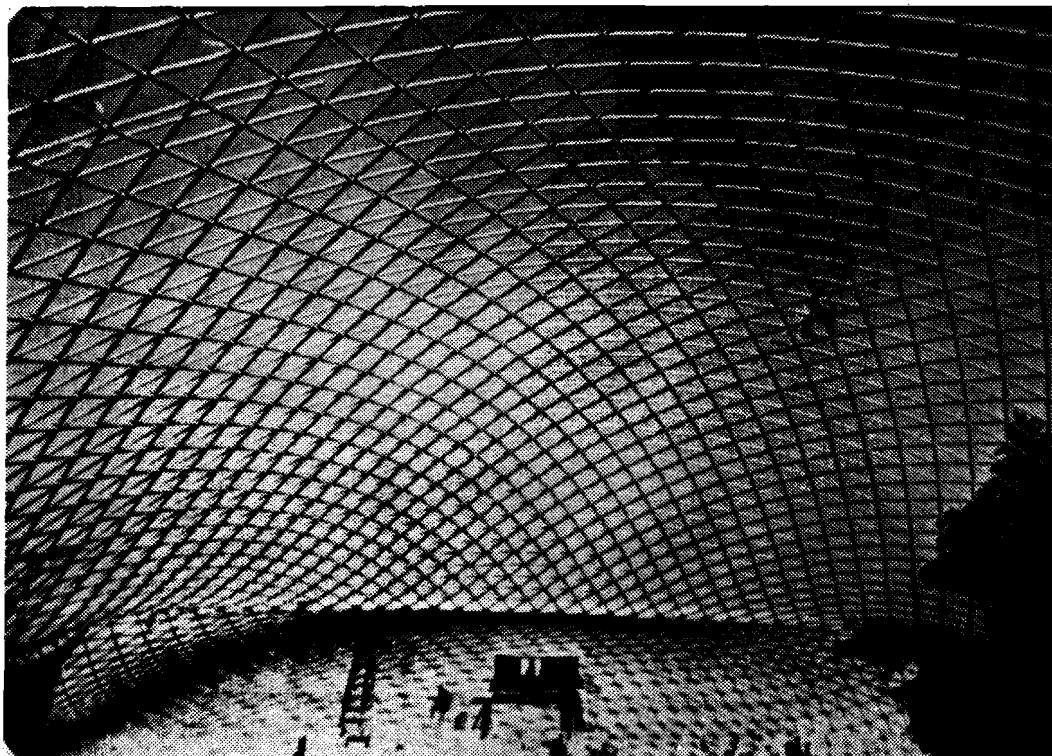


Fig. 2. Single layer space frame shell of arbitrary shape, Escuela Normal, Toluca, Mexico, 1966

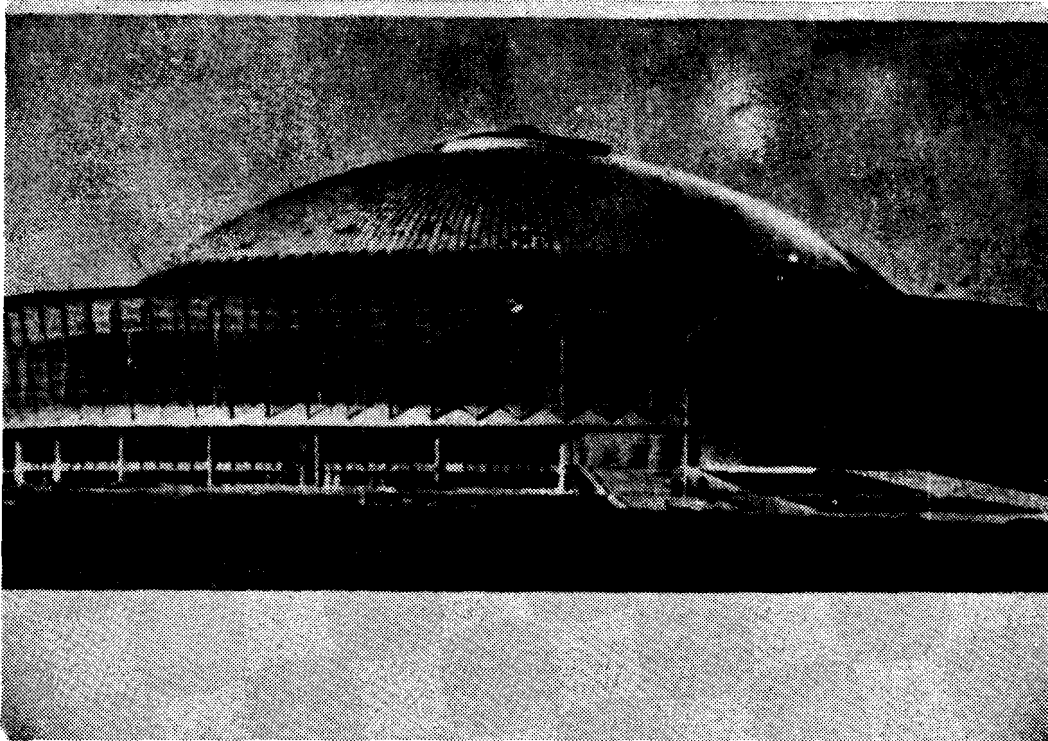
PANEL DISCUSSION

Fig. 3. National Economy Exhibition Pavilion, Bucharest, Romania, 1961



Fig. 4. Section of Bucharest Dome

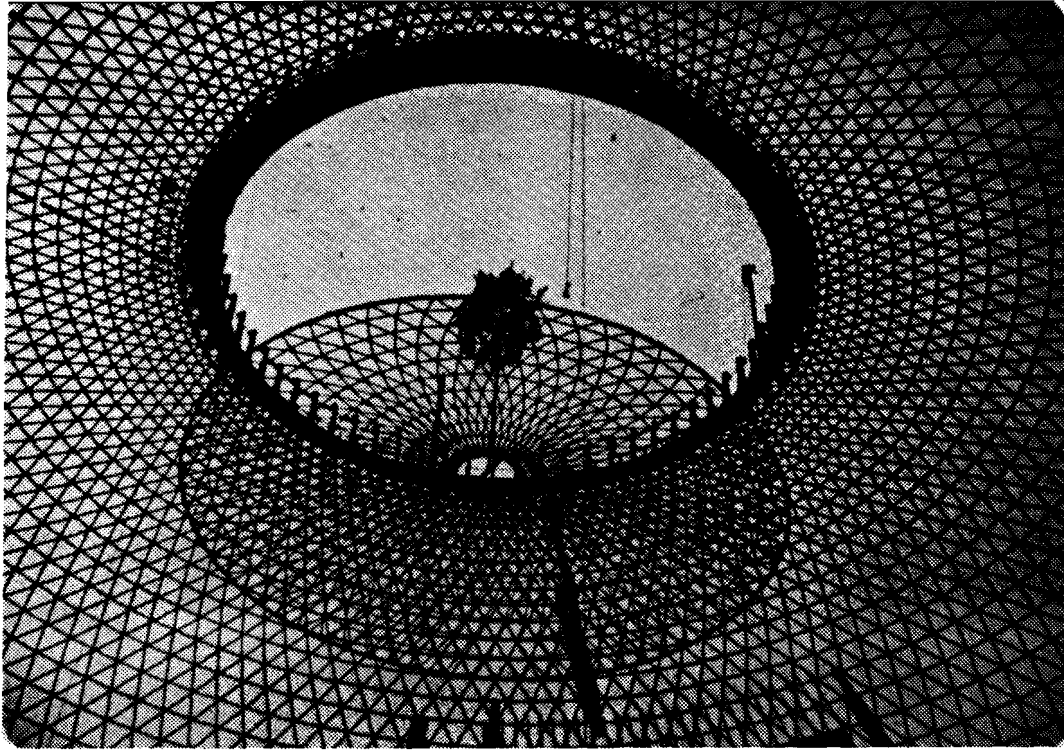


Fig. 5. Erection of Cap of Bucharest Dome

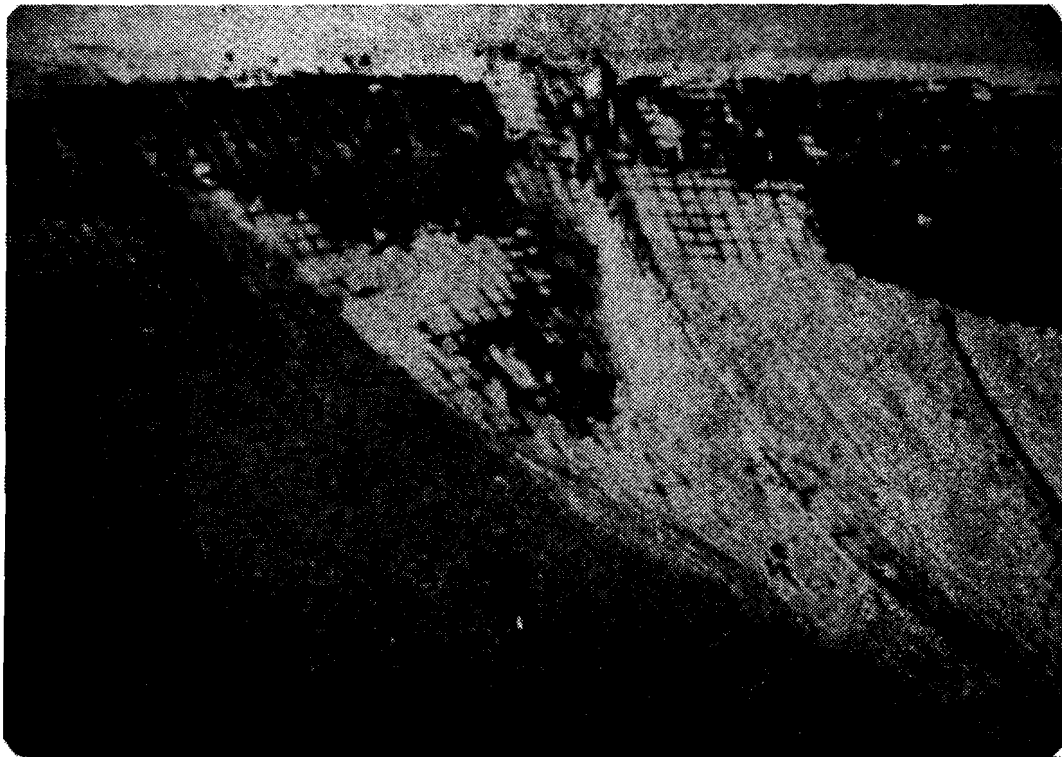


Fig. 6. View of the upper surface of Bucharest Dome after failure. Note part of cap at lower right corner

PANEL DISCUSSION

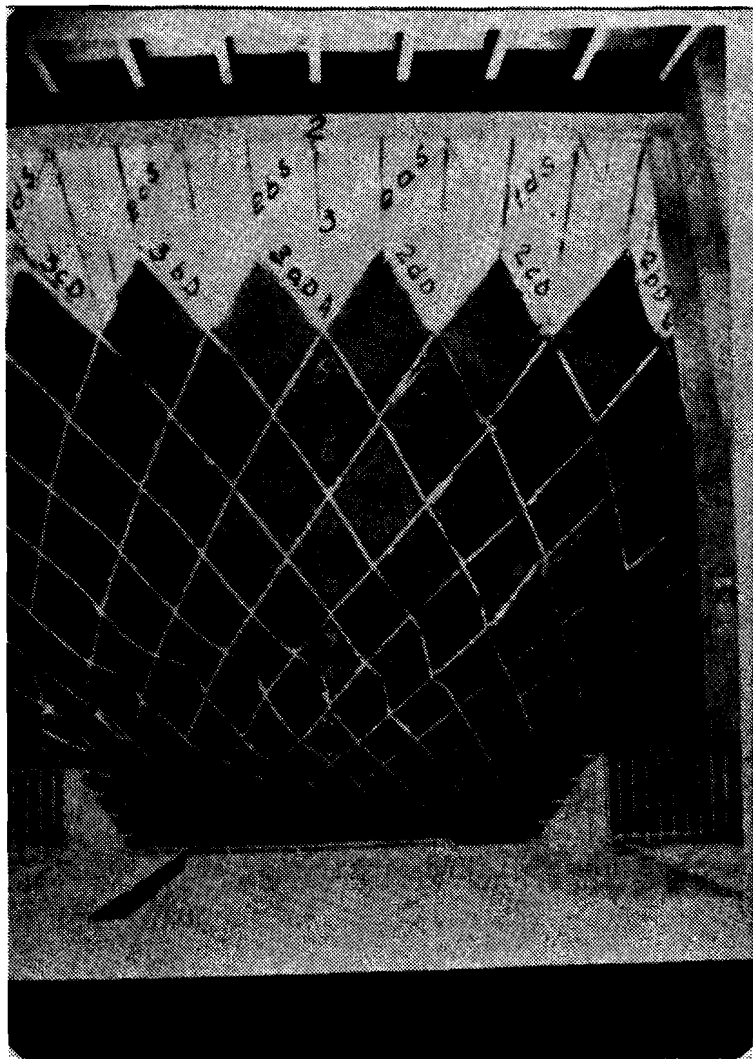


Fig. 7. View of Bucharest Dome after failure, from Interior Mezzanine. The dome structure hangs down from its support ring. Note the line of deformed tubes, and that most other tubes are undamaged.

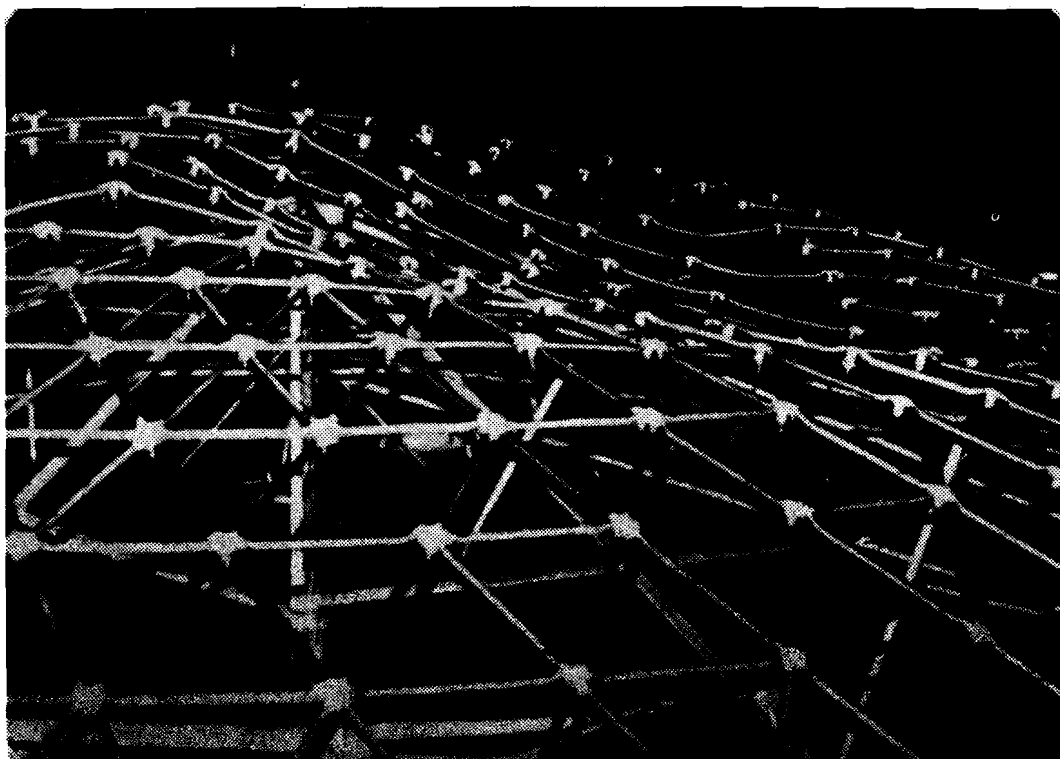


Fig. 8. View of experimental dome at University of Waterloo after test. Loading was by evacu-

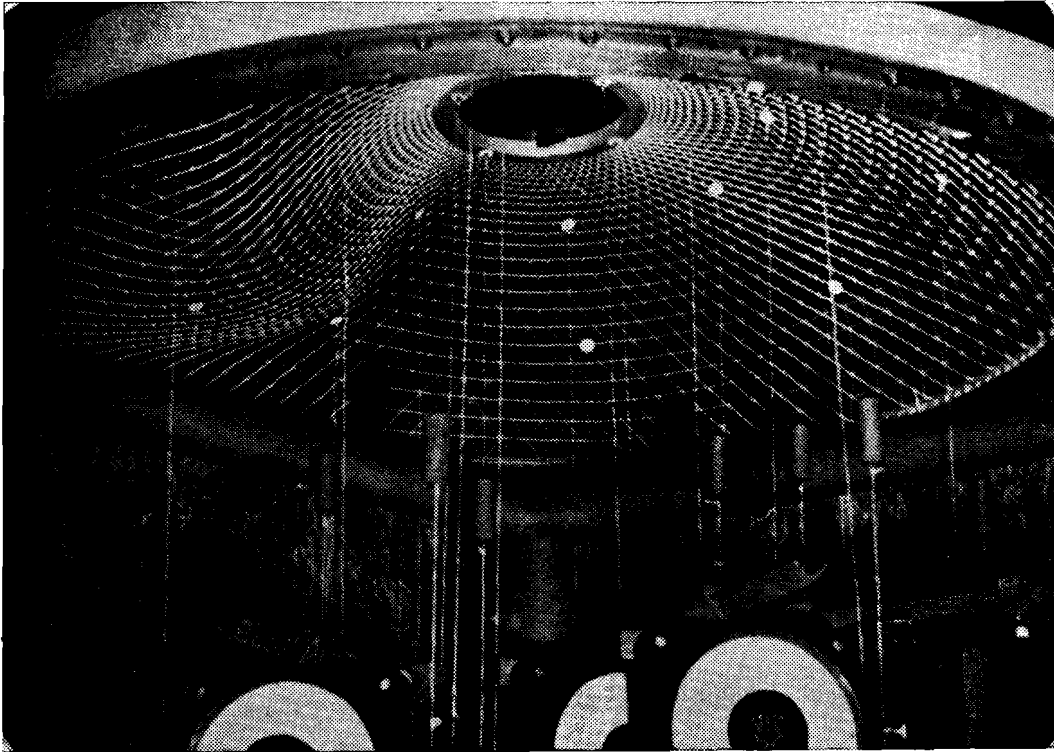


Fig. 9. View of experimental dome at University of Brno after test

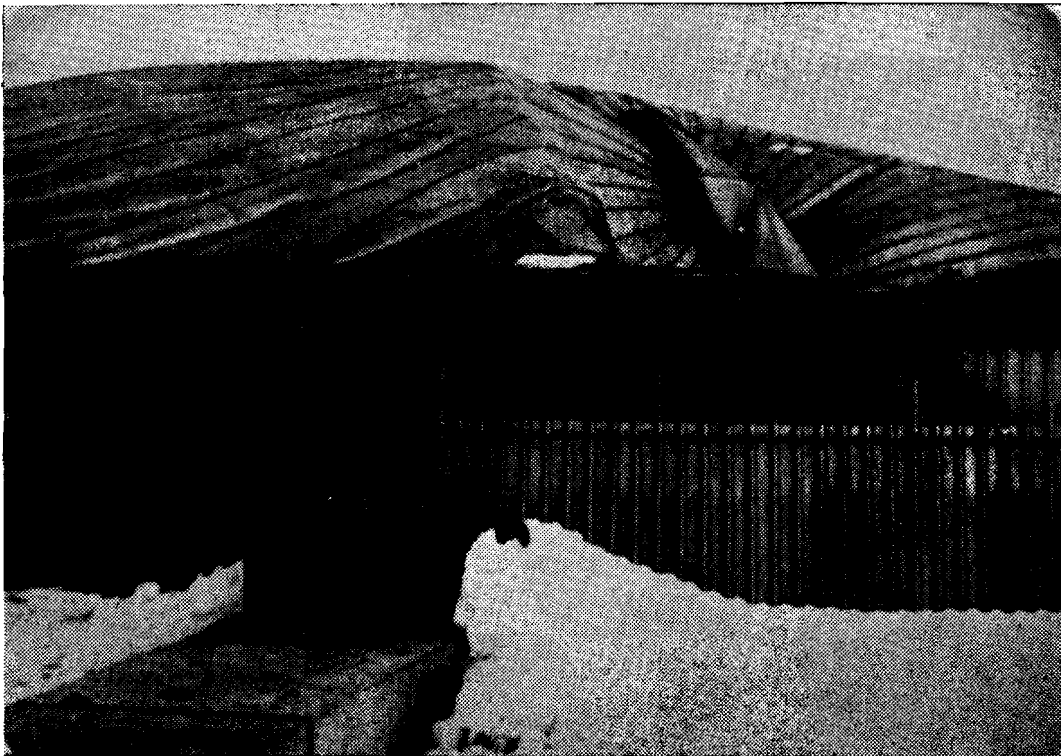


Fig. 10. View of water tank cover at Bradford, England, after failure under exceptional snow load

PANEL DISCUSSION

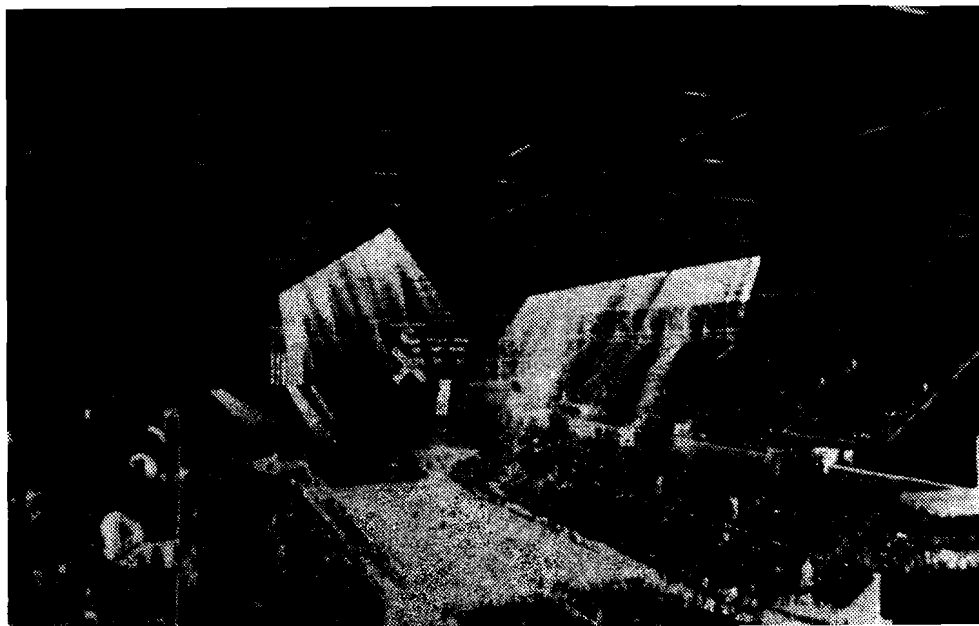
Durkee

Thank you Doug. And now presenting a construction viewpoint, We have Edward P. Becker from my old home town of Bethlehem, Pa. Ed is Chief Engineer of Lehigh Structural Steel Company in Allentown. He holds degrees from Lehigh University. His experience includes a stint as Director of the National Society of Professional Engineers. Ed is the past president of the Pennsylvania Society of Professional Engineers and secretary-elect of the ASCE Committee on Registration. Ed will talk about the contractor's viewpoint and discuss specifically the fabrication and erection of the space frame truss of the Augusta, Georgia Civic Center now under construction. Ed...

Edward P. Becker

Good Evening, Gentlemen. As anchor man, I am in the unique position of having heard all the high powered theory and some of the space truss problems that exist throughout the industry before I have to speak. However, as a fabricator we certainly are pleased to participate in your discussions because we feel that we have something to contribute in this area of new technology. As some of you know, and others will know after this talk, Lehigh Structural Steel has just completed a space frame truss building in Augusta, Georgia. It is officially known as the Augusta-Richmond County Civic Center, and its in downtown Augusta.

In my comments tonight, you will recognize that I'm speaking from the perspective of a Chief Engineer of a structural steel fabricator. Please bear in mind that there is no intent to criticize the design or imply that some of the features of the design were not properly thought out, because both the fabricator and the engineer had a learning experience in this area. I'd like to begin, by first giving a brief description of the structure. Once you have a little understanding of the type of construction we're dealing with then you will appreciate some of the problems to which I will refer later in my talk. This paper covers the practical problems of fabricating and erecting a structural steel space frame truss building that has clear spans of approximately 300'0 in each direction.

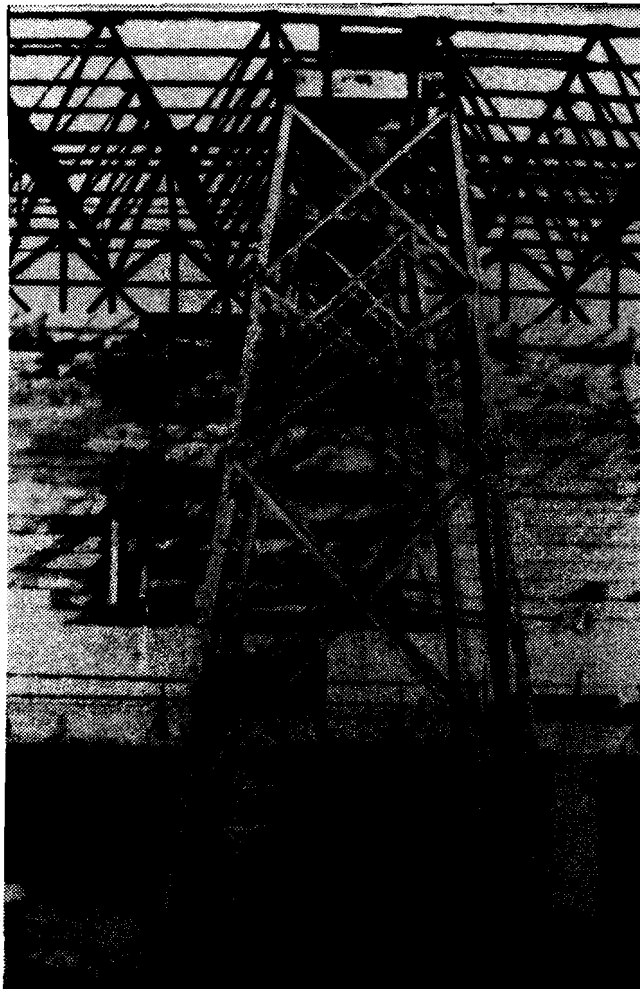


PANEL DISCUSSION

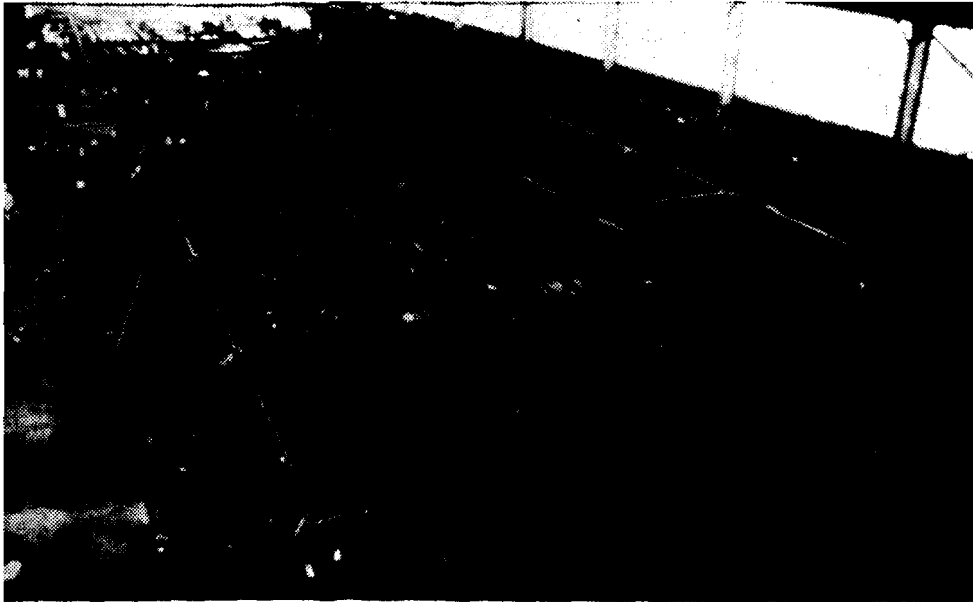
The design utilizes angle shapes exclusively for all structural members in the truss system. Both the chords and the dihedral webs are double angles back to back. The adjective dihedral is used in the sense that the web members are not in a vertical plane but rather are inclined between staggered internal and external chords. The approximate weight of the structural steel frame is 1,200 tons.

The arena is characterized by frame action in the two mutually perpendicular directions of the building and all of the truss steel is architecturally exposed. The McDonnell ICES-STRUDL Computer Program was used by the Engineer for the design and analysis, and the computer sized the members for minimum weight based on the theoretical stresses. Several architectural constraints compounded the problem of assembly and erection. For example, the top chord angles have a constant 4" outstanding leg width against the deck. In the most highly stressed regions of the roof, this required using 8x4x1" angles as chord angles which inhibited the placement of 1" \emptyset A490 bolts. Gusset plates and other connection material could not protrude beyond the limits of the main members in the wall and roof system except at certain chord connections of the roof and even there architectural profiles were maintained.

The space frame consists of 22 bays of three dimensional (triangular) roof trusses about 300'0 long (12'0 deep) and wall trusses on all 4 sides about 40'0 high (6'9) deep -- all on a 13'6 width module. Each roof truss erection unit was 150'0 long (half the span) x 13'6 wide, assembled on the ground and erected on continuous falsework at mid-span.

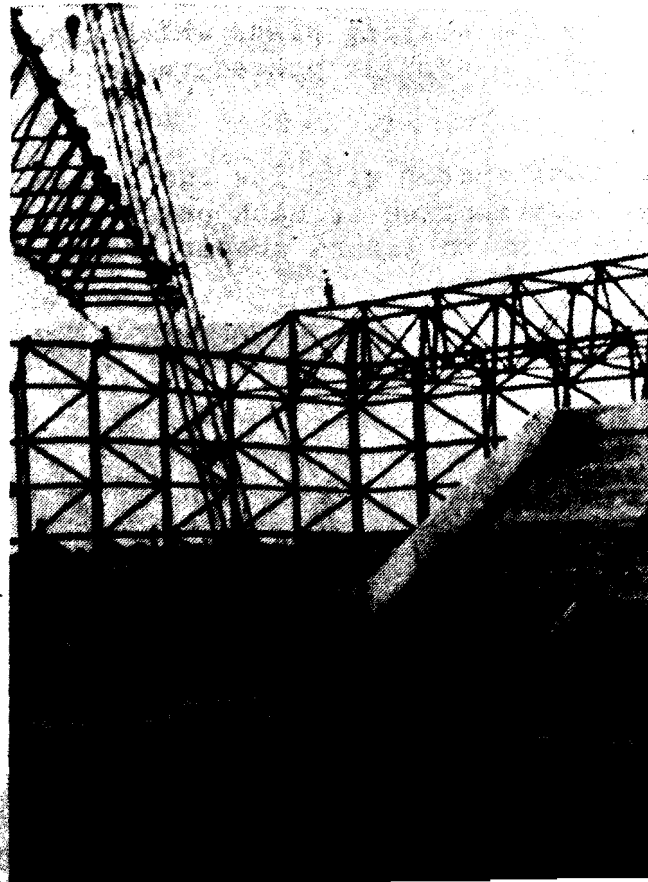


This permitted the roof system to be fabricated in our Allentown, Pa. plant and shipped knocked-down for field assembly into erection units using 1" A490 & 7/8" A325 high-strength bolts. Special weldments, known as "boot details", were fabricated for connections in the roof system. The decision to use "boots" was based on geometric layouts of working lines and accessibility for placing welds to develop the stresses in the 8 members intersecting at each panel point. A prototype of the roof truss module was shop assembled to check fit, clearances, and tolerances.



The wall panels were fabricated as shop welded/bolted assemblies and shipped from our Lancaster, SC plant. The transition pieces at the "haunch" of the frame were shipped loose and field bolted.

The erection was sequenced to satisfy the construction plan and to establish geometrical controls from the corners of the building.

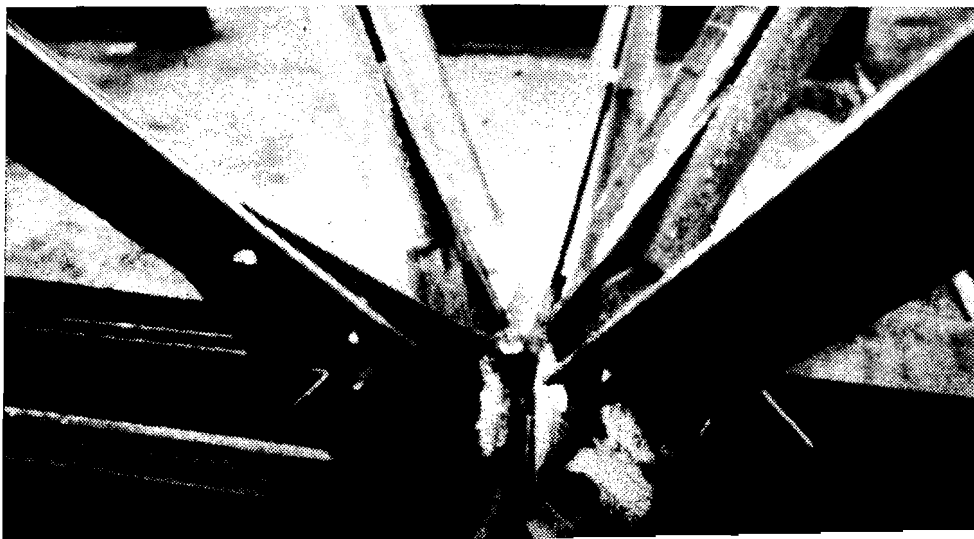


PANEL DISCUSSION

Roof and wall panels were erected progressively starting from the end walls toward the center. 3/4" spacer plates were tack welded at the connections between the chord angles per the design. These were also expected to provide a means for lateral adjustment during erection although none was necessary.

The sophisticated nature of this building, coupled with the highly theoretical design, created some major problems for the fabricator. The highlights of some of these problems are summarized below:

- (1) The designer's choice of double angles, an unsymmetrical section (x-x axis), as the basic structural section created inherent eccentricities throughout the building since for each member, its center of gravity is a function of size. Chord sections varied from pairs of 8x4x1" angles maximum to pairs of 3x3x3/16" angles minimum. The computer's design for minimum weight created a proliferation of angle sizes causing some procurement problems from the mills but more importantly, loss of duplication precluding economical fabrication. It also complicated the location of field splices for erection. Major connection problems resulted where heavy chord members in one direction were interrupted by continuous light chord members in the mutually perpendicular direction. This condition occurred, because in order to erect this type of structure, one direction (longitudinal) was established for fabrication and erection by the design. The calculations of connections in the detailing stage became horrendous because the eccentricities at each connection had to be investigated separately. The selection of a working line referenced to the top of steel was made so the detailer could have a basis to figure the roof system. After studying the sizes of the top chords, a nominal 2" below top of steel was established as the working plane which represented the mean of their centers of gravity. A similar procedure was used for the bottom chords and wall panels.
- (2) The space truss roof system with its two orthogonal chords and four dihedral angles intersecting at each panel point created major problems of placing welds so as to assure proper transfer of the stress for each member through the joint.



PANEL DISCUSSION

After extensive studies on paper, mock-up joints were made in the shop to determine just how effectively welds could be placed. The computer makes it possible to do a rigorous theoretical stress analysis with all stresses concentric at each joint, but it is a most difficult task to fabricate connections to such an ideal condition using welded construction. Welds which overlap each other carry indeterminate stresses (in this case triaxial) and are unacceptable. Therefore, the approach we made on joint development was to assure each member its proper weld placement for transfer of its stress through the joint. This was most feasible by using the "boots" at the top chords of the roof trusses which facilitated better placement of the welds and provided a method for connecting the critical panel points as the top chord was joined in the field. The "boots" bolted through the continuous longitudinal chord angles and connected the dehdral web angles and transverse chords. A top plate was used in conjunction with the boots. This technique also kept the fabrication of the chords simple since all angles then became P. O. material. The bottom chords were complete shop assemblies.

(3) The erection of the roof system required extensive upgrading of web diagonals in the region of the falsework supports. Under the theoretical design loadings, the shears were minimal at mid-span; consequently web sizes were minimal. However, for erection of the individual trusses, the shears in these panels were quite substantial and web members all along the line of falsework, and for several panels back, had to be increased to handle these higher compression stresses.

(4) The structure was erected on falsework with jacking controls. After the entire structural system was completely bolted up and the roof decking installed and welded, the unjacking process took place. Extreme care was needed to assure a very slow rate of unloading, progressively executed along the length of the falsework supports. This was a very critical, yet sensitive, operation where one missed stroke on a jack could cause local buckling of members as the roof was eased down to its self-supporting position. Incidentally, during erection a slight misalignment was detected in the level of the roof steel which the erector attempted to compensate for by raising the jack at that point. This was disastrous since several diagonals buckled in the immediate area of the jack being raised. Replacement was made one by one, reaming as necessary to compensate for the set that caused deviation from detailed dimensions. Additional reinforcing plates were field welded at all reamed connections.

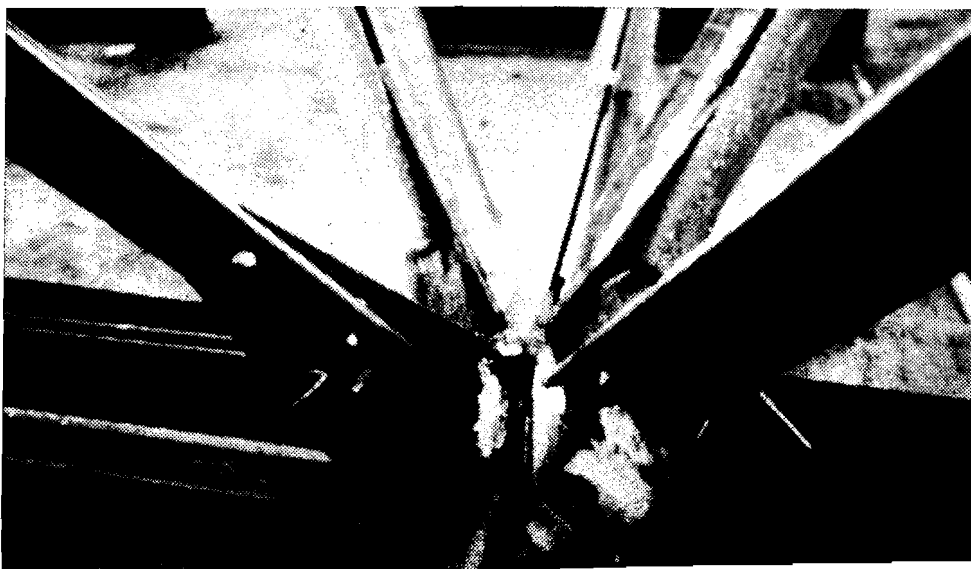
(5) Of concern during the construction planning was how to store and spread the decking. Uniform roof loads were used by the engineer for the design; however, the erection stresses caused by local

PANEL DISCUSSION

Roof and wall panels were erected progressively starting from the end walls toward the center. 3/4" spacer plates were tack welded at the connections between the chord angles per the design. These were also expected to provide a means for lateral adjustment during erection although none was necessary.

The sophisticated nature of this building, coupled with the highly theoretical design, created some major problems for the fabricator. The highlights of some of these problems are summarized below:

- (1) The designer's choice of double angles, an unsymmetrical section (x-x axis), as the basic structural section created inherent eccentricities throughout the building since for each member, its center of gravity is a function of size. Chord sections varied from pairs of 8x4x1" angles maximum to pairs of 3x3x3/16" angles minimum. The computer's design for minimum weight created a proliferation of angle sizes causing some procurement problems from the mills but more importantly, loss of duplication precluding economical fabrication. It also complicated the location of field splices for erection. Major connection problems resulted where heavy chord members in one direction were interrupted by continuous light chord members in the mutually perpendicular direction. This condition occurred, because in order to erect this type of structure, one direction (longitudinal) was established for fabrication and erection by the design. The calculations of connections in the detailing stage became horrendous because the eccentricities at each connection had to be investigated separately. The selection of a working line referenced to the top of steel was made so the detailer could have a basis to figure the roof system. After studying the sizes of the top chords, a nominal 2" below top of steel was established as the working plane which represented the mean of their centers of gravity. A similar procedure was used for the bottom chords and wall panels.
- (2) The space truss roof system with its two orthogonal chords and four dihedral angles intersecting at each panel point created major problems of placing welds so as to assure proper transfer of the stress for each member through the joint.



PANEL DISCUSSION

After extensive studies on paper, mock-up joints were made in the shop to determine just how effectively welds could be placed. The computer makes it possible to do a rigorous theoretical stress analysis with all stresses concentric at each joint, but it is a most difficult task to fabricate connections to such an ideal condition using welded construction. Welds which overlap each other carry indeterminate stresses (in this case triaxial) and are unacceptable. Therefore, the approach we made on joint development was to assure each member its proper weld placement for transfer of its stress through the joint. This was most feasible by using the "boots" at the top chords of the roof trusses which facilitated better placement of the welds and provided a method for connecting the critical panel points as the top chord was joined in the field. The "boots" bolted through the continuous longitudinal chord angles and connected the dehdral web angles and transverse chords. A top plate was used in conjunction with the boots. This technique also kept the fabrication of the chords simple since all angles then became P. O. material. The bottom chords were complete shop assemblies.

- (3) The erection of the roof system required extensive upgrading of web diagonals in the region of the falsework supports. Under the theoretical design loadings, the shears were minimal at mid-span; consequently web sizes were minimal. However, for erection of the individual trusses, the shears in these panels were quite substantial and web members all along the line of falsework, and for several panels back, had to be increased to handle these higher compression stresses.
- (4) The structure was erected on falsework with jacking controls. After the entire structural system was completely bolted up and the roof decking installed and welded, the unjacking process took place. Extreme care was needed to assure a very slow rate of unloading, progressively executed along the length of the falsework supports. This was a very critical, yet sensitive, operation where one missed stroke on a jack could cause local buckling of members as the roof was eased down to its self-supporting position. Incidentally, during erection a slight misalignment was detected in the level of the roof steel which the erector attempted to compensate for by raising the jack at that point. This was disastrous since several diagonals buckled in the immediate area of the jack being raised. Replacement was made one by one, reaming as necessary to compensate for the set that caused deviation from detailed dimensions. Additional reinforcing plates were field welded at all reamed connections.
- (5) Of concern during the construction planning was how to store and spread the decking. Uniform roof loads were used by the engineer for the design; however, the erection stresses caused by local

PANEL DISCUSSION

concentration of decking had to be evaluated. A maximum concentrated load of 1 ton was limited to any one truss unit.

- (6) The shop and field inspection of this structure was both extensive and intensive--partly because it was in fabrication at the time of the Hartford Civic Center collapse, but more so because of the intrinsic critical nature of every weld and every bolted connection in the structure. Ultrasonic inspection of each critical weld was made not once but twice by different inspectors, and all field connections of the high strength bolts were rigorously inspected (load indicator washers were used on the 1" \emptyset A490 bolts to assure proper bolt tensioning).
- (7) The dead load of the erected roof steel, including connection material, was somewhat heavier than estimated. The design provided for a uniform steel dead load of 22.5 psf whereas the actual distribution varies from about 14 psf at the wall lines to approximately 31 psf in the mid-region of the roof. This dead load distribution was reviewed with the Engineer who confirmed that the design was capable of taking these variations. We make note that the actual deflection of the steel at mid-span was $3\frac{1}{2}$ " after unjacking versus 7" estimated indicating the structure had greater stiffness than predicted by theory.

The experience gained by our company from the fabrication and erection of this type of exotic structure will certainly be reflected in any future bids that we may make on similar structures. The cost of the erected steel was in the neighborhood of \$22 per square foot including wall sections which realistically represents structural steel costs for this type of building.

Durkee

Thank you Ed Becker. We're now all authorities on the pricing of fabricated structures.

We will now proceed with the questions and discussion. As the moderator, I'm going to ask the first question. I see a little problem here with the difference between the micro effect and the macro effect; and Doug Wright was remarking about this difference in behavior. Consider the situation where a structure appears to be adequately braced for the macro-type loading, which inevitably is the place where you start on this kind of problem. Doug, is there any way of being reasonably confident that the structure that looks satisfactory from the standpoint of the "once over", will not have some detail part going in that would lead to unpleasant consequences, especially if there were no reasonable means of having such an overloaded detail pass its overload on to another member?

PANEL DISCUSSIONWright

I'm sure there could be problems of that sort. When I tried to think of an example, the sort of things that one can imagine are those that I think an experienced engineer would naturally be sensitive to, such as a point-load on a single layer shell (which of course perturbs the membrane theory anyhow and for which membrane theory can't really give a solution). That may be small enough to be inconsequential in terms of overall behavior, but could still trigger some local distress. I think that's pretty well what you're talking about. My second slide showed a larger diameter cover of a conservatory in Vancouver and it carries a heavy load of air conditioning and ventilating equipment at the zenith. There was a debate about whether that needed to become a double-layer dome. In fact, we concluded from our analyses that it didn't. (Durkee: Were you right?) Well, it's still there.

This is an example to which we were very sensitive. So I think that your point is fair; one has to be very sensitive in the interaction of different modes of behavior.

Durkee:

Thank you. Next question, Dr. George Winter, Cornell University.

G. Winter

This is not necessarily only to the panel, but to any of the consulting engineers here who may have a similar experience. Mr. Becker mentioned that this was a computer design for optimization for weight, and the design incorporated these continuous changes of cross-section which led evidently to problems of actual fabrication and erection, and probably to higher costs than if a smaller number of the changes had been made adding somewhat to the weight but simplifying everything else. Now my question is, is it really customary to take computerized designs, just as they come out of the computer, and not look carefully at what they mean, and throw them at the job? Is this customary, or isn't it?

Becker

It seems today that consulting engineers are confronted with cost problems just like everybody else, and the simplest and quickest way is to transcribe the output from the computer onto a master schedule in the design drawings. The schedule of sizes -- unless an experienced structural engineer really goes through and edits what his people are doing -- comes out like this structure. And this is not an isolated occurrence; we have another space-frame structure already under contract, a heavy beam-column

PANEL DISCUSSION

type of job, but it's a space frame building in which the building is eccentric because it has cantilevers off of two sides. The same situation occurred there; the computer specified truss chords like W36x135's, and yet the compression diagonals that frame into those chords are W14 x 342's. So you have a column section for a diagonal framing into a light beam section as a chord, and the engineers gave no thought to the connection, to the fact that the diagonal flange had to be transitioned back just to meet the width of the chord, and the stiffening arrangement and final integrity of the joint. My impression is that it is an unfortunate trend in some consulting offices.

Wright

Can I make a gratuitous comment, Mr. Chairman? (Durkee: Please.) I think of Hardy Cross' contribution to the advance of structural engineering in this country and throughout the world; in so many ways he was the father of rigorous analysis. I think if he could overhear what you said, he'd be rolling over in his grave.

Durkee:

Well, it is unfortunately true that in too many cases the attention that is needed is not given. I'm afraid we have to admit that there is that problem.

G. F. Fox

I will speak for the consulting engineers in this particular case; just remember that that building is standing. That's number one. Number two, I don't think that very many consultants optimize to the least weight; I think that's the misnomer. I think we all try to find the cost of the welding and of other fabrication factors. That's often much greater than the basic primary cost. The biggest problem we have, by the way, is to get reliable cost data from fabricators. If we wanted to make a really good optimization program, fabricators would have to be more helpful and furnish the basic cost optimization data that we need--that is, the costs. It's all competitive between fabricators and very difficult for engineers to get that material. But I have to speak for consultants. Those structures that are standing there are ahead, sometimes, of the theory and they were designed by consulting engineers.

Durkee:

Well, Gerry, I'd just like to comment on behalf of the fabricator, if I may. The fabricator is going to be reluctant to

PANEL DISCUSSION

hand out costs, not because it's competitive-type information, but because you just cannot put cost data into that good focus. In many cases the fabricator's cost estimator will have to see detailed designs first. He can't just say, well here's the schedule of what fabricated structural steel costs, and this for your guidance in design. Right, Ed? You have to take a careful look at it and evaluate and judge; it is not just handbook data off-the-shelf.

Becker:

I would say that even our own company, depending on when you come to us with the structure, would give you two different prices. It depends on what our shop schedule is and what kind of work, what class of work we need for a particular shop, and what tonnage is involved, and whether the structure that's out for bid is going to fill that particular need. (Durkee: Precisely) So there's no hard-and-fast rule that all beam-column jobs with simple moment connections are going to be at one price all the time. It just fluctuates with the fabricator's requirements for work, along with other factors. But I want to comment back to Mr. Fox about the consultants. You remember I said I am with a fabricator, and am speaking from the fabricator's viewpoint. However, I did work for consulting engineers for seven years, and appreciate and know the problems of the consultants.

W. A. Milek:

Were all of the jacking-down operations under such careful control that you did not upset the balance of stresses in all the members of this grid? That's one question. My second point is that in order to control the erection stresses and account for these much-higher-than-originally-calculated stresses in the web system, it was necessary to significantly increase the size of some members. This in itself, of course, would upset all of the initial analysis; now, was there any consideration or any re-analysis of the frames as a result of the changes in certain members that were introduced to accomplish erection?

Becker:

We directed the change in the dead load back to the Engineer for his evaluation. All during the material-ordering stage where we were confronted with having to change sizes or extend chord angles to a splice location, all of these matters were reviewed by the Engineer. Now, whether he made a final computer analysis to verify the effect of these modifications from the original sizing on the building, I don't know. I can say he gave us his professional answer, and he was quite certain that the stiffness

PANEL DISCUSSION

of the building was more governed by the total geometry than by the small variations in individual members throughout the chord or web system. (Durkee: But you still came up with quite a dead weight variation, rather than the uniform loading that had been originally used; and that didn't worry the Engineer?) Well, it worked out to the same average-- actually, it was incredible but the average dead loading off of our shipping bills was the same as the engineer used for his design, it came out to 22.5 say 23 psf. But the distribution is what concerned us. The central roof region is where we found the connections quite heavy because the top chords in high compression needed heavier gusset plates and a lot of connection material to develop them. And that's where we had this estimate of 31 pounds per square foot from our shipping bills (Durkee: Right here in the middle of the roof?) Right in the Middle. And then it dropped back to 16.7 and further to 14.3 along the walls.

Milek:

My question was not so much the change in dead weight, but the change in stiffness of the individual elements, which certainly must have upset the analysis.

Becker:

Well, the Engineer contended that the change in individual member sizes really did not affect the stiffness, since the matrix of the total building was dominating the stiffness of the structure. That was his answer to us. I want to comment also, Bill, that we went through the structure and sized all of the diagonals along the falsework reactions for the erection loads; and not just at the immediate support points, but two or three panels on either side. Yes, and despite that, we still had some "popping" as the erector had to make adjustment.

T. V. Galambos:

I have a question to either Mr. Loomis or Professor Epstein. Was there a re-analysis made of the Hartford roof based on the assumptions of the designer; and further, what was the collapse load according to the assumptions of the designer...apart from the minimum factor of safety?

Loomis:

The roof was re-analyzed elastically, and the revised member forces were very close to those that were shown on the original documents.

PANEL DISCUSSION

Galambos:

What was the collapse load then?

Loomis:

If the designer had followed through, it would have been, I believe on the order of 120 psf. (Durkee: Followed through in what sense?) Followed through in the design for the members based on the loads he had. (Durkee: Oh yes; now tell us again what he didn't do there.) Well, I wasn't there, so I don't know what he didn't do. When you consider the STRUDL analysis, whether you look at the results that he showed or the results that others of us obtained, we basically came out with the same forces in the members. Where we differed was in the evaluation of what force each member could handle, from panel-point to panel-point.

Howard I. Epstein:

It's partly an answer and partially a comment on some of the previous points. One of the questions posed before was whether or not there should be re-analysis and some further changes made in the structure, following changes requested by the fabricator-erector. The experience that I've had with these types of structures would indicate the area in which you usually need to make such changes is near the center of the structure; and you'll find that the rest of the structure is likely to be fairly insensitive to changes in the sizes of members near the center. (Durkee: Aren't you referring more to arch-type frames than to truss-type frames?) I'm referring to space frames generally. You had brought up previously the area of computer analysis and minimum-weight pack design. The thing that annoys me, or one of my pet peeves in this area, is the over-reliance of the design engineer on the computer results in the design of structures like this. You can see that in your minimum-weight design--in the design of the Hartford roof, where from one day to the next members were changed by 1/16th-in. thickness from one size to the immediate next size. Now that tells me that the designer is relying very heavily on the output of a computer program; and he undoubtedly does so because of the complicated nature of structures like this, he goes away from Hardy Cross--from the seat-of-the-pants type of thinking and judgement. We have no idea anymore, if you put a load on a structure in some position, what the distribution of the forces is going to be in the local area, and how that load is going to travel through the structure, to the reactions; and it leads to this over reliance on computer-generated numbers. And I see this as more of a concern than worrying about some of these other lesser problems. This tendency to rely so heavily on space-frame computer programs is not good.

PANEL DISCUSSIONDurkee:

Are you telling us that this type of structure does not respond to some of the niceties, partly because fabrication and erection can't be all that accurate, and partly because of other reasons?

Epstein:

Well, yes, in part. Some space-frame structures show deflections about one-half of what is predicted, and in the Hartford roof had deflections about one-and-a-half times what was predicted. Now whatever you attributed that to, it means that we'd better re-think the nature of model, and further, maybe we should sit back and do some hard thinking about design philosophy of such structures. I'm very nervous about the fact that there are certain portions of a space-frame structure which may be greatly affected by local conditions during jacking. One question-- several rumors have surfaced in connection with the Hartford Civic Center roof. I've heard from several sources that there were people who worked on the construction of that roof who said they would not ever go into that coliseum when it was completed. Now I don't know whether to attribute that to the fact that those people had not ever built anything like this before, or whether they were concerned because of the very flexible and light type of light structure. Mr. Becker, did you find any such rumors floating around during construction of the Atlanta coliseum?

Becker:

Yes, but of a different kind; I think the ironworkers and the contractor believe they have a really strong building there.

Durkee:

Their confidence wasn't reduced by the Hartford failure?

Becker:

Well, we found it possible at Atlanta to take certain members out and replace them; we found the structure to be very stiff. One problem that occurred during erection was just plain inexperience. After a few such structures you wouldn't expect to have the Hartford type of construction failure because the erector would know better the type of structure that he's dealing with, and possibly generate some useful feedback to the designer, during the construction phase.

PANEL DISCUSSIONDurkee:

We have a question from John Springfield, Carruthers and Wallace, Toronto.

Springfield:

I have two questions -- the first one is very short. Last year Dr. Wright told me that by putting diagonal bracing in orthogonal top-chord panels near the supports, the distortion of those panels out of square is greatly reduced, resulting in a reduction in the deflection of the roof structure. And conversely, if you don't put those diagonals in, then you get a much increased deflection. My calculated deflection for a particular space frame didn't agree with Dr. Wright's. I was short of member capacity in my program, and omitted what Dr. Wright showed me were critical diagonals. Now I didn't see any such diagonals on the Augusta frame; and the Hartford roof seemed to have so many diagonals I couldn't really see whether the square panels near the supports were braced or not.

Becker:

At Augusta we have a typical module of "pyramid construction" all the way up to the wall lines, and then it actually traverses around, from the roof down the wall, following the same pyramidal type of construction. There is no redundant bracing; all dihedral members in this structure are stressed members. There are "pure bracing" members.

Wright:

This question of the effect of diagonal bracing really turns on what we've been talking about in that other discussion about sizing, and it speaks also to the potential benefit of getting away from the numbers and thinking about behavior. We use the term "space frames" quite freely, but there are a whole variety of types of space-frame systems, and their behaviors are fundamentally different. In many cases, the disposition of just a few members can have a profound effect on macro behavior. Basically the kind of structure built in Augusta behaves like a grillage; I don't know about the Hartford type. One can get a very good approximation to the chord forces for the Augusta type, with solution for orthogonal beams. You can do that on the back of an envelope; you don't need a computer, and you can do it in a few minutes. If you then put diagonal bracing, any one of a number of patterns, in the top and bottom grillage faces then there is a considerable change in behavior, because now the roof structure behaves more like a slab instead of a grillage, since

PANEL DISCUSSION

you've introduced the capacity between the parallel frames to resist twisting, and also the x-y moments in slab theory. What John Springfield is talking about is that one can, I think fairly artfully, design a hybrid structure that doesn't have the expense and material of those diagonal braces carried right on through the whole structure; by putting some in selectively, they not only share load and so reduce some of the maximum member sizes, but as well considerably modify the behavior because you introduce some of that twisting resistance in the bays where it's most helpful. And in the process, substantially reduce some of the main chord forces near the midspan.

Durkee:

Perhaps we can draw an analogy to a three-dimensional version of knee-braces in industrial building frames.

Wright:

Yes, it's quite analogous.

Becker:

I might comment on that the entire deck and wall system at Atlanta is welded to the steel frame and becomes part of the structural system--just in case I didn't bring that out clearly in my talk. The Engineer carried the dead load of the deck in the north-south direction which was the direction having the continuous chords. Further, all the lateral loads went to the north-south walls.

Durkee:

Your building was 300 feet square, Ed?

Becker:

It's exactly 297 feet x 297 ft.

Durkee:

Yes, 300 feet square. Next question, John Springfield.

PANEL DISCUSSIONSpringfield:

My second question deals with the economics of patented joint systems versus that of customer fabricated joint systems. Now if you go to a manufacturer of space frames, he will give you a realistic price of what his patented space frame will cost. If you then go back and tell him you want it cheaper than that, and you develop a custom design, calculate your weight of steel, and take a thousand dollars a ton instead of two thousand dollars, then you come up with a cheaper one. I've had a bit of experience with this type of situation myself. An oil company in Toronto saw delightful looking space-frame gas station covers in Europe, said they want one of those. I designed one in simple open web steel joist and beam framing and said that's so much a square foot, while if you do a space frame it's about three times as much. At this point, they kicked me out, and got a second opinion from Dr. Wight, who confirmed the price that I gave them for the patented system. After about three years I got word back from them and found that they finally agreed with me. The point is, to what extent do you think that people are falling into the trap of rejecting realistic prices from the people who have experience in space frames, and thinking that they know a better custom design? Are there any standard space frame systems used and manufactured in North America that could have been used on the structure of this size?

Becker:

I don't know how much history exists on the pricing of this type structure. The fabricating industry is just getting started in this area, as I see it. Costs can vary widely, even on the structure we had; if the Engineer had standardized certain diagonals we would have had many repetitive identical pieces. Lack of duplication is what made this structure so expensive; for the sake of changing a 3 x 3 x 3/16 angle to a 3 x 3 x 1/4 we lost a lot of repetitive fabrication. All these variations affected making the pieces different, and the more different units you must make, the higher the unit price is going to be. Now if there is a positive structural advantage to such changes, fine; but sometimes it looks like "polishing the peanut"-- no real gain for all the extra cost.

Durkee:

Well what kind of cost reduction would you think may be realized as a result of more standardization? Would the structural steelwork be reduced by about 10% in cost, perhaps?

Becker:

Well I think on the Atlanta roof structure, it could be more

PANEL DISCUSSION

significant than that--might even be 15 or 20% less.

Durkee:

That's a lot. Let us hear from Gerry Fox again.

Fox:

I was going to answer one obvious part of the question. There is a space roof in the Baltimore Airport. Perhaps some people here have seen this space roof. When it went out for bidding, there were as I recall, something like six bids. This bidding was not restricted to the United States, and some of the fabricators had their own particular space-frame systems. Out of the six bids, as I recall, there was one from the United States, one from Israel, one from France, one from Italy and one from Germany. These bids reflected competition in the design of the joints, a practice which is just starting in the United States.

Durkee:

Gerry, I take it that you did not spell out the joint details in your design plans?

Fox:

For aesthetic considerations we called for tubular members and we gave examples of joints that we felt were acceptable. (Durkee: Fabricator's choice, then?) Well, they had proprietary systems that met the requirements.

Wright:

Maybe, Mr. Chairman, I could add a word. I think what Gerry has just said indicates part of the current reality. There's been a lot of development invested in three-dimensional structural framework systems and in joint development, in Europe. It seems that most of the effort has come from people who make tubing; and as far as I can tell, using it like tooth-paste at the grocery market. That is, the joint detail is a loss-leader for the tube. And it's very hard to tell what costs what, in the price. If they're going to give you a sort of total-venture price--possibly that is,

PANEL DISCUSSION

for the supply of materials, fabrication and erection, and possibly the design thrown in, European style--then you might get a good competitive price. But you have to be sure you know what you're buying, and it's very hard to imagine buying those joint systems independently. The other part of John's question, is that only one or two of those systems can begin to cope with the forces that are represented in a frame as big as the one in Augusta. There are some other systems that have been used fairly widely, particularly in the light shells that I was describing; they are much simpler systems but they don't begin to cope with forces beyond the order of 100 kips.

Durkee:

Professor Steve Fenves from the Carnegie Mellon University.

Fenves:

I'd like to respond to George Winter's question from the standpoint of another group of practitioners, the computer program designers. From long and bitter experience we have found out that no matter what kind of disclaimers we put on our programs, we get blamed for whatever happens anyhow. So, at least I as an individual have been quite careful as to what programs I put my name on. I certainly would not put my name on a program that blindly iterates on an equal set of equal sizes to "optimize." I would put some sort of a damper on that program if for no other reason than to save the client some money, because, as Professor Epstein pointed out, those last few iterations are absolutely meaningless--they make a difference around one size at the very most. And secondly, I would not put my name on a program that doesn't provide the user the option of back-computing the joint loads from the actual members selected. There's no way I could make people do that, but I certainly would provide the option.

Durkee:

Good point. Now, Dr. Mike Gaus, National Science Foundation, Washington, D. C.

Mike Gaus:

I don't have a technical question, but a hypothetical comment. In view of the fact that many of these structures do not perform well under extreme overloads, particularly the single surface ones, I was just wondering if there had ever been any consideration given to merging the concepts of pneumatic structures and shell structures, to achieve

PANEL DISCUSSION

load balancing for extreme overloads? It might be a concept worth considering.

Wright:

I'm not aware of any designer having done that. There are some other interesting examples, though, in somewhat the same direction. A friend of mine in Mexico who's a designer-contractor has developed a very ingenious, and really quite superb system, of fabricating large water tanks. He uses hyperboloids of revolution which he frames with a very light shell structure made of light steel tubing, not even galvanized, and then uses a modified slip-forming technique and post-tensions the thing, throwing away, of course, the metallic shell after he gets the concrete up. And it's a superb concept of immense effectiveness. It just completely transforms the labor cost of building such a complicated shell, and would, I think, have great applicability in other countries where labor costs are still higher. So, it is a hybridization of the sense you described, where you take advantage of the superb lightness of the metallic skeleton, but don't make your ultimate structure dependent on it.

Durkee:

John Springfield.

Springfield:

Further comment to Dr. Gaus. If you put a pressure of about 0.05 pounds per square inch inside, you can use a 1/16 in. thick stainless steel membrane in place of all that other metallic material. On February 28th, we inflated a stainless steel membrane 300 f x 240 f, and so far, it's stayed there. This gets rid of all these terrible buckling problems.

Durkee:

You are telling us that you used the stainless steel skin as a containment surface.

Springfield:

Certainly.

PANEL DISCUSSION

Durkee:

Mike Gaus, again.

Gaus:

What I had in mind was not only for the erection of the structure, but also for the finished structure like a dome. In the event of an unusually heavy snow storm, you could switch on the pressurization system and therefore improve the safety of the frame.

Durkee:

Sounds good, but can it really be practical?

Wright:

It is, although, in truth it's really very easy to over-design the pneumatic structures-- they're so efficient that a little metal goes a long way, and of course because of the stability problem a few percentage points added to the diameter gives you three times the benefit in terms of your critical load, It is a practical solution.

Durkee:

I would like to ask Bob Loomis, what is the present status of the Hartford investigation?

Loomis:

Well in investigations are pretty well done as far as the City of Hartford is concerned. The City Council had it on the agenda just last night, as I recall, to accept the Lev Zetlin Associates report. Now I don't know what they did, I wasn't there. (Durkee: Tell us again how your investigation ties in...) Well, our study came to a somewhat different conclusion. We have presented it to the City Manager, to the Corporation Council, and to the City Council, so that we weren't hiding anything from anyone. Also, we have submitted a paper on the subject to ASCE. (Durkee: So presumably then there are two reports to be evaluated.) Well, there are really three because Lev Zetlin Associates has a report, the academic study group that the Mayor appointed has a report, and at Loomis & Loomis, we have ours. (Durkee: So there will be then, no doubt, evaluation and

PANEL DISCUSSION

further commentary on those three interpretations.) I would hope so, and I think now it can pretty much happen in professional circles since I think the politics are gone. (Durkee: Do you know who's going to be doing the evaluation? Has a firm been appointed?) No, I don't know of anything that's happening, except that the City is pretty well out of it at this stage. They have some litigation to go through with various people; and I'm sure the original design people and others have developed studies that may reflect some other ideas. But they aren't talking.

Durkee:

Yes, that is understandable. Well gentlemen, we've been hard at work for two hours and five minutes. This is a good subject. We can squeeze in a little more time. Bruce Johnston is looking for the floor.

R. G. Johnston:

Mr. Becker, did you consider making any static proof tests in the shop? It seems to me that for new kinds of structures, It might be a good idea from the fabricator-erector viewpoint.

Becker:

Yes, I'm glad you raised that question. We did make mock joints and cut macro etches to see where the penetration lines of the welds were. Fritz Engineering Laboratory ran qualification tests for us on weld metal, to establish our tensiles, and we also used E70 low-hydrogen electrodes throughout the building. Welding procedure, specifications were established in order to maintain good welding technique. I'm glad you gave me an opening because nowhere in my discussion did I talk about the important matter of distortion on this light type of welded construction. Our company was prudent in not getting into a lot of heavy welding on the top chords. By going to the "boot" system, we didn't have to get into straightening an unsymmetrical member because as the module was made, we had a triangle, and the top chord was the key. If the roof had been made the way it was originally designed, those chords would have curved as a result of all the welding at each panel point, because it was not symmetrical welding; it was unbalanced welding. So we kept the welding off the top chords, and put it on the bottom chords because they are symmetrical. You could balance the welding and control it in the shop. So distortion is an important thing in welded fabrication when you're welding heavy members which carry heavy stress, to thin members which happen to be continuous by virtue of the type of construction.

PANEL DISCUSSION

Durkee:

Did you have any problems with welding into a three-cornered situation where you would be inviting tri-axial stressing and, even in Atlanta, the prospect of brittle fracture problems?

Becker:

The biggest problem on this whole job was trying to develop each joint so that you could actually place those welds by elongating the gusset in the vertical direction, which was architecturally acceptable. It took a great deal of drafting time--another point I have not brought out before. This type of structure is of such a high level of structural design that it is really beyond the scope of an ordinary drafting office just to pick up and detail this. And that's something that needs to be considered in the cost also; we had three hundred shop and field drawings for this job. There was, as I said, very little duplication. One quadrant was not the same as another quadrant because of the way they were designed, with dead load being taken by the chords in the north-south direction. These chords were just a little heavier than the orthogonal chords in the east-west direction. So, this is another point that I want to make; welding distortion, member duplication, and the complexity of the drawings are things that really affect the cost, and are burdening the fabricating industry at this point. In other words, most fabricators are not geared at this point to deal with some of these problems.

Durkee:

Well, and the old story goes that the fabricator that hasn't had this exposure, underestimates his costs and underbids those who have, and so therefore the tendency would be for the inexperienced firm to be doing each new job. Right?

Becker:

Yes -- and so the engineers end up worrying.

Durkee:

Bruce Johnston again.

PANEL DISCUSSIONJohnston:

Hardy Cross has been mentioned -- he always told his students if a structure can find a way to fall down, it will.

Durkee:

He was probably right.

Milek:

He also said you have to know more than the structure if you want it to stand up.

Durkee:

John Dwight from Cambridge University.

Dwight:

We've heard from the fabricators. One suggests having different size members all over the place. And we've heard from Professor Johnston, and Professor Hardy Cross before him, how the structure will find a way to fall down. But now I'd like to try to merge these two statements. I had thought the whole idea of these space-frame structures was that you had standard chords and standard diagonals, that you ran all the way through. And I would have thought that instead of using elastic-type computer programs, you'd use the kind of computer program where you tell the computer that if you have a standard top chord, you use also a standard bottom chord, and a standard diagonal all 'round, and you tell the computer to do more like a basket design, analogous to a yield-line design for a concrete slab, assuming that all the members have their load redistribution capability. I know that in order to do this, Douglas Wright said in his talk, you've got to place limitations on the slenderness ratio of compression members. So that is one limitation. You're going to have either the slenderness ratio down to 70 or so, or maybe above 180 or something like that; probably keep in mind the snapping range for slenderness. But having done that, you go for a redistribution type of design, and give the fabricator one set of design details to implement in his drawing office. I'm surprised this hasn't been mentioned before in the discussion, because Mr. Loomis has been running such programs, such analyses. He's been talking about when you have 50 members coupled, the structure is doing so well; while I'm talking about the kind of design where you would have members buckled, but they'll go on taking their load. Well, I have never designed a space frame in all my life, so I shouldn't be standing here.

PANEL DISCUSSION

Durkee:

We'll accept your comment, except for the last statement. Bob Loomis.

Loomis:

Quite frankly, I have never designed a space-frame structure of the Hartford size; we were looking at it after the fact. I'm afraid that when you consider that an elastic analysis can cause what happened at Hartford, I'd be a little bit hesitant about being too quick to suggest that the same engineers go through a more sophisticated approach. Somebody didn't master something.

Durkee:

Bob Meith, Chevron.

R. M. Meith:

I'd like the whole panel to address this question. It concerns whether a code-writing body, building codes, etc. should require a certain amount of redundancy in these space frames.

Loomis:

Well, from our checking on the Hartford job, we're talking in terms of 70 to 90 buckled members. How much redundancy do you want? I think really it comes down to a question of what an engineer does when he gets it. You can't write a code that's always going to prevent failure; you have to rely on the designer who's working with it. I don't see any way around that. Perhaps the best thing is just to get information out in the open where the designing engineers can see what has happened in the past, and mistakes have been made; and then go on to avoid those pitfalls.

Durkee:

Further comment?

Meith:

I haven't dealt with the Hartford type of space frame. I was involved with offshore structures wherein we do get a certain amount of redundancy because wave-action loads exist sometimes during construction. But the

PANEL DISCUSSION

thing that we tell our junior engineers, is that you develop a feel for the problem in dealing with these structures. Now that's a hard thing to describe to our managers. They don't know what you're taking about when you say I've worked with the structure and I have a feeling that this particular member is very important -- that if it goes, the whole structure goes -- but that other member is less important, so I don't need to deal with it as closely. This is really what I had reference to in commenting about redundancy -- that certainly in these space frames there are certain members that are much more critical than others. Now should we not perhaps have a little additional safety factor and try to prevent the catastrophic type of thing, such as 70 buckled members. Are we sure that all of these buckled simultaneously? Or did the buckle happen after the failure?

Loomis:

I wouldn't say they all buckled simultaneously, but they buckled as the dead load was being put on. It wasn't after-the-fact of the collapse; these members apparently buckled as the dead load went on. But I think we're really saying the same thing. When I say that it comes down to the engineer, I'm saying just exactly what you are -- that you need a knowledgeable designer dealing with the members, not a computer automatically spewing out sizes. This is the essential part of it.

Durkee:

This question of safety factor is one about which there is no end of debate.

Loomis:

I think again that it comes down again to having someone familiar enough with the structure to know what is happening so that he can deal with it on that basis. I don't think you can write rules in the code that can substitute for that judgment.

Becker:

In reply to Bob Meith's question, the space-frame building in Augusta has some features different from those at Hartford. The redundancy that might have existed in the roof system at Hartford may not exist in a space frame such as that at Augusta, where at the haunches of the frame you have certain welds taking extremely high tension on the external chords. And if one of those welds goes, I just think it could propagate right down that wall, and the structure is not designed to take simple-span action. If that tension chord in the negative moment region of the frame goes, the stress

PANEL DISCUSSION

would have to re-distribute to adjacent panels and it could be an unbuttoning type of thing and very bad.

Loomis:

You said you have 3/4 inch plate. That's what Hartford had, and if you get very high stresses in those plates, that's another place where you can get unbuttoning. We found some tremendously high stresses where compression members came together at those 3/4 inch plates.

Becker:

At Augusta, we used weldments at all of the critical joints in the connections between roof and wall. The re-weldments were so arranged that we put a maximum amount of stress through shear welds, rather than through butt welds in tension. But one area that we were concerned about was those critical welds on the negative-moment region of the frame, right at the haunch where you have very high tensions and if one of those let go, it could be disastrous.

Durkee:

Well, gentlemen, it's been a good discussion, equal to the good presentations, and very worthwhile. I think we could go on for another two and a quarter hours, but in deference to the morning program, perhaps we had better take a recess until tomorrow.

Looking ahead, I can let you know that the 1980 Structural Stability Research Council panel discussion will be on the subject of bridge stability problems, and we are scheduled for New York City, a location which is reasonable to most of us. We'd like to see you all back next year.

Now, I want to thank our three speakers: Bob Loomis, who worked in on very short notice, Doug Wright and Ed Becker, all of whom did a fine job; and certainly the audience was most appreciative and responsive. Gentlemen, we thank you all -- it was a successful session.

1979 ANNUAL BUSINESS MEETING

The Structural Stability Research Council holds an annual meeting for the purpose of reporting activities, election of officers, and presentation of the budget for the following year. The 1979 Annual Business Meeting was held on April 25, 1979, in conjunction with the Annual Technical Session at The William Penn Hotel, Pittsburgh, Pennsylvania.

The minutes of the 1979 Annual Business Meeting follow:

CALL TO ORDER

The meeting was called to order at 11:30 a.m. by the Chairman, Jerome S. B. Iffland. Approximately 50 persons were present.

The Chairman introduced the new Vice Chairman, Jackson L. Durkee, the Director, Lynn S. Beedle, the Technical Secretary, Riccardo Zandonini, and the Administrative Secretary, Lesleigh G. Federinic.

The Chairman thanked the National Science Foundation for supporting the conference, the U. S. Steel Corporation for cosponsoring the reception, and Roland R. Graham for handling the local arrangements.

ELECTION OF OFFICER AND EXECUTIVE COMMITTEE MEMBERS

The Nominating Committee, chaired by L. K. Irwin, submitted the following nominations:

Vice Chairman: Jackson L. Durkee

Executive Committee: Walter J. Austin, Theodore V. Galambos,
William A. Milek, Jr.

Voting for all nominees was conducted by letter ballot to the membership. Results of the balloting were announced:

Vice Chairman: Jackson L. Durkee (2½ year term effective immediately)

Executive Committee: Walter J. Austin, Theodore V. Galambos,
William A. Milek, Jr. (3 year terms effective immediately)

MEMBERS-AT-LARGE

The following persons were nominated by the Executive Committee for election to Member-at-Large:

J. W. Clark, Alcoa Technical Center
M. Elgaaly, Bechtel Associates Professional Corp.
R. H. Gallagher, University of Arizona
L. Ingvarsson, Swedish Royal Institute of Technology

C. D. Miller, Chicago Bridge & Iron Company
 E. Popov, University of California, Berkeley
 Z. Razzaq, Southern Illinois University
 H. H. Spencer, Louisiana State University

The motion that all nominees be elected as Members-at-Large was carried unanimously.

LIFE MEMBERSHIP

The Executive Committee submitted the following person for Life Membership:

Marshall Holt

The motion that Holt become a Life Member was carried unanimously.

FINANCIAL REPORT

A summary of the financial status of the Council was presented by the Director including the proposed budget for fiscal year 1979-80.

Budget 1979-80:

Expected balance, Oct. 1, 1979	\$18,130.00
Income	26,350.00
Expenditures	32,900.00
Expected balance, Sep. 30, 1980	\$11,580.00

The budget was approved.

DIRECTOR'S REPORT

The Director's Report appears separately in the annual Proceedings.

It was announced that Dr. Sritawat Kitipornchai will join the SSRC staff in July as the new Technical Secretary.

NEXT ANNUAL TECHNICAL SESSION AND MEETING

The Chairman announced that the next Annual Technical Session and Meeting will be held at the New York Sheraton Hotel in New York City; dates will be 27-30 April 1980. The title of the Panel Discussion will be "Bridge Stability Problems".

ADJOURNMENT

The meeting was adjourned at 12:00 noon.

DIRECTOR'S REPORT
SSRC ANNUAL BUSINESS MEETING
April 25, 1979

This is "a time for research". That fact is evident in the reports of the task groups presented at the 1979 Annual Technical Session and also in the individual task group meetings. So our first responsibility is to thank each task group chairman and member for their diligence over the year.

Jerry Iffland is to be complimented on his leadership as the new Chairman of the Council. He assumed the role on short notice and has served the Council most notably. His idea of scheduling the task group meetings on the first day of these deliberations worked out remarkably well.

This is also a time for books, reports and publications. A number of the task groups are very evidently involved in this initiation.

The Guide continues to be the important focus of the Council. Thinking of the Fourth Edition, two task groups have already begun their work -- anticipating the schedule to be announced below.

All Council members are reminded of the fact that ASCE has designated its 1981 Spring meeting as an "International Conference". Reserve the dates May 11-16, 1981, New York City.

Headquarters hopes to give attention in the coming year to the development of a bibliography and also a booklet on publications. Both of these activities will involve close interaction with all of the task groups.

SSRC Guide

As of 31 March 1979, over 2500 copies of the Third Edition of the "Guide to Stability Design Criteria for Metal Structures" have been sold. This compares favorably with the record of sales of the prior edition.

The schedule for the Fourth Edition, outlined by editor, T. V. Galambos, is as follows:

- April 1980: Full outline prepared
- April 1981: First draft submitted by task groups
- April 1982: Final drafts submitted by task groups
- April 1983: Publication

The Executive Committee has reaffirmed that the emphasis and scope of the Fourth Edition of the Guide will be similar to that of the Third Edition.

Research Priorities

The first draft of the report has been prepared. As evident here at the Annual Technical Session, it will probably be retitled, "Research Needs: Structural Stability".

Ad-Hoc Committee on Column Problems

The Executive Committee has approved Technical Memorandum No. 5, entitled, "General Principles for the Stability Design of Metal Structures". The Executive Committee gave extensive "line by line" attention in its review. The next step is to arrange for its publication.

Task Group 1 (Centrally Loaded Columns)

After a period of review of research priorities, it is expected that future activity of this task group will be to provide advisory guidance for a project at Lehigh on "Column Strength Parameters." This has the objective of completing the needed research in this field and formulating design suggestions.

Task Group 4 (Frame Stability and Effective Column Length)

This is one of the task groups that has many active projects: a total of 11 at 8 universities. The task group is preparing a glossary. It is considering a change in title to better reflect actual scope.

Task group 6 (Test Methods for Compression Members)

Technical Memorandum No. 6 on the measurement of the residual stresses was approved by the task group. Copies will now be sent out for Executive Committee approval.

The task group is also looking at other measurement problems.

Task Group 7 (Tapered Members)

A book on rigid frames of tapered members is the current subject of consideration by this task group, one that is joint with the Welding Research Council.

Task Group 11 (International Cooperation on Stability Studies)

This task group goes back to 1967 and an ASCE meeting in Seattle. It sponsored the first International Colloquium in 1972, the second in 1976-77, and it's beginning plans for a third.

The work on a major Comparison/Summary Report of the four separate colloquia of the 2nd International Colloquium is nearing completion. Arrangements are being made for its publication under the tentative title "Stability of Metal Structures: A World View."

The theme of the 3rd International Conference might well be oriented toward this book with the emphasis on studying the significance of the differences

Task Group 18 (Unstiffened Tubular Members)

Task Group 18 reports 38 research projects underway on tubular members, 27 of which are in North America.

Task Group 20 (Composite Members)

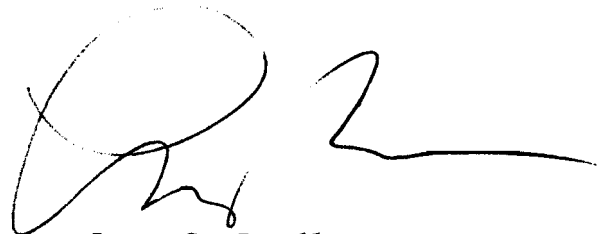
A major accomplishment of this task group, all within the one-year period since the last meeting in Boston, was to complete the final draft of a report entitled "A Specification for the Design of Composite Columns". It will most likely be published in the AISC Engineering Journal.

Task Group 22 (Stiffened Cylindrical Members)

Following up on the effective computer-oriented bibliographic work reported last year, the task group is now compiling, again by computer, test results from the considerable amount of experimental work that has been done in the past.

Task Group 23 (Effect of End Restraint on Initially Crooked Columns)

This newest task group is concerned with the effect of end restraint. Under the leadership of Prof. W. F. Chen, activity has moved along rapidly. Four to five teams are at work on the subject of end restraint in initially crooked members.

A handwritten signature in black ink, consisting of a large, stylized initial 'L' followed by a series of loops and a long horizontal stroke extending to the right.

Lynn S. Beedle
Director

1979 ANNUAL TECHNICAL SESSION AND MEETING ATTENDANCE

<u>Participant</u>	<u>Affiliation</u>
Abrahams, M. J. Austin, W. J.	Parsons, Brinkerhoff, Quade & Douglas, New York City Rice University, Houston, Texas
Beedle, L. S. Becker, E. P. Bernstein, M. D. Birkemoe, P. C. Bjorhovde, R.	Lehigh University, Bethlehem, Pennsylvania Lehigh Structural Steel Company, Allentown, Penna. Foster Wheeler Energy Corp., Livingston, New Jersey University of Toronto, Canada University of Alberta, Canada
Chapuis, J. Chen, W. F. Cheng, F. Y. Christianson, J. A. Clark, J. W.	Washington University (Student), St. Louis, Missouri Purdue University, Lafayette, Indiana University of Missouri, Rolla, Missouri Christianson Consultants, Pittsburgh, Pennsylvania Alcoa Laboratories, Alcoa Center, Pennsylvania
Davis, B. J. Donohoe, M. F. Durkee, J. L. Dwight, J. B.	University of Pittsburgh (Student), Pennsylvania University of Pittsburgh (Student), Pennsylvania Consulting Structural Engineer, Bethlehem, Penna. University of Cambridge, United Kingdom
Epstein, H. I. Errera, S. J.	University of Connecticut, Storrs, Connecticut Bethlehem Steel Corporation, Bethlehem, Pennsylvania
Federinic, L. G. Fenves, S. J. Fleischer, W. J. Fox, G. F.	Lehigh University, Bethlehem, Pennsylvania Carnegie-Mellon University, Pittsburgh, Pennsylvania Bethlehem Steel Corporation, Bethlehem, Pennsylvania Howard Needles Tammen & Bergendoff, New York City
Galambos, T. V. Gaus, M. P. Gilligan, J. A. Gilmor, M. I. Graham, R. R.	Washington University, St. Louis, Missouri National Science Foundation, Washington, D. C. U. S. Steel Corporation, Pittsburgh, Pennsylvania Canadian Institute of Steel Construction, Ontario U. S. Steel Corporation, Pittsburgh, Pennsylvania
Haaiker, G. Hall, D. H. Hartmann, A. J. Hawranek, R. Hedgren, Jr., A. W. Holt, M. Hosokawa, H. Hsiong, W. Hsu, T. L.	U. S. Steel Corporation, Monroeville, Pennsylvania Bethlehem Steel Corporation, Bethlehem, Pennsylvania Monroeville, Pennsylvania University of Toronto, Canada Richardson, Gordon & Associates, Pittsburgh, Penna. New Kensington, Pennsylvania Lehigh University, Bethlehem, Pennsylvania MTA Incorporated, Springfield, Illinois State University of New York, Buffalo, New York
Iffland, J. S. B.	Iffland Kavanagh Waterbury, New York City
Johnson, A. L. Johnson, D. L. Johnston, B. G.	American Iron and Steel Institute, Washington, D. C. Butler Manufacturing Company, Grandview, Missouri Consultant, Tucson, Arizona

Ketter, R. L.	State University of New York, Buffalo, New York
Killam, E. H.	Custodis Construction Company, Terre Haute, Indiana
Kinra, R. K.	Shell Oil Company, Houston, Texas
Koo, B.	University of Toledo, Toledo, Ohio
Krajcinovic, D.	University of Illinois at Chicago Circle, Chicago, Ill.
Krone, L. H.	Washington University (Student), St. Louis, Missouri
Lee, G. C.	State University of New York, Buffalo, New York
Loomis, R. H.	Loomis and Loomis, Inc. Windsor, Connecticut
Loomis, R. S.	Loomis and Loomis, Inc., Windsor, Connecticut
Loomis, R. W.	Loomis and Loomis, Inc., Windsor, Connecticut
Mangelsdorf, C. P.	University of Pittsburgh, Pittsburgh, Pennsylvania
Masoumy, G. H.	Washington University (Student), St. Louis, Missouri
Meith, R. M.	Chevron U.S.A., Inc., New Orleans, Louisiana
Milek, Jr., W. A.	American Institute of Steel Construction, New York City
Miller, C. J.	Case Western Reserve University, Cleveland, Ohio
Mukaiyama, T.	Lehigh University, Bethlehem, Pennsylvania
Ostapenko, A.	Lehigh University, Bethlehem, Pennsylvania
Pekoz, T.	Cornell University, Ithaca, New York
Plaut, R. H.	Virginia Polytechnic Institute, Blacksburg, Virginia
Poellot, W. N.	Richardson, Gordon & Associates, Pittsburgh, Pa.
Prickett, J. E.	Modjeski and Masters, Harrisburgh, Pennsylvania
Radeck, D.	Carnegie-Mellon University (Student), Pittsburgh, Pa.
Razzaq, Z.	Southern Illinois University, Carbondale, Illinois
Sandford, P. G.	Canadian Institute of Steel Construction, Ontario, Canada
Sfintesco, D.	European Convention for Constructional Steelwork, France
Sherman, D. R.	University of Wisconsin, Milwaukee, Wisconsin
Simitses, G. J.	Georgia Institute of Technology, Atlanta, Georgia
Spencer, H. H.	Louisiana State University, Baton Rouge, Louisiana
Springfield, J.	Carruthers and Wallace Limited, Ontario, Canada
Stringer, D. C.	Dominion Bridge Company, Ltd., Ontario, Canada
Temple, M. C.	University of Windsor, Ontario, Canada
Thomaidis, S. S.	Bethlehem Steel Corporation, Bethlehem, Pennsylvania
Tiberio, T. J.	United States Steel Corporation, Monroeville, Pa.
Varney, R. F.	Federal Highway Administration, Washington, D. C.
Vinnakota, S.	Cornell University (Visiting), Ithaca, New York
Wang, C. K.	University of Wisconsin, Madison, Wisconsin
Winter, G.	Cornell University, Ithaca, New York
Wright, D. T.	Ministry of Culture and Recreation, Ontario, Canada
Yoo, C. H.	Marquette University, Milwaukee, Wisconsin
Yu, W. W.	University of Missouri, Rolla, Missouri
Zandonini, R.	Lehigh University, Bethlehem, Pennsylvania
Zellin, M. A.	Sverdrup & Parcell & Associates, Inc., St. Louis, Mo.

List of Publications

The following papers and reports have been received at Headquarters and have been placed in the SSRC Library.

Chen, W. F.

INFLUENCE OF END RESTRAINT ON COLUMN STABILITY, ASCE Convention & Exposition, Atlanta, October 23-25, 1979, Preprint 3608

Ellis, J. S.

LATTICED BEAM-COLUMNS WITH PRESTRESSED AND OFFSET DIAGONALS AND INITIALLY CURVED LONGITUDINALS AND CROSSARMS, Royal Military College of Canada, Civil Engineering Report No. 79-1, February, 1979

Kamtekar, A. G.

AN EXPERIMENTAL STUDY OF WELDING RESIDUAL STRESSES, Department of Engineering, University of Cambridge, Technical Report No. CUED / C-Struct / TR. 39, 1974

Kamtekar, A. G.

STRESSES MEASURED IN INVESTIGATIONS OF THE EFFECTS OF WELDING, Department of Engineering, University of Cambridge, Technical Report No. CUED / C-Struct / TR. 43, 1974

Kamtekar, A. G.

THEORETICAL DETERMINATION OF WELDING RESIDUAL STRESSES, Department of Engineering, University of Cambridge, Technical Report No. CUED / C-Struct / TR. 45, 1975

Kamtekar, A. G.

RESIDUAL STRESSES DUE TO INTERMITTENT AND TWO-PASS WELDS, Department of Engineering, University of Cambridge, Technical Report No. CUED / C-Struct / TR. 46, 1975

Ketter, R. L. and Lee, G. C. , and Prawel, S. P., Jr.

STRUCTURAL ANALYSIS AND DESIGN, McGraw-Hill Book Company, New York, 1979

Kitipornchai, S. and Trahair, N. S.

BUCKLING PROPERTIES OF MONOSYMMETRIC I-BEAMS, Department of Civil Engineering Research Report Series, University of Queensland, Research Report No. CE4, May, 1979

Massonnett, Ch. and Maquoi, R.

RECENT PROGRESS IN THE FIELD OF STRUCTURAL STABILITY OF STEEL STRUCTURES, International Association for Bridge and Structural Engineering Surveys, S-5 / 78, Liege, May, 1978

Nylander, H.

EFFECTIVE WIDTH OF COMPRESSED RECTANGULAR PLATE, Institutionen for Byggnadsstatik Kungl. Tekniska Hogskolan, Meddelande No. 133, Stockholm, 1978

Sundquist, H.

TEKNISK BROTTLINJETEORI FOR PLATTOR BELASTADE MED KORTVARIG DYNAMISK LAST, Institutionen for Byggnadsstatik Kungl. Tekniska Hogskolan, Meddelande No. 127, Stockholm, 1978

Sundquist, H.

CONCRETE SLABS SUPPORTED ON SLENDER COLUMNS UNDER SHORT DURATION LOADS - SUMMARY, Institutionen for Byggnadsstatik Kungl. Tekniska Hogskolan, Meddelande NO. 134, Stockholm, 1979

Van der Woude, F. and Cousins, B. F.

DEFORMATION OF ARCHES: LINEAR ELASTIC BEHAVIOR, Civil Engineering Department, University of Tasmania, Research Report CM - 78 / 3, 1978

Van der Woude, F. and Cousins, B. F.

DEFORMATION OF ARCHES: ELASTIC BUCKLING BEHAVIOR, Civil Engineering Department, University of Tasmania, Research Report CM - 78 / 4, 1978

White, J. D.

LONGITUDINAL STRESSES IN A MEMBER CONTAINING NON-INTERACTING WELDS, Department of Engineering, University of Cambridge, Technical Report No. CUED / C - Struct / TR. 58, 1977

Young, B. W. and Dwight, J. B.

RESIDUAL STRESSES DUE TO LONGITUDINAL WELDS AND FLAME-CUTTING, Department of Engineering, University of Cambridge, Technical Report NO. CUED / C- Struct / TR. 9, 1971

SSRC Chronology

- 9-10 Oct 78 - Executive Committee Meeting, Pittsburgh, Pa.
- 8 Dec 78 - J. W. Clark resigned as SSRC Chairman
- 5 Jan 79 - Colloquium Comparison/Summary Report Workshop, Bethlehem, Pa.
- 25 Jan 79 - J. S. B. Iffland appointed SSRC Chairman
- 25 Jan 79 - Chairman's Meeting, Bethlehem, Pa.
- 22-25 Apr 79- Annual Technical Session and Meeting, Executive Committee Meetings, Task Group Meetings, Pittsburgh, Pa.
- 25 Apr 79 - J. L. Durkee elected SSRC Vice Chairman
- 25 May 79 - SSRC Technical Secretary - Riccardo Zandonini - returned to Italy
- 9 Jul 79 - Sritiwat Kitipornchai assumed duties of SSRC Technical Secretary

Finance

	Fiscal Year 10/78-9/79		Fiscal Year 10/79-9/80
	Budget (approved 5/17/78)	Cash Statement 10/1/78-9/30/79	Budget (approved 4/25/79)
<u>BALANCE</u> at Beginning of Period	\$20,400.00	\$25,185.39 (a)	\$18,130.00
<u>INCOME</u>			
<u>Contributions</u>			
Sponsoring Organizations			
AISC	4,000.00	4,000.00	4,000.00
AISI	5,000.00	5,000.00	5,000.00
CISC	1,000.00	1,000.00	1,000.00
FHWA	---	6,000.00 (b)	---
NSF	9,000.00	9,655.00	10,000.00 (b)
Participating Organizations	1,500.00	1,900.00 (c)	1,500.00
Participating Firms	2,000.00	1,900.00 (d)	1,800.00
Total Contributions	\$22,500.00	\$29,455.00	\$23,300.00
<u>Registration Fees</u>	2,000.00	2,386.00 (e)	2,000.00
<u>MAL Subscription Fees</u>	---	610.00	50.00
<u>Guide Royalties</u>	1,000.00	1,532.63	800.00
<u>Sale of Publications</u>	---	54.31	---
<u>Interest</u>	200.00	---	200.00
TOTAL INCOME	\$25,700.00	\$34,037.94	\$26,350.00
<u>EXPENDITURES</u>			
<u>Technical Services (Hqtrs)</u>			
Staff Salaries	\$12,400.00	\$15,778.21 (f)	\$15,000.00
Supply, phone, mailing	1,400.00	1,053.37	1,400.00
Travel	1,000.00	1,336.12	500.00
Total Technical Services	\$14,800.00	\$18,167.70	\$16,900.00
<u>Research Support</u>	5,000.00		5,000.00
Univ. of Mass. (Chajes)		2,500.00	
<u>Annual Meeting & Proceedings</u>			
Annual Proceedings	\$ 1,300.00	\$ 1,152.94	\$ 1,200.00
Colloquium Summary	3,800.00 (g)	1,569.85	---
Expenses & Services	7,700.00 (g)	3,865.88	5,000.00
Travel	2,000.00	2,344.83	3,500.00
Total AM & Proceedings	\$14,800.00	\$ 8,933.50	\$ 9,700.00
<u>United Engineering Trustees</u>	100.00	100.00	100.00
<u>Travel</u>	500.00 (h)	1,752.81 (i)	1,000.00
<u>Contingencies</u>	200.00	222.00 (j)	200.00
TOTAL EXPENDITURES	\$35,400.00	\$31,676.01	\$32,900.00
<u>BALANCE</u> at End of Period	\$10,700.00	\$27,547.32 (k)	\$11,580.00

EXPLANATORY NOTES

- (a) Depositories (as of 10/1/78)
- | | |
|-----------------------------------|-----------------|
| General Account (UET) | \$17,326.94 |
| Technical Services (Lehigh Univ). | 337.95 |
| NSF Grant (Colloquium) | 3,144.55 |
| NSF Grant (Boston ATS&M) | <u>4,375.95</u> |
| | \$25,185.39 |
- (b) Grant received from Federal Highway Administration to support the 1980 Annual Technical Session & Meeting in New York City. An additional \$6,000 to be received from Urban Mass Transit Administration after 1 Oct 79. NSF support not requested.
- (c) Aluminum Association (\$500); American Petroleum Institute (\$100); American Society of Mechanical Engineers (\$100); Corps of Engineers, U. S. Army (\$100); European Convention for Constructional Steelwork (\$100); Canadian Society of Civil Engineers (\$100); Federal Highway Administration (\$100); International Conference of Building Officials (\$100); Institution of Engineers, Australia (\$100); Langley Research Center, NASA (\$100); Naval Ship Research & Development Center (\$100); Naval Facilities Engineering Command (\$100); Structural Engineers Association of California (\$100); Steel Joist Institute (\$200)
- (d) Carruthers and Wallace Limited; Chevron U.S.A., Inc.; De Leuw Cather & Co.; Earl and Wright; Gannett Fleming Corddry and Carpenter, Inc.; Hardesty & Hanover; Hazelet & Erdal; Howard Needles Tammen & Bergendoff; Iffland Kavanagh Waterbury; Le Messurier Associates/SCI; Modjeski and Masters; Parsons Brinckerhoff Quade & Douglas; Richardson Gordon and Associates; Sargent & Lundy; Skilling, Helle, Christiansen, Robertson; Sverdrup & Parcel and Associates, Inc.; Tippetts-Abbett-McCarthy-Stratton; URS/Madigan-Praeger, Inc.; Weiskopf & Pickworth.
- (e) Includes money paid for luncheon.
- (f) Technical Services (Hqtrs)
- | | <u>SSRC Funds</u> | <u>NSF GRANTS</u> | | |
|------------------------------|-------------------|-------------------|-------------------|-------------------|
| | | <u>Colloq</u> | <u>Boston</u> | <u>Pitt</u> |
| Director | \$1,275.00 | | | |
| Technical Secretary | 3,934.09 | \$1,200.00 | | |
| Administrative Secretary | 3,495.19 | | \$1,504.86 | \$1,343.52 |
| Secretary/Clerical | 1,032.98 | 903.02 | 401.80 | 687.75 |
| (includes employee benefits) | | | | |
| | <u>\$9,737.26</u> | <u>\$2,103.02</u> | <u>\$1,906.66</u> | <u>\$2,031.27</u> |
- (g) A portion of the expenditure under this budget item appears in salaries under "Technical Services". See above note (f).
- (h) Additional travel support, not to exceed \$1200, was approved by the Executive Committee in Oct 78 for the Comparison/Summary Report Committee meeting in Jan 79.

EXPLANATORY NOTES - cont'd

- (i) Executive Committee Meeting, Pittsburgh, October 1978; Colloquium Comparison/Summary Report Workshop, Lehigh University, January 1979.
- (j) Payment to D. Sfintesco (5 ECCS Manuals); Castle Island Press (35th Anniversary stickers); Cambridge University (technical publications).
- (k) Depositories (as of 9/30/79)
- | | |
|-----------------------------------|-----------------|
| General Account (UET) | \$16,430.13 |
| Technical Services (Lehigh Univ.) | 713.79 |
| NSF Grant (Colloquium) | -0- |
| NSF Grant (Boston ATS&M) | -0- |
| NSF Grant (Pittsburgh ATS&M) | 4,403.40 |
| FHWA Grant (NYC ATS&M) | <u>6,000.00</u> |
| | \$27,547.32 |

Register

Chairman: J. B. S. Iffland
 Vice Chairman: J. L. Durkee

EXECUTIVE COMMITTEE

J. S. B. Iffland (81)
 J. L. Durkee (81)
 L. S. Beedle (Director)
 W. J. Austin (82)
 S. J. Errera (80)
 G. F. Fox (81)
 T. V. Galambos (82)
 R. R. Graham (81)
 T. R. Higgins (Technical Consultant)
 B. G. Johnson (81)
 R. M. Meith (80)
 W. A. Milek, Jr. (82)
 J. Springfield (80)
 G. Winter*

* Past Chairman

STANDING & AD HOC COMMITTEES

A. Committee on Guide to Stability Design Criteria for Metal Structures

B. G. Johnston, Chairman	L. S. Beedle
T. V. Galambos, Editor	J. S. B. Iffland
	G. Winter

B. Committee on Finance

G. F. Fox, Chairman
 J. S. B. Iffland
 L. S. Beedle
 R. E. Beil

C. Ad Hoc Committee on Research Priorities

J. S. B. Iffland, Chairman	S. J. Errera
R. Bjorhovde, Editor	T. V. Galambos
	R. M. Meith

D. Ad Hoc Committee on Column Problems

T. V. Galambos, Chairman	E. H. Gaylord
R. Bjorhovde	J. S. B. Iffland
W. F. Chen	J. Springfield

TASK GROUPS

Task Group 1 - Centrally Loaded Columns

R. Bjorhovde, Chairman	J. L. Durkee	B. G. Johnston
L. S. Beedle	J. A. Gilligan	T. Pekoz
W. F. Chen	R. R. Graham*	L. Tall
J. W. Clark	D. H. Hall	R. Zandonini

Scope: To define the strength of centrally-loaded columns, taking due account of the influence of the column geometry, the column cross-sectional geometric properties, the mechanical properties of the column material, and the variables associated with manufacture of column components and with column fabrication.

Task Group 3 - Columns With Biaxial Bending

J. Springfield, Chairman*	S. L. Chin	S. U. Pillai
M. J. Abrahams	L. W. Lu	Z. Razzaq
W. F. Chen	D. A. Nethercot	S. Vinnakota

Scope: To investigate the behavior of columns subjected to biaxial bending, and to develop rational stability criteria based in the ultimate strength of such members.

Task Group 4 - Frame Stability and Effective Column Length

J. S. B. Iffland, Chairman*	J. H. Daniels	L. W. Lu
P. F. Adams	W. E. Edwards	W. A. Milek, Jr.
C. Birnstiel	P. Grundy	Z. Razzaq
M. Biswas	T. R. Higgins	C. K. Wang
F. Y. Cheng	I. M. Hooper	J. A. Yura
H. de Clercq		M. A. Zellin

Scope: To develop procedures for investigating the stability of structural frameworks. The evaluation of when the effective-column length concept should be used, and when not, is an important consideration.

Task Group 6 - Test Methods for Compression Members

T. Pekoz, Chairman	S. J. Errera*	D. R. Sherman
R. Bjorhovde	B. G. Johnston	L. Tall

Scope: To prepare technical memoranda on test apparatus and on techniques for testing structural members subject to buckling, and to develop procedures for interpreting the associated test data.

* Executive Committee Contact Member

Register

Chairman: J. B. S. Iffland
Vice Chairman: J. L. Durkee

EXECUTIVE COMMITTEE

J. S. B. Iffland (81)
J. L. Durkee (81)
L. S. Beedle (Director)
W. J. Austin (82)
S. J. Errera (80)
G. F. Fox (81)
T. V. Galambos (82)
R. R. Graham (81)
T. R. Higgins (Technical Consultant)
B. G. Johnson (81)
R. M. Meith (80)
W. A. Milek, Jr. (82)
J. Springfield (80)
G. Winter*

* Past Chairman

STANDING & AD HOC COMMITTEES

A. Committee on Guide to Stability Design Criteria for Metal Structures

B. G. Johnston, Chairman	L. S. Beedle
T. V. Galambos, Editor	J. S. B. Iffland
	G. Winter

B. Committee on Finance

G. F. Fox, Chairman
J. S. B. Iffland
L. S. Beedle
R. E. Beil

C. Ad Hoc Committee on Research Priorities

J. S. B. Iffland, Chairman	S. J. Errera
R. Bjorhovde, Editor	T. V. Galambos
	R. M. Meith

D. Ad Hoc Committee on Column Problems

T. V. Galambos, Chairman	E. H. Gaylord
R. Bjorhovde	J. S. B. Iffland
W. F. Chen	J. Springfield
	J. A. Yura

Secretaries: R. Zandonini, Technical

TASK GROUPS

Task Group 1 - Centrally Loaded Columns

R. Bjorhovde, Chairman	J. L. Durkee	B. G. Johnston
L. S. Beedle	J. A. Gilligan	T. Pekoz
W. F. Chen	R. R. Graham*	L. Tall
J. W. Clark	D. H. Hall	R. Zandonini

Scope: To define the strength of centrally-loaded columns, taking due account of the influence of the column geometry, the column cross-sectional geometric properties, the mechanical properties of the column material, and the variables associated with manufacture of column components and with column fabrication.

Task Group 3 - Columns With Biaxial Bending

J. Springfield, Chairman*	S. L. Chin	S. U. Pillai
M. J. Abrahams	L. W. Lu	Z. Razzaq
W. F. Chen	D. A. Nethercot	S. Vinnakota

Scope: To investigate the behavior of columns subjected to biaxial bending, and to develop rational stability criteria based in the ultimate strength of such members.

Task Group 4 - Frame Stability and Effective Column Length

J. S. B. Iffland, Chairman*	J. H. Daniels	L. W. Lu
P. F. Adams	W. E. Edwards	W. A. Milek, Jr.
C. Birnstiel	P. Grundy	Z. Razzaq
M. Biswas	T. R. Higgins	C. K. Wang
F. Y. Cheng	I. M. Hooper	J. A. Yura
H. de Clercq		M. A. Zellin

Scope: To develop procedures for investigating the stability of structural frameworks. The evaluation of when the effective-column length concept should be used, and when not, is an important consideration.

Task Group 6 - Test Methods for Compression Members

T. Pekoz, Chairman	S. J. Errera*	D. R. Sherman
R. Bjorhovde	B. G. Johnston	L. Tall

Scope: To prepare technical memoranda on test apparatus and on techniques for testing structural members subject to buckling, and to develop procedures for interpreting the associated test data.

* Executive Committee Contact Member

Task Group 7 - Tapered Members (Joint Task Group with Welding Research Council)

A. Amirikian, Chairman	T. R. Higgins*	L. W. Lu
D. J. Butler	D. L. Johnson	C. J. Miller
C. R. Femley, Jr.	K. H. Koopman	F. J. Palmer
D. S. Ellifritt	G. C. Lee	M. Yachnis

Scope: To develop practical procedures for determining the strength of tapered structural members and of frames made therefrom.

Task Group 8 - Dynamic Stability of Compression Members

D. Krajcinovic, Chairman	S. M. Holzer	G. J. Simitzes
J. Amazigo	B. G. Johnston*	J. C. Simonis
S. S. Chen	R. H. Plaut	

Scope: To define the strength of columns and other compression members subjected to time-dependent loading.

Task Group 11 - International Cooperation on Stability Studies

D. Sfintesco, Chairman	T. V. Galambos	P. Marek
W. A. Milek, Jr., V. Chairman*	M. P. Gaus	G. W. Schulz
G. A. Alpsten	O. Halasz	J. Strating
L. S. Beedle	J. S. Iffland	L. Tall
A. Carpena	B. Kato	R. Zandonini
M. Crainicescu		

Scope: To coordinate American, Japanese and European research groups, and to organize international colloquia, in the field of stability problems. In particular, to provide liaison between SSRC Task Groups, the Japanese Column Research Committee, and Committee 8 of the European Convention for Constructural Steelwork; and to suggest joint research projects.

Task Group 12 - Mechanical Properties of Steel in Inelastic Range

R. Testa, Chairman	A. Gjelsbik	L. W. Lu
G. A. Alpsten	A. L. Johnson	E. P. Popov
G. F. Fox*	B. G. Johnston	F. D. Sears

Scope: To Obtain and interpret data on the mechanical properties of steel in the inelastic range that are of particular importance to stability problems, including the determination of the average value and variation of the following: yield stress level, yield strength, tangent modulus, secant modulus, strain-hardening modulus, and magnitude of strain at incipient strain hardening.

* Executive Committee Contact Member

Task Group 13 - Thin-Walled Metal Construction

W. W. Yu, Chairman	C. Marsh	W. P. Vann
J. W. Clark	T. M. Murray	S. T. Wang
S. J. Errera	A. Ostapenko	G. Winter*
A. L. Johnson	T. Pekoz	

Scope: To investigate the behavior of thin-walled members made of carbon steels, alloy steels, stainless steels, or aluminum alloys; and to develop stability criteria for such members, taking due account of the effects of manufacturing and the fabrication processes.

Task Group 14 - Horizontally Curved Girders

M. Ojalvo, Chairman	C. G. Culver	W. A. Milek, Jr.
R. Behling	J. L. Durkee*	S. Shore
H. R. Brannon	E. R. Latham	W. M. Thatcher
A. P. Cole	P. Marek	C. H. Yoo

Scope: To investigate the behavior of horizontally curved girders, taking due account of the effects of rolling and fabrication practices; and to develop criteria for adequate bracing for such girders.

Task Group 15 - Laterally Unsupported Beams

J. A. Yura, Chairman	A. J. Hartmann	D. A. Nethercot
Y. Fukumoto	S. Kitipornchai	M. Ojalvo
T. V. Galambos*	C. P. Mengelsdorf	N. S. Trahair

Scope: To study the behavior of and develop stability criteria for laterally unsupported beams, including those in framed structures; and to determine bracing requirements for such beams.

Task Group 16 - Plate Girders

W. Hsiong, Chairman	R. S. Fountain	F. D. Sears
K. Basler	K. L. Heilman	H. H. Spencer
P. B. Cooper	H. S. Lew	B. T. Yen
J. L. Durkee*	C. Massonnet	R. C. Young
	A. Ostapenko	H. E. Waldner

Scope: To develop practical procedures for determining the ultimate strength of stiffened plate girders, and to extend these procedures to include plate girders with multiple longitudinal stiffeners.

* Executive Committee Contact Member

Task Group 17 - Stability of Shell-Like Structures

A. Chajes, Chairman	J. W. Clark	C. D. Miller
J. H. Adams	M. Crainicescu	E. P. Popov
W. J. Austin*	S. X. Gunzleman	D. R. Sherman
L. O. Bass	A. L. Johnson	J. C. Simonis
J. Bruegging	A. Kalnins	H. H. Spencer
K. P. Buchert	D. Krajcinovic	D. T. Wright
A. C. T. Chen	C. Libove	

Scope: To investigate the stability of shell-like structures (those structures where the load - carrying elements also serve the functional requirements of enclosing space).

Task Group 18 - Unstiffened Tubular Members

D. R. Sherman, Chairman	A. Chajes	T. G. Johns
B. O. Almroth	S. L. Chin	P. W. Marshall
M. D. Bernstein	J. W. Cox	R. M. Meith*
P. C. Birkemoe	E. D. George, Jr.	C. D. Miller
C. Capanoglu	R. R. Graham	

Scope: To develop stability criteria for manufactured and fabricated unstiffened cylindrical tubular members, and to study the behavior of unstiffened non-cylindrical tubular members.

Task Group 20 - Composite Members

S. H. Iyengar, Chairman	B. Kato	M. Wakabayashi
P. Dowling	J. W. Roderick	G. Winter*
R. W. Furlong	D. Sfintesco	

Scope: To develop stability criteria for various types of composite columns.

Task Group 21 - Box Girders

R. C. Young, Chairman	B. Morgastern	M. C. Tang
J. H. Daniels	D. R. Schelling	D. Tung
G. F. Fox*	F. D. Sears	R. Wolchuk
F. Moolani		

Scope: To review, organize and interpret available information on the behavior of box girders, cooperating with other groups working on this subject; and to develop stability criteria as needed.

Task Group 22 - Stiffened Tubular Members

C. D. Miller, Chairman	J. W. Cox	R. K. Kinra
W. J. Austin	R. C. DeHart	R. M. Meith*
C. Babcock	N. W. Edwards	R. L. Rolf
M. D. Bernstein	R. F. Jones	G. J. Simitzes
K. P. Buchert	E. H. Killam	R. C. Tennyson
C. Capanoglu		

Scope: Will consider cylinders with longitudinal or circumferential stiffening alone or in combination. Stability criteria will be developed for axial load, external or internal pressure, beam type bending and torsion. Consideration will be given to local buckling and general instability type failures. Available test data will be compared with suggested stability criteria. Recommendations will be made where insufficient data is available. The first task will be to develop criteria for axial load. External pressure criteria presented in Chapter 10 of the SSRC Guide will be reviewed.

Task Group 23 - Effect of End Restraint on Initially Crooked Columns

W. F. Chen, Chairman	B. Koo	J. Springfield
R. Bjorhovde	D. A. Nethercot	S. Vinnakota
F. Cheong-Siat-Moy	Z. Razzaq	G. Winter*
T. V. Galambos	D. A. Ross	R. Zandonini
J. S. B. Iffland		

Scope: To study the effect of end restraint on these isolated, hinged-end, initially crooked w-shape columns for which residual stress patterns are generally known.

TASK REPORTERS

Task Reporter 11 - Stability of Aluminum Structural Members

J. W. Clark, Aluminum Company of America

Task Reporter 13 - Local Inelastic Buckling

L. W. Lu, Lehigh University

Task Reporter 14 - Fire Effects on Structural Stability

Task Reporter 15 - Curved Compression Members

W. J. Austin, Rice University

Task Reporter 16 - Stiffened Plate Structures

A. Monsour, Monsour Engineering

Task Group 17 - Stability of Shell-Like Structures

A. Chajes, Chairman	J. W. Clark	C. D. Miller
J. H. Adams	M. Crainicescu	E. P. Popov
W. J. Austin*	S. X. Gunzleman	D. R. Sherman
L. O. Bass	A. L. Johnson	J. C. Simonis
J. Bruegging	A. Kalnins	H. H. Spencer
K. P. Buchert	D. Krajcinovic	D. T. Wright
A. C. T. Chen	C. Libove	

Scope: To investigate the stability of shell-like structures (those structures where the load - carrying elements also serve the functional requirements of enclosing space).

Task Group 18 - Unstiffened Tubular Members

D. R. Sherman, Chairman	A. Chajes	T. G. Johns
B. O. Almroth	S. L. Chin	P. W. Marshall
M. D. Bernstein	J. W. Cox	R. M. Meith*
P. C. Birkemoe	E. D. George, Jr.	C. D. Miller
C. Capanoglu	R. R. Graham	

Scope: To develop stability criteria for manufactured and fabricated unstiffened cylindrical tubular members, and to study the behavior of unstiffened non-cylindrical tubular members.

Task Group 20 - Composite Members

S. H. Iyengar, Chairman	B. Kato	M. Wakabayashi
P. Dowling	J. W. Roderick	G. Winter*
R. W. Furlong	D. Sfintesco	

Scope: To develop stability criteria for various types of composite columns.

Task Group 21 - Box Girders

R. C. Young, Chairman	B. Morgastern	M. C. Tang
J. H. Daniels	D. R. Schelling	D. Tung
G. F. Fox*	F. D. Sears	R. Wolchuk
F. Moolani		

Scope: To review, organize and interpret available information on the behavior of box girders, cooperating with other groups working on this subject; and to develop stability criteria as needed.

C. D. Miller, Chairman	J. W. Cox	R. K. Kinra
W. J. Austin	R. C. DeHart	R. M. Meith*
C. Babcock	N. W. Edwards	R. L. Rolf
M. D. Bernstein	R. F. Jones	G. J. Simitzes
K. P. Buchert	E. H. Killam	R. C. Tennyson
C. Capanoglu		

Scope: Will consider cylinders with longitudinal or circumferential stiffening alone or in combination. Stability criteria will be developed for axial load, external or internal pressure, beam type bending and torsion. Consideration will be given to local buckling and general instability type failures. Available test data will be compared with suggested stability criteria. Recommendations will be made where insufficient data is available. The first task will be to develop criteria for axial load. External pressure criteria presented in Chapter 10 of the SSRG Guide will be reviewed.

Task Group 23 - Effect of End Restraint on Initially Crooked Columns

W. F. Chen, Chairman	B. Koo	J. Springfield
R. Bjorhovde	D. A. Nethercot	S. Vinnakota
F. Cheong-Siat-Moy	Z. Razzaq	G. Winter*
T. V. Galambos	D. A. Ross	R. Zandonini
J. S. B. Iffland		

Scope: To study the effect of end restraint on these isolated, hinged-end, initially crooked w-shape columns for which residual stress patterns are generally known.

TASK REPORTERS

Task Reporter 11 - Stability of Aluminum Structural Members

J. W. Clark, Aluminum Company of America

Task Reporter 13 - Local Inelastic Buckling

L. W. Lu, Lehigh University

Task Reporter 14 - Fire Effects on Structural Stability

Task Reporter 15 - Curved Compression Members

W. J. Austin, Rice University

Task Reporter 16 - Stiffened Plate Structures

A. Monsour, Monsour Engineering

Task Reporter 17 - Laterally Unsupported Restrained Beam-Columns

L. W. Lu, Lehigh University

S P O N S O R I N G O R G A N I Z A T I O N S

	<u>Representatives</u>	<u>Officers</u>
American Institute of Steel Construction	T. R. Higgins J. L. Durkee	W. A. Milek, Jr. Vice President of Engineering
American Iron and Steel Institute	A. L. Johnson	R. T. Willson Sr. Vice President
Canadian Institute of Steel Construction	M. I. Gilmor D. Stringer	H. A. Krentz President
Metal Building Manufacturers Association	D. L. Johnson F. A. Petersen D. S. Ellifritt	F. A. Petersen General Manager

P A R T I C I P A T I N G O R G A N I Z A T I O N S

Aluminum Association	G. S. Gresham M. L. Sharp W. W. Pritsky	P. V. Mara Vice Pres. - Technical
American Institute of Architects	P. E. Kirven T. F. Mariani J. S. Hawkins, Jr.	J. R. Dowling Director. Codes & Regs Center
American Petroleum Institute	J. E. Ubben J. W. Cox A. L. Guy	R. K. Kinra
American Society of Civil Engineers	B. G. Johnston J. S. B. Iffland J. A. Yura	E. Zwoyer Executive Director
American Society of Mechanical Engineers	M. D. Bernstein	R. B. Finch Executive Dir. & Secy.
Association of American Railroads	L. S. Beddle	E. W. Hodgkins Executive Secretary
Canadian Society for Civil Engineers	M. C. Temple	C. G. Southmayd Asst. Genl. Mgr. - Admin.
Corps of Engineers, U. S. Army	G. M. Matsumura	LTG J. W. Morris Chief
Earthquake Engineering Research Institute	H. J. Degenkolb R. D. Hanson T. R. Higgins	J. A. Blume President

Engineering Foundation		J. A. Zecca Secy & General Mgr.
European Convention for Constructional Steelwork		A. Carpena Tech. Secy. General E. B. Evers Admin. Secy. General
Federal Highway Administration	R. F. Varney F. D. Sears J. M. Kruegler	K. S. Bowers Administrator
General Services Administration	A. Dailey W. D. Rust, Jr.	R. G. Freeman Administrator
Institute of Engineers Australia	C. Massey C. O'Connor D. Brooks	J. R. Gibson Committee Secretary
International Conference of Building Officials	D. R. Watson	D. R. Watson Technical Director
Langley Research Center, NASA	M. Stein M. M. Mikulas, Jr.	E. M. Cortwright Director
National Bureau of Standards	H. S. Lew	R. N. Wright
Naval Facilities Engineering Command, U. S. Navy	M. Yachnis	RADM D. G. Iselin Commander
Naval Ship Research and Development Center	M. O. Critchfield R. F. Jones	CAPT M. V. Ricketts Commander
Steel Joist Institute	J. D. Johnson	J. D. Johnson Technical Director
Structural Engineers Association of California	J. O. Robb W. L. Casper J. Gamayo	A. S. Virdee President
Welding Research Council	J. H. Adams G. C. Lee W. A. Milek, Jr.	K. H. Koopman Director

S P O N S O R I N G O R G A N I Z A T I O N S

	<u>Representatives</u>	<u>Officers</u>
American Institute of Steel Construction	T. R. Higgins J. L. Durkee	W. A. Milek, Jr. Vice President of Engineering
American Iron and Steel Institute	A. L. Johnson	R. T. Willson Sr. Vice President
Canadian Institute of Steel Construction	M. I. Gilmor D. Stringer	H. A. Krentz President
Metal Building Manufacturers Association	D. L. Johnson F. A. Petersen D. S. Ellifritt	F. A. Petersen General Manager

P A R T I C I P A T I N G O R G A N I Z A T I O N S

Aluminum Association	G. S. Gresham M. L. Sharp W. W. Pritsky	P. V. Mara Vice Pres. - Technical
American Institute of Architects	P. E. Kirven T. F. Mariani J. S. Hawkins, Jr.	J. R. Dowling Director. Codes & Regs Center
American Petroleum Institute	J. E. Ubben J. W. Cox A. L. Guy	R. K. Kinra
American Society of Civil Engineers	B. G. Johnston J. S. B. Iffland J. A. Yura	E. Zwoyer Executive Director
American Society of Mechanical Engineers	M. D. Bernstein	R. B. Finch Executive Dir. & Secy.
Association of American Railroads	L. S. Beddle	E. W. Hodgkins Executive Secretary
Canadian Society for Civil Engineers	M. C. Temple	C. G. Southmayd Asst. Genl. Mgr. - Admin.
Corps of Engineers, U. S. Army	G. M. Matsumura	LTG J. W. Morris Chief
Earthquake Engineering Research Institute	H. J. Degenkolb R. D. Hanson T. R. Higgins	J. A. Blume President

Engineering Foundation		J. A. Zecca Secy & General Mgr.
European Convention for Constructional Steelwork		A. Carpena Tech. Secy. General E. B. Evers Admin. Secy. General
Federal Highway Administration	R. F. Varney F. D. Sears J. M. Kruegler	K. S. Bowers Administrator
General Services Administration	A. Dailey W. D. Rust, Jr.	R. G. Freeman Administrator
Institute of Engineers Australia	C. Massey C. O'Connor D. Brooks	J. R. Gibson Committee Secretary
International Conference of Building Officials	D. R. Watson	D. R. Watson Technical Director
Langley Research Center, NASA	M. Stein M. M. Mikulas, Jr.	E. M. Cortwright Director
National Bureau of Standards	H. S. Lew	R. N. Wright
Naval Facilities Engineering Command, U. S. Navy	M. Yachnis	RADM D. G. Iselin Commander
Naval Ship Research and Development Center	M. O. Critchfield R. F. Jones	CAPT M. V. Ricketts Commander
Steel Joist Institute	J. D. Johnson	J. D. Johnson Technical Director
Structural Engineers Association of California	J. O. Robb W. L. Casper J. Gamayo	A. S. Virdee President
Welding Research Council	J. H. Adams G. C. Lee W. A. Milek, Jr.	K. H. Koopman Director

C O R R E S P O N D I N G M E M B E R S

G. Augusti	Italy
V. A. Baldin	U S S R
F. S. Braga	Brazil
M. Crainicescu	Romania
H. de Clercq	South Africa
J. B. Dwight	England
Y. Fujita	Japan
G. B. Godfrey	England
M. S. Gregory	Australia
P. Grundy	Australia
O. Halasz	Hungary
T. Kanchanalai	Thailand
A. N. Kounadis	Greece
R. W. Kowalczyk	Poland
M. A. Leclair	Nicaragua
C. Massonnet	Belgium
C. Nassar	Egypt
H. Nylander	Sweden
A. Selberg	Norway
D. Sfintesco	France
F. S. Shaw	Australia
R. Solis	Guatemala
K. Thomsen	Denmark
B. Thurlimann	Switzerland
N. S. Trahair	Australia
U. Vogel	West Germany

L I F E M E M B E R S

	<u>Year Elected</u>
A. Amirikian	1978
W. J. Austin	1976
L. S. Beedle	1976
E. L. Erickson	1976
E. H. Gaylord	1976
J. A. Gilligan	1976
J. E. Goldberg	1976
T. R. Higgins	1976
N. J. Hoff	1976
S. C. Hollister	1976
M. Holt	1979
L. K. Irwin	1976
B. G. Johnston	1976
R. L. Ketter	1976
N. M. Newmark	1976
B. Thurlimann	1976
G. Winter	1976

S S R C A D D R E S S E S

- * ABRAHAMS, M. J., Parsons, Brinckerhoff, Quade & Douglas, One Penn Plaza,
New York, New York 10001
- * ADAMS, J. H., Pittsburgh Des Moines Steel Company, Neville Island,
Pittsburgh, Pennsylvania 15225
- * ADAMS, Dr. P. F., Dean, Faculty of Engineering, The University of Alberta,
Edmonton, Alberta T6G 2G8 Canada
- AL-ABDULLA, Prof. J. K., address unknown
- ALMROTH, Dr. B. O., Lockheed Research Laboratory, 3251 Hanover Street,
Palo Alto, California 94304
- ALPSTEN, Dr. G. A., Stalbyggnadskontroll AB, Tralgatan 16, S-133 00
Saltsjobaden, Sweden
- * ALVAREZ, Prof. R. J., Engineering & Computer Sciences, Hofstra University,
Hempstead, New York 11550
- AMAZIGO, Prof. J., address unknown
- * AMIRIKIAN, Dr. A., Amirikian Engineering Co., 35 Wisconsin Circle,
Chevy Chase, Maryland 20015
- ARNDT, A., Vice-President - Engineering, American Bridge Division, Room 1539,
600 Grant Street, Pittsburgh, Pennsylvania 15230
- * AUGUSTI, Prof. G., Facolta di Ingegneria, Via Di S Maria, 3, I 50139
Florence, Italy
- * AUSTIN, Prof. W. J., Department of Civil Engineering, P.O. Box 1892,
Rice University, Houston, Texas 77001
- BABCOCK, Prof. C., College of Engineering, California Institute of
Technology, Pasadena, California 91125
- BAKER, Prof. J. F., 100 Long Road, Cambridge, England
- * BALDIN, Prof. V. A., Metal Construction Department, Gosstroy USSR, CN11SK,
12 Marx Avenue, Moscow K-9 U S S R

* SSRC Member

BARTON, Dr. C. S., Dean, College of Engineering Sciences & Technology,
270 Clyde Building, Brigham Young University, Provo, Utah 84602

BASEHEART, T. M., College of Engineering (ML 71), University of Cincinnati,
Cincinnati, Ohio 45221

BASLER, Dr. K., Basler & Hofman, Forchstrasse 395, 8029 Zurich, Switzerland

BASS, Dr. L. O., School of Architecture, Oklahoma State University,
Stillwater, Oklahoma 74074

* BEEDLE, Dr. L. S., Fritz Engineering Laboratory #13, Lehigh University,
Bethlehem, Pennsylvania 18015

BEHLING, R., State Highway Department, Salt Lake City, Utah 88411

* BEIL, R. E., Sverdrup & Parcell & Associates, Inc., 800 North 12th Boulevard,
St. Louis, Missouri 63101

* BERNSTEIN, M. D., Foster Wheeler Energy Corporation, 110 South Orange Avenue,
Livingston, New Jersey 07039

* BIRKEMOE, Prof. P. C., Department of Civil Engineering, Galbraith Building,
University of Toronto, Toronto, Ontario M5S 1A4 Canada

* BIRNSTIEL, Dr. C., Consulting Engineer, 230 Park Avenue, New York,
New York 10017

* BJORHOVDE, Prof. R., Department of Civil Engineering, The University of
Alberta, Edmonton, Alberta T6G 2G7 Canada

BLUME, J. A., President, Earthquake Engineering Research Institute,
2620 Telegraph Avenue, Berkeley, California 94704

BODHE, J. G., Kriraniand Company - Cama Building, 24-26 Dacal Street, Fort,
Bombay 400001 India

BOWERS, K. S., Federal Highway Administrator, U. S. Department of Trans-
portation, Washington, D. C. 20590

* BRAGA, F. S., Nacional de Estradas de Rodegem, Rio De Janeiro, D. F., Brazil

BRANNON, H. R., ESSO Production Research Company, P. O. Box 2189, Houston,
Texas 77001

* BROOKS, Dr. D., Department of Civil Engineering, University of Adelaide,
Adelaide, S. A., Australia 5001

- BRUEGGING, J., Butler Manufacturing Company Research Center, 135th & Botts Road, Grandview, Missouri 64030
- * BRUSH, Prof. D. O., Department of Civil Engineering, University of California-Davis, Davis, California 94616
- * BUCHERT, Dr. K. P., Bechtel Power Corporation, TPO, (50) 11A1, P. O. Box 3965, San Francisco, California 94119
- BUTLER, Prof. D. J., Department of Civil Engineering, Rutgers University, New Brunswick, New Jersey 08903
- CANTY, D., Editor, AIA Journal, The American Institute of Architects, 1735 New York Avenue, N. W., Washington, D. C., 20006
- CAPANOGLU, C., Earl and Wright, One Market Plaza, Spear Street Tower, San Francisco, California 94105
- CARPENA, Dr. A., Avenue Louise 326, BTE 52, 1050 Brussels, Belgium
- * CASPER, W. L., 3664 Grand Avenue, Oakland, California 94610
- * CHAJES, Prof. A., Department of Civil Engineering, University of Massachusetts Amherst, Massachusetts 01002
- CHEN, Dr. A. C. T., Exxon Production Research Company, P. O. Box 2189, Houston, Texas 77001
- CHEN, Dr. S. S., Components Technology Division, Argonne National Laboratory, 9700 S. Cass Avenue, Argonne, Illinois 60439
- * CHEN, Prof. W. F., School of Civil Engineering, Purdue University, West Lafayette, Indiana 47907
- * CHENG, Dr. F. Y., Department of Civil Engineering, University of Missouri, Rolla, Missouri 65401
- * CHEONG-SIAT-MOY, Dr. F., Department of Civil & Mineral Engineering, University of Minnesota, 112 Mines & Metallurgy, Minneapolis, Minnesota 55455
- CHIN, S. L., Yankee Atomic Electric Company, 20 Turnpike Road, Westborough, Massachusetts 01581
- CHONG, Dr. K. P., Department of Civil & Architectural Engineering, The University of Wyoming, P. O. Box 3295 University Station, Laramie, Wyoming 82071
- * CLARK, Dr. J. W., 217 Glenview Drive, New Kensington, Pennsylvania 15068
- COLE, A. P., New York State Department of Transportation, 1220 Washington Avenue, State Campus, Albany, New York 12232

- CONNOR, S., Director, Public Information, Alumni Building #27, Lehigh University, Bethlehem, Pennsylvania 18015
- * COOPER, Prof. P. B., Department of Civil Engineering, Seaton Hall, Kansas State University, Manhattan, Kansas 66506
- CORNELL, Prof. C. A., Department of Civil Engineering, Room 1-263, Massachusetts Institute of Technology, Cambridge, Massachusetts 02139
- CORTWRIGHT, E. M., Director, Langley Research Center, N A S A, Hampton, Virginia 23365
- * COX, Dr. J. W., McDermott Hudson Engineering, P. O. Box 36100, Houston, Texas 77036
- * CRIANICESCU, Ms. M., Institut de Cercetari in Constructii si Economia Constructiilor, Sos. Pantelimon 266, Bucuresti, Romania
- * CRITCHFIELD, Dr. M. O., David W. Taylor Naval Ship Research & Development Center, Code 1730.5, Bethesda, Maryland 20084
- CULVER, Dr. C. G., Office of Federal Building, Technical Building 226 Room B244 National Bureau of Standards, Washington, D. C. 20234
- * DAILEY, A. Public Building Service, Room 3042, General Services Administration, Washington, D. C. 20405
- DAVIS, C. S., 19460 Burlington Drive, Detroit, Michigan 48203
- * de CLERCQ, Dr. H., Director, South African Institute of Steel Construction, P. O. Box 1338, Johannesburg, 2000 South Africa
- * DEGENKOLB, H. J., H. J. Degenkolb & Associates, 350 Sanaome Street, San Francisco, California 94104
- DeHART, R. C., Southwest Research Institute, 8500 Culebra Road, P. O. Drawer 28510, San Antonio, Texas 78284
- * DIAO, K., Vice President, URS/ Madigan-Praeger, Inc., 150 East 42nd Street, New York, New York 10017
- DOWLING, J. R., Director, Codes & Regs Center, The American Institute of Architects, 1735 New York Avenue, N. W., Washington, D. C. 20006
- * DOWLING, Prof. P. J., Department of Civil Engineering, Imperial College of Science & Technology, London SW7 2AZ England
- * DRISCOLL, Prof. G. C., Fritz Engineering Laboratory # 13, Lehigh University, Bethlehem, Pennsylvania 18015
- * DRUGGE, H. E., Hardesty and Hanover, 101 Park Avenue, New York, New York 10017

du BOUCHET, Prof. A. V., 9 Meadowlark Lane, East Brunswick, New Jersey
08816

* DURKEE, J. L., Consulting Structural Engineer, 217 Pine Top Trail, Bethlehem,
Pennsylvania 18017

DUTCHAK, E. M., The Constuction Specs Institute, 1150 17th Street, N. W.,
Suite 300, Washington, D. C. 20036

* DWIGHT, J. B., Reader in Structural Engineering, Engineering Department,
Cambridge University, Cambridge CB2 1PZ England

EDWARDS, Dr. N. W., Nutech Inc., 145 Martinvalle Lane, San Jose,
California 95119

* EDWARDS, W. E., Sales Engineering Division, Bethlehem Steel Corporation,
Bethlehem, Pennsylvania 18016

* ELGAALY, Dr. M., Bechtel Associates Professional Corporation, 2342
Delaware, Ann Arbor, Michigan 48103

* ELLIFRITT, Dr. D. S., Director of Engineering & Research, Metal Building
Manufacturers Association, 1230 Keith Building, Cleveland,
Ohio 44115

* ELLIOTT, A. L., 3010 Tenth Avenue, Sacramento, California 95817

* ELLIS, Dr. J. S., Head, Department of Civil Engineering, Royal Military
College of Canada, Kingston, Ontario K7L 2W3 Canada

* ERICKSON, E. L., 501 Dumbarton Drive, Shreveport, Louisiana 71106

* ERRERA, Dr. S. J., Engineering Department, Bethlehem Steel Corporation,
Bethlehem, Pennsylvania 18016

EVERS, E. B., ECCS Administrative Secretary General, Weena 700, 3003
Rotterdam, The Netherlands

FAIRWEATHER, V., Editor, ASCE News, 345 East 47th Street, New York,
New York 10017

FANG, P. J., Department of Civil & Environmental Engineering, University
of Rhode Island, Kingston, Rhode Island 02881

FEDERINIC, Mrs. L. G., SSRC Administrative Secretary, Fritz Engineering
Laboratory - 13, Lehigh University, Bethlehem, Pennsylvania 18015

FELDT, Prof. W. T., Division of Engineering Science, University of
Wisconsin-Parkside, Kenosha, Wisconsin 53140

FELMLEY, Jr., C. R., Technical Secretary, Welding Research Council,
345 East 47th Street, New York, New York 10017

- du BOUCHET, Prof. A. V., 9 Meadowlark Lane, East Brunswick, New Jersey
08816
- * DURKEE, J. L., Consulting Structural Engineer, 217 Pine Top Trail, Bethlehem,
Pennsylvania 18017
- DUTCHAK, E. M., The Constuction Specs Institute, 1150 17th Street, N. W.,
Suite 300, Washington, D. C. 20036
- * DWIGHT, J. B., Reader in Structural Engineering, Engineering Department,
Cambridge University, Cambridge CB2 1PZ England
- EDWARDS, Dr. N. W., Nutech Inc., 145 Martinvalle Lane, San Jose,
California 95119
- * EDWARDS, W. E., Sales Engineering Division, Bethlehem Steel Corporation,
Bethlehem, Pennsylvania 18016
- * ELGAALY, Dr. M., Bechtel Associates Professional Corporation, 2342
Delaware, Ann Arbor, Michigan 48103
- * ELLIFRITT, Dr. D. S., Director of Engineering & Research, Metal Building
Manufacturers Association, 1230 Keith Building, Cleveland,
Ohio 44115
- * ELLIOTT, A. L., 3010 Tenth Avenue, Sacremento, California 95817
- * ELLIS, Dr. J. S., Head, Department of Civil Engineering, Royal Military
College of Canada, Kingston, Ontario K7L 2W3 Canada
- * ERICKSON, E. L., 501 Dumbarton Drive, Shreveport, Louisiana 71106
- * ERRERA, Dr. S. J., Engineering Department, Bethlehem Steel Corporation,
Bethlehem, Pennsylvania 18016
- EVERS, E. B., ECCS Administrative Secretary General, Weena 700, 3003
Rotterdam, The Netherlands
- FAIRWEATHER, V., Editor, ASCE News, 345 East 47th Street, New York,
New York 10017
- FANG, P. J., Department of Civil & Environmental Engineering, University
of Rhode Island, Kingston, Rhode Island 02881
- FEDERINIC, Mrs. L. G., SSRC Administrative Secretary, Fritz Engineering
Laboratory - 13, Lehigh University, Bethlehem, Pennsylvania 18015
- FELDT, Prof. W. T., Division of Engineering Science, University of
Wisconsin-Parkside, Kenosha, Wisconsin 53140
- FELMLEY, Jr., C. R., Technical Secretary, Welding Research Council,
345 East 47th Street, New York, New York 10017
-

- FINCH, R. B., Executive Director & Secretary, American Society of Mechanical Engineers, 345 East 47th Street, New York, New York 10017
- * FINZI, Prof. L., Viale Guistiniano 10, 20129 Milano, Italy
- FISHER, Dr. G. P., 309 Hollister Hall, School of Civil & Environmental Engineering, Cornell University, Ithaca, New York 14853
- FISHMAN, B., Director, Research, The American Society of Mechanical Engineers, 345 East 47th Street, New York, New York 10017
- FOUNTAIN, R. S., Highway Construction Marketing, United States Steel Corporation, Pittsburgh, Pennsylvania 15222
- FOWLER, Prof. W. D., Department of Architectural Engineering, University of Texas at Austin, Austin, Texas 78712
- FOX, A. J., Publisher, Engineering News Record, 330 West 42nd Street, New York, New York 10036
- * FOX, G. F., Howard, Needles, Tammen & Bergendoff, 1345 Avenue of the Americas, New York, New York 10019
- FREEMAN, Dr. B. G., 5803 Russell Road, Durham, North Carolina 27712
- FREEMAN, R. G., Administrator, General Services Administration, Washington, D. C. 20405
- * FUJITA, Prof. Y., Chairman, Column Research Committee of Japan, Department of Naval Architecture, University of Tokyo, Bunkyo-Ku, Tokyo, 113 Japan
- FUKUMOTO, Dr. Y., Department of Civil Engineering, Nagoya University, Chikisa-Ku, Nagoya, Japan
- * FURLONG, Dr. R. W., Civil Engineering Department, University of Texas at Austin, Austin, Texas 78712
- * GALAMBOS, Prof. T. V., Washington University, Box 1130, St. Louis, Missouri 63130
- GALIONE, K. A., Managing Director, Society for Experimental Stress Analysis, P. O. Box 277, Saugatuck Station, Westport, Connecticut 06880
- * GALLAGHER, Dr. R. H., Department of Civil Engineering, University of Arizona, Tucson, Arizona 85724
- * GAMAYO, J., 2726 Sumac Avenue, Stockton, California 95207
- * GAUS, Dr. M. P., Program Manager, Design Research Division of Problem Focused Research Application, Directorate ASRA, National Science Foundation, Washington, D. C. 20550

- GAYLORD, Prof. C. N., Department of Civil Engineering, Thornton Hall,
University of Virginia, Charlottesville, Virginia 22901
- * GAYLORD, Prof. E. H., 2129 Civil Engineering Building, University of
Illinois, Urbana, Illinois 61801
- GEORGE, Jr., E. D., Jordan, Apostol Ritter Associates, Inc., Administration
Building 7, Davisville, R. I. 02854
- GHOSH, S. D. K., Institution of Engineers, 8 Gokhale Road, Calcutta 20,
India
- GIBSON, J. R., Committee Secretary, The Institution of Engineers, Australia,
11 National Circuit, Barton, A. C. T. Australia 2600
- GILES, W. W., Executive Secretary, Structural Engineers Associations of
Northern California, 171 Second Street, San Francisco,
California 94105
- * GILLIGAN, J. A., U. S. Steel Corporation, 600 Grant Street, Room 1780,
Pittsburgh, Pennsylvania 15230
- * GILMOR, M. I., Canadian Institute of Steel Construction, 201 Consumers
Road, Suite 300, Willowdale, Ontario M2J 4G8 Canada
- GJELSBIK, Prof. A., Department of Civil Engineering, S. W. Mudd
Building, Columbia University, New York, New York 10027
- GLASFELD, Dr. R., General Dynamics Corporation, 97 Howard Street,
Quincy, Massachusetts 02169
- * GODFREY, G. B., CONSTRATO, 12 Addiscombe Road, Croydon CR9 3UH England
- GODFREY, Jr., K. A., Editor, Civil Engineering, A.S.C.E, 345 E. 47th
Street, New York, New York 10017
- * GOEL, Prof. S. C., Department of Civil Engineering, The University of
Michigan, Ann Arbor, Michigan 48104
- GOLAY, A., IABSE Bulletin, AIPC-IVBH-IABSE, ETH- Honggerberg, CH-8093
Zurich, Switzerland
- * GOLDBERG, Dr. J. E., Department of Civil Engineering, Texas A & M
University, College Station, Texas 77843
- * GRAHAM, R. R., U. S. Steel Corporation, 600 Grant Street Room 1716,
Pittsburgh, Pennsylvania 15230
- GREENFIELD, W. D., Amoco Minerals Company, Mail Code 5406, 200 East
Randolph Drive, Chicago, Illinois 60601
- * GREGORY, Dr. M. S., Civil Engineering Department, University of Tasmania,
Box 252C G.P.O., Hobart, Tasmania, Australia 7001

- * GRESHAM, G. S., Reynolds Metals Company, 5th & Cary Streets, Richmond,
Virginia 23261
- * GRUNDY, Prof. P., Department of Civil Engineering, Monash University,
Clayton, Victoria 3168 Australia
- * GUNZELMAN, S. X., Design Engineer, Brown & Root, Inc., P. O. Box 3,
Houston, Texas 77001
- * GUY, A. L., Exxon Company, U.S.A., Houston Research Center, N-301
P. O. Box 2189, Houston, Texas 77001
- * HAAIJER, Dr. G., 110 Moonlight Drive, Monroeville, Pennsylvania 15146
- HAENEL, R. L., URS/The Ken R. White Company, P. O. Drawer 6281, Denver,
Colorado 80206
- * HALASZ, Dr. O., Department of Steel Structures, Technical University of
Budapest, XI Muegyetem rkp 3, H-1521 Budapest, Hungary
- * HALL, D. H., Engineering Department, Bethlehem Steel Corporation,
Bethlehem, Pennsylvania 18016
- * HANSON, Prof. R. D., Department of Civil Engineering, University of Michigan,
Ann Arbor, Michigan 48019
- HARDESTY, E. R., Hardesty & Hanover, 101 Park Avenue, New York, New York 10017
- HARPER, C. D., Journal of Institution of Engineers, 11 National Circuit,
Barton, A. C. T. Australia 2600
- HARRIS, Dr. H. G., Department of Civil Engineering, Drexel University,
Philadelphia, Pennsylvania 19104
- * HARTMAN, Dr. A. J., 1161 Colgate Drive, Monroeville, Pennsylvania 15146
- * HAWKINS, J. S., Hawkins Lindsey Wilson Associates, 111 East Camelback Road,
Phoenix, Arizona 85021
- HAYASHI, Prof. T., Department of Mathematics, Chuo University, I-13-27
Kasuga, Bunkyo-Ku, Tokyo 112 Japan
- HEALEY, Dr. J. J., Ebasco Services Incorporated, Two World Trade Center, 91st
Floor, New York, New York 10048
- HECHTMAN, Dr. R. A., Environmental & Urban Systems, Virginia Polytechnic
Institute and State University, Blacksburg, Virginia 24061
- * HEDGREN, Jr., A. W., Richardson, Gordon and Associates, 3 Gateway Center,
Pittsburgh, Pennsylvania 15222
- HEILMAN, K. L., 1118 State Street, P. O. Box 2926, Harrisburg, Pennsylvania
17105

- * HERRMANN, Prof. G., Division of Applied Mechanics - Durand Building,
Stanford University, Stanford, California 94305
- * HIGGINS, Dr. T. R., 12 Beach Drive, Noroton, Connecticut 06820
- HODGKINS, E. W., Executive Secretary, Association of American Railroads,
59 East Van Buren Street, Chicago, Illinois 60605
- * HOFF, Dr. N. J., 782 Esplanada Way, Stanford, California 94305
- * HOLLISTER, Dr. S. C., 201 Hollister Hall, Cornell University, Ithaca,
New York 14853
- * HOLT, M., 536 Charles Avenue, New Kensington, Pennsylvania 15068
- HOLZER, Dr. S. M., Civil Engineering Department, Virginia Polytechnic
Institute & State University, Blacksburg, Virginia 24061
- * HOOLEY, Dr. R. F., Department of Civil Engineering, University of
British Columbia, Vancouver, British Columbia Canada
- * HOOPER, I. M., Seelye Stevenson Value & Knecht, 99 Park Avenue,
New York, New York 10016
- * HSIONG, W., MTA Incorporated, 6420 South Sixth Street, Frontage Road,
Springfield, Illinois 62703
- * HUANG, Prof. T., Department of Civil Engineering, University of Texas at
Arlington, P. O. Box 19308, Arlington, Texas 76019
- * IFFLAND, J. S. B., Iffland Kavanagh Waterbury, 1501 Broadway,
New York, New York 10036
- * INGVARSSON, Dr. L., Avd. DBF, Dobel, 781 84 Borlange, Sweden
- * IRWIN, L. K., P. O. Box 487, Camden, South Carolina 29020
- ISELIN, RADM D. G., Commander, Naval Facilities Engineering Command,
200 Stovall Street, Alexandria, Virginia 22332
- * IYENGAR, S. H., Skidmore, Owings & Merrill, 30 West Monroe Street,
Chicago, Illinois 60603
- JACOBS, G. V., Simpson, Stratta & Associates, 325 Fifth Street,
San Francisco, California 94107
- JANSEN, T. Paul, De Serio-Jansen Engineers, PC, 511 Root Building,
86 West Chippewa Street, Buffalo, New York 14202
- * JOHNS, Dr. T. G., BATTELLE, Houston Operations, 223 West Loop South,
Suite 321, Houston Texas 77027
- * JOHNSON, Dr. A. L., American Iron & Steel Institute, 1000 16th Street,
N. W., Washington, D. C. 20036
- JOHNSON, Prof. A., Nora Strand 26, 182 34 Danderyd, Sweden

- *JOHNSON, D. L., Butler Manufacturing Company, Research Center, 135th Street and Botts Road, Grandview, Missouri 64030
- * JOHNSON, J. D., Technical Director, Steel Joist Institute, 1703 Parham Road, Suite 204, Richmond, Virginia 23229
- *JOHNSON, Prof. B. G., 5025 East Calle Barril, Tucson, Arizona 85718
- * JONES, Dr. R. F., David W. Taylor Naval Ship, Research and Development Center, Bethesda, Maryland 20084
- KALNINS, Prof. A., Department of Mechanics & Mechanical Engineering, Lehigh University, Building # 19, Bethlehem, Pennsylvania 18015
- * KANCHANALAI, Dr. T., 113 Sukumvit SOI 39, Bangkok 11 Thailand
- KATO, Prof. B., Department of Architecture, University of Tokyo, 7-3-1, Hongo, Bunkyo-Ku, Tokyo 113 Japan
- KERR, B. T., General Manager, Engineering Institute of Canada, 2050 Mansfield Street, Montreal 110, Quebec, Canada
- * KETTER, Dr. R. L., President, State University of New York, Buffalo, New York 14214
- *KHAN, Dr. F. R., Skidmore, Owings & Merrill, 30 West Monroe Street, Chicago, Illinois 60603
- KILLAM, E. H., Custodis Construction Company, 3075 Canal Road, Terre Haute, Indiana 47802
- KINRA. R. K., Shell Oil Company, P. O. Box 2099, Houston, Texas 77002
- KIRKLAND, W. G., American Society of Civil Engineers, 1625 I Street, N. W., Room 607, Washington, D. C. 20006
- * KIRVEN, P. E., American Institute of Architects, 1441 Benedict Canyon Drive, Beverly Hills, California 90210
- KLIME, R. G., R. A. Stearn, Incorporated, P. O. Box 106, Sturgeon Bay, Wisconsin 54235
- KOO, Prof. B., Department of Civil Engineering, The University of Toledo, Toledo, Ohio 43606
- KOOPMAN, K. H., Director, Welding Research Council, 345 East 47th Street, New York, New York 10017
- * KOUNADIS, Prof. A. N., Civil Engineering Department, National Technical University, Athens, Greece
- * KOWALCZYK, Dr. R. M., UL. Korotynskiego 19A, m. 119, 02 123 Warsaw, Poland
- * KRAJCINOVIC, Dr. D., University of Illinois at Chicago Circle, Department of Materials Engineering, Box 4348, Chicago, Illinois 60680

- * KRUEGLER, J. M., Department of Transportation, Federal Highway Administration,
400 Seventh Street, S. W., Room 3113, HNG-34, Washington, D. C. 20590
- * KWOH, T., Tippetts-Abbett-McCarthy-Stratton, Engineers & Architects, 1101 15th
St., N. W., Suite 700, Washington, D.C. 20005
- LATHAM, E. R., California Department of Public Works, P. O. Box 1499,
Sacramento, California 95807
- * LECLAIR, Dean M. A., Facultad De Ciencias, Escuela De Ingenieria Civil,
Managua, Nicaragua C. A.
- * LEE, Prof. G. C., Dean, Faculty of Engineering & Applied Sciences, State
University of New York at Buffalo, New York 14214
- LEEDS, D. J., Editor, EERI Newsletter, 11972 Chalon Road, Los Angeles,
California 90049
- LEHMER, G. D., General Manager, Minasian Associates, 444 West Ocean
Boulevard, Long Beach, California 90802
- * LE MESSURIER, W. J., Le Messurier Associates/SCI, 1033 Massachusetts
Avenue, Cambridge, Massachusetts 02138
- * LEW, Dr. H. S., Building Research Division - IAT, National Bureau of
Standards, Washington, D. C. 20234
- LIBOVE, Prof. C., Department of Mechanical & Aerospace Engineering,
139 E. A. Link Hall, Syracuse University, Syracuse, New York 13210
- LIM, Dr. L. C., Le Messurier Associates/SCI, 1033 Massachuaetts Avenue,
Cambridge, Massachusetts 02138
- * LIN, Dr. F. J., 561 North Wilson, Number 1, Pasadena, California 91106
- LIND, Prof. N. C., Department of Civil Engineering, University of Waterloo,
Waterloo, Ontario N2L 3G1 Canada
- LLOYD, Dr. J. R., ESSE Exploration & Production U. K. Incorporated, Five
Hanover Square , London W1R OHQ England
- * LOOMIS, R. S., Loomis and Loomis, Inc., Box 505 Windsor, Connecticut 06095
- * LU, Prof. L. W., Fritz Engineering Laboratory #13, Lehigh University,
Bethlehem, Pennsylvania 18015
- * LUNDGREN, Prof. H. R., Civil Engineering Center, Arizona State University,
Tempe, Arizona 85281
- MacADAMS, J. N., Research & Technology, Armco Steel Corporation, Middletown,
Ohio 45042
- MacDONALD, J. A., Engineering News-Record, 1221 Avenue of the Americas,
New York, New York 10020

- MANGELSDORF, Prof. C. P., 949 Benedum Hall, University of Pittsburgh,
Pittsburgh, Pennsylvania
- MARA, P. V., Vice President - Technical, The Aluminum Association, Inc.,
818 Connecticut Avenue, N. W., Washington, D. C. 20006
- MAREK, Dr. P., Czechoslovakia Technical University, SF CVUT ZIKOVA 4,
Prague 6, Czechoslovakia
- * MARIANI, T. F., American Institute of Architects, Mariani & Associates,
1600 20th Street, N. W., Washington, D. C. 20009
- * MARSH, Dr. C., Concordia University, Center for Building Studies, 1455
de Maisonneuve Boulevard West, Montreal, Quebec H3G 1M8 Canada
- * MARSHALL, P. W., Shell Oil Company, P. O. Box 2099, Houston, Texas 77001
- MARTIN, J. A., Vice President, Structural Engineers Association of California,
1830 Wilshire Boulevard, Los Angeles, California 90057
- * MARTINOVICH, W. M., Earl and Wright, One Market Plaza, San Francisco,
California 94105
- * MASSEY, Prof. C., Department of Civil Engineering, The University of
Western Australia, Nedlands, W. A., Australia 6009
- * MASSONNET, Prof. C., Universite De Liege, Institute Du Genie Civil,
Quai Banning, 6-B 4000 Liege, Belgium
- MASUR, Prof. E. F., University of Illinois - Chicago Circle, Box 4348,
Chicago, Illinois 60680
- * MATSUMURA, G. M., Office of Chief Engineers, Department of Army,
Washington, D. C. 20314
- MATTOCK, Prof. A. H., University of Washington, Department of Civil
Engineering, Seattle, Washington 98105
- * MC NAMEE, Prof. B. M., Drexel University, 32nd & Chestnut Streets,
Philadelphia, Pennsylvania 19104
- MC FALLS, R. K., Bell Telephone Labs, Room 4, 204 North Road, Chester,
New Jersey 07930
- * MEITH, R. M., Chevron Oil Company, 1111 Tulane Avenue, New Orleans,
Louisiana 70112
- * MICHALOS, Prof. J., Polytechnic Institute of New York, 333 Jay Street,
Brooklyn, New York 11201
- * MIKULAS, Dr. M. M., Mail Stop 190, NASA Langley Research Center,
Hampton, Virginia 23665

- * MILEK, Jr. W. A., American Institute of Steel Construction, 400 North Michigan Avenue, Chicago, Illinois 60611
- * MILLER, C. D., Director - Structural Research, Chicago Bridge & Iron Company, Route 59, Plainfield, Illinois 60544
- * MILLER, Prof. C. J., Department of Civil Engineering, Case Western Reserve University, Cleveland, Ohio 44106
- * MORRELL, Prof. M. L., Department of Civil Engineering, Clemson University, Clemson, South Carolina 29631
- MORRIS, LTC J. W., Chief, Corps of Engineers, Department of the Army, Forrestal Building, Washington, D. C. 20314
- * MORRISEY, C. D., Morrisey & Johnson, 41 East 42nd Street, New York, New York 10017
- MUKUOPADHYAY, S., Institution of Engineers, 8 Gokhale Road, Calcutta 20, India
- * MURRAY, Prof. T. M., University of Oklahoma, School of Civil Engineering, 202 West Boyd Street, Norman, Oklahoma 73019
- MURRAY, W. W., Associate Technical Director for Structures, Naval Ship Research and Development Center, Bethesda, Maryland 20084
- NAPPER, L. A., Engineering Department, Bethlehem Steel Corporation, Bethlehem, Pennsylvania 18016
- * NASSAR, Dr. G. E., 26 Adly Street, Apartment 911, Cairo, Egypt
- NETHERCOT, Dr. D. A., Department of Civil & Structural Engineering, The University, Mappin Street, Sheffield S1 3JD United Kingdom
- * NEWMARK, Prof. N. M., Civil Engineering Department, University of Illinois, Urbana, Illinois 61801
- NEWSLETTER, Editor, National Research Council of Canada, Ottawa K1A 0S2 Canada
- * NYLANDER, Prof. H., The Royal Institute of Technology, Department of Bldg. Stat. and Structural Engineering, 100 44 Stockholm 70, Sweden
- * O'CONNOR, Prof. C., Department of Civil Engineering, University of Queensland, St. Lucia, Qld., Australia 4067
- * OJALVO, Prof. M., Department of Civil Engineering, 470 Hitchcock Hall, The Ohio State University, Columbus, Ohio 43210
- * OSTAPENKO, Prof. A., Fritz Engineering Laboratory #13, Department of Civil Engineering, Lehigh University, Bethlehem, Pennsylvania 18015

- * PALMER, F. J., American Institute of Steel Construction, 400 North Michigan Avenue, Chicago, Illinois 60611
- * PARMER, J. F., Executive Director, Structural Engineers Association of Illinois, 55 East Washington Street, Room 1401, Chicago, Illinois 60602
- * PAULET, E. G., 8484 16th Street, Apartment 807, Silver Spring, Maryland 20910
- * PEKOZ, Prof. T., School of Civil & Environmental Engineering, Cornell University, Ithaca, New York 14850
- * PETERSEN, F. A., Metal Building Manufacturing Association, 2130 Keith Building, Cleveland, Ohio 44115
- PFRANG, Dr. E. O., National Bureau of Standards, Structural Material & Line Safety Division - 368, Washington, D. C. 20234
- * PILLAI, Dr. S. U., Department of Civil Engineering, Royal Military college, Kingston Ontario K7L 2W3 Canada
- * PINKHAM, C. W., S. B. Barnes & Associates, 2236 Beverly Boulevard, Los Angeles, California 90057
- * PISETZNER, E., Weiskopf & Pickworth, 200 Park Avenue, New York, New York 10017
- PLAUT, Prof R. H., Department of Civil Engineering, Virginia Polytechnic Institute, Blacksburg, Virginia 24061
- * POPOV, Prof. E. P., University of California, 725 Davis Hall, Berkeley, California 94720
- * PRICKETT, J. E., Modjeski and Masters, P. O. Box 2345, Harrisburg, Pennsylvania 17105
- * PRITSKY, W. W., Technical Director of Engineering, The Aluminum Association, Incorporated, 818 Connecticut Avenue, N. W., Washington, D. C. 20006
- RAY, K., Editor, Building Research, National Research Council, 2101 Constitution Avenue, N. W., Washington, D. C. 20418
- * RAZZAQ, Dr. Z., Department of Engineering Mechanics & Materials, Southern Illinois University, Carbondale, Illinois 62901
- RICKETTS, Capt. M. V., Commander, David W. Taylor Naval Ship Research and Development Center, Bethesda, Maryland 20084
- * RINGO, Dr. B. C., Civil & Environmental Engineering Department, 639 Baldwin # 71, University of Cincinnati, Cincinnati, Ohio 45221
- * ROBB, J. O., 175 North Circle Drive, San Gabriel, California 91776

- * ROBERTSON, L. E., Skilling, Helle, Christiansen, Robertson, 230 Park Avenue, New York, New York 10017
- RODERICK, Prof. J. W., Department of Civil Engineering, The University of Sydney, Sydney N S W, Australia 2006
- ROLF, R. L., ALCOA Research Laboratory, P. O. Box 772, New Kensington, Pennsylvania 15068
- ROMANESKI, A. L., Executive Vice President, Sippican Consultants International, Incorporated, 1033 Massachusetts Avenue, Cambridge, Massachusetts 02138
- ROSS, Prof. D. R., Civil Engineering Department, University of Akron, Akron, Ohio 44325
- RUPLEY, G., Rupley, Bahler, Blake, 391 Washington Street, Buffalo, New York 14203
- * RUST, Jr., W. D., Professional Services Division, Office of Construction Management, Public Buildings Service, General Services Administration, Washington, D. C. 20405
- * SANDFORD, P. G., Carruthers & Wallace, Limited, 34 Greensboro Drive, Rexdale, Ontario M9W 1E1 Canada
- SCHEFFEY, C. F., Director, Office of Research, Federal Highway Administration, Washington, D. C. 20590
- SCHELLING, Dr. D. R., Department of Civil Engineering, University of Maryland, College Park, Maryland 20742
- SCHULTZ, S., Samuel Schultz, Incorporated, 377 South Robertson Boulevard, Beverly Hills, California 90211
- * SCHULTZ, Dr. G. W., Institute für Baustatik, Universität Innsbruck, Technikerstrasse 13, A60620 Innsbruck, Austria
- * SEARS, F. D., Chief, Review Branch, Bridge Division - HNG -32, Federal Highway Administration, 400 Seventh Street, S. W., Washington D. C. 20590
- SEIGEL, L. G., Applied Research Laboratory, MS-80, U. S. Steel Corporation, Monroeville, Pennsylvania 15146
- * SELBERG, Prof. A., The University of Trondheim, Technical Institute of Norway, Division of Steel Structures, 7034 Trondheim
- * SFINTESCO, Dr. D., 86 Avenue De Beaumont, 60260 Lamorlaye, France
- * SHARP, M. L., Alcoa Technical Center, Alcoa Center, Pennsylvania 15068
- * SHAW, Dr. F. S., 244 Edinburgh Road, Casrlecrag, 2068 New South Wales, Australia

- * SHERMAN, Prof. D. R., Department of Civil Engineering, P. O. Box 784,
University of Wisconsin- Milwaukee, Milwaukee, Wisconsin 53201
- SHINOZUKA, Prof. M., Department of Civil Engineering, Columbia University,
607 S. W. Mudd Building, New York, New York 10027
- SHORE, Prof. S., Department of Civil & Urban Engineering, University of
Pennsylvania, 113 Towne Building D3, Philadelphia,
Pennsylvania 19174
- SILANO, L. G., Parsons, Brinckerhoff, Quade, & Douglas, 250 West 34th Street,
New York, New York 10001
- * SIMITSES, Prof. G. J., School of Engineering Science & Mechanics, Georgia
Institute of Technology, 225 North Avenue, N. W. Atlanta,
Georgia 30332
- SIMONIS, J. C., Babcock & Wilcox, Power Generation Group, P. O. Box 1260,
Lynchburg, Virginia 24505
- SMITH, J. R., National Research Council, Building Research Advisory Board,
2101 Constitution Avenue, N. W., Washington, D. C. 20418
- * SOLIS, I. R., Facultad De Ingenieria, Zona 12, Guatemala City, Guatemala
- * SPENCER, Prof. H. H., Department of Civil & Environmental Engineering,
Rutgers University, P. O. Box 909, Piscataway, New Jersey 08854
- * SPRINGFIELD, J., Carruthers & Wallace, Limited, Consultants, 34 Greensboro
Drive, Rexdale, Ontario M9W 1E1 Canada
- * STEIN, Dr. M., SDD-Analytical Methods Section, N A S A Langley Research
Center, Hampton, Virginia 23665
- * STOCKWELL, F. W., American Institute of Steel Construction, 400 North
Michigan Avenue, Chicago, Illinois 60611
- STRATING, Dr. J., Protech International BV, General Engineers & Consultants,
Stationsplein 2, Schiedam, The Netherlands
- * STRINGER, D., Dominion Bridge Company, Ltd., P. O. Box 3246, Station C,
Ottawa, Ontario K1Y 4J5 Canada
- * SVED, G., Department of Civil Engineering, University of Adelaide,
G.P.O. Box 498, Adelaide, South Australia 5001
- * TALL, Dr. L., Dean, School of Technology, Florida International University,
Tamiami Campus, Miami, Florida 33199
- * TANG, Dr. M. C., DRC Consultants, 529 5th Avenue, New York, New York 10017
- * TEMPLE, Prof. M. C., Department of Civil Engineering, University of Windsor,
Windsor, Ontario N9B 3P4 Canada

- TENNYSON, R. C., University of Toronto, Institute for Aerospace Studies,
4925 Dufferin Street, Downsview, Ontario M3H 5T6 Canada
- * TESTA, Prof. R. B., Department of Civil Engineering & Engineering Mechanics,
Columbia University, Seeley W. Mudd Building, New York,
New York 10027
- THATCHER, W. M., 9435 Hutton Drive, Sun City, Arizona 85351
- * THOMAIDES, Dr. S. S., Room 1390, Martin Tower, Engineering Department,
Bethlehem Steel Corporation, Bethlehem, Pennsylvania 18016
- * THOMSEN, Dr. K., International Steel Consulting Ltd., Noerre Farimagsgade 3,
7364 Copenhagen, Denmark
- * THURLIMANN, Prof. B., Institute of Structural Engineering, ETH-Honggerberg,
CH-8093 Zurich, Switzerland
- * TRAHAIR, Prof. N. S., University of Sydney, Civil Engineering, Sydney,
N S W, Australia 2006
- TROMBLEY, K., Editor, Professional Engineer, 2029 K. Street, N. W.,
Washington, D. C. 20006
- TUNG, Prof. D., 461 Park Avenue, Rye, New York 10580
- TYSON, C. G., General Manager, Codes & Standards Activities, American
Iron & Steel Institute, 1000-16th Street, N. W., Washington,
D. C. 20036
- * UBBEN, J. E., Assistant Production Director, American Petroleum Institute,
300 Corrigan Tower, Dallas, Texas 75201
- * ULSTRUP, C. C., Associate Engineer, Steinman, Boynton, Gronquist & Birdsall,
150 Broadway, New York, New York 10038
- * VAN DER WOUDE, Dr. F., University of Tasmania, Civil Engineering Department,
Box 252 C GPO, Hobart, Tasmania 7001, Australia
- * VANN, Dr. W. P., Department of Civil Engineering, Box 4089, Texas Tech
University, Lubbock, Texas 79409
- * VARNEY, R. F., Deputy Chief, Structures & Applied Mechanics Division,
Office of Research - HRS 10, Federal Highway Administration,
Washington, D. C. 20590
- VIEST, Dr. I. M., Room 242 East Building, Bethlehem Steel Corporation,
Bethlehem, Pennsylvania 18016
- * VINNAKOTA, Dr. S., Visiting Associate Professor, Department of Civil
Engineering, The University of Wisconsin-Milwaukee, P. O. Box 784,
Milwaukee, Wisconsin 53201
- VIRDEE, A. S., President, Structural Engineers Association of California,
1717 Daphne Avenue, Sacramento, California 95825

- TENNYSON, R. C., University of Toronto, Institute for Aerospace Studies,
4925 Dufferin Street, Downsview, Ontario M3H 5T6 Canada
- * TESTA, Prof. R. B., Department of Civil Engineering & Engineering Mechanics,
Columbia University, Seeley W. Mudd Building, New York,
New York 10027
- THATCHER, W. M., 9435 Hutton Drive, Sun City, Arizona 85351
- * THOMAIDES, Dr. S. S., Room 1390, Martin Tower, Engineering Department,
Bethlehem Steel Corporation, Bethlehem, Pennsylvania 18016
- * THOMSEN, Dr. K., International Steel Consulting Ltd., Noerre Farimagsgade 3,
7364 Copenhagen, Denmark
- * THURLIMANN, Prof. B., Institute of Structural Engineering, ETH-Honggerberg,
CH-8093 Zurich, Switzerland
- * TRAHAIR, Prof. N. S., University of Sydney, Civil Engineering, Sydney,
N S W, Australia 2006
- TROMBLEY, K., Editor, Professional Engineer, 2029 K. Street, N. W.,
Washington, D. C. 20006
- TUNG, Prof. D., 461 Park Avenue, Rye, New York 10580
- TYSON, C. G., General Manager, Codes & Standards Activities, American
Iron & Steel Institute, 1000-16th Street, N. W., Washington,
D. C. 20036
- * UBBEN, J. E., Assistant Production Director, American Petroleum Institute,
300 Corrigan Tower, Dallas, Texas 75201
- * ULSTRUP, C. C., Associate Engineer, Steinman, Boynton, Gronquist & Birdsall,
150 Broadway, New York, New York 10038
- * VAN DER WOUDE, Dr. F., University of Tasmania, Civil Engineering Department,
Box 252 C GPO, Hobart, Tasmania 7001, Australia
- * VANN, Dr. W. P., Department of Civil Engineering, Box 4089, Texas Tech
University, Lubbock, Texas 79409
- * VARNEY, R. F., Deputy Chief, Structures & Applied Mechanics Division,
Office of Research - HRS 10, Federal Highway Administration,
Washington, D. C. 20590
- VIEST, Dr. I. M., Room 242 East Building, Bethlehem Steel Corporation,
Bethlehem, Pennsylvania 18016
- * VINNAKOTA, Dr. S., Visiting Associate Professor, Department of Civil
Engineering, The University of Wisconsin-Milwaukee, P. O. Box 784,
Milwaukee, Wisconsin 53201
- VIRDEE, A. S., President, Structural Engineers Association of California,
1717 Daphne Avenue, Sacramento, California 95825

- * VOGEL, Prof. U., Institut für Baustatik, Universität Karlsruhe,
75 Karlsruhe, Kaiserstrasse 12, Federal Republic of Germany
- WAKABAYASHI, Prof. M., Disaster Prevention Research Institute, Kyoto
University, Uji City, Kyoto Pref., Japan
- WALDNER, H. E., Modjeski and Masters, P. O. Box 2345, Harrisburg.,
Pennsylvania 17105
- * WANG, Dr. C.K., Department of Civil & Environmental Engineering, University
of Wisconsin, Madison, Wisconsin 53706
- * WANG, Prof. S. T., Department of Civil Engineering, 210 Anderson Hall,
University of Kentucky, Lexington, Kentucky 40506
- * WATSON, D. R., Technical Director, International Conference of Building
Officials, 5360 South Workman Mill Road, Whittier, California
90601
- WELDON, H. P., Sante Fe International Corporation, P. O. Box 1401,
Orange, California
- WILLSON, W. J., Senior Vice President, American Iron & Steel Institute,
1000 16th Street, N. W., Washington, D. C. 20036
- WILTSE, D., Structural Engineers Association of Southern California,
2208 Beverly Boulevard, Los Angeles, California 90057
- * WINGERTER, W. W., Public Affairs, Chevron U. S. A., Incorporated,
New Orleans, Louisiana 70112
- * WINTER, Prof. G., Cornell University, 321 Hollister Hall, Ithaca, New York
14850
- * WOLCHUK, R., Wolchuk & Mayrbaur, 432 Park Avenue, South, New York,
New York 10016
- * WRIGHT, Dr. E. W., 57 Sunnyside Avenue, Ottawa K1S 0P9 Canada
- * WYLIE, F. B., Hazelet & Erdal, 405 Commerce Building, 304 West Liberty
Street, Louisville, Kentucky 40202
- * YACHNIS, Dr. M., Naval Facilities Engineering Command, 200 Stovall Street,
Alexandria, Virginia 22332
- * YEN, Prof. B. T., Fritz Engineering Laboratory, # 13, Lehigh University,
Bethlehem, Pennsylvania 18015
- YOO, Prof. C. H., Department of Civil Engineering, Marquett University,
1515 West Wisconsin Avenue, Milwaukee, Wisconsin 53233
- * YOUNG, R. C., Morrisey & Johnson, 41 East 42nd Street, New York,
New York 10017

- YU, Dr. C. K., URS/Madigan-Praeger, Incorporated, 150 East 42nd Street,
New York, New York 10017
- * YU, Prof. W. W., Department of Civil Engineering, University of Missouri,
Rolla, Missouri 65401
- * YURA, Dr. A. J., Department of Civil Engineering, University of Texas,
Austin, Texas 78712
- ZANDONINI, Dr. R., Istituto Di Scienza E Technica Delle Costruzioni,
Politecnico Di Milano, P.za Leonardo Da Vinci 32, 20133
Milano Italy
- * ZAR, M., Manager, Structural Department, Sargent & Lundy, Engineers,
55 East Monroe Street, Chicago, Illinois 60603
- ZECCA, J. A., Secretary, United Engineering Trustees Incorporated,
345 East 47th Street, New York, New York 10017
- ZELLIN, M. A., Sverdrup & Parcell and Associates, Incorporated,
800 North 12th Boulevard, St. Louis, Missouri 63101
- ZWOYER, Dr. E., Executive Director, American Society of Civil Engineers,
345 East 47th Street, New York, New York 10017

By-Laws*

P U R P O S E S O F T H E C O U N C I L

The general purposes of the Structural Stability Research Council shall be:

1. To maintain a forum where problems relating to the design and behavior of columns and other compression elements in metal structures can be presented for evaluation and pertinent structural research problems proposed for investigation.
2. To digest critically the world's literature on structural behavior of compression elements and to study the properties of metals available for their construction, and make the results widely available to the engineering profession.
3. To organize, administer, and guide cooperative research projects in the field of compression elements, and to enlist financial support for such projects.
4. To promote publication and dissemination of original research information in the field of compression elements.
5. To study the application of the results of research to the design of compression elements; to develop comprehensive and consistent strength and performance criteria, and to encourage their consideration by specification-writing bodies.

*Revised: August 21, 1947; October 1, 1948; November 1, 1949; August 15, 1951; May 20, 1955; October 1, 1960; May 7, 1962; May 21, 1965; May 31, 1968; March 27, 1974, May 7, 1975 and November 15, 1976

M E M B E R S H I P O F T H E C O U N C I L

The membership of the Council shall consist of Members-at-Large, Corresponding Members, Representatives of Sponsoring Organizations, and Representatives of Participating Organizations.

An individual who has expressed interest in the work of the Council, and who has done or is doing work germane to its interest, may be elected Member-at-Large by the Council, following nomination by the Executive Committee.

Corresponding Members are appointed by the Executive Committee to maintain contact with organizations in other countries that are active in areas of interest to the Council.

A Representative is appointed by the Sponsoring Organization or by the Participating Organization subject to the approval of the Executive Committee, and continues to serve until replaced by the organization which he represents. A Sponsoring Organization may appoint up to five representatives, and a Participating Organization may appoint up to three representatives. Organizations concerned with investigation and design of metal compression members and structures may be invited by the Council to become Sponsoring Organizations or Participating Organizations.

Council Members of appropriate age and service may be elected Life Members by the Council, following nomination by the Executive Committee.

Every three years the Secretary of the Council shall contact each Member-at-Large and each Corresponding Member to determine whether he wishes to continue his membership.

Every three years the Secretary of the Council shall canvass the Sponsoring Organizations and the Participating Organizations to determine their Representatives for the next three-year period.

S U B S C R I P T I O N F E E S

The subscription fee for each Member-at-Large shall be \$25.00 for a three-year period, and shall be billed concurrently with the regular triennial membership review. Interim subscriptions shall be \$17.00 for a two-year period and \$8.50 for a one-year period.

Subscription fees for Corresponding Members and Representatives shall be on a voluntary basis.

There shall be no subscription fees for Life Members.

The subscription fee for each Sponsoring Organization shall be a minimum of \$1000 per year.

The subscription fee for each Participating Organization shall be a minimum of \$100 per year, except that any such organization whose By-Laws specifically prohibit payment of such a fee shall be exempted.

M E E T I N G S O F T H E C O U N C I L

The Council shall hold at least one regular annual meeting each fiscal year, and such additional meetings as may be deemed necessary by the Executive Committee. A quorum shall consist of at least twenty members.

F I S C A L Y E A R

The fiscal year shall begin on October 1.

D U T I E S O F T H E C O U N C I L

1. To establish policies and rules.
2. To solicit funds for the work of the Council, and to maintain a general supervision of said funds, including the appropriation of grants for specific purposes.
3. To maintain and operate a central office for the administration of the work of the Council, and for the maintenance of its records.
4. To prepare an annual budget.
5. To issue annual reports.
6. To organize and oversee the committees and task groups established to carry out the projects authorized by the Council.

O F F I C E R S O F T H E C O U N C I L

1. The elected officers of the Council shall be a Chairman and a Vice Chairman. The Chairman shall exercise general supervision over the business affairs of the Council, subjected to the direction of the Council, shall perform all duties incident to this office, and shall be Chairman of the Executive Committee. It shall be the duty of the Chairman to preside at meetings of the Council and of the Executive Committee. The Vice Chairman shall perform all the duties of the Chairman in his absence.

2. The terms of office of the Chairman and Vice Chairman shall begin on October 1st and shall continue for 3 years. They shall be eligible for immediate re-election for only one term of one year. In the event of a vacancy in the office of Chairman or Vice Chairman, a successor shall be appointed by the Executive Committee to serve for the remainder of the unexpired term.

3. There shall be a Director engaged by the Executive Committee subject to the approval of the Council, who shall be the chief executive paid officer of the Council. Additional paid officers may be appointed by the Council as may be necessary. If there is no paid Secretary, the Chairman may appoint a Secretary, who need not be a member of the Council.

4. The Director of the Council shall conduct the regular business of the Council subject to the general supervision of the Council and of the Chairman. The Director shall be expected to attend all meetings of the Council, Executive Committee, and main committees. The Director shall be ex-officio a member of the Council and the Executive Committee. The Director shall conduct the official correspondence of the Council, shall handle the financial affairs of the Council in accordance with an approved budget, and shall keep full records thereof. He shall carefully scrutinize all expenditures and exert every effort to secure economy in the business administration of the Council, and shall personally certify to the accuracy of all bills or vouchers on which money is to be paid. He shall engage such employees as may be authorized, shall be responsible for their work, and shall determine their salaries within budget limitations, subject to the approval of the Executive Committee. The salary of the Director and other paid officers shall be fixed by the Executive Committee. The Director shall draw up and execute all contracts authorized by the Council and its Executive Committee.

E L E C T I O N O F O F F I C E R S

1. Each year, the Executive Committee shall appoint 3 members of the Council to serve as the Nominating Committee. One of the three shall be named Chairman by the Chairman of the Council. Members of the Executive Committee or of the previous year's Nominating Committee shall not be eligible to serve on the Nominating Committee.

2. The Nominating Committee shall name a slate for Chairman and Vice Chairman of the Council, and members of the Executive Committee. The Committee shall submit its nomination for Chairman and Vice Chairman to the Executive Committee prior to the Annual Meeting. Nominations for members of the Executive Committee will be submitted to the membership at the regular Annual Meeting.

3. The election of Chairman and Vice Chairman of the Council shall be by letter ballot. The ballots shall be canvassed at the regular Annual Meeting of the Council. Should no candidate for an office receive a majority of the ballots cast for such office, the annual meeting shall elect the officer by ballot from the two candidates receiving the largest number of votes in the letter ballot.

E X E C U T I V E C O M M I T T E E

1. An Executive Committee of nine members shall be elected by the Council from its membership. The term of membership shall be for three years, and three of the members shall be elected each year at the time of the regular Annual Meeting of the Council. Nominations shall be made by the Nominating Committee as described in the section "Election of Officers". In addition, the Chairman, Vice Chairman, Director, and the most recent Past Chairman and Past Vice Chairman of the Council shall be ex-officio members of the Executive Committee. Members shall take office upon their election. They shall be eligible for immediate re-election.

Vacancies shall be filled by appointments by the Chairman from the membership of the Council, such appointees to serve for the remainder of the unexpired term.

2. The Executive Committee shall transact the business of the Council and shall have the following specific responsibilities and duties;

- (a) To direct financial and business management for the Council, including the preparation of a tentative annual budget.
- (b) To review and approve proposed research projects and contracts.
- (c) To appoint Nominating Committee.
- (d) To appoint chairmen of committees and task groups, and approve committee and task group members.
- (e) To review reports and manuscripts.
- (f) To advise Council on proposed research projects.
- (g) To prepare program for Council meeting.
- (h) To correlate and give general supervision to research projects.
- (i) To refer inquiries relating to design practice to the Committee on Recommended Practice for definition, evaluation, and suggestions for task group assignment.

3. From time to time, the Executive Committee may ask additional consultants particularly interested in definite projects to act with it in an advisory capacity.

4. The Chairman, with the approval of the Executive Committee, shall appoint a Finance Committee to solicit the support required to carry out its projects.

5. The meeting of the Executive Committee shall be at the call of the Chairman or at the request in writing of two members of the Executive Committee. A quorum shall consist of five members, two of whom may be the Chairman and Vice Chairman of the Council.

6. The Executive Committee shall transact the business of the Council subject to the following limitations:

The minutes of the Committee shall be transmitted promptly to all members of the Council. If no objection is made by any member of the Council within two weeks after the minutes have been mailed, then the acts of the Executive Committee shall be considered as approved by the Council. If disapproval of any Committee action is made by three or more Council members, then the question raised shall be submitted to the Council for vote at a meeting called for that purpose, or by letter ballot.

C O N T R A C T S

The Council may make contracts or agreements, within its budget. Contracts for research projects preferably should be for the fiscal year period. Contracts with the Director or other paid employees of the Council may, with the approval of the Executive Committee, be for periods exceeding one fiscal year. At the end of such one-year period, contracts may be renewed or extended by the Council for an additional period, preferably not exceeding the new fiscal year.

S T A N D I N G A N D S P E C I A L C O M M I T T E E S

1. The standing committees shall be a Committee on Finance and a Committee on the "Guide to Stability Design Criteria for Metal Structures". There shall be such special committees as may be approved by the Council.

2. Standing and special committees and their chairmen, shall be appointed by, and responsible to, the Executive Committee. They shall be named at a regular Annual Meeting of the Council, shall take office upon appointment, shall serve for three years, and shall be eligible for immediate reappointment. Vacancies shall be filled in the same manner as regular appointments except that such appointees will complete the term of office vacated.

3. The Committee on Finance shall solicit the support required to carry on the work of the Council. The Chairman and the Vice Chairman shall be appointed from among the membership of the Executive Committee.

4. The Committee on the "Guide to Stability Design Criteria for Metal Structures" shall direct the preparation and publication of the various editions of the "Guide".

R E S E A R C H C O M M I T T E E S A N D T A S K G R O U P S

1. The Executive Committee may authorize one or more research committees or task groups, each for a specific subject or field. Each committee or task group shall consist of a number of members as small as feasible for the work in hand. Members need not be members of the Council.

2. Research committee chairmen or task group chairmen shall be appointed by the Executive Committee, adequately in advance of the Annual Meeting of the Council.

3. All research committee or task group appointments shall expire at the time of the regular Annual Meeting of the Council. Prior to the Annual Meeting, each committee chairman or task group chairman for the ensuing year shall review the personnel of his committee or task group with the idea of providing the most effective organization, and shall make recommendations thereon to the Executive Committee. Committee or task group personnel shall be approved or modified by the Executive Committee, prior to the conclusion of the Annual Meeting of the Council.

4. The duties of a research committee or task group shall be:
 - (a) To review proposed research projects within its field, and to render opinions as to their suitability.
 - (b) To make recommendations as to needed research in its field.
 - (c) To give active guidance to research programs within its field, in which connection research committees or task groups are empowered to change details of programs within budget limitations.
 - (d) To make recommendations as to the time when a project within its field should be temporarily discontinued, or terminated.
 - (e) At the request of the Executive Committee to prepare summary reports covering results of research projects and/or existing knowledge on specific topics.
5. Each project handled by a research committee or task group shall be of definite scope and objective.
6. Each research committee or task group shall be responsible to the Executive Committee for organizing and carrying out its definite projects, which must be approved by the Executive Committee.
7. Each research committee or task group shall meet at least once in each fiscal year before the Annual Meeting of the Council, to review progress made, and to plan activities for the ensuing year.
8. Each research committee chairman or task group chairman shall make a report to the Executive Committee at the time of the Annual Meeting.

REVISION OF BY-LAWS

These By-Laws may be revised at any time upon a majority vote of the entire membership of the Council, by letter ballot or at a meeting of the Council.

Rules of Procedure*

I. OUTLINE OF ROUTE OF A RESEARCH PROJECT FOR CONSIDERATION BY THE STRUCTURAL STABILITY RESEARCH COUNCIL

Projects are to be considered under three classifications:

(1) Projects originating within the Structural Stability Research Council.

(2) Those originating outside the Structural Stability Research Council or resulting from work at some institution and pertaining to general program of study approved by the Structural Stability Research Council.

(3) Extensions of existing SSRC sponsored projects.

Projects under Class (1) are to be handled as follows:

1. Project proposed.
2. Referred to Executive Committee for study and report to Council with recommendation.
3. If considered favorably by Council, the Executive Committee will take necessary action to set up the project.
4. Project Committee, new or existing, sets up project ready for proposals and refers back to Executive Committee.
5. Executive Committee sends out project for proposals.
6. Project Committee selects and recommends successful proposal to Executive Committee for action.
7. If awarded, the Project Committee supervises the project.
8. Project Chairman is to obtain adequate interim reports on project from laboratory.
9. Project Chairman advises Executive Committee adequately in advance of Annual Meeting as to report material available for Council presentation.
10. Executive Committee formulates program for presentation of reports at Annual Meeting.
11. Project Committee submits reports on any completed phase of the work for the Executive Committee.
12. Executive Committee determines disposition of report subject to approval of the Council before publication.

* Revised: Sep 22, 1975 , May 16, 1977

Projects under Class (2) would be handled essentially the same except that steps 4, 5 and 6 would be omitted at the discretion of the Executive Committee. The procedure for items 7 - 12 would then be unchanged from that used for Class (1) projects.

With regard to Class (3) projects, an extension of an existing project which requires no additional funds or changes in supervisory personnel shall be approved by a majority of the Executive Committee, but need not be reported to the Council for its consideration or action. If an extension requires additional funds, such extensions may be approved by the Executive Committee subject to approval by a letter ballot from the Council.

II. OUTLINE OF A PATH OF A PROJECT THROUGH THE COUNCIL (FOR RECOMMENDED PRACTICE)

1. Task Group submits its findings to the Executive Committee.
2. Executive Committee acts and forwards to Recommended Practice Committee.
3. Recommended Practice Committee acts and forwards recommendations to Executive Committee.
4. Council votes on the matter.
5. Executive Committee transmits recommendations and findings to specification-writing bodies, and/or Publications Committee arranges for publication.

III. DISTRIBUTION AND PUBLICATION OF REPORTS

For the guidance of project directors and task group chairmen, the following policy is recommended with regard to the distribution of technical progress reports and with respect to the publication of reports. The scope of this procedure is intended to cover those reports that result from projects supported financially by the Structural Stability Research Council.

Distribution of Technical Progress Reports

Any duplicated report prepared by an investigator carrying out a research program may be distributed to the appropriate task group and to members of the Executive Committee with the understanding that the investigator may make further limited distribution with a view of obtaining technical advice. General distribution will only be made after approval by the task group.

Publication of Reports

Published reports fall into two categories and are to be processed as indicated:

A. Reports Constituted as Recommendations of the Council

1. The report shall be submitted to the Executive Committee which after approval will circulate copies to members of the Structural Stability Research Council.

2. Subject to approval of the Structural Stability Research Council, the Publications Committee takes steps to publish Council recommendations.

B. Technical Reports Resulting from Research Programs

1. Universities or other organizations carrying out programs of research for the Structural Stability Research Council should make their own arrangements for publication of results.

2. Assuming that the investigator wishes to arrange for such publication, approval must be obtained from the appropriate task group.

3. Reprints are currently used as means of distributing reports of projects sponsored by or of interest to the Council. Investigator should order sufficient reprints for distribution by the Council. It is assumed that ear-marked project funds will be adequate for this purpose.

4. When appropriate, reprints should be distributed under a distinctive cover.

5. A statement of sponsorship should be included in all reports.

IV. SSRC LIFE MEMBERS

Reason for Life Member Category - To facilitate continued participation in and contributions to SSRC activities on the part of Council members who:

1. Have given exceptionally long service to SSRC, or
2. Have given long service to SSRC and are on a reduced schedule of regular professional activity.

Guidelines for Nomination to Life Member Category

1. Candidate has given approximately 25 years of active service to SSRC, or approximately 15 years of active service and is not engaged full-time in regular employment; and
2. Has made significant contributions to the work of SSRC; and
3. Expects to continue active participation in the work of SSRC.

Nominating Procedure

1. SSRC Chairman will appoint Life Member Nominating Committee in the fall of each year, this committee to consist of two members of the Executive Committee (one of whom will be designated chairman) and the SSRC Secretary.
2. This committee will submit recommendations for Life Member nominees to the Executive Committee at its spring meeting.
3. Approved candidates will become Executive Committee nominees.

Election Procedure

The names of the Executive Committee nominees will be presented to the Council at its Annual Meeting, for election to Life Membership.

V. WORKING RELATIONSHIP BETWEEN EXECUTIVE COMMITTEE & TASK GROUPS

1. Executive Committee defines scope of task group assignment, selects task group chairman, and appoints Executive Committee contact member. SSRC Chairman sends letter of appointment to task group chairman and furnishes him with Statement of Scope, name of contact member, and procedural guidelines as appropriate.
2. Task group chairman can recommend changes to scope if he so desires.
3. Executive Committee recommends possible task group members, but task group chairman assembles his own list of prospects and determines their willingness to serve, and furnishes names to contact member.
4. Executive Committee approves task group members and SSRC Chairman notifies them of their appointment.
5. Task group should meet at least once a year to remain in good standing. SSRC Chairman shall make this point clear to task group chairman when he is appointed.
6. Suitably in advance of Annual Technical Session, SSRC Secretary shall send instructions to each task group chairman regarding expected participation of his task group.
7. Suitably in advance of each Executive Committee meeting, SSRC Secretary shall send Executive Committee agenda (and relevant EC meeting minutes as necessary) to each task group chairman, requesting him to send one-page report to his contact member covering the following matters (and others as appropriate):
 - a. Task group progress.
 - b. Status of research projects being supervised or advised by task group.

- c. Task group meeting minutes.
- d. Comments on relevant matters on EC agenda.
- e. Membership status and recommended changes.
- f. (Prior to spring meeting of Executive Committee) Task group plans for SSRC Annual Technical Session.

8. It is contact member's responsibility to check regularly with task group chairman regarding task group progress, and particularly with respect to his duties and plans in connection with: (a) holding of task group meetings; (b) reports to Executive Committee; and (c) planning for and participation in Annual Technical Session.

9. In the event task group chairman will not be present at Executive Committee meeting or at Annual Technical Session, contact member will present task group report, or (if he is unable to attend) he shall arrange for an alternate to report, consulting in advance with SSRC Chairman or Secretary as appropriate.

10. In general, SSRC Chairman commissions and furnishes all necessary instructions to task group, and contact member renders follow-up services. Thus, task group chairman is ultimately responsible to Executive Committee, not to contact member.

VI. GUIDELINES FOR SSRC TASK GROUP CHAIRMEN

1. Scope of Task Group Activities

Review the scope as approved by the Executive Committee and recommend changes if needed.

2. Task Group Membership

a. At the time the task group is formed, recommend task group membership to the Executive Committee. Task group members will be approved by the Executive Committee and notified by the SSRC Chairman.

b. Review the task group membership at least once each year (before the annual meeting) and recommend new members or changes in the membership to the Executive Committee.

c. Endeavor to insure that members are active participants in the task group activities.

3. Conduct of Business

a. Direct the activities of the task group in the work required to carry out the assignment defined in the task group scope.

b. Carry out other tasks as may be assigned by the Executive Committee.

c. Hold a meeting of the task group at least once each year.

4. Reporting of Task Group Activities

Submit a written report of task group activities to the Executive Committee before each Executive Committee meeting. The deadlines for the reports will be indicated to the task group chairman by correspondence from the SSRC secretary. Reports should cover:

1. Task group meeting minutes.
2. Status of research projects being supervised or advised by task group.
3. Membership status and recommended changes (before the annual meeting).
4. Other items of task group progress.
5. Comments on other SSRC activities, as appropriate.

