



Missouri University of Science and Technology
Scholars' Mine

AISI-Specifications for the Design of Cold-Formed Steel Structural Members

Wei-Wen Yu Center for Cold-Formed Steel Structures

01 Oct 2002

Standard Test Method for Determining the Web Crippling Strength of Cold-Formed Steel Members

Roger A. LaBoube

Missouri University of Science and Technology, laboube@mst.edu

R. Schuster

Follow this and additional works at: <https://scholarsmine.mst.edu/ccfss-aisi-spec>

 Part of the [Structural Engineering Commons](#)

Recommended Citation

LaBoube, Roger A. and Schuster, R., "Standard Test Method for Determining the Web Crippling Strength of Cold-Formed Steel Members" (2002). *AISI-Specifications for the Design of Cold-Formed Steel Structural Members*. 106.

<https://scholarsmine.mst.edu/ccfss-aisi-spec/106>

This Technical Report is brought to you for free and open access by Scholars' Mine. It has been accepted for inclusion in AISI-Specifications for the Design of Cold-Formed Steel Structural Members by an authorized administrator of Scholars' Mine. This work is protected by U. S. Copyright Law. Unauthorized use including reproduction for redistribution requires the permission of the copyright holder. For more information, please contact scholarsmine@mst.edu.

**Standard Test Method for
Determining the Web
Crippling Strength of
Cold-Formed Steel
Members**

RESEARCH REPORT RP02-6

OCTOBER 2002

Committee on Specifications
for the Design of Cold-Formed
Steel Structural Members



American Iron and Steel Institute

The material contained herein has been developed by researchers based on their research findings. The material has also been reviewed by the American Iron and Steel Institute Committee on Specifications for the Design of Cold-Formed Steel Structural Members. The Committee acknowledges and is grateful for the contributions of such researchers.

The material herein is for general information only. The information in it should not be used without first securing competent advice with respect to its suitability for any given application. The publication of the information is not intended as a representation or warranty on the part of the American Iron and Steel Institute, or of any other person named herein, that the information is suitable for any general or particular use or of freedom from infringement of any patent or patents. Anyone making use of the information assumes all liability arising from such use.

**STANDARD TEST METHOD FOR DETERMINING
THE WEB CRIPPLING STRENGTH
OF COLD-FORMED STEEL MEMBERS**

AN AISI SPONSORED PROJECT

By

**Prof. R. LaBoube
And
Prof. R. Schuster**

October 2002

STANDARD TEST METHOD FOR DETERMINING THE WEB CRIPPLING STRENGTH OF COLD-FORMED STEEL MEMBERS

1. INTRODUCTION AND BACKGROUND

It is a well-known fact that web elements of cold-formed steel members may crippling, that is buckle or yield, when subjected to local concentrated loads. This behavior has been studied by numerous investigators since the 1940s, and it has been concluded that a purely theoretical analysis is rather complicated because it involves numerous influencing parameters (Yu, 1999). For this reason, practical design provisions in North America are based on experimental testing. It has long been recognized and established that the web crippling strength is very much a function of the section geometry (Figure 1). For example, I-sections made of two C-sections connected back to back or similar sections provide a higher degree of restraint against rotation of the web in comparison to shapes having single webs. Based on this, the current Specification provides separate expressions for different section geometries. Also, the web crippling strength depends on the load position and whether or not only one flange is being loaded or two flanges. If it is end loading, the concentrated load is applied at the end of the member and in the case of interior loading, the concentrate load is applied somewhere in the middle of the member span. Typically, web crippling tests are carried out for each section geometry and for each of the following four load cases: These four different loading cases are illustrated in Figure 2.

At this time, there is no recognized standard test method for determining the web crippling strength. The published web crippling data dates back to the early 1940s and over the years researchers have carried out numerous web crippling tests [See Report by Schuster, Xu and Beshara entitled, "Cold-Formed Steel Web Crippling Data", AISI Project, April 1999]. In reviewing all of this test data, one can conclude that the data is not always consistent. For example, the length of test specimen for certain load cases is not consistent. Also, most of the data is based on test specimens not fastened to the support during testing. This is in contrast to how cold-formed steel members are typically installed in the field, i.e., they are usually fastened to the support. Although, the generic single or double track deflection track is a common application were the flange is not attached. Fastening and test specimen length has been shown to result in an increase of up to 75% of the actual web crippling strength for certain load cases.

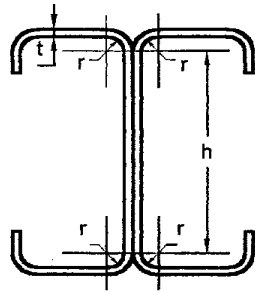

Stiffened Flanges

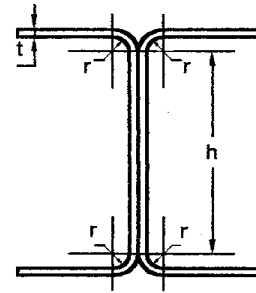

Unstiffened Flanges

I- Sections

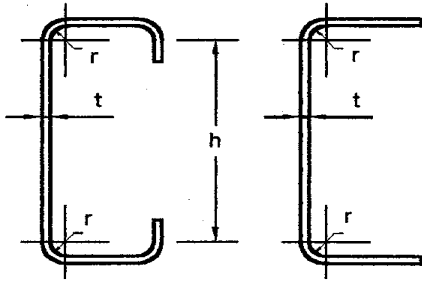

Stiffened Flanges

Unstiffened Flanges

C - Sections

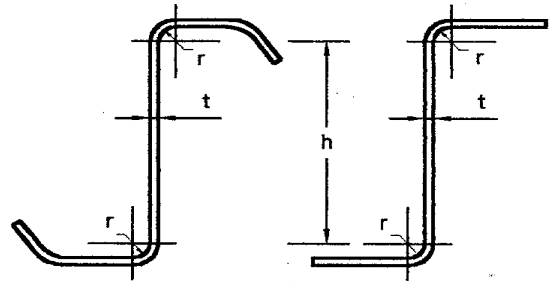

Stiffened Flanges

Unstiffened Flanges

Z - Sections

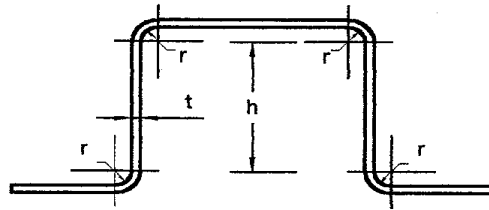

Single Hat Section

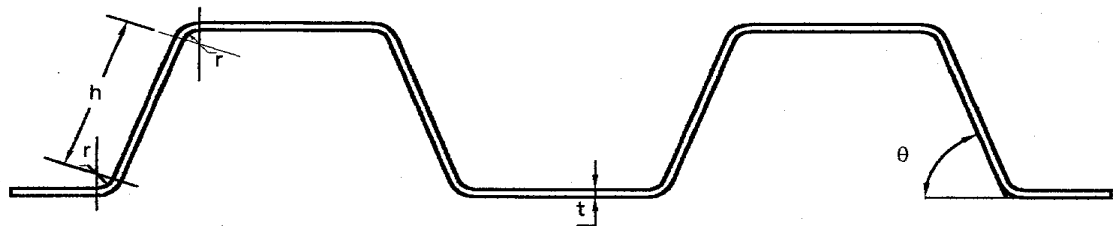

Multi-Web Section

Figure 1 – Typical Section Geometries

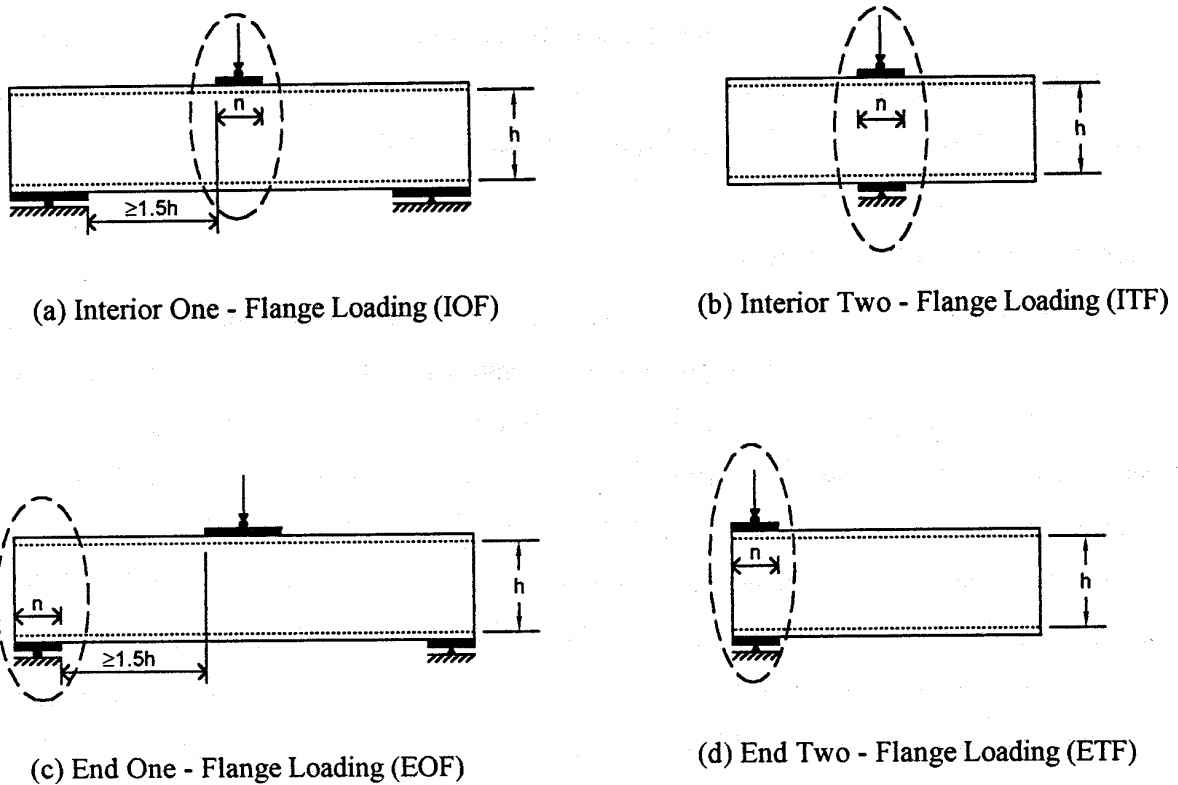

Figure 2 – Load Cases for Web Crippling Tests

2. OBJECTIVE AND SCOPE

The object of this work was to develop a standard test method that could be used to establish the web crippling strength of cold-formed steel members.

The test method is the result of extensive testing of numerous different cross-section geometries over many years, benefiting from the experience provided by technical and industry experts. The test method is applicable to all of the section geometries shown in Figure 1 and subjected to the four load cases shown in Figure 2.

3. PARAMETERS INFLUENCING THE WEB CRIPPLING STRENGTH

3.1 There are six key parameters that influence the web crippling strength of cold-formed steel members (Hetrakul and Yu 1978 [1], Prabakaran 1993 [2]). These key parameters are the following: thickness of the web, t ; yield strength of the web, F_y ; web slenderness ratio, h/t ; inside bend radius to thickness ratio, R/t ; length of bearing to thickness ratio, N/t ; and web inclination, θ . In addition to these key parameters, an additional parameter that must be considered in a test program is the fastening of the flanges. Earlier web crippling tests were performed with the test specimens not being attached to their supporting flange elements. Recent studies have shown that the presence of a flange attachment can have a significant

influence on the web crippling strength. In order to include all of these parameters in the test program, a number of different tests must be carried out to adequately cover the range of these parameters and the loading cases.

4. LOAD CASES

4.1 As shown in Figure 2, there are four different loading cases that must be investigated. The two loading cases are ***One-Flange Loading and Two-Flange Loading***. In each loading case, ***END*** and ***INTERIOR*** tests may be considered. Thus, a total of four different loading cases may occur for web crippling.

One-Flange Loading Case

End One-Flange Loading (EOF)

Interior One-Flange Loading (IOF)

Two-Flange Loading Case

End Two-Flange Loading (ETF)

Interior Two-Flange Loading (ITF)

4.2 **One-flange loading** is the case where only one flange of the section is being loaded in a simple-span test setup (Figures 2a and 2c). To achieve a one-flange loading condition, the clear distance between bearing plate edges must be equal to or greater than 1.5 times the flat dimension of the web element, h , i.e. $1.5h$. If the distance between the bearing plates is less than $1.5h$, then the load case must be considered a two-flange load case.

i) ***Interior One-Flange Loading (IOF)*** - This load case is a condition where the web crippling failure load is accompanied by a moment, therefore it is important to keep the specimen length to a minimum (Fig. 2a). This can be achieved by setting the clear distance between bearing plate edges equal to $1.5h$, hence keeping the specimen to its shortest possible length. The moment ratio of the test moment, M_t , to the calculated nominal moment, M_n , should be equal to or less than 0.30. If this can not be achieved, then the specimen must be considered to be subjected to the combined action of web crippling and bending. The end bearing plates are typically chosen to be wide plates and/or additional web reinforcing is provided at each end support to insure that the failure will occur at the interior load application location.

ii) ***End One-Flange Loading (EOF)*** – As depicted by Fig. 2c, the failure will occur at one of the end support bearing plates in a pure web crippling mode. The length of specimen is generally kept to a minimum to preclude the failure at the interior load application location. Typically, a wide bearing plate is chosen at the interior load application location with additional reinforcement in order to avoid a possible premature failure.

4.3 **Two-Flange Loading** is the case where both flanges of a section are being loaded simultaneously (Figs. 2b and 2d). The length of specimen is important in order to simulate a realistic condition as experienced in practice. This is especially important in the case of single-web sections such as C- and Z-sections. If the specimen length is too short, failure

will be by complete overall buckling of the web element, which is not realistic in practice. In the case of multi-web sections such as deck profiles, the test specimen length is not as important in that there are a number of web elements that share the web crippling load.

- i) ***Interior Two-Flange Loading (ITF)*** – As depicted by Fig. 2b, the applied load is directly over the support reaction, both bearing plates must be the same width for any given test. The length of a single-web specimen should be at least equal to five times the section depth and be positioned symmetrically in the test frame.
- ii) ***End Two-Flange Loading (ETF)*** – As depicted by Fig. 2d, the bearing plates must be the same width for any given test. Also, the specimen length of single-web sections should be at least equal to five times the section depth and the specimen should be positioned flush with both bearing plates at the end being tested. The other end of the specimen is typically placed on a support to stabilize the section during testing.

5. SPECIMENS

5.1 There are two different support restraint conditions that may be considered, i.e., (1) where the specimen is not fastened to the support, and (2) where the specimen is fastened to the support during testing. In practice, cold-formed steel products may be fastened to their supports.

- i) ***Specimen not Fastened to Support*** – In this support restraint condition the specimen is not fastened to a support or to a bearing plate. The web crippling strength may be less than if the specimen was fastened to the support. The reason for this reduced capacity is attributed to the specimen not being restrained against rotation.
- ii) ***Specimen Fastened to Support*** – The specimen is fastened to the support, which may result in larger web crippling capacity because the specimen is restrained against rotation. Bolts can be used to fasten the specimens to the bearing plates.

5.2 Because the web crippling capacity depends on the cross section geometry, each section type illustrated in Figure 1 must be considered individually for each of the load cases shown in Figure 2.

I – SECTIONS

5.3 I-sections are made of two C-sections, stiffened or unstiffened, connected back-to-back and provide for a high degree of restraint against rotation of the web element. Typically, such members are bolted or welded together or are connected together with self-drilling screws. The web crippling strength results can be quite different depending on where the two

individual sections are connected together. For example, the largest strength will result if the sections are fastened together near the top and bottom flanges, such as at the top and bottom inside bend radius locations. In contrast, if the two fastener lines are located near the centerline of the web element the web crippling strength will be reduced. This is due to the degree of rotational stiffness of the flange elements, which is greater if the fasteners are located near the flange elements. The flanges may be fastened or unfastened to the bearing plates during testing.

5.4 One-Flange Loading

- i) **Interior Loading** - The length of the specimen should be as short as possible so as to reduce the unavoidable moment influence to an absolute minimum. Historically, specimen lengths have been defined as the distance between bearing plates plus the sum of the bearing lengths (Fig. 3). To insure that failure occurs at the load application, both ends of the specimen should be reinforced. See Section 4.2 i) for additional information.

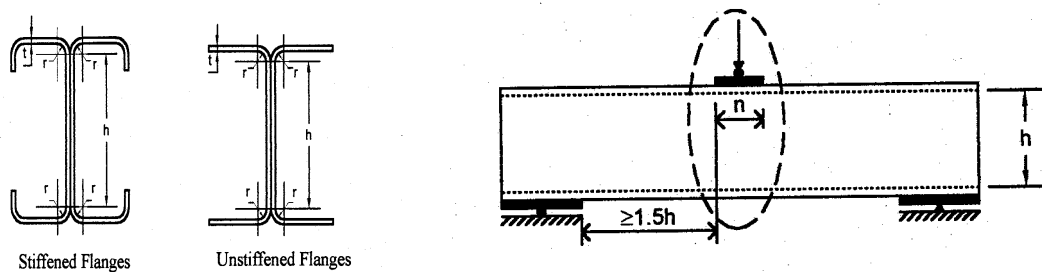

Figure 3 – Interior One-Flange Loading of I-Section Specimens

- ii) **End Loading** – See Section 4.2 ii)

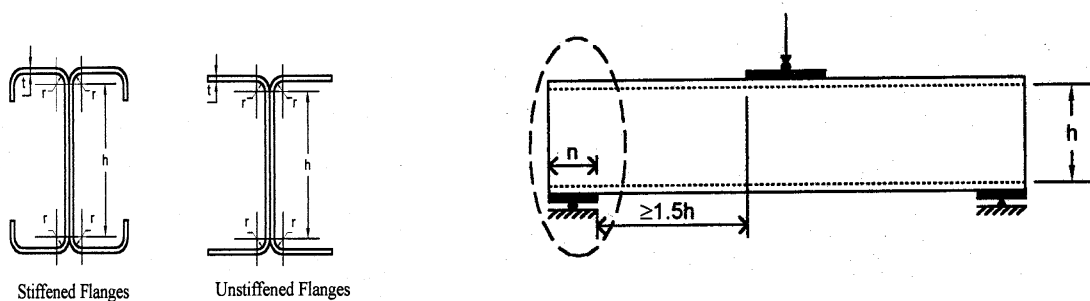

Figure 4 – End One-Flange Loading of I-Section Specimens

5.5 Two-Flange Loading

- i) *Interior Loading* – See Section 4.3 i)

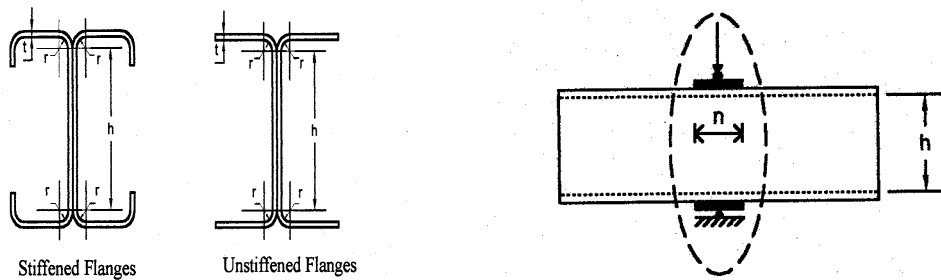

Figure 5 – Interior Two-Flange Loading of I-Section Specimens

- ii) *End Loading* – See Section 4.3 ii)

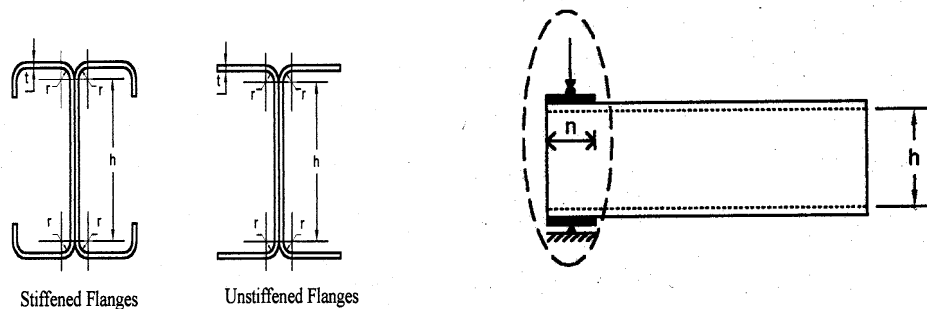

Figure 6 – End Two-Flange Loading of I-Section Specimens

SINGLE WEB SECTIONS

5.6 For Single web specimens, such as C and Z-sections, it is recommended that they be tested in pairs as shown by Fig. 7. Interconnecting the sections using angles will create a box-type test specimen arrangement. This test specimen configuration is recommended to achieve specimen lateral and torsional stability. This is because the C-section does not permit the direct application of the load through its shear center and the Z-section has oblique principle axes. The flanges may be fastened or unfastened to the bearing plates.

5.7 One-Flange Loading

- i) *Interior Loading* - The length of the specimen should be as short as possible so as to reduce the unavoidable moment influence to an absolute minimum. To insure that failure occurs at the load application, both ends of the specimen should be reinforced. See Section 4.2 i) for additional information.

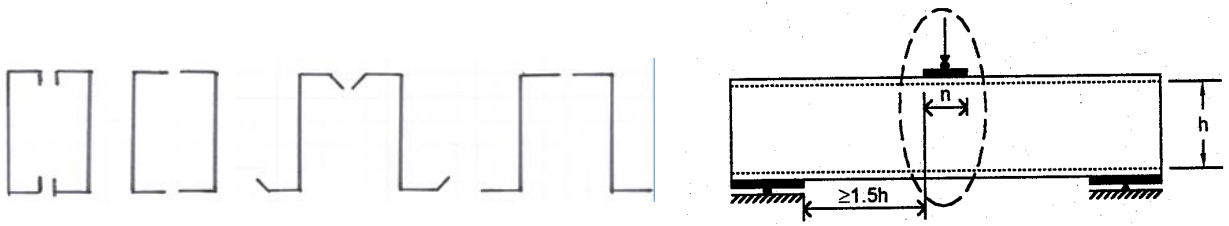

Figure 7 – Interior One-Flange Loading of C and Z-Section Specimens

ii) *End Loading* - See Section 4.2 ii)

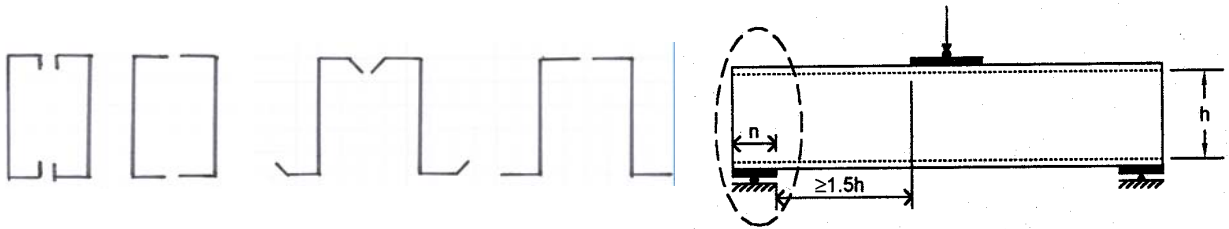

Figure 8 – End One-Flange Loading of C and Z-Section Specimens

5.8 **Two-Flange Loading**

i) *Interior Loading* – See Section 4.3 i)

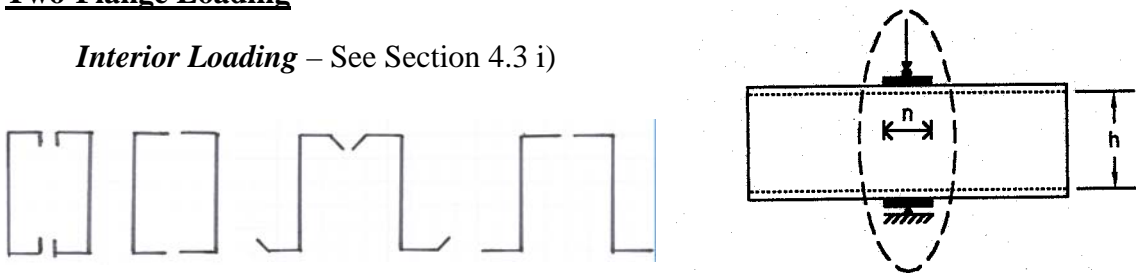

Figure 9 – Interior Two-Flange Loading of C and Z-Section Specimens

ii) *End Loading* – See Section 4.3 ii)

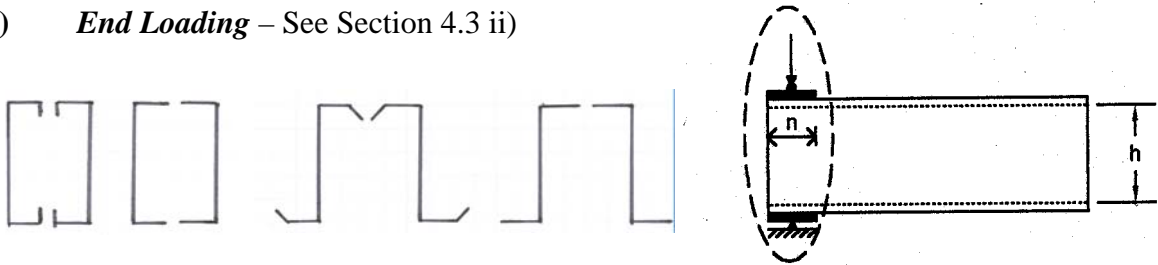

Figure 10 – End Two-Flange Loading of C and Z-Section Specimens

SINGLE HAT SECTIONS

5.9 Single hat sections are rotationally more stable than single web sections and can therefore be tested as individual cross sections. The flanges may be fastened or unfastened to the bearing plates.

5.10 One-Flange Loading

- i) *Interior Loading* - The length of the test specimen should be as short as possible so as to reduce the unavoidable moment influence to an absolute minimum. To insure that failure occurs at the load application, both ends of the specimen should be reinforced. See Section 4.2 i) for additional information.

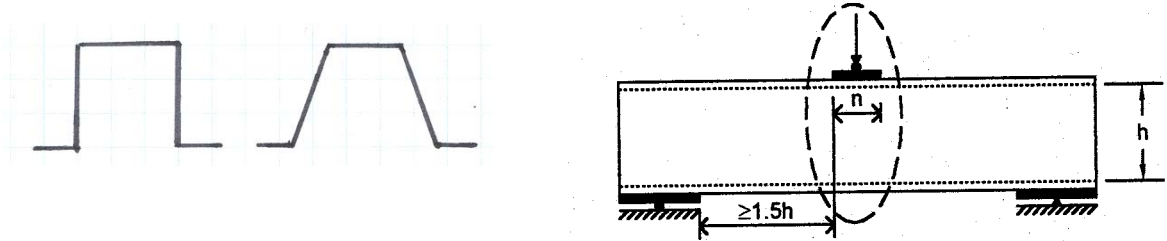

Figure 11 – Interior One-Flange Loading of Single Hat-Section Specimens

- iii) *End Loading* – See Section 4.2 ii)

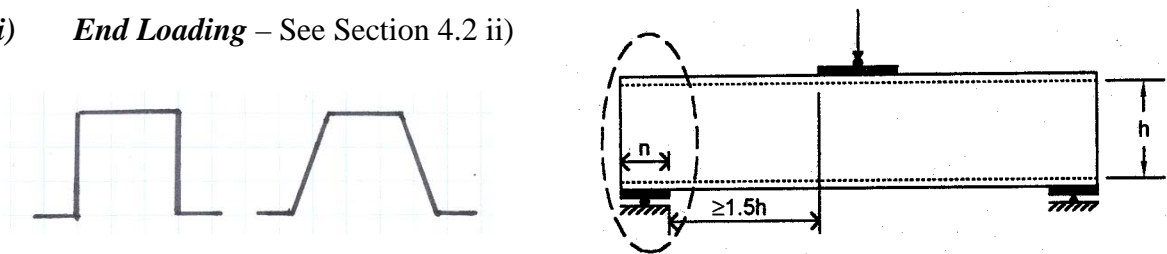

Figure 12 – End One-Flange Loading of Single Hat-Section Specimens

5.11 Two-Flange Loading

- i) *Interior Loading* – See Section 4.3 i)

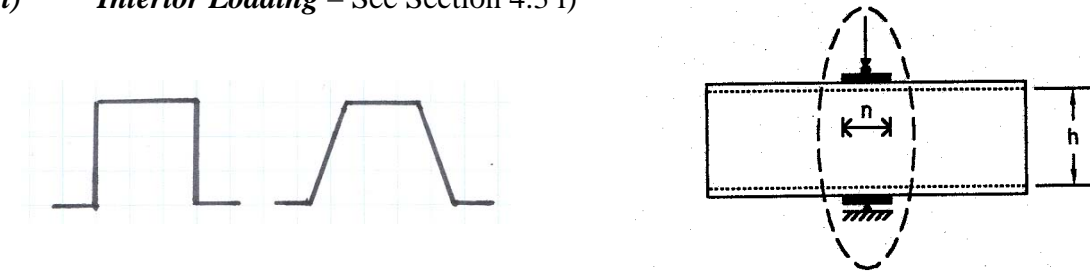

Figure 13 – Interior Two-Flange Loading of Single-Hat Section Specimens

- ii) *End Loading* – See Section 4.3 ii)

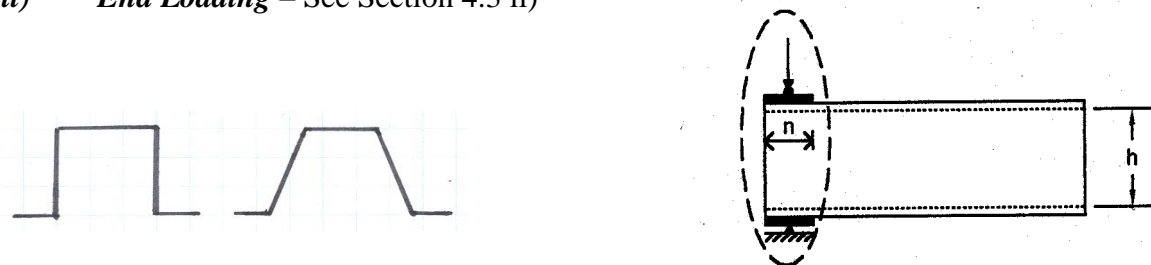

Figure 14 – End Two-Flange Loading of Single-Hat Section Specimens

MULTI-WEB SECTIONS

5.12 Multi-web sections are rotationally even more stable than single hat sections and can therefore be tested as individual cross sections. The flanges may be either fastened or unfastened to the bearing plate.

5.13 One-Flange Loading

- i) **Interior Loading** - The length of the specimen should be as short as possible so as to reduce the unavoidable moment influence to an absolute minimum. To insure that failure occurs at the load application, both ends of the specimen should be reinforced. See Section 4.2 i) for additional information.

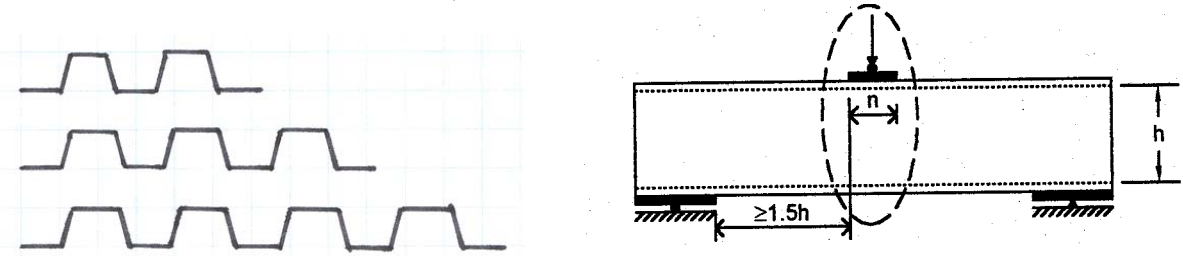

Figure 15 – Interior One-Flange Loading of Multi-Web Section Specimens

- ii) **End Loading** – See Section 4.2 ii)

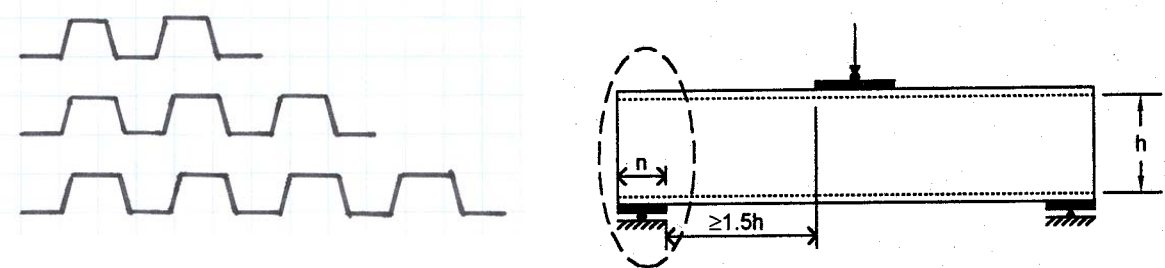

Figure 16 – End One-Flange Loading of Multi-Web Section Specimens

5.14 Two-Flange Loading

- i) **Interior Loading** – See Section 4.3 i)

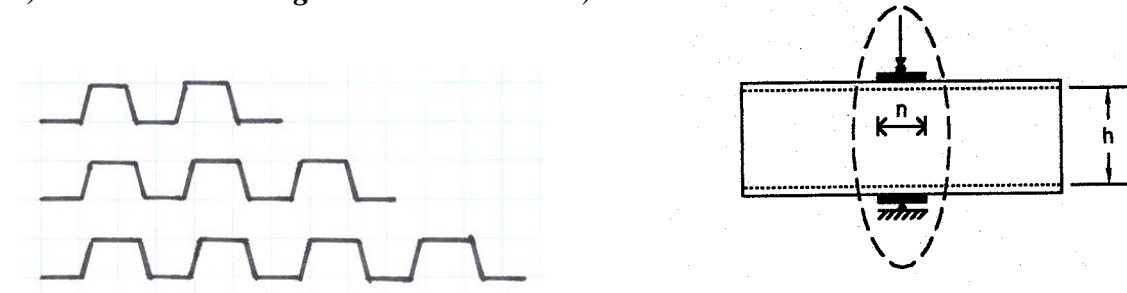

Figure 17 – Interior Two-Flange Loading of Multi-Web Section Specimens

ii) **End Loading** – See Section 4.3 ii)

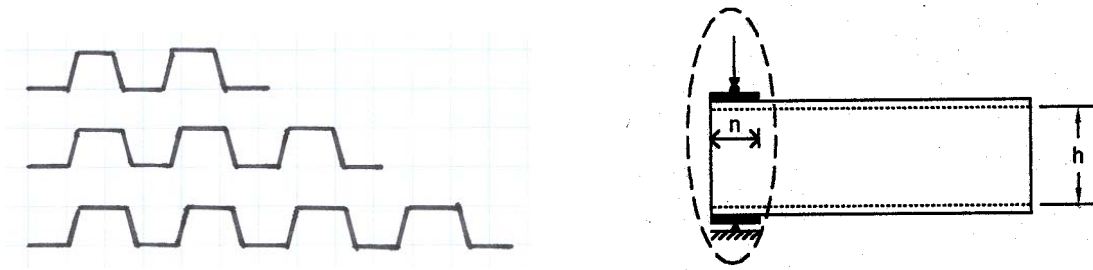

Figure 18 – End Two-Flange Loading of Multi-Web Section Specimens

6. REFERENCE DOCUMENTS

6.1 *ASTM Standards:*

A370 – Standard Test Methods and Definitions for Mechanical Testing of Steel Products

E4 – Standard Practices for Force Verification of Testing Machines

6.2 *AISI Documents:*

Specification for the Design of Cold-Formed Steel Structural Members, 1996 Edition.

7. TERMINOLOGY

7.1 *ASTM Definition Standards:*

E6 – Definition of Terms Relating to Methods of Mechanical Testing.

E380 – Practice for Use of the International System of Units (SI).

7.2 *Description of terms specific to this document:*

End-one-flange loading, Interior-one-flange loading, End-two-flange loading, Interior-two-flange loading, Single Web Shape, and Multiple Web Shape have been previously defined.

7.3 *Symbols:*

h = Depth of flat portion of web element measured along plane of web

L_{\min} = Minimum length of test specimen

N = Length of bearing

t = Web thickness

R = Inside bend radius

θ = Angle between plane of web and plane of bearing surface

8. APPARATUS

8.1 The test method is generally suitable for either hydraulic or screw operated testing machines that comply with the requirements of ASTM E4.

8.2 In lieu of using a test machine, the load may be applied by a hydraulic or pneumatic cylinder. When a cylinder is used, a calibrated load cell must be used to measure the applied load to within ± 2 percent.

9. TEST SPECIMENS

9.1 The test specimen must be both laterally and torsionally stable. Thus, for a geometry that does not permit the application of the load through the shear center, e.g. a C-shape, or for a geometry having oblique principle axes, e.g. Z-shape, the test specimen should consist of two opposed sections as shown in Fig. 7. The individual sections may be interconnected by angles to form a box-type cross section. Alternatively, the shapes may be positioned to represent in-place conditions with appropriate lateral stability provided, such as two C-shapes facing the same direction with the top flange attached by sheathing.

9.2 When evaluating the web crippling capacity of a specific cross section, the box shape must be constructed with two cross sections of like geometry, dimensions, and material properties. When evaluating the web crippling capacity of a specific structural connection or condition, the in-place condition must be simulated by the test specimen, for example, a lapped section at the interior support.

9.3 Interconnecting the cold-formed steel shapes using rigid connecting elements, e.g. L3/4x3/4x1/8 to form the box shape. Connecting elements of equivalent stiffness may be used, for example sheathing.

9.4 The rigid connecting elements shall be connected to the top flange of the cold-formed steel shape using screws or bolts. A self-drilling screw is commonly used. The rigid connecting elements may be attached to the bottom flange as well.

9.5 When using rigid connecting elements they should be located at approximately the $\frac{1}{4}$ and $\frac{3}{4}$ points along the longitudinal axis of the box shape.

9.6 For built-up shapes, e.g. back-to-back C-shapes or nested Z-shapes, the fastener type and pattern used to fabricate the shape shall replicate the in-place condition.

9.7 For shapes that will not maintain their cross-section geometry under load, e.g. a hat shape, the open side of the cross section must be laterally restrained by rigid elements.

9.8 The length of the test specimen is defined based on the loading condition and the in-place conditions. Conservatively, the minimum specimen lengths may be taken as follows:

EOF Loading: $L_{\min} = 3h + \text{bearing plate lengths}$ (See Fig. 2c)

IOF Loading: $L_{\min} = 3h + \text{bearing plate lengths}$ (See Fig. 2a)

ETF Loading: $L_{\min} = 3h$ (See Fig. 2d)

ITF Loading: $L_{\min} = 3h$ (See Fig. 2b)

where h = Depth of the flat portion of the web measured along the plane of the web

For ITF loading, $L_{\min} = 3h$ provides a conservative web crippling strength. Based on in-place conditions, a larger length may be used, a value of at least $L_{\min} = 5h$ is recommended. Longer lengths for IOF loading may result in premature failure resulting from combined bending and web crippling.

9.9 The length of the bearing plate, N , shall replicate in-place conditions.

9.10 The cold-formed steel shape should be connected to its support member replicating in-place conditions. For conservative results, or to reflect in-place conditions, the support connection may be omitted.

9.11 The support condition may conservatively be simply supported or the support condition may replicate the in-place conditions (e.g. C-shapes nested into a track section).

9.12 To reflect the advantageous benefit of a structural system, the test specimen configuration and bracing may be used that replicate the in-place conditions.

10.0 Test Procedure

10.1 A test series shall consider each steel grade and cross-section geometry.

10.2 When the web crippling strength for design is to be based on test results. A test series shall consist of no fewer than three tests for each unique cross section type and steel grade. The factor of safety or phi factor used in design shall be computed in accordance with Section F1 of the *Specification for the Design of Cold-Formed Steel Structural Members*.

10.3 When the web crippling strength is based on a calculation algorithm, a test series shall consist of no fewer than two tests for each unique cross section and steel grade. The calculation algorithm shall reflect the key parameters that influence the web crippling strength as defined by Section C3.4 of the *Specification for the Design of Cold-Formed Steel Structural Members*. The factor of safety or phi factor used in design shall be computed in accordance with Section F1 of the *Specification for the Design of Cold-Formed Steel Structural Members*.

10.4 The physical and material properties of the sheet steel shall be determined in accordance with ASTM A370. The coupons may be taken from flat sheet cut from the coil used to fabricate the cold-formed steel shapes, or the coupons may be taken from the web element of the shape. Coupons should be taken from areas where cold-working stresses will not effect the results.

10.5 The test specimen shall be loaded to failure and the mode of failure noted. Failure is at the point at which the specimen will accept no further load.

10.6 Lateral deformation of the web may be measured during the test using either a dial gage or displacement transducer.

11. Test Evaluation

11.1 The measured failure load per web at the location of failure shall be computed.

12. Test Report

12.1 The objectives and purposes of the test series shall be stated at the outset of the report so that the necessary test results such as the failure load, and the mode of failure are identified.

12.2 The type of tests, the testing organization, the supervising engineer, and the dates on which the tests were conducted shall be included in the documentation.

12.3 The test specimen shall be fully documented, including:
the measured dimensions and identification data of each specimen:

- material thickness
- yield strength
- percent elongation
- cross-section dimensions
- bearing plate width(s)
- specimen length
- support conditions

- manufacturer
- any other distinguishing characteristics
- (a) location of additional stiffeners
- (b) location of lateral braces
- (c) location and size of connecting elements
- (d) type and size of fasteners used.

12.4 The report shall include the type of testing machine, loading increments, and supports. If a hydraulic cylinder and load cell are used, they shall be described. The last date of calibration for the test machine or load cell shall be recorded.

12.5 The report shall include a description summarizing the test program results to include specimen type, span length, failure loads for the test series, and supporting calculations.

13. REFERENCES

Yu, W. W. (2000), "Cold-Formed Steel Design," Third Edition, John Wiley & Sons, Inc., New York.

Hetrakul, N. and Yu. W.W. (1978), "Structural Behavior of Beam Webs Subjected to Web Crippling and a Combination of Web Crippling and Bending," Civil Engineering Study 78-4, Cold-Formed Steel Series, Final Report, University of Missouri-Rolla, Rolla, Missouri, USA.

Parabakaran, K. (1993), "Web Crippling of Cold Formed Steel Sections," Project Report, Department of Civil Engineering, University of Waterloo, Waterloo, Ontario, Canada.

Schuster, R.M., Xu, K., Beshara, B. (1999), "Cold-Formed Steel Web Crippling Data," Canadian Cold Formed Steel Research Group, University of Waterloo, Waterloo, Canada.

Schuster, R.M., Beshara, B. (2000) "Web Crippling of Cold Formed Steel Members," Final Report, Canadian Cold Formed Steel Research Group, University of Waterloo, Waterloo, Canada.



American Iron and Steel Institute

1140 Connecticut Avenue, NW
Suite 705
Washington, DC 20036

www.steel.org

