



Missouri University of Science and Technology
Scholars' Mine

International Conferences on Recent Advances in Geotechnical Earthquake Engineering and Soil Dynamics 1995 - Third International Conference on Recent Advances in Geotechnical Earthquake Engineering & Soil Dynamics

04 Apr 1995, 10:30 am - 12:00 pm

Dynamic Characteristics of Comares Palace in the Alhambra

V. Cuellar

Laboratorio de Geotecnia, CEDEX, Madrid, Spain

E. Kausel

Massachusetts Institute of Technology, Cambridge, MA, USA

J. L. Monte

Laboratorio de Geotecnia, CEDEX, Madrid, Spain

J. M. Roesset

The University of Texas at Austin, Austin, TX

J. Valerio

Laboratorio de Geotecnia, CEDEX, Madrid, Spain

Follow this and additional works at: <https://scholarsmine.mst.edu/icrageesd>

 Part of the [Geotechnical Engineering Commons](#)

Recommended Citation

Cuellar, V.; Kausel, E.; Monte, J. L.; Roesset, J. M.; and Valerio, J., "Dynamic Characteristics of Comares Palace in the Alhambra" (1995). *International Conferences on Recent Advances in Geotechnical Earthquake Engineering and Soil Dynamics*. 6.

<https://scholarsmine.mst.edu/icrageesd/03icrageesd/session01/6>

This Article - Conference proceedings is brought to you for free and open access by Scholars' Mine. It has been accepted for inclusion in International Conferences on Recent Advances in Geotechnical Earthquake Engineering and Soil Dynamics by an authorized administrator of Scholars' Mine. This work is protected by U. S. Copyright Law. Unauthorized use including reproduction for redistribution requires the permission of the copyright holder. For more information, please contact scholarsmine@mst.edu.

Dynamic Characteristics of Comares Palace in the Alhambra Paper No. 1.07

V. Cuellar, J.L. Monte and J. Valerio
 Laboratorio de Geotecnia, CEDEX, Madrid, Spain

J.M. Roesset
 The University of Texas at Austin, Austin, TX, USA

E. Kausel
 Massachusetts Institute of Technology, Cambridge, MA, USA

SYNOPSIS This paper describes the geotechnical investigations that have been conducted to characterize the static and dynamic properties of the ground, the foundation and the structure's material of the Comares tower in the Alhambra palace. The G_{max} values of the different materials were determined using seismic refraction, P-wave transmission tomography, cross-hole and down-hole tests. To obtain the variation of the shear moduli with strain amplitude surface wave and cyclic horizontal plate loading tests were performed in several trenches excavated in the immediate neighborhood. The analysis of the structure response to $M = 5$ earthquakes recently recorded at the top and the bottom of the Tower allowed to check the dynamic properties of the materials estimated previously.

INTRODUCTION

The Comares tower in the Alhambra palace was built in the first half of the thirteenth century in Granada, which is one of the most seismically active regions of Spain. Due to the great historical value of the Alhambra, a research program has been launched recently to assess the conditions of the structures and the foundations of its different buildings, starting with the Comares tower. The ultimate goals are to evaluate the seismic risk and to determine whether strengthening is necessary.

After a brief description of the tower and its geological environment the results obtained in the different tests performed to characterize the static and dynamic properties of its foundation and structural materials are presented and the procedure to assess the variation of the shear moduli with strain level is explained. From the analysis of the structure response to $M = 5$ earthquakes conclusions are drawn about its dynamic parameters.

GEOLOGICAL AND STRUCTURAL MATERIALS

The Comares tower (see Fig. 1) is a square structure with 17.5 m sides in plan that extends vertically for approximately 25 m over the Darro river on the top of a ridge, 50 m high, of the Alhambra formation. At the site, that formation consists mainly of a conglomerate with 60% of quartzite and schist particles of gravel size embedded in a silty clay matrix mass. Those materials were deposited at the base of the nearby Sierra Nevada forming alluvial fans in the Upper Pliocene. Subsidence and fracturing of the Granada basin during the Pleistocene period transformed one of those fans into the hill on the top of which stands the Alhambra fortress today. Seismic refraction

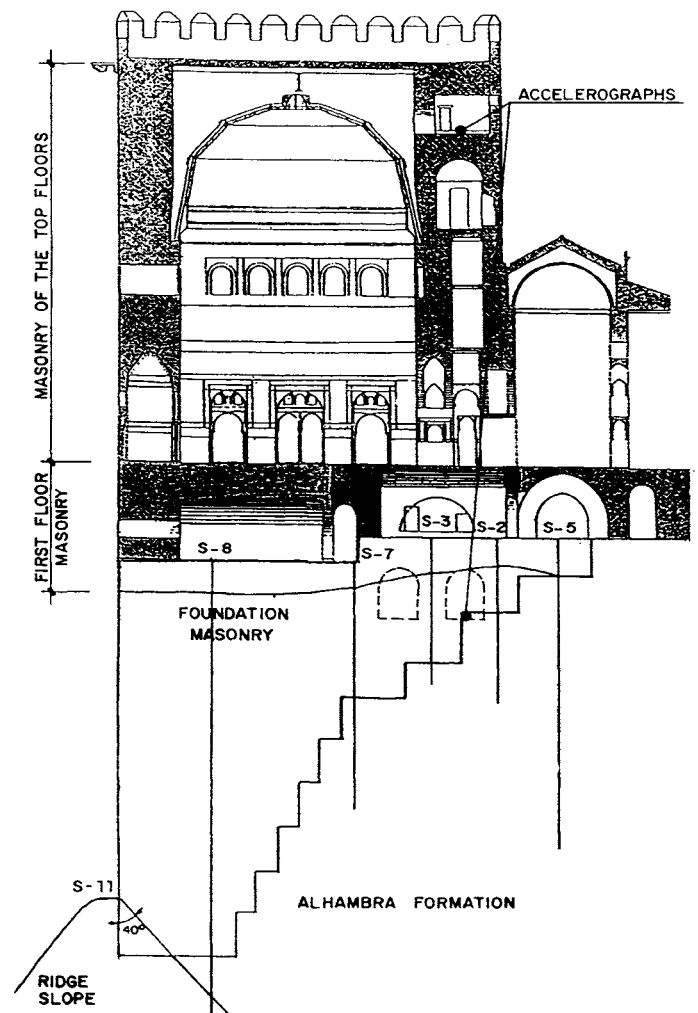

Fig. 1. Comares Tower

surveys carried out on the hill, at the base of the structure revealed the existence of an upper 5 m thick decompressed zone with an average P-wave velocity of 570 m/s overlying more competent materials of the same nature. The same type of materials, cemented with lime and compacted in thin layers, gives place to a rough masonry which locally known as "tapial" was used for the construction of the foundation and structure's walls of the palace.

To analyse the geometry and mechanical properties of the foundation, several vertical and inclined boreholes of 80 mm diameter were drilled from the first floor of the building and the top of the ridge at the base of the structure. The information provided by the boreholes and the results obtained in P-wave transmission tomography performed between them allowed to define the geometry of the foundation as indicated in Fig. 1. On the other hand, taking into account the effect of weathering, the hazardous features (fires, explosions, earthquakes) and the structural modifications to which the palace has been subjected in the past (Kausel, 1993) the three masonry categories indicated in Fig. 1 have been distinguished.

MECHANICAL CHARACTERIZATION OF THE ALHAMBRA FORMATION

Due to the impossibility of obtaining undisturbed samples to be tested in the laboratory, the geomechanical properties of the Alhambra formation have been determined in situ by means of horizontal plate loading tests and surface wave propagation tests carried out in two trenches excavated up to a depth of 2 m in the immediate surrounding of the Tower. Fig. 2 shows how both types of tests were distributed in each trench. The type of loading-unloading cycles imposed in a typical static test are given in Fig. 3 and in Fig. 4 the experimental dispersion curve obtained in the dynamic test close to that static one is presented. The theoretical curve included in that figure corresponds to the distribution of shear wave velocities indicated in its lower part calculated as suggested by Roesset et al (1991) using the Green's functions derived by Kausel (1981). In that process one firstly assumes a shear wave profile, conducts an analytical study to obtain the theoretical dispersion curve corresponding to that profile, compares this theoretical curve to the experimental results, introduces appropriate modifications to the profile and repeats the process iteratively until satisfactory agreement is reached.

To simulate the influence of strain on the shear modulus value, isotropic behavior of the material was assumed and the hyperbolic model given by Eq. (1) was chosen to represent the nonlinear behavior of the material at points in the ground subjected to the same vertical stress σ_v (see Fig. 2)

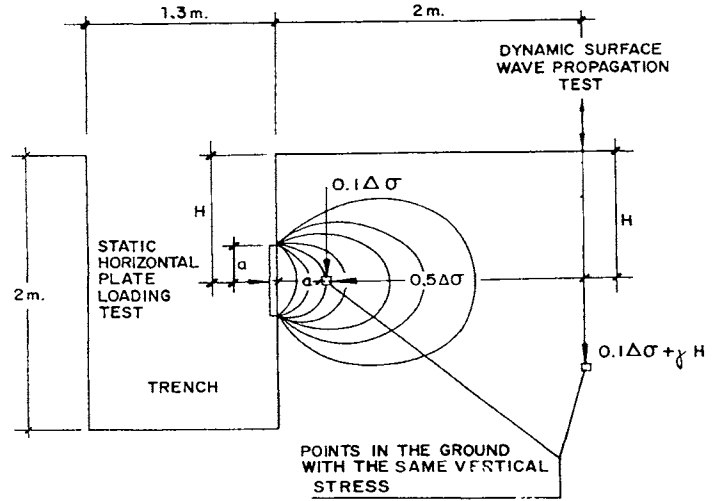

Fig. 2. In Situ Static and Dynamic Tests

$$\bar{G} = \frac{1}{1 + b G_{\max} \bar{\gamma}} \quad (1)$$

Parameter G_{\max} in Eq. (1) was derived directly from the data obtained for a particular value σ_1 of the effective vertical stress in the dynamic tests (see Table 1) while parameter b was determined substituting in Eq. (1) the values \bar{G} and $\bar{\gamma}$ determined as indicated in Table 2 for a loading step $\Delta\sigma$ in the static test inducing the same vertical stress σ_v as the one existing in the ground at a particular depth in the dynamic test.

TABLE 1. Parameters derived from dynamic test at each depth z

Vertical stress	Shear wave velocity	Maximum shear modulus
$\sigma_v = \gamma z$	$v_s = f(z)$	$G_{\max} = \rho v_s^2$

γ = unit weight (21 KN/m³)

ρ = mass density

$f(z)$ = shear wave velocity profile given in Fig. 4

TABLE 2. Parameters derived from static test for each loading step $\Delta\sigma$

Vertical stress	Equi. Young modulus	Equi. Shear modulus
$\sigma_v = 0.1\Delta\sigma + \gamma H$	$\bar{E} = \frac{\pi(1-\nu^2)D\Delta\sigma}{4s}$	$\bar{G} = \frac{\bar{E}}{2(1+\nu)}$
Equivalent axial strain	Equivalent shear strain	
$\bar{\epsilon} = \frac{0.2(2.5-\nu)\Delta\sigma}{\bar{E}}$	$\bar{\gamma} = \frac{2(1+\nu)}{2.5-\nu} \epsilon$	

ν = Poisson ratio (0.35)

s = Plate settlement given in Fig. 3

D = Plate diameter (600 mm)

H = Test depth (see Fig. 2)

It can also be proved that the quotient $2/b$ has the meaning of ultimate strength for samples subjected to an in situ confining state of stresses in which the vertical stress is σ_v and that the non-dimensional product $b \cdot G_{max}$ in Eq. (1) characterize the shape of each hyperbola.

To derive a family of hyperbolas that could be used for design, loading steps $\Delta\sigma$ in Table 2 were selected as sketched in Fig. 5 from the loading and unloading branches of the plate test. Fig. 6 shows the results derived from the test given in Fig. 3. The quotient G/G_{max} between the static and dynamic moduli in all the tests ranged between 0.20 and 0.35.

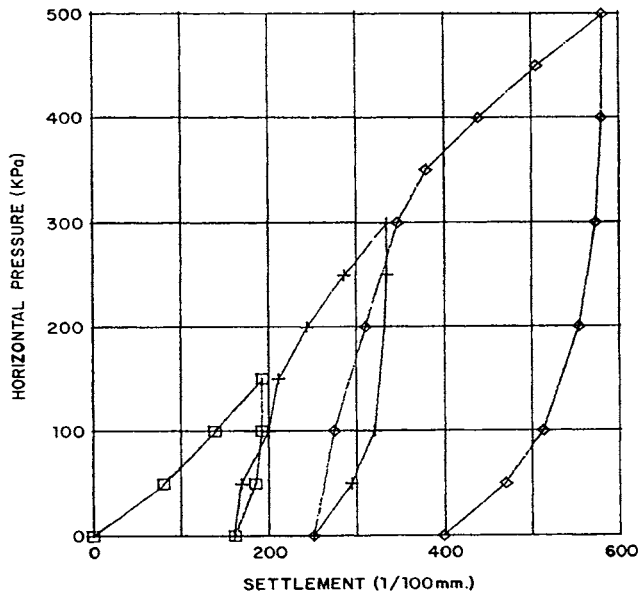

Fig. 3. Horizontal Plate Loading Test

To represent the mechanical behavior of the decompressed zone in the Alhambra formation the hyperbola corresponding to $\sigma_1 = 75$ KPa, compatible with a shear wave velocity of 300 m/seg at a depth of 3.5 m and a compressive resistance of 200 KN/m², was selected, whereas for the undisturbed material under the foundation of the Tower, the product $G_{max} \cdot b = 1510$ corresponding to that hyperbola together with a shear wave velocity of 600 m/seg, as determined in the cross-hole tests, were adopted. Those parameters, compatible with a compression resistance of 1000 KN/m², correspond to the hyperbola given in Fig. 7. The damping ratio curve included in that figure was determined taking into account the data provided by Kokusho and Eshasi (1981) for dense Pleistocene soils of Japan with a percentage of gravel similar to the Alhambra formation.

MECHANICAL PROPERTIES OF THE MASONRY

Longitudinal wave velocities ranging between 900 m/s and 2000 m/s were obtained from P-wave transmission

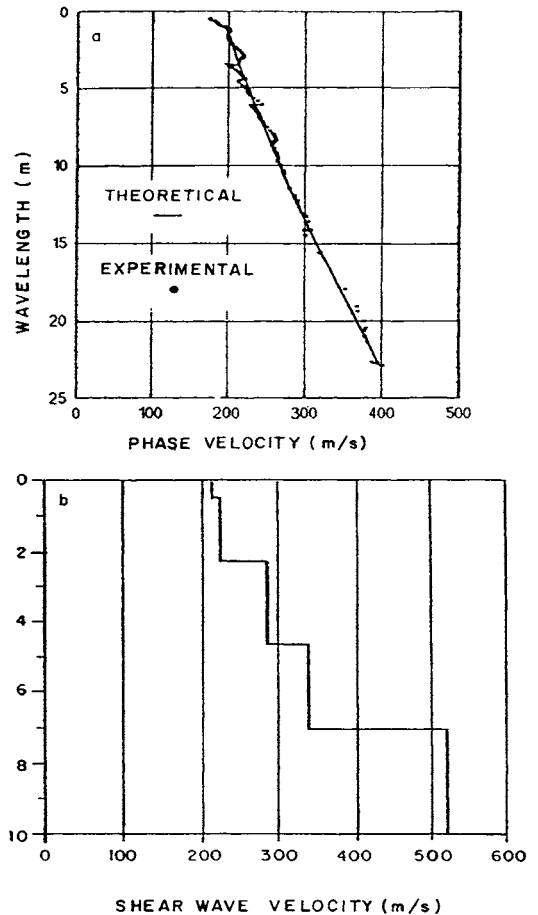

Fig. 4. Surface wave dispersion curve (a) and corresponding shear wave profile (b).

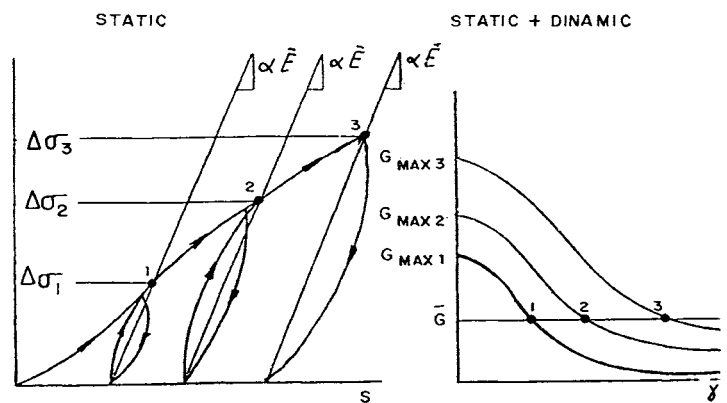

Fig. 5. Hyperbolic models derived from in situ tests

tomography and seismic refraction tests carried out on the walls of the upper floors of the structure. For this material a representative value $v_p = 1360$ m/s was adopted which for a Poisson ratio of 0.3 corresponds to a shear wave velocity of 730 m/s. The unconfined compressive strength associated to those velocities, as determined on laboratory samples retrieved from the walls, was found to be 2500 KN/m².

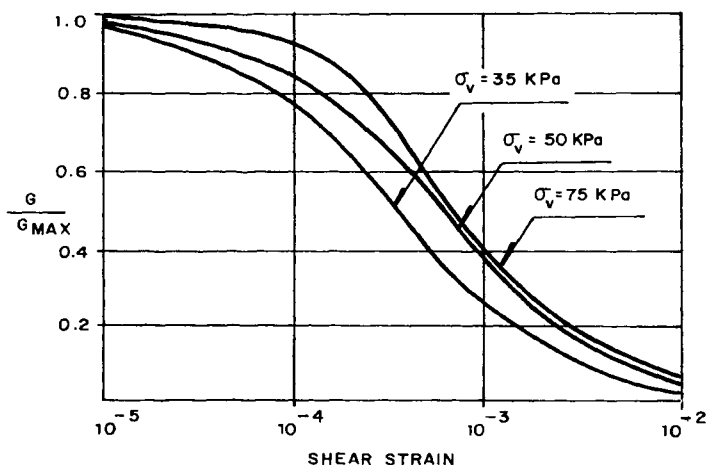

Fig. 6. Hyperbolas derived from test given in Fig. 3 and 4

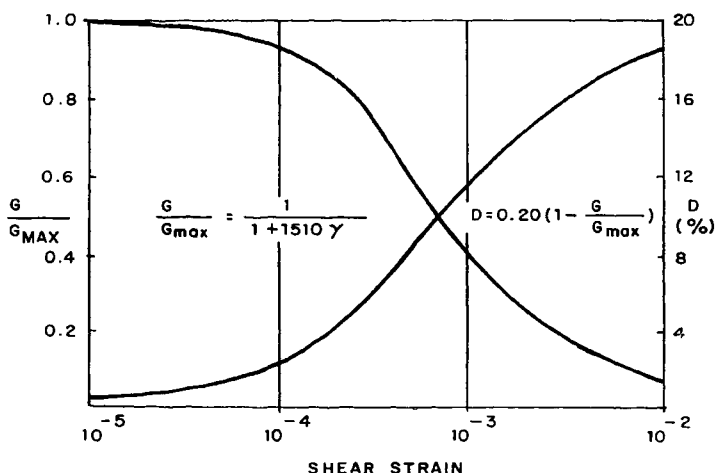

Fig. 7. Dynamic parametes under the Tower

Concerning the foundation masonry, shear wave velocity values ranging between 1000 m/s and 1300 m/s were determined and unconfined compressive strengths between 6700 KN/m² and 9700 KN/m² were found. Representative values $v_s = 1200$ m/s and $q_c = 8000$ KN/m² were adopted for this material.

Using the representative values previously given and the average unit weights determined for these two categories of masonry (21.5 KN/m³ for the top floors and 22 KN/m³ for the foundation) hyperbolic models, reproducing fairly well the stress-strain curves obtained in the unconfined compression tests, were set up. The variations of damping ratio with shear strain adopted for these two materials are given in Table 3.

The geophysical investigation of the first floor masonry led to v_p and v_s values similar to those obtained in the cross-hole and down-hole tests run on the Alhambra formation. Accordingly the same hyperbolic model as the one given in Fig. 7 was adopted for this material.

TABLE 3. Damping ratio (%) of masonry materials

	Shear strain		
	10 ⁵	10 ⁴	10 ³
Top floors	0.20	1.5	8.5
Foundation	0.15	1.0	7.00

SEISMIC MONITORING

To monitor the behavior of the Tower under earthquake excitations two digital strong-motion accelerographs (Kinematics SSA-2) were installed at the base and the top of the structure (see Fig. 1) in the early 1993. Since then, they have been triggered by two earthquakes of magnitude 5 in the Richter scale: the first on the 23rd December 1993 and the second on the 4th January 1994. Their epicenters were located respectively at 73 Km and 94 Km from the site. Fig. 8 presents the E-W acceleration time histories recorded at the top ($a_{max} = 9$ cm/s²) and bottom ($a_{max} = 3$ cm/s²) of the structure on December 1993. Similar records were obtained on January 1994. A natural period of 0.5 seconds can be easily recognized in the last part of the accelerogram recorded at the top of the Tower. On the other hand from the response spectra depicted in Fig. 9, corresponding to the accelerogram recorded at the bottom, it can be seen that a damping ratio slightly higher than 1% is necessary for a natural period of 0.5 seconds to reproduce the peak acceleration recorded at the top. This observation confirms for small shear strains the values given in Table 3.

CONCLUSIONS

In this paper the possibility of determining from in situ tests the non-linear behavior under earthquake type of loading of dense materials with a substantial amount of gravel such as the Pliocene and Pleistocene conglomerates of the Alhambra formation has been demonstrated. Both, seismic refraction and surface wave propagation test have shown the existence of a 5 m thick decompressed zone on the upper part of that formation with an average shear wave velocity half the value of that obtained under the foundation of the Tower. The quotient between the moduli determined by static plate loading tests and those obtained by dynamic surface wave propagation tests has been found to range between 0.20 and 0.35. Seismic geophysical testing has also proved to be of great value to assess the geometry and mechanical properties of the foundation and structural walls of the palace. The seismic monitoring of the Tower has allowed to define its natural period and to check the damping ratio of the structural materials estimated for small cyclic shear strains.

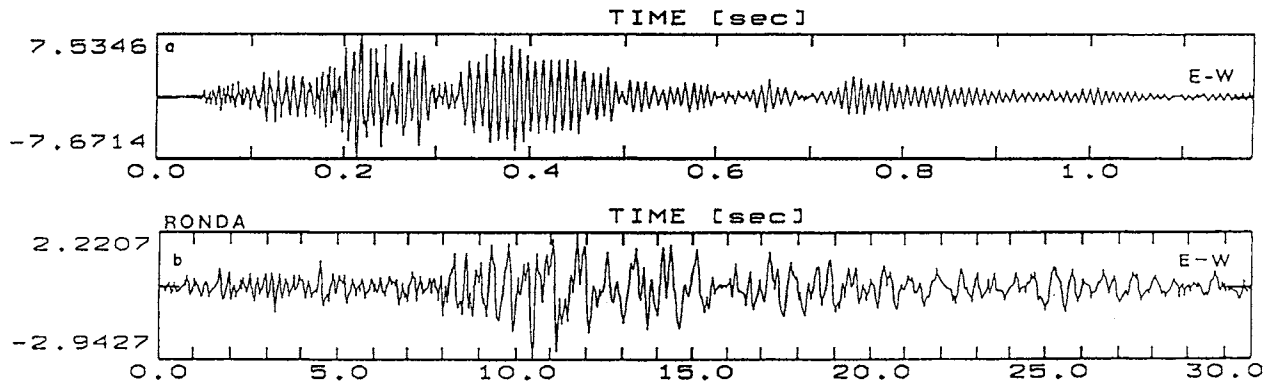

Fig. 8. Acceleration time histories (cm/s^2) recorded at top (a) and bottom (b) of the Tower on December 1993 (Carreño, 1993)

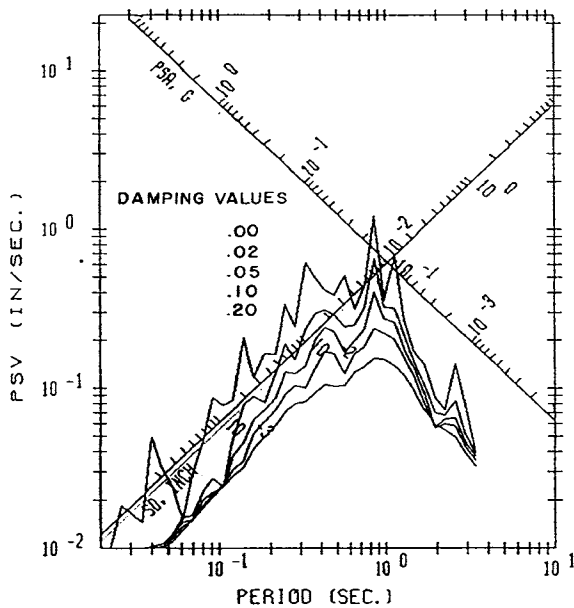

Fig. 9. Response spectra of accelrogram b in Fig. 8 (Carreño, 1993)

ACKNOWLEDGEMENT

Thanks are given to the Direction of the Alhambra Patronage for their help and suggestions to perform this work. Also the financial support provided by the Spanish Directorate General of Scientific and Technical Research is acknowledged.

REFERENCES

- Carreño, E. (1994), Personal Communication, Instituto Geográfico Nacional, Madrid
- Kausel, E. (1981), "An explicit Solution for the Green Functions for Dynamic Loads in Layered Media", Research Report S81-13, Department of Civil Engineering MIT.
- Kausel, C. (1993), "Información Histórica sobre la Estructura y Sótanos de la Torre de Comares", Laboratorio de Geotecnia, Centro de Estudios y Experimentación de Obras Públicas, Madrid
- Kokusho, T. and Eshasi, V. (1981), "Cyclic Triaxial Test on Sands and Coarse Materials", Proc. 10th International Conference on Soil Mechanics and Foundation Engineering, Vol.1, pp. 673-676.
- Roesset, J.M., Chang, D.M. and Stokoe, K.H, II (1991), "Comparison of 2D and 3D Models for Analysis of Surface Wave Tests, Proc. 5th International Conference on Soil Dynamics and Earthquake engineering, Karlsruhe.