



Missouri University of Science and Technology
Scholars' Mine

International Conferences on Recent Advances
in Geotechnical Earthquake Engineering and
Soil Dynamics

2001 - Fourth International Conference on
Recent Advances in Geotechnical Earthquake
Engineering and Soil Dynamics

30 Mar 2001, 4:30 pm - 6:30 pm

Design Concept for High Speed Railway Bridges in Regions with High Seismic Activity and Soft Soil

Oliver Fischer

Bilfinger+Berger BauAG, Germany

Andreas Maurial

Bilfinger+Berger BauAG, Germany

Konstantin Meskouris

Institute for Statics and Dynamics, RWTH, Germany

Carsten Könke

Institute for Statics and Dynamics, RWTH, Germany

Falko Schube

Institute for Statics and Dynamics, RWTH, Germany

Follow this and additional works at: <https://scholarsmine.mst.edu/icrageesd>



Part of the [Geotechnical Engineering Commons](#)

Recommended Citation

Fischer, Oliver; Maurial, Andreas; Meskouris, Konstantin; Könke, Carsten; and Schube, Falko, "Design Concept for High Speed Railway Bridges in Regions with High Seismic Activity and Soft Soil" (2001). *International Conferences on Recent Advances in Geotechnical Earthquake Engineering and Soil Dynamics*. 9.

<https://scholarsmine.mst.edu/icrageesd/04icrageesd/session06/9>

This Article - Conference proceedings is brought to you for free and open access by Scholars' Mine. It has been accepted for inclusion in International Conferences on Recent Advances in Geotechnical Earthquake Engineering and Soil Dynamics by an authorized administrator of Scholars' Mine. This work is protected by U. S. Copyright Law. Unauthorized use including reproduction for redistribution requires the permission of the copyright holder. For more information, please contact scholarsmine@mst.edu.

DESIGN CONCEPT FOR HIGH SPEED RAILWAY BRIDGES IN REGIONS WITH HIGH SEISMIC ACTIVITY AND SOFT SOIL

Dr.-Ing. Oliver Fischer
Bilfinger+Berger BauAG
München, Germany

Dr.-Ing. Andreas Maurial
Bilfinger+Berger BauAG
Wiesbaden, Germany

Prof. Dr.-Ing. Konstantin Meskouris,
Dr.-Ing. Carsten Könke, Dipl.-Ing. Falko Schube
Institute for Statics and Dynamics, RWTH, Germany

ABSTRACT

At present, public transport for mid distances is more and more covered by modern high speed railway links with many examples all over the world being already under construction or in the design process. In case of soft soil conditions or urban areas, many of these projects are being realized as an elevated railway structure utilizing regular viaducts. In seismic active regions earthquake design mainly governs the overall design concept of the bridges, particularly of the piers and foundations. Thus, on the one hand, the structure has to exhibit enough stiffness under serviceability conditions (limitation of rail stresses; safety requirements for high speed trains) while on the other hand, flexibility, energy dissipation and ductility is advantageous with respect to a severe earthquake event. Since the earthquake excitation normally governs the whole structural design in case of high seismicity it is necessary to consider the dynamic loading as early as possible in order to come up with an optimal solution. Modern and efficient numerical simulations using e.g. the Finite Element Method are enabling the design engineers to study the bridge structures under static and dynamic loading conditions, taking into account geometrical and physical nonlinear effects. The following paper describes the design process of a high-speed train structure which has been planned in Taiwan. All results presented herein have been gained during the tender phase of the project which has been finalized in the beginning of the year 2000. The bridge structure has been designed as simply supported viaducts consisting of 35 m and 30 m spans. Each span is supported by four reinforced concrete columns at each end, which are supported by 4 piles (see Fig. 1). The bridge spans have been designed as prestressed box girders, which will be prefabricated and installed at the construction site. Hereby, two earthquake levels have been included, moderate intensity for the serviceability check (elastic response of the structure) and severe earthquake for the ultimate load limit check (elasto-plastic response). The evaluation of the dynamic response has been performed with plane and spatial beam models applying linear and non-linear time history analysis. More 'practical' methods, based on linear superposition principles, such as equivalent static loads or multiple mode response spectrum method have been used for comparison. Time history analyses have been performed by utilizing synthetic acceleration time histories (one and multidimensional), compatible with the governing response spectra. The non-linear elasto-plastic analyses for the severe earthquake situation has been carried out using a single pier model. The advantages for the design by performing a full physical non-linear analysis will be demonstrated. In addition, displacements and rail stresses as well as the influence of the wave-passage effect have been studied by means of an overall dynamic multi-span model, taking into account a non-linear rail-track bond behavior.

INTRODUCTION

International standards require both safety of operation and structural safety of reinforced concrete bridges under two different levels of earthquake intensity. On the one hand, total collapse of the structure has to be avoided in case of the maximum earthquake intensity which has to be expected at the specific site according to probability studies. After the severe earthquake event the structure may exhibit local damage such as plastic hinges. However, this local failure must be repairable. On the other hand, moderate earthquakes exhibiting a higher probability of occurrence shouldn't damage the structure at all. The structure must be designed in a way to resist moderate earthquakes in normal operational system status. Definition of the earthquake intensity level for moderate earthquakes has to be based on risk analysis. The response of the bridge structure must remain within a specified strain

interval. Analysis has to be performed as elastic simulation, probably taking into account the stiffness reduction due to tension cracks in concrete (cracked section analysis).

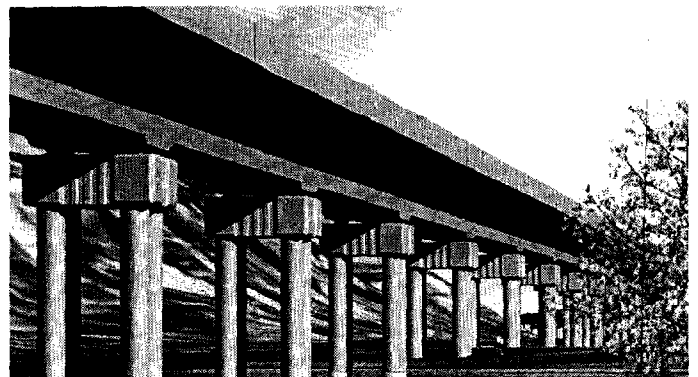

Fig. 1. Computer simulation of the high-speed-train bridges

It is recommended that the definition of an acceptable strain shouldn't be too restrictive in order to avoid that the structural design might be solely governed by too conservative serviceability requirements. Within this context, some modern design concepts propose to limit both crack width and concrete compression to a reasonable level. For example, *Priestly et al. [1996]* allow a maximum crack opening of about 1 mm and a concrete compressive strain of up to 0,004. Depending on the type of bridge structure - reinforced concrete bridges carrying railways or road traffic - additional serviceability requirements have to be considered. Hereby, physical nonlinear simulations performed by the authors have demonstrated that the amount of pier reinforcement is of negligible influence on the maximum displacements of the bridge deck. Accordingly, with respect to the limitation of displacements under serviceability earthquake loads, the limitation of strain is of minor influence.

All necessary parameters for seismic loading are a result of the specific method used. The load intensity for the quasi-static force method and the response spectra methods is governed by the maximum peak ground acceleration (PGA). Both methods are restricted to linear-elastic behavior and neglect duration and time-history of the quake. These two important effects, which have to be taken into account in order to estimate the damage behavior of the structure, can be regarded within direct time integration simulations. In doing so, measured or artificially generated time histories for the ground acceleration can be used as a basis for dynamic analyses.

Load bearing capacity and ductility, defined by the plastic deformations of the reinforced concrete columns are of major influence on the earthquake response of bridges. For example, if a high bearing capacity is provided for the piers, only a reduced ductility demand will be required for the structure in order to resist the design earthquake. Accordingly, piers with limited plastic deformation capabilities have to be designed with appropriate high bearing capacity while viaduct piers being characterized by a ductile load bearing behavior under extreme loading enable the designer to reduce the structural capacity. Using the capacity design of bridge columns the interaction between structural resistance and ductility demand can be considered. Hereby, the amount of reinforcement is chosen in a way to guarantee the development of plastic hinges in case of the severe earthquake only in desired regions of the structure.

Each plastic hinge has to fulfill the requirements for the necessary plastic deformation (ductility check) and requires an appropriate reinforcement design for the highly stressed regions. Therefore, the earthquake design of the reinforced concrete columns has to be performed under the aspect to guarantee the necessary plastic rotational capacity. In order to avoid undesired plastic hinges in other areas, e.g. pile foundations and superstructure, there, structural resistance has to be chosen according to the overstrength capacity resulting from the plastic hinge mechanism. This guarantees the formation of plastic hinges only in desired regions.

The type of reinforced concrete column and the shape are of major impact on the earthquake response, especially in case of a severe earthquake characterized by large maximum ground accelerations. In the following, a standard single column type of pier (cantilever pier) shall be compared with a more sophisticated four column frame-type of pier (multi-bent pier) for the bridge support. Fig. 2.1 shows the cantilever type column, either designed massive or with a hollow box section. Plastic deformation capability for this type of support remains restricted to one plastic hinge at the nadir of the column. Due to the restriction of the allowable damage formation in case of the severe earthquake this column type requires an appropriate amount of stiffness. However, this leads to even higher stiffness requirements for the bridge span and the pile foundation piles in order to confidently exclude the development of plastic hinges in these structural members.

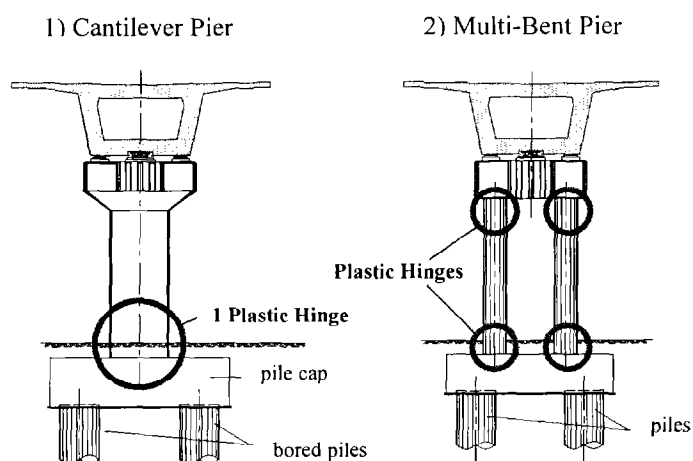

Fig. 2. Plastic hinges for different types of reinforced columns

If we now compare the single cantilever column with the four column multi-bent concept (see Figure 2.2), we can observe fundamental differences in the structural response. Plastic deformations may occur at several locations and therewith a higher amount of ductility for the overall structure is available. Accordingly, a reduced structural resistance has to be provided for the alternative type of pier. In addition, the design forces of construction members being "sheltered" by the overstrength capacity of the hinges will be reduced. Especially in case of soft soil conditions, these reduced requirements can lead to substantial savings in the foundations. However, it should be mentioned that the multi-bent pier tends to be more sensitive with respect to the serviceability requirements. For example, by defining a high intensity for the serviceability earthquake or in case of very conservative strain limitations, serviceability aspects may govern the design of the overall structure and thus, the efficiency of the multi-bent pier will be unnecessarily reduced. A four column type pier has been proposed for the high-speed-train bridges in Taiwan. The following chapters will present results for the dynamic structural response obtained from FE-simulations for this type of substructure.

Investigated Structural Systems

Due to the coupling effect of two neighboring supports being of minor influence in case of a simply supported structure, the simulation has been restricted to an individual four-column support. The discretized system is shown in Fig. 3. Within the first approach the piles have been modeled by linear-elastic translatorial and rotational springs. The effective stiffness of the foundation piles has been determined by applying forces and moments on top of the elastically embedded piles. Stiffness parameters for elastic bedding have been taken from geological surveys, provided by the client.

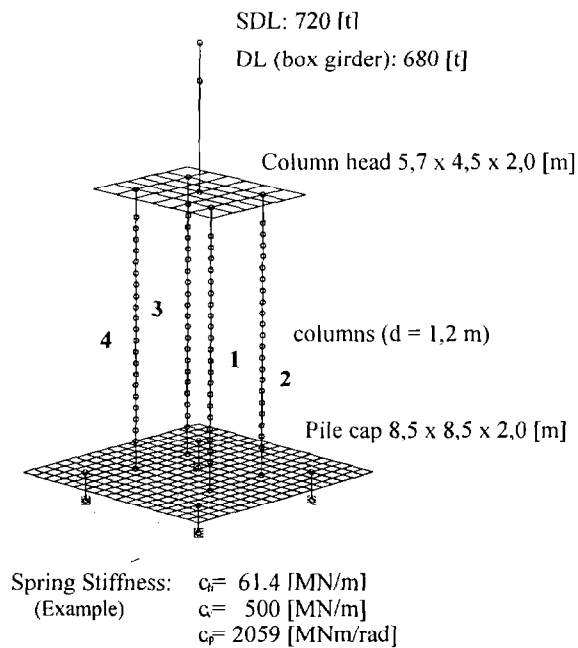

Fig. 3. Discretized four column support system

No additional train mass has been taken into account within the present investigation. Further, the four columns have been connected by shell elements at their top and bottom representing the pile cap and the pier head, respectively. The following dynamic active masses have been considered (s = lever arm of mass to mid-surface of column head):

- $m_{DL} = 680$ tons self weight (DL) of box girder, $s = 2,90$ m
- $m_{SDL} = 720$ tons superimposed dead load (SDL), $s = 4,25$ m

LINEAR MODEL

Eigenfrequencies

First, the eigenfrequencies of the system shown in Fig. 3 have been computed. The first two eigenfrequencies show the first two fundamental bending frequencies with $f_1 = 0,84$ Hz and $f_2 = 0,87$ Hz. The third eigenfrequency with $f_3 = 4,05$ Hz defines

the torsional mode. The first bending eigenmode as well as the torsional eigenmode are presented in Fig. 4 and 5.

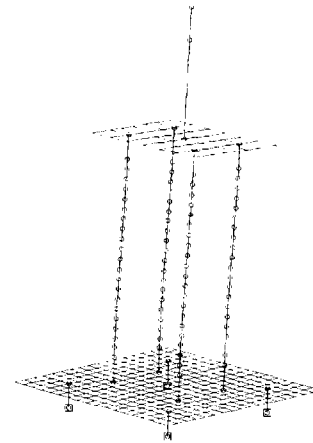

Fig. 4. First Eigenmode, $f_1 = 0,84$ Hz (bending)

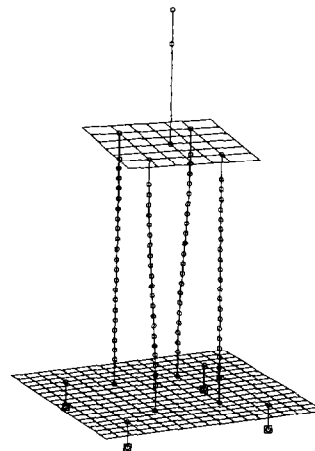

Fig. 5. Third Eigenmode, $f_3 = 4,05$ Hz (torsion)

Response Spectrum Method

The response spectrum for the load case severe earthquake has been chosen depending on the appropriate soil conditions and the seismic zone, by the normalized spectrum in Fig. 6. The spectrum has to be multiplied by a maximum acceleration of $Z_1 = 0,34 \times g = 3,34$ m/sec².

Note: The base ground acceleration of $0,34 \times g$ has been provided within the tender phase of the project. Following the severe Chi-Chi earthquake in Taiwan on 21st of September 1999, both base ground acceleration and response spectra are in a reviewing process and will be modified based on risk and probabilistic analyses.

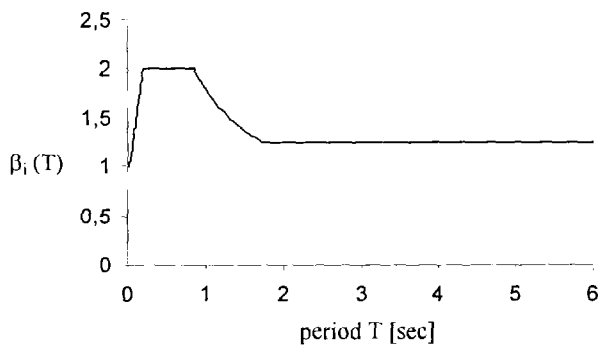

Fig. 6. Normalized response spectrum

The linear response spectra defines the maximum response for deformation, velocity and acceleration of a single mass system with varying eigenfrequency and constant damping.

Assuming linear-elastic system behavior and therewith linear superpo-sition, we can transform every multi-mass system into a sum of single mass systems by a modal analysis, e.g. see *Petersen* [1996] and *Meskouris* [1999]. Each eigenmode i can be described by a modal participation factor

$$\beta_i = \varphi_i^T \mathbf{M} \mathbf{r} \quad (1)$$

with the mass matrix \mathbf{M} , a vector containing the eigenmodes φ_i and a vector \mathbf{r} , defining the nodal displacements of the whole structure for a unit displacement acting in the foundation nodes. Maximum dynamic displacements, velocities and accelerations can be derived with the appropriate response spectra for each individual eigenmode:

$$\begin{aligned} \max \mathbf{V}_i &= \beta_i \mathbf{S}_{d,i} \varphi_i \\ \max \dot{\mathbf{V}}_i &= \beta_i \mathbf{S}_{v,i} \varphi_i \\ \max \ddot{\mathbf{V}}_i &= \beta_i \mathbf{S}_{a,i} \varphi_i \end{aligned} \quad (2)$$

Superposition of the maximum modal responses occurring at different times, can be realized by the square root of sum of squares principle considering all modal contributions (SRSS-rule). The internal reactions (axial-force and bending moment) are represented in Fig. 7 and 8. Here, the CQC superposition has not been adopted since the eigenfrequencies show enough spacing. The earthquake excitation has been applied simultaneously in all three directions.

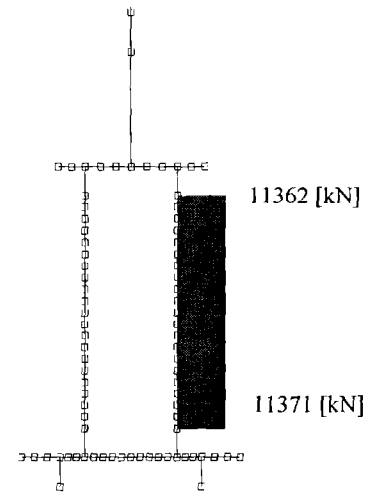

Fig. 7. Axial force in column, response spectrum method

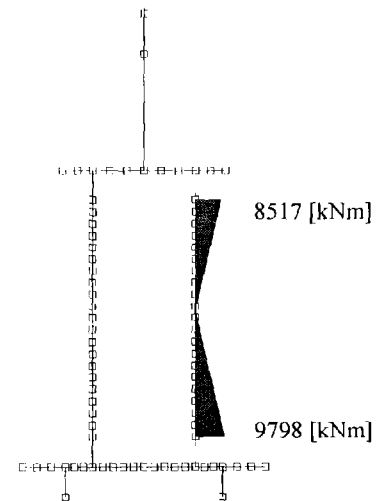

Fig. 8. Bending moment in column, response spectrum method

Direct Time Integration

In order to study the influence of the superposition rule a direct time integration analysis of the structure has been performed. The material behavior has been limited to linear-elastic behavior. An artificial acceleration time history has been generated according to *Meskouris* [1999] based on the response spectrum given in Fig. 6. The dynamic excitation has been applied as ground acceleration to the foundation nodes with all three components – two in horizontal direction and two in vertical direction – being applied simultaneously. Full 100 % horizontal components have been superimposed being combined with applied with 100 % while the vertical component have been scaled to 33 % of the maximum

horizontal acceleration. The time history of the acceleration used can be seen in Fig. 9.

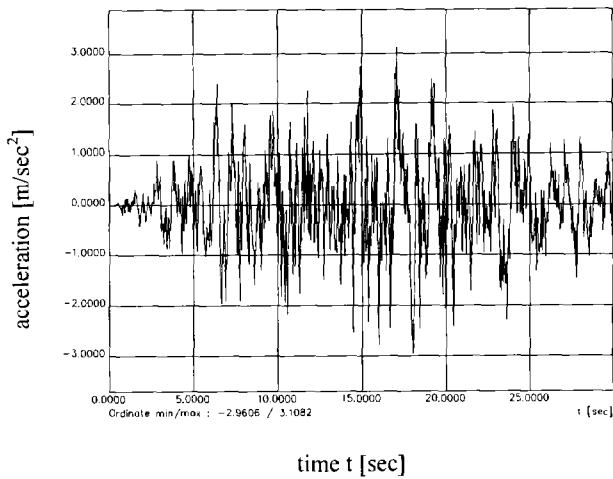

Fig. 9. Artificially generated acceleration time history, (horizontal component)

The structural response demonstrates that the differences compared to the results gained from a response spectrum analysis are negligible. This is because the first fundamental bending modes obviously dominates the structural response. The slight reduction in the maximum internal forces can be explained by the more realistic superposition of the two horizontal components in time. Due to the difference in the first two bending eigenfrequencies (eigenmode 1 for bending in x-direction and eigenmode 2 for bending in y-direction) the maximum response occurs at different times.

Fig. 10 and 11 present the time history of axial force and the bending moment in the nadir of one column.

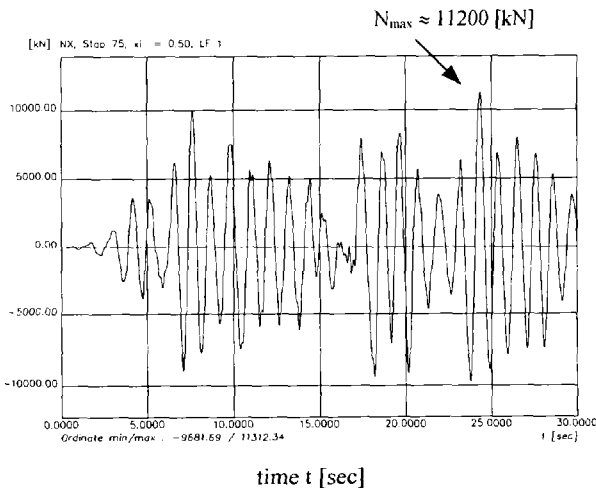

Fig. 10. Axial force N in column nadir, linear direct time integration method

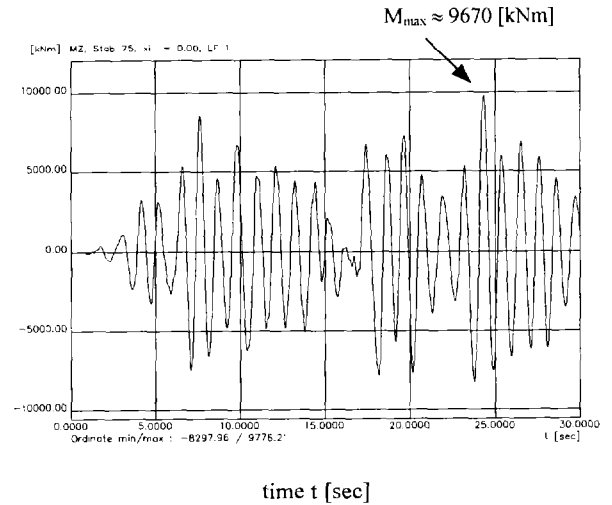

Fig. 11. Bending moment M in column nadir, linear direct time integration method

Multiple-Span System

In order to compute stresses in the track system an 11 span system has been discretized, taking into account the varying height of the columns over a total length of the structure of 350 m. The compression stresses in the track system have to be limited in order to prevent the train from derailing during an earthquake. The 11-span system has been simulated with a direct time integration method, while the system is still founded on linear-elastic springs. The acceleration time histories already used for simulation of the singular columns has been used as excitation on all foundations. All time histories have been applied without time shift.

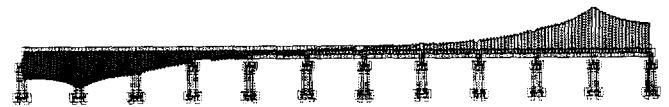

Fig. 12. Longitudinal rail force due to breaking forces

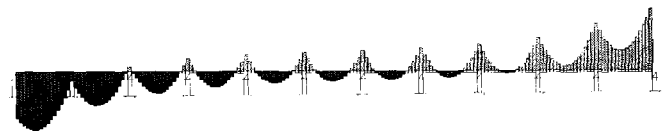

Fig. 13. Longitudinal rail force due to load case temperature



Fig. 14. Longitudinal rail force under serviceability earthquake

Figure 12 to 14 present the axial-force of the track system due to three different load cases: breaking load (Fig. 12), temperature (Fig. 13) and serviceability earthquake (Fig. 14). This system can also be used to study the wave passage effect by applying the acceleration time histories at every foundation with an appropriate time shift.

PHYSICAL NON-LINEAR ANALYSIS

The system should develop plastic hinges at the ends of the columns under load case catastrophic earthquake". In order to prove this nonlinear behavior of the structure a nonlinear simulation of the four column support has been performed. Therefore a fiber model – with 10 fibers per cross section – has been discretized and has been analyzed using the direct time integration method. The reinforcement steel has been modeled as multi-linear elastic plastic and tension cracks as well as plasticity for the concrete has been taken into account.

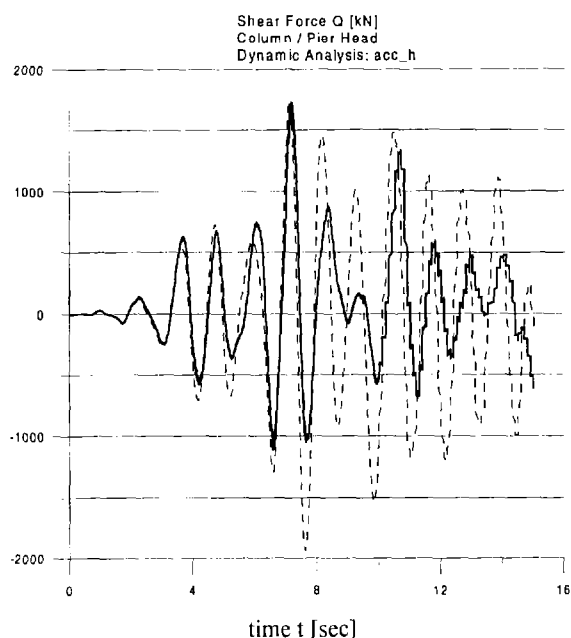

Fig. 15. Shear Force, linear simulation

Figures 15 and 16 present the time histories of the internal shear force in one column using the physical linear material model and the physical nonlinear material model respectively. A reduction of about 15 % percent in maximum internal forces can be observed.

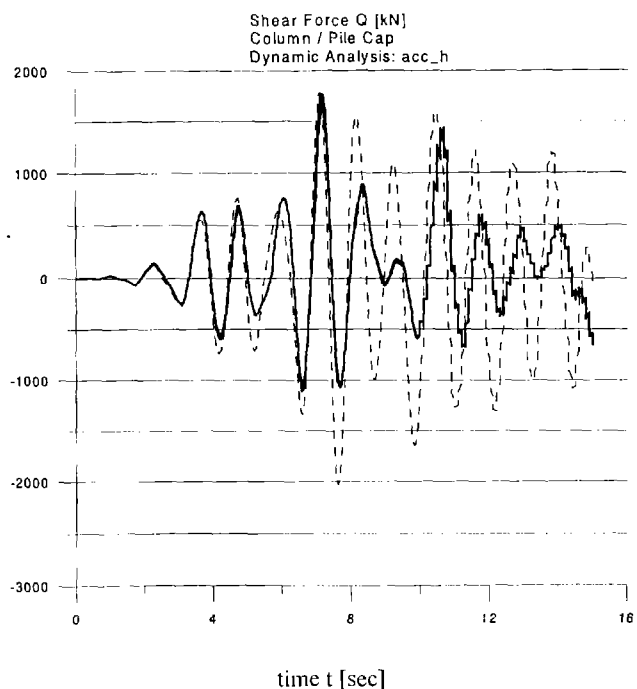

Fig. 16. Shear force, nonlinear simulation

SUMMARY

With regard to seismic strains considerations to the design of a elevated high-speed-railway structure can be based on fundamental thoughts of ductility and structural resistance as well as on efficient FE-simulations. The latter method allows an optimized design. Efficient studies of variants for dynamic loading are possible by applying simplified procedures (response spectrum method) or more precise methods of simulation (direct time integration).

REFERENCES

- Priestley, M.J.N., Seible, F., Calvi, G.M. [1996]. *Seismic Design and Retrofit of Bridges*. Wiley & Sons, New York.
- Petersen, C. [1996]. *Dynamik der Baukonstruktionen*, Braunschweig, Vieweg Verlag.
- Meskouris, K. [1999]. *Baudynamik - Modelle, Methoden, Praxisbeispiele*, Berlin, Verlag Ernst & Sohn.
- Clough, R.W., Penzien, J. [1979] *Dynamic of Structures*. McGraw-Hill Book Company.