



Missouri University of Science and Technology
Scholars' Mine

International Conference on Case Histories in
Geotechnical Engineering

(2013) - Seventh International Conference on
Case Histories in Geotechnical Engineering

02 May 2013, 4:00 pm - 6:00 pm

Failures of Retaining Wall Structures Due to Earthquake

Mohammadreza Abbasi Garavand
University of Science and Culture, Iran

Hamzehlou Bahareh
Petro Kaveh Engineering Company, Iran

Follow this and additional works at: <https://scholarsmine.mst.edu/icchge>

 Part of the [Geotechnical Engineering Commons](#)

Recommended Citation

Garavand, Mohammadreza Abbasi and Bahareh, Hamzehlou, "Failures of Retaining Wall Structures Due to Earthquake" (2013). *International Conference on Case Histories in Geotechnical Engineering*. 21.
<https://scholarsmine.mst.edu/icchge/7icchge/session03/21>

This Article - Conference proceedings is brought to you for free and open access by Scholars' Mine. It has been accepted for inclusion in International Conference on Case Histories in Geotechnical Engineering by an authorized administrator of Scholars' Mine. This work is protected by U. S. Copyright Law. Unauthorized use including reproduction for redistribution requires the permission of the copyright holder. For more information, please contact scholarsmine@mst.edu.

FAILURES OF RETAINING WALL STRUCTURES DUE TO EARTHQUAKE

Mohammadreza Abbasi Garavand
University of Science and Culture
Tehran, P.O. Box: 13145-871, Iran

Hamzehlou Bahareh
Petro Kaveh Engineering Company
Tehran, P.O. Box: 1969743434, Iran

ABSTRACT

This paper describes crack pattern of reinforcement concrete retaining structure due to earthquake. For this reason, the 3-D finite element dynamic analysis of retaining wall structures with consideration of the soil-structure interaction has been used. Purpose of this study is to detect damage zone, due to earthquake in such structures. The analysis data is based on 1995 Kobe and 1994 Northridge earthquake reports, and the results have been verified with some retaining walls were damaged in those earthquakes.

To take into account the non-linearity of soil-structure surface, surface to surface contact element is used. One of the most important problems in dynamic analysis is modeling of infinite media. If hinge or sliding support for soil boundary is used, it would not define an acceptable boundary condition, because the transmitted earthquake waves reflect from the boundary and no energy would transmit out. For simulation of the unbounded nature of the soil medium, viscous (dashpot) boundary has been applied. Damping coefficient is given by Lysmer and Kuhlemeyer, and Drucker Prager soil plasticity model is considered for non-linearity of soil.

Distributions of the amplitude of stress in the wall, crack pattern in concrete wall are discussed in detail and finally suggested flexural failure diagram for determining damage zone and weak point of cantilever retaining wall.

INTRODUCTION

Retaining wall structures are constructed to protect a slope surface when banking or cutting cannot be conducted. They are common in high way and rail way embankments.

All types of retaining walls can be damaged due to earth quake but type of damage may be different according to their constructed material and structure type. Concrete cantilever retaining wall may face any of overturning, sliding and flexural failure.

Damage of retaining walls during the earthquake can be seen in recent large earthquake such as Northridge (1994), Kobe (1995) and Taiwan Chi Chi earthquake (1999), all have made serious damages to retaining wall structure.

This paper discusses about damage zone detection due to earthquake and 3D nonlinear dynamic analysis of retaining wall.

MATERIAL MODEL

In order to material modeling behavior, the models which are exist in finite element program ANSYS are used.

Program ANSYS is capable of handling dedicated numerical models for the non-linear response of concrete under dynamic loading.

Reinforced Concrete Modeling

3D ANSYS element solid65 that has ability of modeling reinforced concrete, used for retaining wall modeling.

these elements include a smeared crack analogy for cracking in tension zones and a plasticity algorithm to account for the Possibility of concrete crushing in compression regions

(ANSYS, 2008).

The SOLID65 element uses a smeared rebar capability, which involves three different rebar materials orientated in any direction relative to the global coordinate system. The rebar was input to replicate the volumetric ratios and orientation of the longitudinal and transverse reinforcement in the wall. (ANSYS, 2008).

Reinforcement concrete properties used in the model are as the following table.

Table 1. Concrete Characteristics

Compression Strength (kg/cm ²)	Mass Density (kN/m ³)	Poisson Ratio	Elasticity Modulus (N/m ²)
300	25	0.18	2.74E10

In this study Bangash curve used for modeling of concrete material in compression. And for modeling of reinforcement we used two linear elastic plastic behavior.

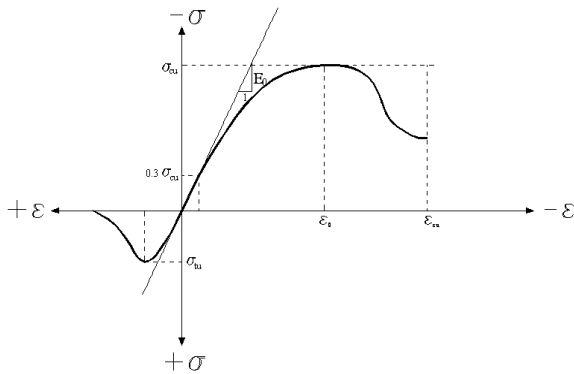

Fig. 1. Stress Strain Diagram of Concrete in Pressure.

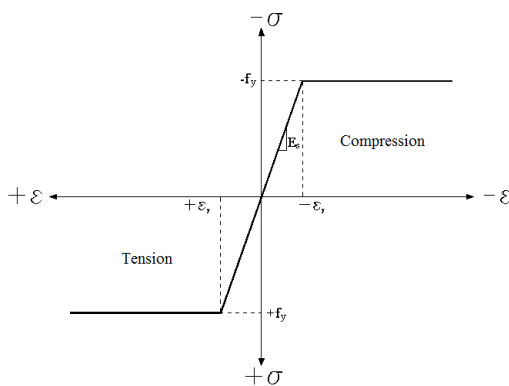

Fig. 2. Elastic Plastic Reinforcement Diagram.

Soil Modeling

In order to modeling of the soil behavior, Draker-Prager model has been used. Draker-Prager model is an estimation of Coulomb law with considering hydrostatic pressure. Draker-Prager yield function is as follow (Chen and Baladi, 1985):

$$F = 3\alpha\sigma_m + \sqrt{j_2'} - k' = 0 \quad (1)$$

In which:

$$\alpha = (2 \sin \varphi) / (\sqrt{3}(3 - \sin \varphi))$$

$$k' = (\sigma_c \sin \varphi) / (\sqrt{3}(3 - \sin \varphi))$$

Where:

c and φ are cohesion and angle of internal friction of soil. σ_c , σ_m and j_2' are matrixes that represented in Chen and Baladi, 1985.

Soil is meshed with 3D solid45 ANSYS element that has 6 freedom degrees in each node (ANSYS, 2008). Elastic plastic soil prosperities that used in modeling are as the following table.

Table 2. Soil Characteristics

Cohesion	Internal Friction Angle (Degree)	Dilatancy Angle (Degree)	Mass Density (kN/m ³)	Poisson Ratio	Elasticity Modulus (N/m ²)
0	30	3	18	0.30	1.00E10

Reinforcement Modeling

Residual behaviors of concrete structure directly depend on residual behavior of reinforcement. To do the exact analysis, appropriate numerical model should be considered for reinforced concrete. Choosing the numerical model can affect on dynamic analysis which is used where dynamic forces like earthquake exist.

Residual erosion model, describes resistance properties can be calibrate with uniaxial test on reinforcement.

Staggered behavior model of stress-strain reinforcement curve can be dividing to two groups:

1- Immense models that are based on measuring relating between stress and strain.

2- Fine models that are based on displacement theory.

Fine models are concluded from simple theories but are such complicated that cannot be used in nonlinear analysis for large structures. In other way immense models are simpler but they are unable to consider some residual behavior (Okamura and Maekawa, 1991).

THREE DIMENSIONAL RETAINING WALLS MODEL

Taking advantage of symmetry and anti symmetry only one fourth of the actual length of model was built in finite element software package ANSYS 11.

Eight node hexahedral elements with three transitional degrees of freedom at each node are used here.

The eight node element and finite element quarter model are used for retaining wall–soil system.

In order to modeling the concrete behavior of retaining wall, solid65 element and also for simulation of soil properties solid45 ANSYS element used.

Geometry of model based on actual retaining wall, was built, 65 years before Kobe earthquake in Shin-Nagata. This wall has 200m length and damaged in Kobe earthquake.

Dimensions of the wall and also the ANSYS finite element model are shown in following figures. On ANSYS modeling retaining wall modeled only between expansion joints.

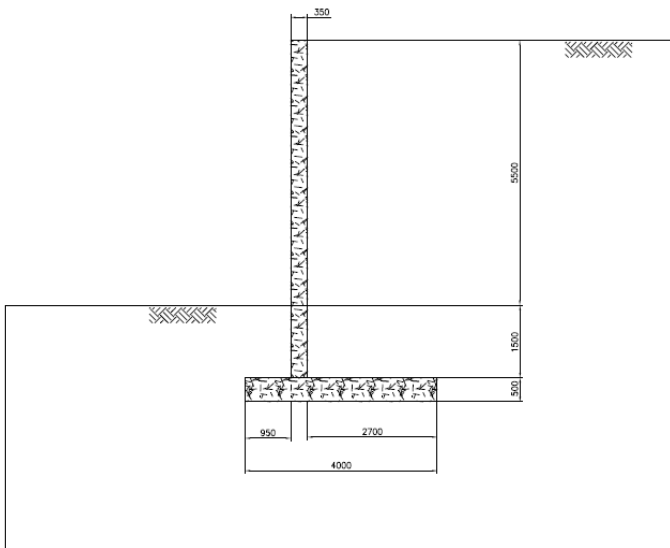

Fig. 3. Geometry of Retaining Wall.

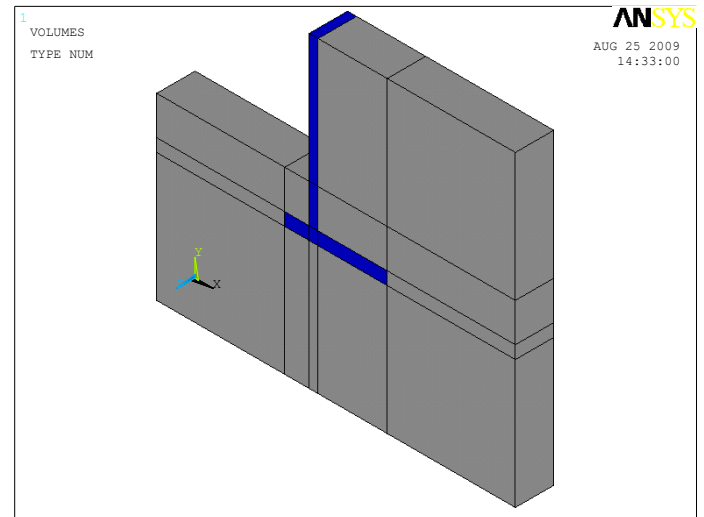

Fig. 4. ANSYS Finite Element Models.

BOUNDARY CONDITION

Infinite media modeling is one of the important problems in soil-structures dynamic analysis.

If hinge or sliding support for soil boundary has been used in finite element method, it would not define an acceptable boundary condition, because the transmitted earthquake wave reflects from the boundary and no energy would transmit out.

For simulation of the unbounded nature of the soil medium, two types of boundaries have been applied and the corresponding responses have been compared (Lysmer and Kuhlemeyer, 1969).

These boundaries are:

- Viscous (dashpot) boundary: viscous dampers are attached on the side face of the model. At a particular node where viscous dampers are attached, damping coefficients in normal and perpendicular directions are given by Lysmer and Kuhlemeyer (1969).
- Kelvin element (spring and dashpot) boundary: Kelvin elements are also used at the boundary. The stiffness and damping constant of the Kelvin element has been evaluated based on the solution developed by Novak and Mitwally (1988). Viscous and Kelvin element boundaries are shown in figure 5.



Fig. 5. Viscous and Kelvin Element Boundaries.

In this study we used Kelvin element as boundary condition.

ADEQUACY OF ANSYS FOR DYNAMIC ANALYSIS

ANSYS is a general purpose structural analysis program which has the capability to perform nonlinear time history analysis. This program uses displacement time history of earthquake as dynamic load.

In this study, for simulation correct earthquake condition, displacement time history of earthquake on down boundary of soil model is applied.

With ANSYS transient analysis result with displacement time histories could be reliable to study nonlinear response of structure under earthquake load.

The ANSYS program uses 3 methods to transient dynamic analysis; i.e. (1) full method, (2) reduced method and (3) superposition method (ANSYS, 2008).

Full method program create complete matrix and calculating response. This method is a powerful method compared with the other two methods since that full method has the capability to consider nonlinearity property such as plasticity, large deformation and etc. So in this study we used full method for dynamic transient analysis (ANSYS, 2008).

SEISMIC LOADING

Actual load of three great mentioned earthquakes, i.e. Kobe, Northridge and Chichi, with displacement time history are applied. These earthquakes are selected between other earthquakes. Displacement and acceleration time history of these earthquakes is shown in figures 6 and 7.

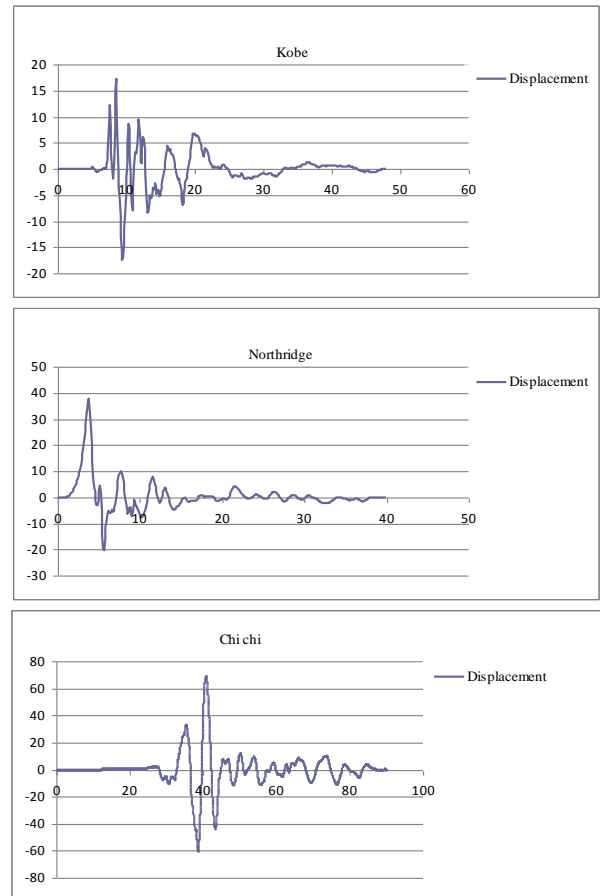
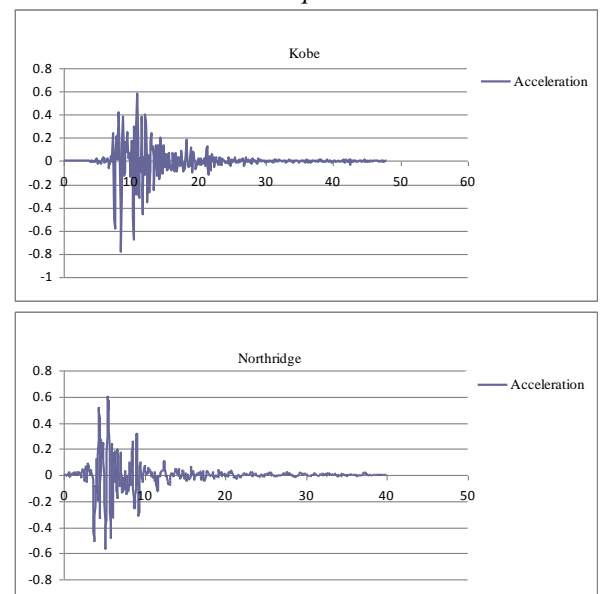

Fig. 6. Displacement of Kobe, Northridge and Chi chi Earthquakes.



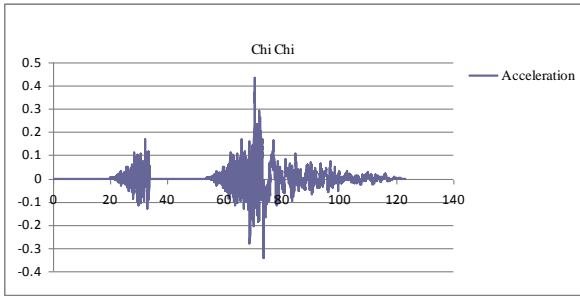

Fig. 7. Acceleration Time History of Kobe, Northridge and Chi chi Earthquakes.

Table 3 also shows these earthquake properties.

Table 3. Earthquake Properties of Kobe, Northridge and Chi chi.

	Kobe	Northridge	Chi chi
PGA	0.789	0.690	0.439
PGV (cm/Sec)	80	90	120
PGD (cm)	17	39	71

FINITE ELEMENT MODELING OF CRACK

Many models have been developed to represent cracking during finite element analysis of a reinforced concrete member. Two main approaches are common for a representative analysis, the discrete crack and smeared crack approach and the use of joint or interface elements.

The discrete crack approach requires monitoring the response and modifying the topology of the finite element mesh corresponding to the current crack configurations at each state of loading. Discrete crack models explicitly represent crack as a separation of nodes and the node is redefined as two nodes. Having many cracks leads to many degrees of freedom and the mesh topology of the problem may have to be changed significantly to cope with new crack patterns. Therefore the discrete crack approach may not be the best choice for problems with many cracks, like in reinforced concrete elements. These problems can mostly be avoided in the smeared crack approach, which models cracks and joints in an average sense by appropriately modifying material properties at the integration points of regular finite elements. The formation of a crack involves no remeshing or new degrees of freedom. However they have limited ability to model sharp discontinuities and represent the topology or material behavior in the vicinity of the crack. The smeared crack approach works best when cracks to be modeled are themselves smeared out, as in reinforced concrete applications.

CRACKS

Cracking should be limited to a level that will not impair the proper functioning of the structure or cause its appearance to be unacceptable, it is also important from the aesthetic view to control the cracking. Concrete cracks early in its loading history. Most cracks are results from the following actions.

1. Volumetric change caused by plastic shrinkage or expansive chemical reactions with in hardened concrete, creep and thermal stresses.
2. Stress because of bending, shear or other moments caused by transverse loads.
3. Direct stress due to applied loads or reactions or internal stresses due to continuity, reversible fatigue load, long-term deflection, environmental effects or differential movements in structural system.

CRACKS PATTERN RESULTS OF DYNAMIC ANALYSIS

The cracking patterns in the wall can be obtained by using the Crack/Crushing plot option in ANSYS. The concrete crack/crush plots were examined to see the different types of cracking that occurs within the concrete. Two types of concrete failure occur, compression failure (crushing) and tension cracks. The compression failure is shown as circles and tension cracks as lines that form diagonally up the wall towards the loading that is applied. The two signs of the concrete failure in ANSYS are shown in Fig. 8.

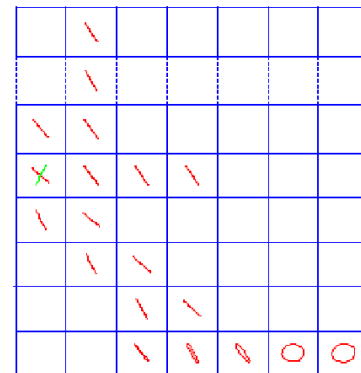

Fig. 8. Cracking signs in ANSYS.

The crack pattern of Northridge, Kobe and Chi Chi earthquake are in Fig. 9 to Fig. 11

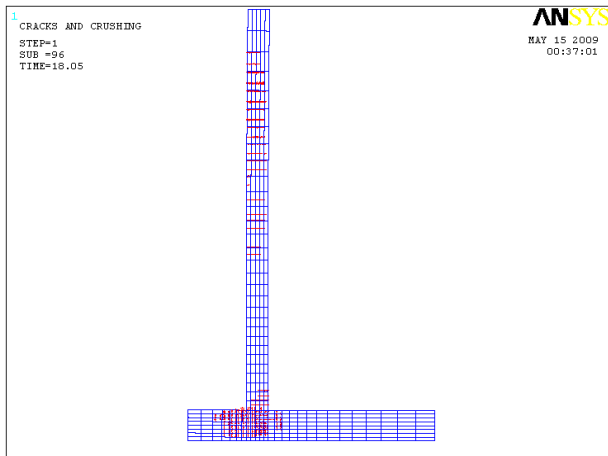

Fig. 9. Crack pattern during Kobe Earthquake.

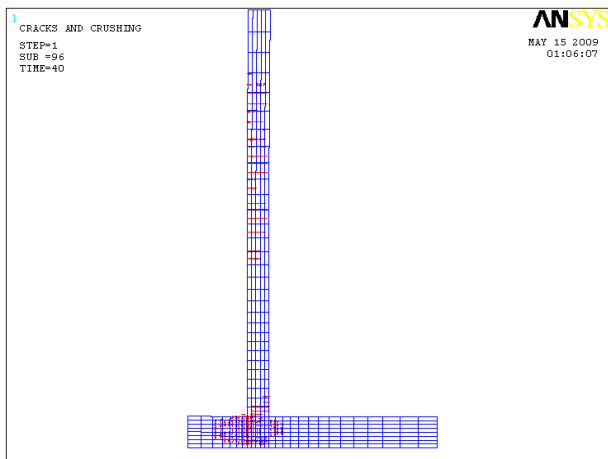

Fig. 10. Crack pattern during Northridge Earthquake.

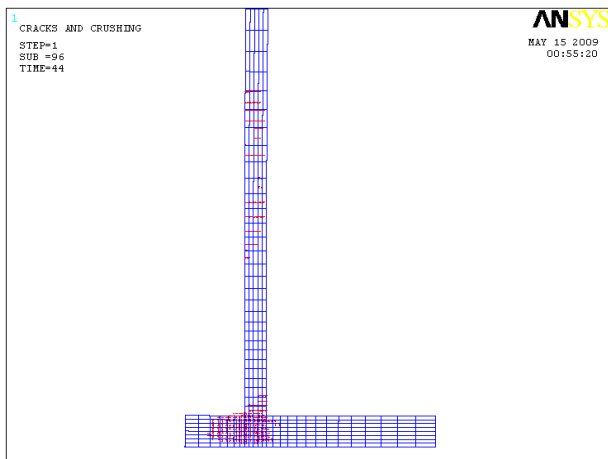

Fig. 11. Crack pattern during Chi Chi Earthquake.

STRESS DISTRIBUTION RESULTS

In order to review the stress distribution in cantilevers wall following plot result have been obtain from ANSYS.

Fig. 12 to Fig. 14 presents the stress distribution in concrete wall, Stress concentration in each model are Significant.

Stress is concentrated in connection between wall and footing.

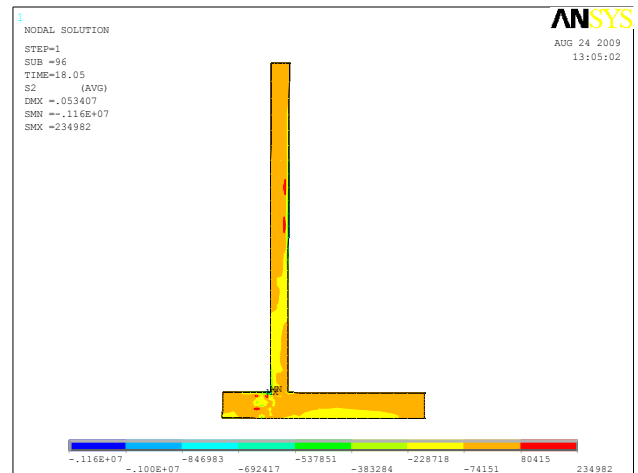

Fig. 12. Stress distibution during Kobe Earthquake.

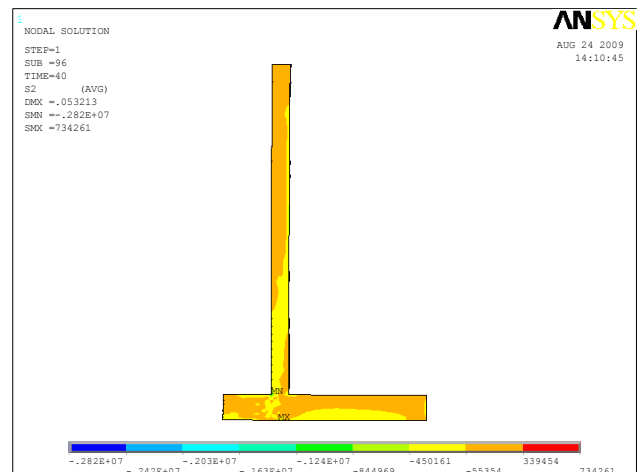

Fig. 13. Stress distibution during Northridge Earthquake.

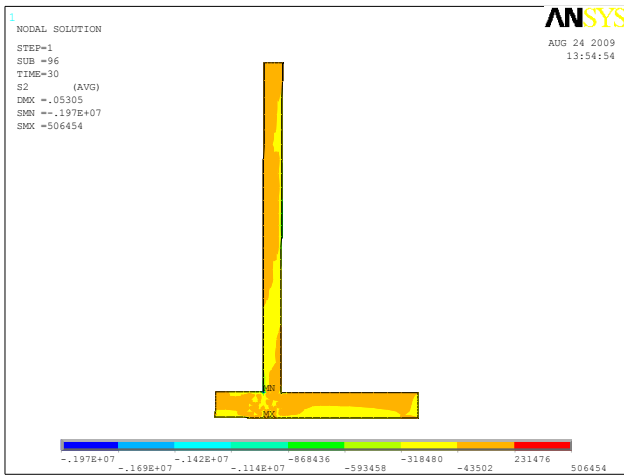

Fig. 14. Stress distribution during Chi Chi Earthquake.

SUGGESTION OF FLEXURAL FAILURE DIAGRAM

According to result data from analysis and crack pattern obtained from ANSYS, the authors suggested flexural failure diagram.

This diagram shows the weak zone of retaining wall base on nonlinear dynamic analysis.

Fig. 15 present the flexural failure diagram, in this diagram the area that marked in blue is damaged zone in Kobe, Northridge and Chi Chi earthquake.

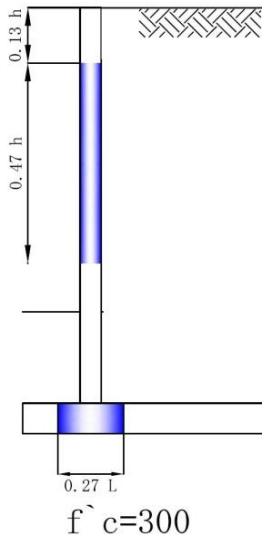

Fig. 15. Flexural failure diagram.

CONCLUSION

In general the collapse mode of reinforcement concrete Cantilever retaining walls are flexural failure.

Wall damage result of soil forces effect on structure in earthquake, which lead to cracking and finally crashing of the structure.

Appearance cracks in the wall are in two categories, first one is flexural and tension cracks that appear in wall and second is compression and flexural cracks that appear in the foundation.

It seems that in damaged detected zone (Fig. 15), the cantilever retaining wall should be reinforced with FRP or similar method and if the wall is in design stage, the designer can improve the steel bar arrangement and size bar in mentioned zone of wall.

REFERENCES

- Chopra, A.K. [1995]. “*Dynamic of Structures-Theory and Applications to Earthquake Engineering*”. Prentice Hall, Englewood Cliffs, New Jersey.
- Gazetas, G. [1984]. “Seismic Response of End-bearing Single Piles”, *Soil Dyn. and Earthquake Engrg.*, No. 3, pp. 82-93.
- Gazetas, G. [1991]. “Foundation Vibrations”, in *Foundation Engineering Handbook*, (H.Y. Fang, ed.) Van Nostrand Reinhold, New York, NY, pp. 553-593.
- Prakash, S., Y. Wu and E.A. Rafnsson [1995a], “On Seismic Design Displacements of Rigid Retaining Walls”, *Proc. Third Intern. Conf. on Recent Adv. in Geo. Erthq. Engrg. and Soil Dyn.*, St. Louis, MO, Vol., III, pp. 1183-1192.
- Prakash, S., Y. Wu and E.A. Rafnsson [1995b], “*Displacement Based Aseismic Design Charts for Rigid Walls*”, Shamsheer Prakash Foundation, Rolla, MO.
- Nanakorn, P. and Soparat, P [2000], “Finite Element Analysis of Cracking Localization The Smeared Crack Approach with a Mixed Formulation”, *Thammasat International Journal of Science and Technology*, Vol. 5, No. 3, pp. 28-39, 2000.