



Novel magnetic composites based on water soluble unsaturated polyester resin and iron oxide nanoparticles

Petar Velev, Rayna Bryaskova

University of Chemical Technology and Metallurgy, Bulgaria

p_velev@uctm.edu, rbryaskova@uctm.edu

ABSTRACT. Magnetic nanocomposites on the basis of water soluble unsaturated polyester resin filled with different amount of iron oxide nanoparticles have been successfully prepared. The mechanical properties of thus prepared composites as tensile, impact and flexural strength were determined. The specific volume and surface resistance of the magnetic nanocomposites were also determined.

KEYWORDS. Magnetic Nanoparticles; Unsaturated Polyester Resin; Copolymerization; Mechanical Properties; Surface Resistance.

INTRODUCTION

Recently, great scientific and technological interest has been paid to the magnetic nanoparticles because of their unique properties and various applications [1-6]. They can be synthesized using different methods such as microemulsion [7], sol-gel synthesis [8], sonochemical reactions [9], hydrolysis [10] and thermolysis [11]. These methods are used for preparation of particles with homogeneous composition.

The synthesis of magnetic nanoparticles is a complex process because of their colloidal nature. The first challenge consists in the determination of the experimental conditions leading to formation of uniform magnetic nanoparticles with appropriate size [12]. The second critical point is the choice of reproductive process, which can be industrialized without any additional purification procedures such as ultracentrifugation [13] or magnetic filtration [14-16]. The most used methods for the synthesis of magnetic nanoparticles is precipitation of iron salts. The production of magnetic nanoparticles in aqueous solutions is very perspective, environmental friendly process and possesses numerous advantages.

It is well known that unsaturated polyester resins are a solution of unsaturated oligomers in monomer (usually styrene) which are able to copolymerize. This combination possesses a good complex of properties as relatively low viscosity, and easy and complete copolymerization after addition of initiator which makes them very suitable for different processing methods. It is established that the resin easily forms emulsion with water after alkalifying of the medium with ammonia in the range from 1.8% to 5.2% under simple stirring. The obtained emulsion is stable enough with the time in order to undergo various technological processes. It is known the preparation of suspension copolymerization of unsaturated resins with styrene and acrylonitrile using a redox system consisting of metylketohydroperoxide and cobalt naphthenate [17].

The aim of this investigation is the preparation of magnetic nanocomposites on the basis of water soluble unsaturated polyester resin and aqueous solution of magnetic nanoparticles without using of any surfactant. There are not data in the literature concerning the preparation of such water soluble unsaturated polyester resins filled with magnetic nanoparticles. The mechanical properties of the prepared magnetic nanocomposites will be investigated as well.

EXPERIMENTAL PART

Materials and methods.

Materials:

Unsaturated polyester resins VIAPAL VUP 4627 BEMT/56 (CYTEC, Germany), containing 44% styrene, which is previously accelerated. Cyclohexanoneperoxide (PEROXIMON K 41) Ammonia-25% solution, FeCl_2 (Acrosorganics) and FeCl_3 (Acrosorganics) have been used without purification as received.

Methods:

The average hydrodynamic diameter of the magnetic nanoparticles is determined using Dynamic Light Scattering (DLS) - Malvern CGS-3 equipped with He-Ne laser with wave number 623,8 nm at temperature 25°C and angle 90°.

The concentration of the iron in the hydrosol of $\gamma\text{Fe}_2\text{O}_3$ of 9600 $\mu\text{g}/\text{ml}$ is determined by atomic absorption analysis (AAA) using Perkin – Elmer spectrophotometer.

The composite materials are investigated with the aid of the following methods:

- Tensile strength - EN ISO 527 – 1,2 : 1996;
- Impact strength - EN ISO 179 : 1993;
- Flexural strength - EN ISO 178 : 1996;
- Determination of specific volume and surface resistance [18];

Relatively density and degree of swelling (weight and volume) in acetone

Synthesis

Synthesis of hydrosol of $\gamma\text{Fe}_2\text{O}_3$.

Magnetic nanoparticles are prepared according to reference [19]. Briefly, 0.85 ml of 12,1 M HCl and 25 ml degassed water are mixed with 5.2 g FeCl_3 and 2 g FeCl_2 . The molar ration of Fe^{2+} and Fe^{3+} was $\text{Fe}^{2+}/\text{Fe}^{3+}=0.5$ at $\text{pH}=11-12$. Thus prepared mixture is added dropwise into 250 ml 1.5 M NaOH solution under vigorous stirring. The last stage consists in the formation of black precipitate. The precipitate is collected in magnetic fields and added to degassed water followed by centrifugation (three times for 1 min) at 4000 rpm. After this purification, 500 ml 0.01M HCl is added to the precipitate in order to neutralized the anionic charge of the particles. The cationic colloidal nanoparticles are separated again by centrifuging and they are peptized with addition of water. The result is a clear, transparent colloid (hydrosol). The oxidation of Fe_3O_4 to $\gamma\text{Fe}_2\text{O}_3$ is based in the change in the pH of the hydrosol of Fe_3O_4 to $\text{pH}=3,5$. The transparent hydrosol is stirred for 30 min at 100 °C under air. The color of the solution is changed from red to brown red. This solution is cooled to room temperature and the upper layer is collected after centrifugation for 30 min at 4000 rpm. The obtained transparent brown-red layer is a hydrosol of $\gamma\text{Fe}_2\text{O}_3$ nanoparticles.

Copolymerization of unsaturated polyester resin

The method of preparation is described in references [17, 20]. The unsaturated polyester resin is placed in a reactor where is tempered at appropriate initial temperature. Then the initiator is added and the time of copolymerization is accounted as the reaction mixture is stirred during 30 sec. To determine the time and the maximum reached copolymerization temperature of unsaturated polyester resin at different initiator concentrations is used equipment shown in Fig. 1.

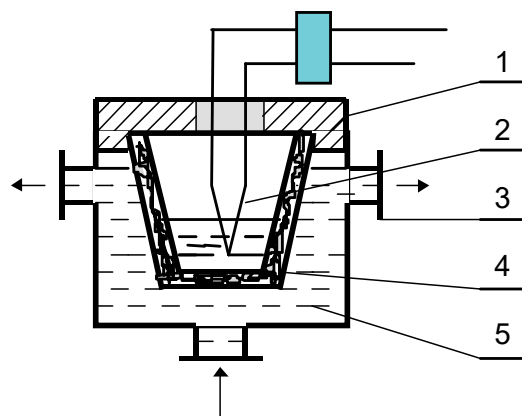

Figure 1: Scheme of the reactor used to study the copolymerization process: 1-lid; 2-thermocouple; 3 – orifice for the tempered fluid; 4- vessel for the investigated resin; 5 – circulating fluid.

Preparation of magnetic nanocomposites.

The polymer composites are prepared manually by mixing of the diluted with water unsaturated resin and hydrosol of $\gamma\text{Fe}_2\text{O}_3$ nanoparticles applying different concentrations. The sum of the added water and nanoparticles solution is equal and corresponds to degree of filling 0.5%.

RESULTS AND DISCUSSION

It is well known that maleic, respectively fumaric bonds in the unsaturated polyester resins are not able to homopolymerize. In the presence of another unsaturated monomer, copolymerization takes place and the molecules of the unsaturated polyester resins have been cross-linked (bonded molecularly by the second monomer). Styrene and, more seldom other vinyl monomers are used most often for this purpose [21].

In this investigation, unsaturated polyester resin containing 44% styrene was used. Initially, the copolymerization of the unsaturated polyester resin containing 44% styrene was performed using different amount of initiator in order to determine the time for reaching the optimal copolymerization temperature during the process (Fig. 2). It was established that during the copolymerization reaction, the increased amount of initiator lead to higher reaction temperatures reached at shorter times. The same dependence was established for the change of adiabatic temperatures with the time (Fig. 3). On the base of these results, the initiator concentration of 2 wt.% (or 0,4 g for 20 g resin) was chosen as an optimal concentration for the copolymerization process.

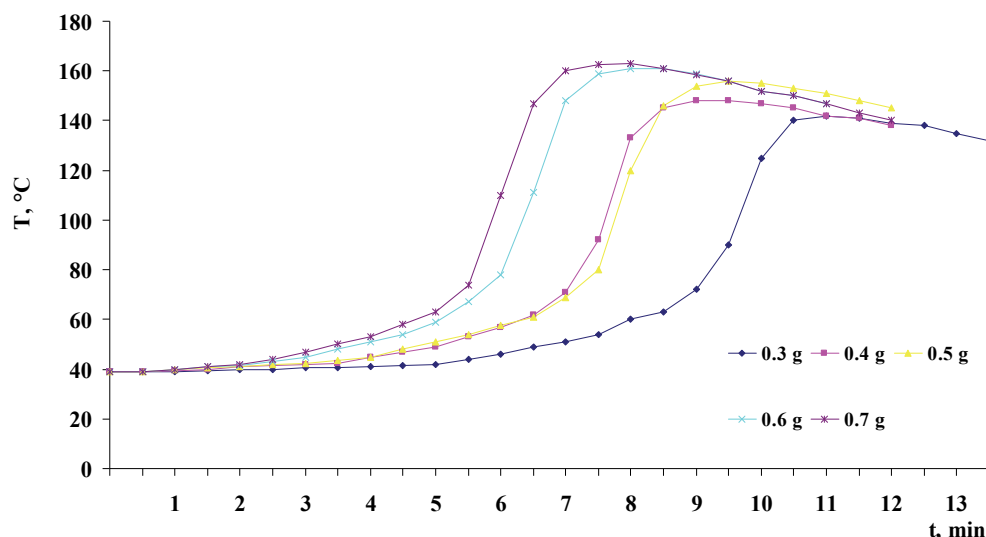
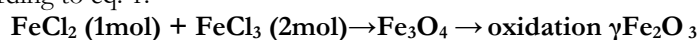

Figure 2: Dependence on the reaction temperature with the time for the copolymerization of unsaturated polyester resin with different amount of initiator.

The examination on the extracted substances and swelling in resin solvent showed that regardless of the way in which it is heated and cooled, the reaction does not complete. The copolymerization processes proceeded slowly. Therefore after reaching of $T_{\text{exp}}^{\text{max}}$, the sample is transferred to the thermostat at temperature equal to the temperature $T_{\text{exp}}^{\text{max}}$.

After heating for 1 hour, the sample is placed in the reactor and the rate with which the temperature decreased is measured (Fig. 3). It was established that after one hour of keeping the maximum temperature, the copolymerization process is completed. The extracted substances are decreased until the minimum values – under 4%, and the swelling in ethyl acetate decreased below 2.3%.

To prepare magnetic nanocomposites on the basis of unsaturated polyester resin Fe_2O_3 nanoparticles are synthesized according to eq. 1:



The synthesized Fe_2O_3 nanoparticles used as filler to prepare magnetic nanocomposites possess an average hydrodynamic diameter (D_h) of 60 ± 0.7 nm at particles size distribution (PDI) of 0.38 as measured by DLS (Fig. 4).

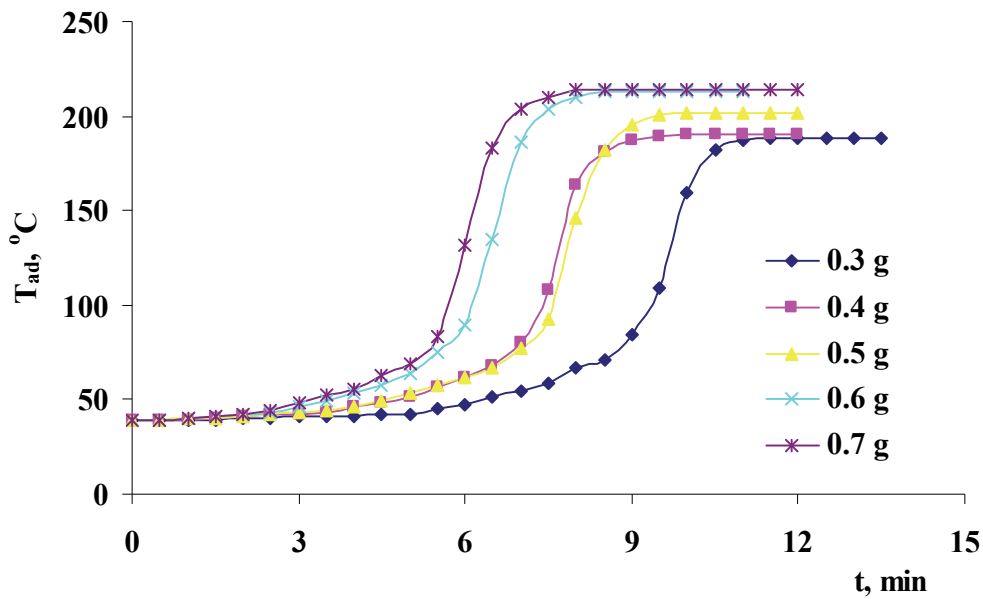

Figure 3: Changes of adiabatic temperatures with the time depending on the initiator concentration.

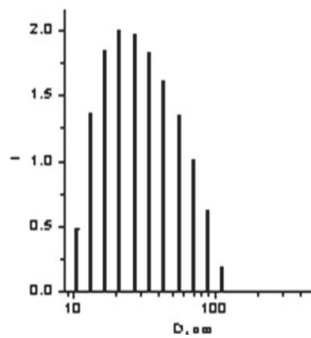

Figure 4: Average hydrodynamic diameter and particles size distribution of aqueous solution of $\gamma\text{Fe}_2\text{O}_3$ nanoparticles.

The observed broader polydispersity of the nanoparticles could be due to some nanoparticles aggregation. Further, different amounts of filler are added to the water alkaline solution of the resin thus obtaining following composites which are tested for their mechanical properties such as tensile, impact and flexural strength (Tab. 1).

No	UPER. g	Hydrosol of nanoparticles. ml	Water. ml	Content of magnetic nanoparticles. %
1	50	0	26	0
2	50	5.25	20.75	0.1
3	50	15.75	10.25	0.3
4	50	26	0	0.5

Table 1: Content of the used magnetic composites

The tensile strength (Fig. 5) decreases slightly with increasing the amount of magnetic nanoparticles in the resin as the obtained data are not significantly changed depending on the magnetic nanoparticles content.

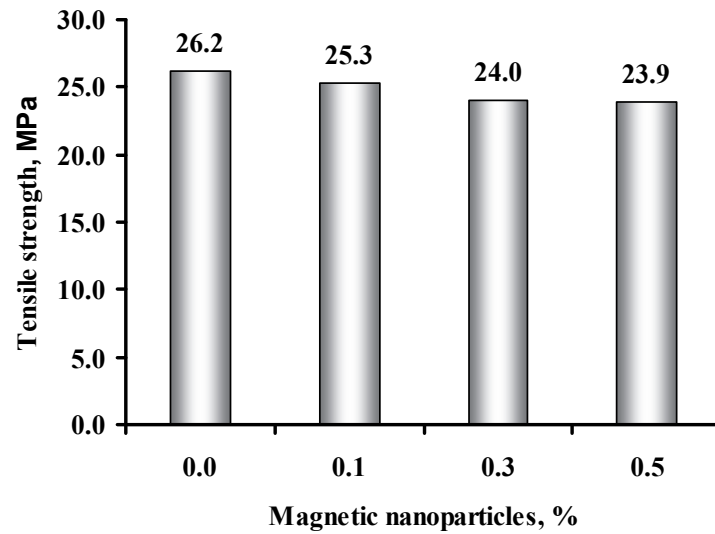

Figure 5: Tensile strength of magnetic composites with different content of magnetic nanoparticles.

The results for impact strength of the magnetic nanocomposites depending on the magnetic nanoparticles contents are presented in Fig. 6.

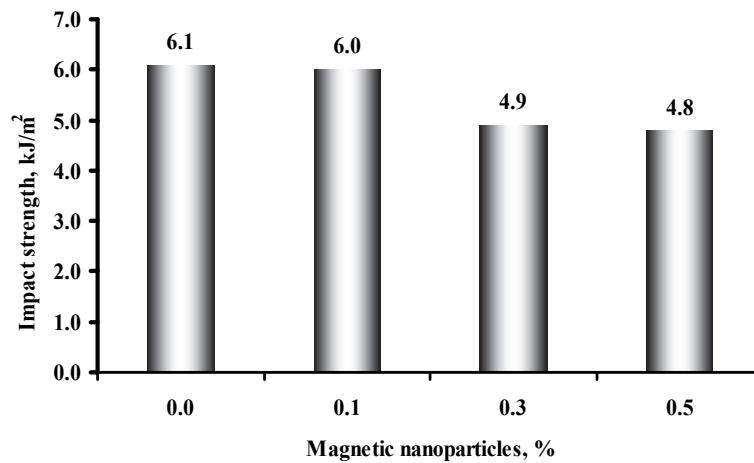

Figure 6: Impact strength of magnetic composites with different content of magnetic nanoparticles.

The increased content of magnetic nanoparticles in the composites leads to decreasing of the values for the impact strength. The lowest value (4.8 kJ/m²) is obtained for the composites containing higher amount of magnetic nanoparticles - 0.5% .

The results of magnetic composites for flexural strength are presented in Fig. 7.

The results for flexural strength showed insignificant change in dependence on the magnetic nanoparticles content. The best results are obtained for the samples containing 0.1% nanoparticles (0.33MPa) and the lowest (0.23MPa) for the samples containing 0.5%.

Tab. 2 presents the results for the specific volume ρ_v [$\Omega \cdot m$] and surface ρ_s [Ω] resistance. The increased amount of the magnetic nanoparticles in the composites leads to some decreasing of the specific volume and surface resistance. This trend allows the preparation and design of magnetic composites with desired conductivity.

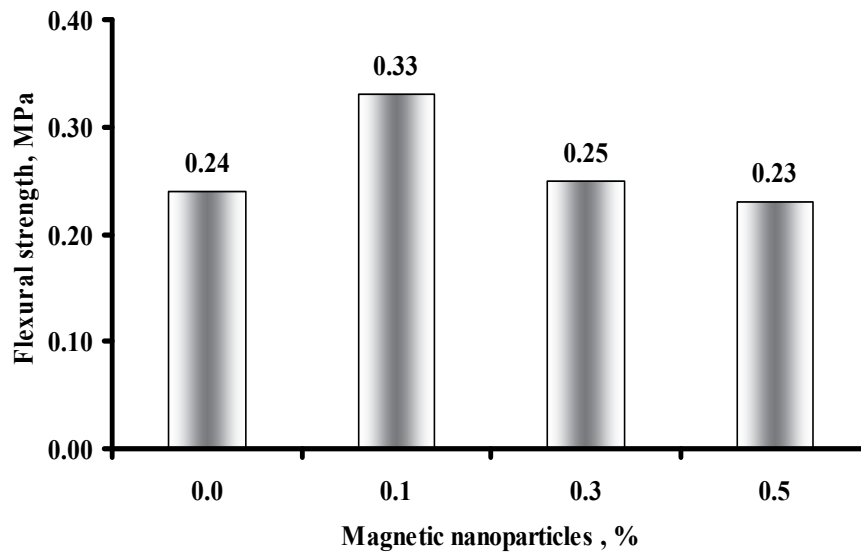

Figure 7. Flexural strength of magnetic composites in dependence on the filler content in %.

Magnetic nanoparticles content %	ρ_v , [$\Omega \cdot m$]	ρ_s , [Ω]
0	$1.0 \cdot 10^{12}$	$4.5 \cdot 10^{14}$
0.1	$0.82 \cdot 10^{11}$	$2.0 \cdot 10^{13}$
0.3	$0.42 \cdot 10^{11}$	$1.5 \cdot 10^{13}$
0.5	$0.35 \cdot 10^{11}$	$1.0 \cdot 10^{13}$

Table 2: Variation of ρ_v and ρ_s in dependence on the magnetic nanoparticles content

The obtained values for the density of the magnetic composites are presented in Tab. 3.

Magnetic nanoparticle content, %	Density, g/cm^3
0	1.21
0.1	1.14
0.3	0.82
0.5	0.98

Table 3: Density of magnetic composite in dependence on the amount of the filler

As seen the density of the polymer composites decreases with increasing the amount of the magnetic nanoparticles content. The decreased density showed that probably there are some gas formations in the resins. The observed lower values of the some physico-mechanical properties in the magnetic composites in comparison to the pure resin is probably due to the detected decreased density in the composites with increasing the amount of magnetic nanoparticles content. The higher mechanical strength possesses the pure resin and the composite containing 0.1% magnetic nanoparticles. The pH nanoparticles solution is 3.5. Since the hydrolysis of UPER has to be conducted at pH 8, the amount of NH_4OH which has to be added to the mixture has to be increased in order to reach the desired alkalinity of the solution with the increasing concentration of magnetic nanoparticles. The neutralization process probably provokes the gas formations in the composites. This state is confirmed from the results for the degree of weight (Fig. 8) and volume (Fig. 9) swelling of the polymer composites.

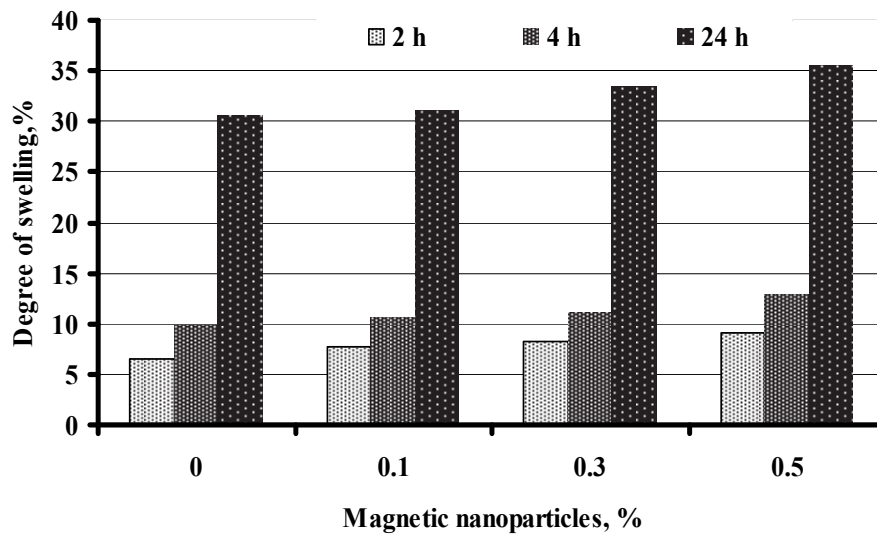

Figure 8: Changes of degree of swelling (weight) in dependence on the amount of magnetic nanoparticles.

The degree of weight swelling is increased with increasing the amount of magnetic nanoparticles in the magnetic composites. This increasing of the degree of swelling proves the presence of pores in the samples.

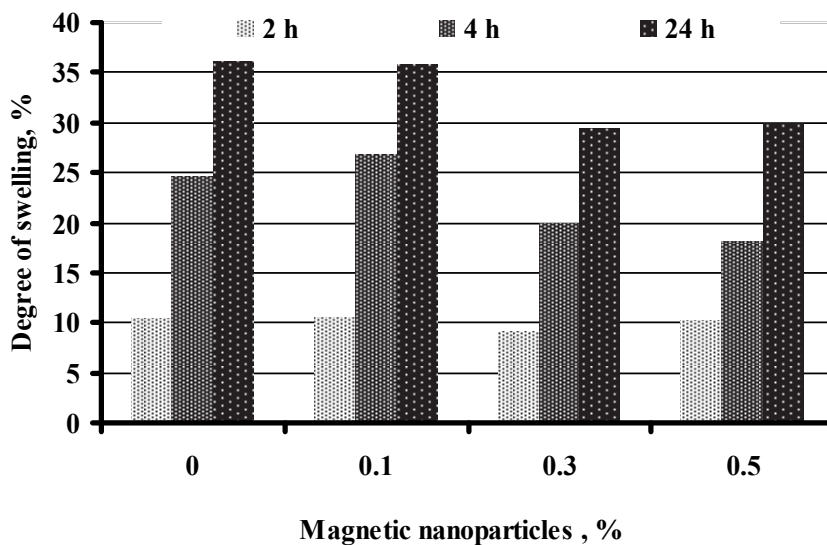

Figure 9: Changes of degree of swelling (volume) in dependence on the amount of magnetic nanoparticles.

As seen from the figure, degree of volume swelling decreases irregularly with the introduction of magnetic nanoparticles. The degree of swelling is higher at the samples without magnetic nanoparticles.

The weight of the samples containing higher amount of magnetic nanoparticles increases and the volume of the samples decreases when staying in a solvent (acetone) for 24h. It can be concluded that the higher amount of the magnetic nanoparticles in the composites does not disturb the crosslinking process of the resin but the prepared magnetic composites posses higher amount of open and closed pores in which enters higher amount of solution. Therefore, the density of the polymer composites decreased with increasing the amount of the magnetic nanoparticles (Tab. 3).



CONCLUSIONS

The nanocomposites on the basis of diluted with water unsaturated polyester resin containing magnetic nanoparticles with concentration ranging from 0.1% to 0.5% were successful prepared. It was established that the increased concentration of the magnetic nanoparticles leads to decreased mechanical properties of the composites due to the formation of micropore structure. As expected the specific volume and surface resistance of the composites is changed with increasing the amount of magnetic nanoparticles in the composites.

REFERENCES

- [1] Sun, S., Murray, C.B., Weller, D., Folk, L., Moser, A., Monodisperse FePt nanoparticles and ferromagnetic FePt nanocrystal superlattices, *Science*, 287 (2000) 1989-92.
- [2] Miller, M.M., Prinz, G.A., Cheng, S.F., Bounnak, S., Detection of a micron-sized magnetic sphere using a ring-shaped anisotropic magnetoresistance-based biosensors, *Appl. Phys. Lett.*, 81 (2002) 2211- 2213.
- [3] Jain, T.K., Morales, M.A., Sahoo, S.K., Leslie-Pelecky, D.L., Labhasetwar, V., Iron oxide nanoparticles for sustained delivery of anticancer agents, *Mol. Pharm.*, 2 (2005)194-205.
- [4] Chourpa, I., Douziech-Eyrolles, L., Ngaboni-Okassa, L., Fouquenot, J.F., Cohen-Jonathan, S., Souce, M., Marchais, H., Dubois, P., Molecular composition of iron oxide nanoparticles, precursors for magnetic drug targeting, as characterized by confocal Raman microspectroscopy, *Analyst*, 130 (2005) 1395-403
- [5] Bulte, J. W., Intracellular endosomal magnetic labeling of cells, *Methods Mol. Med.*, 124 (2006) 419 -39.
- [6] Modo, M., Bulte, J.W., Cellular MR imaging, *Mol. Imaging*, 4 (2005)143-64.
- [7] Burtea, C., Laurent, S., Roch, A., Vander, Elst, L., Muller, R.N., C-MALISA (cellular magnetic-linked immunosorbent assay), a new application of cellular ELISA for MRI., *J. Inorg. Biochem.* 99 (2005) 1135-44.
- [8] Boutry, S., Laurent, S., Vander, Elst, L., Muller, R.N., Specific E-selection targeting with a superparamagnetic MRI contrast agent., *Contrast Med.Mol. Imaging*, 1 (2006) 15-22.
- [9] Babes, L., Denizot, B., Tanguy, G., Le Jeune, J.J., Jallet, P.J., Synthesis of Iron Oxide Nanoparticles Used as MRI Contrast Agents: A Parametric Study, *Colloid Interface Sci.*, 212 (1999) 474-482.
- [10] Sonvico, F., Dubernet, C., Colombo, P., Couvreur, P., Metallic colloid nanotechnology, applications in diagnosis and therapeutics, *Curr. Pharm.Des.*, 11 (2005) 2091 -2105.
- [11] Corot, C., Robert, P., Idee, J.M., Port M., Recent advances in iron oxide nanocrystal technology for medical imaging, *Adv. Drug Delivery Rev.*, 58 (2006) 1471-504.
- [12] Modo, M. M. J., Bulte, J. W. M., *Molecular and Cellular MR Imaging*; CRC Press: Boca Raton, FL (2007).
- [13] Charles, S.W., Popplewell, J.; Properties and applications of magnetic liquids, *EndeaVour* 6 (1982) 153 -61.
- [14] Gupta, A.K., Gupta, M., Synthesis and surface engineering of iron oxide nanoparticles for biomedical applications, *Biomaterials* 26 (2005) 3995-4021.
- [15] Chastellain, M., Petri, A., Gupta, A., Rao, K.V., Hofmann, H., Super magnetic silica-iron oxide nanocomposites for applications in hyperthermia, *Adv. Eng. Mater.* 6 (2004) 235-241.
- [16] Willard, M. A., Kurihara, L.K., Carpenter, E. E., Calvin, S., Harris, V.G., *Encyclopedia of Nanoscience and Nanotechnology*; Nalwa, H. S., Ed.; American Scientific Publishers: Valencia, CA, 1, (2004) 815.
- [17] Natov, M., Velev, P., Suspension copolymerization of unsaturated resins with styrene and acrylonitrile, *Macromolecular chemistry and physics*, 201 (2000) 1244-49.
- [18] Al-Hartomy, O. A., Al-Ghamdi, A., Dishovsky, N., Slavcheva, D., Iliev, V., El-Tantawy, Farid, Dielectric and Microwave Properties of Natural Rubber Based Composites Containing Fullerene Black, *International Review of Chemical Engineering*, 3(2011), 386-391.
- [19] Kang, Y. S., Risbud, S., Rabolt, J. F., Stroeve, P., Synthesis and Characterization of nanometer-size Fe₃O₄ and γ - Fe₂O₃ particles, *Chem Mater.*, 8 (1996) 2209-2211.
- [20] Rojas, A.J., Borrajo L.and Williams R.J.; The curing of unsaturated polyester resins in adiabatic reactors and heated molds, *Polym. Eng. Sci.*, 17 (1981) 1122 -27.
- [21] Fradet, A., Arlaud, P., *Comprehensive Polymer Science*, ed. Eastmond, G. C.; Ledwith, A.; Russo, S.; Sigwalt, P., Pergamon Press, Oxford, 5 (1989) 331- 344.