

บทความวิจัย

การศึกษาแรงสั่นสะเทือนอัลตราโซนิกช่วยในการตัด อะลูมิเนียมหล่อ

เศรษฐ์ อุดมบุญญาณภาพ¹ ธงชัย เฟื่องจันทร์ดี² อภิวัฒน์ มุตตามระ³
และ สมศักดิ์ ศิวดำรงพงศ์^{1*}

บทคัดย่อ

การประยุกต์ใช้แรงสั่นสะเทือนอัลตราโซนิกในงานกัดสามารถช่วยในการปรับปรุงลักษณะเฉพาะในการขึ้นรูปหลายๆ ด้าน เช่น แรงในการตัดเฉือน ความหยาบผิวของชิ้นงาน และอายุการใช้งานของเครื่องมือตัด อย่างไรก็ตาม จำนวนงานวิจัยในด้านนี้ยังมีอยู่ไม่มากและส่วนใหญ่เป็นการศึกษาวัสดุประเภทแข็งเปราะ ดังนั้นงานวิจัยนี้ได้ขยายขอบเขตการศึกษาในงานกัดอะลูมิเนียมหล่อเกรด A356 ซึ่งมีสมบัติอ่อนเหนียว โดยสร้างแรงสั่นสะเทือนความถี่ 19.74 กิโลเฮิร์ตซ์ ขนาดแอมพลิจูด 12 ไมโครเมตร ส่งผ่านให้กับชิ้นงานในทิศทางการเคลื่อนที่ของเครื่องมือตัด งานกัดถูกทำขึ้นภายใต้เครื่องกัดซีเอ็นซีและดอกเอ็นมิลคาร์ไบด์ขนาดเส้นผ่านศูนย์กลาง 6 มิลลิเมตร กัดแบบร่องปราศจากการหล่อเย็น ผลการทดลองพบว่า อัตราการป้อนสูงส่งผลให้ค่าเฉลี่ยแรงตัดเฉือนในแนวระนาบของการใช้แรงสั่นสะเทือนอัลตราโซนิกมีค่าน้อยกว่ากระบวนการกัดแบบทั่วไปถึงร้อยละ 13.9 ลักษณะโครงสร้างจุลภาคของพื้นผิวงานหลังประยุกต์แรงสั่นสะเทือนอัลตราโซนิกมีการก่อตัวที่เป็นแบบแผนและแตกต่างจากกระบวนการกัดแบบทั่วไป เมื่อความเร็วในการตัดเฉือนเพิ่มสูงขึ้นค่าความหยาบผิวลดลงร้อยละ 21.4 สรุปได้ว่าแรงสั่นสะเทือนอัลตราโซนิกสามารถก่อให้เกิดผลกระทบเชิงบวกต่อค่าเฉลี่ยแรงตัดเฉือนและค่าความหยาบผิวโดยขึ้นอยู่กับอัตราการป้อนต่อฟันและความเร็วในการตัดเฉือน

คำสำคัญ: แรงตัดเฉือน ค่าความหยาบผิว แรงสั่นสะเทือนอัลตราโซนิกช่วยในงานกัด อะลูมิเนียม A356

¹สาขาวิชาวิศวกรรมการผลิต สำนักวิชาวิศวกรรมศาสตร์ มหาวิทยาลัยเทคโนโลยีสุรนารี

²สาขาวิชาการจัดการวิศวกรรมการผลิตและโลจิสติกส์ คณะวิทยาศาสตร์และเทคโนโลยี มหาวิทยาลัยราชภัฏบ้านสมเด็จเจ้าพระยา

³ภาควิชาวิศวกรรมอุตสาหกรรม คณะวิศวกรรมศาสตร์ มหาวิทยาลัยธรรมศาสตร์

*ผู้นิพนธ์ประสานงาน, e-mail: somsaksi@sut.ac.th

Study of Ultrasonic Vibration Assisted Milling of Casted Aluminum

Sed Udomboonyanupap¹, Thongchai Pangjundee², Apiwat Muttamara³
and Somsak Siwadamrongpong^{1*}

ABSTRACT

Ultrasonic vibration-assisted milling (UAM) has been proven to improve machining characteristics such as cutting force, surface roughness quality, and cutting tool life. However, the number of research studies in the field of UAM is very small and mainly focused on hard-brittle material machining processes. Accordingly, to expand UAM research into a wider variety of materials, a study of UAM on a ductile material, A356 Cast aluminum is presented in this research. In the experiment, ultrasonic vibration of 19.74 kHz with an amplitude of 12 μm was applied to the workpiece along cutting feed direction. Besides, CNC machining center and carbide end mill with a diameter of 6 millimeters were used for slot milling under dry cutting condition. Characteristics of cutting force magnitude in end mill revolution, surface topography, and surface roughness were compared between UAM and conventional milling (CM). Experimental results showed that the average horizontal force in cutting direction of UAM was lower than CM at large feed per tooth value by 13.9%. UAM surface topography was different when comparing to CM because ultrasonic vibration assistance enables the generation of a uniformed pattern on the workpiece. Surface roughness was improved by 21.4% when cutting speed increases. It was concluded that UAM application on A356 Cast aluminum material has positive effects on cutting force and surface roughness depending on feed per tooth and cutting speed.

Keywords: Cutting force, Surface roughness, Ultrasonic vibration-assisted milling, Aluminum A356

¹School of Manufacturing Engineering, Suranaree University of Technology

²Program in Production and Logistics Engineering Management, Faculty of Science and Technology,
Bansomdejchaopraya Rajabhat University

³Department of Industrial Engineering, Thammasat University

*Corresponding author, email: somsaksi@sut.ac.th

Introduction

Milling process is the most commonly used metal removal operation in industry. General problems of milling process especially machining of good mechanical property materials are high cutting forces, wear of cutter edges, dimensioning deviation, poor surface roughness, and properly method requirement of cooling. These are potentially increasing risks of quality and economic concerns because of growing demand for milling of good mechanical property materials. A new efficient technique to break constraints of milling performance is known as ultrasonic-assisted milling (UAM). The fundamentals of UAM is that the tool face was separated from the chip and cutting area repeatedly by using high-frequency vibration amplitude imposed to the tool or workpiece.

In the past few decades, different researchers have reported significant improvements in hard-brittle material by using ultrasonic-assisted milling. Zhang *et al.* [1-3] compared the performance of rotary ultrasonic face milling (RUFM) with the conventional milling of K9 optical glass. There were reported that the relationship between cutting depth and ultrasonic amplitude would significantly reduce the cutting force, and extend tool life of diamond tool. Pei *et al.* [4] used rotary ultrasonic face milling to reveal the main effects of the process parameters such as Material Removal Rate (MRR), cutting force, and surface roughness in advanced ceramic machining process. Noma *et al.* [5] presented a reduction of thrust force, tool wear and chipping size after applied axial ultrasonic vibration-assisted milling of chemically strengthened glass. Li *et al.* [6] evaluated the cutting force and surface quality of ceramic matrix composite finding that RUFM has advantage over conventional machining.

Beside hard brittle material machining by UAM research, hard-to-cut material was also picked up to study on UAM application in order to improve machining characteristics. Suarez *et al.* [7] investigated the effect of UAM on Ni-Alloy 718 hard-to-cut material. The result shows that fatigue of UAM specimen increases which can explain by surface differences from conventional milling (CM). Elhami *et al.* [8] could reduce cutting force of hardened AISI4140 machining process by applying two advanced machining methods: thermally enhanced machining and UAM to the workpiece. Uhlmann *et al.* [9] studied effects of UAM when different cutting condition applied into the carbon and glass fiber reinforce plastics. The result shows that ultrasonic-assisted milling can be advantageous on workpiece quality and dust concentration but a reduction of cutting force could not be observed. Razfar *et al.* [10] investigated the effect of UAM of AISI 1020 steel in term of depth of cut, cutting speed and feed rate. The surface roughness is improved by up to 12.9% when implementing UAM. Shen *et al.* [11] agreed that forces while milling AISI 420 steel are reduced during UAM compared to CM. Reduction of cutting forces is attributed to the vibration amplitude influencing the gap between the cutting tool and the workpiece material resulting in improved chip breaking condition. Zarchi *et al.* [12] investigated the effect of ultrasonic vibration on cutting forces in ultrasonic-assisted side milling of AISI 420. They developed a new theoretical model for cutting force. Maurotto *et al.* [13] investigated that the effect on residual stresses in ultrasonic-assisted milling of AISI 316L reaching frequencies as high as 60 kHz, but they found the best result in the

low frequency range. Tao *et al.* [14] analyzed horizontal cutting force after applying ultrasonic vibration into Ti-6Al-4V workpiece. The result indicates that cutting force would be decreased when feed direction ultrasonic vibration is exerted to the workpiece especially when feed per tooth value is equivalent with vibration amplitude.

Furthermore, widely applicable ductile and soft material such as aluminum was sometimes selected to study in UAM application to compare with conventional milling process. Ma *et al.* [15] researched on ultrasonic vibration-assisted cutting and found that it could improve machining precision of Al52S workpiece. Chern *et al.* [16] researched on vibration-assisted milling of Al6061 and found that vibration could improve machining accuracy, surface roughness, and tool life. Xing *et al.* [17] presented that ultrasonic vibration-assisted milling can improve tribology property because scaly textures which occur by vibration could enhance the adsorption capacities of Al alloy surface to oil film.

In overall, ultrasonic-assisted milling is an advanced machining technology and has contributed several advantages. However, the number of research studied in the field of UAM is a few quantities when compared with a variety of applications, techniques, and materials. The main reason is UAM researchers highly focused on machining of hard-brittle and hard-to-cut materials rather than general soft materials. To expand UAM research into a wider variety of materials and applications, UAM research on ductile material A356 Cast aluminum is presented in this research. The difference of machining characteristics between UAM and CM such as cutting force, surface topography and surface roughness are analyzed and discussed in this study.

Materials and Methods

The experiments of UAM process have been performed on a 3-axis UMACH LMC1020 CNC milling machine. An UCE Ultrasonic generator is employed to supply high frequency electrical impulses into 1.5 kW piezoelectric transducer. These high frequency electrical pulses are converted to mechanical vibrations with ultrasonic frequency (19.74 kHz) and transferred to cast aluminum A365 workpiece which is attached at the end of transducer. An ultrasonic transducer body is fixed with the metal frame which is clamped with a Kistler dynamometer model 9072 by 4 hex head set screws. Bench vise on CNC machine table is used to clamp dynamometer. Cutting force signal is displayed on Kistler amplifier 5070A and it interfaced to the computer using Dyno software to analyze the force (Figure 1).

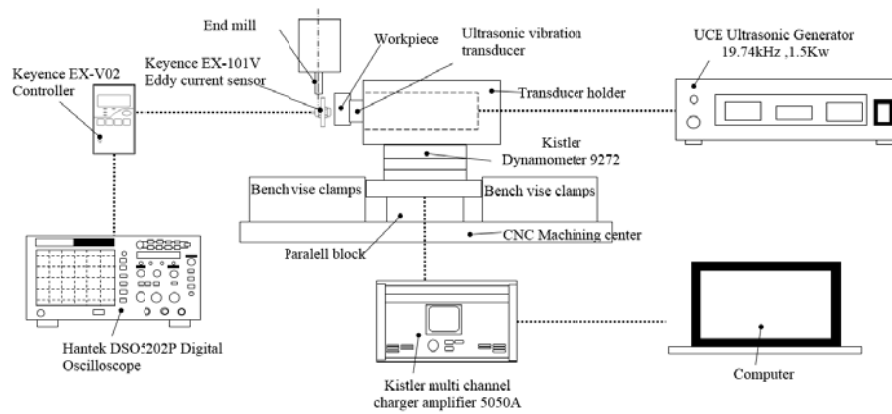
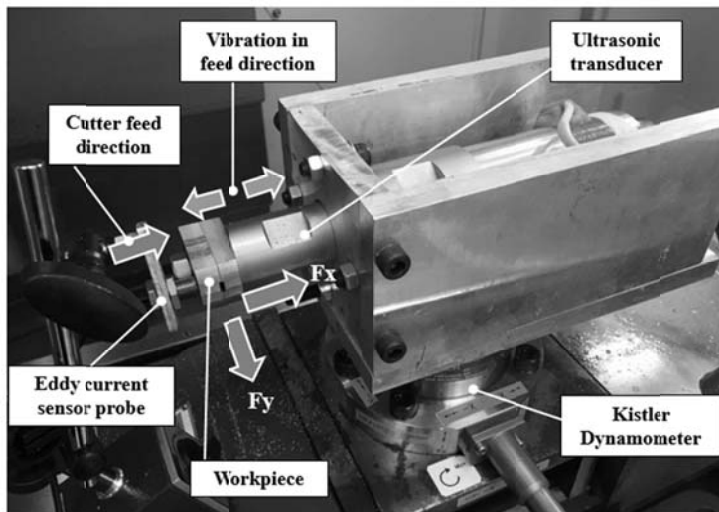

Figure 1 Schematic of experiment set up.

Vibration amplitude of the work piece has been confirmed by Keyence EV-101V eddy current sensor. The sensor probe was located in a distance of 1 mm to the end face of the workpiece as shown in Figure 2(a). Vibration frequency signal was transferred through eddy current sensor and Keyence controller EX-V02 to output at Hantek DSO520P Digital oscilloscope monitor. Output voltage value is shown 84mV and its amplitude value was indicated at 12 μm peak to peak by voltage calculation as in Figure 2(b).

(a)



(b)

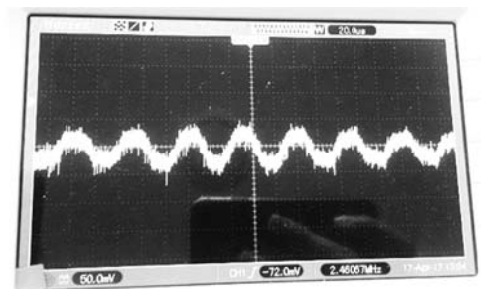

Figure 2 (a) Set up of workpiece and sensor for vibration amplitude measurement, (b) Output voltage from sensor measuring vibration amplitude ($1 \mu\text{m}/7\text{mV}$) which shows the amplitude of 12 μm

Cast aluminum A356 T6 was used for this experiment. The workpiece material was cut to the dimension of 10x50x20 mm. The elemental compositions of the workpiece material are shown in Table 1.

Slot milling has been performed by a commercial two-flute carbide end mill with a diameter of 6 mm without cooling process. Cutting process was operated by UAM and CM methods. Vibration amplitude was applied at 0 and 12 μm to see the difference of cutting force and surface structure. Axial cutting depth is set at 1 mm, all cutting parameters with their ranges have been given in Table 2.

Table 1 Percentage of alloying elements used in A356 T6.

Si	Mg	Fe	Cu	Mn	Zn	Ti	Al
7.18	0.215	0.108	0.0197	0.0045	0.0089	0.112	Bal.

Table 2 Cutting conditions in experiment test.

Experiment	Cutting speed n , (r/min)	Feed per tooth f_z , ($\mu\text{m}/\text{tooth}$)	Feed rate* f_t , (mm/min)	Depth of cut A_p , (mm)	Frequency f , (kHz)	Amplitude A , (μm)
CM	5000,7000*	10,20,30	50,100,200,300,400	1	-	0
UAM	5000,7000*	10,20,30	50,100,200,300,400	1	19.74	12

*Cutting parameter for surface roughness study

Surface topography was analyzed by SEM JSM-6010 series while surface roughness (Ra) was measured by Mitutoyo surface roughness portable tester model SJ-201. Due to the variations in vibration amplitude at different positions along the vibration, cutting force, and surface roughness have been measured and then their average values have been recorded.

Results and Discussions

1. Cutting force.

In experiment of feed per tooth of 10, 20 and 30 μm range, two cutting force components along feed direction (F_x) and feed perpendicular direction (F_y) components have been measured by a 9272A KISTLER dynamometer. The force signals are recorded for analysis via a Dyno-ware software. As commonly understood by many researchers that rotation angle shall not be measured under the current experimental conditions, therefore, the measured forces in F_x and F_y directions cannot be converted to tangential force. The resultant force in horizontal cutting direction (F_c) is used to analyze the improving effect of the exerted ultrasonic vibration on the milling processing. Components of cutting force in F_x , F_y and F_c directions are presented on Figure 3

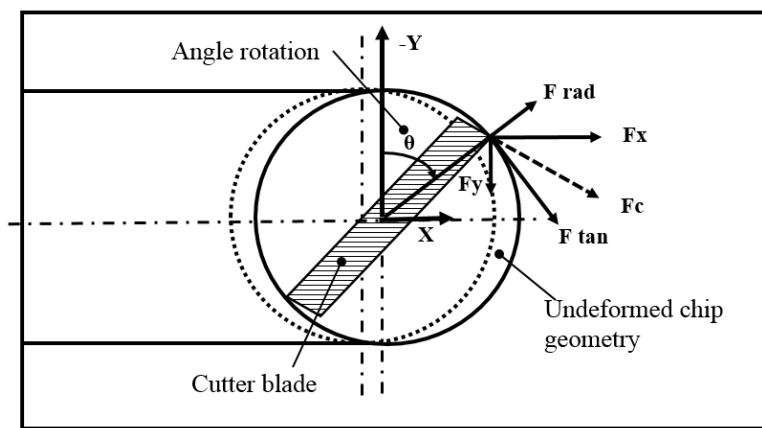

Figure 3 Cutting force components of slot milling.

The horizontal force in cutting direction (F_c) can be calculated and obtained by Eq. (1).

$$F_c = \sqrt{F_x^2 + F_y^2} \quad (1)$$

Figure 4 shows partial raw cutting force data where F_x and F_y indicate the cutting force of feed tangential feed directions. The cutting force profiles of the UAM workpiece (Figure 4(b), 4(d) and 4(f)) were different from those of cutting force of conventional milling (Figure 4(a), 4(c) and 4(e)) process. It could be considered due to UAM generated workpiece vibration with a high frequency of 19.74 kHz which caused the cutting tool tips move backward-forward, and resulting high density of cutting force measured profile. A different peak of cutting force in each cutting tooltip observed, it might cause by different edge radius due to wear and run-out length phenomena in the regular milling process. Besides, peak values of cutting force increase when feed per tooth values are increasing, and the peak values of UAM cutting forces in F_x direction are higher than CM because of cutting tool moved forward over the conventional cutting patch.

The detailed photographs in Figure 5 show the feed direction and tangential direction cutting forces in one cutting cycle under the same feed per tooth condition ($f_z = 30 \mu\text{m}$) when the vibration amplitudes are 0 (conventional milling) and $12 \mu\text{m}$, respectively. It shows that ultrasonic vibration could reduce the profiles of cutting forces in F_y direction while F_y in conventional milling maintains. Analysis shows that the production of pulse like profiles was the result of the cutter moving backward to the position which could make reduction of cutting force in F_y direction.

Figure 6 shows the average horizontal force in cutting direction value by hundred cutting cycles against three feeds per tooth values. The primary efficacy parameter which profoundly influenced to average horizontal force in cutting direction increasing in all experimental conditions is feed per tooth. Cutting force gradual increase when feed per tooth is rising. Comparison of cutting force, CM gave lower horizontal cutting force than UAM at feed per tooth of $10 \mu\text{m}$ because UAM contributed to high cutting force in both F_x and F_y cutting force directions. But when feed per tooth value is increased to $20 \mu\text{m}$, cutting force in UAM become equivalent with CM, and when feed per tooth value is increased to $30 \mu\text{m}$, cutting force in UAM becomes lower than CM by 13.9%. This phenomena effect is analyzed and presented that cutting force in direction is reduced because tooltip moved backward and contributed to lower average horizontal force in cutting direction at the measured point as explained above in Figure 5. It might be additionally observed that the advantage of vibration could contribute to cutting force reduction when vibration amplitude is smaller than feed per tooth value. It could explain that large vibration amplitude could make an adverse effect on cutting force because the cutting tooltip moves forward over feed per tooth.

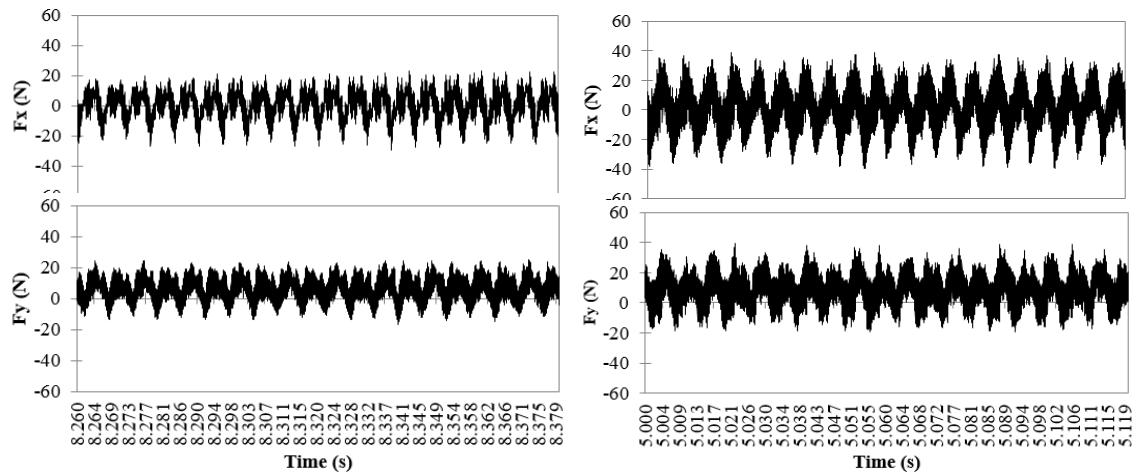

(a) $A = 0 \mu\text{m}$, $f_z = 10 \mu\text{m}$, $f_t = 100 \text{ mm/min}$

(b) $A = 12 \mu\text{m}$, $f_z = 10 \mu\text{m}$, $f_t = 100 \text{ mm/min}$

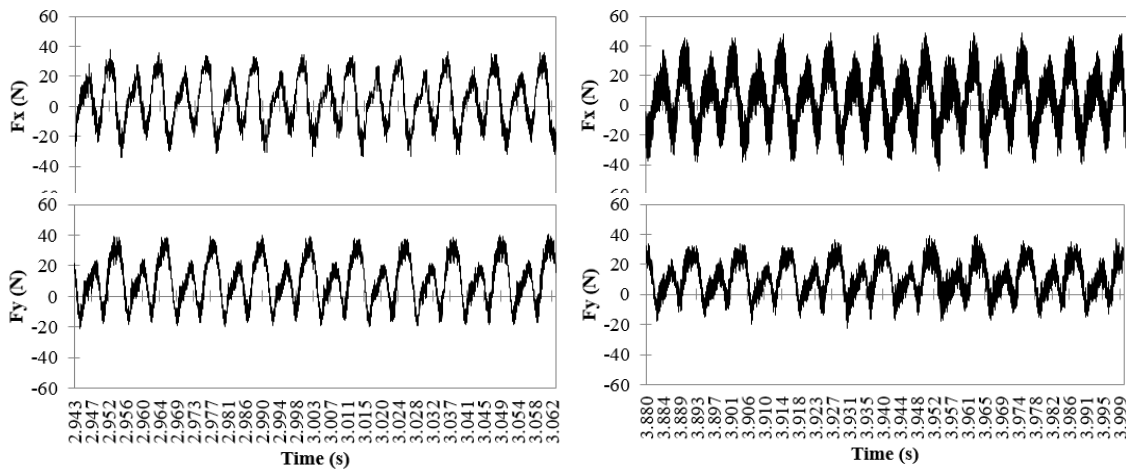

(c) $A = 0 \mu\text{m}$, $f_z = 20 \mu\text{m}$, $f_t = 200 \text{ mm/min}$

(d) $A = 12 \mu\text{m}$, $f_z = 20 \mu\text{m}$, $f_t = 200 \text{ mm/min}$

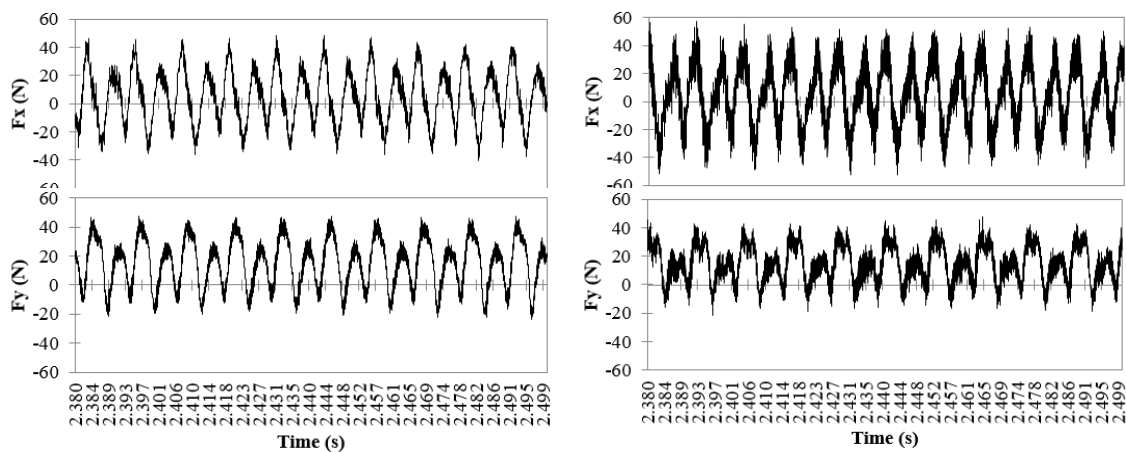

(e) $A = 0 \mu\text{m}$, $f_z = 30 \mu\text{m}$, $f_t = 300 \text{ mm/min}$

(f) $A = 12 \mu\text{m}$, $f_z = 30 \mu\text{m}$, $f_t = 300 \text{ mm/min}$

Figure 4 Experiment cutting force with different amplitudes and feed per tooth.

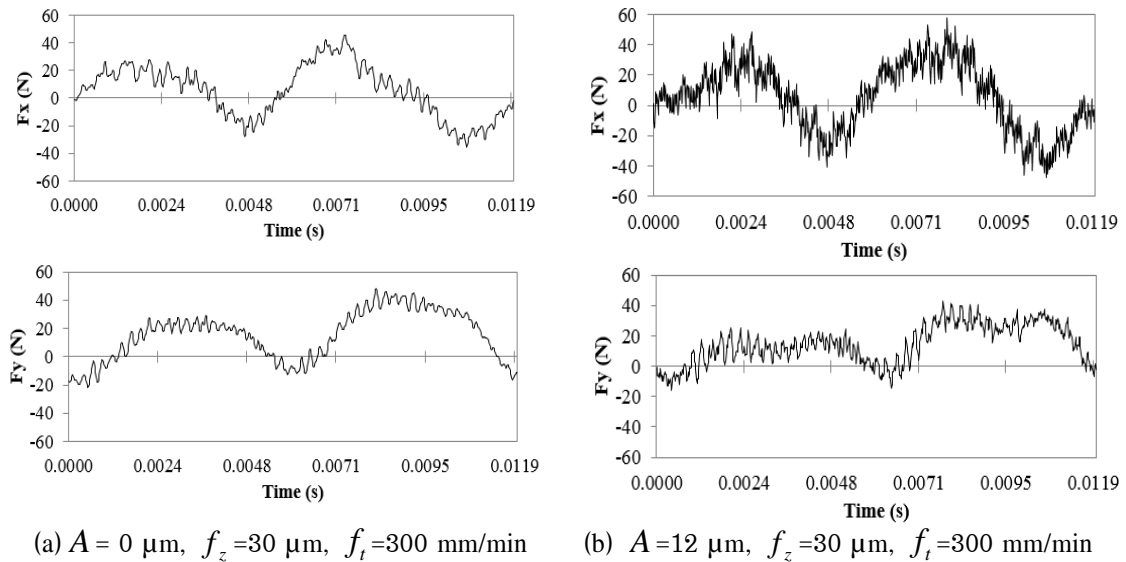

Figure 5 Experiment cutting force data in a cutting cycle.

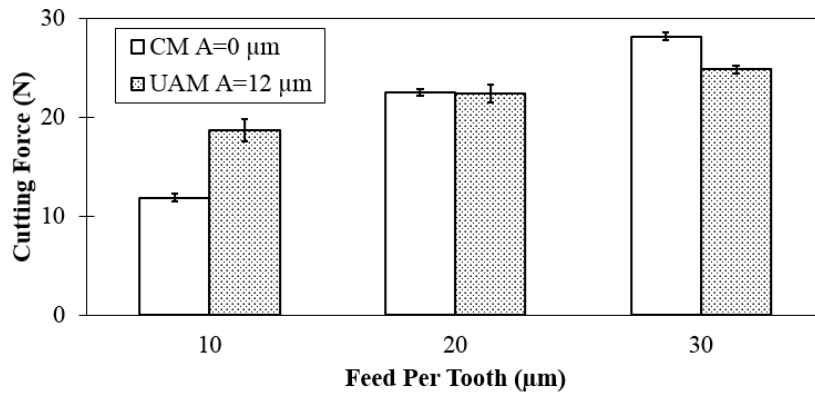

Figure 6 Average value of force in cutting direction (F_c) with different feeds per tooth.

2. Surface topography

Figure 7 shows the SEM photographs of slot bottom surfaces comparing between CM and UAM against feed per tooth of 10, 20 and 30 μm . Surface defects by cutting tool tip long dragging mark and chip removing appear on the bottom surface even when there is no ultrasonic vibration applied, as shown in Figure 7(a), 7(c) and 7(e). Without ultrasonic vibration, constant cutting tool surface contacts with workpiece materials during the cutting process acting on the processing surface continuously. Therefore, chips and cutting heat cannot be carried away in a timely manner which give the reason for surface defects. When ultrasonic vibration is applied, scaly textures evenly distribute on the UAM surface. The small chips and cutting heat could be quickly removed or eliminated, and thus avoiding tooltip and chip long dragging mark were occurred. Besides, a cause of scaly texture difference depending on a ratio of vibration amplitude and feed per tooth value. It is shown in Figure 7(b), 7(d), and 7(f).

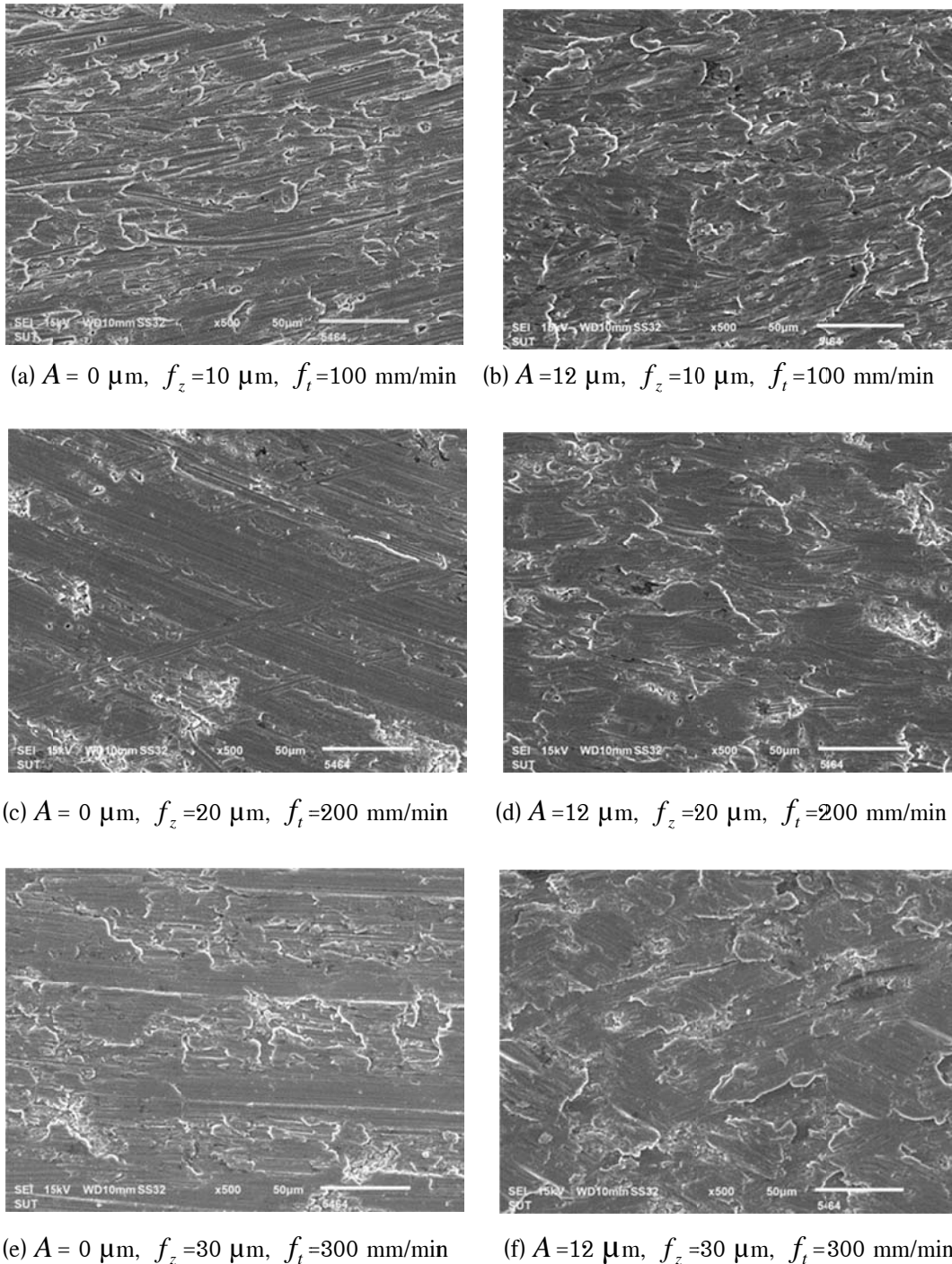

Figure 7 SEM photographs of finished surface at x500.

3. Surface roughness

In each experiment, the surface roughness has been measured three times by using a Mitutoyo surface roughness measuring tool, and their arithmetic average has been recorded as the corresponding surface roughness. Figure 8 shows the respective values of surface roughness of slot bottom surfaces against feed rate for CM and UAM in different cutting speed levels (n , r/min)

conditions. It can be observed that surface roughness increase with the rising of feed rate both CM and UAM with similar trend. In term of cutting speed effect, the surface roughness of both UAM and CM is reduced when cutting speed increases because of under a specific feed rate value, higher cutting speed effects to thinner chip thickness. Surface roughness is not much distinctly different in all feed rate values of cutting speed of 5000 r/min, but the surface roughness of UAM condition can be improved by 21.4% compared with CM when the cutting speed was rose to 7,000 r/min. It can explain that under a particular vibrating frequency, the higher the spindle speed, the shorter the cutting period, the trajectory of the tooltips change, and fewer tool marks remain on the machined surface as shown in Figure 9. Thus, in UAM, selection of cutting parameters and vibrating parameters affects the topography and surface.

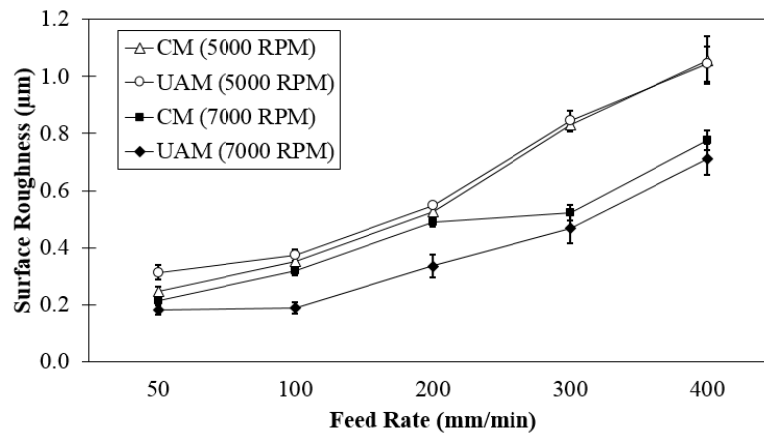

Figure 8 Average value of surface roughness with different cutting speed.

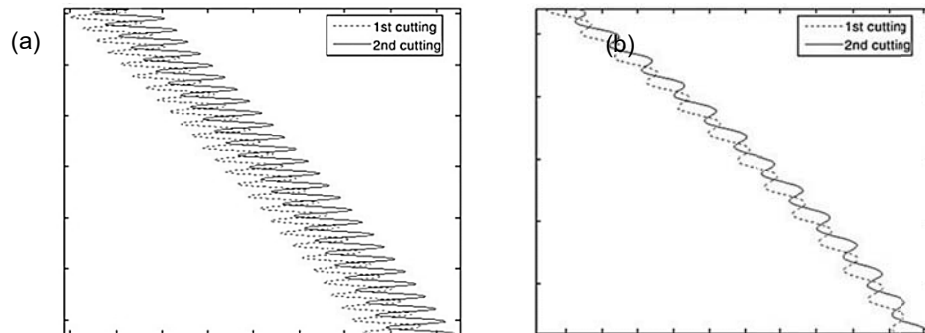

Figure 9 Trajectories of tool tips under different spindle speed (partial enlarged view). (a) Low cutting speed, (b) High cutting speed.

Conclusions

Ultrasonic vibration-assisted milling (UAM) has been utilized to machine slots into casted aluminum A365. The purpose of this exploratory work was to investigate the effect of feed per tooth, cutting speed and ultrasonic vibration on ductile material. Following conclusions can be drawn from the studies:

1. Cutting feed per tooth was the main effect on the cutting force in CM and UAM conditions. Cutting force gradually increases when cutting feed per tooth was rising.

2. Intermittent micro-segmentation cutting in a milling cycle by ultrasonic vibration effecting to a pulse of cutting force changed. The higher feed per tooth value of milling with ultrasonic vibration in the feed direction can bring advantage result on the lower average horizontal force in cutting direction lower than conventional milling method.

3. By comparing surface topographies of machined slot bottom surface, UAM can reduce surface defects with minimal tooltips drag mark phenomena and obtain uniform machined surfaces.

4. UAM in the feed direction has a positive effect on the surface roughness of machined surface.

The experiment study corroborates the difference between UAM and CM in term of variable feed per tooth, feed rate, and cutting speed at constant value of the vibration amplitude. Further studies are expected to address the effect of ultrasonic vibration on milling process, especially in term of wider parameters such as cutting speed, depth of cut, vibration amplitude and mechanism causing tool wear.

References

1. Zhang, C., Feng, P., Zhang, J., Wu, Z., and Yu, D. 2012. Theoretical and Experimental Research on the Features of Cutting Force in Rotary Ultrasonic Face Milling of K9 Glass. *Applied Mechanics and Materials*. 158: 1674-1679.
2. Zhang, C., Feng, P., Zhang, J., Wu, Z., and Yu, D. 2012. Investigation into the Rotary Ultrasonic Face Milling of K9 Glass with Mechanism Study of Material Removal. *International Journal of Manufacturing Technology and Management*. 25 (4): 248-266.
3. Zhang, C., Zhang, J., and Feng, P. 2013. Mathematical Model for Cutting Force in Rotary Ultrasonic Face Milling of Brittle Materials. *International Journal of Advanced Manufacturing Technology*. 69 (1-4): 161-170.
4. Pei, Z. J., Ferreira, P. M. 1999. An Experiment Investigation of Rotary Ultrasonic Face Milling. *International Journal of Machine Tools and Manufacture*. 39: 1327-1344.

5. Noma, K., Takeda, Y., Aoyama, T., Kakinuma, Y., and Hamada, S. 2014. High-Precision and High-Efficiency Micromachining of Chemically Strengthened Glass Using Ultrasonic Vibration. 6th CIRP International Conference on High Performance Cutting (HPC2014). 23-25 June 2014. California. USA. p. 389-394.
6. Li, Z., Yuan, S., and Zhang, C. 2016. Research on the Rotary Ultrasonic Facing Milling of Ceramic Matrix Composites. The 9th International Conference on Digital Enterprise Technology-Intelligent Manufacturing in the Knowledge Economy Era. 29-31 Mar 2016. Nanjing. China. p. 428-433.
7. Suarez, A., Veiga, F., Luis, L., Polvorosa, R., Steffen, L., and Wretland, A. 2016. Effects of Ultrasonic-Assisted Face Milling on Surface Integrity and Fatigue Life of Ni-Alloy 718. *Journal of Materials Engineering and Performance*. 25: 5076-5086.
8. Elhami, S., Razfar, M. R., and Farahnakian, M. 2015. Analytical, Numerical and Experimental Study of Cutting Force during Thermally Enhanced Ultrasonic Assisted Milling of Hardened AISI 4140. *International of Mechanical Sciences*. 103: 158-171.
9. Uhlmann, E., Protz, F., Stawiszynski, B., and Heidler, S. 2017. Ultrasonic Assisted Milling of Reinforced Plastics. 1st CIRP Conference on Composite Materials Parts Manufacturing (CIRP CCMPM 2017). 8-9 June 2017. Karlsruhe. Germany. p. 164-168.
10. Razfar, M., Sarvi, P., and Zarchi, M. A. 2011. Experimental Investigation of the Surface Roughness in Ultrasonic-Assisted Milling. *Proceedings of the Institution of Mechanical Engineers, Part B: Journal of Engineering Manufacture*. 225: 1615-1620.
11. Shen, X. H., Zhang, J. H., Li, H., Wang, J. J., and Wang, X. C. 2012. Ultrasonic Vibration-Assisted Milling of Aluminum Alloy. *The International Journal of Advanced Manufacturing Technology*. 63: 41-49.
12. Zarchi, M. A., Razfar, M., and Abdullah, A. 2013. Influence of Ultrasonic Vibrations on Side Milling of AISI 420 Stainless Steel. *International Journal of Advanced Manufacturing Technology*. 66: 83-92.
13. Maurotto, A., and Wickramarachchi, C. T. 2016. Experimental Investigations on Effects of Frequency in Ultrasonically-Assisted End-Milling of AISI, 316L: A Feasibility Study. *Ultrasonic*. 65: 113-120.
14. Tao, G. C., Ma, C., Shen, X. H., and Zhang, J. H. 2017. Experimental and Modeling Study on Cutting Force of Feed Direction Ultrasonic Vibration-Assisted Milling. *International Journal of Advanced Manufacturing Technology*. 90: 709-715.
15. Ma, C., Shamoto, E., Moriwaki, T., and Wang, L. 2004. Study of Machining Accuracy in Ultrasonic Elliptical Vibration Cutting. *International Journal of Machine Tools and Manufacture*. 44: 1305.

16. Chern, G. L., and Chang, Y. C. 2006. Using Two-Dimensional Vibration Cutting for Micro-Milling. *International journal of machine tools and manufacture*. 46: 659.
17. Xing, D., Zhang, J., Shen, X., Zhao, Y., and Wang, T. 2013. Tribological Properties of Ultrasonic Vibration Assisted Milling Aluminum Alloy Surfaces. Proceedings of the Seventeenth CIRP Conference on Electro Physical and Chemical Machining (ISEM 2013). 8-12 April 2013. Leuven. Belgium. p. 539-544.

ได้รับบทความวันที่ 1 ธันวาคม 2560

ยอมรับตีพิมพ์วันที่ 31 มีนาคม 2561