

The Techniques and Material Aesthetics of the Daguerreotype

Michael A. Robinson

**Submitted for the degree of Doctor of Philosophy
Photographic History**

**Photographic History Research Centre
De Montfort University
Leicester**

Supervisors: Dr. Kelley Wilder and Stephen Brown

March 2017

For Grania Grace

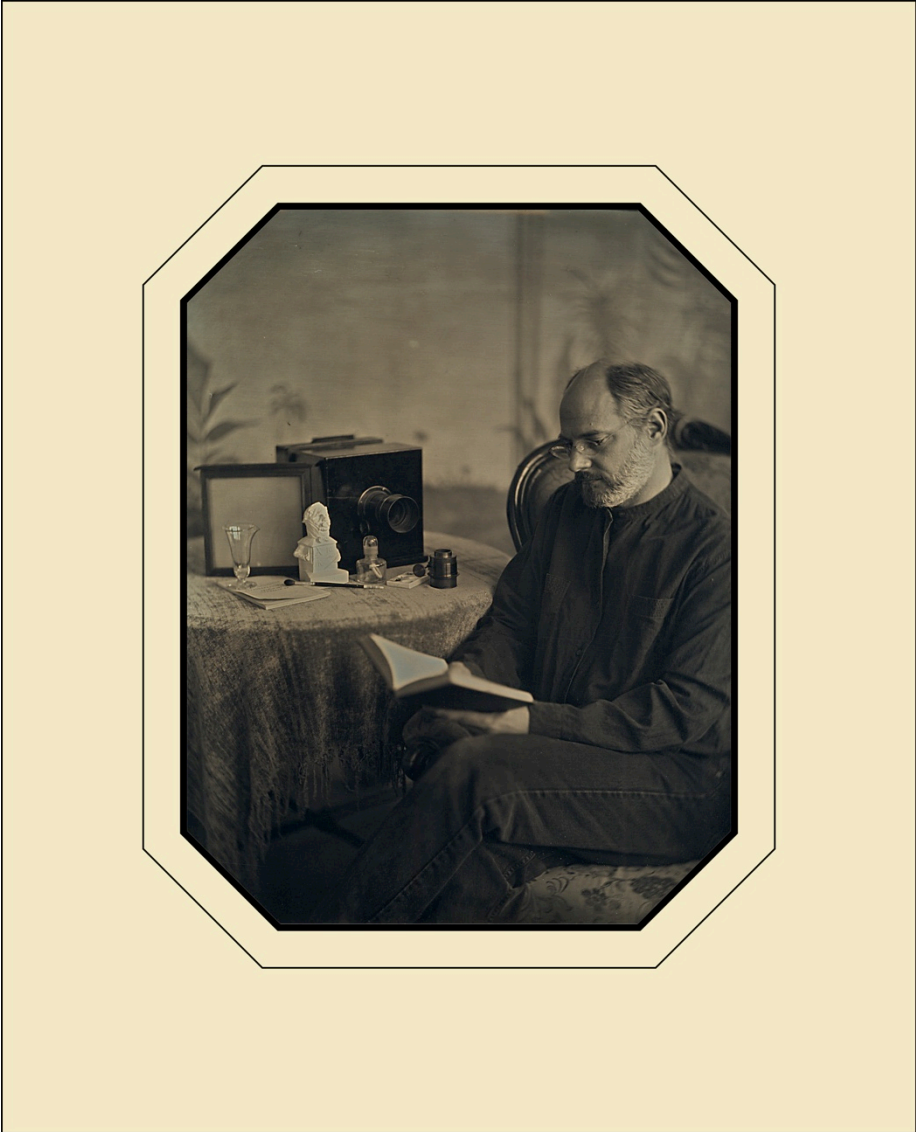

Abstract

This thesis explains why daguerreotypes look the way they do. It does this by retracing the pathway of discovery and innovation described in historical accounts, and combining this historical research with artisanal, tacit, and causal knowledge gained from synthesizing new daguerreotypes in the laboratory. Admired for its astonishing clarity and holographic tones, each daguerreotype contains a unique material story about the process of its creation. Clues from the historical record that report improvements in the art are tested in practice to explicitly understand the cause for effects described in texts and observed in historic images. This approach raises awareness of the materiality of the daguerreotype as an image, and the materiality of the daguerreotype as a process.

The structure of this thesis is determined by the techniques and materials of the daguerreotype in the order of practice related to improvements in speed, tone and spectral sensitivity, which were the prime motivation for advancements. Chapters are devoted to the silver plate, iodine sensitizing, halogen acceleration, and optics and their contribution toward image quality is revealed. The evolution of the lens is explained using some of the oldest cameras extant. Daguerre's discovery of the latent image is presented as the result of tacit experience rather than fortunate accident.

This thesis is the first to rigorously explain by empirical evidence how, why, and in what ways the daguerreotype process evolved. Its trans-disciplinary methodology, combining traditional research, tacit and gestural process knowledge, and laboratory synthesis refutes the speculative views of highly regarded photo historians, thus significantly correcting the historical record. Curators, caretakers and conservators are provided new material information about daguerreotypes to guide them and protect our cultural heritage, and avoid ill-informed conservation mistakes that have led to irreparable losses of the past.

Finally, this work provides evidence to revise prior histories concerning Daguerre's research and the evolution of the daguerreotype process.

Contents

Abstract	iii
List of Figures and Tables	vi
Acknowledgements.....	xiii
Chapter 1: Introduction	
1.1 Overview.....	1
1.2 The Daguerreotype Process	8
1.3 The Daguerreotype and Human Agency	16
1.4 The Daguerreotype and Material Culture	21
1.5 Engaging Literature	30
Chapter 2: Research Methodology	
2.1 Overview.....	39
2.2 Engagement through Synthesis.....	42
2.3 Experimental Process, Materials and Apparatus.....	50
2.4 Experimental Design.....	61
2.5 Conclusion	67
Chapter 3: The Silver Plate	
3.1 Overview.....	70
3.2 Technological Progression to Silver	73
3.3 Materiality of the Plate	89
3.4 Platemaking Technology	104
3.5 Polishing	114
3.6 Galvanizing	125
3.7 Conclusion	135
Chapter 4: Sensitizing with Iodine	
4.1 Overview.....	138
4.2 Introduction	140
4.3 Colours, Speed, Spectral Sensitivity.....	146
4.4 The Sensitizing Box	167
4.5 Conclusion	180

Chapter 5: Sensitizing Accelerators	
5.1	Overview..... 183
5.2	Introduction..... 186
5.3	The Holborn District..... 191
5.4	Claudet's Chloride of Iodine..... 208
5.5	Managing Bromine..... 215
5.6	Mixed Halogens..... 224
5.7	Conclusion..... 235
Chapter 6: Optics and Exposure	
6.1	Overview..... 240
6.2	Daguerre's Lens..... 244
6.3	First Portraits..... 255
6.4	Petzval's Lens..... 269
6.5	Conclusion..... 283
Chapter 7: Image Development Fixing and Toning	
7.1	Overview..... 289
7.2	The Magic Cupboard..... 291
7.3	Louis Daguerre's 1835 Discovery..... 301
7.4	Time and Temperature..... 307
7.5	Mercury and Ether..... 318
7.6	Gilding..... 327
7.7	Conclusion..... 337
Chapter 8: Conclusions	
8.1	Research Questions and Methodology..... 342
8.2	Chapter Summaries and Findings..... 346
8.3	Summary..... 362
Appendices	
	Appendix A – A Twin Paradox: Southworth & Hawes (PMG-AIC article)..... 365
	Appendix B - DagTest 4-24-2015 Baron Gros Experiment..... 384
	Appendix C - US Patents Related to Daguerreotype Plate Polishing..... 385
	Bibliography..... 434

List of Figures and Tables

Figure 1.	Dag Test 3-9-2014. Portrait of Keith F. Davis. Illustration of Prismatic effect with a slight change of viewing angle appearing magenta (left) and cyan (right).	7
Figure 2.	Joseph-Philibert Girault de Prangey (left) and Jean-Baptiste-Louis and Gros (right). Daguerreotypes of the east facade of the Propylaea from the same vantage point.	14
Figure 3.	Dag Test 3-18-2015. Multiply sensitized plate. Micrograph of highlight region on plate half developed with Hg (left), micrograph of highlight region on plate half developed with ether added to the Hg apparatus (right). Ether affect on image colour (Overlay).	44
Figure 4.	Patent drawing (adapted) for Southworth and Hawes' Daguerreotype Plate Holder (left). The replica device in use (right). Bob Warren photograph.	48
Figure 5.	Daguerreotype on a quarter-hard plate (left), and identically prepared example on a half-hard plate (right).	52
Figure 6.	Nineteenth century French style sensitizing boxes (left). <i>Author photo – GEM collection</i> . New reproduction sensitizing box (right).	54
Figure 7.	Bromine vapour absorbed by silica gel (left). The concentration of bromine is judged by colour. Working strength gel appears yellow, replenish strength gel appears red-orange (right).	55
Figure 8.	Clockwise from the left, a replica half-plate Palmer and Longking camera with Voigtländer lens, a full-plate replica of Daguerre's camera with landscape achromatic lens, an original L.B.B. & Co. quarter-plate chamfered box camera and lens, ca 1843, a replica quarter-plate chamfered box camera with Voigtländer lens, an original half-plate Palmer and Longking camera with C.C. Harrison lens, and a replica Voigtländer all-metal camera for taking round daguerreotypes.	57
Figure 9.	Nineteenth century cast iron mercury baths in quarter, full and half-plate size. Heating is done with an alcohol lamp (left). National Gallery of Canada collection. Modern mercury bath with improvements including an automated mercury temperature controller (right).	58
Figure 10.	Gilding illustration adapted from E. de Valicourt (left). Gold toning a quarter-plate (right).	60
Figure 11.	DagTest 4-15-2011. Solid .999 fine silver sheet (left). .999 fine silver clad copper (right).	63
Figure 12.	DagTest 4-15-2011. Solid .999 fine silver sheet (left). .999 fine silver clad copper after 10 minutes immersion in warm salt water (right). The yellow orange coating of silver iodide is still present on the solid silver plate.	64
Figure 13.	Page 25 from my laboratory notebook.	65

Robinson: The Techniques and Material Aesthetics of the Daguerreotype

Figure 14. Dag Test 4-15-2011. Image on sterling silver clad plate (left). Dag Test 3-18-2012. Image on sterling plate with pure silver deposited on right side before use (right).	92
Figure 15. Dag Test 3-13-2013. Image on fine silver (left). Image on sterling silver (right).	93
Figure 16. Dag Test 2-17-2013. Saxton re-enactment series compared to Saxton's first daguerreotype (inset). Saxton image courtesy of the Historical Society of Pennsylvania.	96
Figure 17. 1840 shadow region (left), 1841 shadow region (right).	100
Figure 18. 1840 Robert Cornelius daguerreotype. Arrow indicates burnishing tool marks.	102
Figure 19. Planishing hammer marks visible by reflection (left), under water (centre) and half- shadow illumination (right). 1840 plate on the left, others date to ca. 1853.	107
Figure 20. Surface defects on a Corduan & Co. plate visible in half-shadow illumination. National Gallery of Canada collection, LFA 21500_186_83.	110
Figure 21. Dag Test 9-21-2015. Full-plate daguerreotype polished with pumice according to Daguerre's directions in his 1839 manual. Insets illustrate the difficulties with dilute nitric acid.	117
Figure 22. Dag Test 5-14-2016. Daguerreotype polished with tripoli (rottenstone) according to Daguerre's improved method from October 1839. The plate was polished with linear strokes and no acid was applied after heating the plate.	119
Figure 23. Modern plates polished circular with pumice (left). Linear polish with rouge (right). Overlay, Daguerreotypes by Robert Cornelius with circular polish (left), and linear polish (right).	120
Figure 24. US Patent 4,573 dated June 13, 1846 (left). Verso and recto of the half-plate polishing block (centre). National Gallery of Canada collection, LFA 21500_601_5. Southworth and Hawes half-plate daguerreotype of three women. The plate has deformed edges due to the clamping system (right). Collection Michael Mattis and Judith Hochberg.	123
Figure 25. Daguerreotype of a surveyor with copper sulphate corrosion due to porous silver (left). Verso of the plate indicating that it was not galvanized. Note the red wax used to adhere the plate to a wooden block for buffing (right). Collection of Lawrence T. Jones.	127
Figure 26. SEM images showing the grain size of high current electroplated silver (left), compared to galvanic low current density (right).	130
Figure 27. Plating current test, 2005. The photosensitivity difference between a hard, fine- grained silver deposit produced with high current density (left), and a soft large-grained silver deposit produced with low current density (right).	131

Robinson: The Techniques and Material Aesthetics of the Daguerreotype

Figure 28. Dag Test 3-23-2014. The inset image from a light microscope shows dozens of black spots on the un-galvanized side that did not form on the galvanized side. SEM image of a black spot magnified 500X shows the insensitive circular void (upper right). SEM image showing silver grain cluster polishing residues trapped in a surface defect (lower right).	132
Figure 29. Dag Test 4-23-2016. Galvanizing is beneficial when bromine sensitizing is less than ideal (left). With sufficient bromine, the gain in sensitivity and tone is slight. Softer silver results in a brighter and warmer toned image, all else being equal (centre and right).	133
Figure 30. Box label for plates made by Edward White, New York manufacturer. National Gallery of Canada collection. Author photograph.....	134
Figure 31. Francis Wey, "Comment le soleil est devenu peintre. Histoire du Daguerreotype et de la photographie." <i>Musée des familles XX</i> , 1853, p. 261 (left). Louis Figuier, <i>Merveilles de la science</i> . Paris: Jouvett & Cie, 1869. p. 37 (right).	142
Figure 32. DagTest 4-12-2014. A silver spoon left on an iodized plate near north facing window light.	143
Figure 33. DagTest 9-19-2011. Iodine Ring Experiment.	148
Figure 34. DagTest 2-16-2013. View from studio window (left). In camera, unfixed silver iodide print-out negative image (right).	151
Figure 35. Inspecting the sensitizing colours. <i>The Scientific American</i> , January 22, 1887, Vol. 56, No. 4, p 47.	150
Figure 36. Colours reproduced directly from a sensitized plate with a spectrophotometer.	152
Figure 37. DagTest 9-17-2011. Iodizing colours (left), and the completed image (right) and first cycle reference scale (below).	153
Figure 38. Specular reflectance curves for silver iodide coatings of 60 and 120 seconds.	158
Figure 39. DagTest 2-8-2011. SEM images of silver iodide on daguerreotype plates.	161
Figure 40. DagTest 3-4-2015. 75 seconds 1st cycle magenta-violet iodizing (left). 393 seconds 2nd cycle magenta-violet iodizing (right).	163
Figure 41. Specular reflectance curves for silver iodide coatings of 75 and 393 seconds.	164
Figure 42. Iodine box enhanced cross section, from <i>History and Practice of Photogenic Drawing</i> , 1839, Plate II (left). Illustration of vapour distribution (right).	168
Figure 43. Daguerreotypes by Southworth & Hawes, courtesy of GEM.	169
Figure 44. Iodine absorbed porous plastic panel (left). Iodized silver plate (right).	172
Figure 45. Iodine coating simulation (left). <i>The Open Door</i> , daguerreotype, 2012 showing the effect of light iodine coatings on the perimeter (right).	173

Robinson: The Techniques and Material Aesthetics of the Daguerreotype

Figure 46. Iodine coating box built by John Roach. National Gallery of Canada collection. LFA 21500_601_31.	175
Figure 47. <i>Reverend Rollin Heber Neale</i> , Daguerreotype by Southworth & Hawes, courtesy of GEM.	176
Figure 48. <i>Greenwich Hospital</i> , National Gallery of Canada collection. LFA 21500_160_5 (left). <i>Folkestone Viaduct</i> , R. P. S. Collection 2003-5001/2/28227 (right).	189
Figure 49. Holborn District (detail). <i>The Fascination of London: Holborn and Bloomsbury</i>	192
Figure 50. Granite Bldg. studio, New York. <i>The Daguerreian Journal</i> , vol 2, 1851:75 (top). Medical Hall studio, Holborn. <i>The London and Edinburgh Philosophical Magazine and Journal of Science</i> , vol 19, 1841:408 (bottom).	197
Figure 51. Apparatus for preparing A & B mixtures, August 6, 1841. The Royal Society, AP/24/21.	204
Figure 52. <i>Portrait of John F. Goddard</i> , taken with the Wolcott camera. Private collection (left). <i>Antoine Claudet, Self-portrait</i> . Private collection (right).	206
Figure 53. DagTest 11-13-2014. Sensitizing experiments with iodine, chlorine and bromine. ...	211
Figure 54. <i>Portrait of Roger Smith</i> , 2014, taken at Lacock Abbey in 2014 using the replica camera that he built (left). <i>Mike Robinson, self-portrait</i> , 2014 (right).	213
Figure 55. Foucault's design sensitizing box for bromine water (left). Iodine box incorporating an absorbent card after Séguier's design (right). Source, www.collection-appareils.fr	217
Figure 56. Daguerre's <i>View of Bry-sur-Marne</i> , 1844. Collection of the Société française de photographie (left). DagTest 10-20-2013. Gold chloride solution applied locally before sensitizing (right). The red arrows indicate the location of the semi-circular seepage.	219
Figure 57. DagTest 4-11-2015. Plate with mottled gold deposit on right half before re-polishing (left). Completed image with left half completely veiled and the right half partially formed (right).	221
Figure 58. Baron Gros' apparatus (enhanced with colour), <i>Recueil de mémoires et de procédés nouveaux concernant la photographie sur plaques métalliques 1847</i>	226
Figure 59. DagTest 4-24-2015. Baron Gros' 9-section sensitizing testing method.	230
Figure 60. Graph of singly sensitized vs. multiply sensitized magenta layers.	231
Figure 61. Graph of Baron Gros' preferred sensitizing (black line) compared to the fastest working combination (magenta line).	232
Figure 62. Chromatic aberration (left). Chromatic correction of focus with a crown and flint glass doublet (right). Illustration credit, Bob Mellish, Wikimedia Commons, 2006. ...	245
Figure 63. Drawing by Daguerre, sent to Niépce on April 19, 1833. From a reproduction in Kravets, <i>Dokumenty po istorii izobreteniiia fotografii</i> , 1949: 411.	248

Robinson: The Techniques and Material Aesthetics of the Daguerreotype

Figure 64. DagTest 6-11-2016. 75 seconds exposure (top), 120 seconds exposure with the lens reversed to project a flatter field (bottom). These images are quarter-plates. ...	250
Figure 65. Guinand price list dated 1844 for crown and flint optical disc found among Henry Fitz Jr's papers. Courtesy of the Southold Historical Society, Southold, NY.	253
Figure 66. Illustration of Wolcott patent drawing and spherical aberration (left). DagTest 4-13-013 taken with a Wolcott camera replica (right).	256
Figure 67. Claudet's <i>Photogenic Paradox</i> recreation (daguerreotype reversed for illustration). .	258
Figure 68. DagTest 12-19-2010. Spectral sensitivity of the daguerreotype.	261
Figure 69. John Draper's experimental lens camera apart and assembled. National Museum of American History, Smithsonian. Accession number 72.072A.08. Author photograph.	262
Figure 70. Cameras circa 1840 - 41 from the National Gallery of Canada collection. Unknown maker "Lokuta" camera, LFA 21500_600_8 (left). Camera built by John Roach, New York, LFA 21500_600_5 (right). Author photograph.	264
Figure 71. William H. Butler camera outfit, ca 1842, from the National Gallery of Canada collection, LFA 21500_600_3 (left). Ninth-plate portrait of Grant Romer taken with the same camera (right).	265
Figure 72. DagTest 11-24-2013. Daguerreotypes taken with the William H. Butler camera. Three sizes with centre element transposed incorrectly (top). Three sizes with the correct orientation for the centre element (bottom). Portrait of a man on quarter-sized plate masked to conceal spherical aberration. National Gallery of Canada collection, LFA 21500_186_83 (right).	267
Figure 73. Achromatic lens evolution from 1839 to 1841 comparing image size and relative speed.	270
Figure 74. DagTest 6-27-2016. Voigtländer all-metal round camera (left). Resolution test, quarter-plate lens serial. no. 3933 (right).	272
Figure 75. Quarter-plate daguerreotype of Samuel Troth, 1842. Courtesy of the Historical Society of Pennsylvania (left). Clipping from <i>The Practical Photographer</i> , June 1, 1894 (right).	274
Figure 76. DagTest 1-18-2016. Half-plate daguerreotypes taken with a Voigtländer lens (left), and C. C. Harrison lens (right).	278
Figure 77. Daguerreotype portraits of Fiona Christie taken January 3, 2004 with a Voigtländer lens.	280
Figure 78. The Frenchman, <i>Venice, St. Mark's and the pillars of Acre looking towards the Piazza</i> , c. 1845, courtesy of Ken and Jenny Jacobson (left). DagTest 4-8-2015 taken with a Voigtländer lens with a 5/8 inch hole in the lens cap (right).	282

Robinson: The Techniques and Material Aesthetics of the Daguerreotype

Figure 79. Half-plate daguerreotypes by Ruskin and Crawley with bracketed focus, courtesy of Ken and Jenny Jacobson (top). Chromolithograph after a drawing by John Ruskin <i>Panoramic view of Thun and the River Aar</i> , private collection (bottom).	285
Figure 80. 1934 advertisement for Kimberly-Clark corporation.	291
Figure 81. DagTest 1-21-2011. Mercury droplet test.	297
Figure 82. DagTest 1-14-206. Mercury reversal of a visible negative image.	299
Figure 83. DagTest 11-27-2014. Mercury developed latent image highlights with silver iodide printed-out shadows.	304
Figure 84. Salt fixed daguerreotype (left). Sodium thiosulphate fixed daguerreotype (right).	305
Figure 85. DagTest 3-18-2011. Plate developed for 1,2,4 and 8 minutes at 177°F, fixed and gold toned.	308
Figure 86. DagTest 3-18-2011. SEM micrographs at 2K and 20K and L*a*b* values for each step of the test targets at four development times. The SEM images indicate the image particle size, frequency and shape which determines image colour, and the yellow sloping line indicates a gain in photographic speed.	309
Figure 87. DagTest 3-18-2011. Solarized highlight particle size and frequency.	310
Figure 88. DagTest 3-14-2012. Analysis of highlight particles removed from the plate with adhesive tape.	314
Figure 89. DagTest 3-19-2015. Variations in time and sensitizing, with and without ether with corresponding SEM images of the 11-step tablets.	320
Figure 90. DagTest 3-19-2015. SEM images of mid-tones.	321
Figure 91. Patent by Eugène Mulon, 1855. Apparatus to introduce the chloroform or ether vapours into the mercury box by regularizing their evaporation. (<i>Paris et le Daguerreotype</i> , Musée Carnavalet, 1989: 26)	322
Figure 92. Cyrus and Hippolyte Macaire. <i>Navire quittant le port du Havre</i> (ca. 1851-53), collection of Jean and Leonard Walle.	325
Figure 93. DagTest 3-21-2014. Nineteenth century plate (top). DagTest 3-22-2014. Modern plate (bottom). Before and after gilding.	329
Figure 94. EDX chemical map showing daguerreotype image composition. Image (adapted) courtesy of Dr. Edward P. Vicenzi.	331
Figure 95. SEM micrographs of a void-free un-gilded plate and voids on gilded plates.	333
Figure 96. DagTest 3-28-2016. Void patterns and gold percentage at 0, 90s, 3m, and 6m.	333
Figure 97. Modern exfoliated plate (left). Southworth and Hawes image (right). Courtesy of GEM.	335

Robinson: The Techniques and Material Aesthetics of the Daguerreotype

Figure 98. Oversized daguerreotype of John Barritt Melson by J. E. Mayall. (Additional image inset for clarity) <i>19th Century British Photographs</i> exhibit, National Gallery of Canada, 2012. Planishing hammer marks are plainly visible in reflections on the gallery floor. Author photograph.	348
Table 1. Adapted from <i>A Treatise on Photography</i> by N. P. Lerebours. Translated by J. Egerton. London 1843: 19.	10
Table 2. Silver Iodine <i>Thickness</i> comparison.	160

Acknowledgements

I wish to thank the following for their advice, support and invaluable assistance these past six years and more.

Marcos Armstrong, François Brunet, Fiona Christie, Keith F. Davis, Michelle Delaney, Elizabeth Edwards, Chris Evans, Steven Evans, Gary W. Ewer, Greg French, Amy Folk, Bryan & Page Ginns, Jeff Green, Todd Gustavson, Alex Hakonson, Greg Hill, Spring Hurlbut, Gary Inkratas, Matthew R. Isenburg, Ken and Jenny Jacobson, Mark S. Johnson, Art Kaplan, Michael Lehr, Arnaud Maggs, Qiang Li, John McElhone, Neil MacDonald, Christopher Mahoney, Joanna McManus, Robin Meyers, Michael Mattis & Judith Hochberg, Ken Nelson, Jill Offenbeck, Mark Osterman, Shannon Perich, Serge Plantureux, Irving Pobboravsky, Grania Robinson, Janice Robinson, Grant B. Romer, Jerry Spagnoli, Peter Stahr, Dusan Stulik, Roger Taylor, David Thomson, Edward P. Vicenzi, Robert Warren, Leonard and Jean Walle, Roger Watson, Michelle Wilson, Bruce Wright, D'Arcy White, Harvey S. Zucker

The late Matthew R. Isenburg, founder of the Daguerreian Society and good friend, amassed an encyclopaedic collection of Daguerreotypes, Daguerreian Equipment, Literature and Ephemera. This collection was acquired privately in 2012 and brought to Toronto. My work has been enriched beyond measure because of the direct and unrestricted access to this material during the course of my research.

The Daguerreian Society members past and present, who share a common passion for the Daguerreotype, have been a never-ending source of inspiration.

I wish to recognize my present and former students of the Film and Photographic Preservation and Collections Management Program at Ryerson University for their support and enthusiasm.

I owe a debt of gratitude to Denise Marcoccia, Debra Worrell, Ken Marlow, Phil Bunn, Terence Rouge and the entire team at Clad Metal Specialties for their dedication and expertise in manufacturing daguerreotype plates.

I wish to acknowledge my supervisors, Dr. Kelley E. Wilder and Stephen Brown, for their dedication, encouragement and welcome advice. Kelley is an exemplar of academic scholarship and was the perfect mentor to me. I thank Dr. Martin Richardson and Dr. Marie-Angélique Languille for their enthusiastic yet rigorous review of my dissertation.

Most of all I wish to thank my partner Fiona Christie for her love and support.

1.1 Introduction: Overview

The Daguerreotype process produced a highly resolved singular image on a polished silver plate and dominated camera imaging until it was superseded by more convenient methods in the mid-1850s. This thesis examines the materials and methods used by nineteenth century daguerreian artists to produce them. It is important when interpreting historic daguerreotypes in the context of dating, authorship or aesthetics, to be aware of the processing variables that affect image quality because these variables were in constant flux from its introduction in 1839 until the end of its commercial use. Daguerreotypes not only appear different during different periods of advancement in the process, they can differ widely in appearance when made during the same period. Daguerreotypes do not all look alike.

Scholars and historians in the post-daguerreian era have relied on textual sources for their knowledge of the materials and processes when interpreting daguerreotypes. The difficulty with this approach is two-fold. First, as the texts were written during the daguerreian era by practicing daguerreians, much knowledge was held tacitly and not written into the public record. Second, the ability to recognize the significance or meaning of certain textual details may be limited by a lack of experience with the medium. My approach involves not only researching the materials and methods used, but actually testing them in practice to show explicitly how such variables affect the visual qualities of a daguerreotype.

I have chosen to explore the techniques and materials that advanced image quality, and for my purpose this means how effective these are at meeting the challenges of the daguerreotype process in terms of speed, tone and spectral sensitivity. Photographic style, pose and subject matter are beyond the scope of this investigation. To establish a definition of image quality, a nineteenth century description serves because it conforms to the language of the textual record. Thomas Sutton provided a concise description of image quality in 1856:

In a fine Daguerreotype, the utmost delicacy of line is combined with perfect gradation of shade; the details of the deepest shadows are as legible as those in full light; and the most elaborate finish is blended with exquisite softness of effect. In tone, nothing can be more beautiful than the varied hues of gold and purple which the image presents when viewed in different positions, in a strong light.¹

In contemporary terms, delicacy of line refers to the resolution of fine detail, gradation of shade is the rendition of natural colours of the subject in monochrome values, (the daguerreotype is not a colour process), details in deep shadows and full lights with softness of effect implies the contrast of the scene or person before the camera is fully realized, and elaborate finish is an indication of excellent plate polish. The varied hues that change with viewing angle is otherwise referred to as prismatic effect. All of this had to be achieved with exposures brief enough to arrest motion as blurriness destroys the resolution of fine details.

The materials of the daguerreotype include silver for the plates, iodine, bromine and chlorine used as sensitizing halogens, optics, and mercury and gold for processing the image after exposure. Materials related to production, such as polishing abrasives or apparatus, have been investigated if their use is reported in the literature to affect the appearance of the daguerreotype. Other material components of the daguerreotype object, such as cover glasses, matts, cases, passe-partout mounts and wall frames, will not be addressed here as they do not contribute to the visual qualities of the image.²

Techniques refer to how the materials were used. For example, polishing and buffing the silver plate can be performed entirely by hand, with mechanical aids, or a combination of both. Whatever the method, the degree of hand pressure and direct observation is critical for repeatable and successful results. This requires experience and craft knowledge, otherwise known as tacit knowledge. As a contemporary daguerreian artist with over sixteen years experience making

¹ Thomas Sutton, "The Daguerreotype Process." *Photographic Notes, Journal of the Photographic Society of Scotland and of the Manchester Photographic Society* 1 (1856): 112.

² For a comprehensive catalogue of daguerreotype housing materials see Berg, Paul K. *Nineteenth Century Photographic Cases and Wall Frames*. Huntington Valley Press, 1995.

daguerreotypes, I have the skills to replicate the methods of nineteenth century daguerreotypists in order to re-discover tacit knowledge omitted from the historical record. This in turn may reveal new information about historical daguerreotypes. Pamela Smith refers to this as "Artisanal Literacy" where knowledge is gained through experience and work rather than textual information.³ Every step of the daguerreotype process depends on tacit knowledge. Polishing, galvanizing, sensitizing, exposure evaluation, development and the final steps in fixing and gilding are observed processes that greatly rely on experience.

Tacit knowledge is retained and transferred directly from master to apprentice and throughout a community of practitioners.⁴ The know-how stemming from the daguerreotype process ceased over a hundred and twenty years ago when it was superseded and the daguerreians eventually died off. The same occurred within a community of musical instrument makers in the eighteenth century as explained in *Value Creation and Knowledge Loss: The Case of Cremonese Stringed Instruments*. When the instruments from master artisans Stradivari and Del Gesù received high acclaim for their concert-hall tone over a century after they were made, there was nobody able to replicate their sound with newly made instruments. Violin makers attempted to rediscover the tacit knowledge used to make them. Italian instrument maker Simone Fernando Sacconi made replicas based on Stradivari's moulds, templates, notes and sketches, and material scientists analyzed the woods and varnishes. Experts ultimately could not agree on an explanation for the sound strength of the Cremonese instruments. Cattani, Dunbar and Shapria in *Value Creation and Knowledge Loss* recognize that "a scientific approach based on the impact of isolated variables may simply demonstrate how too many potentially influential variables are in play to work out

³ Pamela Smith, *The Body of the Artisan: Art and Experience in the Scientific Revolution*. University of Chicago Press, 2004: 8.

⁴ Liliane Hilaire-Pérez and Catherine Verna, "Dissemination of Technical Knowledge in the Middle Ages and the Early Modern Era: New Approaches and Methodological Issues." *Technology and Culture* 47, no. 3 (July 2006): 536-65. <http://www.jstor.org/stable/40061171> (Date accessed, 29 Feb. 2012)

which ones constitute the critical causal relationships.”⁵ Every step of the daguerreotype process is a potentially influential variable, and so my approach addresses each step in turn using chemicals and procedures that adhere as closely as possible to nineteenth century practice.

Dr. M. Susan Barger has shown that the appearance of daguerreotype is directly related to its microstructure in terms of image particle size, spacing and distribution and states that alteration in materials and methods can be categorized by “those that improve microstructure and those that improve photographic efficiency”.⁶ Nineteenth century daguerreians had their own categories to discuss how altering materials and methods affected image quality and sensitivity.⁷ Modern scientific terms such as photographic efficiency and microstructure have the same meaning as shorter exposure time and image quality. An important point is that the daguerreotype process is not panchromatic as it reproduces the spectrum in monochrome values with decreasing sensitivity from violet to green. The non-uniform spectral response of the daguerreotype was well understood in the nineteenth century. Albert Southworth advised ladies to “Remember that positive red, orange, yellow or green, are the same as black, or nearly so; and violet, purple and blue are nearly the same as white; and arrange your costume accordingly.”⁸ Furthermore, Antoine Claudet graphically illustrated the spectral response of the daguerreotype process at the Crystal Palace exhibition in 1851.⁹

⁵ Gino Cattani, Roger L. M. Dunbar, and Zur Shapira, “Value Creation and Knowledge Loss: The Case of Cremonese Stringed Instruments.” *Organization Science* 24, no. 3 (2013): 11. <http://pubsonline.informs.org/doi/abs/10.1287/orsc.1120.0768> (Date accessed, 30 Nov. 2016)

⁶ M. Susan Barger, “The Daguerreotype: Image Structure, Optical Properties, and a Scientific Interpretation of Daguerreotypy.” PhD Dissertation, The Pennsylvania State University, 1982: 209.

⁷ I have chosen to use plain language to describe the appearance of daguerreotypes as this conforms well to the language used by nineteenth century daguerreians.

⁸ Albert S. Southworth, “Suggestions to Ladies Who Sit for Daguerreotypes.” *Lady’s Almanac* (1854): 103.

⁹ Roger Taylor, “Photographic Exhibitions in Britain 1839 - 1865.” <http://peib.dmu.ac.uk/detailphotographer.php?photogNo=73&inum=31&listLength=230&orderBy=coverage> (Date accessed, 2 Feb. 2012) Claudet titled his experiment a Photogenic Paradox whereas, “The result is that the yellow glass, although showing clearly to the eyes the picture of Her Majesty, has prevented the photogenic action, and that the deep blue glass, although completely hiding the portrait of Prince Albert, the photogenic rays reflected by his picture through the blue glass have

This spectral limitation of the daguerreotype system posed a challenge to produce pleasing skin tones for suntanned, freckled, or ruddy-faced sitters and was part of a daguerreians consciousness. For this reason I have added a third category for alterations in materials and methods; the list as follows:

1. Those that improve photographic sensitivity. (photographic efficiency)
2. Those that improve tone, contrast, or prismatic effect. (microstructure)
3. Those that improve spectral response or colour sensitivity.

Furthermore, as improvements in materials and methods were developed to address one or more of the above categories, it is important to know when and where these improvements were adopted into practice. Researching the chronology of materials and methods will, in some cases, assist in determining the date and provenance of daguerreotypes.

The optical properties of daguerreotypes vary significantly between artists, depending on their manipulation of the process. In 1854, daguerreian Jex J. Bardwell, wrote an article titled *Cause and Effect* seeking answers to the question:

In looking over a collection of pictures from different galleries, you will notice a peculiarity of tone -- so much so in some instances, that you could almost name the artist from whose hand the picture came. Now, How is this? ... We can see the effect, and many times might give a weeks' work to know the cause.¹⁰

Jex Bardwell concluded his article by fully describing his procedures and encouraged others to do so, hoping to form some sort of consensus, or at least compile process details for comparison. Even at this late period in daguerreotype evolution artists were trying to understand the nuances of the process.

Unfortunately, Bardwell's question, relevant to a practicing professional in 1854 seeking to do exemplary work, was never answered.¹¹ As Bardwell observed, all

had the same action on the daguerreotype as if the engraving had been covered with transparent glass, or with no glass at all."

¹⁰ J. J. Bardwell, "Cause and Effect." *The Photographic and Fine Art Journal* 7 (1854): 270-1.

¹¹ In reviewing the subsequent volumes of the *Photographic and Fine Art Journal*, which ended in 1859, I found no further correspondence by J. Bardwell, nor any response to his request. In fact,

daguerreotypes do not look the same, their optical properties are directly influenced by the minutiae of process.

This study provides new insight for the interpretation, appreciation and understanding of our earliest photographs. It allows historians, curators, dealers, collectors and photographic collection management professionals to more accurately date daguerreotypes by knowing how a particular technique influences appearance, and when that technique was introduced. John Wood writes, "The daguerreotype, like any other art form, demands its own critical vocabulary, its own way of being seen, and its own way of being appreciated."¹² To illustrate Wood's point, many daguerreotypes change much more subtly with viewing angle than merely appearing positive or negative as Barger and others note.¹³ The optical phenomena described by Sutton as *prismatic effect*, refers to a change in image colour from pink to cyan when the viewing angle is altered slightly. Prismatic effect is not present in all daguerreotypes because it is due to specific material techniques that control image particle microstructure. The cyan-magenta hue shift in daguerreotypes having prismatic effect is best seen when the viewing geometry is slightly altered by turning the plate in hand (Fig. 1).

I could only find one article related to the practice of the daguerreotype. Photographers were adopting the new wet-collodion process, which was a much simpler, reproducible technology. Virtually all the articles in this, and Humphrey's Journal, post 1855 pertain to collodion negatives, positives and albumen silver printing.

¹² John Wood, *The Daguerreotype: A Sesquicentennial Celebration*. 1st ed. Iowa City: University of Iowa Press, 1989: 9.

¹³ M. Susan Barger, "The Daguerreotype: Image Structure, Optical Properties, and a Scientific Interpretation of Daguerreotypy." PhD Dissertation, The Pennsylvania State University, 1982. In the abstract Barger writes "The mirror-like substrate gives the daguerreotype a very unusual appearance in that the image may be seen as either a positive or negative according to viewing conditions." Wikipedia has a similar positive/negative description.



Figure 1. Dag Test 3-9-2014. Portrait of Keith F. Davis. Illustration of prismatic effect with a slight change of viewing angle appearing magenta (left) and cyan (right).

In making daguerreotypes for this dissertation, I have used notices of improvements in the art sourced from historical texts as guide to replicate nineteenth century materials and methods as they evolved. Improvements have been located in journals, treatises, manuals and correspondence, and have been selected on the basis of those that improve photographic sensitivity, those that improve tone and contrast, and those that improve spectral response. I have chosen these categories because they represent the main challenges for a practicing daguerreotypist in rendering the values seen in nature, and for live subjects, brief exposures to minimize motion blur was of paramount importance. Exposure times in 1839 with Daguerre's original materials and methods were several minutes depending on the intensity of daylight. In less than a year, with alterations in lens and camera design, and the use of multiple halogens to accelerate the plate, exposure times were reduced extending the use of the daguerreotype from landscape and still-life into the realm of portraiture.

1.2 Introduction: The Daguerreotype Process

Daguerre worked in secret with his partners throughout the 1830s to advance the techniques and materials of photography into a marketable system. Saving pre-market advancements for later chapters, this section is concerned with the system as introduced, complete with an instruction manual providing the means for others to experiment and advance the art. François Arago, perpetual secretary to the Académie des Sciences, presented the Daguerreotype on August 19, 1839 after much anticipation and speculation as to the secret of permanently securing the image created in the camera obscura.¹⁴ Two days later, Alphonse Giroux placed an advertisement in the *Gazette de France* offering the necessary apparatus including a camera, sensitizing box, mercury chamber and a few utensils, though customers had to register for a yet to be printed copy of the instruction manual.¹⁵ Those attempting the process by following the seemingly simple directions laid out in Daguerre's manual were frustrated. Daguerre was reportedly obliged to hold weekly demonstrations of his working methods because

¹⁴ One of the earliest accounts appeared on January 2, 1839 in *Le Drapeau Tricolore*. The author states the secret to the process will be available by subscription in January. On the same day, Daguerre wrote to Isidore Niépce to relay Arago's opinion that the subscription plan was impractical and thought it better that the French government purchase the invention to make it freely available to the nation. Arago introduced the idea to the Académie des sciences on January 7th, pre-empting Daguerre's plan for an exhibition of forty daguerreotypes on January 15th. Daguerre and Niépce's pension was granted by law on June 15th, and the process was revealed on August nineteenth, almost nine months after the first newspaper account. See Ewer, Gary. "The Daguerreotype: An Archive of Source Texts, Graphics, and Ephemera the Research Archive of Gary W. Ewer Regarding the History of the Daguerreotype." http://www.daguerreotypearchive.org/texts/N8390018_LETELLIER_DRAP-TRI_1839-01-02.pdf (Date accessed, 12 Jan, 2013)

¹⁵ Grant B Romer, "Daguerre in the Library." In *Imagining Paradise: The Richard and Ronay Menschel Library at George Eastman House, Rochester*, Steidl 2007: 27-33. Romer writes that the Menschel Library holds seventeen of forty known variants in French and foreign language of Daguerre's manual published in 1839-40. Romer relays Daguerre's surprise after completing his first public demonstration on September 7th, 1839: "I was astonished to see my brochure in everyone's hands, while I myself did not have a copy." Daguerre was waiting for his copy from Giroux, while his students had obtained theirs from La Maison Susse-Frères. The source of this information is Harmant, Pierre G. "Daguerre's Manual: A Bibliographic Enigma." *History of Photography* 1, no. 1 (January 1977): 83.

failure was more likely than success for those attempting the process based solely on textual information.¹⁶

In France, England and America the process advanced quickly through experimentation. So much so that copies of Daguerre's manual were quickly updated when newer information became available.¹⁷ Lerebours published an early manual (translated in 1843) listing the steps involved with the new method compared to Daguerre's old process. There are three significant differences; the first being polish to improve contrast, next the introduction of accelerating substances to improve speed, and last with introduction of gold chloride to brighten and tone the image (Table 1).¹⁸

¹⁶ *The London Journal of Arts and Sciences*. London: Sherwood, Neely, and Jones, 1840: 120-23.

¹⁷ N. P. Lerebours, *A Treatise on Photography; Containing the Latest Discoveries and Improvements Appertaining to the Daguerreotype*. By N. P. Lerebours. Translated by J. Egerton. London: Longman, Brown, Green, and Longmans, 1843: 19. The introduction states, "The third edition of this work, of which we published, in the month of May, 1842, 1,800 copies, having been all sold, we have determined on bringing out a new one. As we could not pass unnoticed the additions and alterations since made in this art, many of which we have ascertained to be useful and valuable improvements, we have written anew all that part which relates to the different operations;"

¹⁸ Fixing the image with gold chloride may seem as a confusing term for readers familiar with photographic processes. The gold toning process literally fixes the image particles firmly to the plate surface making them less susceptible to being wiped away by the slightest touch.

Robinson: The Techniques and Material Aesthetics of the Daguerreotype

Table 1. Adapted from *A Treatise on Photography* by N. P. Lerebours.
Translated by J. Egerton. London.

Old Method.	New Method.
1. Rub the plate with oil, clean off the oil, heat the plate strongly, and polish the plate strongly, with pounce or tripoli.	1. Polish the plate.
2. Apply a coating of iodine (of a golden-yellow colour.)	2. Apply the coating of iodine.
3. Subject the plate to the action of the camera.	3. Subject to the plate to the vapours of bromine-water or other accelerating substances.
4. Subject the plate to the action of mercurial vapours.	4. Expose the plate to the camera.
5. Deprive the plate of its sensitive coating in the hyposulphite bath.	5. Subject the plate to the action of mercury.
6. Wash the plate with distilled water in a boiling state.	6. Deprive the plate of its sensitive coating in the hyposulphite bath.
	7. Fix the image by means of the chloride of gold, according to Mr. Fizeau's process.
	8. Wash the plate with filtered or distilled water.

Reading the above might serve to help identify a daguerreotype amongst a pile of other nineteenth century photographic types in an antique shop, but is insufficient knowledge for someone wishing to make a daguerreotype. Imagine asking a musician to play a score after reading a review of a performance. Learning to play music requires a tutor-student relationship involving demonstration, repetition and

practice. It is an arduous task aided by a precise means to transfer musical notation between artists. This notation, known as sheet music, translates tacit knowledge, (know-how of music learned through playing) into a universal language understood by those with the ability to read it. The daguerreian *sheet music* (my analogy for literature) does not have the precision of musical notation. Descriptive terms for the appearance of a daguerreotype are best supported by visual examples.

Tutorials and demonstrations continued to be an important means of obtaining practical knowledge throughout the first decade of photography.¹⁹ William H. Sherman recalls the challenges facing daguerreians, particularly those outside of major cities, who had limited access to available literature or a fraternity for the sharing of information:

It would be difficult for photographers of the present day to realize how difficult it was, way back in the early forties-say any time previous to '45 or '46... There was then no literature of the art. No handbook had been printed; no journals were published. Those who pretended to initiate the candidate into the mysteries were, with but few exceptions, in need of being themselves taught in the first principles of the knowledge which they professed to impart.²⁰

As Sherman points out, tutors often knew little more than their students and textual sources in the mid-1840s were scarce. The greatest teacher was the process itself with knowledge gained tacitly through experience and observation. Gradually, tidbits of information would be shared, traded and sold between daguerreians. In March 1846, George Pyle, a novice daguerreotypist paid fifty dollars to John E.

¹⁹ Pamela Powel, "The Daguerreotype: Portraiture at the Dawn of Photography." In *The Daguerreian Annual: Official Yearbook of the Daguerreian Society* 2000: 60-1. Throughout the entire daguerreian era, those skilled in the art would provide lessons for a fee. John Mayall provided lessons to George Pyle in 1846 for fifty dollars (worth approximately 1600 dollars in 2017). Pyle's notebook contains valuable recipes for silvering, sensitizing and gilding solutions. Pyle family fonds, Chester County Historical Society, West Chester, PA.

²⁰ William H. Sherman, "The Rise and Fall of the Daguerreotype." *The Photographic Times and American Photographer* 21 (1891). Reprinted with an introduction by Gary W. Ewer in *The Daguerreian Annual: Official Yearbook of the Daguerreian Society* 1997: 209-25.

Mayall for “all the knowledge on the subject” he possessed.²¹ Pyle visited him seven times for lessons and recorded advice on plates, polishing, galvanizing, iodizing, gilding and quickstuffs (the term for chemical accelerators) in his notebook.²² Mayall later wrote to Pyle before departing Philadelphia for London England that in the two-months that had elapsed since the lessons “nothing fresh has turned up of any consequence, except that a new quick, much easier manufactured than the one I gave thee & will answer just as well” and followed with the details of its preparation.²³ In the 1840s arts and science journals, such as *Comptes rendus hebdomadaires des séances de l'Académie des sciences*, *L'Artiste*, *The Literary Gazette*, the *Journal of the Franklin Institute* or *The London Journal of Arts and Sciences* contained articles describing improvements in photography, but Sherman did not cite these sources. Robert Hunt, John Draper, Antoine Claudet and others published their experiments in these varied journals and information diffused slowly from there until the first journals specific to photography collected and republished the information in a single volume. *The Daguerreian Journal* from America, however, did not appear until November 1, 1850, and its French equivalent, *La Lumière*, first appeared February 9, 1851.

The literature about the daguerreotype process often contains vague and contradictory information.²⁴ The reason is that the process is a manual art and

²¹ J. E. Mayall, "Receipt from John Mayall to George Pyle for Instructions in the Art of Daguerreotype Pictures." *Gift of Francis C. Pyle Estate*: The Chester County Historical Society, April 1, 1846.

²² George Pyle, "George Pyle's Lesson Book Containing Notes from Mayall's Lectures." *Gift of Francis C. Pyle Estate*: The Chester County Historical Society, 1846. Mayall concluded his lessons with the *Law of Chances*, indicating that the odds of success improved with repeated trials, provided that each trial is performed under identical conditions. This is a sure indication of the fickle nature of the daguerreotype process.

²³ J. E. Mayall, "Letter from John E. Mayall to George Pyle." In *Gift of Francis C. Pyle Estate*: Chester County Historical Society, 1846. Mayall became one of the pre-eminent daguerreian operators in London. In 1847 he exhibited over 140 daguerreotypes, many of them full-plate allegorical studies, portraits of noted scientists, and landscape views including a panorama of Niagara Falls. For a list of the plates see Taylor, Roger. "Photographic Exhibitions in Britain 1839 - 1865," online. <http://peib.dmu.ac.uk> (Date accessed, 18 March 2017)

²⁴ Charlie Schreiner, "In Their Own Words." *The Daguerreotypist: a Newsletter for Contemporary Daguerreotypists* 2012, no. March 30, 2012 (1998). Charlie Schreiner, a contemporary daguerreotypist conducted a search of fifty nineteenth century sources for recommendations on the best sensitizing colours for bromide of lime. He charted twenty-six

workers developed their own method of practice. The materials and steps to follow were available in texts, but the degree of hand pressure used to polish the plate, the angle the plate is held in hand to view the sensitizing colours, the hand and eye co-ordination required to move the alcohol lamp beneath the plate during gilding, and the precise moment to stop gilding before the image exfoliates and is destroyed, is knowledge only gained through experience. This knowledge is with the practitioner, not in the literature, but is essential to produce a daguerreotype.

A major contribution of this dissertation is that daguerreotype practice is replicated following materials and methods *chronologically*. In other words, images have been made that conform to the methods of 1839 and continue according to improvements reported in the literature. The results serve as a reference for comparison, visually, materially, and in some cases analytically, with historical daguerreotypes. To evaluate an image based on its apparent quality, one must be conscious of the material state of the art at the time of its making. It is unfair to compare a view of the east facade of the Propylaea in Athens by Joseph-Philibert Girault de Prangey made in 1842 with a similar view by Baron Jean-Baptiste-Louis Gros made in 1850 (Fig. 2).²⁵ ²⁶

opinions and found, "...the recommended colors and proportions of iodine and bromine by these daguerreotypists are all different."

²⁵ Joseph-Philibert Girault de Prangey, "Athènes. 1842. Propylées. Pris de l'intérieur." Christies, Important Daguerreotypes by Joseph-Philibert Girault de Prangey from the Archive of the Artist - Part II: Tuesday 18 May 2004, Lot 91. Athens, 1842. This image is laterally reversed. Girault de Prangey's intention was to publish engravings after his daguerreotypes. Having laterally reversed daguerreotypes would be to his advantage. Surveys of three Christie's auction catalogues (2003, 2004, 2010) provide an excellent overview of the varied image quality of his work.

²⁶ Jean-Baptiste-Louis Gros, "View of the East Facade of the Propylaea on the Acropolis." Collection: Centre Canadien d'Architecture/Canadian Centre for Architecture, Montreal. Athens, 1850.

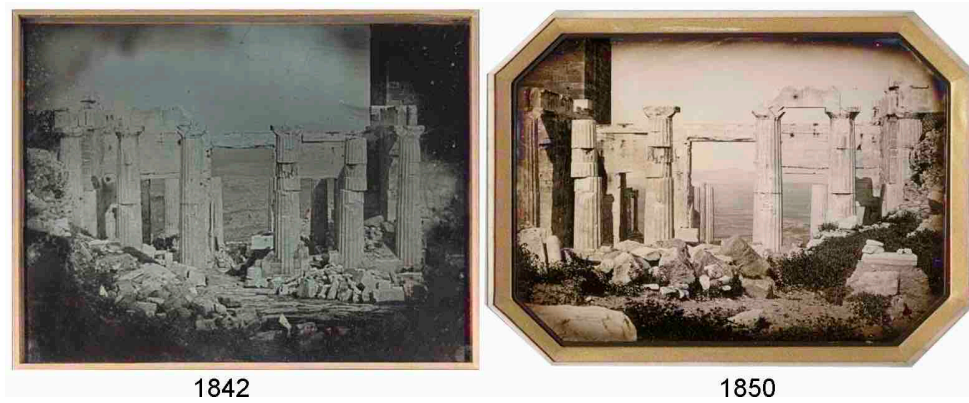

Figure 2. Joseph-Philibert Girault de Prangey (left) and Jean-Baptiste-Louis Gros (right). Daguerreotypes of the east facade of the Propylaea from the same vantage point.

Both images have the detail and resolution that daguerreotypes are renowned for, but the similarity ends there. The Girault de Prangey view, technically one of his most accomplished images, has an overall bluish and pewter-grey image tone. Gros' image, on the other hand, has very warm tones, with pearlescent greens and pinks, brilliant highlights and uniform tonality throughout. The difference is due to variations in the daguerreotype process; the latter plate by Gros was made by more refined means. My dissertation provides reasons, based on experiment rather than speculation as to why a particular daguerreotype looks the way it does. For an example of speculation, Stephen C. Pinson, in his catalogue of the known works of Daguerre writes about *View of Notre Dame de Paris, from the Pont des Tournelles*:

This daguerreotype is one of several that have been attributed to Daguerre based upon supporting evidence and/or qualities of the plate and image, rather than on Daguerre's signature...Helmut Gernsheim, who purchased the plate from an English dealer in 1950, believed that Daguerre made the daguerreotype because of its physical characteristics (the lack of gold toning and the overall gray tonality, which suggests the use of salt as a fixing agent and the sensitization of the plate with iodine alone)...²⁷

Pinson suggests that the look of this plate is partly due to having been fixed with a salt solution. In my research I have found the use of salt water for fixing has

²⁷ Stephen C. Pinson, *Speculating Daguerre: Art and Enterprise in the Work of L. J. M. Daguerre*. University of Chicago Press, 2012: 210.

no effect whatsoever on the appearance of a daguerreotype. Furthermore, singly sensitized (iodine only), un-gilded plates commonly have bluish, pewter-gray image tone, but not always. Some singly sensitized and un-gilded plates exhibit neutral to warm tones visually indistinguishable from multiply sensitized, gilded plates, proving that Gernsheim, followed by Pinson, have attributed Daguerre as the maker of *View of Notre Dame de Paris* based on possibly false assumptions.²⁸ The look of the plate is important, not only for aesthetics, but for historical reasons. The plate is a source of information about dating, working methods or attribution, and origin if the viewer has the ability to decipher it materially with the new information provided by my research. The next section illustrates the human factor in daguerreotype making.

²⁸ As Pinson's book *Speculating Daguerre* was going to press a triptych of full-plates was re-discovered at the Imperial Academy of Art, Saint Petersburg. Daguerre sent these as a gift to Czar Nicolas I and they are the best preserved of all his known works. They have brilliant neutral tones rather than bluish pewter-gray. I have produced several salt-fixed images and they too are neutral toned.

1.3 Introduction: The Daguerreotype and Human Agency

Bardwell recognized that daguerreotypes from different makers can appear significantly different in tone, contrast and image quality.²⁹ These visual differences are due to complex variables of plate preparation, sensitizing, development and finishing that remain entirely in the control of the artist. Each practitioner adopted a preferred way to prepare his or her plates or chemicals. Some methods were developed through experimental trials and became closely guarded secrets. J. M. Skegagur (sp) wrote to a colleague in 1843 that a great secret, known by few, was the addition of silver nitrate to the gold toning solution.³⁰

Secrets aside, there are excellent primary sources for technical history but they leave gaps in the historical record. The Anthony prize contestants who provided inadequate details of their working methods is a prime example. In 1853 Edward Anthony, former daguerreian and supplier of photographic apparatus and materials, offered an ornate silver pitcher valued at five hundred dollars (first prize) and two silver goblets (second prize) for the all-around best set of daguerreotypes submitted in secret and judged by an expert panel. A stipulation of the contest required entrants to include a description of their materials and processes. His motivation was to elevate the daguerreian art by publishing the materials and methods used by the contest winners, and sell more of the preferred supplies. Snelling was disappointed with the apathetic response considering only ten daguerreians entered the competition. He chastised the contestants for not pushing the boundaries of their day-to-day practice because out of forty entries

²⁹ J. J. Bardwell, "Cause and Effect." *The Photographic and Fine Art Journal* 7 (1854): 270-1.

³⁰ J. M. Skegagur [sp], "Letter to J. H. Mifflin Esquire, Fellow Daguerreian in Savannah Georgia." National Gallery of Canada collection, date Feb. 16, 1843. This handwritten letter gives a complete account of the state of the art in this early period. Gold toning had just recently been introduced into practice and the precise formula is given. Skegagur (sp) writes "this is considered a great secret and there are but two besides myself who know it...Mr. White and Mr. Chilton. that is this Exact receipt others have it partially." This formula is altered from Hippolyte Fizeau's original method published in *Comptes rendus hebdomadaires des séances de l'Académie des sciences*, August 1840, in that it also includes seven grains of silver nitrate in addition to the usual gold chloride and sodium thiosulfate chemicals. This early letter is the only primary source that mentions the use of silver nitrate in mixing the gilding solution and there is no evidence that the technique was adopted in later practice.

only two were tableaux vivant, the rest being routine portraits. He further complained of the scarcity of details supplied by some of the participants. "We should be pleased to receive more detailed descriptions from those gentlemen who have been so very brief in giving their process. They hardly come up to the requirements of Mr. Anthony's proposals_ Ed. P.A.J."³¹

Many of the preferred materials and chemicals used by the contestants were listed by the supplier's name, such as Lewis' Buff Lathe, Davie's Rottenstone, Chilton's Iodine, and Hesler's Chloro-iodide of Lime. The precise chemical mixtures of these ready-made materials were withheld as trade secrets. The *Photographic and Fine Art Journal* text indicates that although there are some steps of the process in common between each contestant, each entrant's process was unique. Snelling's article may be the best primary source of technical history for comparing the working methods from different studios, however, since it is only concerned with the art as practiced in 1853, it cannot help in understanding the evolution of materials and methods since 1839.

Even if it were possible to compare the work of several studios, with their working methods known, another difficulty is that image quality can sometimes vary significantly between plates from the same maker. Plate-to-plate variability is a concern for practitioners of the daguerreotype and a common cause of failure is the sensitizing process. With gelatine emulsion and wet-collodion systems the silver-halide balance is constant allowing photographic sensitivity to be predictable. Image contrast is controlled through exposure and development. With the daguerreian system the balance of halides is formed on each plate individually. Sensitivity and contrast is determined by this balance and too little or too much of iodine or bromine will, more often than not, result in miserable failure. Even and predictable sensitizing also requires a perfectly clean and polished silver surface. One of the many challenges with sensitizing is to regularly add the correct

³¹ Henry H. Snelling, ed. "The Photographic and Fine Art Journal." 7 (1854): 6-11. The two full-plate tableaux vivant compositions were George Bernard's *A Woodsawer's Noonning*, reproduced as a tipped in albumen print in the journal issue (the original daguerreotype has been lost), and Gabriel Harrison's *The Infant Savior*.

proportion of accelerator (bromine) to each plate. Noël Paymal Lerebours recommended for uniform sensitizing to use a precise measure of bromine diluted in water and discard it after each use.³²

Lerebours' solution dates to the early period when daguerreotypists were just beginning to use bromine and understand how to manage it. Discarding the highly volatile bromine water after each trial to manage consistency was time consuming and impractical for a busy studio, not to mention generating a considerable amount of toxic vapour that had to be neutralized. Daguerreians eventually learned to prepare dry sensitives by mixing concentrated liquid bromine, and chloro-iodine into slaked lime (calcium hydroxide) powder. It sometimes happens that even though the plate is exposed to the bromine vapour for the same time as a previous test, with the same room temperature and humidity, and the sensitizing colour appears identical to the previous plate, it might be insufficiently sensitized if the vapours contained within the sensitizing box are not allowed to recover fully.³³ In this instance there is no visual clue that there may be a problem until the plate is developed with mercury vapour and fixed. The effect of insufficient bromine or silver halide mixture imbalance will result in insensitive zones rendering dark patches that may easily be misinterpreted as poor polishing or defects due to moisture. When problems arise one proceeds to make more experiments following inductive reasoning to determine the cause of the failure (and may proceed down a blind alley if the cause is misjudged). Variables are continually tweaked, according to educated guesses based on experience, cause and effect is observed, and trials and adjustments repeated to hopefully achieve better results.

This account of the Anthony Prize winners, and difficulties with sensitizing, emphasize that in order to study the materials and processes of the daguerreotype

³² N. P. Lerebours, *A Treatise on Photography; Containing the Latest Discoveries and Improvements Appertaining to the Daguerreotype*. By N. P. Lerebours. Translated by J. Egerton. London: Longman, Brown, Green, and Longmans, 1843: 40.

³³ Jean-Baptiste-Louis Gros, *Quelques notes sur la photographie: Sur plaques métalliques*, revised 2nd edition, 1850: 50. Baron Gros used of two sets of sensitizing boxes when he wished to prepare several plates quickly. He noticed that the sensitizing boxes "worked slower" as the day progressed.

one must recognize that the process is entirely under the control of the maker. The process is not the same for everyone, and can vary within the oeuvre of a single maker as techniques and materials were modified over time, or perhaps over the course of a single day, to achieve optimum results. Though the plate, its preparation and sensitizing have the greatest effect on the outcome, and most daguerreian manuals emphasize these steps in the process, camera exposure, mercurial development and toning also contribute visually to the finished image.³⁴ This dissertation is arranged according to steps of the daguerreotype process beginning with preparation of the silver plate, through sensitizing, exposure, development and finishing because each step serves as the foundation for the next. Failed technique during one step can rarely be recovered by alterations to the next.

It is not my intention here to argue the artistic merit of nineteenth century daguerreians but to note that the process, contrarily, has been viewed as automatic or mechanical in nature. This notion originates with Daguerre himself when he described it as a “chemical and physical process which gives nature the power to reproduce herself”.³⁵ To continue this point, Scovill and Co. packaged daguerreotype plates in boxes adorned with a woodcut label showing an anthropomorphized Sun painting a picture of a posing Earth.³⁶ I re-establish an awareness of human agency and rediscover tacit knowledge of the past when making new daguerreotypes using diverse materials and methods guided by historical material culture in the form of texts and images. In doing so, I make

³⁴ Henry Hunt Snelling, *The History and Practice of the Art of Photography, or, the Production of Pictures through the Agency of Light: Containing All the Instructions Necessary for the Complete Practice of the Daguerrean and Photogenic Art, Both on Metallic Plates and on Paper*. G.P. Putnam, 1849: 61- 76. Under the chapter heading, Daguerreotype Process, Snelling devotes eight pages to plate preparation and sensitizing, one page to development and three pages to gold toning. This is typical of many daguerreotype manuals.

³⁵ Louis Jacques Mandé Daguerre, "Daguerréotype." *Image: The Journal of the George Eastman House of Photography* 8, no. 1 (March 1959 1838): 4.

³⁶ Matthew R. Isenburg, "Don't Forget to Check Labels for Dating Clues." *The Daguerreian Annual: Official Yearbook of the Daguerreian Society*, 1992: 100-03.

Robinson: The Techniques and Material Aesthetics of the Daguerreotype

explicit the effects of known causes, such as polishing marks left by the maker, or the reasons why some plates appear blue.

1.4 Introduction: The Daguerreotype and Material Culture

In order to investigate the material practices of the daguerreotype it is necessary to begin with the nineteenth century accounts. These consist of correspondence by historical actors, technological histories contained in treatises and manuals printed over fifteen years of the daguerreian era, contemporary journals of scientific societies and journals dedicated to photography. I have researched these sources to locate details of practice that are reported to improve photographic speed, tone or spectral sensitivity of the daguerreotype process. This information then leads to questions and hypotheses that are tested by experimental synthesis. Synthesis is a scientific method of replicating a system (the daguerreotype) to understand the effects (appearance) of known causes (working methods). I achieve this by designing experiments to evaluate variables of the daguerreotype system that claim to improve the art according to the above criteria.

Replicating materials and processes used by nineteenth century practitioners is effective in recovering tacit knowledge, or unwritten human agency.³⁷ The results of these experiments show significant findings that allow for a revised understanding of photographic history based on the materiality of daguerreotypes. Douglas R. Nickel, in *Notes Towards New Accounts of Photography's Invention* compares the standard histories by Werge, Eder and Newhall which emphasize artistic genres and significant makers, with two more recent histories, *Before Photography: Painting and the Invention of Photography* by Peter Galassi and Geoffrey Batchen's *Burning with Desire: The Conception of Photography*. Nickel argues that both Batchen, whose model of invention is founded on the idea of photography, and Galassi who asserts that photography originates in a pre-photographic vision from the Renaissance, "result in the suppression of the active

³⁷ Archaeologists have long practiced replicative technologies to understand the material culture of past civilizations. The established term for this is Experimental Archaeology. EXARC is an ICOM Affiliated Organization representing archaeological open-air museums, experimental archaeology, ancient technology and interpretation. EXARC publishes an online journal <http://journal.exarc.net/category/experimental-archaeology> (Date accessed, 21 May 2017)

role of individual agents".³⁸ Nickel advocates for a more inclusive framework presented by Bruno Latour, historian of science, who connects actors, objects and networks both conceptually and materially.³⁹ This leans towards a material turn, and Nickel proposes that we begin by examining heuristics and "return to developmental models...but with a new set of tools, methods and questions."⁴⁰ This is my approach, which differs from other histories in that I address not only the materiality of the daguerreotype as image, but also the materiality of the daguerreotype as process.

Edwards and Hart, editors for *Photographs. Objects, Histories: On the Materiality of Images* state that awareness of the materiality of photographs is crucial to understanding them, and knowing the causal photographic history will help explain why photographs look the way they do.⁴¹ Each contributor to *Photographs, Objects, Histories* chose works that have a *hyper-materiality* to illustrate their essay; a tintype set with hair in a locket, photographs in albums, a mixed box of anthropologic images, photographs as playing cards or incorporated into religious symbols, and a daguerreotype souvenir. The authors, according to the editors, are "critically focused on the role of the material in understanding those

³⁸ Douglas R. Nickel, "Notes Towards New Accounts of Photography's Invention." In *Photography and Its Origins*, edited by T. Sheehan and A. Zervigon, 104-16: Taylor & Francis, 2014: 114.

³⁹ Nickel referenced Latour's *Science in Action: How to Follow Scientists and Engineers through Society*. Milton Keynes: Open University Press, 1987. This book became the foundation for what was later named the Actor-Network-Theory (ANT). For a definition of ANT see John Law, "Notes on the Theory of the Actor-Network: Ordering, Strategy, and Heterogeneity." *Systems practice* 5, no. 4 (1992): 379-93. ANT is particularly applicable to the development of daguerreotype technology, for example but not limited to the actors and the close-knit network centred in Holborn Bars, London in 1839-40 discussed in Chapter 5, and the development of optics presented in Chapter 6.

⁴⁰ Nickel, "Notes Towards New Accounts of Photography's Invention." 114. For a history of material culture studies and the 'material turn' see Dan Hicks, "The Material-Cultural Turn: Event and Effect." In *The Oxford Handbook of Material Culture Studies*, edited by Dan Hicks and Mary C. Beaudry, 25-98. Oxford, 2010. https://www.academia.edu/1527571/The_Material-Cultural_Turn_event_and_effect (Date accessed, 31 May 2016)

⁴¹ E. Edwards and J. Hart, *Photographs Objects Histories: On the Materiality of Images*. Taylor & Francis, 2004: 6-7. This resource is a collection of essays arranged by the editors to illustrate that the materiality of a photograph is integral to understand its meaning, and that each contribution provides a unique model to serve as a guide to engaging with the materiality of photographs.

images.”⁴² Their premise is that the standard histories of photography emphasize the aesthetic and fall short in acknowledging the materiality of photographs. For example, a reproduction of a stereo daguerreotype by Antoine Claudet was cropped to illustrate the tableau as a singular image in Beaumont Newhall’s *History of Photography*.⁴³ Newhall is interested in its artistic merits and presents a two-dimensional tableau vivant. Claudet, the maker of the image, is equally concerned with replicating three-dimensional human vision. Newhall’s choice to illustrate only one half of the stereo pair negates one of the prime motivations for its creation; its own attempt at hyper-reality.

I use the term hyper-materiality to mean images with unusual presentations or display scenarios. A methodology of analysis that encompasses the entire image/object does not address the materiality of photographs alone and seems to be the practical way for these authors to proceed.⁴⁴ For example, Joan Schwartz’s essay, *Un Beau Souvenir du Canada*, addresses the materiality of the daguerreotype by reiterating its unique visual qualities as a precious, infinitely detailed image, but extends her analysis to include the case, maker, subject, and context of its creation.⁴⁵ As a social historian, Schwartz’s methodology begins with the image/object as a whole and analyses each component, whereas my

⁴² Edwards and Hart, *Photographs Objects Histories: On the Materiality of Images*. Taylor & Francis, 2004: 2.

⁴³ Newhall, Beaumont. *The History of Photography: From 1839 to the Present*. Fifth ed.: Museum of Modern Art, 1982: 35. Respectively to this image Geoffrey Batchen writes, “In terms of reproductions in photographic histories, the image is consistently privileged over the daguerreotype’s casing...” See Batchen, “Ere the Substance Fade.” In *Photographs Objects Histories: On the Materiality of Images*, edited by E. Edwards and J. Hart, 2004: endnote 4.

⁴⁴ Alan Bekhuis and Jillian Pichocki, “Image Object: Contemporary Daguerreotypes.” edited by Center for Alternative Photography Penumbra Foundation. New York: Blurb, 2013. I borrow the term Image/Object from the title of a recent exhibition of contemporary daguerreotypes. Alan Bekhuis and Jillian Pichocki, “Image Object: Contemporary Daguerreotypes. Seventy-four daguerreotypes made by thirty-three artists were exhibited. The hand-of-the-maker was readily apparent between the works exhibited. Many of the contemporary daguerreians in this exhibition are at the tyro stage with the materials that accounts for some of the variability of image tone, and quality. Bardwell also observed this phenomenon, on a more refined level, in 1854 when he compared the work from established galleries.

⁴⁵ Joan M. Schwartz, “Un Beau Souvenir Du Canada: Object, Image, Symbolic Space.” In *Photographs Objects Histories: On the Materiality of Images*, edited by E Edwards and J. Hart, 116-31: Taylor & Francis, 2004.

investigation, from a process historian's perspective, involves synthesizing the materials and craft that combine to produce the image itself. I do not address the materiality of the extraneous housing because it has nothing to do with the daguerreotype process. This allows me to explain empirically why daguerreotypes images look a particular way related to the processes and materials of their making. As a practitioner, I am able to extract meaning in a way that historians cannot access or speak about. Using the model set out by Schwartz, I extend its usefulness with an artisanal skill-set to shed light on materiality of the daguerreotype plate itself and understand the most effective methods of practice. The daguerreotype is challenging to understand solely by reading historical works when the tacit or secret knowledge of practice is buried with the maker.

There have been several attempts to rediscover the tacit knowledge in different fields of art history and history of science. David Hockney, in *Secret Knowledge: Rediscovering the Techniques of the Old Masters*, for example re-enacted the use of the camera lucida, concave mirrors and simple lenses to project or reflect images onto canvas and show how these optical devices may have been used as early as the fifteenth century to create greater realism in art. Hockney, an artist, and Charles Falco, an optical scientist, theorized that artists such as Holbein, Caravaggio and van Eyck made use of optics to aid them in their painting.⁴⁶ The secret knowledge claimed to be uncovered with their work is the understanding of how primitive optics might have been used to reflect or project images onto a painter's canvas. Although optical characteristics can be deciphered from reference points on paintings using computer modelling, working distances, focus limitations, and the utility of optics is much easier to grasp by actually using the

⁴⁶ Charles M. Falco, "The Hockney-Falco Thesis." <https://wp.optics.arizona.edu/falco/art-optics/> (Date accessed, 29 March 2017) The Hockney-Falco thesis has generated great controversy among art historians, optical scientists and artists. It is not my intention to support or argue against their theory that great masters used optics as a shortcut in their work. In relation to my work it is not important to determine definitively if Holbein ever traced over a projected optical image, what is noteworthy is Hockney's methodology. To test his hypothesis, Hockney actually replicated the use of concave mirrors and lenses to form an image on canvas and in doing so was able to recognize the limitations and advantages of optical projection. This experience gave Hockney the insight and ability to recognize optical artefacts in historic works.

tools. This methodology is valuable for historical study in that, through re-enactments, the researcher gains sensory and gestural experience that may reveal details from past practice that was never recorded, or perhaps clarify vague meanings in historical texts.

Historians of Science, Fors, Principe and Sibus in *From the Library to the Laboratory and Back Again*, acknowledge that sensual and gestural information is difficult to transmit textually, or omitted from the literature altogether as being “considered matters-of-course by the original practitioners” thereby existing solely as a component of tacit knowledge.⁴⁷ Sibus specifies a subset of tacit knowledge as “gestural knowledge” which is learned by practical engagement with materials and methods which “opens the way for a richer, deeper, and more accurate interpretation of textual sources and objects.”⁴⁸ This concept of ‘gestural knowledge’ is useful when studying the daguerreotype because it informs the reading of historic technical manuals, although a high degree of skill is a pre-requisite to conduct the experiments for this dissertation.

Gestural knowledge aside, critics argue that re-enactments require a degree of similarity with historical practice. David Stork argues that Hockney’s use of historic optical techniques is flawed because there is little historical evidence from the period in question in terms of texts and material culture to show that optics of sufficient quality were available to artists. He stresses, “Re-enactments with modern, store-bought mirrors do not mimic past historical, material conditions.”⁴⁹

⁴⁷ Hjalmar Fors, Lawrence M. Principe, and H. Otto Sibus, "From the Library to the Laboratory and Back Again: Experiment as a Tool for Historians of Science." *Ambix* 63, no. 2 (2016): 85-97. Sibus and Fors are faculty of The Office for History of Science, a research unit within the Department of the History of Science and Ideas at Uppsala Universitet, Sweden. They direct ongoing research on the Experimental History of Science. See <http://www.vethist.idehist.uu.se/index.php/research/project/2/eng/> (Date accessed, 22 March 2017)

⁴⁸ Fors, Principe, and Sibus, "From the Library to the Laboratory and Back Again: Experiment as a Tool for Historians of Science." (2016): 92. Sibus quips, "If a picture is worth 1000 words, the experience of reworking a process is worth even more"

⁴⁹ David G. Stork, "Computer Vision and Image Analysis in the Study of Art: Hockney Theory." <http://www.diatrope.com/stork/FAQs.html>. (Date accessed, 31 May 2013)

Sven Dupré restructured Stork's position in placing historical constraints on the Hockney-Falco thesis by asking if the material evidence is compatible, and secondly if the textual evidence is compatible with the thesis.⁵⁰ In this case the material evidence is incompatible because fifteenth century mirrors and lenses, being imperfect, are incapable of projecting an image with sufficient brightness and clarity, compared to the optics Hockney used for his re-enactment. The textual evidence is also incompatible because it does not exist to explain the technique re-enacted. The study of daguerreotypes is not hindered by the lack of original material. Textual evidence is plentiful, albeit full of conflicting advice from the late daguerreian period. Limited information exists for the incunabula period from 1839 to 1844, but it is very sparse concerning Daguerre's work leading up to 1839.⁵¹ Replications conducted for this thesis have served to uncover new information about all periods of daguerreian history and its objects. To conform to historical practice during re-enactments, I use authentic process materials, apparatus, optics, and reference historic daguerreotypes thereby meeting Stork's criteria in that my work maintains verisimilitude with techniques and material conditions of the past. In the following chapter on Research Methodology, I explain how my materials and methods have the requisite degree of similarity with historical practice.

Some have argued that information provided by re-enactments cannot be certain because exact replication of past material conditions and experimental reproducibility is impossible. Melvyn C. Usselman et al, in *Restaging Lebig: A Study in the Replication of Experiments* outlines Henry Collins' position that the lack of gestural knowledge necessary to perform historic experiments defeats any attempt at replications based on textual sources alone.

⁵⁰ Sven Dupré, "Introduction. The Hockney-Falco Thesis: Constraints and Opportunities." *Early Science and Medicine* 10, no. 2 (2005): 129.

⁵¹ I adopt the term incunabula to refer to the early developmental stages of the daguerreotype process. I define this as the period from 1839 to 1844.

Craft knowledge is necessary to every experiment; it can only be communicated directly; it is tacit and often even invisible; and there can be no algorithms or sufficient verbal instructions that will allow replication.⁵²

To counter Collins, Usselman proposed that exact replications are unnecessary; rather replications that yield results similar enough to prior practice to compel acceptance have *convincing* replicability. Usselman was successful in guiding two students with no prior experience through several iterations of chemical analysis using a replica model of Liebig's kaliapparat; his invention comprised of multi-globed chemical glassware to contain combustion gasses. The students proved capable of developing the tacit knowledge to judge the quality of their combustion experiments, and their results matched those reported 150 years earlier by Liebig and his students. Furthermore while performing the replications, Usselman and his team were able uncover the rational behind the modifications and improvements that Liebig made to his kaliapparat between 1831 and 1837. *Restaging Liebig* clearly illustrates the importance of informed historical reproductions and the authors concluded that their experience "confirms the importance of understanding the malleability of experimental systems".⁵³ A malleable experimental system is an excellent descriptor for the materials and methods of the daguerreotype process. I understand the daguerreotype system and have the pre-requisite gestural knowledge from nearly two decades practical experience to design informed historical reproductions. The notion of 'convincing replicability' serves as a guiding principle for my purposes. In replicating historic daguerreian methods, I employ optics from the period, and use materials and techniques as necessary to avoid anachronism and conform to the time period in order to extract precise information about the experimental question.

This approach resides in a relatively recent movement for historical studies that combine textual information with material culture. The *material turn* has gained traction within the last decade, and additionally authors such as Pamela H. Smith

⁵² Melvyn C. Usselman, Alan Rocke, Christina Reinhart, and Kelley Fousler, "Restaging Liebig: A Study in the Replication of Experiments." *Annals of Science* 62, no. 1 (2005): 50.

⁵³ Usselman et al. "Restaging Liebig" (2005): 54.

have brought forth the recognition of artisanal knowledge to complement and support intellectual knowledge.⁵⁴ Artisanal knowledge exists tacitly within the craftsperson and is specifically learned through experience and apprenticeship. Such know-how, for the most part, lies outside of the textual record. Pamela H. Smith in *The Body of the Artisan* argued that skilfulness in reproducing nature was a measure of an artisan's craft knowledge and such information could be gleaned from their practices, recipes and the objects left behind. She noted that "Art historians...have rarely made their focus the artist's understanding of the process..."⁵⁵ The daguerreotype process eclipsed painting, drawing and sculpture (the artworks addressed by Smith) at reproducing nature in microscopic detail with great efficiency. Nevertheless, as the authors of *Ways of Making and Knowing: The Material Culture of Empirical Knowledge* recognize, and is true with daguerreotype process, "efforts to find better methods of making also drove the search for fresh and accurate information".⁵⁶ Seeking better methods to replicate nature in terms of efficiency, tone and spectral sensitivity was the driving force behind the evolution of the daguerreotype.

My work differs from that of Smith and the contributing authors of *Ways of Making and Knowing*, in that in addition to making use of material culture in the form of practices, recipes and objects, I replicate or re-enact the practice of the daguerreotype to understand those better methods sought by daguerreians, which in turn determines why daguerreotypes look the way they do. Furthermore, the act of replicating offers fresh insight into tacitly held knowledge about the daguerreotype process or an historical actors' methods. Sibum refers to this as experimental history to "get access to hitherto unrecognized dimensions of past

⁵⁴ P.H. Smith, A.R.W. Meyers, and H. Cook, *Ways of Making and Knowing: The Material Culture of Empirical Knowledge*. University of Michigan Press, 2014. The editor's preface opens with "The 'material turn' is surely upon us. For more than a decade historians of science and of the book have been demonstrating...that the development of knowledge in early modern and modern Europe was bound up in materialities."

⁵⁵ P.H. Smith, *The Body of the Artisan: Art and Experience in the Scientific Revolution*. University of Chicago Press, 2004:21.

⁵⁶ Smith, Meyers, and Cook, *Ways of Making and Knowing*. University of Michigan Press, 2014:10.

practice”.⁵⁷ Sensual information stemming from the replication of past practice can provide otherwise unobtainable hints to the historian regarding the origin of ideas or subsequent pathways followed by historical actors, and resolve ambiguities in textual records.⁵⁸ This is particularly true in my investigations related to Daguerre’s work prior to 1839 faced with ambiguous textual information and relatively scant material extant from his hand. Yet Sibum, an historian of science is careful with his terminology preferring to use the terms re-working, re-enacting, and restaging because these “place emphasis on the doing rather than the outcome.”⁵⁹ Reproduction and replication, terms which Sibum avoid, refer to the product of the work. Both process and product are important in my experiments because the daguerreotype is a visual object, and only by looking at the results am I able to understand the cause and effect of tested variables.⁶⁰ Throughout this dissertation I use the terms re-enactment and reproduction to refer to my experiments because they are equally valid in principle to describe my research.

In this section I have discussed how re-enactment can provide fresh insight into the material culture of an art-form or process, and how it is critically important that the re-enactments are compatible with the material conditions of the time. Re-enactments are determined from textual sources that report advancements in the daguerreotype process to improve speed, tone or spectral sensitivity. The next section discusses the different approaches historians have used to engage with the literature of the daguerreotype.

⁵⁷ L. Auslander, A. Bentley, L. Halevi, H. Otto Sibum, and C. Witmore, "Ahr Conversation: Historians and the Study of Material Culture." *American Historical Review* 114 (2009): 1358. Sibum points out that literary sources such as laboratory notebooks often provide insufficient detail to understand how a device worked. Furthermore, prerequisite knowledge to perform an experiment is rarely detailed in such sources having been “written for the historical actors themselves, and not for the historians who try to make sense of the past”.

⁵⁸ Hjalmar Fors, Lawrence M. Principe, and H. Otto Sibum, "From the Library to the Laboratory and Back Again: Experiment as a Tool for Historians of Science." *Ambix* 63, no. 2 (2016/04/02 2016): 90.

⁵⁹ Fors et al, "From the Library to the Laboratory and Back Again." (2016): 93. Sibum avoids the term “replication” because it has a specific meaning in science, that of repeating an experiment to confirm prior results. From an art historian perspective, I am fine with its use.

⁶⁰ Of course I have the actual daguerreotypes in hand. To convey my results, they have been digitized and reproduced here.

1.5 Introduction: Engaging Literature

Benjamin Pierce Johnson praised the work of the American daguerreotypists at *The Great Exhibition of the Works of Industry of all Nations* at the Crystal Palace in 1851:

...the examples exhibited by the Americans surpass, in general, beauty of effect, any which we have examined from other countries. This has been attributed to a difference in the character of the solar light, as modified by atmospheric conditions; we are not, however, disposed to believe that to be the case...we know of no physical cause by which the superiority can be explained, and we are quite disposed to be sufficiently honest to admit that the mode of manipulation has more to do with the result than any atmospheric influences.⁶¹

Historians of photography often repeat the superiority of American daguerreotypes at the Crystal Palace. In *The Daguerreotype in America*, Beaumont Newhall paraphrases Horace Greeley by saying, “[i]n daguerreotypes we beat the world”.⁶² ⁶³ What is important for my work, as noted by Johnson, is that the mode of manipulation, not geography or clear skies, was the reason for the Americans success; what was important for Newhall was American superiority.⁶⁴ This section reviews how other historians have engaged with the literature of the daguerreotype and how my approach, which combines textual research, practical experience, and historical re-enactments, can reveal new information, or correct what has been misinterpreted.

⁶¹ B.P. Johnson, Report of Benj. P. Johnson: Agent of the State of New York, Appointed to Attend the Exhibition of the Industry of All Nations, Held in London, 1851. C. Van Benthuysen, Public Printer, 1852: 116-7.

⁶² Beaumont Newhall, *The Daguerreotype in America*. 3rd revised ed. ed. New York: Dover Publications [etc.]; London: Constable, 1976: 11.

⁶³ H. Greeley, *Glances at Europe: In a Series of Letters from Great Britain, France, Italy, Switzerland, Etc., During the Summer of 1851. Including Notices of the Great Exhibition, or World's Fair*. Dewitt & Davenport, 1851: 26. Horace Greeley actually said, "In Daguerreotypes, it seems to be conceded that we beat the world, when excellence and cheapness are both considered--at all events, England is nowhere in comparison--and our Daguerreotypists make a great show here." For a contemporary view of the American showing at the crystal place see Dinius, Marcy J. "Best in Show." <http://www.common-place.org/vol-09/no-04/dinius/>. (Date accessed, 17 April 2012)

⁶⁴ The final chapter in *The Daguerreotype in America* is titled "The American Process". Essentially the chapter is a survey of American-made apparatus, a few examples of Yankee ingenuity, and describes the details of the process, none of which were uniquely American.

Mid-twentieth century historians such as the Gernsheims and Newhall have written monographs and chapters on the daguerreotype without ever having made a daguerreotype. For some this is not an issue. Vanessa Schwartz, professor of Art History at the University of Southern California claimed that one does “not need to know how to build a table to appreciate fine furniture”⁶⁵ but Leora Auslander, historian and teacher at the University of Chicago, is convinced that her experience as a furniture-maker was as essential to her understanding as all of her archival, library and museum research on the material and social history of French furniture.⁶⁶ Leor Halevi, co-participant with Auslander, in discussing *Historians and the Study of Material Culture* would classify Schwartz as a “hands-off historian” and Auslander a “hands-on historian”. Hands-off historians, Halevi suggests, after teasing out all that is possible from historical sources sometimes cannot resist the temptation to speculate.⁶⁷

Kelley Wilder’s dismissal of Daguerre’s photographic paper is a relatively recent example of an historian speculating with historical sources. In a letter to Talbot, Biot outlined the differences between Daguerre and Talbot’s photosensitive papers:

You only disagreed [differed] with Mr Daguerre over the general principle of the process which consists of preparing the paper with a preliminary application of liquid...The liquid he prefers above all other is hydrochloric ether, weakly acidified by the slow decomposition it sustains over time. I underline this condition because it is indispensable, as you will easily understand. It does not use, or barely uses heat to dry either the ether or the nitrate, which would be harmful⁶⁸

⁶⁵ Vanessa R. Schwartz, "Color in the History of Photography." Paper presented at the Photography Historians: A New Generation?, Ryerson Image Centre, March 26-28, 2015.

⁶⁶ L. Auslander, A. Bentley, L. Halevi, H. Otto Sibum, and C. Witmore, "Ahr Conversation: Historians and the Study of Material Culture." *American Historical Review* 114 (2009): 1371. Haveli in reply to Auslander framed his argument as an insider/outsider problem in the study of material culture.

⁶⁷ Auslander et al, "Ahr Conversation: Historians and the Study of Material Culture." *American Historical Review* 114 (2009): 1388-89.

⁶⁸ Jean-Baptiste Biot, "Letter to Wm. Henry Fox Talbot." In *The Correspondence of William Henry Fox Talbot*. Leicester: DeMontfort University, 1839. Dated February 24, 1839. Document No. 3817. <http://foxtalbot.dmu.ac.uk/letters/transcriptDocnum.php?docnum=3817> (Date accessed, 7

Wilder wrote, "On the surface it appeared that Biot was quite well informed of Daguerre's paper process, but this was not the case. The process described, one of hydrochloric (or chlorohydric) ether, does not render any paper susceptible to impression photographically".⁶⁹ She had only half the formula in mind because Biot only relayed to Talbot what was different between his and Daguerre's photographic paper. The important sensitizing step with silver nitrate solution was omitted as a matter of course. In reading Biot's letter as a 'hands-on' historian familiar with such processes, I recognized the word "nitrate" and understood that there must be more to the formula. Indeed, Biot tells Talbot the full details are available in *Comptes rendus hebdomadaires des séances de l'Académie des sciences*. The February 18 issue explicitly states that after the paper, impregnated with muriatic ether, is thoroughly dried it is then dipped in a solution of silver nitrate in distilled water.⁷⁰ The paper according to Biot "is so sensitive that even yesterday, when it was wet and very foggy, the weak radiation in the atmosphere coming from a northerly direction affected it within a few seconds through a

Jan. 2016). Kelley Wilder's version of Biot's letter uses "differed with" and the DeMontfort database has "disagreed with Mr Daguerre". It is clear from the letter that Biot had access to both Talbot and Daguerre's formula. Differs is more appropriate than disagreed in this case. What was different between the two was only the first wash, "the preliminary application of liquid" which was salt water in Talbot's process and decomposed hydrochloric ether in Daguerre's. Wilder presents this chemical as the entire formula and incapable of photographic impressions. Biot left out the second solution, silver nitrate, because it was common to both formulae, knowing Talbot would easily understand. Biot mentions that the full details are in last Monday's *Comptes rendus hebdomadaires des séances de l'Académie des sciences*.

⁶⁹ Kelley E. Wilder, "Ingenuity, Wonder and Profit: Language and the Invention of Photography." Oxford University, 2003:135-7.

⁷⁰ Jean-Baptiste Biot, "Physique chimique -- Note de M. Biot sur un papier sensible préparé par M. Daguerre." *Compte rendus hebdomadaires des séances de l'Académie des sciences* 1, no. Séance du Lundi 18 Février (1839): 246-47. It is unfortunate that Wilder never sought out this reference. She may have been at a disadvantage and unable to locate it because Biot's letter to Talbot was catalogued with the date January 24, 1839, not the actual date of February 24. Daguerre's instructions are clear and concise for the preparation of this paper. He knew of the advantages in uniformity given by dipping the paper into solutions rather than brushing them on, and if we are to believe Biot, had this figured out in 1826, nine years ahead of Talbot.

cylinder of rock crystal 21 millimetres long".⁷¹ It seems Biot was not only well informed of Daguerre's paper process, he actually used it for himself.⁷²

Halevi proposed a distinction between an experiential and experimental approach for "hands-on" historians.⁷³ My reading of Biot is informed by experience enabling a different interpretation than Wilder, which in turn led me to seek out the full details of the process in *Comptes rendus hebdomadaires des séances de l'Académie des sciences*. In this instance, replication of Daguerre's paper process was unnecessary because its validity is fully supported by historical texts. On the other hand, an experimental approach can serve to fill in gaps in knowledge when the textual record is incomplete and material culture in the form of historical artefacts does not exist.

Samuel F. B. Morse wrote to his brother Sidney that "the steps of his [Daguerre's] progress in the discovery, and his valuable researches in science are lost to the scientific world" the day after fire destroyed the Diorama and his adjoining workshop.⁷⁴ With no material culture in the form of lab notes nor images known from Daguerre's studio prior to 1837, historians have reconstructed the events of Daguerre's discovery through his correspondence, contracts with Nicéphore and Isadore Niépce, brief notices in journals, and third party accounts, leading to a number of speculative assumptions. For example, a notice in *Journal des Artistes* reports that Daguerre had created a *permanent* camera image, based on his own discoveries in 1835, although the earliest extant daguerreotype is dated

⁷¹ Jean-Baptiste Biot, "Letter to Wm. Henry Fox Talbot." DeMontfort University, 1839. Document No. 3817.

⁷² For a history of Biot's use of photosensitive papers see Levitt, T. "Biot's Paper and Arago's Plates - Photographic Practice and the Transparency of Representation." [In English]. *Isis* 94, no. 3 (Sep 2003): 456-76.

⁷³ Auslander et al, "Ahr Conversation". (2009): 1389.

⁷⁴ Samuel Finley Breese Morse, "The Daguerrotipe." *New-York Observer*, April 20, 1839: 62. http://www.daguerreotypearchive.org/texts/N8390002_MORSE_NY_OBSERVER_1839-04-20.pdf (Date accessed, 24 Oct 2014) Morse had visited Daguerre at his studio on Thursday March 7, 1839 to view his photographs. The following day, while Daguerre was with Morse to see his telegraph machine, the Diorama and workshop burned to the ground. Daguerre's notes and plates were said to be destroyed.

1837.⁷⁵ These dates encompass Daguerre's discoveries of latent image development and fixation with salt water. The two-year span has been interpreted in various ways. The Gernsheims outright dismiss the notion of a permanent image in 1835, stating that he had only *informed* Isadore Niépce of his discovery, unable to show him tangible evidence because the plates were unfixed.⁷⁶ Michel Frizot implied that the delay between the discovery of development and fixing was due to Daguerre's lack of scientific knowledge, when he wrote in an aside, "This problem, however (which would not have impeded a scientist like Talbot), was still unresolved in February 1837...".⁷⁷ Gernsheim and Frizot provide yet again examples of "hands-off" historians offering speculation.

Frizot's opinion of Daguerre's scientific prowess is curious. Does he take material culture in the form of extant images and laboratory notebooks as measure of scientific abilities (for the residue of Talbot's work is vast), or have previous authors who present Daguerre's discoveries as accidental influenced him? Whatever his reasons, one can get an inkling of Daguerre's scientific knowledge from his letter to Arago, read before L'Academie des Sciences in September 1839. The intent of the letter, reprinted in *Comptes rendus hebdomadaires des séances de l'Académie des sciences*, was to explain the feasibility of engraving daguerreian images for use with a printing press.⁷⁸ Daguerre expended his time between 1835 and 1837 conducting experiments to etch the shadow portions of his images in order to retain black pigment to gain more contrast. More importantly for my interests, the letter contains clues in Daguerre's own words about his progress of invention from the use of silver iodide and silver plates in 1831 to the published

⁷⁵ "Diorama." *Journal des Artistes* 13 (September 27, 1835): 202-4. Daguerre's still-life from 1837, though barely visible due to failed attempt at conservation, resides in the collection of the Société Française de Photographie.

⁷⁶ Helmut and Alison Gernsheim, *L.J.M. Daguerre: The History of the Diorama and the Daguerreotype*. 2nd revised ed. New York: Dover, 1968:73.

⁷⁷ Michel Frizot, "Light Machines: On the Threshold of Invention." In *A New History of Photography*. Köln: Könemann, 1998: 25.

⁷⁸ L.J.M. Daguerre, "Des procédés photogéniques considérés comme moyens de gravure. — Lettre de M. Daguerre à M. Arago". *Compte rendus hebdomadaires des séances de l'Académie des sciences*, Séance du Lundi 30 Septembre (1839): 423-30. An English translation for much of this letter appears in *The Athenæum*, No. 624, October 1839.

process of 1839. The chemical information contained within this letter has not been examined in prior histories. Fresh insight into Daguerre's progress has been obtained through an experimental approach here, guided by details outlined in this letter. Fors, Principe and Sibum support the notion that "reproducing and experiment can thus offer the historian otherwise unobtainable hints regarding the origin of ideas, theories, conclusions, or the subsequent pathways of invention followed by historical actors".⁷⁹ Re-enactments performed for the chapter on latent image development provide a more plausible explanation for the sequence of events leading to Daguerre's discovery of mercury development, as opposed to playing "blind-man's bluff in his chemical cupboard".⁸⁰ Furthermore, experiments based on Daguerre's letters to Isadore Niépce provide tangible and credible evidence to show that Daguerre's claim of achieving a stable camera-made image in September 1835 was not premature.

Few historians have adopted the hands-on approach to the daguerreotype. Irving Pobboravsky wrote his masters thesis, *Study of Iodized Daguerreotype Plates* in 1971.⁸¹ This study is referred to in my chapter on Sensitizing with Iodine. M. Susan Barger and William B. White studied the daguerreotype by engaging with its material culture in the form of historical texts, artefacts and re-enactment experiments. Their important book, *The Daguerreotype: Nineteenth-Century Technology and Modern Science*, published in 1991 and updated in 2000, has been an influential source cited in nearly every essay and journal article written since that deals with the materiality of daguerreotype.⁸² The book chapters on

⁷⁹ Hjalmar Fors, Lawrence M. Principe, and H. Otto Sibum, "From the Library to the Laboratory and Back Again: Experiment as a Tool for Historians of Science." *Ambix* 63, no. 2 (2016/04/02 2016): 90.

⁸⁰ John Werge, *The Evolution of Photography with a Chronological Record of Discoveries, Inventions, Etc.* London: Piper & Carter, 1890: 26.

⁸¹ Irving Pobboravsky, "Study of Iodized Daguerreotype Plates." Information Service, Graphic Art Research Center, Rochester Institute of Technology, 1971.

⁸² M. Susan Barger and William B. White, *The Daguerreotype: Nineteenth-Century Technology and Modern Science*. 2nd ed. Baltimore: John Hopkins University Press, 2000. According to Google Scholar, this work has been cited 117 times at the close of 2016.

technological practice and daguerreotype image structure, drawn from Barger's 1982 PhD dissertation, have the most relevance to my work.

Barger claims to answer the question, "How, if at all, does image structure vary from daguerreotype to daguerreotype?"⁸³ This is essentially the same question asked by J. J. Bardwell in 1854 in wondering why daguerreotypes have remarkably different appearances. Barger answers *how* but not *why* image structure varies because her answer is limited by the processing variables she studied and the plate materials she used. To analyze changes in microstructure due to process variables, half of the plates fabricated for her research were sent to Irving Pobboravsky, a contemporary daguerreian in Rochester, New York to make new daguerreotype step tablets. With the rest, she made test images stating, "It was clear that actually making daguerreotypes in the laboratory would provide information that could not be gained in any other way".⁸⁴ While true, her understanding of image particle morphology is founded on a fixed set of processing variables. Pobboravsky used modern electro-plated plates and did not vary methods beyond his standard practice.⁸⁵ Barger did not explore specifics of plate material, sensitizing with alternate halogens, optics, or mercury time and temperature to understand how each of these affect photographic speed, image tone and spectral sensitivity, as this was far beyond the scope of her research.

⁸³ M. Susan Barger, "The Daguerreotype: Image Structure, Optical Properties, and a Scientific Interpretation of Daguerreotypy." PhD Dissertation, The Pennsylvania State University, 1982: 60.

⁸⁴ Barger, "The Daguerreotype: Image Structure, Optical Properties, and a Scientific Interpretation of Daguerreotypy." 1982: 55-8. Barger recounts the difficulties experienced attempting the process. Things have not changed since 1839 in this regard. "It was surprisingly difficult to learn to make daguerreotypes. There was a vast difference between knowing the procedure and making it work. The same steps for processing daguerreotypes used in the nineteenth century, described previously in Chapter 2, were used to prepare the modern daguerreotypes. It took many months of diligent work before the number of successful attempts to make daguerreotypes began to overtake the number of failures. This was puzzling because the procedure was never substantially altered; however, technique was continuously improved. The failure to form images was not necessarily due to a failure of the daguerreian system."

⁸⁵ Irving Pobboravsky provided the following information related to the samples he produced: "19 Oct 79 - Sent two plates (gray scales) - both have 4 bromine levels - one gilded the other not. The next 14 plates were given I-B-I sensitization - (just one level of bromine). Plates 1-7 -not gilded, Plates 8-14 - gilded" in a personal communication.

The importance of Barger's work is its interdisciplinary nature, incorporating technical history and material science. Where it falls short, is the depth of inquiry into the nuances of the materials and methods that evolved over time for the historical information they may reveal. Barger has relied on an assumed uniformity of practice that Newhall believed years prior when he stated that by consulting standard treatises one could "reconstruct in detail every step of the process".⁸⁶ This belief is due to the way daguerreian textual information was disseminated. Details that were scattered through arts and science journals, such as *Comptes rendus hebdomadaires des séances de l'Académie des sciences*, the *Journal of the Franklin Institute* or *The London Journal of Arts and Sciences* in the 1840s were distilled and collated into photographic journals and standard treatises. Nearing the commercial end of the daguerreotype, Montgomery P. Simmons, a daguerreian with over fifteen years experience, condensed the whole of the art into a nutshell:

There are other modes of operating...But I have deemed it advisable to give but one process for each, being much better for the student to thoroughly understand one set of formulae, than to have but a smattering idea of many. Those which I have ventured to explain, the result will show, are equal to any in use...I will endeavor to point out the best and shortest road to success...It is not enough, that a process should be capable of producing the best effects, but it should do so, with the greatest certainty, and the least possible trouble.⁸⁷

At the close of the Civil War in America, John Towler only required four pages of text to explain the daguerreotype process in his 350 page textbook, *The Silver Sunbeam*.⁸⁸ This digest of the process, typically in texts from the mature period, give the impression that the materials and methods were straightforward and standardized, which can be misleading for researchers when attempting to

⁸⁶ Beaumont Newhall, *The Daguerreotype in America*. 3rd revised ed. ed. New York: Dover Publications [etc.]; London: Constable, 1976: 115.

⁸⁷ Montgomery P. Simons, *Photography in a Nut Shell; or, the Experience of an Artist in Photography, on Paper, Glass and Silver.; With Illustrations*. Philadelphia: Printed by King & Baird, no. 607 Sansom Street., 1858: 12-13.

⁸⁸ John Towler, *The Silver Sunbeam: A Practical and Theoretical Text-Book on Sun Drawing and Photographic Printing*. Joseph H. Ladd, 1864. Facsimile ed. Morgan & Morgan, NY. 1969: 268-71.

understand the daguerreian system. The best effects, (speed, tone, and contrast) are not solely influenced by an ideal single set of processing steps, but each of these characteristics were influenced by several permutations of combined variables that evolved during the daguerreian era. I want to emphasize Simon's point that there are other modes of operating. Naturally the best and shortest road to success was desired but there were many roads and driving speeds. Returning to Bardwell's inquiry and American daguerreians showing so successfully at the Crystal Palace; it is the mode of manipulation that explains why daguerreotypes look the way they do, and that has not been rigorously investigated until now.

Modes of manipulation that explore variations of processing procedures are detailed in their relevant chapters following the next section on research methodology.

2.1 Methodology: Overview

The daguerreotype was in a continual state of flux since its inception, as practitioners sought new materials and methods to improve photographic speed, tone and spectral sensitivity. I have reviewed primary sources for notices of improvements in practice and made replicative experiments to test the claim and understand how working methods affect the appearance of daguerreotypes. It is important to recognize the role of human agency when investigating the daguerreotype processes because it is essentially a handmade system. Images can look significantly different, not only from different studios, but results can vary wildly from the same maker, as one of the greatest challenges for a daguerreian operator is to prepare each plate similarly for consistent results. Moreover, re-enactments must conform convincingly to the material culture from the period in question because historical experiments made with modern materials and methods may lead to questionable results.

The goal of this chapter is to explain and justify my research methodology. There are two ways to scientifically approach material culture in the form of historical objects and texts. One can analyze the historical object to determine how it was made or one can synthesize new objects to determine the effects of the process. Analysis and synthesis are closely linked with deduction and induction. If processing variables are explicitly understood in a system, the analysis of cultural artefacts is a useful methodology to deduce the cause or method of their creation. Justus von Liebig, a contemporary of Daguerre, explained that deductive reasoning is impossible when precise information about a process is missing, and a better approach would be to use inductive science and perform experiments based on experience with materials, or as he referred to it, an artistic approach to science. Von Liebig offers Faraday's discovery of the electric motor and Daguerre's discovery of mercury development as examples of inductive science.⁸⁹

⁸⁹ Justus Von Liebig, "Induction and Deduction." *The Cornhill Magazine*, July to December 1865, 1865: 296-305.

Engaging with technical histories through synthesis or experimental replication can recover knowledge not available from textual sources in several ways. It can clarify ambiguous language, uncover the role of human agency in the process of invention, provide the gestural knowledge necessary to perform intricate and malleable experiments for a better understanding of the process involved, and the products of experimental replication can provide tangible information about historic objects that are described in texts but have not survived. This chapter provides examples where synthesis has been successful in revealing new information for historians of science and historians of photography.

Though it is impossible return to the past and prepare plates precisely as Baron Gros did, I have taken precautions to ensure that my apparatus, materials and methods conform as closely a possible to past conditions. Plates have been manufactured by the cladding process according to specifications obtained from original examples. Manual and mechanical polishing systems used perform the work in the same manner as the past. Sensitizing boxes have been replicated after original equipment of varying designs and experiments using these boxes have revealed surprising information about their influence on sensitizing uniformity. Plates have been exposed with vintage optics and replica cameras, and in some instances I've been fortunate to work with some of the oldest original cameras in existence. The section on sample preparation is to illustrate that my historical re-enactments should not be subject to anachronistic criticism, and that this research maintains a convincing reproducibility so that results and conclusions accurately reflect of the material culture in question.

In the daguerreotype process, production variables are complicated, diverse, and fickle. The rate of iodizing for instance is significantly influenced by the materiality of the plate and its surface polish, ambient temperature, relative humidity in the workroom, and the concentration of iodine vapour in the box so that sensitizing with iodine does not conform to standard timing. (The way one processes twentieth century photographic film.) Rather than timing, the creation of

silver iodide on the plate is monitored by direct observation of the colours reflected from its surface while the seconds are noted. The appearance of these colours depends on the angle at which the plate is held in hand for observation combined with room lighting conditions. Iodizing is one of many challenges of synthesis, particular to the daguerreotype process. I address this by designing experiments that effectively isolate the material or method under investigation. To minimize the influence of human agency or material conditions during the experiment, I prepare a single plate where possible. For example, in studying the effects of different iodizing times, the sensitizing is applied selectively to different sections of the plate through masking. In this way other variables such as polishing or mercury development do not factor in the result.

Each experiment for this dissertation has been designed to address questions related to the daguerreotype process, or to understand the working methods of historical actors. The experiments have been recorded in a laboratory notebook and the resulting daguerreotypes are titled DagTest *mm-dd-yyyy*. Written directly on the verso and/or recto are the pertinent details so the information is readily at hand while looking at the daguerreotype. Most importantly, each daguerreotype has been photographed or scanned with a colour-managed workflow to reproduce the tones, contrast and colours of the images as accurately as possible for inclusion in this dissertation. In this manner, the effects of known causes are made visually explicit.

2.2 Methodology: Engagement through Synthesis

There are two different but complimentary scientific approaches that can be adopted to engage with historical objects. Tom Ritchey suggests that analysis and synthesis are “two sides of the same coin” and with any investigation, it is the available knowledge that governs which approach is best. Ritchey prefers the synthetic approach, which allows the investigator to infer the effects on the basis of given causes “when the laws and principles governing a system's internal processes are known, but when we lack a detailed picture of how the system behaves as a whole”.⁹⁰ In the daguerreotype, causes are the variables of the process, and the effects are the image. This interpretation also aligns with Bardwell's question, in *Cause and Effect*, where he observes the effects, (daguerreotypes appear different from different makers) and would give a week's work to know the cause (how they did it).⁹¹ I follow the synthetic approach by replicating specific methods, described as improvements in the process, from historical texts along the daguerreian timeline.

According to Ritchey, the analytical approach is preferable “when a system's overall behaviour is known, but when we do not have clear or certain knowledge about the system's internal processes or the principles governing these” allowing the investigator to draw conclusions about causes on the basis of effects.⁹² Analysis has been the method of many prior scientific studies of the daguerreotype and I will now explain why this approach may be ineffective, followed by examples to illustrate the effective use of the synthetic approach.

⁹⁰ Tom Ritchey, "Analysis and Synthesis: On Scientific Method – Based on a Study by Bernhard Riemann." *Systems Research* 8, no. 4 (1991): 37. Ritchey's article presents a contemporary view on the scientific method. For a nineteenth century perspective see, Von Liebig, Justus. "Induction and Deduction." *The Cornhill Magazine*, July to December 1865, 1865: 296-305 and Herschel, J.F.W. *A Preliminary Discourse on the Study of Natural Philosophy*. Longman, Rees, Orme, Brown, and Green ... and John Taylor, 1831.

⁹¹ J. J. Bardwell, "Cause and Effect." *The Photographic and Fine Art Journal* 7 (1854): 270-1. See Introduction page 6.

⁹² Ritchey, "Analysis and Synthesis" *Systems Research* 8, no. 4 (1991): 29.

William F. Stapp, curator of photographs at the National Portrait Gallery in Washington, DC enlisted M. Susan Barger to make a scientific contribution for the exhibition catalogue on the early daguerreotypes of Robert Cornelius. She examined daguerreotypes Cornelius made between 1840 and 1842 with a scanning electron microscope to image their microstructure and to perform chemical analysis. She questioned if it were possible to predict changes in image appearance (microstructure) as the result of processing changes, and if that microstructure could then be used to assign a date for the daguerreotype.⁹³ This motivation may appear to be art-market driven, but historically it is important to realize that Cornelius worked during the incunabula era when changes to materials and methods occurred at a rapid pace. Two significant additions to Daguerre's original process were reported in the early literature; the first being the introduction of multiple halogens to increase speed, and the second being gold toning to finish the image.⁹⁴ Barger linked image particle morphology with sensitizing, and concluded that the platelet formation she observed in highlight regions of the micrographs were "characteristic of an early multiply sensitized daguerreotype", and images without highlight platelets were produced at a later date when Cornelius had better control over his sensitizing technique.⁹⁵ However sensitizing isn't the only processing variable that affects image particle morphology. I have produced highlight particle morphologies with and without platelets on the *same multiply sensitized plate* by altering mercury development conditions, a variable Barger had not considered. In conducting experiments for the chapter on development, I tested ether combined with mercury, as Baron Gros recommended,

⁹³ M. Susan Barger, "Robert Cornelius and the Science of Daguerreotypy." In *Robert Cornelius: Portraits from the Dawn of Photography*. Washington, DC: Smithsonian Institution Press, 1983: 111.

⁹⁴ See Table 1, p 10.

⁹⁵ Barger, "Robert Cornelius and the Science of Daguerreotypy." 1983: 119-28. Barger concluded on page 126, "Since he [Cornelius] was already working and experimenting with daguerreotypy before the final processing techniques had been determined, there were predictable microstructural changes associated with alterations in processing that could also be used as markers for dating...That is, once multiple sensitization and gilding had become part of routine daguerreotype processing, the features of the daguerreotype microstructure would have been fairly consistent regardless of the individual daguerreotypist." If this were true all daguerreotypes produced after 1842 would have a similar appearance in tone and J. J. Bardwell would not be wondering about cause and effect, nor would I.

and found that ether introduced into the mercury apparatus had a remarkable effect on image colour. (Fig. 3) When examining the plate in a scanning electron microscope to understand the cause of the colour difference, I noticed that image particle morphology was constrained to regular spherical highlight particles when ether was used, and irregular image particles and platelets had formed on the half developed without ether. This does not prove Cornelius used ether, but it does illustrate that other variables may affect particle morphology, and since Barger only considered sensitizing, she cannot draw reliable conclusions about microstructure or assign dates to historic plates with certainty. This example illustrates a problem with the analytical approach when the cause is assumed to be due to a single variable.

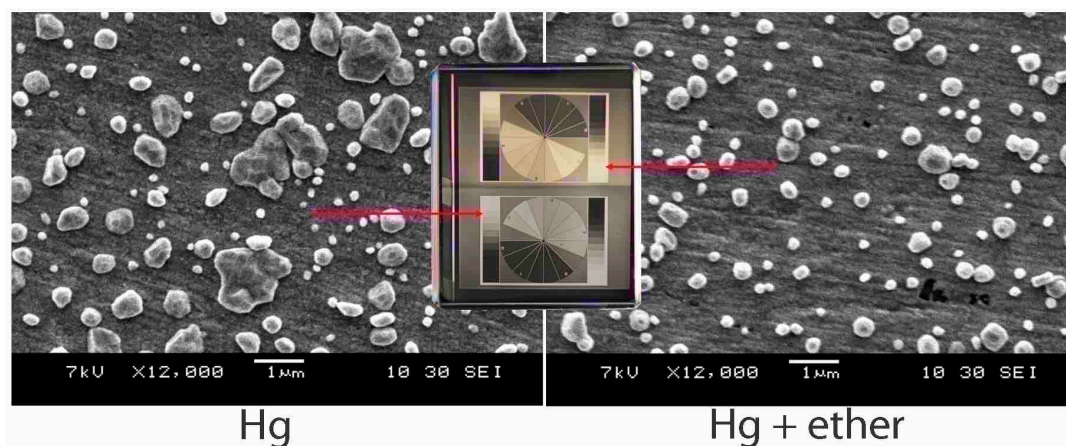

Figure 3. Dag Test 3-18-2015. Multiply sensitized plate. Micrograph of highlight region on plate half developed with Hg (left), micrograph of highlight region on plate half developed with ether added to the Hg apparatus (right). Ether affect on image colour (Overlay).

The synthetic approach involves replication and re-enactments. In the field of science, David Gooding shows how synthesis is an effective methodology to make explicit tacit knowledge of a process or discovery. In *Mapping Experiment as a Learning Process: How the First Electromagnetic Motor Was Invented*, he reconstructed the apparatus of Faraday's rotation motor from historical texts (Michael Faraday's laboratory notebook) and by working with it, re-discovered the thought experiments, observation, human agency, and tacit know-how that was necessary to modify the apparatus step-by-step to achieve electrical rotation. Much of this information was missing or not explicitly clear in the lab notes.⁹⁶

Gooding found replication to be an invaluable aid in interpreting Faraday's notebook, because it provided him and his final-year physics students at Bristol University the tacit knowledge to develop a better understanding of Faraday's mental processes. Gooding explained, "The study of artefacts is an established part of the history of technology yet the study of processes is far less developed...discovery and invention are neglected because creativity is thought to be beyond the reach of empirical study, and is often placed in an unanalyzable category marked 'genius'".⁹⁷ In the same manner, replication experiments to understand the mental processes and progress of discovery of historical actors, performed for several chapters here, provide a clearer interpretation, so historians do not have to rely on "genius" or "blind-luck" to explain events.

In the history of photography, synthesis was effective in uncovering details about Niépce's use of iodine to blacken bitumen images described. This method is described in historical texts but no example of the process remains. Jean-Louis Marignier was able to replicate the photographic processes that relied on the hardening of bitumen resin with light exposure. For material accuracy he obtained

⁹⁶ David Gooding, "Mapping Experiment as a Learning Process: How the First Electromagnetic Motor Was Invented." *Science, Technology, & Human Values* 15, no. 2 (1990): 191. Gooding's maps are remarkably similar to computer programming flowcharts, however, they are designed to represent apparatus, thought experiments, real experiments, observation; in effect scientific method and human agency combined. It is not my intention to draw flowcharts; the daguerreian process variables are more complicated to be represented in this manner.

⁹⁷ Gooding, "Mapping Experiment as a Learning Process" (1990): 196.

bitumen from the same mines (now abandoned) that Niépce did. Eventually Marignier succeeded, first in replicating the bitumen on tin process of 1827 and then Niépce's improved process that used a silver plate as a support. He fumed a silver plate with iodine vapour before dissolving the unhardened bitumen, followed by blackening it with exposure to sunlight.⁹⁸ Marignier explains:

Not one example of an image treated with iodine vapors has survived so it was impossible to know the exact performance of this method before my work. It is only by revisiting the practice of this process that I have been able to show that it results in high-quality images with a range of gradient of gray as broad as modern-day silver gelatin photographs.

Marignier has been able to recover significant information using this methodology, such as proving the exposure time required for bitumen photographs was several days, not eight hours as stated in Newhall's popular *The History of Photography*.⁹⁹ Furthermore, the image produced by replicating the silver-iodine reversal bitumen process was remarkably continuous in tone and a great improvement over the heliograph, though no better in light sensitivity. In a similar way, my re-enactments have produced tangible examples of Daguerre's work leading up to his invention that have not survived in the form of images or lab notes.

For my chapter in the book *Young America* (2005) re-enactments were used to interpret the daguerreotypes of Southworth and Hawes and determine why their work looks unique. I searched for texts and manuscripts written by the partners that contained details of their working methods. Information related to their plate choice, plate re-silvering, polishing, preferred sensitizing halogens, lens choice,

⁹⁸ The bitumen served as a permeable mask of varying thickness to form silver iodine on the plate proportional to camera exposure. The plate has far better detail and resolution than the known heliographs on pewter.

⁹⁹ Beaumont Newhall, *The History of Photography: From 1839 to the Present*. Fifth ed.: Museum of Modern Art, 1982: 15. Eight hour exposures are required for camera images using the Physautotype process which worked roughly five times faster than bitumen process and roughly 70 times slower than the daguerreotype process using only iodine. The sensitivity ratio between the Physautotype and the Daguerreotype is provided directly by Daguerre in a single sheet broadside from late 1838 printed to promote his new process. This broadside is only known by a copy, formerly in the collection of the George Eastman House, now lost. This information from Ewer, Gary. "The Daguerreotype: An Archive of Source Texts, Graphics, and Ephemera, M8380001, www.daguerreotypearchive.org, (Date accessed, 18 March 2017)

camera modifications, and mercury temperature, guided the replication of daguerreotypes according to the methods described.¹⁰⁰ To conform as closely as possible to their practice, I used Voigtländer Petzval lenses as they did,¹⁰¹ I had a polishing device replicated from their patent drawing¹⁰² (its action is illustrated in Fig. 4).¹⁰³ I also obtained two nineteenth century plates from the Southworth and Hawes studio that had been polished and re-silvered but unused.¹⁰⁴ These plates provided an important visual clue (a sky-blue colour) to the re-silvering thickness, which allowed me to replicate this critical aspect of their process.¹⁰⁵

¹⁰⁰ The two sources that best describe Southworth and Hawes' practice are, Albert Sands Southworth, "The Early History of Photography in the United States." *The British Journal of Photography* 18, no. November (1871): 530-32, and Albert Sands Southworth, *The Massachusetts Register: A State Record for the Year 1852, Containing a Business Directory of the State with a Variety of Useful Information*. George Adams, 1852. Southworth gave excellent descriptions of their plate quality and working methods. "We silver all our Plates every time we try them, by Electro Galvanism, thus securing them against spots of oxide of copper coming through the pores or small holes in the silver."

¹⁰¹ E. White, "Invoice for Voigtländer ½ Plate Camera (Lens) " In the National Gallery of Canada collection, 1846. Dated Feb. 16, 1846. The Voigtländer portrait lens, designed in 1841 by Josef Petzval, had a working aperture of *f*/3.6. It quickly gained a reputation for being the finest objective available. Southworth and Hawes paid 70 dollars for a half-plate Voigtländer lens purchased from E. White, N.Y.

¹⁰² Albert Sands Southworth and Josiah Johnson Hawes, "Improvement in Apparatus for Holding Plates for Polishing", US Letters Patent 4,573. June 13th, 1846. See Appendix C – p 418.

¹⁰³ Albert Sands Southworth, "The Early History of Photography in the United States." (1871): 530-32. Southworth and Hawes gave the final polish to their plates by hand with the aid of this machine. Southworth considered its use indispensable. "Our swing-polishing plate-holder...enabled us to finish our plates with great perfection.

¹⁰⁴ I obtained these plates from the late Matthew R. Isenburg, Hadlyme, CT. Provenance: J. J. Hawes, 1901; E. S. Hawes, 1934; Holman's Print Shop, Boston, ca 1942; A. R. Phillips, Jr., 1956; H. L. Gross, 1979; M. R. Isenburg, 2001; M. A. Robinson.

¹⁰⁵ Re-silvering refers to applying silver to the plate with a galvanic battery. This is discussed in Chapter 3, p 126.

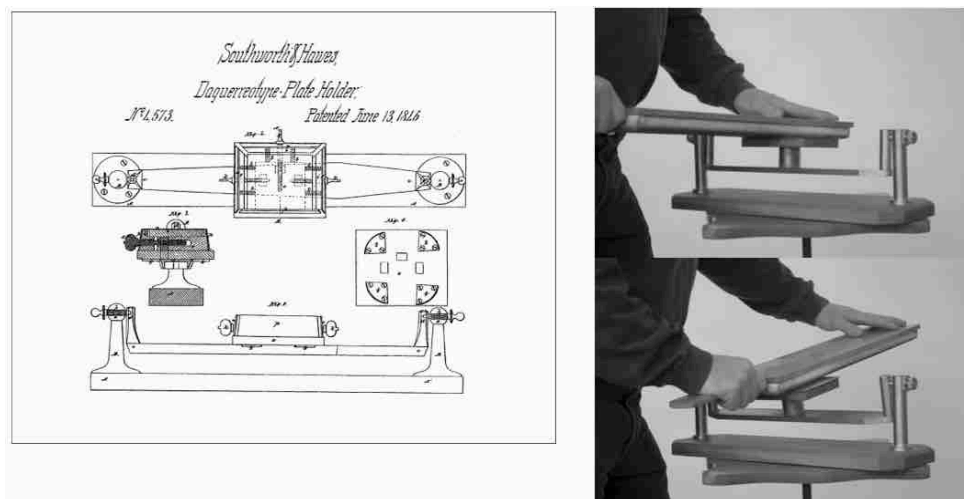

Figure 4. Patent drawing (adapted) for Southworth and Hawes' Daguerreotype Plate Holder (left). The replica device in use (right). Bob Warren photograph.

New daguerreotypes produced with information from historical texts compared well with historical images; my daguerreotypes had the same appearance in tone and prismatic effect as those of Southworth and Hawes.¹⁰⁶ I found there was no single technique used by Southworth and Hawes that made their work unique, rather it was their complete understanding and careful attention to the minute details of each stage of the process that allowed them to produce some of the finest examples of American daguerreian art.¹⁰⁷ Their artistic genius (posing and lighting notwithstanding) was the result of their technical know-how of the daguerreian system. A system as defined by Ritchey is “any (circumscribed) object which consists of a number of “parts” or “components” which, in some way or another work together in order to produce and overall effect or behavior.”¹⁰⁸ The synthetic approach provided fresh insight into Southworth and Hawes’ system and was effective in explaining why their images look the way they do.

¹⁰⁶ Grant Romer agreed. Upon seeing my work he joked that someone should pay me handsomely to never ever make another daguerreotype for fear of Southworth and Hawes forgeries in the marketplace.

¹⁰⁷ Michael A. Robinson, "A Style Peculiar to Themselves: An Investigation into the Techniques of Southworth and Hawes." In *Young America: The Daguerreotypes of Southworth & Hawes*, 552 p. (152 p. of plates). New York: International Center of Photography; Rochester, N.Y.: George Eastman House; Gottingen: Steidl, 2005: 492-3.

¹⁰⁸ Ritchey, "Analysis and Synthesis": 6.

I have shown in Barger's work that analysis is questionable because the variables of the daguerreotype process, or the technical flexibility of the components of the system, were not taken into account. On the other hand, synthesis can lead the way to a richer and more accurate reading of historical texts. The method was essential for Gooding to recover Faraday's process of discovery and fill in significant gaps in knowledge not available in his lab notes, and Marignier has given us a clearer understanding of photosensitivity and image quality of iodine after bitumen by synthesizing Niépce's processes.

The daguerreotype process is complex, varies between artists, and continually evolved over the period of its commercial use. To garner useful knowledge concerning processes of the daguerreian system that influence speed, tone and spectral sensitivity, the synthetic method is a useful tool, provided the researcher has the pre-requisite tacit and gestural knowledge to design effective experiments. I have included my investigation of the techniques of Southworth and Hawes to make it clear that I have the tacit and gestural knowledge to extract pertinent information from historical sources through synthesis and perform convincing replicative experiments.¹⁰⁹ The next section explains the materials and methods I use in my experiments to show how they conform to historical practice.

¹⁰⁹ See Chapter 1, p 27 for a discussion of convincing replicability.

2.3 Methodology: Experimental Process, Materials and Apparatus

This high level of fidelity to the original process, apparatus, or experimental protocol is not, however, always necessary to carry out a historically informative reproduction...Original features which the historian considers to be irrelevant to the final outcome are initially ignored in order to simplify the reproduction. For example, one might use vessels made of modern Pyrex glass instead of early modern soft glass, or employ thermostatically controlled electrical heat sources rather than putrefying dung.¹¹⁰

From the Library to the Laboratory and Back Again: Experiment as a tool for Historians of Science, from which the above quote was taken, presents an acceptable degree of fidelity for re-enactments related to the history of science. This consideration is equally important when synthesizing the daguerreotype to recover reasonable knowledge and avoid the same critique levied against the Hockney/Falco thesis for using anachronistic optics.¹¹¹ The experimental procedures, materials, and apparatus for this work have been developed to maintain credibility with past historical conditions of the daguerreotype system. When absolutely necessary I use vintage equipment, in particular for the chapter on optics. Otherwise my apparatus and materials are modern replicas made by adhering to original specifications and designs, and I stray from exact historical practice with the use a random orbital sander and a thermostatically controlled heater and fume hood while working with the mercury vapour. These modern concessions are for convenience and safety and their use is materially irrelevant to the outcome.

The chapters to follow concern the components of the daguerreian system and are arranged in procedural sequence as The Silver Plate, Sensitizing with Iodine,

¹¹⁰ Hjalmar Fors, Lawrence M. Principe, and H. Otto Sibum, "From the Library to the Laboratory and Back Again: Experiment as a Tool for Historians of Science." *Ambix* 63, no. 2 (2016/04/02 2016): 94.

¹¹¹ See Chapter 1, p 24. David Stork and Sven Dupré are critical of Hockney's *Secret Knowledge: Rediscovering the Techniques of the Old Masters* because he used optics and methods that did not relate to historical practice.

Sensitizing Accelerators, Optics and Exposure and Image Development, Fixing and Toning. The materials and apparatus I use for historical re-enactments are described now in the same succession.

Plates and Polishing

I have been using silver-clad copper plates produced by Clad-Metal Specialties on Long Island, NY since 1998. At the time, I sought a company capable of making new plates according to nineteenth century specifications because of the inconsistency in photosensitivity from modern electro-plated silver reported by my contemporary daguerreian colleagues. The people at Clad Metal Specialties were intrigued that the earliest photographs were made on silver clad copper and agreed to send me a few samples of .999 fine silver clad onto copper that had specifications surprisingly similar to original daguerreotype plates.¹¹² With these samples, I was able to produce daguerreotypes with a strong white highlight free from solarizing, a common problem with electroplated plates used by other modern daguerreians.¹¹³

In the modern cladding process the raw materials (silver and copper) are prepared in long 100-foot coils for manufacturing efficiency. The two metals are brought together and squeezed between heated rollers to emerge firmly bonded. This procedure differs with the nineteenth century cladding process only in terms of efficiency.¹¹⁴ The material qualities of surface finish, silver purity and hardness

¹¹² Fortunately, they were producing this material for the data reading arm mechanism used in computer hard drives.

¹¹³ Michael A. Robinson, "The Making of Twenty Daguerreotypes." *The Daguerreian Annual: Official Yearbook of the Daguerreian Society*, (2000): 239-67. This article features daguerreotypes made between October 1997 and June 2001. Of importance here is the story my first trials with the prototype clad plate. The precise specifications for silver thickness being 0.00065 – 0.001 inch (16.5 microns - 25.4 microns) bonded to copper with a total plate thickness of 0.020 +/- .001 (508 microns +/- 25.4 microns). This is a silver/copper ratio of 1:19. If this were hallmarked according to nineteenth century practice it would be stamped with the numeral 20, indicating one-twentieth part silver. The majority of nineteenth century plates are stamped with 40, indicating the silver is only one-fortieth the total thickness.

¹¹⁴ Chapter 3, p 105 contains a section on Platemaking Technology. See also M. Susan Barger and William B. White, *The Daguerreotype: Nineteenth-Century Technology and Modern Science*. 2nd ed. Baltimore: John Hopkins University Press, 2000: 48-51.

closely match a nineteenth century plate that I provided for testing.¹¹⁵ Initially I was working with half-hard modern material but changed the specification to quarter-hard based on the information obtained from the original daguerreotype plate.¹¹⁶ I found that I could prepare and polish the softer, quarter-hard material much more readily than the half-hard material and the softer silver also produced a higher quality image. As seen in Fig. 5, the harder plate lacks shadow detail and image brightness, compared to the image made on the softer material. This experience taught me that silver hardness and grain structure affect speed, tone and contrast and should not be taken for granted.



Figure 5. Daguerreotype on a quarter-hard plate (left), and identically prepared example on a half-hard plate (right).

Many nineteenth century daguerreians polished and buffed their plates entirely by hand, though the efficiency of cleaning and polishing was improved with mechanical aids such as steam driven buffing wheels and treadle operated

¹¹⁵ This plate, hallmarked HB 40, has a planished surface that appears smoother than the surface obtainable from rolling mills alone. The nineteenth century plate sample was deemed to be quarter-hard by using a Rockwell hardness tester, which measures the depth at which a 1/16 diameter carbide steel ball under load penetrates a sample. The depth of penetration determines the degree of hardness or temper of the material.

¹¹⁶ I switched from half-hard to quarter-hard material in 2008.

lathes.¹¹⁷ Jabez Hogg in *A Practical Manual of Photography*, provided a description of the use of a foot-operated treadle lathe to impart a random orbital motion between the plate and a rotating, velvet covered, polishing disc.¹¹⁸ Later in the mid-1850s, David Shive patented an improved machine for polishing daguerreotype plates. It was designed to simplify the process, as the use of the lathe style polisher such as described by Hogg required a high level of skill and manual dexterity:

The nature of my invention consists in providing a machine for polishing daguerreotype plates and other like surfaces requiring the finest polish, adapted to cause either the plate or the polishing pad to move in constantly changing circles, the one piece against the other, so as to continuously change by circular motions the relative position of every point of contact between the two surfaces.¹¹⁹

The text of Shive's patent letter describes the random orbital motion of the machine. These nineteenth century polishing tools have been replicated with modern equipment by combining Hogg's plate holding device on the lathe polisher, with Shive's random orbital motion into a single system. A thin ABS plastic frame with wide sides adhered to plate glass retains the plate and protects its edges from wearing through during polishing, similar in function to lathe style plate holder. The plate is retained in this frame with firm downward pressure while guiding a modern polishing machine by hand. Random orbital motion is achieved with a variable speed sander.¹²⁰ A five-inch diameter, one-inch thick foam pad is attached to drive a disc of soft cloth with polishing abrasive pressed against the silver surface. Once the plate is sufficiently polished, it is cleaned of any residues, and the final buffing

¹¹⁷ There are at least eight different patent models of daguerreotype polishing machines in the collection of the American History Museum, Smithsonian Institution Washington D.C.

¹¹⁸ Jabez Hogg, *Photography Made Easy: A Practical Manual of Photography Containing Full and Plain Directions for the Economical Production of Really Good Daguerreotype Portraits, and Every Other Variety of Photographic Pictures According to the Latest Improvements*. E. Mackenzie, 1845: 14.

¹¹⁹ David Shive, "Machine-for Polishing Daguerreotype-Plates." US Letters Patent 12,560. March 20, 1855. See Appendix C, p 430.

¹²⁰ The machine is Makita brand, Model Number B05021K, the foam disc Bosch part number, 2608613005. Other machines and pads may be adapted to the same purpose. Cotton velvet is an effective material to apply the polishing abrasives as long as it is replaced frequently. If used worn or matted with polishing residue the plate will be scratched rather than polished.

is performed on a replica of Southworth and Hawes' swing arm device with velvet covered paddles dusted with rouge and lampblack. The final polish is linear and horizontal as was the finish on the vast majority of nineteenth century plates.

Sensitizing Boxes

The sensitizing boxes I use are modelled after a nineteenth century design (Fig. 6). In 2002, I reviewed a variety of styles from the technology collection at the George Eastman Museum and chose to have a set of iodine and bromine boxes made similar to nineteenth century French-made ones because of their design simplicity and compactness. This design, unlike the American push-through style, is more convenient for inserting masks to apply vapours in four different concentrations on a single plate, which is invaluable for testing purposes. The iodine or quickstuff is contained within a glass (Pyrex) dish with its top edge ground flat. Springs below the dish provide upward pressure against a ground glass sliding lid, which maintains an excellent seal against vapour loss when the boxes are at rest. In use, the polished plate is placed face down in the wooden frame opening above the glass slide and the slide is withdrawn to expose the silver to the sensitizing vapours.



Figure 6. Nineteenth century French style sensitizing boxes (left). *Author photo* – *GEM collection*. New reproduction sensitizing box (right).

Iodine is a fuming flake-like solid at room temperature. One hundred grams of iodine in a half-plate sized sensitizing box is sufficient to sensitize a decades worth of plates provided an airtight seal is maintained. Bromine, on the other hand, is a fuming liquid far more dangerous and more potent at full concentration than

necessary. It must be diluted for use with the daguerreotype process. In the nineteenth century the first solvent was water. Many daguerreians used liquid quicks for their entire career, though some adopted dry quicks that used calcium hydroxide (slaked lime) powder. I also used calcium hydroxide in my early work but switched to silica gel to control the bromine vapour in 2003 (Fig. 7). I discovered its capabilities for absorbing and releasing halogen vapour serendipitously while seeking an alternative for calcium chloride to dry out and control the moisture in my iodine box.¹²¹ I placed the silica gel in the sensitizing box for one purpose, but discovered another.



Figure 7. Bromine vapour absorbed by silica gel (left). The concentration of bromine is judged by colour. Working strength gel appears yellow, replenish strength gel appears red-orange (right).

The experiments for this dissertation were processed with halogen-absorbed silica gel unless noted otherwise. The iodine box does not require strengthening with the addition of more iodine; it remains constant for years, however the temperature of the room affects the rate of iodization.¹²² Bromine, on the other hand, is continually being depleted to the point of requiring replenishing. I always perform a bromine

¹²¹ Samuel D. Humphrey, *American Hand-Book of the Daguerreotype ... Containing the Daguerreotype, Electrotype And ... Other Processes ... Fifth Edition*. New York, 1858: 95. Calcium chloride is recommended to serve as an iodine box desiccant. It is extremely hygroscopic and with enough moisture present, the dry chemical will turn to liquid slurry. I chose to use silica gel instead as a more stable solid. I placed a teaspoon of silica gel on a watch crystal and left it to rest amongst the iodine crystals. When I opened the box, I observed that the silica gel had turned purple as it absorbed iodine vapour. I tried it with bromine vapour and it has proved to be an excellent method for managing both the iodine and bromine.

¹²² With my apparatus it requires fifty seconds to sensitize to a rosy-yellow colour over iodine in a room temperature of 24°C and seventy seconds if the room is 21°C.

test before critical work. Masking the plate during the bromine step in order to create four distinct amounts of bromine on a single plate is the most effective means to do this. This method not only saves time, but also minimizes plate-to-plate variables for a more accurate test. Once the correct timing for bromine exposure is determined, it will work effectively at that time all day.

Optics

It is necessary to use vintage lenses that conform to historical material culture when testing daguerreian system variables for their influence on photographic speed, tone, or spectral sensitivity. Modern optics have anti-glare coatings and lens elements that deliver significantly different imaging characteristics than antique lenses. Generally speaking, most new lenses require longer exposure due to their smaller maximum aperture, and form images with more contrast than the daguerreian portrait lens designed by Josef Max Petzval and introduced in 1841 by the optical firm of Voigtländer & Sohn from Wien (Vienna).¹²³ In the chapter on optics and exposure, I test lenses that predate Petzval's design, French landscape lenses, and a Petzval copy from a competing maker to understand their imaging characteristics. I have found that Petzval lenses from C. C. Harrison of New York perform quite differently than those of Voigtländer & Sohn. To ensure that the visual qualities of experimental daguerreotypes (designed to test variables other than optics) were not affected by lens or camera design, only original or exact replicas of daguerreian cameras, with original lenses have been used. Figure 8 displays an arrangement of replica and original cameras that I have used for this work.

¹²³ The Petzval design for portrait lenses, first manufactured by Voigtländer & Sohn, and quickly copied by other opticians in England, France and America was by far the most common lens design in use from 1843 until the end of the daguerreian era.



Figure 8. Clockwise from the left, a replica half-plate Palmer and Longking camera with Voigtländer lens, a full-plate replica of Daguerre's camera with landscape achromatic lens, an original L.B.B. & Co. quarter-plate chamfered box camera and lens, ca 1843, a replica quarter-plate chamfered box camera with Voigtländer lens, an original half-plate Palmer and Longking camera with C.C. Harrison lens, and a replica Voigtländer all-metal camera for taking round daguerreotypes.

Development, Fixing, Toning

My daguerreotypes are developed with mercury vapour in an apparatus modelled after vintage equipment. A typical American design for the mercury vapour bath was an inverted pyramid of cast iron with an open top fitted with masks for the various plate sizes (Fig. 9). In a vintage mercury bath a small quantity of mercury was poured in from the top. A thermometer was fitted to the exterior to check the temperature as it was heated with an alcohol lamp flame.¹²⁴ I updated the inverted pyramid design to handle toxic mercury as safely as possible. A stainless steel threaded cup serves to hold the liquid mercury, which is removable to minimize spillage. The temperature is held constant at any chosen

¹²⁴ Heating a mercury bath with an alcohol lamp requires constant attention. The temperature will continue to rise beyond practical and safe levels if left unattended. Often the excess heat would cause the thermometer to break; In this case temperature would be gaged by touch.

setting with an electronically controlled heating element linked to thermo-coupled temperature sensor immersed in the liquid mercury. The plate is inserted into the apparatus by first withdrawing a slide above the receiver for the plate, the upper slide is closed and a second slide below the plate is withdrawn. This design ensures the bath is always closed to the atmosphere to minimize the escape of mercury vapour.¹²⁵ The mercury bath is placed within an operating fume extraction hood for extra precaution. The use of electricity in controlling and ventilating the mercury vapour is a necessary alteration from nineteenth century practice in the interest of safety. The chemical reaction between the latent image silver and mercury vapour remains the same as historical practice.



Figure 9. Nineteenth century cast iron mercury baths in quarter, full and half-plate size. Heating is done with an alcohol lamp (left). National Gallery of Canada collection. Modern mercury bath with improvements including an automated mercury temperature controller (right).

Once developed, the plates were fixed to remove the light sensitive silver halide(s) and gilded if required for the experiment. Unless otherwise noted, all daguerreotypes were fixed in a fresh 3% weight/volume solution of sodium thiosulfate pentahydrate ($\text{Na}_2\text{S}_2\text{O}_3 \cdot 5\text{H}_2\text{O}$) in distilled water. After fixing, the plates were rinsed and immediately toned with gold by placing the plate on a level support called a gilding stand.

¹²⁵ A small amount of mercury, (25 mL) has served to develop several thousand daguerreotypes since 1998 and its volume remains measurably unchanged.

A typical method to gild a quarter-plate is as follows: 10 mL of 0.2% gold chloride solution ($\text{HAuCl}_4 \cdot x\text{H}_2\text{O}$ with pH raised with 10 drops of 2% sodium metaborate solution, $\text{NaBO}_2 \cdot 4\text{H}_2\text{O}$)¹²⁶ is mixed into 10 mL of 1% sodium thiosulfate anhydrous solution ($\text{Na}_2\text{S}_2\text{O}_3$). The mixed solution is orange coloured. It will clear after two or three hours, but I have used it immediately after filtering with equal success. The plate rests on a gilding stand and is heated with an alcohol lamp from below for three or four minutes, sometimes but not often longer, while observing the process (Fig. 10).¹²⁷ The toning reaction is viewed most effectively when the plate is positioned to reflect a white surface to present a negative image to the observer. To avoid stains, I avoid handling the plate by the edges and first pour distilled water on the plate so it fills the surface. The toner is poured directly into the standing water on the plate displacing some but not all of it. Once gilding is complete, the plate is flushed with distilled water, dried with an electric blow dryer and sealed behind glass to protect it from tarnish or physical damage. The verso is annotated with the date and processing details.

¹²⁶ During my first year of practice I noticed that when I mixed my Part A (gold chloride solution) into Part B (hypo solution) the mixture was golden orange (tawny) colour that cleared after a couple of hours. When Irv Pobboravsky mixed his Part A and B together the solution was colourless right away. Irv and I did a few experiments (7/18/99) using my toner on his test target daguerreotypes. He was ecstatic to see a roughly 30% increase in contrast. Whites got whiter, blacks got blacker. With his toner, Irv was seeing a gain in blackness, but not as much brightening of the highlights. We then looked at pH to try to figure out the cause. My tawny solution had a pH of about 6.5 mixed, Irv's about 4.5 mixed. The difference was due to the acidity of the gold chloride. Not all gold chlorides are created equal. Eventually my supplier in Toronto had to find another source and to my dismay, the gold chloride was more acid, like Irv's. (1% solution had a pH of 1.5, the less acid salt had a 1% solution pH of 2.5) I did experiments on raising the pH of the new gold chloride. Eventually, I found the best means to do this was adding about a drop per mL of pH+ solution to the Part A BEFORE mixing it with the Part B (hypo).

¹²⁷ Edmund de Valicourt, *Nouveau manuel complet de photographie sur métal, sur papier et sur verre*. Paris: Roret, 1862. End page foldout illustration. http://books.google.com/books?id=3wY3-crlqLMC&hl=&source=gbs_ap (Date accessed, 18 Feb. 2016)

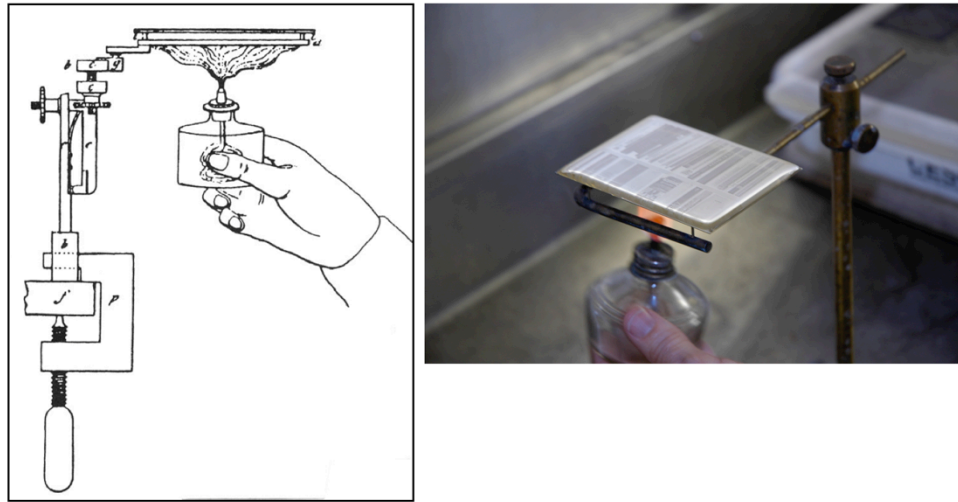

Figure 10. Gilding illustration adapted from E. de Valicourt (left). Gold toning a quarter-plate (right).

Although I use modern adaptations to the apparatus employed in making daguerreotypes, such as an electric sander for polishing, an electronically controlled heating system for the mercury bath, a fume hood for ventilation and a blow dryer to dry the plates, these modifications do not alter the material conditions of their production. The mechanics of my process that depend on human agency such as buffing, sensitizing, fixing and gilding are identical to nineteenth century practice. Having established that my experimental process, materials and apparatus are similar enough to historic practice to yield reasonable information about the daguerreian system, the next section reviews experimental design.

2.4 Methodology: Experimental Design

I have used the scientific method of synthesis to create new daguerreotypes in order to evaluate materials and processes that are claimed to improve photographic sensitivity, improve tone and contrast, or improve spectral response. I have chosen these categories because they address the limitations of the daguerreian system as a whole, and it is while addressing these limitations that nineteenth century practitioners modified their practice. Synthesis begins with a question that originates from reviewing historic texts. From that question research is conducted to form a hypothesis, experiments are designed to test the hypothesis, the experiment is performed and the results are observed. The results can either confirm or reject the hypothesis, lead to additional iterations to modify the experiment in the event of inconclusive results, and occasionally give unexpected results that lead to new discoveries.

Speculation concerning the benefits of materials or methods permeates daguerreian literature from the beginning. For example, Daguerre had informed François Arago that copper in combination with silver performed better than silver alone for the daguerreotype plate. Arago included Daguerre's information in his report to the Chamber of Deputies on July 3, 1839, adding his own hypothesis for the observation:

According to Mr. Daguerre, the image is better reflected on a sheet of plated metal (on a sheet of silver laid over a sheet of copper), than on a single sheet of silver alone. This fact, supposing it to be thoroughly established, would seem to prove, that electricity forms an important part in these curious phenomena.¹²⁸

Arago's reasoning has led to further speculation as to the benefit of electricity; that of increased photosensitivity. Speculation is evident when comparing two variant English translations of the same original text in French. The September 13,

¹²⁸ Louis Jacques Mandé Daguerre, *Historique et description des procédés du Daguerreotype et du Diorama*. Alphonse Giroux et Cie ed. Paris: Delloye, Libraire, 1839: 18. Original in French. (Direct translation in English is from the McLean edition, London. The Memes edition omits this text.)

1839 translation by J. S. Memes, of the Royal Scottish Academy of Fine Arts, which *does not include* Arago's text quoted above, reads, "Although the copper serves principally to support the plate of silver, the union of these two metals tends to the perfection of the effect".¹²⁹ Another translation published by Thomas McLean & Co. 26 Haymarket, London, which does include Arago's hypothesis has, "...the combination of these two metals contributes sensibly to the perfection of the effect".¹³⁰ Daguerre, in his original text, does not say light sensitivity is improved with silver plated copper compared to images made on plain silver.¹³¹ This is a later inference in which the translator for the McLean edition is influenced by Arago's speculation. The increased photosensitivity notion of silver clad copper is perpetuated, without experimental evidence, by M. Susan Barger in her doctoral thesis when she quotes the line from the McLean edition and believes *contributes sensibly* to be a proven fact. She follows the quote with, "Daguerre had tried plates of pure silver, but he did not find these to be as sensitive as plates made of plated silver".¹³²

Barger was likely speculating based on McLean's translation. This section describes how historical re-enactment, or synthesis, was designed to test the reported advantage of silver clad copper over solid silver, which also led to a clarification of ambiguity in the original texts. To test Daguerre's preference for silver clad copper over silver alone, I made a daguerreotype using .999 fine solid silver sheet and compared it to an identically made daguerreotype on a .999 fine silver clad copper plate (Fig. 11). The plates were singly sensitized with iodine to conform to 1839 practice. I also planned to fix the plates in salt water in

¹²⁹ Louis Jacques Mandé Daguerre and J.S. Memes, *History and Practice of Photogenic Drawing on the True Principles of the Daguerreotype*, Tr. By J.S. Memes. 1839: 55.

¹³⁰ Louis Jacques Mandé Daguerre and Beaumont Newhall, *An Historical and Descriptive Account of the Various Processes of the Daguerreotype and the Diorama [in Text of the Manuals in English and French, with French edition following the English.]*. New York: Winter House, 1971: 63. The McLean edition reproduced here comes from a later French edition published November 2, 1839. I have underlined *sensibly* to emphasize the different meanings of the translation.

¹³¹ The Memes translation is accurate according to the French line "l'assemblage de ces deux métaux concourt à la perfection de l'effet."

¹³² M. Susan Barger, "The Daguerreotype: Image Structure, Optical Properties, and a Scientific Interpretation of Daguerreotypy." PhD Dissertation, The Pennsylvania State University, 1982: 21.

accordance with Daguerre's 1837 method because I had formed a hypothesis about how Daguerre was able to fix his images this way. Silver clad copper was likely necessary for salt-water fixation to work by removing the silver iodide with a galvanic reaction.¹³³ If my hypothesis proved correct, the silver iodide would not be removed from the solid silver daguerreotype, as electric current would not be generated from a single metal in the salt solution electrolyte. Two connected metals in an electrolyte amount a battery where electrons flow from a less noble metal to a more noble metal, in this instance from copper to silver.

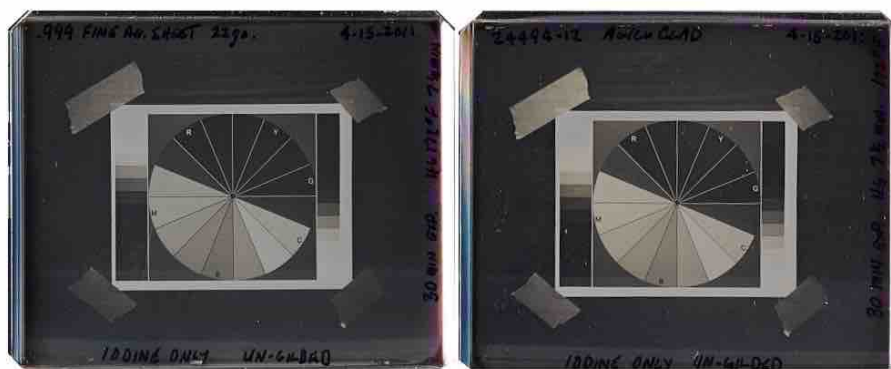

Figure 11. DagTest 4-15-2011. Solid .999 fine silver sheet (left). .999 fine silver clad copper (right).

The test results do not indicate an appreciable difference in photosensitivity. (The difference in image hue is related to hardness and metallurgy, which is addressed in the next chapter). This test, nevertheless, was extremely informative. When the two plates from DagTest 4-15-2011 were placed in a warm 10% salt solution the light sensitive silver iodide coating on silver clad copper plate dissolved while the solid silver plate remained unchanged after 10 minutes (Fig.12). This test revealed the true electrical benefit of bi-metal plates. The act of immersing a silver clad copper plate in a solution of salt water effectively created a simple battery. Salt water is an electrolyte that allows the flow of electrons from the copper verso of the plate (anode) to the silver recto (cathode). Electrons chemically reduce silver

¹³³ I was led to this hypothesis because had observed that immersion of a silver clad copper plate into an electrolyte generates a current creating a simple battery and silver sulphide can be reduced to silver by electrical current. My hunch was silver iodide would react the same way.

iodide (AgI) to silver metal at the cathode surface and fix the plate. After failing to remove the silver iodide from the solid plate with salt water, I re-polished the plates and repeated the experiments by fixing the images in sodium thiosulfate to compare the sensitivity of the two types of plates.



Figure 12. DagTest 4-15-2011. Solid .999 fine silver sheet (left). .999 fine silver clad copper after 10 minutes immersion in warm salt water (right). The yellow orange coating of silver iodide is still present on the solid silver plate.

The daguerreotypes from this experiment proved that salt water was ineffective in removing silver iodide from a solid silver plate. If Daguerre had not used silver clad copper he may not have discovered a viable working photographic process as early as 1837. My experiments are recorded in a laboratory notebook, the procedure and specific processing details are noted, the experimental daguerreotypes are documented digitally and important processing details are recorded directly on the plate verso. Observations are recorded and recommendations for further experiments are noted. Figure 13 reproduces my notebook page for DagTest 4-5-2011.

Project No. _____ 25
Book No. _____

TITLE PLATE VARIABLES Ag/Cu CLAD vs. 999.6 Solid Ag vs. 925 Silver CLAD

From Page No. _____

PURPOSE: Daguerre suggests that Ag/Cu clad improves the result.
Suggested that the metal be as pure as possible.
Test 3 different plates with iodine only sensitizing

Purpose 2 - Hypothesis: Ag/Cu is necessary to provide cement for salt fixator.
Test to see if pure silver plate can be fixed with H₂O₂.

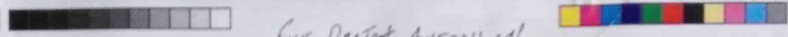

File: DagTest_4-15-2011.ppt

24494-12

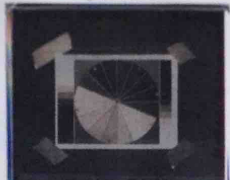

FINE SILVER SHEET

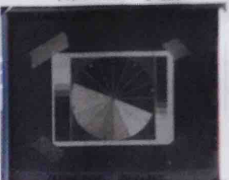

STERLING SILVER CLAD





Plate #	Plate Type	Polish	sensitizing boxes	Iodine	colour	Bromine
24494-12 Fine Silver Sterling Silver	AgCu - 91.8 solid sheet 925 Ag/Cu clad	Method 2010	BSY - HP	60s + 15s dark	yellow tint of rose	None
Ev	Kelvin	Camera	lens	exposure	mercury	fixer
8		1/4 plate	L.B.B. & Co.	30 minutes	172 @ 7.5 min	sodium thiosulfate



clad plate 10% salt solution
fixed in 5 minutes

solid silver plate unfixed by
10% salt after 10 minutes
in 5 minutes

Observations - Clad silver plate is slightly faster with warmer tone than
solid silver.
Purity of the plate is important, Sterling silver plate is veiled
and less sensitive.

All plates re-used - first attempt with white light sensitization was
underexposed at 15 min - These plates were salt fixed.
Silver Clad Copper plates were cleaned of AgI in about 5 min. in 10% w/v
solution (warmer) - Solid silver plate unfixed after 10 min.

Recommendation: Attempt 1/2 Dark sensitized plate.

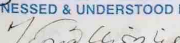
SIGNATURE 	DATE 4/15/2011	WITNESSED & UNDERSTOOD BY 	To Page No. DATE Apr 17/11
--	-------------------	---	----------------------------------

CONFIDENTIAL

Figure 13. Page 25 from my laboratory notebook.

The page from my lab notebook, which details a multi-purpose experiment, serves as an example of my experiment records and the value of the synthetic approach. Daguerre's text indicates that the purity of silver was important and that silver-clad

copper contributed to the perfection of the results. The experiment (DagTest 4-15-2011) was performed on .999 fine silver clad to copper, .999 fine solid silver sheet, and .925 sterling silver clad to copper. I found that daguerreotypes made on sterling silver are significantly poorer in quality as the shadows are veiled and the image lacks contrast. This observation has led me to question the analytical work done in the early 1980s on plates made by Robert Cornelius and is discussed in the next chapter. I have produced in excess of four hundred daguerreotypes over the course of my research with outcomes ranging from complete failure and inconclusive results to confirming a tested hypothesis and in some instances significant new and unsuspected knowledge about the daguerreian system. The laboratory notebook serves to document my research, help me design new experiments based on the outcomes, and cull from these many experiments the significant findings reproduced here.

2.5 Methodology: Conclusion

My research methodology incorporates the synthesis of historical practice to reveal fresh insight into the techniques and materials of the daguerreotype process. This is the first comprehensive study that addresses each step in the process in relation to advancements designed to improve speed, tone and spectral sensitivity, which was the prime motivation for such improvements. This work helps to explain not only why daguerreotypes looked the way they do, but in many cases when they looked that way. Furthermore, replication and synthesis has been a valuable tool to resolve inconsistencies with primary sources. This is a study of the material culture of the daguerreotype.

Daguerreian material culture exists as historic images, apparatus, and texts. This material culture has been researched previously by historians and material scientists, and their interpretation, observations, and conclusions are naturally informed and influenced by their knowledge of the process. There are instances, however, where historical texts are misleading. For example, McLean's English translation of Daguerre's manual claims that the bi-metal silver clad copper plate contributes to photosensitivity, though Daguerre only wrote that silver clad copper contributes to a more perfect result. Daguerre never explained the reason for better results with clad plates, which lead Arago to suggest that electricity plays an important role in the process. McLean's translator has taken Arago's point to mean an increase in photosensitivity, and Barger relayed this as a fact, which in turn, influenced her conclusions related to the analysis of Cornelius's plates. (This is discussed in the next chapter.)

Daguerre, through years of experience with the materials, tacitly knew that the daguerreian image was better reflected on silvered copper, though he did not explain why, perhaps due to the complex nature of the process, clearly indicated when he wrote, "I will have to carefully record the procedures, as there are a

thousand minute details one has to know to succeed".¹³⁴ Tacit knowledge, missing from the written accounts, can be recovered through replication, as has been shown by Gooding's historical experiments from Faraday's notebook and Usselman's re-enactments of chemical analysis using a replica model of Liebig's kaliapparat described in the first chapter.

Replication aside, conservators and material scientists have analyzed historic daguerreotypes to recover information about their chemical and physical nature. There is a risk of misinterpreting the analysis when the processing variables are not explicitly understood. The analytical approach used by M. Susan Barger with early daguerreotypes by Robert Cornelius is flawed because her conclusions are based on the assumption that sensitizing is the only variable that influences image particle morphology. My experiment, designed to test Gros' use of ether combined with mercury show that the development process also influences image particle morphology.

Analysis of historic images is best supported by synthesis but for the work to be credible, the experiments must reasonably conform to past historical conditions. For example, had I used modern electroplated silver rather than historically correct silver clad copper I would not have observed that salt water solutions can electrolytically remove silver iodide from clad plates due to their bi-metal nature. Daguerre discovered salt water was an effective fixer in 1837, but we do not know if he understood the reason to be due to a galvanic process because there are no substantiated historical texts. My re-enactment makes this knowledge explicit.

One of the goals of this research is to recover tacit, craft knowledge of the daguerreotype process as practiced by nineteenth century practitioners as the art progressed. The above example of salt-water fixation is one of several throughout

¹³⁴ Nicéphore Niépce, M. Bonnet, and J.L. Marignier, *Niépce, correspondance et papiers*. Maison Nicéphore Niépce, 2003:1074-5. Document 579. Original in French. This important document is transcribed in its entirety in the next chapter. Contents of this book are searchable online at <http://www.niepce-letters-and-documents.com/> (Date accessed, 17 March 2017)

this dissertation that illustrate how replication, or synthesis, may serve as an effective methodology to make explicit an historical actors' process or discovery.

I argue that effective replications, due to the highly malleable nature of the daguerreotype process, must be designed to minimize plate-to-plate differences resulting from human agency and material conditions. My experimental methods effectively address this issue. For example, when testing the effects of different sensitizing colours, which are controlled by the duration of exposure to the halogen vapours, I perform the experiment on a single plate through selective masking. This ensures that other variables, such as plate preparation, development and gilding do not affect the outcome. This work is not solely about replicative experiments. I add a significant contribution to the history of the daguerreotype by re-examining the primary sources equipped with an artisanal literacy that allows me to extract meaning or an historical actors' intent that others without such experience might over-look or misread.

In the chapters that follow I revisit the literature of the daguerreotype in relation to each step of the daguerreotype process from the silver plate followed by sensitizing methods, exposure with cameras and lenses and finally development and finishing steps. My approach involves not only researching the materials and methods used, but also testing them in practice by making new daguerreotypes to show explicitly how such variables affect the visual qualities of a daguerreotype. The daguerreotypes produced for this work serve to inform historians, scholars, conservators, and collection managers about the techniques and material aesthetics of daguerreotypes and their history.

3.1 The Silver Plate: Overview

The daguerreotype process begins with a silver plate. The entire process was in a continual state of flux as artists improved their techniques and materials in search of better image quality, and indeed, the daguerreotype plate also has its history of material and technological advancements towards this end. The silver plate, like glass and paper in other processes, serves as the support on which the photographic image exists. Unlike paper or glass, the quality of the silver plays a significant role in image creation during each step of the process. Surface polish, sensitizing, mercurizing, fixing and gilding are each influenced by the materiality of the plate, which in turn, affects the speed and tonality of the image. The influence of the silver plate in image formation has not previously been thoroughly investigated. Alice Swan analyzed nineteenth century plates to determine the chemical composition and thickness of the silver layer and of deterioration compounds on the surface¹³⁵ and Irving Pobboravsky described the desirable qualities of nineteenth century plate but only in terms of surface conditions, malleability and silver thickness.¹³⁶ Neither of these researchers addresses the materiality of the silver layer in terms of its effect on the imaging characteristics of the plate.

The aim of this chapter is to first clarify how Daguerre came to use the silver plate in his work, then show how the materiality of the plate (in terms of purity) influences speed and how surface finish influences optical distinctness or contrast. This chapter serves to illustrate how manufacturing methods for silver clad copper in American and England were different to those used by the French. All plates

¹³⁵ Alice Swan, C. E. Fiori, and K. F. J. Heinrich, "Daguerreotypes: A Study of the Plates and the Process." *Scanning Electron Microscopy* 1 (1979): 411-24. Other researchers have followed Swan such as Susan Barger, Silvia Centeno, Patrick Ravines, Ralph Wiegandt and Edward Vicenzi in analyzing daguerreotype plates, but in each case their focus was on determining the chemical nature of the silver plate and/or deterioration artefacts.

¹³⁶ Irving Pobboravsky, "The Daguerreotype Plate as Seen by a Contemporary Daguerreian Artist." *The Daguerreian Annual: Official Yearbook of the Daguerreian Society* (1991): 114-22. Pobboravsky abandoned the plan of making new plates made by the cladding process as he found them unworkable due excess curvature and elongated voids in the surface.

require polishing for reflectiveness and cleanliness, and I show how advancements in both manual and machine assisted methods can be recognized, and how such methods influence image quality. I conclude with galvanizing, a technique where the daguerreian artist adds a pure soft layer of silver to the polished plate using electric current. This process has been misunderstood not only in its origin, but how it is significantly different than modern electroplating methods. Previous researchers, such as Susan Barger have assumed that galvanizing was essentially an American process and that electro-plating is materially the same.¹³⁷

To understand why Daguerre chose the silver plate over other image substrates is necessary to review the technological progress in the work of Niépce and Daguerre. Their work, as this chapter explains, was driven by the need for image tones correct to nature, but more importantly, the need for a quick working process. The progression from pewter, to glass, to silver plate offered speed gains from days, to hours, to minutes. In addition to photosensitivity, the materiality of the silver, in terms of its purity can radically affect image tone. Daguerre advised that the silver clad copper performed better than solid silver but the reason for this has not been explained. Susan Barger who analyzed early daguerreotypes by Robert Cornelius found that his plates were silver alloyed with copper, which she thought surprising, yet reasoned that this impurity contributed to his superior image quality. This contradicts Daguerre's advice that the silver must be pure. To resolve these questions modern samples were produced on sterling alloy, pure silver clad copper and pure solid silver to determine how each type of material affects imaging quality. I have replicated experiments related to plate polishing from the incunabula and mature period of the daguerreian era to illustrate how polishing

¹³⁷ M. Susan Barger and William B. White, *The Daguerreotype: Nineteenth-Century Technology and Modern Science*. 2nd Ed. Baltimore: John Hopkins University Press, 2000: 44-5. Barger and all other contemporary daguerreians before me have used modern electro-plated plates to produce daguerreotypes. They have not understood the difference between clad silver, galvanic deposit silver and electroplated silver. I make the distinction between modern electro-plating and nineteenth century galvanizing because the current density used during the nineteenth century plating process is significantly less. Low current density produces very soft and large-grained silver deposits which yield improved photosensitivity and tone as proven by images made with the galvanizing process according to historical practice.

influences contrast within the image, and finally, a thorough examination of the galvanic process combined with re-enactment experiments reveal the true nature and benefits of using re-silvered plates. The next section explains the reasons why silver became the preferred substrate for Daguerre's photographs.

3.2 The Silver Plate: Technological Progression To Silver

Photographic experiments that preceded and superseded the daguerreotype were produced on metal, paper and glass substrates. These substrates do not play a significant role in forming the light sensitive substance.¹³⁸ The daguerreotype plate, on the other hand, serves an important optical and photochemical role, in addition to being a support for the image.¹³⁹ Daguerre's choice of silver plated copper for the creation of photographic images is directly related to achieving a degree of rapidity, or photographic standard set by Niépce and Daguerre when they formed their partnership in 1829.¹⁴⁰ The purpose of the partnership was to improve Niépce's invention to a practical, marketable state. The Heliograph was not ready for commercialization because it lacked distinctness and clarity due to optical aberrations and blurred shadows from lengthy exposures. Despite the many improvements made to Niépce's process during their partnership it remained impractically slow in photosensitivity. Daguerre explicitly described the photographic standard they were working towards in what has typically been referred to as a broadside, printed in late 1838, listing a delicate gradation of tones, perfection of detail and most importantly speed:

I knew that the only means of complete success was to attain a speed such that it could produce the same effect in the space of a few minutes, so that the sun's rays would not have time to move, and also so that the mechanics of the process would be simpler. It is the solution of this problem I am announcing today. This other process, which is basically quite different and to which I have given my name by titling it Daguerreotype, is greatly superior in speed, in sharpness of image, in the delicate gradation of tones, and in the perfection of detail to that which Mr. Niepce invented, in spite of all the improvements that I made to it. The difference of light sensitivity is as 1 to

¹³⁸ Starch and gelatine sizing in paper and gelatine emulsions on glass affect image quality and speed to a small degree, and silver iodine formed on paper and glass is nearly insensitive, yet when formed on a silver plate silver iodide darkens in minutes when exposed to daylight.

¹³⁹ I suggest an optical role because polish is related to image contrast. At the outset Daguerre worked with unpolished plates.

¹⁴⁰ In a personal communication in 2014, Grant Romer suggested that Daguerre and Niépce were first to establish the basis for the photographic standard that required speed, sharpness and gradation of tones.

70, and compared with the substance known as silver chloride it is as 1 is to 120.¹⁴¹

The 70:1 increase in photosensitivity compares iodized silver plates with Daguerre's improved version of Niépce's process known as the Physautotype. The English translation of the 1838 broadside first appears in *L. J. M. Daguerre, The History of the Diorama and the Daguerreotype*, published in 1956 by Helmut and Alison Gernsheim, (courtesy of Beaumont Newhall) though part of its meaning was altered by the authors in their version of the translation. In the broadside, Daguerre compared the speed of the daguerreotype to the lavender resin based Physautotype. The Gernsheims modify the translation to read, "The difference in its sensitivity to light as compared with M. Niépce's process is as 1 to 70".¹⁴² The underlined text is an insertion not in the French original and places emphasis on Niépce's process rather than Daguerre's improved Physautotype process. This slight alteration of the facts is significant. Not only has Daguerre's role in advancing Niépce's process been downplayed, but also the issue of photosensitivity of the evolving processes has been confused. The Gernsheims seem to have extrapolated from this 70:1 ratio of sensitivity, an eight-hour exposure on a summer's day for Niépce's bitumen based Heliograph. This daylong exposure for the earliest extant camera image has entered the canon of photo-history since Helmut and Alison Gernsheim rediscovered the plate in

¹⁴¹ Beaumont Newhall, "An Announcement by Daguerre." *Image: Journal of Photography of the George Eastman House* 8, no. 1 (March 1859): 32-36. Newhall reproduced the copy of the broadside in *Image* followed by an English translation. The copy, part of the Gabriel Cromer collection has since disappeared, and no others have surfaced. There is no evidence the broadside was circulated. It may have been originally printed to promote the sale of subscriptions to the Daguerreotype, but the plan was abandoned when Arago proposed that the French government purchase the invention outright and gift it to the nation. Nevertheless, this important document contains significant details in Daguerre's own words related to photosensitivity.

¹⁴² Helmut and Alison Gernsheim, *L.J.M. Daguerre: The History of the Diorama and the Daguerreotype*. 2nd revised Ed. New York: Dover, 1968: 80. I have underlined the additional text inserted in this version. The original in French is, "C'est la solution de ce principe que j'annonce aujourd'hui; cet autre procédé, dont la base diffère entièrement et auquel j'ai donné mon nom en l'intitulant DAGUERRÉOTYPE, sous le rapport de la promptitude, de la netteté de l'image, de la dégradation délicate des teintes, et surtout de la perfection des détails, est bien supérieur à celui que M. NIEPCE a inventé, malgré tous les perfectionnements que j'y avais apportés, puisque comparativement la différence de sensibilité à la lumière est comme 1 à 70..."

1952.¹⁴³ ¹⁴⁴ Nearly half a century later, by replicating Niépce's Heliograph process of 1827, Jean-Louis Marignier has found that several days' exposure was necessary.¹⁴⁵ Daguerre and Niépce's Physautotype process of 1833 required several hours exposure, and the *emerging* daguerreotype process of 1835 merely several minutes, as is revealed in correspondence from Daguerre to Isadore Niépce addressed at the end of this section. Before turning to Isadore and the emergent daguerreotype, it is important to understand the technological progression of techniques and materials to illustrate how the silver plate was chosen by Daguerre to serve the partners' photographic standard, being vastly superior in light sensitivity.

A Popular Treatise on the Art of Photography begins with the history of the new art in its first 1841 edition.¹⁴⁶ The author, Robert Hunt notes that the earliest attempts to create images by light induced chemical reactions using silver compounds were made by Wedgwood and Davy in 1802, followed in 1814 by Niépce.¹⁴⁷ The darkening of silver salts is a chemical reaction known as photolysis. Wedgwood and Davy's images were photo-reduced microscopic silver particles made by partially covering the light sensitive substance to block sunlight. The solution of two fundamental problems was deemed important for successful photography. First, the images had to resist further change in light and second the values of light and shade in the scene had to be reproduced in their natural order. In the photolysis of silver compounds, the substance exposed to light darkens, reversing the tones in nature.

¹⁴³ Jessica S. McDonald, "A Sensational Story: Helmut Gernsheim and "the World's First Photograph"." In *Photography and Its Origins*. New York and London: Routledge Taylor and Francis Group, 2015: 25-35.

¹⁴⁴ Gernsheim and Gernsheim, *L.J.M. Daguerre*. 2nd revised ed. New York: Dover, 1968: 53.

¹⁴⁵ Jean-Louis Marignier, "Heliography: New Light on the Invention of Photography." *The Daguerreian Annual: Official Yearbook of the Daguerreian Society* (1996): 58-60.

¹⁴⁶ Robert Hunt, *A Popular Treatise on the Art of Photography, Including Daguerreotype, and All the New Methods of Producing Pictures by the Chemical Agency of Light*. Glasgow, 1841.

¹⁴⁷ Robert Hunt, *A Manual of Photography*. J.J. Griffin and co., 1853: 12. Missing from Hunt's list of early experimenters is Elizabeth Fulhame who in 1780 attempted to produce patterns on fabric in photo-reduced metal compounds. See Larry J. Schaaf, *Out of the Shadows: Herschel, Talbot and the Invention of Photography*. Yale University Press, 1992: 23-25.

Nicéphore Niépce solved the first problem in 1824.¹⁴⁸ Having abandoned silver chloride as unstable and counter-productive, he experimented with the light sensitivity of organic resins. Niépce coated a limestone slab with a solution of powdered bitumen in lavender oil and set it smoothly with heat. The coating, a light golden brown residue, was hardened by oxidation and became insoluble. The oxidation process is accelerated by UV light exposure, though painstakingly slow in photographic terms. Niépce required several hours when making a contact print from an oiled engraving, or several days if attempting to secure a view in a camera obscura. After exposing the coated stone to sunlight, he dissolved the softer, soluble residue in lavender oil diluted with mineral spirits, then washed his image with gentle flow of water and set it aside to dry. Niépce referred to the image on limestone as a counter proof (negative) as he wrote to his brother Claude. He noted that it was best seen with the stone held at an oblique angle to cause the polished surface to reflect a dark field. Only under these extreme viewing conditions would the image appear positive.¹⁴⁹

Niépce adopted etching to solve the problem of reversed tones. He replaced the limestone support with metal, a necessity for acid etching, first with copper, then pewter, and finally silver-plated copper.¹⁵⁰ The hardened bitumen served as a

¹⁴⁸ Nicéphore Niépce, M. Bonnet, and J.L. Marignier, *Niépce, correspondance et papiers*. Maison Nicéphore Niépce, 2003: 706-11. A letter from Nicéphore Niépce to Claude Niépce (No. 384) dated September 16, 1824 is the earliest note of successfully fixing a point-de-vue, referring to an image created in a camera.

¹⁴⁹ Jean-Louis Marignier, "Heliography: New Light on the Invention of Photography." *The Daguerreian Annual: Official Yearbook of the Daguerreian Society* (1996): 59-63. Jean-Louis Marignier has proved that exposures of four or five days are necessary in summer with a lens aperture of *f*/4. In replicating the work of Niépce, Marignier has revised our understanding of primitive photography and provides a clear conception of the limitations of Heliography at the time Niépce first met Daguerre.

¹⁵⁰ Niépce et al, *Niépce, correspondance et papiers*. 2003: 740-1, 749,755-7, 876-7. Letters no. 404, no. 399, no. 409, and no. 479. Niépce sent two small copper plates with bitumen images on them to Lemaître sometime in July 1825. Recognizing that his own skills for etching or engraving were lacking, he asked Lemaître, an expert, to etch and make prints from them. On May 26, 1826 Niépce wrote to his son Isidore that he was quite pleased with himself for switching to polished tin (pewter) plates, which made it easier to see his views created in camera. Lemaître was not so enthused with Niépce's choice. He observed that pewter was too soft a metal to print more than a few copies from, and he may have recommended that Niépce try silver-plated copper that had both the strength for engraving and the greater surface reflectance for viewing his camera images. On

resist to acids. Once etched, the resist was removed and the metal plate was inked and printed similar to the intaglio process. The success of this method was limited to the reproduction of engravings by contact exposure, and according to Daguerre, acid was never used on plates produced in the camera.¹⁵¹ Engraving with acid requires very discreet lines which were not obtainable within a camera at this time due to non-planar optics and exposures lasting several days. Shadows move with the sun causing the bitumen resist to be indistinct, thus making it impossible to etch for ink printing.

Nicéphore travelled in haste to London in the fall of 1827 with the news of his brother's illness and brought along images to promote his process abroad. Francis Bauer, residing at Kew-Green and secretary of the Royal Society, upon viewing Niépce's photograph(s) and photo-engravings encouraged him to write a memoir to be read before the membership.¹⁵² This memoir, according to Victor Fouque, was never published in *Proceedings of the Royal Society* because it lacked the experimental details.¹⁵³ Larry J. Schaaf indicates that hard luck, bad timing and a dysfunctional leadership in the Royal Society may have played a role.¹⁵⁴ A third possibility is that the process just wasn't ready, as noted by Sir Evrard Home, Vice President of the Royal Society. "The discovery he [Niépce] considers not brought

August 20, 1828, Niépce complained to Lemaître that his work had been delayed while waiting for suitable silver-clad copper plates.

¹⁵¹ Louis Jacques Mandé Daguerre, and J.S. Memes, *History and Practice of Photogenic Drawing on the True Principles of the Daguerreotype*, Tr. By J.S. Memes. 1839: 41.

¹⁵² Dr. Dusan C. Stulik and Art Kaplan, "Niépce and Daguerre: Daguerre and Niépce " In The Daguerreian Society Symposium. St. Petersburg, Florida: Getty Conservation Institute, 2011. Niépce left four plates in the care of Francis Bauer; two acid etched plates for printing, *Le Cardinal d'Amboise* and *Christ Carrying his Cross*, one bitumen point de view (camera made image), *View from the Window at Le Gras*, and one photographic reproduction of an engraving, coincidentally, copied a painting by Daguerre, titled *Un Clair de Lune*. I suggest photograph(s) because the copy plate *Un Clair de Lune* seems to have been produced with the intention of being a photographic end product, not having been etched for printing and the image consists of lavender resin alone. Lavender resin appears whiter without the bitumen colourant, allowing to plate to be better seen as a photographic positive.

¹⁵³ Victor Fouque and Edward Epstein, *The Truth Concerning the Invention of Photography: Nicéphore Niépce; His Life, Letters and Works [in English]*. New York: Tennant and Ward, 1935: 82.

¹⁵⁴ Larry J. Schaaf, "Niépce Abroad: Britain in 1827 & 1839 - Russia in 1839 & 1994." In *Nicéphore Niépce, Une Nouvelle Image*, 100-06. Chalon: La Société des amis du Musée Nicéphore Niépce 1998: 100-106.

to perfection, and therefore has not promulgated it: he has presented me with a specimen...however much it is diminished.”¹⁵⁵ Niépce wrote with candour about the limitations of Heliography at this time. In *Notice sur l’Heliographie*,¹⁵⁶ he explains:

My framed pictures, made on pewter, will doubtless be found too weak in tone. This defect springs principally from the fact the light parts do not contrast sufficiently with the shades which result from the metallic reflection. It should be easy to remedy this by giving more whiteness and brilliancy to those parts which represent the effects of light, and by receiving the impressions of this fluid [e.g. light] on plated silver well polished and burnished; for then the contrast between white and black would be all the more marked, and this latter colour, intensified by means of some chemical agent, would lose its glare, which is unpleasant to the eye, and sometimes produces an incongruous [negative] effect.¹⁵⁷

He admitted that his work was preliminary and suggested further experiments to improve the contrast of his images. Two of the plates he left with Francis Bauer in London differ in terms of highlight brightness. *View from the Window at Le Gras* has duller image highlights than *Un Clair de Lune*, the reason being the latter has little or no bitumen mixed with the lavender oil imaging material.¹⁵⁸ Daguerre inserted a critique of Niépce’s notes on Heliography in his manual noting that “The

¹⁵⁵ Schaaf, “Niépce Abroad: Britain in 1827 & 1839 - Russia in 1839 & 1894.” 1998: 103.

¹⁵⁶ Niépce et al, *Niépce, correspondance et papiers*. 2003: 790-808. Maignier points out that Niépce wrote three notices of heliography at this time. The first dated October 31 was written to Mr. Aiton, the Royal Gardener at Kew, in hopes of getting an audience with the King. The second, dated November 4 or 5 was unaddressed and the last dated December 8 was addressed to Francis Bauer.

¹⁵⁷ Helmut and Alison Gernsheim, *L. J. M. Daguerre (1787-1851): The World’s First Photographer*. Cleveland; New York: World Pub., 1956: 65.

¹⁵⁸ Dr. Dusan C. Stulik in personal communication. The presence of lavender without bitumen has been confirmed by x-ray fluorescence analysis performed by Dr. Dusan Stulik. In a personal communication in 2013 with Dr. Stulik, he posited that *Un Clair de Lune* might in fact be a physautotype, a process co-invented with Daguerre in 1832. This is not possible as this plate is dated in Bauer’s hand, 1827. Maignier has shown that the way in which lavender oil is used in Niépce’s Heliograph is quite different from its use in Niépce and Daguerre’s Physautotype. In the first instance lavender oil is the solvent for bitumen. If used on its own, as I suggest was done for *Un Clair de Lune*, lavender oil would oxidize with light exposure, the still soft coating dissolved in a lavender oil and alcohol mixture. In the second instance lavender oil is distilled by heat to a powdery residue that is dissolved in alcohol. This solution, once dried on a plate forms a frosted white coating that is exposed to light. The image is developed (cleared) with kerosene vapour; no coating is dissolved. If prepared on glass and blackened on the verso the image would have looked much like a precursor to the ambrotype, if on polished silver much like the daguerreotype.

clearest tint which is obtained by this process is not *white*.— M. Daguerre."¹⁵⁹

Whiteness refers to highlight brightness; an important consideration for image quality and a clue to their path of discovery. A few years later, Daguerre improved the heliograph using the residue of distilled lavender oil to create the whiter highlights on glass and metal physautotypes.

The degree of whiteness is critical for camera images to appear positive rather than negative. Niepce had found that his bitumen images adhered far better to polished silver than glass when rinsing. To better preserve images on glass, Niépce substituted Dippel's oil for lavender oil, but due to its increased oiliness it repelled the rinse water. This substance, Daguerre noted, was even more coloured than bitumen, and counter-productive to producing images with good contrast and tones in their natural order.¹⁶⁰ The greater tenacity of bitumen on silver compared to glass contributed to continued experiments with this metal.

Nicéphore Niépce had described to his brother the essence of the daguerreian optical system in 1824 when he observed the effect of bitumen on stone and pewter. To be viewed as a positive image, highlights must appear brighter than the shadows; this occurs if the non-image surface of the plate reflects a darkened room while the image surface scatters light incident from an oblique angle. Niépce, knowing that silver can be polished to a more reflective surface than pewter, explained in his *Notice* that the contrast between white and black would be "all the more marked" if made on a silver plate.

Niépce continued working and wrote to Lemaître in the fall of 1829 encouraging him to visit Daguerre's studio to see the new plates just sent to Paris. Lemaitre, the engraver who printed Niépce's experiments, responded with the assumption that the plates were etched, where after Niépce corrected him by stating that they were merely blackened. Niépce revealed to Daguerre the new substance to

¹⁵⁹ Daguerre, *History and Practice of Photogenic Drawing*, Tr. By J.S. Memes. 1839: 34.

¹⁶⁰ Daguerre, *History and Practice of Photogenic Drawing*, Tr. By J.S. Memes. 1839: 34-42.

Niépce wrote the complete details of his process in a note dated December 5, 1829. These notes were given to Daguerre upon signing of their co-partnership agreement that same month. Daguerre reproduced these notes in his manual.

blacken silver was iodine.¹⁶¹ Niépce noted that his completed image looked well enough as is, though to blacken the plate he placed it, with the bitumen layer intact, inside a tall wooden box leaning vertically against one of the sides. Opposite that side in a groove he placed a few iodine crystals. The open top of the box was then covered with a piece of glass to contain the iodine vapour through which Niépce could observe the plate as it darkened. With this box design, it is hard to imagine that he would not have known that darkening of silver iodide was induced by light exposure, as this was reported by Sir Humphry Davy as early as 1814.¹⁶²

The problem with silver iodide was the same as silver chloride; when exposed to light, the substance turned black. Niépce's plan to reverse the tones of his heliographs with iodine vapour was ingenious.¹⁶³ He exposed his bitumen camera images to iodine vapour. The vapour diffused through the image layer proportionally according to the thickness of the hardened bitumen. The silver iodide formed would blacken and Niépce then removed the bitumen to reveal a photograph in tones correct with nature. The dark values were comprised of photo-reduced light absorbing silver particles and the highlights were the white lustre of unpolished silver metal. (Polishing the plate in this instance would be counter-productive). While there are no extant Niépce made bitumen images blackened with silver iodide, Jean-Louis Marignier in 1996 has proven by replication that this method was the first to successfully reproduce continuous tone camera images, though the exposure required four or five days.¹⁶⁴

Niépce was able to create camera images having continuous tones correct to nature but the exposures were impractically long. Photo-engraving at this point

¹⁶¹ Prior to iodine, Niépce tried unsuccessfully to blacken the silver with sulphur.

¹⁶² Humphrey Davy, "Some Experiments and Observations on a New Substance Which Becomes a Violet Coloured Gas by Heat." *Philosophical Transactions of the Royal Society* (1814): 76.

¹⁶³ Niépce et al, *Niépce, correspondance et papiers*. 2003: 921-926. Letter no. 506, dated November 29th, 1829, is the earliest known written account of Niépce's use of iodine to blacken the shadows of his plates.

¹⁶⁴ Marignier, "Heliography: New Light on the Invention of Photography." (1996): 52-63.

had reached an impasse, as it was only successful for the reproduction of pre-existing line drawings by contact exposure. Daguerre stated that Niépce never etched a point de vue and noted that even with the best optical apparatus, engraving of camera images was not possible because the long exposure caused indistinct shadows.¹⁶⁵ At this point Niépce was short of funds and energy. Much impressed by Daguerre's inventive genius with light sensitive phosphorous incorporated into his diorama paintings; he proposed an offer of partnership. The articles of the agreement state that both partners would share equally in the proceeds from the development of a marketable photographic process. It was agreed that each partner's input would be of equal value. Niepce would contribute his secret of Heliography and Daguerre would contribute his new camera design, his talents, and his initiative. Niépce's lens projected an increasingly blurred image from centre to edge. This combined with blurred shadows from long exposures made it impossible to render a well-defined image. Daguerre's camera had an achromatic lens that projected a sharp image from centre to the edges of a plate, but it did not enhance the speed of the operation. Daguerre needed to find substances with much greater light sensitivity to have any hope of reproducing what he saw on the ground glass of his camera, requiring a *three-hundred* fold increase in photosensitivity to reduce camera exposure times from days to minutes.

Charles Chevalier, the optician who encouraged Daguerre to seek out Niépce in 1826, wrote a memoir entitled *Éloge de Daguerre. - Documents historiques, lettres inédites de N. Niépce, etc.* in 1854 describing the character of the two inventors. Niépce was portrayed as a man with extensive scientific knowledge, though not well studied in chemistry. Chevalier knew Daguerre well by his weekly visits to the optical shop to share talk of lenses and dreams of securing images from the camera. Chevalier noted that obligations with the Diorama left Daguerre

¹⁶⁵ Louis Jacques Mandé Daguerre, *History and Practice of Photogenic Drawing, Tr. By J.S. Memes*. 1839: 41. Photo-engraving of continuous tone images would not be possible until the introduction of the half-tone screen.

no time to study science; during this period, he conducted his experiments empirically. Daguerre's habits changed however, once the contract with Niépce was signed. His visits to Chevalier ceased, and for two years he ensconced himself in his laboratory, passionately studying chemistry, while surrounded by books, pipettes and flasks.¹⁶⁶ Daguerre's experimental talents are revealed in a letter where he advises Niépce (precisely one month before Niépce died) on how best to conduct an experiment with the physautotype to achieve the whitest whites.

167

The partners tested a dizzying combination of supports, resins, solvents and colourants searching for improved image contrast. Polished and matte silver plate, iron plate, steel plate, glass, resin, phosphorous, sugar dusted on sticky varnishes, black smoke and ivory black are among the over one hundred materials and methods they experimented with.¹⁶⁸ Daguerre's improved heliographic process was described in *Historique Et Description Des Procédés Du Daguerreotype Et Du Diorama*, but it was not mentioned by the name Niépce and Daguerre coined for it; the Physautotype. The process had the advantage of greater whiteness and much improved speed requiring hours rather than days. A point de vue could be recorded in six to eight hours or less if the light was brilliant.¹⁶⁹ The improved whiteness came from a very thin film of the residue of distilled lavender oil, however it was so thin that it could not withstand immersion in solvents. Daguerre

¹⁶⁶ Charles Chevalier, "Éloge de Daguerre. - Documents historiques, lettres inédites de N. Niépce, etc.". Chap. Troisième Partie. In *Guide du photographe*. Paris, Palais Royale 158: C. Chevalier, 1854. 23.

¹⁶⁷ Niépce et al, *Niépce, correspondance et papiers*. 2003: 1024-26. Document 554. Niépce and Daguerre observed that each were getting different whites in their tests and suspected that minerals in their local water supply might be a contributing factor. Daguerre sent a water sample from the Seine and advised Niépce to dip 1/3rd of a plate in Paris water, an opposite third in water from the Saône and leave the centre dry to observe the effect. Isolating variables on a single plate is a very effective way to observe cause and effect.

¹⁶⁸ Niépce et al, *Niépce, correspondance et papiers*. 2003: 952-54. Document 513. This document is a hand written list of material and methods totalling 101 numbered items. The materials were described by number rather than name in correspondence between Niépce and Daguerre to maintain secrecy.

¹⁶⁹ Daguerre, *History and Practice of Photogenic Drawing, Tr. By J.S. Memes*. 1839: 45.

solved this problem by developing the plate with kerosene vapour, which did not remove the unexposed matte white film, but clarified it.

All the while Daguerre worked on improving the resin process he knew that silver iodide prepared on a silver plate required only minutes for the darkening effects of light exposure to be visible. He experimented with iodized silver plates because they were significantly quicker than the physautotype process and wrote to Niépce, "We should find a way to reverse the effect that is contrary to nature [convert blackened silver to white] and above all, fix the image...or find a way to get the same promptness from our other substances."¹⁷⁰ Daguerre's success with using solvent vapours for the physautotype must have contributed to the accrued knowledge that led him to use mercury vapour to attempt to convert the blackened silver on printed-out iodized silver plates to white, though there is no documentary evidence to show that he worked with mercury before the death of Nicéphore Niépce in July 1833.

Daguerre, mourning the loss of his partner, all the while occupied with painting tableaux for the Diorama meant little progress was made in 1834. He returned to photographic experiments in the spring of 1835, and during this time revised his original contract with Niépce senior to recognize his recent discoveries and re-name the partnership. There are two key points noted in the additional contract language. First, the process invented by Niépce and improved by Daguerre (referring to the Physautotype) could not be advanced any further. Second, Daguerre had realized after much experimentation that it was possible to get even faster results by a process that he had discovered, but had not yet brought to fruition (referring to iodized silver plates).¹⁷¹ These points, Daguerre reasoned, were justification to change the first article of the original 1829 contract which named the company as *Niépce-Daguerre*, to read *Daguerre et Isadore Niépce* and

¹⁷⁰ Niépce, et al, *Niépce, correspondance et papiers*. Maison Nicéphore Niépce, 2003: 989-90. Letter no. 532.

¹⁷¹ Victor Fouque and Edward Epstein, *The Truth Concerning the Invention of Photography: Nicéphore Niépce; His Life, Letters and Works* [in English]. New York: Tennant and Ward, 1935:112-3.

change the purpose of the contract which originally stated that Daguerre was to improve Niépce's discovery, to that of exploiting the discovery invented by M. Daguerre and the late Nicéphore Niépce.¹⁷² Niépce's son Isidore inherited his father's contract and struggled to acquaint himself with the physautotype process as revealed by Daguerre's correspondence with him. He wrote to Isidore on four occasions in 1835 to apprise him of his work and respond to Isidore's difficulties.¹⁷³ By August, Daguerre was "convinced more than ever" to abandon the physautotype in favour of silver plates but wrote, "I however do not urge you to cease your work because with the new process it is impossible to obtain proofs on glass"¹⁷⁴ Daguerre also indicated that he had restored the image tones correct to nature. This shows that he had found a way to convert the black, print-out, silver image to white with mercury vapour but had not yet discovered an invisible latent image which further reduced exposure times. Daguerre's last letter in 1835 reveals the limitations of the physautotype process, and contains important clues to his work with silver iodized plates in terms of rapidity, allowing for exposures in one-sixtieth the time, proving that he had, by then, discovered latent image development.

¹⁷² Helmut and Alison Gernsheim, *L.J.M. Daguerre: The History of the Diorama and the Daguerreotype*. 2nd revised ed. New York: Dover, 1968: 187-9.

¹⁷³ Daguerre's letters to Isidore Niépce in 1835 are dated, April 1, August 4, October 5, and December 15. In the April letter Daguerre invites him to come to Paris during the first fortnight in May saying it will take four or five days to acquaint him with the new methods and it is during this visit that the revised contract is signed. In the August letter Daguerre offers advice on producing the matte surface required for the physautotype process, but he is more inclined towards iodized silver plates. Daguerre's October 5th letter indicates his regret that the months of April, May, June and July were required for work on tableaux for the Diorama, but of great significance is the first mention of portraiture and a sixty times increase in photosensitivity. This is unquestionably due to Daguerre's discovery of the latent image with silver iodized plates.

¹⁷⁴ Niépce, et al, *Niépce, correspondance et papiers*. Maison Nicéphore Niépce, 2003: 1070-71. Letter no. 576. While the physautotype can be produced on silver plate or glass, it is apparent that Isidore Niépce only had glass at hand. The new process (daguerreotype) required silver plates.

Dear Isadore

DIORAMA

Paris, 15 December, 1835.

I have refrained from writing to you because I have been working very much on our affairs and I wanted to wait until I had something new to report.

Well however, I have found several ways to make the first substance [silver iodide] disappear which is of utmost importance to the secret of securing the image, yet none is perfectly suitable.

I still hope that this month will not pass without my having something more satisfying. You will understand, my dear friend, that I must conduct my research here because I need a multitude of materials which I could not, without great difficulty get at your location, not to mention that my pictures [Diorama paintings] need my supervision. If I came to work with you we would have but a few days, and the effort would achieve nothing, because with the old process [physautotype] at this time of year it is very difficult to get satisfactory results even with very long exposures.

It is not the same by the new process, in this season I obtain in fifteen minutes the same results that I did not obtain in less than 3 hours in summer by the old method, and results that I get in fifteen minutes [now], in summer, should not take more than three or four minutes: I even have the hope to make portraits, as the possibility seems within reach.

But I cannot tell you here about the manner of operating; for that I will have to carefully record the procedures, as there are a thousand minute details one has to know to succeed; even so, it will be necessary for you to conduct your experiments under my watchful supervision, so that I can be sure you are not confused or miss any important steps. [Daguerre then addresses Isadore's difficulty with the physautotype process] It is the same for the matte coating you are having difficulty with, I cannot guess from a distance the reason for your failure. I have one in a dozen times had my coatings turn glossy, and it was always easy to explain the reason. Either I had too great a quantity of the substance, or introduced too much heat into the box. In short, I can tell you after one moment of examination, it was always easy for me to guess the cause of the failure.

I regret that you could not make some proofs this past summer with such favourable light because the new process does not work on glass. This is my only regret because in terms of promptitude, the difference is at least 1 to 60, since the proofs of medals which you saw, which were not made in less than an hour in the solar apparatus you know, would not take a minute

to obtain the same result. You see that the difference is enormous, and that gives us, especially if I manage to achieve enough quickness, the ability to make portraits and take greater advantage of the discovery.

Thus, my dear friend, as it is difficult for you to help me with these experiments, not being nearby and hard for you to obtain the necessary materials yourself, and when I finish completing the process, it will be necessary that we find the means of working at least fifteen days together. I will write again as soon as I have something new to show you and we will then decide what course we must take.

I am sad to learn that you are upset. I hope you will be appeased now. Be assured that you have my most sincere friendship.

Daguerre.¹⁷⁵

This extremely informative letter, translated here for the first time has gone unnoticed by previous authors including Pinson.¹⁷⁶ My translation¹⁷⁷ has been greatly informed by experiments with iodized silver plates, shown in the next chapter, and by experiments using mercury vapour to convert *visible* and *latent* images on iodized silver plates to positive images, shown in the chapter on development. This letter reveals that Daguerre had found several ways to stabilize the photograph, but he is still unsatisfied. It indicates that the process with silver iodized plates is complicated and the thousand little details are held tacitly with Daguerre who suggests to Isadore Niépce that even with a written description of the method, it would be best if he came to Paris for fifteen days of supervised experimentation. After the public announcement in 1839, Isadore Niépce indignantly stated that Daguerre stole the credit for his father's invention and his contributions were "pretended improvements, and vainglorious imaginations" because Daguerre shared nothing of his new work, yet forced him into signing the

¹⁷⁵ Niépce, et al, *Niépce, correspondance et papiers*. Maison Nicéphore Niépce, 2003:1074-5. Document 579. Original in French.

¹⁷⁶ Stephen C. Pinson, *Speculating Daguerre: Art and Enterprise in the Work of L. J. M. Daguerre*. University of Chicago Press, 2012:118. Pinson references Daguerre's letter of October 5th, 1835 to show Daguerre's preoccupation with the Diorama.

¹⁷⁷ I thank François Brunet for reviewing my translation for accuracy.

revised contract in May 1835.¹⁷⁸ This letter proves otherwise. Proofs of medals were shown to Niépce in May but they were sixty times slower than the new process, indicating that throughout the summer, Daguerre was still trying to convert print-out silver iodide from black to white. Critically important is the clue that Daguerre discovered the latent image with its enormous speed gain *after* August 4th, but certainly before the first week of October and likely in the latter half of September when a brief note appeared in *Journal des Artistes* indicating that Daguerre had succeeded in fixing the image of the ordinary camera obscura.¹⁷⁹ The notice suggests that portraits may be preserved indefinitely. The ability to make portraits, Daguerre wrote in the above letter, would be of great advantage to the discovery. It is clear from the letter that due to the weak light of the season he had not yet attempted portraiture, estimating that with the camera (lens) Niépce was familiar with, in summer light, only a minute's time would be necessary. With his own camera, he assumed summertime exposures would require about 3 to 4 minutes.

The quick exposures times described by Daguerre in December 1835 could *only* have come from latent image development on sensitized silver plates. This is confirmed by my experiments shown in later chapters. No other materials or methods at this time approached such rapidity. The physautotype was 70 times slower and silver chloride was 120 times slower. In other words, if Talbot had used Niépce's camera it might have taken him two hours to record his famous *Oriel Window* salted paper negative in the bright sunshine of August 1835 while Daguerre would have finished his exposure in a minute.

Daguerre had achieved the necessary speed to meet his photographic standard in the autumn of 1835, but was dissatisfied with the image quality and still considered the process incomplete at mid-December. In replicating the process one can immediately see continuous tones, correct to nature when the plate is

¹⁷⁸ Fouque and Epstean, *The Truth Concerning the Invention of Photography: Nicéphore Niépce; His Life, Letters and Works [in English]*. New York: Tennant and Ward, 1935: 113.

¹⁷⁹ "Diorama." *Journal des Artistes* 13 (September 27, 1835): 203-4.

removed from mercury development, but what must have concerned Daguerre at this time was the lack of clarity and contrast. He would achieve this within two years by improving the quality and polish of the plate, and the discovery of a better means to fix the image.

The historical texts have guided my experiments and in turn these experiments have given me the insight to uncover significant details that have not been recognized by prior historians. I have shown by reviewing the progression of materials and methods that Daguerre's use of the silver plate is due to its superior photosensitivity when used with iodine to produce a latent image. The next section explains how the materiality of silver metal itself affects the final outcome.

3.3 The Silver Plate: Materiality of the Plate

The materiality of the daguerreotype plate must be addressed because the silver metal combines with iodine and bromine to form the light sensitive surface. Material properties such as purity, surface uniformity and silver grain size (which is related to hardness) directly affect image quality. Authors Floyd and Marion Reinhart and M. Susan Barger in the early 1980s have written about some of these qualities, but they have only examined historical texts and vintage daguerreotypes, and as a consequence, they have relied on inference to base their conclusions.¹⁸⁰ Replicative tests using silver plates that conform to historic materials allows for clear and explicit conclusions. I will concentrate on silver purity in this section, as this is critically important for image quality, leaving surface uniformity and quality of polish for the next section.

Daguerre explicitly stated in his manual that the silver must be as pure as possible.¹⁸¹ J. Meme's English translation, dated September 13, was advertised in *The Globe* that same evening and within the month daguerreotypes were being made in London.¹⁸² One maker, a chemist at the Royal Polytechnic named J.T. Cooper was licensed by Miles Berry to exhibit and perform demonstrations for an admittance of one shilling. Berry was Daguerre's patent agent in England who had to contend with a Frenchman named Michel de Ste. Croix who simultaneously was giving demonstrations free of charge at the Adelaide Gallery.¹⁸³ Barry eventually

¹⁸⁰ Floyd and Marion Rinhart, *The American Daguerreotype*. Athens: University of Georgia Press, 1981.

M. Susan Barger, "Robert Cornelius and the Science of Daguerreotypy." In *Robert Cornelius: Portraits from the Dawn of Photography*. Washington, DC: Smithsonian Institution Press, 1983.

¹⁸¹ Louis Jacques Mandé Daguerre, *Historique et Description des Procédés du Daguerreotype et du Diorama*. Alphonse Giroux et Cie ed. Paris: Delloye, Libraire, 1839: 59. Daguerre wrote, "L'argent doit être le plus pur possible."

¹⁸² R. Derek Wood, "Ste Croix in London. 1839." *History of Photography* 17, no. 1 (1993): 105. Wood followed this article with a monograph *The Arrival of the Daguerreotype in New York*. New York: The American Photographic Historical Society, 1995. These works clearly illustrate how rapidly the daguerreotype spread across the western globe.

¹⁸³ "The Daguerreotype in London." In *The Morning Post*. London, England, Friday, October 11, 1839; Issue 21440. Nineteenth Century British Library Newspapers: Part II. For recent scholarship on the English daguerreotype patent see Edwards, Steve. "'Beard Patentee': Daguerreotype Property and Authorship." *Oxford Art Journal* 36, no. 3 (2013): 369-94.

stopped him with a court injunction, but not before a review of the two men's work appeared in the *Morning Post*, a mere seven weeks after the daguerreotype was revealed in August. The reviewer in *The Daguerreotype in London* noted that, even with similar facilities at the two institutions, each man had produced different results. He goes on to explain:

The sky in M. Ste. Croix's landscapes presents a delicately blue tint, equally diffused - that in Mr. Cooper's is greyish, but the dark outlines of the houses in one of his best pictures (a view of Langham-place and the church adjoining) are curiously set off by a bright kind of reveal in the surrounding air as if all the colouring particles had been repelled to a distance from the lines of a steamy shadow.¹⁸⁴

William Henry Fox Talbot, who was living in London at this time, had the opportunity to visit Ste. Croix at the Adelaide Gallery. He wrote to his mother, Lady Fielding, to explain that if he were going attempt the process himself, he would have to order his plates from France. His note is particularly important, as it reveals a clue for the difference between St. Croix and Cooper's daguerreian images. Talbot stated, "... the chief embarrass is, that London plated copper will not answer (nobody knows why) & that it is therefore necessary at present to import the plates from Paris".¹⁸⁵

Was this really so? I formed a hypothesis that London plated copper was inferior supposing it was impure Sheffield plate.¹⁸⁶ Sheffield plating is made with

¹⁸⁴ "The Daguerreotype in London." In *The Morning Post*. October 11, 1839. The bright reveal is describing the "Mackie line" effect, but that is not the point I wish to make here. In many daguerreotypes a thin bright white edge separates a dark shadow are from an adjacent overexposed solarized sky that appears blue. My point is that the steamy shadows and grey skies of Cooper's plates compared to the delicate blue tint of Ste. Croix's are due to the silver plate. Cooper sourced his plates in London white Ste. Croix most likely brought French-made plates with him.

¹⁸⁵ W.H.F. Talbot, "The Correspondence of William Henry Fox Talbot." Leicester: DeMontfort University. Online database <http://foxtalbot.dmu.ac.uk/index.html>. (Date accessed, 15 May 2013) Original part of the Royal Photographic Society Collection at the National Media Museum, Bradford. Document number 3949. In a letter to his mother, dated October 5, 1839, W. H. F. Talbot explains that the "chief embarrass" in making successful daguerreotypes is that plates made in London did not work as well as imported French plates.

¹⁸⁶ In 2004, Mark Osterman gave me a sample of silver clad copper that he found in a New York jeweller's supply store. The material was labelled "ss" which he quipped to mean "silver surprise". The plate yielded horribly fogged and low contrast images. Subsequently, I had the material

silver alloyed with roughly seven percent copper, also known as .925 Sterling. Pure silver is .999 fine silver. I made a daguerreotype on .925 sterling silver clad copper, (DagTest 4-15-2011) and repeated the experiment on another sterling clad plate that I had previously added pure silver by precipitation to one-half of its surface (DagTest 3-18-2012). Images on sterling silver were invariably veiled in the shadows, with dull highlights and lacking contrast, whereas the side of the sterling silver plate with pure silver added was relatively clean and bright (Fig 14).

analyzed and it contained approximately 7% copper. This identified it as Sterling silver plate. I found that I could make fine images with it if I re-silvered the plate with pure silver.



Figure 14. Dag Test 4-15-2011. Image on sterling silver clad plate (left). Dag Test 3-18-2012. Sterling plate with pure silver deposited on right side before use (right).

The above experiments were prepared according to refined polishing techniques, using a lens from 1844. I repeated the experiment on pure and Sterling plates using the materials and techniques available to Cooper and Ste. Croix in the autumn of 1839. A pair of daguerreotypes (DagTest 3-13-2013) were made with a Chevalier daguerreian lens mounted to an accurate replica of Daguerre's camera design built by Giroux. The plates were polished precisely as described in the first manual, with olive oil and pumice, dilute nitric acid, heated, and polished again with dry cotton and pumice. They were sensitized only with iodine and developed as Daguerre directed. There is a significant difference between images made on sterling and fine silver when prepared according to Daguerre's instructions and the results conform to the descriptions of Ste. Croix and Cooper's plates in the *Morning Post* (Fig. 15).



Figure 15. Dag Test 3-13-2013. Image on fine silver (left). Image on sterling silver (right).

The sky in the image made on the pure silver plate presents a delicately blue tint and the tone of the image on the Sterling plate is greyish, with steamy shadows, similar to the description of the images by Ste. Croix and Cooper in *The Morning Post* quoted earlier. This test confirms that London plated copper would not answer if it was sterling silver. Daguerre may have had the same experience with his early experiments. A foreign correspondent, likely a Frenchman, wrote on January 16, 1839 that he had seen examples of Daguerre's images made four years earlier, which had a "...slight haziness... [a] defect he has now entirely overcome."¹⁸⁷ The haziness, or lack of contrast in 1835 was the result of the state of the art at that time. Perhaps the cause was impure silver. According to the French assay laws of 1797 still in effect, the purity standard for première qualité silver was .950 plus or minus five parts per thousand.¹⁸⁸ Perhaps the haziness was due to imperfect polish. Whatever the reason, it is clear that at some point Daguerre realized that the silver must be pure.

Around the same time as Ste. Croix's demonstrations in London, Joseph Saxton, an accomplished machinist, made the earliest daguerreotype in Philadelphia from a second storey window at the U.S. Mint. This episode is important because it demonstrates how at first, very sparse, working details of the

¹⁸⁷ "Foreign Correspondence." *The Athenaeum, Journal of English and Foreign Literature, Science and the Fine Arts*, no. 587 (January 26, 1839): 69.

¹⁸⁸ W. Chaffers, *Hall Marks on Gold and Silver Plate. To Which Is Now Added a History of L'orfèvrerie Française*. 1883: 281-2.

daguerreotype arrived in Philadelphia from France by way of the scientific community. Further dissemination of the process was linked to the materiality of the silver plate and technical know-how. Alexander D. Bache, the first to receive the notice, sought out Saxton who had coin silver readily at hand. Saxton then approached Robert Cornelius for pure silver plate a few weeks later. Sarah Kate Gillespie in *The Early American Daguerreotype* dates the Saxton image as taken “probably on October 16” based on reading Alexander D. Bache’s description of the process in the October issue of the *United States Gazette*. She then suggests that the question of priority for Saxton is less important than “Why Saxton at all?” Her answer is simply that technical curiosity motivated him to construct the apparatus and aim it a group of buildings from window of his laboratory.¹⁸⁹ Gillespie seems unaware of the related actors. First, Bache’s article was printed in the *Gazette* on September 26.¹⁹⁰ Second, he was President of the American Philosophical Society and close friends with Joseph Saxton who was also a member.¹⁹¹ Bache shared the limited process details with Saxton prior to publication so the date the image is certainly before September 26.¹⁹² Finally, Bache was also president of Central High School from 1839 to 1842, which was the subject of the daguerreotype so it may be just as likely that Bache crossed the street with the information just received from Paris to visit his friend, who had the mechanical skill and materials at hand (silver plate) to try the daguerreotype.

¹⁸⁹ Sarah K. Gillespie, *The Early American Daguerreotype: Cross-Currents in Art and Technology*. MIT Press, 2016: 144-5.

¹⁹⁰ Alexander Dallas Bache, "The Daguerreotype Explained." *United States Gazette*, September 25 1839. The article is reprinted as Appendix 4 in Robert Cornelius: *Portraits from the Dawn of Photography*: 139.

¹⁹¹ Arthur H. Frazier, *Joseph Saxton and His Contributions to the Medal Ruling and Photographic Arts*. Smithsonian Studies in History and Technology 32: Smithsonian Institution Press, 1975: 15.

¹⁹² William F. Stapp, Robert Cornelius, Marian S. Carson, M. Susan Barger, *Robert Cornelius: Portraits from the Dawn of Photography*. Washington, D.C.: Published for the National Portrait Gallery by the Smithsonian Institution Press, 1983: 41. In footnote 19, Stapp partially quotes Julius F. Sachse’s own footnote in “Early Daguerreotype Days”. The complete footnote reads. “An old member of the Philosophical Society who was active at the time claims that Saxton’s experiment was made a month previous (September, 1839) shortly after the letter to A. D. Bache, above quoted, and before it was published”

Julius F. Sachse believed that the article "The Daguerreotype Explained" published by Bache in the *United States Gazette* on September 26, did not contain sufficient information for Saxton to succeed.¹⁹³ A scientific friend of Bache's was in attendance during the August 19 public announcement and made notes. The description he passed on was very simple containing few details; wipe a plate with nitric acid, expose it to iodine until it turned yellow, expose the plate for a time in a camera, develop it with mercury and fix it with hypo-sulfite of soda.¹⁹⁴ Sachse speculated that these scant details were insufficient to produce an image and based on this reasoning the date of the Central High School daguerreotype has been estimated by Gillespie and others at mid-October *after* complete information from Daguerre's manual was available. Replication following the sparse details of Bache's letter, using coin silver and a simple lens, provides insight into the image quality Saxton would have achieved with these materials and methods.

I made daguerreotypes following these procedures to understand if one could be successfully produced according to the limited information in Bache's letter. According to Marcus Root, Saxton made a camera made from a cigar box and fitted it with a simple bi-convex lens.¹⁹⁵ Figure 16 shows nine experiments I made over the course of one afternoon. Most of the images were grossly overexposed with a 4-inch (60mm) diameter magnifying lens fitted to a replica cigar box. The best image, in the lower left corner of the series, looks remarkably similar to Saxton's view. The time for the exposure was surprisingly short for mid-February, requiring only three minutes with the lens restricted to a 33 mm aperture, or in modern terms, the equivalent of *f*/5.

¹⁹³ Julius F. Sachse, "Early Daguerreotype Days II." *American Journal of Photography* v. 13, no. 151 (July 1892): 306-8.

¹⁹⁴ Bache, "The Daguerreotype Explained." September 25, 1839.

¹⁹⁵ Marcus A. Root, *The Camera and the Pencil, or, the Heliographic Art: Its Theory and Practice in All Its Various Branches ... : Together with Its History in the United States and in Europe: Being at Once a Theoretical and a Practical Treatise, and Designed Alike, as a Text-Book and a Hand-Book: Illustrated with Fine Engravings on Steel and on Wood*. M.A. Root, 1864: 351. According to Tony Hyman of the online Cigar History Museum, an 1840 cigar box held 250 cigars and was roughly 5 x 5 x 7 inches. (From an email correspondence on February 12, 2013).



Figure 16. Dag Test 2-17-2013. Saxton re-enactment series compared to Saxton's first daguerreotype (inset). Saxton image courtesy of the Historical Society of Pennsylvania.

To determine purity of the silver Saxton used, I obtained a U.S. silver dime dated 1839 and placed it in a Joel model 6380LV Scanning Electron Microscope for X-ray analysis. The dime's metal was .920 silver and .080 copper by weight percent, similar to Sterling silver. DagTest 2-17-2013, using sterling silver, provides direct evidence that the limited information obtained from Bache was sufficient for a skilled craftsman to make a daguerreotype on coin silver from the mint and proves that an early dating of before September 26, 1839 is justified. The tones in the replica image as in the original by Saxton are quite weak due to impure silver.

Saxton then approached the firm Cornelius and Son, silver platers and brass lamp makers, to obtain pure silver plates for further experiments. Saxton introduced the daguerreotype to Cornelius who opened the first portrait studio in Philadelphia. By surveying his oeuvre between 1840 and 1842 one can clearly see rapid advances in plate preparation (and sensitizing, lighting, and optics).

Cornelius earned a reputation for exceptional image quality. A reviewer pronounced his specimens “unsurpassable...the best that have yet been seen in this country” even better than Daguerre himself.¹⁹⁶ His daguerreotypes received acclaim beyond America as well. J. Egerton of London, in his preface to the translation of Lerebours’ treatise, remarked that in 1841, “the most beautiful specimens of the Daguerreotype then in existence, [were] produced by Mr. Cornelius, of Philadelphia”.¹⁹⁷

How he was able to achieve such a fine finish on his plates? Robert Cornelius and his father Christian were highly skilled metal-smiths. Christian opened shop in 1810 as a silver plater and by 1825 was making oil lamps. Robert joined the firm two years before the daguerreotype was introduced, and by this time lamp making was their primary enterprise.¹⁹⁸ They had long since purchased their plated metal from Scovill Manufacturing Co. in Waterbury Connecticut. When J. M. Lamson Scovill paid a visit during the week of October 21, 1839, Robert Cornelius placed an order for “one pc. Rich Plate for the daguerreotype business” to work into daguerreotype plates. Scovill forwarded the order to his brother at the factory informing him that iodine did not perform well on coin silver due to the copper alloy.¹⁹⁹ The connection between the Scovill and Cornelius is important. As explained later in this chapter, Scovill provided the silver clad stock in rough condition for the daguerreotype process due to their metal rolling methods at that time, and Cornelius had pre-requisite skills to rework the metal to a smooth and polished surface.

¹⁹⁶ *Godey's Lady's Magazine* 20 (April 1840): 190.

¹⁹⁷ N. P. Lerebours, *A Treatise on Photography; Containing the Latest Discoveries and Improvements Appertaining to the Daguerreotype*. By N. P. Lerebours. Translated by J. Egerton. London: Longman, Brown, Green, and Longmans, 1843: ii.

¹⁹⁸ *Desilver's Philadelphia Directory and Stranger's Guide*, 1828-1835, continued as *McElroy's Philadelphia City Directory*, 1837-67. <https://archive.org/search.php?query=Philadelphia+city+directory> (Date accessed, 17 March 2017)

¹⁹⁹ Dr. Philip W. Bishop, "Scovill and Photography." *The New Daguerreian Journal: Devoted to the Daguerreian and Photogenic Art Also embracing the Sciences, Arts, and Literature* 3, no. 2 (January 1975): 7. Cornelius relayed Saxton's experiments with coin silver to Scovill... "they have been trying it at the mint but do not make it go well as they wish on account of the Silver".

The question of silver purity was raised again in the early 1980s. Fifteen of Cornelius' daguerreotypes were analyzed with a model ISI DS 130 scanning electron microscope using energy dispersive x-ray analysis, as research for the chapter *Robert Cornelius and the Science of Daguerreotype*, contributed by M. Susan Barger. Their analysis determined thirteen of the fifteen Cornelius plates were a silver copper alloy of "less than ten percent".²⁰⁰ The other two plates, produced after 1843 and stamped with the hallmark "40 L.B.B. & Co.", had a pure silver surface.²⁰¹

Barger, surprised by the analysis, realized that finding impure silver alloy "contradicts the traditional assumptions about daguerreotype plates".²⁰² She correlated Cornelius' exceptional image quality with the use of alloyed silver, explaining that copper when added to silver in small quantities improved its mechanical strength. This harder surface then facilitated an exquisite polish. Barger previously surmised that copper, as an impurity, served as a photographic sensitizer, however for the Cornelius chapter she noted that "...the use of silver-copper alloy for plating should have no real effect, either positive or negative, on image production".²⁰³ I have shown with experiments using alloyed silver that copper has a significant negative affect in image quality. How is it that my actual experiments do not conform to Susan Barger's theories?

The reason is that X-ray microanalysis is affected by the voltage setting of the scanning electron microscope; the penetration depth of the electron beam increases with increasing accelerating voltage. For example, at 10kV, the electron

²⁰⁰ Barger, "Robert Cornelius and the Science of Daguerreotypy." 119.

²⁰¹ John S. Craig, *Craig's Daguerreian Registry*. 2nd Revised ed. Vol. I, Torrington, CT. 2003. L.B.B. and Co. refers to Louis B. Binsse, a daguerreian and daguerreotype stock dealer listed in New York business directories between 1843 and 1845.

²⁰² Barger, "Robert Cornelius and the Science of Daguerreotypy." 127.

²⁰³ Barger, 126. See also M. Susan Barger, "The Daguerreotype: Image Structure, Optical Properties, and a Scientific Interpretation of Daguerreotypy." PhD Dissertation, The Pennsylvania State University, 1982: 210. In her PhD dissertation Barger inserts Table 7 "Nineteenth Century Observations and Modern Views." Under the Observation heading she writes. "The copper of the daguerreotype plate contributes to the photographic effect". For this observation, she checked the column headed Affects Photographic Speed. Under the Reason For Observation heading she stated, "Copper, as an impurity in the silver, may act as a photographic sensitizer."

beam will penetrate silver to a depth of approximately 0.4 microns, and when 20kV is used, the beam penetrates roughly three times deeper to 1.4 microns. The equation to calculate the penetration depth in microns is:

$$d_p(\mu m) = \frac{0.0276W_\alpha E_0^{1.67}}{Z^{0.89}\rho}$$

W is the atomic weight (g/mole), E is the energy (kV), Z is the atomic number of the element sampled, and ρ is the density (g/cm³).

The EDX analysis for Barger's research was performed at voltage setting of 20kV.²⁰⁴ At this power the sensor may have picked up X-rays from the copper substrate. In 2013, I examined two Cornelius daguerreotypes from a private collection in a scanning electron microscope. The plates were analyzed at 10kV, 15kV, and 20kV with point and area scans in highlight and shadow regions. The analysis indicated pure silver at 10 kV power. Trace copper (~2.4%) was found in area scans of the shadow regions at 20 kV. As this figure is below the margin of error, the plates are made with pure silver, not an alloy as Barger reported.

²⁰⁴ According to Barger's research files, The EDX spectra were taken from a Kevex Energy Dispersive X-Ray spectrometer model 7077.

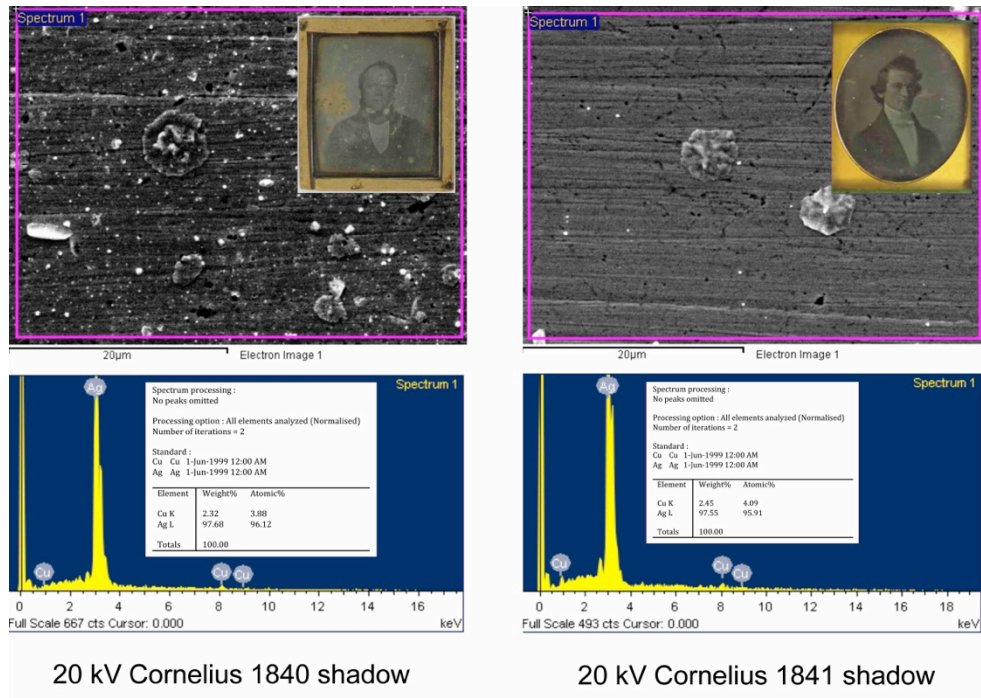

Figure 17. 1840 shadow region (left), 1841 shadow region (right).

Cornelius' superior specimens were not due to silver alloy, but his skill in polishing using techniques acquired from the lamp making trade. The metal finishing process used in the lamp factory for silver and brass lamp parts is found in a description of the establishment:

The tools used here...are formed of highly polished steel or a very hard material called bloodstone. The prominent parts of the work are highly polished by means of these burnishing tools, which are dipped freely into a dark-colored liquid...the mysterious chemical is nothing more than small beer!²⁰⁵

Burnishing differs from polishing in that the metal is rubbed to a high shine using a well-lubricated hardened steel or polished stone, whereas polishing uses increasingly finer abrasives to wear away rough metal. Cornelius first burnished the silver, and then polished it with a secret mix of fine powders. The recipe for his

²⁰⁵ *Description of the Establishment of Cornelius and Baker, Manufacturers of Lamps, Chandeliers and Gas Fixtures*, Philadelphia. Chandler, 1860: 16.

plate polish was seven parts graphite mixed with one part rouge.²⁰⁶ I have examined seventeen of Cornelius' daguerreotypes and every example, except his first self-portrait made on a solid silver plate, have a distinct surface indicating that he burnished the metal to smooth and brighten it before polishing. I have not seen these unique metal finishing artefacts on any other daguerreotypes, either from the 1840 to 1842 period or later. These burnishing tool marks, (and other plate surface details), are only apparent under half-shadow illumination, which is the intersection between dark field reflection in which the image appears positive, and light field reflection when the image appears negative. In order to view surface artefacts on a daguerreotype plate the viewing angle must be rotated by the observer to allow the transition region of half-shadow illumination to move across the surface. Figure 18 illustrates Cornelius' handiwork with the burnishing tool.

His self-portrait is not burnished because it was made with a solid silver plate having ample metal to withstand polishing. Clad plates, on the other hand, have a thin silver layer that is easily worn through by excessive polish. In 1840, American-made clad plate was very rough, with pores and pits throughout the surface that remained after polishing. To reduce these defects Cornelius annealed and re-rolled the two-foot lengths of plate he purchased from Scovill, then cut them into sixth-plate size and burnished their surface before finishing them with his special graphite and rouge polishing powders.

²⁰⁶ Charles Leroy Moore, *Two Partners in Boston: The Careers and Daguerreian Artistry of Albert Southworth and Josiah Hawes*. (Volumes I and II). 1975: 188-9. Moore quotes in full a letter from Joseph Pennell to his former partner Albert Southworth, written in 1845. Pennell left to work for Scovill. He wrote, "The polishing powder is a secret which he [Mr. Scovill] says he got from Cornelius...It is rouge mixed with black lead...pulverize it and mix it with 1/7 as much rouge and grind them together well...Please do not let Scovill know I tell you of this..." For more on Southworth & Hawes, see *Young America: The Daguerreotypes of Southworth and Hawes*. International Center of Photography, 2005.

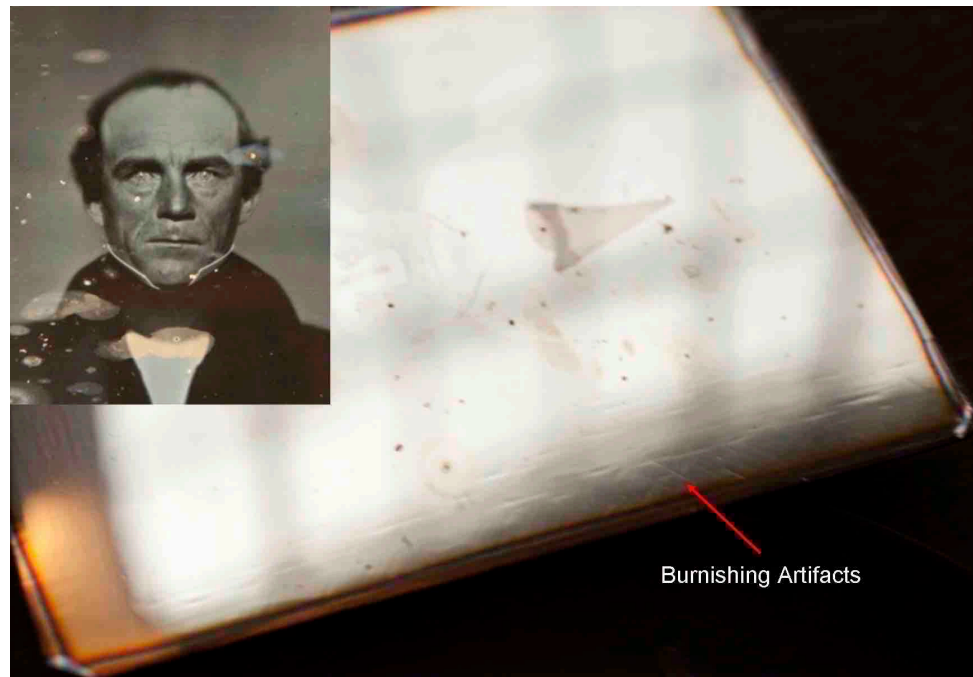

Figure 18. 1840 Robert Cornelius daguerreotype. Arrow indicates burnishing tool marks.

Cornelius' early plates are roughly 30% thinner than the 25 gage (~0.020 inch) material supplied by Scovill, indicating that he spent considerable effort to thin out the metal to improve its surface.²⁰⁷

As stated, Cornelius' exceptional image quality is due to his ability to prepare the pure silver surface, not due to copper impurities as assumed by Barger. This section clearly illustrates the importance of understanding the instrumentation used when analyzing historic objects to determine their chemical makeup. The accelerating voltage set on the SEM was too high for Barger to accurately analyze the silver composition of Cornelius' plates in 1983. Replication experiments here prove that the use of alloyed silver is detrimental, not beneficial to image quality, as Barger claimed being misled by erroneous data. They have also shown that it

²⁰⁷ Bishop, "Scovill and Photography.": 8. Scovill advised the factory to roll the metal down no thinner than easy 25, which is roughly 0.020 inches thick. If the clad metal was produced at 30 parts copper to 1 part silver, as was the standard, the silver thickness would be roughly 17 microns thick as delivered to Cornelius. With re-rolling, burnishing, and polishing, the silver thickness may have been less than half that. This may account for the copper alloy Barger found in analyzing these plates as the electron beam operating at high voltage (20kV) could penetrate beyond the silver thickness to excite X-rays from the copper substrate.

would have been possible for Saxton to make his view of Central High School with the scant information contained in Bache's letter. This refutes Sachse and re-establishes a September 1839 date for this image. Once Saxton was aware that pure silver was required, he turned to Robert Cornelius for help.

Early American and English-made rolled plates had a rougher surface, more marked with pores, pits and impressions than plates imported from France. The French platers had developed manufacturing techniques to produce a silver surface that was rarely equalled by foreign competitors. These unique platemaking techniques were adapted to meet Daguerre's demands as explained in the next section.

3.4 The Silver Plate: Platemaking Technology

French plates were smoother and required less effort to polish than American and English rolled plates. This section will make explicit why this is so and illustrate how French-made plates can be identified. The smoothness was imparted by a finishing step not used in America or England known as hammering or planishing but this was not used for daguerreotype plates until 1838. Prior to this, Daguerre worked with imperfectly plated silver. During the mid-1830s he experimented with unpolished silver, trying to simultaneously fix his mercury developed images and improve their contrast by etching the shadows with acid to fill them with black pigment. He abandoned this approach due to the fragile image amalgam and turned his attention to improving the polish of the plates to better reflect darkness.²⁰⁸ Due to the surface of the plates at this time being rough and full of pores from the rolling process, he could not achieve a perfectly uniform polish.

In 1838 Daguerre paid a visit to the leading metalworking factory in Paris, managed by M. Gandois, to inquire if beating the metal with hammers could eliminate the defects in silver plate. Receiving a negative reply from Gandois, Daguerre quickly insisted on speaking with their polisher. August Brassart, the young silversmith, recalled the moment the two men approached his workbench. Daguerre asked:

“Can you make plates perfectly smooth and free from pores?” When the question was put my employer stepped behind the famous inventor and motioned to me to reply in the negative. I paid no heed to Gandois’ advice and answered: “I am confident sir, I can do it”.²⁰⁹

²⁰⁸ Louis Jacques Mandé Daguerre, "Des procédés photogéniques considérés comme moyens de gravure. — Lettre De M. Daguerre À M. Arago". *Compte rendus hebdomadaires des séances de l'Académie des sciences*, no. Séance du Lundi 30 Septembre (1839): 423-7. Daguerre wrote to Arago about the possibility of engraving daguerreotypes. His letter reveals key information of his progress of discovery. Daguerre’s letter was partially translated in *The Athenæum*, No. 624, October 1839. For more detail, see the chapter on latent image development.

²⁰⁹ "A. Brassart of St. Louis Perfected the Process Which Made Daguerre Famous." *St. Louis Post-Dispatch*, August 21 1898: 23. In this interview, Brassart specifically mentions that Daguerre used rolled plates and requested planishing as a remedy to smooth out the defects. The story

Brassart had no idea of why Daguerre wanted the plates, but took up the challenge that his co-workers thought impossible. After five or six weeks he had results. "On this plate", Brassart recalled, "the first flawless sunlight picture was taken".²¹⁰

Marc-Antoine Gaudin one of the first to attempt the daguerreotype in Paris described the complete French system of plate fabrication in detail.²¹¹ The plate making process, according to Gaudin, begins with an approximately three by five by four-tenths of an inch thick rectangular block of copper. Soldered to this is a thin sheet of pure silver ranging from one-twentieth to one-fortieth as thick as the copper. The fused metals were then passed back and forth between rollers by two workmen, significantly elongating and thinning the workpiece. As the material was reduced in thickness it reached a degree of hardness that prevented further reduction. To continue, the metal had to be annealed.²¹² The material would be taken through several cycles of rolling and annealing to render thirty-two, six by eight by one-twentieth inch plates, otherwise known as full or whole-plates from the original block. The rolling mill imparts a curvature to the plate and roughness to the silver surface. After the final pass through the mill rollers the plates were annealed again and cut to size. Gaudin explained the final manufacturing process, an essential operation to equalize, smooth and slightly re-harden the surface:

appears in "The First Man to Make Daguerreotype Plates." *Photographic Times and American Photographer*, no. v. 19 (1889): 73-4. In this article, written nine years prior to the above, details of his polishing method using hammers are omitted. Charles van Ravenswaay, directory of the Missouri Historical Society, recounted the story in 1954, based on the above articles and correspondence with Brassart's grandson, Charles A. Dostal. Van Ravenswaay's research on the subject is held in the August Brassart Collection, Missouri History Museum Archives, St. Louis.

²¹⁰ Charles van Ravenswaay, "August P. Brassart, an Associate of Daguerre." *Image: Journal of Photography of the George Eastman House* 3, no. 3 (March, 1954): 18. August Brassart left Gandois' employ for military service in the early 1839 or 40 and returned to daguerreotype platemaking around 1845. Plates have been found with "Brassart" hallmark indicating a post-1845 date. In 1856, Brassart was hired by Henry Hayden to produce daguerreotype plates in America for the Holmes, Booth and Haydens Company. The enterprise was short-lived as the daguerreotype process was superseded.

²¹¹ Gaudin made his first trials on August 20, 1839, the day following the public announcement. Gaudin was partners with Lerebours, the optician. Though he wasn't present for the public announcement, he had access to the manual and the means to hastily construct the apparatus.

²¹² To soften the silver-copper plate, the annealing process involves heating the metals to a visible red glow and allowing them to cool. The temperature required to anneal the silver copper bond is between 700~800°C.

The planishing is performed with the hammer, blow by blow; much skill and care is necessary on the part of the workmen to practice it in a satisfactory manner.²¹³

Planishing, unique to French-made plates, was part of the platemaking process from the beginning until the end of the commercial daguerreian era and the artefacts of the hammer are a good indication of the country of origin. Once polished, hammer marks on daguerreotypes made with French plates are not visible under normal viewing conditions. Figure 19 shows three examples of planishing marks. Boston dentist Samuel Bemis made the left image in the spring of 1840. He purchased a complete daguerreian outfit from François Gouraud including a dozen French whole-plates at two dollars apiece.²¹⁴ When a point source light is allowed to reflect off the plate against a wall, the planishing can be seen in overlapping circles of brightness. This effect is similar to a Chinese magic mirror, an ancient novelty, where a design is stamped into the surface of a metal disc and then ground and polished to the depth of the design. The metal surface with no visible design still reflects a bright image of the impression on a smooth wall.²¹⁵ The reflected image is due the hardness differential of the metal surface. The middle image in figure 19 is a French-made half-plate of U.S. politician Edwin Stanton and his son, circa 1853. Normally invisible, I noticed the planishing marks when the plate was submerged in water while undergoing conservation at my studio. The right image in figure 19 is an unpolished nineteenth century plate with the hammer marks plainly visible under half-shadow illumination.

²¹³ Marc A. Gaudin, "A General View of the Daguerreotype." *The Photographic and Fine Art Journal* 5, no. 1 (January 1853): 5-12.

²¹⁴ A full-plate daguerreotype by Samuel Bemis, *King's Chapel Burial Ground*, in the collection of the George Eastman Museum (GEM accession number 80:0788:001), bears the hallmark 30, indicating a silver to copper ratio of 1:30. On close inspection, artefacts of the planishing hammer confirm that this is an early (ca. 1840) plate of French manufacture. Bemis, a Boston dentist purchased a complete outfit including plates from François Gouraud on April 15, 1840. The bill of sale resides in the collection of GEM.

²¹⁵ I had first-hand experience with this phenomenon at a Daguerreian Society Symposium in 2001 when David Burder demonstrated the reflection of a line figure of a monk from the surface of a Chinese magic mirror. I was further amazed when he showed that an electro-formed copy from the mirror did the same.



Figure 19. Planishing hammer marks visible by reflection (left), under water (centre) and half shadow-illumination right). 1840 plate on the left, others date to ca. 1853.

French plates are easily identified when removed from their protective case or housing to reveal the hallmark stamp in the corner of the plate.²¹⁶ Strict regulations for gold and silver plate required a maker's mark symbol with their name initials, the word *doublé* or *plaqué*, and a numeric stamp to indicate the portion of silver on the plate.²¹⁷ A plate marked with numeral 20 had fifty percent thicker silver than one marked 30, and twice as much a number 40 plate. Thicker 20 marked plates were more expensive, but offered an advantage to one learning the process because the plates could be re-polished several times. The more commonly sold 40 plates could barely be reused a third time, particularly if gilded, due to the thin silver layer.²¹⁸

On March 7th, 1839 in Paris, Samuel Finley Breese Morse met Daguerre and saw his plates. He began experimenting with the daguerreotype upon his return to the United States as soon as the working details were available in September.²¹⁹

²¹⁶ I do not recommend dismantling images to ascertain the hallmark due the fragility of the plate surface, but if the plate requires removal for conservation, the hallmark should be noted.

²¹⁷ W. Chaffers, *Hall Marks on Gold and Silver Plate. To Which Is Now Added a History of L'orfèvrerie Française*. 1883: 288. The Act of the nineteenth Brumaire, An VI, Titre V11 - Of the Fabrication of Plated Goods an Gilding and Silvering Metals. Articles 95 to 97 (edited) state. - Whoever desires to plate on copper may employ silver in any proportion he desires. He is bound to place upon each of his works his own punch. He shall add to the stamp numerals indicating the quantity silver contained in the work, on which shall also be impressed the full word DOUBLÉ.

²¹⁸ Dominick Marcocchia, materials testing technician at Clad Metal Specialities, measured a cross section of a used nineteenth century daguerreotype plate that I provided. The silver thickness averaged 0.00025 inches (6.35 microns). Polishing to remove a gilded image wears away roughly 1~2 microns of silver per attempt.

²¹⁹ Samuel Finley Breese Morse, "The Daguerrotipe." *New-York Observer*, April 20, 1839, 62. S.F.B. Morse wrote a letter dated March 9th to his brother Sidney, editor of the New York Observer

Once proficient, he sold lessons in the art, training students. (This reinforces the importance of the tutor-student transfer of daguerreian practical knowledge, like the Mayall-Pyle relationship noted in the introduction chapter.) Many of Morse's students became pre-eminent American daguerreian artists, such as Samuel Broadbent, Mathew Brady, Edward Anthony, Joseph Pennell and Albert Southworth.²²⁰

Textual sources regarding Morse's quest for silver plates reveal the American manufacturer's inability to economically produce a product equal to the imported French plates. Writing to Marcus Root in 1855, he recalled the difficulties with American plate quality during his early trials in the fall of 1839:

The greatest obstacle I had to encounter was in the quality of the plates. I obtained the common plated copper in coils at the hardware shops, which of course is very thinly coated with silver, and that impure.²²¹

Morse inquired at Scovill's New York office after pure silver clad copper plates in whole-plate size, hoping that American-made plates could be had at a better price than the French plates imported by Gouraud. With an estimated demand for 300 pounds of silver plate per week, (which represents about 750 full-plates, or 3000 quarter-plates) all the Scovill Company could produce by year's end was 18 full-plates from 41 pounds of metal, representing 80% waste. J. M. Lamson Scovill wrote to his brother at the factory. "The daguerreotype Metal sent turns out good for nothing...Butler, Professor Morse, and all hands are Chop Fallen about it..."²²² Morse, undeterred by Scovill's failure, turned to a local supplier for plates, on which

describing his visit to Daguerre's studio and the images he had seen. Extracts of the letter were published on April 20, 1839 and is the earliest published account of the process available to the American public. Morse had a studio at New York University and partnered with the chemistry professor, John Draper, to operate a daguerreotype studio on rooftop of the building in the spring of 1840.

²²⁰ C. Mabee, *The American Leonardo: A Life of Samuel F.B. Morse*. A.A. Knopf, 1943: 243. See also Grant B. Romer, "The Daguerreian Careers of A.S. Southworth and J.J. Hawes", *Young America*, Steidl 2005: 22.

²²¹ Samuel Finley Breese Morse, "Who Made the First Daguerreotype in This Country?". *The Photographic and Fine Art Journal* 8 (1855): 280.

²²² Dr. Philip W. Bishop, "Scovill and Photography." *The New Daguerreian Journal: Devoted to the Daguerreian and Photogenic Art Also embracing the Sciences, Arts, and Literature* 3, no. 2 (January 1839): 9. J. M. Lamson Scovill's letter is dated December 31, 1839.

one of his earliest successful images, a view of City Hall was made.²²³ Corduan, Perkins and Company at 28 and 30 Cherry Street, New York advertised the manufacture and sale of all sizes of plates beginning in early 1840 through 1841. Another early daguerreian who purchased Corduan plates was Hugh Lee Pattinson, an English metallurgist who made the first views taken in Canada of Niagara Falls in April 1840.²²⁴ Pattinson had hoped to secure a number of saleable views but returned to England with far fewer than planned.²²⁵ Pattinson relayed his difficulties with the plates during a monthly meeting of the Literary and Philosophical Society at Newcastle on Tyne:

Mr. P. exhibited some drawings taken by himself, one of Ravensworth Castle, and two or three views of the Falls of Niagara, which were examined with considerable interest. As a proof of the incertitude attending the invention, we may state that Mr. Pattinson visited the Falls with the intention of bringing away sixty or seventy drawings, but found, on his arrival, that most of the plates were defective, owing to the silver not being pure, and he was obliged to return with a smaller number of drawings than he originally calculated upon.

Mr. Pattinson uses thin copperplates, coated with silver, and highly polished. The defective plates were purchased in New York.²²⁶

The surface quality of the Corduan, Perkins and Company plates was no better than Scovill's. During the rolling process, the slightest debris, dust or metal particle

²²³ Sarah K. Gillespie, "Samuel F. B. Morse and the Daguerreotype: Art and Science in American Culture, 1835--1855." 3232008, City University of New York, 2006: 106. Gillespie quotes a notice from *The [New York] Evening Post*, February 18, 1840, p2 which states, "The plate on which the drawing was taken was manufactured by Corduan, Perkins & Co., No. 28 Cherry Street." Morse had recently had a falling out with François Gouraud, then the only source for French daguerreotype plates in New York.

²²⁴ Graham W. Garrett, "Canada's First Daguerreian Image." *History of Photography* 20, no. 2 June 1 (1996): 101-03.

²²⁵ Ten of Pattinson's daguerreotypes were donated to the Robinson Library, University of Newcastle upon Tyne, Newcastle by his great-granddaughter in 1926. They were rediscovered in 1997, and an Internet inquiry led to Roger Watson, who recognized their significance. The views of Niagara Falls are stamped "Corduan Perkins & Co." His view Niagara was reproduced as an engraving in *Excursion Daguerriennes*. See N.P. Lerebours, "Amérique Du Nord: Niagara." In *Excursions Daguerriennes. Vues Et Monuments Les Plus Remarquables Du Globe*. Paris, 1842. Vol. 1.

²²⁶ "Daguerreotypes - Mr. Pattinson's Address to the Literary and Philosophical Society." *Newcastle Chronicle*, December 5, 1840. Reprinted on the Internet site for Newcastle University Library. <http://www.ncl.ac.uk/library/special-collections/collections/daguerreotypes/litandphil> (Date accessed, 11 May 2016)

would leave an impression in the surface, or worse, become embedded or perforate the thin silver layer. An early 1842 guide explains the difficulty:

Daguerreotype plates are either of American or French manufacture. French plate is preferred to the American on account of its possessing a smoother surface; American Plate is very imperfect, the silver abounds with perforations which appear like black dots in the designs.²²⁷

An effective way to identify an early American or English rolled but not hammered plate is to look at the surface in half-shadow illumination to see the imperfections. Figure 20 is a portrait of a man taken on a Corduan plate from 1840 or 1841 and defects from the rolling process abound.

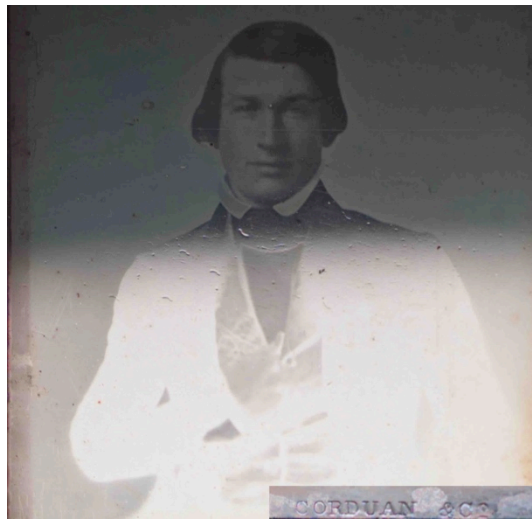

Figure 20. Surface defects on a Corduan & Co. plate visible in half-shadow illumination. National Gallery of Canada collection, LFA 21500_186_83.

French platers had worked out a method to protect the delicate silver surface during the final rolling steps and prevent debris from being impressed into the plate. The secret was revealed in New York by a gentleman who described to J. Chamberlin, Scovill's New York agent, that he had seen the plating work in Paris

²²⁷ Gilman and Mower, *The Photographer's Guide: In Which the Daguerrean Art Is Familiarly Explained*. Lowell, MA: Samuel O. Dearborn. Printer, 1842): 6. (Facsimile reproduction edition of 50, gift from Gary Ewer).

and that "it is rolled in the usual way up to the last time through the Rolls, when it is put through double, the two silver sides put together".²²⁸

The actors involved with early daguerreotype experiments in New York were interconnected and shared knowledge about plate preparation. Samuel F. B. Morse, the artist and inventor, recorded in a notebook his experiments and lessons with François Gouraud from January 14 through 18, 1840. These handwritten pages indicate that Dr. James R. Chilton a chemist, David W. Seager an economist, and Professor John W. Draper M.D. were in attendance for some the lessons.²²⁹ Alexander S. Wolcott, a dentist, and John Johnson, a mechanic, who were associated with Draper and Morse, did not attend.²³⁰ They were preparing to open a portrait studio in the Granite Building at the corner of Broadway and Chambers. Wolcott and Johnson made early trials with Corduan and Scovill's plates but found they had to finish the plates by hand rolling them face down against a highly polished steel die and annealing them several times.²³¹ In October 1840, William S. Johnson, Alexander's father, travelled to London to patent their reflecting camera and he formed a partnership with Richard Beard. Johnson Sr. also supervised the production of plated metal for their enterprise and shared the French secret of rolling plates face to face. Richard Beard felt that this improvement was important enough to include as part of the patent specifications for the reflecting camera:

2nd. A mode of preparing silver surfaces by pressing them face to face between hardened rollers, when they are to receive "images." Two plates of copper coated with silver are cleaned with cotton and dilute sulphuric acid; their silver surfaces are then placed in contact, and they are passed

²²⁸ Bishop, "Scovill and Photography." *The New Daguerreian Journal*: 3, no. 2 (Jan. 1845): 9.

²²⁹ Samuel Finley Breese Morse, "Memoranda of Daguerreotype." In *Samuel Finley Breese Morse papers, 1793-1844*: Library of Congress, 1840. Seager made the first daguerreotype taken in New York in September 16, 1840 and exhibited the image at Chilton's store, 263 Broadway. Morse did the same with his early successful images.

²³⁰ Before forming a brief partnership with Dr. John Draper in a glass studio on the roof on New York University where both men taught, Morse had proposed and offer of partnership with Wolcott which was declined. A. S. Wolcott however built the mercury bath Draper used in 1840. The bath, now in the collection of the Smithsonian Institution bears a label that reads, "Mercury box of 1840. Made by Wolcott (sic) for Prof. J. W. Draper M. D. of the University of New York".

²³¹ John Johnson, "Daguerreotype." *The Daguerreian Journal*. Vol. 2 (1851): 77.

between a pair of smooth hardened rollers; they are then annealed by heat, permitted to cool, and the whole process repeated until the silver surfaces are highly polished and equal in appearance all over.²³²

Beard's patent is the result of a transatlantic rebound of platemaking technology. Rolling the silver face to face was witnessed in Paris, retold in New York to be shared amongst the above named actors, and exported to London where a patent for the method was registered. Alexander Wolcott joined his partner John Johnson in Beard's enterprise and oversaw the manufacture of cameras, plates and other articles required by the patentee studios at manufactory maintained on Wharf Road.²³³

The appearance of the plate can indicate when and perhaps where it was made due to artefacts, which can be seen under the specific conditions, demonstrated here. These artefacts do not affect imaging quality in terms of speed and contrast per se, as a fine image can be made on a deplorable surface if the polish is fine and the silver is clean, however the presence of them may serve to place the image at a point along the evolutionary timeline of the process to coincide with other variables that do affect imaging characteristics such as sensitizing or optics. For example, the daguerreotype in figure 20 of the young man is full of surface defects typical of the first years of American plate manufacture, yet the image is reasonably well seen under normal viewing conditions. The camera used to make it predates 1842 as well, as illustrated in the optics chapter section titled First Portraits (See Fig. 71, p 266).

Polishing the silver before sensitizing, even with surfaces smoothed by the planishing hammer or rolled to a high lustre, was the most laborious aspect of making a daguerreotype. The surface of the plate not only had to be highly reflective to achieve the greatest contrast in the dark tones, but uniform and

²³² *Patents for Inventions: Abridgements of Specifications Relating to Photography*. Part 1. George E. Eyre and William Spottiswoode ed., Great Britain Patent Office, 1861: 3-4. Patent No. 8546, June 13, 1840.

²³³ Steve Edwards, "'Beard Patentee': Daguerreotype Property and Authorship." *Oxford Art Journal* 36, no. 3 (2013): 387.

meticulously clean to combine with the sensitizing halogens for maximum sensitivity and image tone. The next section discusses the advances in materials and methods, both manual and mechanical that were developed to achieve a perfectly polished uniform surface.

3.5 The Silver Plate: Polishing

The daguerreotype plate must be polished and buffed to an exquisite shine for two distinctly different reasons in terms of image quality. First, the reflectance of the plate is determined by the surface smoothness and the greater the reflectance, the greater the contrast due to deeper black and dark values in the final image. The other necessity of polishing and buffing, rarely discussed, is the creation of a chemically pure and clean surface on which to form the light sensitive silver halides. Plates contaminated with polishing residues, oils or moisture will at best deliver uneven tones, spots, and dark voids, and at worst no image at all as unclean surfaces impair photographic sensitivity.

Whether it be hammered, rolled or burnished, the surface of a new daguerreotype plate was unsuitable for immediate use.²³⁴ Polishing was necessary to remove the marks from the hammer or rolls. This was achieved by wearing down the surface using a fine abrasive such as pulverized pumice or rottenstone applied with cotton or velvet, and a lubricant such as olive or mineral oil, or alcohol and water. This tedious work, sometimes referred to as scouring the plate, left a circular semi-mat sheen on the surface. This was removed by buffing the plate with a long paddle covered with buckskin or velvet, sprinkled with dry powdered rouge, lampblack or both in combination. Traditionally, buffing was performed to leave fine linear scratches horizontally on the plate to ensure its finish was aligned parallel to the room lighting, as fine buffing lines and scratches are more visible when they are perpendicular to the light source.²³⁵ Some daguerreians, such as Southworth and Hawes, were so skilled at polishing and buffing their plates that the final buff is often invisible. These skills took years to

²³⁴ A profilometer measures the surface of a sample to quantify its roughness. It determines the deviation away from a median line in hills and valleys. The result, Rq or RM (root mean square) is expressed in microns. A new and unused nineteenth century French-made plate ranged in Rq from 1.2 - 1.7 microns. A well polished and ready to sensitize plate was measured to have an Rq of 0.6 microns.

²³⁵ Stereoscopic daguerreotype pairs made for viewing in a Brewster style stereoscope are often buffed vertically because the viewing light enters from the top of the device.

develop through the continual refinement of craft informed through practice. A. Bisbee of Dayton, Ohio, would agree:

When a person has learned to clean [and polish] a plate well, he may consider that he has learned at least one half of the art. But this is not to be learned in a week, or a month, and we might say a year, for it is careful experience that makes perfect. We have now been engaged in the business eleven years, and find that we are still improving by practice in this one thing.²³⁶

Bisbee explains that the art is learned through experience. Specifically, one learns to prepare a daguerreotype by critically observing the reflective surface during the polishing work then understands the effectiveness of the work by the image it yields. Replicative experiments using the materials and methods of polishing as they evolved is the most direct means to determine the qualitative reasons for the appearance of a daguerreotype.

I have briefly introduced the polishing methods as practiced during the height of the art, which differ significantly from those first published by Daguerre. As in other steps of the process, various polishing materials and methods impart a particular look to the plate and knowing when such improvements were introduced may help to date an image. Direct experience with the original method of polishing also gives insight into reasons for advances in this regard. Daguerre's labour intensive method divided the polishing and cleaning into separate steps. For polishing he recommended a wad of cotton, olive oil and finely pulverized pumice, followed by dry cotton and pumice. For cleaning, he used cotton and nitric acid diluted 1:16 with water. He heated the plate over an alcohol flame for five minutes to carbonize oil residue and followed up with three more cycles of dry pumice and dilute nitric acid. Daguerre, during a public demonstration executed the entire process from polishing to finished image in seventy-two minutes.²³⁷

²³⁶ A. Bisbee, *The History and Practice of Daguerreotyping*. New York: Arno Press, 1973 [c1853], 1853: 63-64.

²³⁷ William F. Stapp, Robert Cornelius, Marian S. Carson, M. Susan Barger, *Robert Cornelius: Portraits from the Dawn of Photography*. Washington, D.C.: Published for the National Portrait Gallery by the Smithsonian Institution Press, 1983: 140. Appendix 5 is a reprints an eyewitness'

The manipulations are clearly described in the historical text but the effectiveness and quality produced by them are better understood in practice. I followed the manual verbatim while demonstrating the process to my students and was able to accomplish the work in 85 minutes. Figure 21 shows the resulting tones of the image with this primitive technique. I had difficulty with excess acid beading up on the plate that caused spotting in the sky. The enlarged detail inset in the figure shows the result of “globules” of dilute acid on the plate that affected the uniformity of the tone, a problem Daguerre warned against noting that the acid must be spread sparingly and evenly. The inset in the upper right of Figure 21 is a detail of an unpolished plate with dilute nitric acid applied only to the left side. After exposing the sample to iodine vapour, the acidified side had more silver iodide than the plain side, which indicates that acid applied unevenly affects the sensitizing rate and image quality. Excess oils, moisture, nitric acid and poorly pulverized pumice led to a variety of failures such as spots, streaks, scratches and poorly formed images. Though the directions are clearly laid out in Daguerre's manual, multiple attempts, with slight alterations in material qualities and variations in handiwork were necessary to achieve success with the process. Observed effects provide clues to the reasons for failure and new trials are designed to improve the results. This process provides insight into difficulties experienced by historical actors.

account of Daguerre's public demonstration in September. The writer omits the three repetitions of nitric acid and dry cotton with pumice after heating the plate.

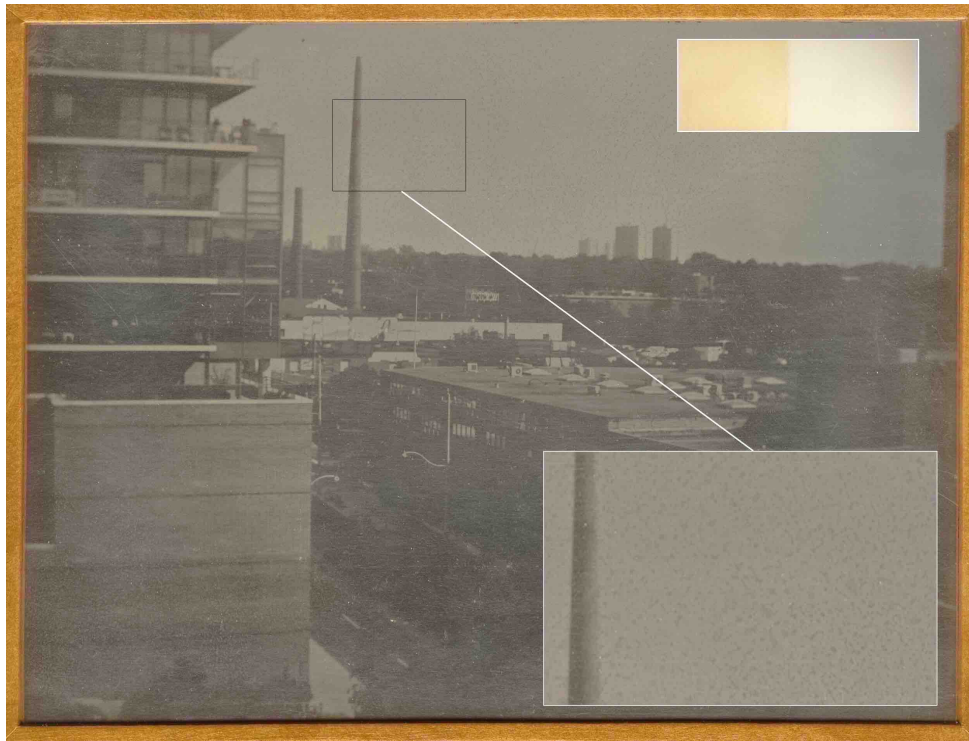

Figure 21. Dag Test 9-21-2015. Full-plate daguerreotype polished with pumice according to Daguerre's directions in his 1839 manual. Insets illustrate the difficulties with dilute nitric acid.

Morse recorded in his notebook that he and Gouraud had difficulties with spreading nitric acid during his lessons in January 1840 (similar to my experience with the process). While working solo in February, he had given up on nitric acid and tried a number of variations on polish, sometimes omitting the olive oil. He tried cotton velvet with a rubber pad and abrasives finer than pumice such as rottenstone (tripoli) and rouge (iron oxide). This notebook reveals his struggle with failure after failure, eventually leading to success as he noted on February 11.²³⁸

Unfortunately for Morse, François Gouraud had left for America without the knowledge of Daguerre's recent advances in polishing. Daguerre amended his system of polishing just after his manual was published. He wrote to Arago in October that he preferred calcined tripoli (rottenstone) over pumice because it

²³⁸ Samuel Finley Breese Morse, "Memoranda of Daguerreotype." In *Samuel Finley Breese Morse papers, 1793-1944*: Library of Congress, 1840. Throughout this notebook, Morse records "Dag." as a polishing substance. It was likely pre-packaged pumice that he obtained from François Gouraud. He tried this with oil, water and dry cotton.

produced a better polish in less time and furthermore required less acid.²³⁹

Daguerre's improved polish is evident in an image he made on October 2, 1839 as a demonstration for his colleagues at the Société libre des Beaux-arts, titled *Le Pavillon de Flore et le Pont-Royal*.²⁴⁰ The finish achieved by Daguerre on this plate has led Stephen Pinson to question the dating and authorship because of its image quality. "The condition of the daguerreotype is exceptional... and thus all the more remarkable if Daguerre in fact produced it only a few weeks after his earlier public demonstration".²⁴¹ The information that Daguerre provided to Arago for the preparation and use of tripoli suggests that he had worked with the substance for some time. Another important detail is the handwork he used in polishing. Daguerre's manual advised a circular motion, "always rounding and crossing the strokes, for it is impossible to obtain a true surface by any other motion of the hand" yet the *Le Pavillon de Flore* daguerreotype has a linear polish.²⁴² To understand the effects on image quality given by Daguerre's new improved polishing method relayed to Arago in October, I substituted rottenstone for pumice, omitted the nitric acid after heating, and switched to linear handwork. The contrast and image quality significantly improved as seen in figure 22. The plate is somewhat uneven in the sky due to slight moisture from my fingers that contaminated the cotton pledget, but the contrast and tonal range is far better than I obtained with a coarser abrasive (pumice) and circular polishing proving that *Le*

²³⁹ Louis Jacques Mandé Daguerre, "Physique appliquée: Lettre de M. Daguerre à M. Arago sur la substitution du tripoli à la ponce, pour le polissage des plaques destinées à recevoir les images du Daguerreotype." *Compte Rendus hebdomadaires des séances de l'Académie des sciences*, no. Séance du Lundi 21 Octobre (1839): 512-13.

²⁴⁰ Louis Jacques Mandé Daguerre, *Le Pavillon de Flore et le Pont-Royal*. Paris, Musée des Arts et Métiers, inv 8745-1, October 2, 1839.

²⁴¹ Stephen C. Pinson, *Speculating Daguerre: Art and Enterprise in the Work of L. J. M. Daguerre*. University of Chicago Press, 2012: 209-10. To make his point, Pinson suggests that this quite brilliant image be compared to a view *Palais Royal* cat. no 98 taken after 1842 that is in exceptional condition and supposedly gold toned, and a still life *Fossils and shells* cat. no 100. which is has more muted pewter-grey tones. I am also not sure why Pinson mentions that *Le Pavillon* was made only weeks after his earlier public demonstration. The one extant plate from September 14, the day of the third demonstration is all but invisible due to mishandling and tarnish. It is not reasonable to compare Daguerre's advancement based on this deteriorated image.

²⁴² Louis Jacques Mandé Daguerre and J.S. Memes, *History and Practice of Photogenic Drawing on the True Principles of the Daguerreotype*, Tr. By J.S. Memes. 1839: 57.

Pavilion de Flore et le Pont-Royal could have been produced by Daguerre on October 2, 1839.



Figure 22. Dag Test 5-14-2016. Daguerreotype polished with tripoli (rottenstone) according to Daguerre's improved method from October 1839. The plate was polished with linear strokes and no acid was applied after heating the plate.

Daguerre continued to address image defects due to excess acid and moisture, (evident in figures 21 and 22) as late as 1843. He reported an improvement recommending “nitric acid at five degrees for the first operation, and reduced to one degree for the latter”, and to heat the plate during iodizing.²⁴³ Diluting the acid by a further one-fifth and heating the plate would prevent globules of acid from marking the plate and the heat would mitigate the negative effects due to moisture

²⁴³ "Paris Letter." *The Literary Gazette and Journal of the Belles Lettres, Arts, Sciences, &c* (March 18, 1843 1843): 185-86. "Daguerre recommends nitric acid at five degrees for the first operation, and reduced to one degree for the latter". Daguerre relayed his improvements to Arago for publication in *Comptes rendus hebdomadaires des séances de l'Académie des sciences*, séance du Lundi 13 Mars 1843. The Paris correspondent condensed four pages of detailed text into one paragraph in his report for *The Literary Gazette*.

during sensitizing. Polishing methods steadily improved though over the first few years of the art and this can be clearly seen in the plates produced by Cornelius in Philadelphia.

Robert Cornelius, noted for his skill in metal finishing, used a circular polish during the first months of his commercial operation. Later he finished with a linear polish, which improved his image quality dramatically. Linear polishing with fine abrasives, such as rouge and lampblack, produce a smooth reflective surface, whereas a circular polish, particularly if done with coarse abrasives such as pumice, create a light scattering surface which appears *less black*. Figure 23 combines scans of modern plates polished with these two methods and examples of Cornelius's work from 1840 and 1842.



Figure 23. Modern plates polished circular with pumice (left). Linear polish with rouge (right). Overlay, Daguerreotypes by Robert Cornelius with circular polish (left), and linear polish (right).

Circular polish with coarser abrasives yields a lesser reflective surface than a reciprocating polish, which in turn diminishes the depth of the shadow values. This

is clearly seen in the images on the left side of figure 23 compared to the right side.²⁴⁴

The transition from circular to linear polish is also apparent in François Gouraud's work. Having left New York for Boston, Gouraud was still using circular handiwork for the final polish in mid-summer according to the manual he published under his own name.²⁴⁵ By September 1840 however, Gouraud was finishing his plates with a linear polish horizontally across the plate as can be seen in the only daguerreotype extant of his making.²⁴⁶ Circular polish using pumice, oil and a pledget of cotton in hand has a distinct appearance that is difficult to photograph but is easily seen when the plate is illuminated with a point source light. Daguerreotypes with such polish artefacts are most certainly from 1839 to mid-1840 unless made later by someone following the original published directions. Re-enactments and early daguerreotypes, particularly those by Cornelius, indicate rapidly evolving practices in the techniques and materials of plate polishing. After 1845, there were no improvements in abrasives beyond the preferred rottenstone for scouring and rouge and lampblack for buffing, though by the 1850s daguerreians tended to move away from troublesome olive oil for lubrication and preferred lighter mineral oils, turpentine, and alcohols with a small addition of ammonia.²⁴⁷ The work was tedious and daguerreians, naturally, sought mechanical devices to speed up the work.

²⁴⁴ Also clear is the change in lighting from direct axis illumination to side top lighting between the 1840 and 1842 image. Cornelius used axis lighting in his first studio with pre-Petzval optics and singly sensitized plates. Once he incorporated bromine and the new Petzval lens he no longer required such a powerful light and his second studio was illuminated with a skylight.

²⁴⁵ François Gouraud, *Description of the Daguerreotype Process, or a Summary of M. Gouraud's Public Lectures, According to the Principles of M. Daguerreotype. With a Description of a Provisory Method for Taking Human Portraits* Boston: Dutton and Wentworth's Print., 1840. Gary W. Ewer, ed., *The Daguerreotype: an Archive of Source Texts, Graphics, and Ephemera*, N8400001 http://www.daguerreotypearchive.org/texts/F8400001_GOURAUD_MANUAL_1840.pdf (Date accessed 15 May 2016)

²⁴⁶ François Gouraud, "Still Life of Plaster Casts." Museum of Fine Arts, Boston, September 7, 1840. Accession no, 1974.234. Bemis' views held in the George Eastman Museum in Rochester, NY have planishing artefacts, blisters and circular polish, Indicating that they are made on French plates and polished according to the instructions in Daguerre's manual.

²⁴⁷ Jean-Baptiste-Louis Gros, *Quelques notes sur la photographie: Sur plaques métalliques*. revised 2nd edition, July 1850 ed. Paris: Roret, 1850: 65-70.

The first American patent for a polishing machine was granted to John Johnson on December 14, 1841.²⁴⁸ It was the same system developed earlier in London, used by him at the Polytechnic on Regent Street and by Jabez Hogg at Richard Beard's second studio on Parliament Street. Hogg described its operation in *Photography Made Easy*.²⁴⁹ Johnson adapted the headstock of a treadle lathe and devised a holder to press the plate against the spinning polishing disc, slightly off axis, to impart a random orbital motion. The marks from the random orbital action were followed with linear buffing to remove them.

In total there were eight American patents for polishing machines issued between 1841 and 1858 (see Appendix C, p 414). Some were designed to mechanize a rotating motion and others converted rotary to reciprocating motion to impart a linear finish. In the early to mid-1840s the plates were usually adhered to a block of wood for the polishing process, whether by hand or machine. The preferred adhesive was red sealing wax, commonly used to seal stationery, though this occasionally would cause grief for the operator if the heat generated by polishing was sufficient to melt the wax and dislodge the plate. This sad occurrence would not only ruin the plate but also damage the delicate chamois or velvet buffing paddles. To eliminate this difficulty, daguerreotype practitioners invented a great variety of holding clamps and plate blocks to better secure the plate while polishing with no less than twelve patents granted in America between 1846 and 1855 for such devices (see Appendix C, p 386).

The plate often reveals evidence of the apparatus used in the polishing process, such as red wax residue on the verso or the bends and crimps a daguerreotypist adds to the edges of their plate to attach it to a particular holding

²⁴⁸ John Johnson, "Apparatus for Polishing the Plates Used in Taking Likenesses for Other Objects in Which Such Plates Are Required. Us Letters Patent 2,391, Dec. 14, 1841. <http://www.google.ca/patents/US2391> (Date accessed 13 Feb 2015) See Appendix C – p 415.

²⁴⁹ Jabez Hogg, *Photography Made Easy: A Practical Manual of Photography Containing Full and Plain Directions for the Economical Production of Really Good Daguerreotype Portraits, and Every Other Variety of Photographic Pictures According to the Latest Improvements*. . E. Mackenzie, 1845. Johnson's polishing lathe was still in favour in 1853. Hogg's fourth edition (1853) illustrates it on page 12.

device. These artefacts can serve in rare cases to identify the maker or productions from the same studio according to unique bends or crimps in the plate. For example, Southworth and Hawes' patent swinging arm polisher used a metal block with a clamping system for half-sized plates and larger. The clamp deformed the edges of the plate on two sides in the centre, as circled in figure 24.



Figure 24. US Patent 4,573 dated June 13, 1846 (left). Verso and recto of the half-plate polishing block (centre). National Gallery of Canada collection, LFA 21500_601_5. Southworth and Hawes half-plate daguerreotype of three women. The plate has deformed edges due to the clamping system (right). Collection Michael Mattis and Judith Hochberg.

The structure and design of a piece of apparatus can lend a visual signature to the image in other ways. I have described that very early plates have a visible circular polish and that daguerreians modified their methods to give a linear polish that did much to improve the reflectance of the plate. The machine designed by William and William Henry Lewis (US Patent 8,235 dated July 22, 1851 – see Appendix C p 421) had a large shallow cone nearly three feet in diameter covered with deerskin. With the plate pressed against the cone near its circumference the polish would be linear as desired, except the buffing lines would have a slightly curved but uniform shape. An image made in the mid 1850s by French daguerreian E. Vaillat has an exquisite finish with precisely this type of buffing

artefact.²⁵⁰ This proves that polishing machinery was used in some studios undoubtedly to ease the work and serve more clients.

Some daguerreians, seeking the ultimate in surface finish and uniformity, added an additional thin layer of silver to the polished plate by electro-chemistry. This process was described as galvanizing in the nineteenth century and sometimes referred to as re-silvering today. Essentially this is electro-plated silver, however, the next section explains why the galvanic process is vastly different than modern silver-plating methods.

²⁵⁰ The plate is in the author's collection.

3.6 The Silver Plate: Galvanizing

The nineteenth century method of silver plating, known as galvanizing, improved the surface of polished plates and is vastly different than modern plating methods due to the different silver hardness and grain structure that each method produces. These material differences influence the imaging qualities of the plate in terms of speed and tone. M. Susan Barger, intending to avoid confusion with zinc dipped steel, also known as galvanized metal, elected to use the term *American Process* to refer to re-silvered, or galvanized daguerreotype plates.²⁵¹ In designating galvanized plates as American process, she perpetuates the confusion about the origin of this technique for preparing daguerreotype plates, initiated by Beaumont Newhall when he wrote, “Warren Thompson of Philadelphia introduced galvanizing to France as a part of “le procédé américain...”²⁵² Warren Thompson, originally from Philadelphia, moved to Paris to open a daguerreian studio. He charged 500 Francs for lessons on the American method which infuriated Edmund Valicourt, because he believed that Thompson had appropriated improvements in polishing and sensitizing developed in England and France by Claudet, Bingham, and Laborde.²⁵³ A complete description of the American Daguerreotype Process, appended to *Plain Directions; Practical Hints on the Daguerreotype*, did not include

²⁵¹ M. Susan Barger and William B. White, *The Daguerreotype: Nineteenth-Century Technology and Modern Science*. 2nd ed. Baltimore: John Hopkins University Press, 2000: 44-5.

²⁵² Beaumont Newhall, *The Daguerreotype in America*. 3rd revised ed. New York: Dover Publications [etc.]; London: Constable, 1976: 120. The earliest reference to the American Process comes from Charles Wheatstone in a letter to William Henry Fox Talbot, dated Feb. 24, 1841. He wrote “I have recently seen some miniature portraits taken by the American process which are absolutely perfect, ...” A footnote to the letter reads. “The electroplating of commercial daguerreotype plates with a thin coating of silver is here mentioned by the name attributed to Warren Thompson, a daguerreotypist practising in the United States at the time. It is also known as galvanizing.” This interpretation for a letter of this early date is incorrect. Wheatstone is actually referring to the Wolcott and Johnson reflecting camera invented in America and recently introduced in London. See The Correspondence of William Henry Fox Talbot, Document 4198. <http://foxtalbot.dmu.ac.uk/letters/transcriptDocnum.php?docnum=4198> (Date accessed 18 March 2017)

²⁵³ Edmund de Valicourt, *Nouveau manuel complet de photographie sur métal, sur papier et sur verre*. Roret, 1851: 40. This manual was translated into English by W. Grigg and published serially in the *Photographic and Fine Art Journal*, Vol. 7 1854. Valicourt listed three parts to the American process, that of using leather for buffs introduced by Claudet, bromide of lime quick developed by Bingham, and the second iodizing step first announced by Laborde.

galvanizing.²⁵⁴ While galvanizing was not part of the American process Thompson was promoting, it came to be thought of as an American advancement due to an 1851 advertisement in *La Lumière*. Thompson wrote in support of the new Christofle et Cie electroplated plates:

It is well recognized by almost all experienced daguerreotypers, that silver deposited by the electroplating process is much more favourable for the daguerreotype, whites are much less prone to show [solarization], and blacks, more transparent and more perfect in their details. Almost all the leading operators in America for the past five years have galvanized their own plates...²⁵⁵

It is critical to understand that galvanizing refers to the daguerreian adding silver by electro-deposition to existing silver clad polished plates. They did not galvanize directly onto copper. Valicourt noted that the galvanizing process was tried with limited success by French daguerreians; Belfield in 1842, Gaudin in 1844, and Rochas in 1847 who advised re-silvering daguerreotype plates for every trial.²⁵⁶ Warren arrived in Paris in 1847 and could hardly have introduced the technique, though he may have shared details he learned in America, as the leading operators there were indeed galvanizing their own plates.

Southworth and Hawes, the preeminent daguerreian artists in Boston adopted galvanizing in 1843.²⁵⁷ They thought it indispensable, and re-silvered every new plate before use regardless if it was American or French-made by the cladding process or from Christofle et Cie, Paris, made entirely by the electroplating

²⁵⁴ John H. Croucher, "Practical Hints on the Daguerreotype." In *Plain Directions for Obtaining Photographic Pictures*. Philadelphia: A. Hart, late Carey and Hart, 1853: 222-24.

²⁵⁵ Warren Thompson, "Plaques Pour Le Daguerreotype Argentées." *La Lumière* (May 11 1851): 56. In an advertisement, Warren endorsed the newly introduced electroplated plates produced by Christofle et Cie. English translation from Newhall, *The Daguerreotype in America*. 120-21.

²⁵⁶ Valicourt, *Nouveau manuel complet de photographie sur métal, sur papier et sur verre*. Roret, 1851: 26.

²⁵⁷ Charles G. Page, "Letter to A. S. Southworth." In *National Gallery of Canada collection*, April 14, 1843. Chas G. Page was a Professor of Chemistry, employed at the US Patent Office and a daguerreian. He inquired of Southworth, "Do you use simple or compound battery for silvering? Cyanide or Hyposulfite solutions of silver. What do you put on the back of your plate to prevent the deposit?"

process.²⁵⁸ This shows that no matter the original means of manufacture Southworth and Hawes preferred the imaging qualities and polish obtainable with their own process of re-silvering plates.

The advantage of re-silvering clad plates was that it sealed pores or voids in the silver, which were pinpoints of exposed copper. These voids would cause black specks in the image, and over decades green accretions of copper sulphate would form, marring the image. (This artefact of deterioration is common with American-made clad plates that have not been galvanized, Figure 25.)



Figure 25. Daguerreotype of a surveyor with copper sulphate corrosion due to porous silver (left). Verso of the plate indicating that it was not galvanized. Note the red wax used to adhere the plate to a wooden block for buffing (right). Collection of Lawrence T. Jones.

Even with pore-free clad silver, galvanizing was preferred to add a uniform silver coating in terms of hardness and density, as was explained by Dr. Hermann Halleur, formerly the director of the Royal Technical School at Bochum, Germany:

The silvered copper plates generally sold in the early days of photography, had a thin coating of silver hammered or rolled down on them; the same

²⁵⁸ I have in my collection two unused half-plate daguerreotypes from the Southworth and Hawes studio. One was made by the cladding process, the other is a Christofle et Cie electroplated plate. Both have been re-silvered at the studio having a lightly sky blue thin silver deposit.

method is still pursued at the present time in England and France. Now, these plates have their good points, which are outweighed, however, by certain defects inherent in the mode of their manufacture, as will be shown immediately. The other, and better method of plating the copper, is by the galvanic process. The great advantage of this latter process is this, that the silver spread over the surface of the copper is purer, and more uniformly and evenly distributed, than is the case with the plates prepared by the hammering or rolling process; and, what is of greater importance still, that the silver coating is of *equal density throughout*, which cannot well be the case with the hammered or rolled plates. Now a disparity in the density of the silver of the coating is a serious drawback; since not only are the softer and looser parts more strongly affected and wasted in the processes of cleaning and polishing than the harder and denser parts, but the formation of iodide of silver, in the process of iodizing, extends also more deeply into the softer parts, which, of course, cannot but impair the beauty of the picture subsequently taken on the plate.²⁵⁹

It is important to make the distinction between electro-plating and galvanizing. Though essentially the same in theory, in practice the grain structure of the silver deposit is vastly different. During the process, silver ions from the plating solution are deposited as pure silver metal on the daguerreotype plate connected as the cathode (negative) pole of a circuit. The rate of silver deposition increases with current density, which is expressed as *amperage per square unit area*. In electro-chemistry, one coulomb (an ampere-second) will deposit 1.118 mg of silver, which is equivalent to 4.025 grams per ampere per hour. To deposit silver on one side of a full-plate to a thickness equivalent to a number 40 clad plate would require about 70 minutes time at one ampere current.²⁶⁰ To achieve a bright, fine-grained, and adherent layer on a base metal such as copper, a relatively high current density in the range of 2.75 to 4 amps per hour per square foot of cathode area is necessary, though with modified plating baths containing brightening agents and cathode agitation, 15 amps per hour per square foot current is possible to speed up the

²⁵⁹ G.C.H. Halleur, F. Schubert, and G.L. Strauss, *The Art of Photography: Instructions in the Art of Producing Photographic Pictures*. John Weale, 1854: 24.

²⁶⁰ The electro-chemical equivalent of silver is 4.025 grams/amp/hour and silver weighs 10.49 grams per cubic centimetre. A full-plate surface area is 356.45 square centimetres. Silver 12.5 microns thick (.00125 mm) on a full-plate weighs 4.67 grams (356.45 x .00125 x 10.49). Assuming that the verso of the plate is varnished to limit the plating to the front surface, and 100% efficiency of the plating system, the time to achieve the same thickness as a clad silver 40 plate is a little more than 70 minutes.

plating process. The higher the current density, the finer grained and *harder* the silver deposit.²⁶¹ Although electroplating technology was developed at the same time as the daguerreotype, it was nearly ten years before suitable electro-plating solutions containing brightening agents were compounded to enable daguerreotype plate makers to plate silver onto base copper.²⁶²

Re-silvering polished silver clad plates does not require such high current densities for electro-deposited silver to adhere to the silver plate. In fact, electroplated deposits as just described are counterproductive in terms of speed, tone and image quality. Baron Gros, who began electro-chemically silvering his plates in 1846, devoted nearly a third of his hundred-page treatise to the minutiae of galvanizing. He advised that when the current is proper, a full-plate will take on eight decigrams of silver in one hour's time, which was more than necessary for fine results.²⁶³ I was able to calculate the current density used by Gros from this information to galvanize new plates having the same material qualities as historic plates. The electric current Gros used was only one-fifth of an ampere, or 200 mA for a full-plate. This equates to a current density of 0.521 amps per hour per square foot, or six or more times *less* current than used for contemporary electroplating. As mentioned, current density affects the hardness and grain size of the deposit. Figure 26 compares the deposit made by modern electro-plating methods to that of a galvanic deposit produced with a much lower current density.

²⁶¹ W. Blum and G.B. Hogaboom, "Factors Governing the Character and Distribution of the Deposits." In *Principles of Electroplating and Electroforming: (Electrotyping)*, 85-119. New York: McGraw-Hill Book, 1930.

²⁶² Christoffe et Ice in Paris began to make plates by the electroplating process in 1851 as did Scovill manufacturing Company in Waterbury CT. Halleur mentions that F. Schneider, in Berlin is also making electroplated plates for the trade by 1854.

²⁶³ Jean-Baptiste-Louis Gros, *Quelques notes sur la photographie: Sur plaques métalliques*. revised 2nd edition, July 1850 ed. Paris: Roret, 1850: 36. As previously mentioned, the electro-chemical equivalent for silver is 4.025 g/A/hr. Gros' plate weighed 0.8 g more after one hour's time in the plating solution, which means the current, was only one-fifth of an ampere. This equates to a current density of 0.521 amps per hour per square foot, or six or more times *less* current than used for electroplating.

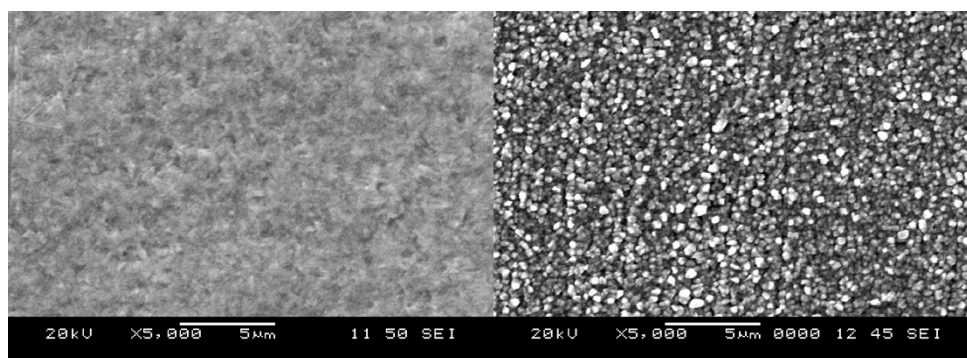

Figure 26. SEM images showing the grain size of high current electroplated silver (left), compared to galvanic low current density (right).

Fine grained hard silver deposits, such as the example in the above figure at left are more wear resistant and appear more intensely black when polished. While this is beneficial for tableware, harder silver also retards photographic sensitivity. I have previously given an example that shows the speed advantage quarter-hard clad plate has over half-hard clad plate (see Chapter 2, p 53). In terms of galvanizing, contrary to Barger's statement, that "American process plates, in which the daguerreotypist electroplates an additional layer of silver onto cold-roll clad plate, has the advantage of a harder silver layer..." the opposite is true; galvanizing performed at low current densities produces very soft and large grained deposits. Soft and large silver grains provide an increase in photo-sensitivity with highlights less liable to solarize while the softer silver substrate is more responsive to the gold toning reaction thereby improving the blacks, as is addressed in a later chapter. S. D. Humphrey found that galvanized plates worked one-fifth faster than Scovill or French plates giving the same results in eight seconds exposure compared to ten.²⁶⁴ Baron Gros described a more precise experiment to determine the benefits of galvanizing by electro-depositing silver on one half of a clad plate:

I took a new coated plate [doublé], as nice as possible, silvered half of it using the battery. I polished the entire plate, as usual, and already, after this first preparation, I realized that the silvered half appeared blacker and

²⁶⁴ Samuel Dwight Humphrey, *Humphrey's Journal of the Daguerreotype & Photographic Arts: Also Embracing the Sciences and Arts Pertaining to Heliography*. Second Series. New York, Published Semi-Monthly by S.D. Humphrey, 546 Broadway. Vol. 3. 1852: 25.

deeper than the side that was not...a proof likewise made with a plate prepared like the above, gave me the following results: the bare side came out well and could have been considered a rather good proof, the silvered side was overexposed and we can conclude that it had received too much light.²⁶⁵

Gros' half-galvanized experiment can be replicated on modern materials. I re-silvered one side of a plate with one amp current for one minute, and the other with 0.070 current for 10 minutes. The side of the plate re-silvered with a lower current density produced a brighter nearly solarized image as shown in figure 27.

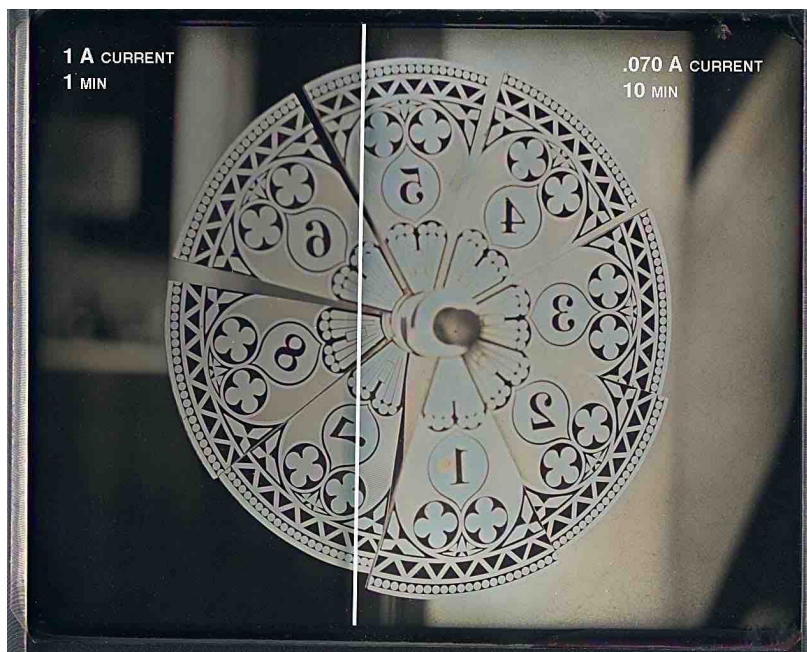

Figure 27. Plating current test, 2005. The photosensitivity difference between a hard, fine-grained silver deposit produced with high current density (left), and a soft large-grained silver deposit produced with low current density (right).

The speed difference is due to larger grain clusters having more surface area available to react with the sensitizer, particularly the bromine. I became aware of this phenomena while troubleshooting a problem with a new batch of clad plates that had a rougher than usual surface. I prepared the plate with 15 micron abrasive sandpaper attached to a random orbital sander rather than hand sanding,

²⁶⁵ Gros, *Quelques notes sur la photographie*. revised 2nd edition, 1850: 3-4. William E. Kilburn, London daguerreian conducted the same experiment several times and reported the same results in a supplement to *The London and Edinburgh Philosophical Magazine and Journal of Science*. Richard and John E. Taylor, Vol. 32. 1848: 541.

hoping to save time. Though the plate seemed well polished, the final image was covered in black spots, which under a light microscope appeared to have a bright nucleus in some of their centres. When viewed in a scanning electron microscope the nucleus was revealed to be a mass of silver grains that had collected in a surface defect during the polishing stage. During sensitizing, these granular clusters of silver residues scavenged the available bromine vapour nearby which created a circular insensitive zone around the defect site, as can be seen in the 500X enlargement in figure 28. This plate was also galvanized on one half of the plate. The grain structure and surface area of the galvanized side masked the polishing residues providing a spot-free image on that half of the plate.

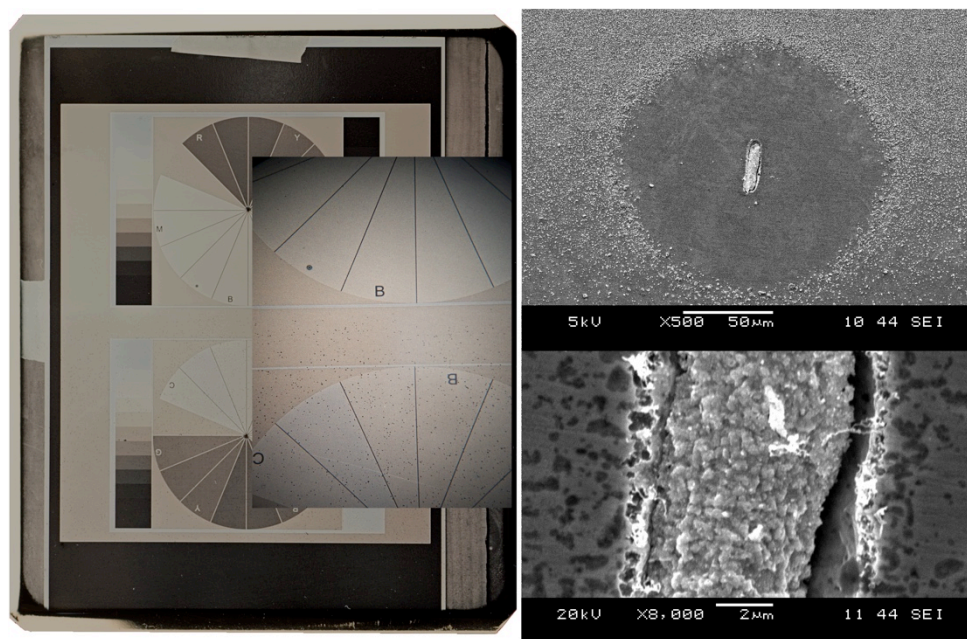

Figure 28. Dag Test 3-23-2014. The inset image from a light microscope shows dozens of black spots on the un-galvanized side that did not form on the galvanized side. SEM image of a black spot magnified 500X shows the insensitive circular void (upper right). SEM image showing silver grain cluster polishing residues trapped in a surface defect (lower right).

The gain in sensitivity from galvanizing is not universal. Kilburn reported the plates were one-third faster, Humphrey only one-fifth faster. The speed benefit is entirely dependent upon the relative hardness of the underlying plate, the quality of the polishing and accuracy in sensitizing. Fifteen years ago, when I was using clad

plates of half-hard temper, and my polishing system was not as refined, galvanizing significantly improved the speed and image quality of my work. More recently, I have found the speed gain from galvanizing is negligible when the polishing and sensitizing is performed with skill. In Dag Test 4-23-2016 (Fig. 29) the image at left is a half galvanized plate of quarter-hard temper. Eighty seconds bromine exposure was insufficient for the plain clad side but enough for the re-silvered side, (indicated by the bright and even tones), proving that the silver deposit influences sensitizing in some cases. I repeated the experiment giving 90 seconds bromine on two plates of different hardness. In these images the gain in tone and speed from galvanizing is slight, barely worth the extra effort; an observation that aligns with Levi Hill on the subject:

The process [galvanizing] is however a tedious, and, without great skill, and very careful manipulation, an uncertain one. It is not, we believe, as much in use among the best operators as formerly”.²⁶⁶

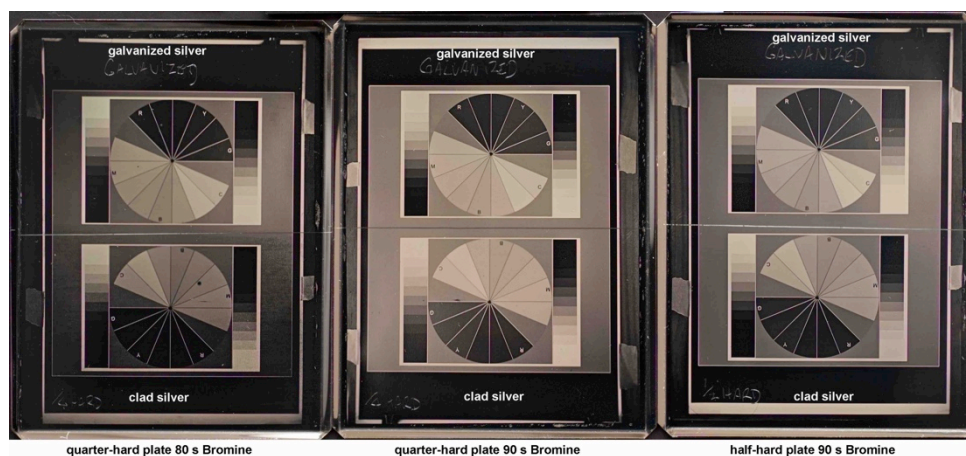

Figure 29. Dag Test 4-23-2016. Galvanizing is beneficial when bromine sensitizing is less than ideal (left). With sufficient bromine, the gain in sensitivity and tone is slight. Softer silver results in a brighter and warmer toned image, all else being equal (centre and right).

The real advantage of galvanizing was to create a pure surface that could be trusted to perform uniformly in terms of speed and imaging qualities regardless of the source or condition of the original plate. The daguerreotype process was

²⁶⁶ Levi L. Hill, *A Treatise on Daguerreotype; and the Whole Art Made Easy*. Lexington, N. Y.: Holman & Gray, 1850: 45.

challenging enough without having to remember that Edward White's plates were *faster working* than Scovill's or French hammered plates due to the relative hardness of the metal. The label on a box of Edward White's plates, figure 30, boasts that due to the purity and softness of the silver, they require only half the polishing, are "exquisitely sensitive, and pictures of greater beauty, depth and distinctness, can be taken on them, than with any other plates".

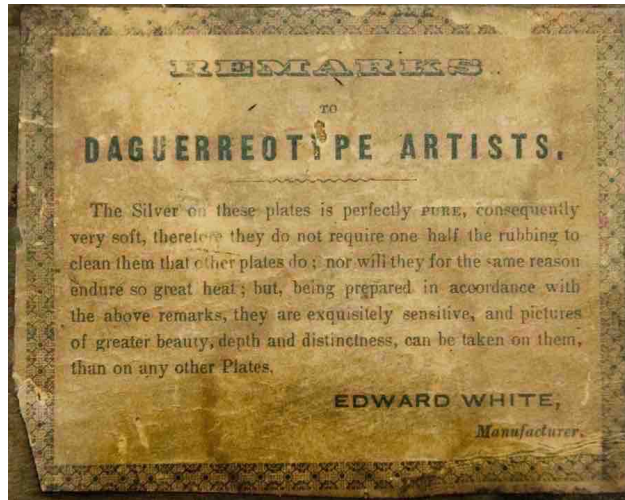

Figure 30. Box label for plates made by Edward White, New York manufacturer. National Gallery of Canada collection. Author photograph.

Galvanizing added a pure and soft surface that performed equally well as White's 'Finest Quality A No. 1' plates, as they were stamped, but enabled the daguerreian to produce similar results on plates of any quality or manufacturing method. Iodine vapour is extremely susceptible to the slight variations in silver microstructure, surface polish and cleanliness. The daguerreian operator, in galvanizing their plates could be assured of a reliable plate surface every time.

3.7 The Silver Plate: Conclusion

Daguerre announced that the photographic standard set by him and Niépce was achieved in late 1838. The self-named Daguerreotype was superior in speed, sharpness, delicate gradation of tones, and more highly detailed than any other photographic process known by a wide margin; being 120 times faster than silver-chloride due to iodized silver plates and latent image development. Daguerre's correspondence with Isadore Niépce in December 1835 clearly indicates that he had discovered the latent image shortly after his previous letter of August 4, and around the time of its announcement in *Journal des Artists*, on September 27. Significantly, Daguerre believed portraits were within reach.

In terms of the purity of the silver plate, the re-creative method implicitly shows the negative effect that silver alloyed with copper has on imaging quality. I have shown why M. Susan Barger misinterpreted her analysis of Cornelius' daguerreotype plates (being alloyed with copper) due to the penetration depth of scanning electron beam and have shown Cornelius' remarkable image quality is not due to copper alloyed with silver, but due to his skill in silver polishing with the use of a burnishing tool and his special mix of abrasive powders. I have described and illustrated the precise viewing technique, using half-shadow illumination, to observe burnishing artefacts and plate surface details on historic plates and this technique is immensely useful in identifying work by Cornelius and other early American images such as those made on Corduan and Co. plates.

I have described the difference between French-made (planished) and American-made (rolled) daguerreotype plates and shown how one can observe the hardness differential of planished plates through reflection, and the pores and marks of rolled plates by half-shadow illumination. French platers minimized defects from the mill by rolling the plates face to face during the final stages, and this technique was adopted in America then exported, and patented in England by John Johnson from New York. In a similar transfer of technology, Johnson developed a lathe polishing system in London and returned to patent the method in

New York. I have described the polishing methods as practiced during the height of the art, which differ significantly from that first published by Daguerre and note that he continued to develop his polishing methods and made improvements known to the scientific community through correspondence with François Arago. The degree of difficulty with Daguerre's original method is made explicit through modern reproductions and historical experiments contained in Samuel Morse's notebook from January and February 1840.

Barger's research in daguerreotype raw materials is truly invaluable, but her investigation into the role the plate plays in image formation is limited to the reflective quality of the surface. The quality of the polish affects the surface reflectance, which in turn improves the black or dark values of the image. This is true and very important if we are solely interested in making mirrors. The daguerreotype is not a mirror, it is an image, and the image is due to particles on the reflective surface that scatter light. Particle morphology is partly influenced by the materiality of the silver plate in terms of hardness and purity. Electroplating with the high current density required by modern electroplating practice forms a very hard and pure silver surface. This fine grained, hard surface can be polished to a high reflectance, but its structure is not ideal for maximum sensitivity or image particle growth. Barger has incorrectly assumed, first that galvanizing is what constituted the *American Process*, and secondly that it is materially equivalent to electroplating. I have shown how galvanizing came to be incorrectly thought of as an American advancement, and that the galvanized silver deposit is large-grained and very soft due to the low current density employed. Galvanized, large-grain silver deposits work faster in degrees than most clad plates as reported in historic texts and shown through modern re-enactments. Barger could not have experienced this because the new daguerreotypes produced for her study were made with electroplated silver, not silver-clad copper or soft galvanic deposits.²⁶⁷

²⁶⁷ Barger, "The Daguerreotype: Image Structure, Optical Properties, and a Scientific Interpretation of Daguerreotypy": 52-4. Barger attempted to make silver-clad copper plates for her study but abandoned the idea. She resorted to electroplating as the only practical method to

Re-silvering daguerreotype plates was a process introduced in the early 1840s as a remedy for perforations and non-uniform densities in rolled and planished clad plates. As plating and polishing methods improved, galvanizing became less important for practitioners, however, some like Southworth and Hawes continued to re-silver every plate before use regardless of its quality to ensure a uniform and regular surface in preparation for sensitizing. Uniformity in hardness, purity, and silver microstructure greatly aided the sensitizing process and repeatability of results.

produce plates. The plates for her study were produced with a current density ($\sim 7\text{A/ft}^2$) twelve times more powerful than that used by Baron Gros' re-silvering method ($\sim 0.5\text{A/ft}^2$).

4.1 Sensitizing with Iodine: Overview

The daguerreotype plate serves an important optical and a chemical role, in addition to being a support for the image. Optically, the more perfect the polish, the greater the contrast and richness of the shadow values. A perfect polish is also vital for the uniformity of the sensitizing process. The plate made of silver provides half the material for silver-iodide molecule (AgI). This chapter deals with iodine, the other half of the material equation.

Several histories of photography report that Daguerre discovered the light sensitivity of silver iodide by accident. In this chapter I review the origin of this anecdote and show by replicative evidence that historic engravings depicting the accidental discovery are at odds to reality. Correspondence between Daguerre and Niépce proves he was a careful experimenter who clearly understood the nature of silver iodide.

Silver iodide formed on polished silver appears as a progression of prismatic colours during the sensitizing process. The aim of this chapter is to make explicit the nature of silver iodide formed on the plate, in terms of its structure, apparent colour, and the relative photographic speed of these colours, as they are not equally light sensitive. Equally important is the manner in which the plate receives its iodine coating. The plate is exposed to iodine vapour contained within an enclosed sensitizing box. This box plays an important role in forming silver iodide on the plate and this chapter explains how its design can assist in the application of a uniformly sensitive coating in a convenient amount of time. Daguerre's first box design required between five and thirty minutes to attain the desired golden-yellow coating and he and others quickly modified the coating box to shorten the iodizing process.

My re-enactment of the forgotten spoon anecdote illustrates the rapid reaction iodized silver plates have to light, and a replication of the iodine ring experiments by Talbot and Waller in the early 1840s explicitly shows the relative photolytic

sensitivity of the various colours of silver iodide. This is followed up with experiments designed to produce four levels of iodine on a silver plate by exposing each quadrant to iodine vapour in doubling increments. The colours were recorded and compared against the quality of the photographic image they produce with mercury development. This experiment directly illustrates the negative affect on image quality from too little or too much iodine exposure. I have designed a novel means to accurately record the reflection spectra from silver iodide using a spectrophotometer. The setup and positioning of the device using SpectraShop[®] software accurately reproduces the colours and viewing geometry observed during the actual sensitizing process. Reflectance and absorption spectra obtained from modern samples using the spectrophotometer help to explain the relative sensitivities of different iodine coatings; why a yellow appearing coating is more sensitive than a blue coating. Furthermore, with scanning electron microscopy of iodized plates, I provide evidence to re-define the model for the formation of silver iodide from that of thickness to particle size and density. This new model accounts for the mercury development fog on insufficient iodine coatings. In the section on the sensitizing box, I show historic and modern examples of the effects of uneven iodine coatings and under what circumstances they occur. My work with modern samples informs the interpretation and understanding of uneven iodizing effects seen on some nineteenth century images.

4.2 Sensitizing with Iodine: Introduction

Iodine is the foundation of the Daguerreotype process; without it light sensitivity cannot be imparted. Bernard Coutrois, a French chemist and manufacturer of saltpeter discovered this crystalline, fuming, substance while trying to discern why his metallic apparatus corroded during his process. He poured sulphuric acid on the residual liquid from the washed ash of burned seaweed and a violet corrosive gas evolved that condensed into dark metallic-looking flakes. He sent samples of this substance to his friends Charles Desormes and Nicolas Clément for analysis, who then passed some on to Sir Humphry Davy. Within a few years, Davy had determined that it could not be decomposed further, and had suggested the name iodine for the new element, as he felt its properties analogous to chlorine and fluorine. Davy also reported on the combination of iodine with silver, "The precipitate was much more rapidly altered by exposure to light, than the muriate of silver, and was evidently quite a distinct body".²⁶⁸ As noted in a previous chapter, Daguerre studied chemistry while ensconced in his laboratory surrounded by chemical treatises.²⁶⁹ He must have done his research on silver iodide, for he knew it was decomposed by daylight.²⁷⁰

Daguerre, in the spring of 1831, concurrently with his experiments with the Physautotype process, which used lavender resin as the light sensitive compound, experimented with iodized silver plates and he encouraged Niépce to do the same. The anecdote that Daguerre accidentally discovered silver iodide was light

²⁶⁸ Humphrey Davy, "Some Experiments and Observations on a New Substance Which Becomes a Violet Coloured Gas by Heat." *Philosophical Transactions of the Royal Society* (1814): 76-93. Davy also describes the precipitate, silver iodide, to be light yellow and that of muriate of silver to be white, as is the case. Muriate of silver is the archaic term for silver chloride.

²⁶⁹ Charles Chevalier, "Éloge de Daguerre. - Documents historiques, lettres inédites de N. Niépce, etc.". Chap. Troisième Partie. In *Guide Du Photograph*. Paris, Palais Royale 158: C. Chevalier, 1854: 23.

²⁷⁰ Louis Jacques Mandé Daguerre and J.S. Memes. *History and Practice of Photogenic Drawing on the True Principles of the Daguerreotype*, Tr. By J.S. Memes. 1839: 39. Daguerre's footnote reads, "It is of importance to point out to the reader that the use of iodine here made by M. Niepce only to blacken his plates, proves that he was not acquainted with the property possessed by this substance, when in contact with silver, of being decomposed by light." What this means is that the latent image is invisible silver particles, created by photolysis of silver iodide.

sensitive persists and does not help to convey his scientific rigour. Recently historians, Roger Watson and Helen Rappaport in *Capturing the Light*²⁷¹ rehash the story, as do Helmut and Alison Gernsheim in *L.J. M. Daguerre*²⁷² written a half century earlier, and G. L. Johnson in *The History of Daguerre: The Story of His Invention* in 1905.²⁷³ André Gunthert in *L'inventeur inconneu*, traces this tale from a two-part article published in 1853 by Francis Wey, retold by Louis Figuier in 1869. Wey's history illustrated with engravings, states that Daguerre stumbled upon the light sensitivity of silver iodide by accidentally leaving a silver spoon on an iodized silver plate and noticed an image upon removing the spoon. Daguerre's face in the 1853 engraving may be taken from a daguerreotype by Charles R. Meade in 1848, quite some time after the event.²⁷⁴ The later engraving borrows many elements from the former, such as leaning canvases, drafting tools, and chemical bottles.²⁷⁵ The illustrations, figure 31, show a surprised Daguerre holding the spoon in his hand while regarding the dark image of the spoon on the plate. Both depictions of this supposed event are technically at odds to reality. First, Daguerre would have no reason to iodize a plate in the manner illustrated had he been preparing a heliograph or physautotype, and secondly, the spoon would have blocked light and left a *light* image on a dark ground. The illustrations depict the opposite, with the spoon rendered darkly.

²⁷¹ Roger Watson and Helen Rappaport, *Capturing the Light: The Birth of Photography, a True Story of Genius and Rivalry*. St. Martin's Press, 2013: 85.

²⁷² Helmut and Alison Gernsheim, *L.J.M. Daguerre: The History of the Diorama and the Daguerreotype*. 2nd revised ed. New York: Dover, 1968: 69.

²⁷³ Geo. Lindsay Johnson, M.A., M.D., B.Sc., F.R.C.S, "The History of Daguerre: The Story of His Invention." *The Photographic Journal* 45, no. 3 March (1905): 127-9. Johnson claims that the discoveries of silver iodide sensitivity and mercury development were both fortunate accidents that surprised Daguerre in his laboratory.

²⁷⁴ Francis Wey, "Comment le Soleil est Devenu Peintre. Histoire du Daguerreotype et de La Photographie." *Musée des familles XX* (juin 1853, p. 257-265, juillet 1853, p. 289-300 1853): 261. Charles Meade was a visiting daguerreian from New York State. While in Bry, Daguerre explained to him how he came to use mercury.

²⁷⁵ Louis Figuier, *Merveilles de la Science*. Paris: Jouvet & Cie, 1869: 37.



Figure 31. Francis Wey, "Comment le soleil est devenu peintre. Histoire du Daguerreotype et de la photographie." *Musée des familles XX*, 1853, p. 261 (left). Louis Figuier, *Merveilles de la science*. Paris: Jouvett & Cie, 1869. p. 37 (right).

Gunthert, in *L'inventeur inconnu*, argues that the history of photography has not been established by expert practitioners having technical knowledge, but rather through editorial initiatives by authors outside of the photographic field.²⁷⁶ I agree with Gunthert in this regard. The training of photo-historians has traditionally been in other fields, for instance Wey was the Inspector General for the department of archives in Paris, a French language historian, and a photographic art critic. He was not an expert practitioner. The engraving in Wey's history is similar to the one printed sixteen years later in Figuier's history. Figuier, a chemist and scientist, presumably would have been familiar with the effects of sunlight on an iodized silver plate (with or without a forgotten spoon on it) however both illustrations show a dark plate with a light shadow where the daylight was prevented to act on it.

Victor Fouque, also writing in the late 1860s, championed Niépce's right of priority in *The Truth Concerning the Invention of Photography*. He stated that

²⁷⁶ André Gunthert, "L'inventeur inconnu: Louis Figuier et la constitution de l'histoire de la photographie française." *Études Photographiques*, no. No. 16 (2005): 7. Gunthert wrote, "L'histoire de la photographie n'est pas née du côté de la technique. Elle n'a pas été établie par des praticiens experts, mais par des littérateurs dilettantes, dans le cadre d'initiatives éditoriales la plupart du temps extérieures au champ photographique."

Daguerre changed nothing in principle merely substituting iodine for bitumen of Judea.²⁷⁷ These historians have failed to acknowledge the significant seventy-fold speed advantage that iodized silver plates had over lavender resin, which in itself was roughly eight times faster than bitumen. The effect of sunlight on an iodized silver plate with a spoon resting on it is *visible* in minutes (much faster than the days or hours required for the bitumen or Physautotype process).²⁷⁸ The following re-creation of the experiment shows that the shadow of the spoon is visible as a light or negative image in five minutes, and very distinct in ten minutes (Fig. 32).

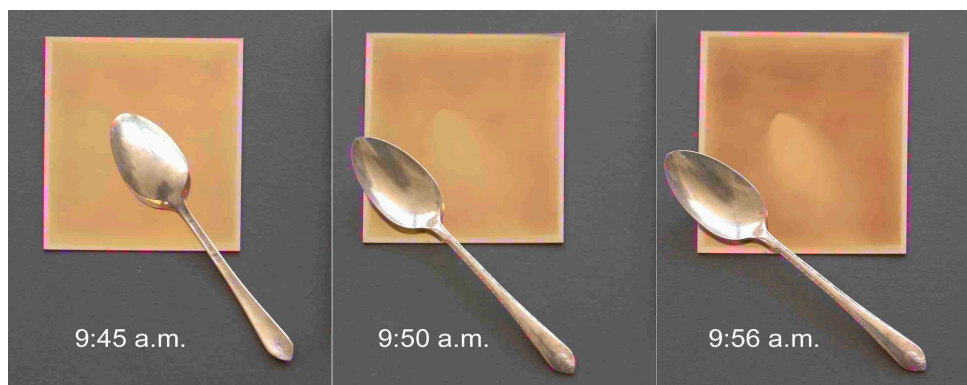

Figure 32. DagTest 4-12-2014. A silver spoon left on an iodized plate near north facing window light.

Daguerre and Niépce were well aware of the light sensitivity of iodized silver plates proven by their exchange of letters. Daguerre wrote to Niépce that he observed the effects in a camera in three minutes, two minutes when the plate is exposed in a microscope, and one minute if by contact print in full sunshine; evidence that he had experimented with different exposure methods. He concluded, “Maybe we’ll find a way to fix this picture, or perhaps a way to get the same sensitivity from our other substances”.²⁷⁹ Niépce’s reply was pessimistic:

²⁷⁷ Victor Fouque and Edward Epstean, *The Truth Concerning the Invention of Photography: Nicéphore Niépce; His Life, Letters and Works* [in English]. New York: Tennant and Ward, 1935: 120. Epstean translated Fouque’s original 1867 French text in 1934.

²⁷⁸ The spoon does not need to be made of silver. One of my motives for repeating this experiment was to determine if the silver spoon had any effect in producing a dark image. It doesn’t, it simply blocks light, as would any opaque object.

²⁷⁹ Nicéphore Niépce, M. Bonnet, and J.L. Marignier, *Niépce, correspondance et papiers*. Maison Nicéphore Niépce, 2003: 989-90. no. 532. Daguerre letter to Niépce dated May 21, 1831.

I had given my attention to similar researches previous to our connexion, but without hope of success, from the impossibility, or nearly so, in my opinion, of fixing in any durable manner the images received on iodine, even supposing the difficulty surmounted of replacing the lights and shadows in their natural order. My results in this respect have been entirely similar to those which the oxide of silver gave me; and promptitude of operation was the sole advantage which these substances appeared to offer.²⁸⁰

Niépce recognized that the sole advantage of silver iodide on a silver plate, compared to their other substances, was speed, though he was at a loss on how to achieve lights and shades in their natural order. He was aware that light exposed silver iodide turned black. More important than an overlooked spoon, is what the historians have overlooked. The work was performed on *unpolished* plates! Gaudin wrote that Niépce's iodizing of silver was a simple method to produce black shadows. It was intended to produce a matte black by way of exposed silver iodide rather than the black reflected from polished silver.²⁸¹ The use of unpolished plates for this purpose has been addressed in the previous chapter and further in the chapter on latent image development.

What is most important is that Daguerre recognized the tremendous speed advantage offered by iodized silver plates. Though an improvement over bitumen, the physautotype process required impractically long exposure times. Silver iodide prepared on a silver plate required only minutes in direct sunlight for the effect to be noticed, leading Daguerre to abandon the slower working methods; they were after all seeking a practical, marketable process. Hours-long exposures cannot yield sharp images in a camera as shadows move within the field of view focused on the plate. Re-enactments indicate that Daguerre must have observed the rapid blackening of silver iodide when he wrote to Niepce about observed effects with a

²⁸⁰ Niépce, and Marignier. *Niépce, correspondance et papiers*. 2003: 993-4. no. 535. Niépce letter to Daguerre dated June 24, 1831. The English version is from Memes' translation of Daguerre's Manual, 50-51.

²⁸¹ Gaudin, *Traité pratique de photographie, exposé complet des procédés relatifs au Daguerreotype, avec description de sa nouvelle méthode pour travailler au bain d'argent*. J. J. Dubochet, 1844: 4. Gaudin wrote, "il visait à produire un noir mat à la place d'un noir de miroitement". (translation) Mat, unpolished silver blackened with iodine, does not appear nearly as black as polished silver reflecting darkness.

camera, microscope and contact print. This also helps to understand why he sought a way to convert, or whiten the effects of light exposure to produce images in their natural order. He finally achieved this goal in 1835 by amalgamating print-out silver with mercury.

Even though iodized silver plates were by far the most sensitive of all the substances Daguerre tried, their sensitivity can be affected by too little, or too much, exposure to iodine vapour. Too much iodine will result in a less sensitive plate and too little iodine will give very poor results. The materials and methods developed to apply a uniform silver iodide layer on a well-polished plate, having the greatest sensitivity, while yielding images with good tone and contrast, will now be addressed.

4.3 Sensitizing with Iodine: Colours, Speed, and Spectral Sensitivity

What is the proper way to prepare silver iodide on a silver plate for the greatest speed, tone and contrast? In the daguerreotype process, the polished plate is exposed to iodine vapour emanating from iodine crystals contained within an enclosed box. Daguerreians often called these coating boxes and referred to the silver iodine sensitizing as “coating the plate”. These coatings came to be described in terms of thin or thick as determined by its apparent colour. The colours of silver iodide on a polished silver plate are entirely different than silver iodide precipitated from solutions. Silver nitrate and potassium iodide mixed together form a curd-like, light yellow solid (silver iodide) that changes very little in sunlight. The additional silver available from the plate itself serves as an accelerant; analogous to Talbot’s discovery that excess silver nitrate increases the sensitivity of silver chloride printing-out paper. The appearance of silver iodide on polished silver progresses through the colours of the spectrum in relation to the length of exposure to the iodine vapour. A very brief exposure forms an invisible coating, and with more time, light yellow soon appears, then deeper golden yellow, reddish-yellow, red, magenta, violet, blue, green and then colourless once again. The cycle will then repeat a second, third and even fourth time given enough iodine vapour exposure. These cycles can be made to form in rings, which serve as a useful learning tool, but not a means to prepare daguerreotype plates for image making, as the coating must be uniform in colour for optimum results.

W. H. F. Talbot, as soon as the details of the daguerreotype process were revealed, devised an elegant experiment to observe the cycling effect of iodine colours. He placed a grain of iodine, no larger than the head of a pin, on a silver plate. In doing so the colours formed on the plate like they were the waves from a pebble tossed into a perfectly still pond.²⁸² Augustus V. Waller, educated in Paris

²⁸² W.H.F. Talbot, "Meeting of the British Association for the Advancement of Science." *The Athenaeum*, no. 618 (September 16 1839): 643-4. Talbot remarked that he had also observed the

as a medical doctor, returned to London in 1841, and perhaps unaware of Talbot's iodine rings experiment from 1839, began to study the subject in the autumn of 1840. He published a very thorough account in December 1842. Waller did much more than repeat Talbot's work. He also created similar coloured rings with chlorides, bromides and oxides on silver, and on copper, and made note of their relative light sensitivities. Interestingly, his experiments showed that silver chloride and silver bromide rings prepared on silver were *less* photosensitive than silver iodide and those on copper even slower.²⁸³ Augustus Waller described a very effective means to study light sensitivity relative to the colours of silver iodide:

The action of light on the different colours of the iodide of silver is very interesting: the most correct way of studying this is to protect one half of a system of coloured rings by an opaque [sic] screen, while the other half is exposed for a short time to the influence of the solar rays.²⁸⁴

light sensitivity of silver iodide but he chose to experiment with silver chloride instead that prints-out quicker than silver iodide (on paper). Talbot had not considered the possibility of developing a latent image or experimented with the idea until after Daguerre's process was known.

²⁸³ Waller discovered what daguerreians experimenting with chlorine and bromine would learn. Using bromine or chlorine alone will not work. Sensitizing with chlorine and bromine must be done with iodine present, either in combination with, or with iodine first, followed by the accelerating halogens of chlorine and/or bromine.

²⁸⁴ Dr. Augustus Waller, "Experiments on the Coloured Films Formed by Iodine, Bromine, and Chlorine Upon Various Metals." *London and Edinburgh Philosophical Magazine and Journal of Science*, no. 21 (1842): 422 - 27. When Talbot read this, he felt obliged to set the record straight as to who created the iodine rings first, and published his own account, "On the coloured Rings produced by Iodine on Silver, with Remarks on the History of Photography, in the same journal, no. 22 (1843): 94 -97.

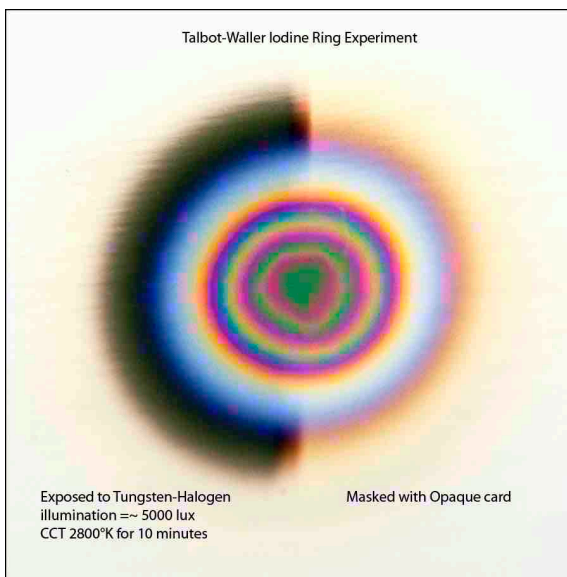

Figure 33. DagTest 9-19-2011, Iodine Ring Experiment.

My experiment shown in figure 33, DagTest 9-19-2011, follows Waller's advice. A piece of iodine-saturated silica gel was placed on a piece of silver clad copper and covered with a watch crystal to create a closed and stable atmosphere. Coloured rings were observed to form progressively through yellow, orange, magenta, violet, blue, and green, before appearing colourless again. The iodine was removed when rings were formed to the fourth cycle. An opaque card then covered half of the concentric rings and the plate exposed to a bright tungsten-halogen light for ten minutes. As in Niépce's work, the silver iodide reacted when exposed to light, but *not all* colours darkened. The experiment clearly shows that invisible silver iodide is formed before the first appearance of light yellow. The experiment also shows that the greatest change (blackening) occurs in the first cycle magenta colour and little to no change occurs in the blue appearing rings of silver iodide. Daguerre understood this years in advance of Talbot or Waller. He had established that the quickest working colour for silver-iodine was golden-yellow and that coatings that appeared blue were less sensitive to light. The depth of his understanding is revealed in the following letter:

May 21, 1831

My dear Mr. Niépce.

After a number of new tests, I believe we should focus our research on iodine. This substance has a great sensitivity to light when in contact with polished silver. It is important that the plate is removed as soon as it takes on a beautiful golden hue, equal throughout, because if it continues to a different bluish or bronze colour, it does not have the same sensitivity to light...

What makes me believe in the possibility of obtaining images in their natural order is this. When I place an engraving on an iodized plate, the features that were dark after one minute exposure, change to a bluish colour, not quite white, with an excess of light exposure. (like the colour of your plum tree blossoms, sir)

I think sir, we would not be wasting our time to work with this substance, and to be sure that you arrive at the same golden tint, I am forwarding a test that I made with a lens and camera just like the small one you have. Take care not to look at the plate in broad daylight, because the image will disappear, but you can still see enough to judge the colour on the polished silver.

your partner,

Daguerre.²⁸⁵

The unfixed sample plate that Daguerre forwarded to Niépce, to help him judge the correct colour on the plate, may have looked similar to my DagTest 2-16-2013 in figure 34. In the letter that accompanied the plate, Daguerre mentioned that the effects in camera could be seen in three minutes. My experiment, with a simple bi-

²⁸⁵ Nicéphore Niépce, M. Bonnet, and J.L. Marignier, *Niépce, correspondance et papiers*. Maison Nicéphore Niépce, 2003: 989-90. Letter no. 532. Online at <http://www.niepce-letters-and-documents.com/book/#/989/> (Date accessed, 18 March 2017) This letter illustrates the extent of Daguerre's research. He is aware that quickest coatings of silver iodide on polished silver are golden yellow. He has made contact prints on iodized plates from engravings and noticed the reversal of tones with extended light exposure. This is similar to the Becquerel method of forming image particles with continued, red light exposure after the image is first formed by daylight. And finally, he has created unfixed negative images in a camera. The sample Daguerre sent to Niépce to judge the plate colour was a camera image. The image would have appeared black (negative) within a golden-yellow ground of silver iodide. As Daguerre warned, if the sample were to be exposed to broad daylight, the entire plate would blacken, causing the image to disappear.

convex lens and cigar box-like camera, required twenty minutes exposure. This is not unusual, considering the bleak wintry day of the experiment.



Figure 34. DagTest 2-16-2013. View from studio window (left). In camera, unfixated silver iodide print-out negative (right).

Daguerre sent an iodized plate to Niépce to ensure that he experimented with the same golden-yellow colour coatings. The iodizing colours are best seen when the plate is held obliquely to reflect diffuse white light from its surface, however, as the plate is held in the hand at an angle determined by the artist there is no standardized geometry to inspect the coating colours. As the inspection angle is changed, so does the apparent saturation of the coating.

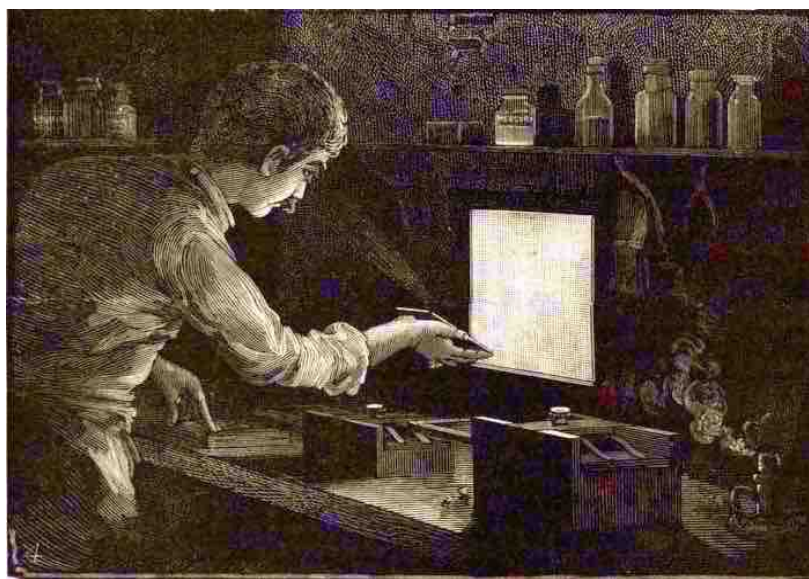

Figure 35. Inspecting the sensitizing colours. *The Scientific American*, January 22, 1887, Vol. 56, No. 4, p 47.

Along with viewing angle, intensity and colour cast of the inspection light will affect the perceived colours on the plate during sensitizing. To avoid unwanted exposure to the plate, daguerreians often performed the sensitizing by the illumination of a candle, or the dim light of a distant open door in the dark room (Fig. 35). Under dim or yellowish candlelight, it is very difficult to discern when the desired golden-yellow has been attained.²⁸⁶ Operators, sensitizing under different lighting conditions, each striving to attain the golden-yellow hue recommended by Daguerre, may in reality have prepared their plates quite differently. This may account for the differences of opinion on the correct colours in nineteenth century texts. Between 1997 and 1999, Charlie Schreiner, a modern practitioner posted an online newsletter for the general interest of the contemporary daguerreian community. He published, *In Their Own Words*, a survey of fifty vintage sources, to determine if there was a consensus of opinion in terms of the recommended sensitizing colours for iodine. He tallied his results to find very little agreement between the coatings suggested by nineteenth century daguerreotypists, though he noticed a trend over a decade progressing from “thinner” yellow iodine coatings to “thicker” red-rose. Schreiner, as a practitioner, understood the difficulty with written descriptions of colour:

A rose is a rose? One annoying difficulty with daguerreotyping is clearly identifying a particular color of silver iodide and trying to get THE color the same every time. Or, for that matter, telling someone about it. The colors are in a continual shift and at any one moment the color is really a blend of several colors. Throw in some iridescence and a verbal description is weak at best and matching to a color chip is impossible.²⁸⁷

Considering the difficulties with clearly identifying and describing sensitizing colours, and that any interpretation of the colours is affected by viewing angle and illumination, it was essential to establish a standard and repeatable system to

²⁸⁶ I perceive the yellow patch of an X-rite ColorChecker[®] chart as white, and the orange patch as yellow, when viewed by candlelight at one-foot distance (luminous intensity of one candela). Furthermore as the light levels drop, colours become less saturated.

²⁸⁷ Charlie Schreiner, "In Their Own Words." *The Daguerreotypist: a Newsletter for Contemporary Daguerreotypists* (1998). <http://daguerre.org/resource/dagtypist/cs06-15-98.html>. (Date accessed, 30 March 2012) Schreiner, tried to compare his sensitizing colours to Pantone[®] patches, a standard colour reference system.

document the colours. Without such a system it would have been difficult to make explicit the results of my sensitizing experiments. Daguerreotype experiments were captured with a digital camera, using lighting methods to best record sensitizing colours as seen in the darkroom, and are compared with digital images of the finished daguerreotypes. I have also developed a means to record spectrophotometric readings directly from sensitized samples using a measurement geometry that matches the viewing angle (approximately 30°), used by daguerreians to evaluate the colours during plate preparation. Irving Pobboravsky studied iodized daguerreotype plates in 1971 and expressed regret that he was unable to match the incidence and reflection angle common to daguerreian practice due to the limitations of the spectrophotometer he used.²⁸⁸ With an X-Rite i1 Pro 2 spectrophotometer and SpectraShop[®] software set to measure plates at the same angle as viewed during sensitizing, I was able digitally reproduce the sensitizing colours as I saw them (Fig. 36).

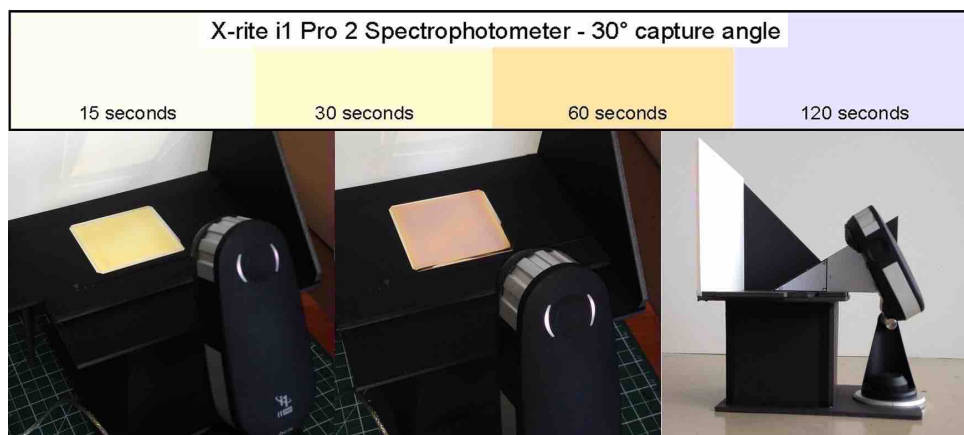

Figure 36. Colours reproduced directly from a sensitized plate with a spectrophotometer.

²⁸⁸ Irving Pobboravsky, "Study of Iodized Daguerreotype Plates." "In partial fulfillment of a masters degree in photographic sciences, School of Photographic Arts and Science, Rochester Institute of Technology ", Information Service, Graphic Art Research: 14. Pobboravsky wrote, "It is regretted that the spectrophotometer could not imitate the illumination-collection geometry used by observers when viewing the iodide surface. The plate is usually viewed by specular reflectance at an angle of roughly 60 degrees to the normal. Viewing geometry is quite critical, especially for thicker layers, because the color seen depends upon the angle of view."

In order to determine the optimum amount of iodine exposure to produce the best speed, tone and contrast, I prepared a plate with four coatings of iodine, beginning with fifteen seconds and doubling the time for each successive quadrant. In the experiment shown in figure 37 (DagTest 9-17-2011) overall fogging occurs in the two lightest coatings, no image is visible within the 15 second quadrant, and just a trace image of the brightest patch of the test target is reproduced in the 30 second quadrant. Fog does not occur with sufficient iodine exposure (60 seconds), which I interpret as a reddish-yellow coating. At 120 seconds the coating appears violet-blue, and the greyscale reproduced has darker highlights and lower contrast.

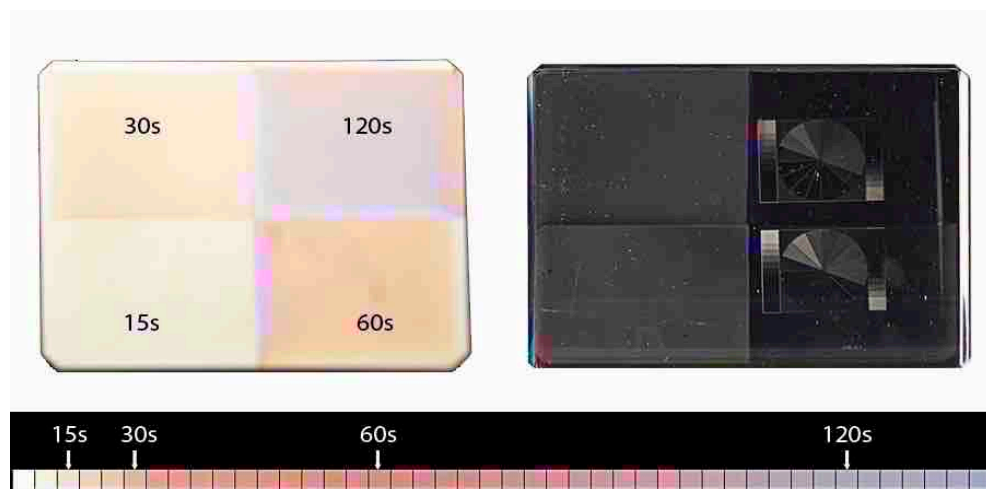

Figure 37. DagTest 9-17-2011. Iodizing colours (left), and the completed image (right) and first cycle reference scale (below).

The loss of quality from excess iodine observed here conforms closely to Daguerre's advice, "If left too long the bright golden yellow will turn violet which should be avoided, because then the light will not have such a powerful effect on it".²⁸⁹ When the yellow coating is not sufficient, Daguerre simply says the image from nature will be reflected with difficulty. Whether or not Daguerre is referring to fog is unclear. In my normal daguerreian practice, I have never experienced such fogging, nor have I read any reports of it in vintage sources. This is understandable as short sensitizing times with only iodine as a sensitizer was not

²⁸⁹ Louis Jacques Mandé Daguerre and J.S. Memes, *History and Practice of Photogenic Drawing on the True Principles of the Daguerreotype*, Tr. By J.S. Memes. 1839: 67.

be part of normal practice after 1840 or 41. The veiling phenomena has also not been reported in the modern era because contemporary daguerreians who use only iodine, do so to avoid the use of the more noxious substances of bromine and mercury. Daguerreotypes can be made without mercury using the Becquerel phenomena to develop images.²⁹⁰ Fogging with light iodine coatings only occurs with mercury development. My tests using Becquerel development with similar four-quadrant sensitizing procedures remained fog free in the lightest coatings.²⁹¹ Interestingly, a plain polished plate masked during sensitizing to leave one-third plain silver, one-third iodized for 20 seconds and one-third for 60 seconds, and given no camera exposure, but exposed to mercury vapour for the usual development time provided notable results. The plain silver third, contrary to expectations that it would be white with mercury amalgam, remained clear and unveiled by mercury. I am not the first daguerreian notice this.²⁹² The twenty-second iodized section was uniformly veiled with silver-mercury amalgam and the sixty-second section far less veiled, though dotted with larger silver-mercury amalgam particles.²⁹³ Another observation, which came as a surprise, and has not been reported elsewhere, is that mercury developed image particles, before fixing, are not easily rubbed off the plate. After fixing, the image is as delicate as the dust

²⁹⁰ "Physique. - Mémoire sur le rayonnement chimique qui accompagne la lumière solaire et la lumière électrique; Par M. Ed. Becquerel. (3e Mémoire. - Extrait Par L'auteur.)" *Compte rendus hebdomadaires des séances de l'Académie des sciences*, no. Séance du Lundi 2 Novembre (1840): 702-3. Edmond Becquerel discovered that latent daguerreotype exposures could become visible by printing-out the image under yellow or red glass. This required several hours in sunlight, which was impractical for commercial use in the daguerreian era. The Becquerel method does not work with bromine accelerated plates but has become a popular way for contemporary daguerreians to make images without mercury.

²⁹¹ DagTest 9-19-2011 and DagTest 9-20-2011 were sensitized with 20,40,80 and 160 seconds iodine. One developed by the Becquerel method using yellow glass, the next with red glass.

²⁹² Pobboravsky, "Study of Iodized Daguerreotype Plates." "In partial fulfillment of a masters degree in photographic sciences, School of Photographic Arts and Science, Rochester Institute of Technology", Information Service, Graphic Art Research Center, Rochester Institute of Technology, 1971: 48. Pobboravsky observed the same, counter intuitive, result during the course of his research. He wrote, "Also, surprising as it may seem, no mercury was precipitated on the bare silver even though it was unprotected by silver iodide. A similar observation was reported by Claudet". See Antoine Claudet, "Progress and Present State of the Daguerreotype Art", *Journal of the Franklin Society*, series 3, vol. 10, no. 2, Aug. 1845: 114.

²⁹³ DagTest 3-3-2015. This test, prepared under safelight and given no camera exposure, confirms that the mercury is reacting with silver from the polished plate, as there is no latent image silver available.

on a butterfly's wing, meaning it can be destroyed by the slightest touch.²⁹⁴ This would suggest that the image particles are not merely on the surface of the iodide layer but are distributed throughout the microstructure of silver iodide, and when the silver iodide is dissolved with fixation, the image particles become vulnerable to abrasion. The different sensitivity of the iodine ring colours, and the observation that speed and contrast are affected by the colour of the silver iodide coating, as in the 60 and 120 second quadrants of DagTest 9-17-2011, may be explained by the spectral reflectance curves obtained from iodized plate samples, shown later in this section. The mercury veil that occurs with short sensitizing times, as in DagTest 9-17-2011, though not at all with plain polished silver, may also be explained using a new model for the nature of the coating. This coating has been described in terms of thickness, with yellow coatings being the thinner and blue coatings thicker. Scanning electron micrographs of iodized silver plates, also shown later in this section, provide evidence for a different interpretation of the iodide coating.

Irving Pobboravsky's Study of Iodized Daguerreotype Plates is the most cited work on sensitizing daguerreotypes with iodine. His thesis had three objectives; to measure the thickness of the silver iodide layer formed at various sensitizing times and therefore presenting different colours on the plate, to determine the cause of the observed colours, and finally to measure the photographic speed of the series of coating thicknesses (colours). I will address the first and third sections of his work, starting with the latter. Pobboravsky concluded that maximum sensitivity occurred with yellow-magenta coating, and that speed and contrast lessened as the colours advanced to blue and into the second and third cycle.²⁹⁵ Pobboravsky was able to quantify the relative speeds and contrast for his experiments using sensitometry, but he does not provide an explanation for why sensitivity and

²⁹⁴ Louis Jacques Mandé Daguerre, *History and Practice of Photogenic Drawing on the True Principles of the Daguerreotype*, Tr. By J.S. Memes. 1839: 19. The butterfly's wings analogy originates with Arago. In his report to the Chamber of Deputies, preceding the granting of a pension for Daguerre and Niépce, Arago states that the slightest touch will destroy the image. "But who ever thought of forcibly pulling a ribbon of lace or brushing the wing of a butterfly?"

²⁹⁵ Pobboravsky, "Study of Iodized Daguerreotype Plates." 1971: 54.

contrast changes with the coating colours.²⁹⁶ He briefly refers to John Draper's work with iodized plates in the introduction for the third part of his thesis, but he does not investigate spectral absorption related to iodizing colour or comment on the importance of this relative to the speed of daguerreotype plates.²⁹⁷ He introduces the following to show where his findings contradict Draper:

Draper found that the sensitivity of the plate was at a maximum when yellow; decreased to a minimum when blue, and reached a second maximum upon turning yellow again. In other words, plate sensitivity was directly related to blue light absorption by the silver iodide.²⁹⁸

Pobboravsky found that second cycle yellow coatings are twelve times slower than first cycle yellow coatings.²⁹⁹ Draper reported first and second cycle yellow coatings to have nearly the same sensitivity.³⁰⁰ The disagreement between Draper and Pobboravsky may have been related to the development method. Draper developed with mercury vapour while Pobboravsky used the Becquerel method. The twelve-fold loss in speed with second cycle yellow coatings that occur with the Becquerel method, but not with mercury development, is not related to blue light absorption, but an entirely different mechanism related to the nature of the silver iodide layer, as is explained later.

Nevertheless, absorption of radiant energy (light) explains the different sensitivities in first cycle coatings between yellow and blue. First cycle coatings conform to the Grothhuss-Draper Law of photochemistry that is, for light to produce an effect on matter, it must be absorbed. The specular reflectance curves (Fig.

²⁹⁶ Sensitometry is the science of quantifying the speed and contrast of photographic emulsions. In comparing the known contrast, in logarithmic terms, of a scene or step tablet against the result on photographic film, or in this case a daguerreotype, the contrast and speed can be determined according to ISO standards. Due to the extreme slowness of iodized plates, Pobboravsky chose to assign relative speed values to his samples rather than ISO (ASA) speeds.

²⁹⁷ John W. Draper, "On Some Analogies between the Phenomena of the Chemical Rays and Those of Radiant Heat." *London, Edinburgh, and Dublin Philosophical Magazine and Journal of Science* 19, no. 123 (1841): 195-210. This work was the foundation of the Grothhuss-Draper law of photochemistry. (Christian J.D.T. von Grothhuss and John W. Draper), The law is: for light to produce an effect upon matter it must be absorbed.

²⁹⁸ Pobboravsky, "Study of Iodized Daguerreotype Plates." 1971: 38.

²⁹⁹ Pobboravsky, "Study of Iodized Daguerreotype Plates." 47.

³⁰⁰ Draper, "On Some Analogies between the Phenomena of the Chemical Rays and Those of Radiant Heat." 1841: 207.

38) generated with spectrophotometer readings taken from iodized silver plates provide quantitative evidence that a 60 second, yellow-tinged-with-red coating of silver iodide reflects roughly half as much blue light as a 120 second, magenta-bluish coating.³⁰¹ When light strikes a solid surface at an angle it can be reflected, scattered, or absorbed. With a daguerreotype all three occur, so if light is not reflected, it must be either scattered or absorbed. There is a distinct dip in both reflectance curves at 420 nanometers, which is very close to the absorption coefficient for silver iodide (424 nm blue light) so the cause is most likely due to absorption rather than scattering.³⁰² By this reasoning then, if a 60 second, yellow-tinged-with red, coating reflects half as much blue light then it would absorb about twice as much blue light as the 120 second coating, and in keeping with Draper's law, plate sensitivity is directly related to blue light absorption. This is also supported by practical experience. Blue coatings require double or thrice as much exposure to achieve the same highlight brightness.

The reduction in contrast with longer silver-iodide coating time is also explained, in part, by these curves. There is a crossover point at 490 nm (blue-green) where the 120-second coating *may* absorb more green and yellow light than the sixty second coating. When the exposure is compensated for by the loss of speed with blue coatings, the additional exposure given yields more detail from green coloured and yellow coloured subjects, providing a smoother gradation of tones, but with less contrast and highlight brightness.³⁰³

³⁰¹ The X-Rite i1 Pro 2 spectrophotometer was designed for many tasks, one of which is making a colour profile for a digital projector, which means it is able to measure colours projected onto a screen from a distance. This feature also makes it possible to measure diffuse daylight incident and reflected from a sensitized plate at a 30° angle. In order to take these readings with the SpectraShop 4® software application, one has to choose "Emissive - Monitor" as the sample type. This is why the vertical axis of the graph is labelled Emission and is crossed out. I have changed the label it to read Specular Reflectance.

³⁰² Pobboravsky, "Study of Iodized Daguerreotype Plates." 1971: 8.

³⁰³ With blue coatings and tripple camera exposure, the green and yellow wedges of a test target colour wheel were rendered as a mid-tone value. The green and yellow patches of the wheel reflect about 5% of the spectrum below 430 nm, yet they appear about mid-tone grey. This method serves to extend the spectral sensitivity of silver iodide.

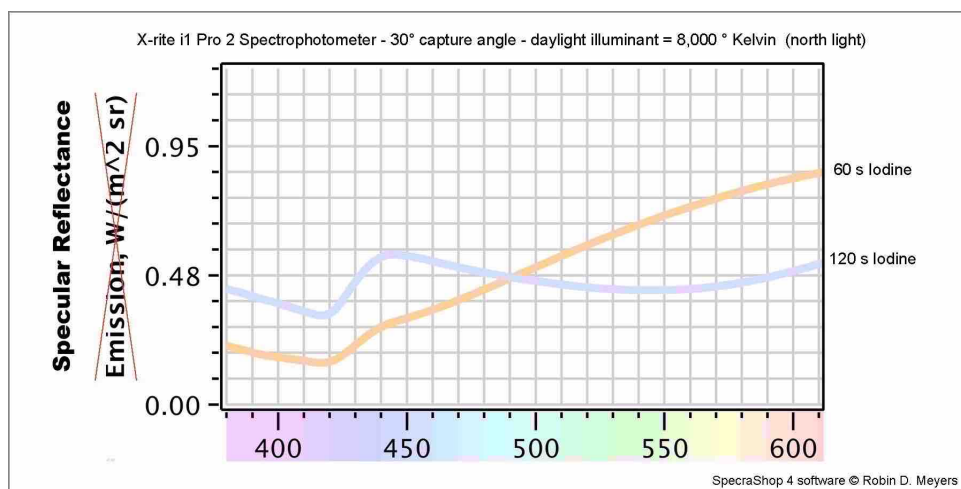

Figure 38. Specular reflectance curves for silver iodide coatings of 60 and 120 seconds.

The crossover of the two curves at 490 nm may also be due to an increase in surface roughness. In this case it is possible that some wavelengths longer than 490 nanometers are more affected by scattering or interference while shorter wavelengths are less affected by the same microstructure. The term microstructure refers to the nature of the silver iodide coating, for which I will now refer to the first part of Pobboravsky's thesis.

Pobboravsky was interested in determining the thicknesses of the different colours of silver iodide formed on the plate and developed a novel approach to find the answer. He prepared silvered plates and exposed them to iodine vapour ranging from 18 to 660 seconds to create samples which appeared to him yellow, magenta, and blue, in the first, second, and third cycles. He then coated the plate with a gelatine solution, which when dried could be peeled off the silver taking the silver iodide with it. The stripped samples were analyzed by two different methods to calculate the thickness of the silver iodide layer. Pobboravsky sent his samples to the Kodak Research Laboratories in Rochester to be analyzed with X-ray fluorescence. Though the technology was calibrated for photographic film and paper emulsions, it produced data in milligrams of silver per square foot from the silver iodide samples. Pobboravsky divided the molecular weight of silver iodide by the molecular weight of silver to convert the data into silver iodide thickness in

nanometers. The second method Pobboravsky used to determine the silver iodide thickness was to compare light transmission through his samples against the incident light intensity. He applied Bouguer's law which works on the transmission of light through a substance to calculate the thickness of his silver iodide coatings; hence the need to strip the iodide coatings from the plate.³⁰⁴

When light strikes a substance at a 90° angle it can be reflected back, scattered, absorbed or transmitted. Pobboravsky designed his test to account for back scatter and reflectance and was able to calculate the thickness of his silver iodide layers. Both methods provided fair agreement in thickness beyond first cycle blue, however, with coatings more in keeping with usual daguerreian practice (first cycle yellow to violet range) the absorption or Bouguer-Lambert law data indicated thinner layers than the X-ray fluorescence method, particularly in the light yellow range.³⁰⁵ Another, relatively simple means to estimate the coating thickness is to weigh the silver plate before and after sensitizing. The additional weight is due to the formation of silver iodide on the surface. The gain must be multiplied by a factor of 1.85 to account for the silver component of the silver iodide molecule. I polished and sensitized a half-plate of twenty-one square inches (135.5 cm²) surface area. Silver iodide has specific gravity of 5.7 g/cm³, so I calculated the thickness of three different coloured coatings from the weight of silver iodide gained.³⁰⁶ In 1839 Jean-Baptiste André Dumas, no doubt with the aid of a fine analytical balance, estimated the thickness of the yellow coating of silver iodide to be "less than a millionth of a millimeter".³⁰⁷ Table 2 provides a comparison of the three methods mentioned to determine silver iodide thickness.

³⁰⁴ "Beer-Lambert-Bouguer Law." In *McGraw-Hill Dictionary of Scientific & Technical Terms*. <http://encyclopedia2.thefreedictionary.com/Beer-Lambert-Bouguer+law>. (Date accessed, 28 Feb. 2015) The law is: The change in intensity of light transmitted through an absorbing substance is related exponentially to the thickness of the absorbing medium and a constant that depends on the sample and the wavelength of the light.

³⁰⁵ Pobboravsky, "Study of Iodized Daguerreotype Plates." 1971: 9.

³⁰⁶ I thank Irving Pobboravsky for his assistance in determining the conversion formulae.

³⁰⁷ "On the Discovery of M. Daguerre." *Chemist A Monthly Journal of Chemical and Physical Science* 1 (1840): 18-9.

Table 2. Silver Iodine *Thickness*³⁰⁸ comparison.

	Pobboravsky			Robinson	Dumas 1839
Colour	Bouguer-Lambert	X-ray Fluorescence	Colour	Weight Calculation	
light yellow	7	15.5			
light low saturation magenta	16	29.6	yellow magenta	16.4	< 1
magenta blue	36	40.3	magenta violet	39.1	
light steel blue	60	63.6	blue	57.6	
		Ag Thickness in Nanometers			

All of these methods to determine thickness only provide reliable results if the coating is *uniform and homogenous*. If the coatings are not uniform and homogenous, then the above findings are invalid. Uniformity, essential for even tones, is affected by the purity, cleanliness and polish of the silver plate. The sensitizing box design also affects uniformity, as discussed in the next section. Pobboravsky shows experimental evidence for a discontinuous layer with iodine coatings less than 80 nanometers. He also explains that the non-linear, increasingly greater time required to achieve the next progression of colour is reasonable if one assumes a discontinuous layer.³⁰⁹ Discontinuous layers by definition are not homogeneous. Though the terms ‘thickness’ and ‘coating’ are part of daguerreian lexicon, they do not accurately describe the nature of the silver iodide layer.

In 2011, I was able to find actual evidence of a discontinuous surface of silver iodide. DagTest 2-8-2011 (Fig. 39) shows scanning electron microscope (SEM) images of a polished silver plate along side plates with 30 and 120 seconds exposure to iodine vapour. The images show non-contiguous, irregular shaped particles of silver iodide on the surface.³¹⁰

³⁰⁸ I have used italics here because the term is invalid for describing silver iodide coatings.

³⁰⁹ Pobboravsky, "Study of Iodized Daguerreotype Plates." 1971: 29. Pobboravsky felt it "reasonable to expect a faster growth rate for a discontinuous film than for a continuous one in which growth rate is slowed because of diffusion through the iodide layer".

³¹⁰ The SEM model used for this analysis was the JEOL JSM-- 6380LV at Ryerson University. Qiang Li was the operating technician. The scanning electron beam tends to break the silver-iodide bond making analytical data unreliable. It is possible that a helium-ion microscope would provide greater resolution of undisturbed halide particles on a daguerreotype plate.

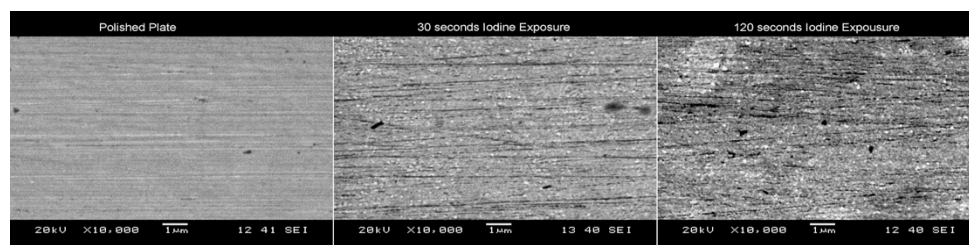

Figure 39. DagTest 2-8-2011. SEM images of silver iodide on daguerreotype plates.

An effective analogy to explain the sensitizing process would be to imagine the silver plate being represented as a rectangle of black paper and the formation of silver iodide to be salt shaken on the paper for increasing amounts of time. One shake would distribute a certain amount of grains on the paper, with a frequency, for example, of 20 grains per square centimetre. An additional shake would increase the frequency to 30 grains per square centimetre, with 10 new grains forming while some of the existing grains increase in size. As sensitizing progresses, less and less of the black paper can be seen between the grains. Therefore, a more accurate term to describe the silver iodide surface would be particle density. With 30 seconds of iodizing the particle density is 5~10 particles per square micron area, at 120 seconds the particle density increases to 8~15 particles per square micron. Particle density and particle size increases with iodine vapour exposure, so less free silver is available to react as iodizing times progress.³¹¹ The formation of silver iodide is a corrosive phenomenon, not a coating. The plate surface is roughened with iodine exposure as Pobboravsky noted, the surface of the SEM image of the 120 second coating appears rougher and visual evidence of this is that very fine horizontal scratches from the finishing buff can be etched enough to disappear.³¹²

The fogging that occurs with light yellow coatings and the loss of speed that occurs with the second cycle coatings with Becquerel development may be explained with this new model of halide particle formation. As has been discussed,

³¹¹ The same model holds true for silver-mercury amalgam particles in the development process (see DagTest 3-18-2011, p 311).

³¹² Pobboravsky, "Study of Iodized Daguerreotype Plates." 1971: 34.

mercury vapour does not form a white amalgam on plain polished silver, nor does it combine the silver iodide on the plate. It only reacts with latent image silver metal or silver from the plate surface. If the silver iodide particle density is too sparse, the mercury vapour is free to react with the base silver metal to form visible fogging, as the proportion of silver to mercury is more favourable for the formation of visible silver mercury amalgam particles. Mercury vapour does combine with plain polished silver because, proportionally, there is far too great a silver to mercury ratio to form visible amalgam particles. This silver-mercury ratio is important to keep in mind. More detail on this will be provided in the chapter on latent image development.

There is evidence to show that bulk silver metal from the plate acts as a sensitizer for silver iodide. Pure silver iodide, precipitated from solutions of silver nitrate, changes very little with sunlight, yet when formed on a polished silver plate it blackens in minutes. Furthermore, silver metal in contact with silver iodide may serve to extend the spectral sensitivity of the plate. Pobboravsky assumed his samples would not absorb light beyond 430 nm because this is true for pure silver iodide. He was surprised to find that his total reflectance curves were significantly lower than expected. The sum collected from his spectrophotometer for specular (reflected) and diffuse (scattered) light was less than the incident energy on his samples. As previously mentioned, light can be reflected, scattered or absorbed by a solid surface. Pobboravsky had to reconsider the possibility that absorption may account for the observed energy loss. "It had been assumed that absorption was zero for silver iodide over the wavelength range of 450 nm to 1300 nm. This must now be open to question".³¹³

The last point to address is the loss in speed, by a factor of twelve, between first and second cycle coatings reported by Pobboravsky. I have shown less blue light absorption as the cause of speed loss between first cycle golden-yellow and blue colours, though the increase in silver iodide particle density may also play a

³¹³ Pobboravsky, "Study of Iodized Daguerreotype Plates." 1971: 37.

minor role. DagTest 3-4-2015 was designed to determine if first and second cycle coatings appearing the same magenta-violet colour would have same sensitivity if mercury developed (Fig. 40). Both first and second cycle coatings appeared very similar, though in the second cycle, the magenta was more saturated. Specular reflectance readings agreed with my observation. The sensitivity between the two coatings is very similar to Draper's results, and contrary to Pobboravsky's findings. The dark values of the second cycle plate have been significantly reduced due to the greater surface corrosion from additional iodine exposure. Polished surfaces reflect light inversely to corrosion.

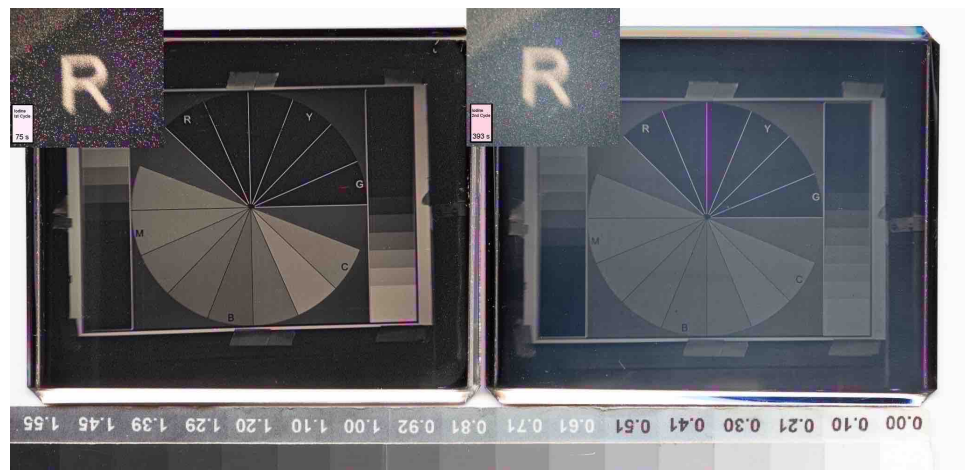

Figure 40. DagTest 3-4-2015. 75 seconds 1st cycle magenta-violet iodizing (left). 393 seconds 2nd cycle magenta-violet iodizing (right).

This is proved by the specular reflection curves (Fig. 41) for the seventy-five second (1st cycle) and 393 second (2nd cycle) layers. The first cycle coating has a higher specular reflectance across the spectrum. Absorption affects sensitivity, scattering affects perceived colour. The spectrophotometer geometry that has been set up to mimic darkroom practice provides a bonus for interpretation. The device only collects specular light, meaning as more incident light rays are scattered due to the roughened surface or particle morphology, less specular is light collected by the spectrophotometer, and so, the curve plots lower on the graph

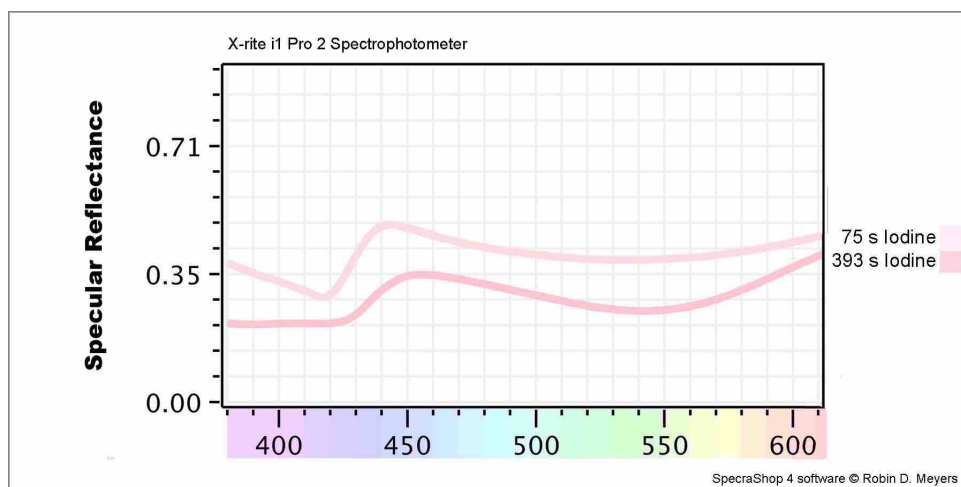

Figure 41. Specular reflectance curves for silver iodide coatings of 75 and 393 seconds.

The reason Pobboravsky noticed significantly slower second cycle speeds is due to proportionally less silver metal available from the plate surface with longer iodizing times due to increased silver iodide particle size and density. With Becquerel development, the latent image serves as a site for printing-out silver. The print-out reaction is photolytic, meaning the silver iodide bonds are broken by light energy to reduce the silver ions to silver. Newly released iodine ions then react with nearby available silver. With proportionally less silver available with second cycle coatings, the speed of the process is affected.

Pobboravsky was able to show experimentally that silver iodide layers were discontinuous and porous within first cycle layers though he believed that beyond 80 nanometers thick they were homogeneous. This conclusion however caused him to wonder why image particles dispersed on top of homogeneous thicker layers did not simply float away with fixation.³¹⁴ He reasoned that with porous, first cycle layers, the image particle could exist along side the silver halide grain, and be in contact with the silver substrate though he could not account for the adhesion of image particles created on homogenous layers after fixing. He felt fixation would dissolve the layer and undermine the image particle. An alternate understanding of the silver iodide layer is now possible. This work shows that silver halides are

³¹⁴ Pobboravsky, "Study of Iodized Daguerreotype Plates." 1971: 30.

formed in discrete particles rather than porous or homogenous coatings of a certain thickness, and explains why the image particles remain after fixation. Somewhat related, is my observation that the mercury image particles are secured by the iodine coating and are removed with difficulty by wiping. Once the silver iodide is removed with sodium thiosulphate (fixed), the image particles can be wiped off with the slightest touch, unless they are gilded.

I have shown evidence that the silver iodide is not a coating or layer of a definable thickness on top of the silver plate. Iodine reacts with the silver to form discreet nanoparticles of silver iodide distributed over the surface with a frequency of roughly 10~15 particles per square micron and the particles increase in size and density with iodine vapour exposure. This reaction is corrosive in nature, etching the silver in the process. The model I have described for silver iodide formation on a daguerreotype can account for all of the observations discussed in this section. With light yellow coatings, the silver-mercury ratio at the surface *between* the silver halide particles is able to support the formation of light scattering amalgam creating a veiled image. When the silver halide particle density reaches a fine point, fogging is prevented and maximum speed and contrast is achieved. The silver plate itself serves an integral role, first to provide silver for halide formation, but secondly to serve as a sensitizer for that halide. This is why the material quality of the silver plate can significantly affect sensitivity. If silver halide particle density increases beyond the ideal, then photographic speed is affected due to a reduction in free silver available to serve as a sensitizer.

The optimum sensitizing colour for silver iodide in terms of speed, tone and contrast was found to be at the first cycle magenta hue. This is true for all means of image formation, whether Talbot rings, Becquerel development, or mercury developed images. This is not surprising, as light absorption is affected by the coating colour, not development. Daguerre originally recommended golden-yellow, because it was the *quickest* coating of silver iodide but a few years later had

altered his recommendation to "rose violâtre" because this colour produced more pleasing contrast and tonalities.³¹⁵

This section has shown that iodine reacts with the silver plate to form discontinuous and discreet clusters of silver iodide on the surface, and that the frequency and size of these halide clusters affect photosensitivity. Furthermore, the ideal coating for optimum speed, tone and contrast is determined by the colour reflected from the plate during the process and spectrophotometry has been used successfully here to quantify that colour. Uneven hues in the sensitive coating will significantly affect the quality of the image. If a portion of the plate is magenta while another portion appears blue, darker image areas will occur in the less sensitive blue coloured regions. In practice, perfect uniformity of colour is very difficult to achieve during sensitizing because, as the next section shows, evenness is influenced by the design of the sensitizing apparatus used to apply the coating.

³¹⁵ Louis Jacques Mandé Daguerre, "On a New Mode of Preparing the Plates Destined to Receive Photographic Images." *The Chemist*, no. v. 5 (1844): 260-3. (Originally in *Comptes rendus hebdomadaires des séances de l'Académie des sciences*, April 22, 1844, p 762.) Daguerre described the colour as "rose violâtre" (pinkish violet). The descriptor magenta was adopted for this colour after the French victory at the Battle of Magenta in 1859. Violet and red are at opposite ends of the visible spectrum and when combined produce magenta.

4.4 Sensitizing with Iodine: The Sensitizing Box

When evaluating historic daguerreotypes, either for aesthetics or condition, it is important to be aware of the causes and effects of non-uniform sensitizing. Uniformity is affected by the condition of the silver plate, but it can also be affected by the sensitizing box design due to its materials, shape, and volume. The manipulations are so delicate that even the means of inserting the plate into the sensitizing box can affect the uniformity of the sensitive layer. The best designs iodize the plate with perfect uniformity, producing images free from voids, or localized tone and colour shifts. The evenness, or lack thereof, of the iodine coating is observed during the sensitizing process; as is the image quality that results from such a coating. This section will show how the sensitizing box design can influence image quality not only by the uniformity of the coating, but also by the rate at which the desired sensitizing colour is achieved.

Within the earliest sensitizing box design, fumes emanating from the iodine crystals gradually disperse into a uniform vapour seven inches above, at the plate surface. Daguerre included precise scale drawings of his camera and plate holder, sensitizing box and mercury bath in his manual.³¹⁶ Plate II, shows drawn to scale top and side views. The interior of the box is an inverted truncated rectangular pyramid with an iron cup to hold the iodine flakes. Mid-way up from this is an iron plate with lifting ring that serves as a lid to retain the iodine vapour when the box is at rest. Immediately under the lid are four wooden blocks in each corner that support the board to which the polished silver plate has been attached with silver bands and nails. In practice, the box lid is opened and the iodine cover is removed. The board with the plate attached is placed silver side down on the support blocks and the lid is closed. The interior volume of the box is roughly 4.8 litres.³¹⁷ This shape, volume, and distance from the iodine to the plate allows for

³¹⁶ Louis Jacques Mandé Daguerre, *Historique et description des procédés du Daguerreotype et du Diorama*. Alphonse Giroux et Cie ed. Paris: Delloye, Libraire, 1839. Plate II.

³¹⁷ Daguerre's precise drawings allowed me to extrapolate the interior dimensions from a digital scan using the measurement tools available in imaging software (Adobe Photoshop® CS5). With

the vapour to rise and expand to reach an equilibrium, thereby providing a uniform concentration at the daguerreotype plate surface. Figure 42 illustrates the iodine vapour distribution within the box.



Figure 42. Iodine box enhanced cross section, from *History and Practice of Photogenic Drawing*, 1839, Plate II (left). Illustration of vapour distribution (right).

The disadvantage with this plan is that the box must be opened to the atmosphere at the beginning of the sensitizing process, and every time the operator wishes to inspect the sensitizing progress for the desired colour. In doing so, the operator is exposed to iodine vapour, and once the vapour has escaped, additional time is required for the atmosphere inside the box to regain its saturation strength.

The time required to achieve the recommended golden-yellow coating with this box design varied with room temperature, from between five and thirty minutes

these measurements, I was able to determine the volume of an inverted rectangular truncated pyramid. I used an online calculator to simplify the procedure. See "Aqua-Calc: Conversions and Calculations." <http://www.aqua-calc.com/calculate/volume-truncated-pyramid>. (Date accessed, 19 Dec. 2013)

according to Daguerre's manual, and thirty for forty-five minutes from a later source.^{318 319}

My experience is that a five-degree increase in ambient room temperature, within a 70-85°F operating range, requires a corresponding ten percent reduction in sensitizing time. Lengthy sensitizing times limit the number of plates that can be tested under similar lighting conditions. Samuel F. B. Morse, working with much smaller plates and iodine box (a smaller volume box will sensitize plates faster) spent a frustrating afternoon on February 7, 1840 trying to make a daguerreotype with nothing to show for it at the end of the day but seven failures.³²⁰ Had he been using an iodine box like Daguerre's he would not have been able to make as many experiments. Repeated trials, under similar lighting conditions, eventually lead to improvement. This is shown in a series of vignettted sixth-plate portraits by Southworth and Hawes, circa 1850 (Fig. 43).³²¹

³¹⁸ Daguerre, *Historique et description des procédés du Daguerreotype et du Diorama*, 1839: 63.

³¹⁹ François Arago, "Physique appliquée. - Photographie." *Compte rendus hebdomadaires des séances de l'Académie des sciences*, no. Séance du Lundi 23 Décembre (1839): 824. Daguerre wrote his manual during the summer of 1839, the first copies becoming available in September. Three months later, on December 23, François Arago informed by Daguerre states the time required to achieve the golden yellow coating to be between 30 and 45 minutes with the "old" method. This discrepancy is likely temperature related.

³²⁰ Samuel Finley Breese Morse, "Notebooks---Photography, Art, and Miscellaneous." In *Samuel Finley Breese Morse papers, 1793-1944*: Library of Congress, 1840. Samuel F. B. Morse's handwritten notebook, *Memoranda of the Daguerreotype*, lists seven experiments on February 7, 1840 between 11:40 am and 4:40 pm. At this time of year his final exposure was 50 minutes long, lasting until after sunset. Each attempt resulted in failure - in Morse's hand, "results - Nothing!" He tried several plates with the same poor results most likely because on this day, he omitted the nitric acid for each trial. During previous experiments, while working with François Gouraud, he had spotting troubles using the nitric acid. In this early period before better polishing methods were known, nitric acid was the best way to ensure a chemically clean surface.

³²¹ Albert S. Southworth and Josiah J. Hawes, "Unidentified Woman." daguerreotype, ca. 1850. Collection of George Eastman Museum, Rochester, NY. I have had precisely the same experience in my studio. During a portrait session, it is usual that first plate, or two, indicate that adjustments are necessary in sensitizing for optimum image quality. Once this is established, I am able to finesse the pose.



Figure 43. Daguerreotypes by Southworth & Hawes, courtesy of GEM.

The first plate in the series has dark patches, showing the effect of uneven iodizing which produces less sensitive regions on the plate. The second image is an improvement in sensitizing, though not ideal, and the final two images have been evenly sensitized, and are variations in pose.

A third disadvantage of Daguerre's iodizing box is that the interior slanted walls are constructed of wood. With continued use, the side walls absorb iodine vapours that add to the sensitizing action. Daguerre acknowledged that a well used box works faster than a brand new one.³²² Unfortunately, the iodine saturated wood tended to iodize the perimeter of the plate surface more than the centre. Daguerre had a practical remedy for this problem. He attached the daguerreotype plate to the wooden board, which served to facilitate the transfer of the plate between the iodine box, the camera, and the mercury box, with bands made of silver, the same metal as the surface of the plate. These bands would absorb the excess iodine vapour emanating from the sides of the wooden box, to achieve a more uniform coating.

Daguerre, with the experience he learned from iodine saturated wood continued to improve his process throughout the autumn of 1839. François Arago reported near the end of the year that, with Daguerre's new method, sensitizing times are reduced from thirty minutes to two! This was accomplished, first by reducing the volume of the box, but more cleverly, by inserting a board of light coloured softwood into a groove within the shallow box, above the iodine crystals, and just

³²² Daguerre, *Historique et description des procédés du Daguerreotype et du Diorama*, 1839: 67.

below a groove that received the polished plate. The underside of the wood absorbed the iodine vapour while the box was at rest. To sensitize a plate, Daguerre simply withdrew the softwood board, flipped it over and reinserted it.³²³ Baron Séguier, nobleman, and member of the Académie des Sciences, who trained with Daguerre, adopted a slight variation of this system; his shallow iodine box had a wooden board faced on both sides with card, which absorbs iodine vapour more readily than wood.³²⁴ He inverted the panel when the card became depleted, to absorb more vapour from the iodine contained in the bottom of the box, while simultaneously providing a freshly iodized card to sensitize a plate on the opposite side.³²⁵ This improvement, introduced in France by Daguerre and Séguier, and relayed by Robert Hunt in England, was soon practiced in America.³²⁶ W. H. Goode, serving as chemical assistant at the University of New York in 1841, claimed that, "Iodization, however, can be effected with great uniformity by placing the frame containing the plate on a board impregnated with iodine, than by any other arrangement."³²⁷ The uniformity possible with this method is due to the very close proximity (one or two millimetres) between the iodine saturated board and the plate, which maintains a minimal static atmosphere between the two reagent surfaces. I have observed this during experiments with this method of sensitizing. Figure 44 shows that the silver iodide layer created is extremely uniform, except at the very perimeter. This is because the iodine absorbed area of the panel extended beyond the dimensions of the plate, giving an excess of iodine at the perimeter. (This is an excellent example of the delicacy of the iodizing process.)

³²³ Arago, "Physique appliquée. - Photographie." *Compte rendus hebdomadaires des séances de l'Académie des sciences*, no. Séance du Lundi 23 Décembre (1839): 824.

³²⁴ Quentin Bajac and D. de Font-Réaulx, *Le daguerréotype français: Un objet photographique*. Réunion des musées nationaux, Musée d'Orsay, and Metropolitan Museum of Art. 2003: 158-60. The still-life daguerreotype by Séguier, reproduced on page 159, has identical compositional elements (sculpture and drapery) as an image by Daguerre and another by Hubert, Daguerre's assistant.

³²⁵ Charles Chevalier, *Nouvelles instructions sur l'usage du Daguerreotype, Description d'un nouveau photographe, Suivi d'un mémoire sur l'application du brôme*. 1841: 33.

³²⁶ Robert Hunt, *A Popular Treatise on the Art of Photography, Including Daguerreotype, and All the New Methods of Producing Pictures by the Chemical Agency of Light*. Glasgow, 1841: 60.

³²⁷ W. H. Goode, "The Daguerreotype and Its Applications." *American Journal of Science and Arts* (1841): 137-44.

The panel is also depleted in absorbed iodine in the area that corresponds to the plate dimension, as indicated by the colour saturation in the centre of the panel. It is difficult to maintain consistency in sensitizing times by this method of plate iodization.



Figure 44. Iodine absorbed porous plastic panel (left). Iodized silver plate (right).

The iodine saturated board procedure was not adopted *en masse* because it was a cumbersome and slow way to sensitize a plate, and generally too impractical for the burgeoning demand of portrait photographers, who had to prepare plates quickly and frequently.

Daguerreian practice informed the reconfiguration of sensitizing boxes to be more compact and better sealed to maintain a saturated iodine atmosphere. The iodine was placed in a glass lined interior or porcelain pan with a sliding ground-glass cover to facilitate sensitizing plates in rapid succession. Within a French-made sensitizing box (c. 1845) the volume is only one-tenth that of Daguerre's original design.³²⁸ The reduced volume shortened the sensitizing times, however this design introduced another problem. When the interior wall dimensions are the same as the plate that is to be sensitized, and made of non-absorbing glass or porcelain, the perimeter of the plate does not receive the same level of sensitizing as the centre section. The effect of this can be seen in the following example. In 2011, I constructed a half-plate sensitizing box with a glass jar precisely the same

³²⁸ The Technology collection at the George Eastman House International Center for Photography in Rochester, NY has several examples of French-made sensitizing boxes. I measured the dimensions from one, GEM accession no. 77:131:20

dimensions as the silver plate with the intention of making it as compact as possible for air travel.³²⁹



Figure 45. Iodine coating simulation (left). *The Open Door*, daguerreotype, 2012 showing the effect of light iodine coatings on the perimeter (right).

When I used it to sensitize half-plates, the silver iodide coating was a very light yellow around the perimeter when the centre had reached the optimum coating colour (Fig. 45). The effect on the image is the same as the light yellow coatings in DagTest 9-17-2011 shown in the previous section; the result is fogged and devoid of an image around the perimeter. When I add a reducing mask to coat a smaller quarter-plate in the half-plate sized box, the reverse is true; the perimeter receives more iodine than the central surface.³³⁰ The effect of either too much or too little iodine near the edges of the plate would have been of little consequence in a nineteenth century portrait studio. Portrait daguerreians frequently chose medium to dark plain backgrounds to diminish the effects from uneven plate sensitizing, and the loss of uniformity around the perimeter, due to the box design was a minor inconvenience, set off by the speed and efficiency it offered.³³¹

A design feature that is typically American is a combined ground glass cover and frame that extends outside the box. The operator places the polished plate

³²⁹ The glass jar is assembled from six flat pieces of glass glued together. The finished interior dimensions for the iodine box jar are 4 x 5.25 x 2 inches deep. A half-plate of 4.25 x 5.5 inches is placed on top of the box, resting all four sides on a 1/8-inch wooden ledge, over a rectangular opening that matches the jar size. The ground glass cover is drawn out to expose the plate to the vapour.

³³⁰ A quarter-plate is 3.25 x 4.25 inches.

³³¹ The studio practice of taking likenesses against a medium dark background is the most commonly found background in nineteenth century daguerreotypes. Furthermore, the plate housing often had oval shaped mats that masked any perimeter defects from view.

into the frame and pushes it over the sensitizer. This differs from the French design, in which the plate is placed in a frame above the iodine and a ground glass slide is drawn out to expose the plate to the vapour. The earliest description of the American designed sensitizing box actually originates in England, described in "Beard's Apparatus for Taking Likenesses" published in *The Penny Mechanic* on May 1, 1841:

I place a square glass vessel, somewhat larger than the plate to be operated on, in a box made of wood, with a cover with an opening at each end, to allow a plate of glass to slide closely across, so as to permit of as little escape of vapour as possible; in the plate-glass slide being somewhat more than twice the length of the box, and in one part thereof, towards one end, an opening is formed through the glass large enough to receive the metal plate, yet not allow it to drop through; by this means the slide can bring the plate of metal directly over the box, in order that the vapours, as they arise, may come in contact with the silver surface, which is placed downwards, and in a few seconds it will be ready to be put into the reflecting apparatus, to receive an impression; or it may be put into a dark case for holding several such plates ready for use.³³²

John Roach, a New York Optician, began manufacturing this style of sensitizing box in 1842 (Fig. 46).³³³

³³² "Beard's Apparatus for Taking Likenesses." *The Penny Mechanic and Chemist: A Magazine of the Arts and Sciences* 1 (May 1 1841): 166-8. This review of the workings at Beard's studio appears in the May 1st volume of the *Penny Mechanic*, just a few weeks after the Beard studio opened at the Royal Polytechnic on Regent Street. The studio was operated by John Goddard, chemist at the Polytechnic and John Johnson, who arrived from New York the preceding October.

³³³ John S. Craig, *Craig's Daguerreian Registry*. 2nd Revised ed. Vol. I, Torrington, CT. 2003: 319.



Figure 46. Iodine coating box built by John Roach. National Gallery of Canada collection. LFA 21500_601_31.

The American sensitizing box having a “glass vessel, somewhat larger than the plate to be operated on” solved the problem of iodine starvation near the perimeter of the plate, but the push-through design introduced a new problem that was independent of plate size. In February 1843, J. M. Skegagur (sp) a New York daguerreian cautioned John Houston Mifflin from Savannah, Georgia:

To succeed and with certainty it is necessary that the plate be perfectly clean and well polished, that the coating be of a uniform hue or colour not in spots, if you slide the lid of chlorine box suddenly the gas is driven to one end, consequently one end of the plate will be more coated than the other, but by turning the plate you correct it, if you slide it softly, I have found it does not require turning.³³⁴

Occasionally even the most skilled have problems with vapour turbulence when sliding the plate into the sensitizing box. Southworth and Hawes of Boston often photographed their sitters with light backgrounds and presented their images with very narrow mats to show as much of the plate as possible. Photographing against a white background is a tremendous technical challenge that requires extremely

³³⁴ J. M. Skegagur [sp], "Letter to J. H. Mifflin Esquire, Fellow Daguerreian in Savannah Georgia." National Gallery of Canada collection, date Feb. 16, 1843.

even polishing and sensitizing, a true testament to their skill. A full-plate portrait of Reverend Neale, taken against a light background has undulating tones caused by eddies in the iodine vapour that likely occurred when the slide was pushed into the box too quickly (Fig. 47).³³⁵ Agitated vapour sensitizes the plate more rapidly than still vapour, and this is precisely what Mifflin was warned against.

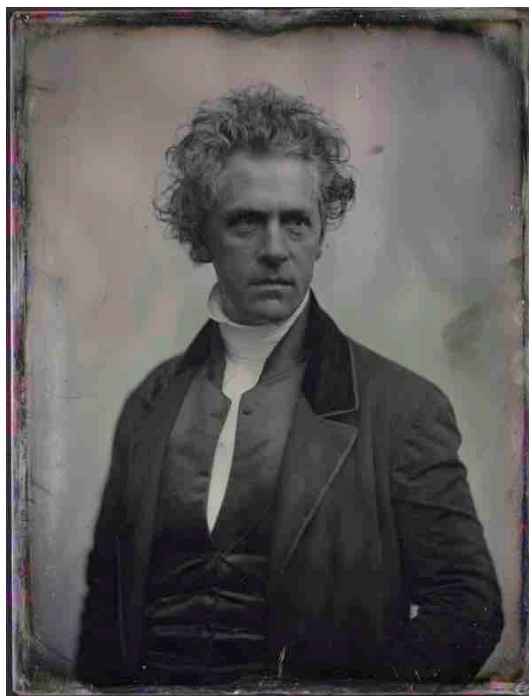

Figure 47. *Reverend Rollin Heber Neale*, Daguerreotype by Southworth & Hawes, courtesy of GEM.

Landscape views that involve skies particularly demand sensitizing uniformity for perfectly even tones; multi-plate panorama views being the ultimate challenge. When exposure times exceed a few seconds, a featureless blank sky is the result, though in reality it may have been filled with picturesque cumulous cloud formations against a blue sky. This area of uniform bright exposure on the plate will shift in hue or lightness according to shifts in sensitizing evenness. This defect, though it seems unkind to mention for such a monumental achievement, can be

³³⁵ Albert S. Southworth and Josiah J. Hawes, "Reverend Rollin Heber Neale." GEM accession number 1974:0193:0141.

seen in the first and second from the left plates of an eight full-plate panoramic view of the Cincinnati waterfront by Fontayne and Porter, taken in 1848.³³⁶

Jean-Baptiste-Louis Gros invented a sensitizing box design in 1850 particularly suited for work in the field. He constructed two shallow glass pans closed with a porous flat tile of half-fired porcelain. Sealed within one box was iodine, the other a combination of chlorine and bromine absorbed by slaked lime. The sensitizing vapours would pass through the porous tile and sensitize the plate. The system was designed for the challenges of sensitizing plates outdoors in the full light of day. Gros placed the shallow pans back to back in a wooden box with top and bottom adapted for the plate holders of his camera. The polished plates would be placed within the dark slides for the camera, these placed over the iodine box and the dark slide drawn out. Sensitizing would occur within the plate holder. This system allowed him to sensitize his plates on location, altering the sensitizing for successive plates if necessary. Gros wrote that his sensitizing boxes functioned without recharging for months, they were very compact, and being sealed, could be carried in any orientation without fear of chemical spillage. Baron Gros added a description of his experience with these boxes in the June 1850 (2nd edition) of *Quelques Notes sur la Photographie*, just having returned from a trip to Athens where he made many of his finest daguerreotypes:

The temperature of the place where one works, the thickness of the bisque, its greater or lesser porosity, the more or less considerable quantity of bromide or chloride de brome contained in the lime, the thickness of the layer of iodine or chloro-bromide of lime contained in the basins, necessarily affects the rapidity with which the fumes are released in the boxes and color more or less quickly the plate undergoing their action.

However, because it is by the color the plates take on that one judges the degree of their sensibility, there is no real inconvenience in using boxes that

³³⁶ Charles Fontayne and William S. Porter, "Cincinnati Panorama of 1848." 1848. Available online at <http://1848.cincinnati.library.org/showPlate.php?id=1&category=> . (Date accessed, 8 March 2015) I have also experienced this while making a five-plate panorama of the City of Pittsburgh. Over a two-year period, I made several tries. In 2006 my best effort showed uneven sky values across the five plates. I was able to create a more uniform view a year later with modifications to my sensitizing box.

are too slow except a loss of time, which is often precious. I also noticed that during the same day the same box became slower the more it was used and so I concluded that during the time off the fumes slowly filtered by the bisque deposit on its upper surface a light layer of iodine or bromine which evaporates more quickly than if it had not formed. Therefore one has to have at least two types of double basins if one wants to work quickly and make several images in a short time.³³⁷

Gros developed an ingenious solution to judge the sensitizing colours on his plate under the brilliant May sunshine in Athens, without the need for a darkroom. In the dark slide of his plate holder above one corner of the polished plate, Gros bored a hole into which he inserted a cone of wood painted white that terminated at the plate surface in a 4 millimetre diameter circle, the upper diameter about one centimetre. Gros could peer into the cone and judge the colour of the sensitive coating as it approached his desired hue, and be assured the entire surface of the plate was the same colour, as the bisque tiles sensitized the plates with perfect uniformity. Gros recognized that a small lentil-sized spot on his daguerreotypes would have to be sacrificed, the area being bright white or solarized after development. He invariably chose to frame his landscape daguerreotypes in octagonal mats to hide the affected corner. Gros' box design of 1850 was developed from experience, experimentation, and improvements to how the accelerating halogens were managed. The sensitizing boxes he used in 1846 for chlorine and bromine were completely different to what has just been described here, and are addressed in the next chapter.

Improvement in the design of the sensitizing box begins with Daguerre. He reduced its volume and introduced a wooden board that absorbed iodine vapour that when placed very close to the plate surface, eliminating the effects of gaseous turbulence, superabundance or shortness of vapour at the edges, and gave a very even layer of silver iodide. This however, as Gros recognized, resulted in longer sensitizing times with extra time required for the saturated boards or porous

³³⁷ Jean-Baptiste-Louis Gros, *Quelques notes sur la photographie: Sur plaques métalliques*, revised 2nd edition, July 1850 ed. Paris: Roret, 1850: 50. This description is not in the first edition that was printed in January 1850, before Gros' trip to Greece.

bisques to regain their sensitizing power. It was the ideal design for landscape work where tonal qualities were more important than the speed of operation. In a busy portrait studio, the American 'push-through' designed box was the ultimate compromise for speed and efficiency. The glass jar was intentionally made slightly larger than the plate size to minimize perimeter iodine weakness. When reducing frames were used for smaller plates, super saturation of the perimeter was unavoidable. This resulted in a slight natural vignetting (darkening) toward the edges as thicker iodine coatings have been shown to be less sensitive. This is not necessarily bad for portraits. The vignetting that results from coating small plates in boxes built for larger ones partially explains the daguerreian's preference for medium to dark backgrounds in portraits as this shade tends to minimize tonal variations in the finished image due to uneven sensitizing.

4.5 Sensitizing with Iodine: Conclusion

I have shown that Daguerre recognized the tremendous speed advantage that silver iodide formed on silver plates had over all other light sensitive materials he and Niépce had tested. This, combined with evidence that Daguerre also understood that different colours of iodide coatings on plates were not equally light sensitive, and that light decomposes silver iodide, is evidence that he came to use iodine as a process as a result of scientific inquiry rather than by accident.

Through modern experiments, I explicitly show that the colours of silver iodide are not equally light sensitive by recording these colours for comparison with the resulting image. Pobboravsky regretted that the spectrophotometer could not imitate the illumination-collection geometry used by observers when viewing the iodide surface and the data obtained did not accurately reproduce the observed colours. I have developed a method to use an X-rite spectrophotometer and SpectraShop[®] software to record spectral data that does imitate the same viewing geometry used by observers during the sensitizing process, and reproduces the colours accurately as seen. This solves the difficulty reported by Schreiner with clearly identifying a particular colour of silver iodide and relaying the information.

Reflection and absorption spectra obtained from these readings have partially explained the relative sensitivities of the differently iodized plates. The different sensitivities of silver-iodide colours are primarily due to their ability to absorb actinic light. Blue coatings in Talbot's rings experiment appear blue in part because they do not absorb blue light, and so they are barely affected by light exposure. Silver iodide has an absorption peak at 430 nm and this is indicated by a dip in the reflection spectra obtained from my samples. The spectra from yellow appearing coatings indicate roughly twice the absorption of 430 nm light than blue coatings. This explains the loss of photographic sensitivity with blue appearing coatings which agrees with the Grotthuss-Draper law that spectral energy must be absorbed for a chemical effect to occur. I have reconciled and explained the discrepancy between Draper, who reported that second cycle yellow coatings were equally as

sensitive as first cycle yellow coatings, and Pobboravsky who determined second cycle coatings to be twelve times slower. My tests have validated Draper's work in that that first cycle coatings have roughly the same sensitivity as second cycle coatings of the same colour when developed with mercury vapour. With second cycle coatings however, the blackness of the shadow values are compromised by excessive iodine corrosion of the polished plate. The reason Pobboravsky's findings were contradictory is that he used the Becquerel print-out method to develop his experiments rather than mercury development.

Experiments to determine the optimum iodide coating for speed, tone and spectral sensitivity have shown the effects of under and over iodized plates. These experiments are the first to show overall fogging with under iodized plates developed with mercury vapour. Scanning electron microscopy of silver iodized plates indicates that the silver iodine coating is comprised of discreet amorphous particles that increase in size and frequency with increased iodine exposure. Pobboravsky thought the iodized plate to be a layer of a specific thickness, beginning as discontinuous and gradually filling in to a uniform coating. The new mechanism I propose is more accurately described as that of increasing particle density rather than an increasing thickness of silver iodide as the iodizing step progresses. This model is able to explain the fogging observed in the lightly iodized quadrants of DagTest 9-17-2011. This observation leads to a clear understanding of the effect of insufficient iodizing due to the design of the sensitizing box.³³⁸

The design of the sensitizing box in creating uniform tones across the image is important to understand. I have shown with modern examples that the perimeter of the plate will often be over or under coated in relation to the centre of the plate depending on the design of the sensitizing box and this can lead to veiling of the

³³⁸ Daguerre, even after his pension was secured, continued his efforts to improve the iodizing process by substituting a pine board saturated with iodine vapour for his original high volume coating box. This reduced the time to iodize a plate from thirty minutes to two, which greatly increased the number of trials one could perform under similar lighting conditions. This small change alone very likely did much to increase the chances of success for those new to the art.

perimeter with less iodine or loss of sensitivity with excess iodine. Excess perimeter coating is not necessarily an issue for portraiture because a natural vignetting occurs with the loss of speed as the iodide colour transitions from magenta to blue. Furthermore, it could be argued that the oval mats commonly employed in daguerreotype enclosures tend to hide the effects of uneven iodizing.

It is important for curators or caretakers of historic daguerreotypes to understand that the veiled effects on images are sometimes due to insufficient iodine around the perimeter, or that mottled tones in the background are due to turbulence in the vapour created by sliding the plate over the iodine too quickly. Both of these conditions are inherent in the making of the plate, not as what might be assumed without the knowledge provided here, due to image deterioration. Images with misunderstood condition issues are at best withheld from display or at worst subject to unnecessary conservation treatment.

Both issues, perimeter uniformity and turbulence in the vapour, were solved by Baron Gros' design for sensitizing boxes intended to be used away from the studio. The half-fired bisque tiles that retained the sensitizing chemicals allowed for the vapours to permeate through them very evenly. Gros' design allowed him to sensitize his plates while in the camera plate holder, eliminating the need for a darkroom. Thus, he was able to sensitize and develop his images under the full light of day in Athens, which was a significant and practical improvement to his working methods.

The sensitizing process was soon accelerated with other halogens. By 1841 chlorine was combined with iodine to increase photosensitivity by a factor of five or ten, and a few years later bromine was introduced in a manageable way to improve Daguerre's process, reducing exposure times from minutes to seconds.

5.1 Sensitizing Accelerators: Overview

Sensitizing a daguerreotype plate with iodine is a relatively simple process; when the optimum coating is formed on the plate, its response to light is quite predictable. The adoption and successful use of chemical accelerators such as chlorine and bromine was a gradual process involving complicated and precise combinations of these halogens to ensure repeatable results. Elemental iodine is solid, bromine a liquid and chlorine is a gas at room temperature. Iodine, used in its solid state, provides a stable and consistent vapour concentration within the sensitizing box. A well-built sensitizing box with a good hermetic seal containing fifty grams of iodine crystals, for example, will last years before recharging is necessary. Chlorine and bromine vapours are far more challenging to manage due to their greater volatility in liquid and gaseous states. Furthermore, they must be used in a very dilute form, which introduced new complications to the process. It was extremely challenging to maintain the same vapour concentration for each experiment as the accelerants, when used in dilute form, constantly lost their strength. Chemical acceleration increased the sensitivity of the daguerreotype plate by a factor of sixty or more when optimized, and any variance in the admixture of chlorine and/or bromine to the iodine coating resulted in an unpredictable change in sensitivity.

This chapter opens with the first experiments in chemical acceleration in the Holborn District of London in the early 1840s. It explains the differences in terms of speed, tone and manageability between chlorine and bromine, the two principle halogens used for acceleration, and how and when they were introduced into practice. Next, the section on managing bromine, much more volatile than chlorine, provides evidence for its delayed introduction into the art, a delay contrary to the perception gleaned from the literature that bromine and chlorine were introduced almost simultaneously by Goddard and Claudet. The chapter concludes with the most advanced acceleration methods of the 1850s that combine bromine with chlorine with lime, otherwise known as dry sensitives, and

their effect on speed, tone and spectral sensitivity, the main focus of this dissertation.

Modern daguerreotype experiments presented in this chapter explicitly reveal how photosensitivity changes between plates sensitized with iodine alone, iodine with chlorine, and iodine with bromine. They also show significant tonal differences between plates accelerated with chlorine and plates accelerated with bromine as practiced before 1844. Experiments made to replicate 1841-1844 practice were conducted with a vintage lens-based (refracting) camera ca. 1841 and an exact replica of Wolcott and Johnson's mirror (reflecting) camera of 1841, which provide insight into the advantages and limitations of the competing optical systems used by Antoine Claudet and Richard Beard in London's first studios.

Obscure references reported by Daguerre in 1844 and by Robert Cornelius in 1842 refer to the application of noble metals (gold and platinum) to the plate before sensitizing. This little-known technique, now understood through replicative tests, was to mitigate bromine veil and improve image quality during the incunabula period when bromine was difficult to control. Daguerre's manipulations with gold were complicated, and Cornelius' method is known merely from a single line in a journal, void of practical information.³³⁹ I have verified with modern experiments the practicality of applying gold to the daguerreotype plate in advance of sensitizing, thereby proving the utility of their process, and providing a new understanding of each man's inventiveness that heretofore has been overlooked.

Baron Gros' inventiveness is also shown, including a 9-variable sensitizing test, described in his 1850 treatise, and replicated in this chapter. The test provides explicit evidence of the differences in speed, tone and contrast obtainable with different combinations of iodine and chloro-bromine. In replicating Gros' test I have recorded the sensitizing colours on the plate digitally, and with a

³³⁹ American Philosophical Society, *Proceedings of the American Philosophical Society*. Vol. II: American Philosophical Society., 1842: 150. This reference from *Proceedings of the American Philosophical Society* is discussed later in this chapter.

spectrophotometer, to show a direct relationship between the final image in terms of speed, tone and contrast and the colour of the sensitive coating.

5.2 Sensitizing Accelerators: Introduction

It is a logical idea to add chlorine or bromine to the daguerreotype process to increase photosensitivity based on the reaction to light of these silver salts when applied to paper. Dr. John William Draper of Virginia, who had been investigating the decomposition of silver salts by sunlight two years before the daguerreotype was announced, observed the relative sensitivities of silver chloride and silver bromide. Draper wrote in his laboratory notebook, on June 14, 1837, "I have corroborated the assertion of Berzelius that Bromide blackens more readily than the chloride".³⁴⁰ Draper noted that bromine and chlorine worked faster than iodine with silver on paper.³⁴¹ Thus, it was reasonable for daguerreians to assume that these chemicals alone or in combination would speed up the process.

The adoption of chemical accelerators into the sensitizing process is a more complicated story than what has been previously written. The impression one gets from histories of photography is that the reliable and quick-working chemical acceleration methods of the 1850's were the techniques and materials used in 1840. Beaumont Newhall, in *The History of Photography* for example, explains in one paragraph, "The thought had occurred to many and had been tried by many, but it is clear that the first to publish a practical method was John Frederick Goddard".³⁴² Timm Starl in *A New History of Photography* includes along with Goddard, his countryman, Antoine Claudet and Austrian, Franz Kratochwila as the "three who finally achieved significant improvements".³⁴³ This conclusion he bases

³⁴⁰ Draper, John W. "Chemistry and Physics Experiments [Manuscript]: Journal, 1836-1842." In *Draper Family Collection*, National Museum of American History Smithsonian Institution. Washington DC: Dibner Library: MSS 001672 B quarto. I am indebted to Dr. Greg Wickliff for this reference in his presentation, "John William Draper's Experiments in Light, Photography and Publishing." In *The Twenty-second Daguerreian Society Symposium*. Atlanta, GA, 2010.

³⁴¹ John W. Draper, "Experiments on Solar Light, Decomposition of the Salts of Silver." *Journal of the Franklin Institute* 20 (1837): 45.

³⁴² Beaumont Newhall, *The History of Photography: From 1839 to the Present*. Fifth ed.: Museum of Modern Art, 1982: 29-30.

³⁴³ Timm Starl, "The Use and Spread of the Daguerreotype Process." In *A New History of Photography*, edited by Michel Frizot, 39-40. Köln: Könemann, 1998: 39-40. Starl is mistaken in his date for Kratochwila's reported use of bromine and chlorine. The article appears in *Wiener Zeitung*, on January 19, 1841, and Starl has the year at 1840 of the same date. The correct date is

on published accounts of their discoveries. Missing from this list are Philadelphians Robert Cornelius and Dr. Paul Beck Goddard (no relation to John F. Goddard) because they preferred to keep their discovery secret for commercial advantage.³⁴⁴ As acceleration methods affect speed, tone and contrast differently, three factors central to this dissertation, it is important to understand how these chemicals and processes evolved during the 1840s. This understanding will provide a better means to interpret images made during the first decade of photography, based on their *look*, when no additional information is available.

My aim here is not to revisit priority of discovery; rather, it is to emphasize three points that have not been addressed. Firstly, Goddard did not experiment alone; he worked alongside others in a small newly formed photographic community around Holborn Bars, London in 1840. Secondly, chlorine and bromine have been perceived as similar and interchangeable for their quickening action on the daguerreotype.³⁴⁵ My experiments, discussed later in this chapter, show that this is not true. Finally, though significantly faster than chlorine, bromine when introduced was much more difficult to use reliably as the plates would frequently be veiled, or solarized. It took five more years of progressive development to reliably manage bromine vapour.

Daguerre in 1844, and Baron Gros as late as 1846, developed complicated procedures to address the veiling problems associated with using bromine.^{346 347} Edmond de Valicourt, author of several technical manuals, explained that bromine was far more manageable by the end of 1847 when it became common practice to

confirmed in an 1841 article by Professor Berres of Vienna. See Berres, Dr. Josef. "Neue Aufschlüsse Über Das Daguerreotyp". *Polytechnisches Journal* 81, no. XLIII (1841): 149-57.

³⁴⁴ M. Susan Barger and William B. White, *The Daguerreotype: Nineteenth-Century Technology and Modern Science*. 2nd ed. Baltimore: John Hopkins University Press, 2000: 34.

³⁴⁵ Goddard published the use of bromine on December 12, 1840, Kratochwila the use of chlorine and bromine on January 19, 1841, and Claudet revealed the use of Chloride of Iodine on June 10, 1841. Each of these sources claim that daguerreotypes can be made between five and fifteen seconds outdoors, compared to four or five minutes using the original process.

³⁴⁶ Louis Jacques Mandé Daguerre, "On a New Mode of Preparing the Plates Destined to Receive Photographic Images." *The Chemist*, no. v. 5 (1844): 260-3.

³⁴⁷ Charles Chevalier, *Recueil de mémoires et de procédés nouveaux concernant la photographie sur plaques métalliques et sur papier*. Charles Chevalier, 1847:1-15.

apply a second dose of iodine vapour after bromine to eliminate the tendency to veil or fog the plates.³⁴⁸ He expressed his displeasure that this new information was being sold as part of the American Process for 500 francs by some “charlatan” to French daguerreians, while it was originally published by their own countryman, Professor C. Laborde in 1844.³⁴⁹

As just noted, the early bromine process was not a practical method readily adopted upon Goddard’s notice in the *Literary Gazette* on December 12 1840. Newhall and Starl give the impression that halogen acceleration was fairly well established by the start of 1841 and that acceleration methods were fixed for the duration of the daguerreian era. This impression can lead to inaccurate conclusions when dating daguerreotypes. Ken Jacobson, Ruskin scholar and daguerreotype collector, notes that curators, cataloguers, dealers, and historians, in the absence of precise documentation, tend to assign arbitrary dates for daguerreotypes based on their appearance, and that the task is “somewhat easier for early 1840s images” due to the look of the plate and the style of the framing.³⁵⁰ The consequence of this strategy, when applied to daguerreotypes, and a problem for historians in general without a clear understanding of the materials and methods of their production, is that they may assign an earlier than actual date for the object in question. Daguerreotypes are often deemed early, primitive, or from the incunabula period solely by the tones of the plate and its housing. For example, a daguerreotype of Greenwich Hospital in a simple ruled paper housing appears to be taken in late 1839 or 1840 based on the muted tonality of the plate

³⁴⁸ Edmund de Valicourt, *Nouveau manuel complet de photographie sur métal, sur papier et sur verre*. Roret, 1851: 68-9. The charlatan Valicourt referred to was Warren Thomson, recently from Philadelphia. The other two aspects of the ‘American Process’ was galvanizing additional silver onto the plate and the use of buckskin for polishing.

³⁴⁹ C. Laborde, “Moyen certain de prévenir le voile des substances accélératrices, et de donner plus de sensibilité à la couche impressionnable.” *L’Echo du monde savant, travaux des savants de tous les pays dans toutes les sciences*. 11, no. 13 (Jeudi, 15 Août 1844): 304.

³⁵⁰ Ken and Jenny Jacobson, *Carrying Off the Palaces, John Ruskin’s Lost Daguerreotypes*. London: Bernard Quaritch Ltd., 2015: 227. In footnote 88, the Jacobson’s are providing context for their trove of Ruskin daguerreotypes produced between 1845 and 1858.

and the crude polish.³⁵¹ Another English architectural view of the Folkestone railway viaduct, in a similar housing with the same handwriting on the edge of the plate as the Greenwich Hospital image seems very likely to be by the same maker.³⁵² It has similar muted tonalities that lead one to believe it is also from 1839 or 1840, however the construction of the Folkestone railway viaduct began in the summer of 1843. The date of these daguerreotypes (Fig. 48) illustrate that plate preparation and chemical acceleration were still evolving in 1843, given that the mature sensitizing process using bromine with second iodizing generally yields clearer, brighter, and warmer tonalities.



Figure 48. *Greenwich Hospital*, National Gallery of Canada collection. LFA 21500_160_5 (left). *Folkestone Viaduct*, R. P. S. Collection 2003-5001/2/28227 (right).

These plates are not among the earliest British scenes, those being views by J.T. Cooper of the Polytechnic and Michel de St. Croix in the autumn of 1839 as discussed (see Chapter 3, p 91). What the Folkestone viaduct view shows is that by the latter half of 1843, plate acceleration methods were not as fully resolved as Newhall and Starl have implied in their histories.

³⁵¹ Jabez Hogg (attributed), "Greenwich Hospital." daguerreotype, c. 1842. National Gallery of Canada collection, LFA 21500_160_5.

³⁵² Jabez Hogg (attributed), "Folkestone Viaduct." daguerreotype, c. 1843. Royal Photographic Society Collection at the National Media Museum, Bradford. Cat. no. 2003-5001/2/28227. Online at [http://www.daguerreobase.org/en/collections/indeling/detail/start/225?f_string_collection_name\[0\]=Royal+Photographic+Society+Collection+at+the+National+Media+Museum,+United+Kingdom](http://www.daguerreobase.org/en/collections/indeling/detail/start/225?f_string_collection_name[0]=Royal+Photographic+Society+Collection+at+the+National+Media+Museum,+United+Kingdom) (Date accessed, 3 May 2014). The Daguerreobase website was established in 2012 specifically for European daguerreotypes. The site includes an online quarterly journal.

The next section covers the span between 1839 and 1843 and proves that the sources cited by historians that promote John F. Goddard as the discoverer of bromine are unreliable having been altered to strengthen the argument on his behalf. I reveal the means of chemical acceleration developed by Goddard for the Beard Patentee holders, never before published as it was closely guarded for patent and licensing concerns, and that he was not solely responsible for it, having been influenced by technologies imported by Wolcott and Johnson of New York in America, and further developed by a small interconnected community at Holborn Bars, London.

5.3 Sensitizing Accelerators: Holborn District

This section is concerned with the introduction and advancement of chemical acceleration in the Holborn District, which begins in 1840, and illustrates the relationships between the key figures involved; Claudet, Beard, John and Wm. Johnson, Goddard, and the patent agents Carpmael and Berry. Michael Pritchard, in his dissertation about the development and growth of the British photographic industry, briefly touches on the early days of the daguerreotype in London. He covers the optical and scientific firms pre-dating 1839, and in terms of daguerreotype practice he discusses the patent dispute between the first two established London portrait studios; Richard Beard's Photographic Institution, which opened on the roof of the Royal Polytechnic Institute on March 23, 1841, and Antoine Claudet's Adelaide Gallery studio which opened soon after in June in the Strand.³⁵³ He does not address the daguerreotype experiments of 1840-41 using chlorine or bromine, crucial for the success of daguerreian portrait studios, which has been complicated by patent concerns, and the fickle nature of bromine. John Johnson put it, "The whole story" is too jumbled a mass to pass for history of "great interest" or contribution to the "History of Photography".³⁵⁴

Antoine Claudet, Miles Berry, Richard Beard, William and John Johnson (father and son), and John F. Goddard were key figures in the experiments and events of 1840 and 1841 that lead to the opening of London's first portrait studios. These experiments made after the Royal Polytechnic and Adelaide Gallery demonstrations in the fall of 1839, and before the first commercial studios were established in the same buildings, occurred along a *less than 400 metre* stretch of road in the Holborn District; essentially the birthplace of commercial photography in London. A map (Fig. 49) of this area is keyed with the names and business

³⁵³ Michael Pritchard, "The Development and Growth of British Photographic Manufacturing and Retailing 1839-1914." De Montfort University, 2010: 48-65.

³⁵⁴ Antoine Claudet, "Letter to Mr. P. Foster." *The Philadelphia Photographer*, no. V (1868): 174-7. Claims made by Claudet about the early history of photography (in a letter to Foster), printed in the *British Journal of Photography* were read before a meeting of the American Institute. In attendance was John Johnson whose verbal rebuttal was recorded by C. W. Hearn and printed in the above journal, and in the *British journal, The Photographic News*, (August 21, 1868): 404-5.

locations for the people involved.³⁵⁵ The map significantly shows that Claudet & Houghton and the patent agents Berry and Carpmael are literally neighbours and just down the street are Beard and Johnson's experimental studio and Dymond & Company operative chemists, who likely would have provided or compounded the bromine and chlorine used by everyone in the neighbourhood. Mr. Turner, chemist at Dymond & Co. prepared the chloride of iodine for Johnson and quite likely provided the retort apparatus and instruction to both Goddard and Claudet for the preparation of their compounds.³⁵⁶



Figure 49. Holborn District (detail). *The Fascination of London: Holborn and Bloomsbury*.

³⁵⁵ Sir Walter Besant and G. E. Mitton, *The Fascination of London: Holborn and Bloomsbury*. Adam and Charles Black, 1903. Project Gutenberg <http://www.gutenberg.org/files/21411/21411-h/21411-h.htm> (Date accessed, 13 April 2013)

³⁵⁶ Charles W. Hearn, "New York Correspondence." *The Philadelphia Photographer* 5, no. 53 (1868): 176. Hearn transcribed John Johnson's reminisces of his experiments with chloride of iodine. "To this end I worked diligently, succeeding, by the discovery and application of chloride of iodine, in effecting the desired result, toward the close of November or early in December, 1840—Diamond [sic] & Co. (per Mr. Turner), of Holborn Bars, London, preparing whatever was ordered for my use."

Claudet, a Frenchman by birth, partnered with George Houghton at Claudet and Houghton's crown and sheet glass warehouse at 89 High Holborn on the south side of the street. Claudet, on the urging of his friend and optician, Lerebours, attended one of Daguerre's public demonstrations in the fall of 1839 where he learned the process.³⁵⁷ He claimed to have purchased a licence directly from Daguerre at that time,³⁵⁸ though the earliest mention of a licence is from an advertisement placed in the London Times, dated March 3, 1840:

The sole right of making, using, exercising and vending this important discovery in England being secured by Her Majesty's royal letters patent, granted to Mr. Miles Berry, of the Patent-office, Chancery-lane. Messrs. Claudet and Houghton, 89 High Holborn, beg leave to announce that having obtained a licence from the patentee, they have on hand a collection of splendid specimens of this wonderful discovery...Injunctions will be taken against any person possessing apparatuses, making use of them, or selling proofs without licence or the authority of the patentee. Direction — Claudet and Houghton, 89, High Holborn.³⁵⁹

The timing of the advertisement coincides precisely with of the arrival of William S. Johnson, a New Yorker who set sail on February 4 and landed in London near the end of the month. Johnson's purpose was to promote and patent a newly designed daguerreotype camera for portraits, invented by Alexander S. Wolcott, his son John's partner. This lensless camera used a concave mirror mounted in the rear to focus reflected light onto the sensitized plate; a design borrowed from a reflecting telescope. On the morning of October 6, John Johnson brought newly received information on Daguerre's process to Wolcott, a dentist's mechanic, and optician. Johnson agreed to source the silver plate and iodine, while Wolcott designed and built a prototype camera for taking portraits. Rather than use a lens,

³⁵⁷ Karen Hellman, "Antoine Claudet, a Figure of Photography, 1839--1867." PhD, City University of New York, 2010: 4.

³⁵⁸ Claudet, "Letter to Mr. P. Foster." (1868): 174. This point has been debated and contested by Arthur Gill and R. Derek Wood because there is no documentary evidence to prove it. See Gill, Arthur. "Wolcott's Camera in England and the Bromine-Iodine Process" and Wood, R. Derek, "The Daguerreotype Patent, the British Government, and the Royal Society." published in *History of Photography*, July 1977 and January 1980 respectively.

³⁵⁹ "The Daguerreotype; or, Nature Delineated by Herself." In *Times*. The Times Digital Archive London, Tuesday, March 3, 1840: 3.

Wolcott borrowed a concave mirror from his Gregorian telescope to focus the light on a tiny silver plate not quite three-eighths of an inch square. On the very day and the next they had produced a successful, tiny profile portrait of Johnson, who had to sit motionless in the well lit attic room for five minutes.³⁶⁰ A full-scale camera with an eight-inch concave mirror was completed by the year's end. It produced images on plates 2 X 2 ½ inches and reflected roughly thirty times more light than what was refracted through Daguerre's achromatic lens.

Perhaps, with the arrival of Johnson and his camera, Claudet and Houghton deemed it important to assert their right in the press. Johnson senior was introduced to Richard Beard by Mr. Carpmael, a patent agent in competition with Miles Berry, whose offices were in Lincoln's Inn, immediately behind Claudet and Houghton's shop.³⁶¹ According to John Johnson, the Wolcott reflecting camera was first exhibited in London on March 23, 1840.³⁶² Claudet may have learned of the Wolcott camera from this exhibit because he immediately extended his own licence on March 25 by purchasing an indenture for £200 for the use of three cameras in Britain.³⁶³ Prior to buying the indenture, Claudet put forth a proposal to the Royal Society, and Berry simultaneously appealed to the Treasury to buy Daguerre's patent in England outright and allow the process to be practiced without restriction, as had occurred in France.³⁶⁴ It is for this reason that Claudet added a

³⁶⁰ John Johnson, "Daguerreotype." *The Daguerreian Journal*. Vol. 2 (1851): 56-57.

³⁶¹ Letters from Carpmael, patent agent to W.H.F. Talbot, confirm the Lincoln's Inn address. See "The Correspondence of William Henry Fox Talbot." Leicester: DeMontfort University. Online at <http://foxtalbot.dmu.ac.uk/letters/transcriptFreetext.php?keystring=Carpmael&keystring2=&keystring3=&year1=1800&year2=1877&pageNumber=9&pageTotal=77&referringPage=0> (Date accessed, 3 May 2012)

³⁶² "Photography at the American Institute." *The American Journal of Photography and the Allied Arts and Sciences* Vol. 1 (1858): 10. Johnson was quoting directly from his partnership ledger from the Wolcott and Johnson firm.

³⁶³ W. Newton, *The London Journal of Arts and Sciences, and Repertory of Patent Inventions*. Sherwood, Gilbert, and Piper, 1843. This journal reports the patent law dispute between Beard and Claudet and the judgment. Claudet, on March 25 extended his licence to enable him to use of three cameras, much like additional licences are required today to use computer software on more than one computer.

³⁶⁴ R. Derek Wood, "The Daguerreotype Patent, the British Government, and the Royal Society." *History of Photography* 4, no. No. 1 (January 1980): 53-9. The French government, in granting Daguerre his pension, freely provided the daguerreotype to the nation, not the world. For a patent to be granted in America, the working details had to be provided for the process to be

clause to his indenture with Berry that bound the licensor to refund the licence fee and allow Claudet to sell out his inventory if the patent was bought by the Royal Society, or by the government for the benefit of all Britons. Claudet was careful to have an escape clause because the plan, if successful, would effectively make his investment worthless. The plea to the treasury department was rejected and the patent remained with Daguerre and Isadore Niépce, via their agent, Miles Berry for another fifteen months.³⁶⁵

Beard and Johnson senior jointly applied to patent the Wolcott reflecting camera in the spring of 1840. Miles Berry at first opposed the issuing of the patent, but he withdrew his opposition after the partners purchased a license at £50 per annum to use the process.³⁶⁶ The fee was later increased by an additional £150 for the use of three cameras.³⁶⁷ Beard and Johnson were granted the British patent for the Wolcott reflecting camera on June 13, 1840 and up to this point neither of them were familiar enough with the daguerreotype process to use it.³⁶⁸ Beard was a coal merchant and patent speculator and William Johnson was in England to advance his son's interests. They asked Robert Longbottom, Secretary

tested prior to approval. Perhaps this was sufficient to dissuade Daguerre against patenting the daguerreotype in America, and so, the daguerreotype was practiced there without restriction, by default.

³⁶⁵ The following year, Daguerre instructed Miles Berry to sell the patent, at roughly one third the asking price proposed to the British treasury. Claudet, having first right of refusal, could not convince his partner, Houghton, to invest the additional £800. Berry then turned to Beard, who bought the patent on June 23, 1841, the same month that Claudet opened his studio. Beard felt that the clause in the indenture obligated Claudet to give up his rights to the process upon return of his investment and brought suit against Claudet for failing to do so. In Beard vs. Claudet, the judge ruled in Claudet's favour because the intent of the clause was to protect the defendant in the event that the government acquires the process. Claudet could sell his interest back to Beard if he wished, and Beard was bound by the clause to buy it, but Claudet was not bound by the clause to sell.

³⁶⁶ *The Philadelphia Photographer*, no. V (1868): 174-7. In this article Johnson has his fee paid to Berry at £150. In 1858, reading directly from his partnership ledger he has it at £50 to use the process, and later another £150 to operate three cameras. Claudet's letter to Foster accused them of operating without a licence and Johnson corrected the historical error by saying they paid for a licence well before every having the need of it, which seems to confirm the two separate ledger entries.

³⁶⁷ "Photography at the American Institute." *The American Journal of Photography and the Allied Arts and Sciences* Vol. 1 (1858): 10.

³⁶⁸ William S. Johnson and Richard Beard, "A Mode of Taking Likenesses and Representations of "Nature", and of Drawings by Reflecting Images on to Suitably "Prepared Surfaces," by Means of Concave Reflectors.", Royal Letters Patent, 8546. June 13, 1840.

of the Royal Polytechnic Institution, for the name of someone who could assist them. He referred them to John Frederick Goddard, then a lecturer on optics at the Adelaide Gallery, a competing institution to his own.³⁶⁹ Goddard left his employment at Adelaide Gallery to work with Beard and Johnson in an experimental studio at the Medical Hall near Furnival's Inn. Goddard was able to successfully make portraits with the new camera by mid-September as reported in *The Morning Chronicle*, but at this time he was simply using iodine to sensitize the plates, as indicated by the "from one to four minutes" required to expose a likeness.³⁷⁰ Beard and Johnson built a complicated system to reflect direct sunlight onto the sitter, filtered through dark blue glass or blue copper sulphate solution to relieve eyestrain.³⁷¹ The lighting system was modelled after Wolcott and Johnson's New York studio in the Granite Building at the corner of Broadway and Chambers, which had been in operation since March 21 that year.³⁷² Two illustrations showing this lighting arrangement in New York, and in Holborn, are nearly identical and indicate that the studio lighting system used in Holborn was imported from New York via Johnson's correspondence (Fig. 50).³⁷³

³⁶⁹ Jabez Hughes, "The Discoverer and Use of Bromine in Photography: A Few Facts and an Appeal." *British Journal of Photography* (15 December 1863): 487-8. It is curious that Beard and Johnson did not seek the help of Claudet. When they went to Longbottom at the Royal Polytechnic, they could not have missed the exhibition of over 100 daguerreotype views on display. The Times on Saturday June 6th read:

Polytechnic Institution. — Continental Daguerreotypes of the first class, in 100 beautiful views taken in Greece, Italy, and France recently introduced into this country by Messrs Claudet and Houghton, (licensees and patentees,) for the exhibition and sale of which a separate room has been exclusively appointed.

Perhaps they saw Claudet as competition and preferred to keep their plans confidential.

³⁷⁰ "Daguerreotype Portraits." *The Morning Chronicle*, September 12 1840. Grant Romer and I experimented with a replica Wolcott camera in 2006. Using only iodine to sensitize the plates, we made fair portraits of each other in four minutes with diffuse north facing light.

³⁷¹ Daguerre was first to suggest that dark blue glass placed between the sitter and the sun would soften the intensity of the light and avoid a grimaced expression. See *Historique et Description des Procédés du Daguerreotype et du Diorama*: 27.

³⁷² John Johnson, "Daguerreotype." *The Daguerreian Journal*. 2 (1851): 74-6. March 21st is the earliest date in the studio journal where money was received for a portrait. See also, *The American Journal of Photography and the Allied Arts and Sciences*, New Series, Vol. 1 (1858-9): 10.

³⁷³ Johnson in *The Daguerreian Journal* mentions his contemporaries, Samuel Morse and John Draper, who partnered in a studio at New York University, John Goddard and Robert Cornelius who opened the first studio in Philadelphia and Southworth and Plumbe who separately worked in the Boston area. Each of these daguerreians adapted Wolcott and Johnson's lighting system, camera

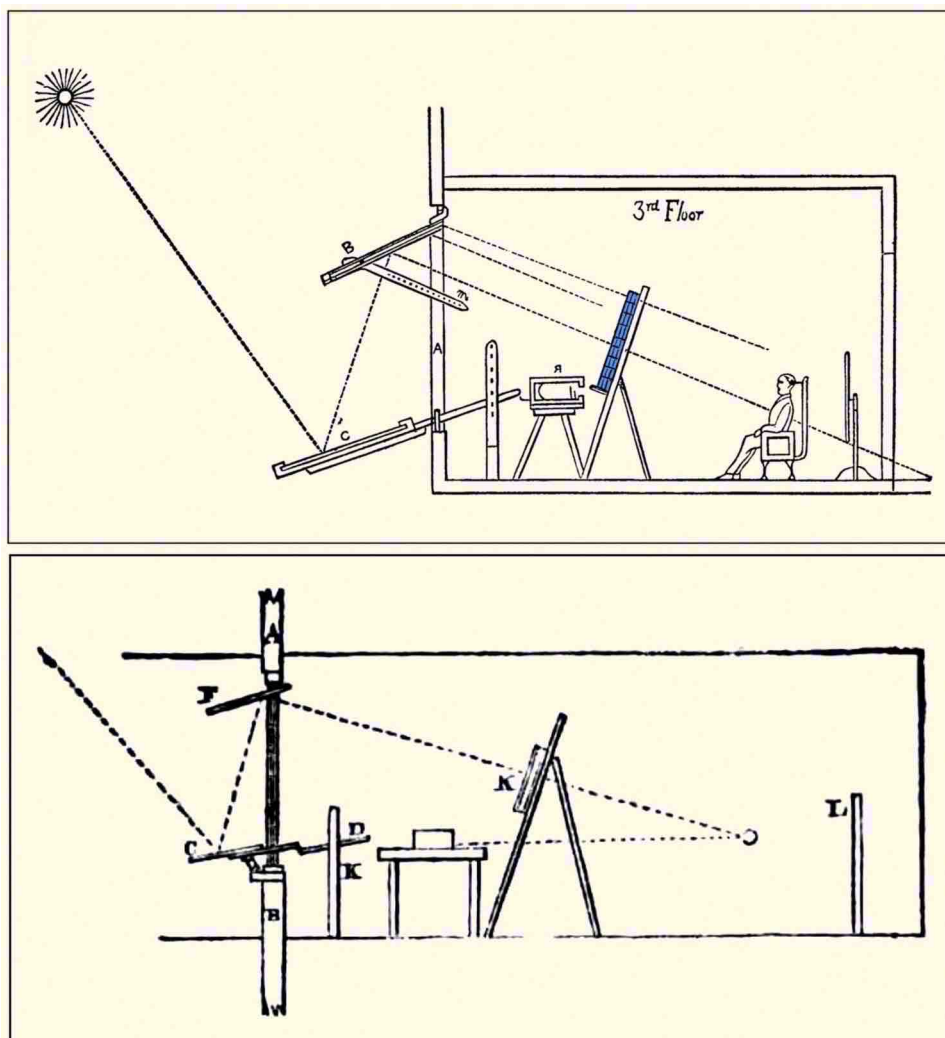

Figure 50. Granite Bldg. studio, New York. *The Daguerreian Journal*, vol 2, 1851:75 (top). Medical Hall studio, Holborn. *The London and Edinburgh Philosophical Magazine and Journal of Science*, vol 19, 1841:408 (bottom).

The reflecting camera and lighting arrangement were not enough to contend with the diminished light levels during the autumn and winter seasons. Wolcott and Johnson maintained ongoing correspondence, passing on lighting and chemical information, ever since William Johnson's arrival in London. Meanwhile, in New York, John Johnson experimented with nitro-muriatic acid that "reacted and formed

system or both in 1840. The connection between these men is evident in that John Draper's second mercury bath (1840) was built for him by Wolcott and resides in the Draper technology collection at Museum of American History, Smithsonian Institution, Washington D.C.

a peculiar chloride of iodine” and reduced exposure times somewhat.³⁷⁴ His chemical know-how was required in London, so he left New York on October 1 and upon his arrival rented a room, adjacent to the Medical Hall studio, at Furnival’s Inn, 138 Holborn Bars.³⁷⁵

John Johnson and John Goddard worked for several months together in the Holborn studio, each testing their own combinations of chemicals. Goddard revealed his “A & B” formula to Johnson as a combination of “idous” and “iodic” acid with iodine.³⁷⁶ By the end of November, Johnson had success with chloride of iodine, prepared for him by a Mr. Turner employed with Dymond & Company, Operative Chemists, situated *just around the corner* at 146 Holborn Bars. In a trans-Atlantic return of technology, Johnson exported the chloride of iodine prepared by Dymond & Co. back to the United States for use and sale by Wolcott.³⁷⁷

About the same week, Goddard hit upon a combination using bromine that made the process so exceedingly fast that he recommended to Beard that they abandon the reflecting camera altogether and switch to a more versatile, though slower working lens-based camera.³⁷⁸ They did not abandon the reflecting camera at this time, for reasons soon to be explained. Goddard announced his new means of preparing plates with bromine on December 12, 1840 in the Literary Gazette:

VALUABLE IMPROVEMENT IN DAGUERRÉOTYPE.

To the Editor of the Literary Gazette.

³⁷⁴ Johnson, "Daguerreotype." *The Daguerreian Journal*. 2 (1851): 79.

³⁷⁵ A letter from Johnson to W.H.F confirms this address. Johnson sent Talbot a reflecting camera and instructions for its use. See "The Correspondence of William Henry Fox Talbot." Leicester: DeMontfort University. Online at <http://foxtalbot.dmu.ac.uk/letters/transcriptDocnum.php?docnum=4206> (Date accessed, 3 May 2012).

³⁷⁶ *The Philadelphia Photographer*, no. V (1868): 176.

³⁷⁷ Johnson, "Daguerreotype." (1851): 79.

³⁷⁸ Hughes, "The Discoverer and Use of Bromine in Photography: A Few Facts and an Appeal." *British Journal of Photography* (15 December 1863): 487-8. Hughes was also the Honorary Secretary for the committee organized to collect a fund for the relief of the widow of Frederic Scott Archer. See *Journal of the Photographic Society*, Vol. 4 (July 21, 1858): 263.

SIR,—Having been engaged for some time past in investigating the different means of preparing the plates for the action of light in photographic delineations of daguerreotype, in the hopes of being able to render them more sensitive, the result of my experiments has been the valuable discovery, that when the bromide of iodine is used instead of the simple iodine, this very desirable object is attained in a most extraordinary degree. So delicately sensitive are the plates, when properly prepared, that the faintest lights act upon them; even on the dull, cloudy days of November, with a London atmosphere, if not too foggy, and there is sufficient light to produce a picture, it will, by a few minutes exposure, be delineated. I have not had an opportunity of experimenting with bright solar light since I made the discovery; but from the experience I have had in the old process during the last summer, I have no doubt that with a clear summer sun in London the effects will be almost instantaneous. With the light of the ordinary gas a picture of a plaster bust may be obtained in three or four minutes.

I remain, Sir, yours, &c. JOHN F. GODDARD.

Late Lecturer on Optics, &c. &c., at the Royal Adelaide Gallery.³⁷⁹

This is the first published notice of the use of bromine that Newhall referenced. As to its practicality, Antoine Claudet complained that to be credited for priority of a discovery, “it was not enough to have stated that we have made the discovery of a new agent; we must prove it by enabling others to test it and to apply its properties.”³⁸⁰ The necessary information to prepare the bromine, and allow others to test it was deliberately edited out of the article, likely to retain some competitive advantage. Goddard’s draft for the *Literary Gazette* article, dated December 8, 1840 does contain the necessary information to prepare the substance. This draft was not printed until 1864, just prior to Goddard’s death, and well after the end of commercial daguerreotypy. The text from the draft and the printed article are identical with the exception that these lines following the first sentence have been removed:

...If iodine and bromine are placed together in equal proportions, they instantly combine and form a new compound, the bright scaly crystals of the

³⁷⁹ John F. Goddard, "Valuable Improvement in Daguerreotype." *Literary Gazette; and Journal of the Belles Lettres, Arts, Sciences, &c.*, no. 1247 (December 12 1840): 803.

³⁸⁰ Antoine Claudet, "Question of Priority Respecting the Discovery of the Accelerating Process in the Daguerreotype Operation." *The London, Edinburgh, and Dublin Philosophical Magazine and Journal of Science* XXXII, no. CCXIV (March 1848): 215-16.

former dissolving, and the new substance crystallizing in dark microscopic crystals of a beautiful arborescent appearance. These are exceedingly volatile, more so than the iodine alone, the vapour attacking the silver surface in a similar manner...³⁸¹

The *Literary Gazette* text of December 12 and Goddard's December 8 draft are identical except for the omission of the specific details relating to the preparation of iodide of bromine, which is precisely what Claudet would have needed to test and validate Goddard's claim.

The above was published as part of a follow-up article written by Cornelius Jabez Hughes in 1864 to prove priority of the discovery of bromine on behalf of Goddard. Hughes' earlier article in late 1863, *The Discoverer and Use of Bromine in Photography: a Few Facts and an Appeal*, was written to set the record straight as to who was the first to use of bromine, and hoped that awareness of Goddard's contribution to the progress of photography would stir the photographic community to contribute to a relief fund. By this time Goddard was in ill-health living at St. Joseph's Almshouse at Brook Green, Hammersmith. Hughes' original article appeared on December 11, 1863 in *The Photographic News*, and four days later in *The British Journal of Photography*. In another slight alteration of text, the 1500 word appeal is identical between the two publications except for *one word*.

The Photographic News article of December 11 reads:

...in Feb., 1841, he deposited a paper in the Archives of the Royal Society, detailing his sensitive process of chlorine with iodine for taking portraits from life. A copy of this paper was presented to each of the licensees of Mr. Beard, as directions for making their sensitive solutions.³⁸²

The British *Journal of Photography* article of December 15 reads:

³⁸¹ Jabez Hughes, "The Bromine Question and Mr. J. F. Goddard, Being Two Chapters Connected with the Early History of Photography." *The Photographic Journal* 9, no. 145 (MAY 16 1864): 47-49.

³⁸² Hughes, "The Discoverer and Use of Bromine in Photography: A Few Facts and an Appeal." *The Photographic News: A Weekly Record of the Progress of Photography*, no. 12 (11 December 1863): 593-4.

...in February, 1841, he deposited a paper in the archives of the Royal Society detailing his sensitive process of bromine with iodine for taking portraits from life...³⁸³

Hughes' substitution of 'bromine' for 'chlorine' was most likely a deliberate alteration to support Goddard's position as discoverer of bromine acceleration. Furthermore, the paper detailing his sensitive process, and given to each of the licensees of Mr. Beard was not deposited in the archives of the Royal Society until March 23, 1864, not February 1841 as claimed. What Goddard delivered to the Royal Society in March, 1841 was a sealed packet containing a transcription of his journal notes between January 18 and February 18, to be retained as a means of establishing priority of his discovery.³⁸⁴ In 1864, Hughes asked Goddard to write to the Secretary of the Royal Society requesting that the packet be opened and a certified transcription made for inclusion in his follow-up article, and in that letter of request Goddard writes:

...having recently found the original rough draft of my paper on my A & B mixtures, (which I was not aware that I possessed) I have now the satisfaction of handing a copy to you with the accompanying letter which I shall feel greatly obliged by your laying before the Council of the Royal Society...³⁸⁵

Hughes reproduced Goddard's daily journal notes of early 1841 in their entirety, and they show for certain that he used bromine. On January 28 with the addition of bromide of iodine solution to the sensitizing box, he took a portrait of Mr. Beard that was "strong but very blue". He then altered the chemical proportions by adding more iodine to the box and made a better, whiter, image of Mr. Carpmael in just over two minutes, on a very dull day. His best result came with further

³⁸³ Hughes, "The Discoverer and Use of Bromine in Photography" *British Journal of Photography* (15 December 1863): 487-8.

³⁸⁴ John F. Goddard, "Notes, &C., of Discoveries in Daguerreotype, by John Frederick Goddard." GB 117, The Royal Society, 1841. Reference number AP/24/21. The catalogue description is, "Two experimental portrait photographs attached to the bottom of an autographed manuscript letter from J F Goddard of 4 March 1841 and enclosed within a covering letter and notes of 2 March 1864, explaining the important discoveries he had made in the Daguerreotype on the means of preparing the silver surface of the plates."

³⁸⁵ John F. Goddard, "Letter to Mr. White Esq., Assistant Secretary of the Royal Society." GB 117, The Royal Society, 1864. Reference number AP/24/21.

adjustments to the balance of iodine and bromine, while taking a portrait of William Johnson on February 12.³⁸⁶ Hughes decided not to reproduce the method for making the A & B solutions used in the studios of the Beard Patentees, stating in a footnote that it was a lengthy document and that “its value appears to have passed away with the process which it refers”.³⁸⁷ Goddard’s choice of chemicals and precise means of preparing his A & B solutions have remained secret to the present day, known only by the Beard Patentee holders. Goddard never published full and accurate details on how he accelerated his plates while the English daguerreotype patent was in force³⁸⁸, though one convoluted description of the sensitizing process, published in *The Penny Mechanic and Chemist*, used at the Polytechnic studio was so imprecise that anyone who tried to follow it would surely fail.³⁸⁹

In 2014, I obtained a copy of Goddard’s handwritten notes on preparing the A & B mixtures from the Royal Society. The contents of the manuscript have a renewed value in understanding the history and progress of chemical acceleration. The manuscript reveals that bromine was *not* used in the preparations. The draft,

³⁸⁶ Jabez Hughes, "The Bromine Question and Mr. J. F. Goddard, Being Two Chapters Connected with the Early History of Photography." *The Photographic News: A Weekly Record of the Progress of Photography* VIII, no. 297 (May 13 1864): 232-33. The article reproduces the certified transcription, dated March 29th, 1864 of the contents of Goddard’s sealed packet deposited at the Royal Society in 1841.

³⁸⁷ Hughes, "The Bromine Question and Mr. J. F. Goddard", *The Photographic News* VIII, no. 297 (May 13 1864): 232-33.

³⁸⁸ The patent expired fifteen years after it was granted to Miles Berry, English agent for Daguerre. Goddard, in June 1840, began working for Richard Beard and William S. Johnson who together patented the reflecting camera invented by Johnson’s son John and his partner, Alexander Wolcott. Johnson sr. was seeking to patent the reflecting camera in England and Mr. Carpmael, who was Talbot’s patent agent, introduced him to Richard Beard. An experimental studio was established in Holborn Bars. At this time Beard, like Claudet, had bought an indenture to use the daguerreotype process. It wasn’t until a full year had passed after patenting the reflecting camera that Beard bought the patent rights entirely from Berry.

³⁸⁹ "Beard's Apparatus for Taking Likenesses." *The Penny Mechanic and Chemist: A Magazine of the Arts and Sciences* 1 (May 1 1841): 166-8. The sensitizing recommendations *supposedly* used at the Royal Polytechnic Gallery were written as follows, “I prefer that the iodine should not be used separately, but that it should be combined with nitric acid and water, or with bromine or with both, or with bromic acid. In combining iodine with nitric acid and water, I put equal parts of iodine, nitric acid and water; and in combining bromine therewith, I combine an equal part of each of the other three; or I omit to use nitric acid, and use sulphuric acid and water; or I omit the use of acid, and simply combine iodine and bromine in the box above mentioned”.

dated August 6, 1841, written months after the *Penny Mechanic and Chemist* article, and months after the studio opened at the Polytechnic, show that Mixture A, is iodine tri-chloride dissolved in water, and Mixture B is the same iodide trichloride solution combined with iodous acid. For use Goddard combined 20 drops each of mixtures A and B together with fifty grains of iodine moistened with 20 drops of distilled water. The sensitizing was performed in a single step, with iodine and the two mixtures combined into one sensitizing box. Adjustments to the chemical balance were made by adding a few drops of A, or B, or adding a few grains of iodine or a few drops of distilled water as explained in the instructions. Goddard described the setup and use of the retort apparatus for preparing the mixtures, augmented with diagrams. The retort apparatus illustrated by Goddard for preparing Mixture A is precisely the same as used by Mr. Turner of Dymond and Co. to make chloride of iodine for Johnson, and what Claudet used to prepare his own chloride of iodine. To make chloride of iodine, manganese dioxide and hydrochloric acid are carefully heated in a retort. The chlorine gas generated passes from the retort into the receiving vessel containing iodine crystals.³⁹⁰ The only difference between Johnson and Claudet's preparation and Goddard's Mixture A is that Goddard allowed the reaction to continue beyond the formation of iodine *monochloride*, (indicated by a dark red liquid), until iodine *trichloride* was formed (indicated by very volatile yellow needle like crystals). Goddard's tri-chloride had three times the chlorine content as chloride of iodine, and it was necessary to be further reduced by combining it with iodous acid to create the B Mixture. He described the apparatus with a diagram (Fig. 51).

³⁹⁰ This is a dangerous process with the risk of the retort breaking with applied heat. Chlorine can be compounded with iodine on a small scale using calcium hypochlorite, available for swimming pool maintenance. The chlorine vapour from this chemical will combine with iodine in a slower, more controlled reaction.

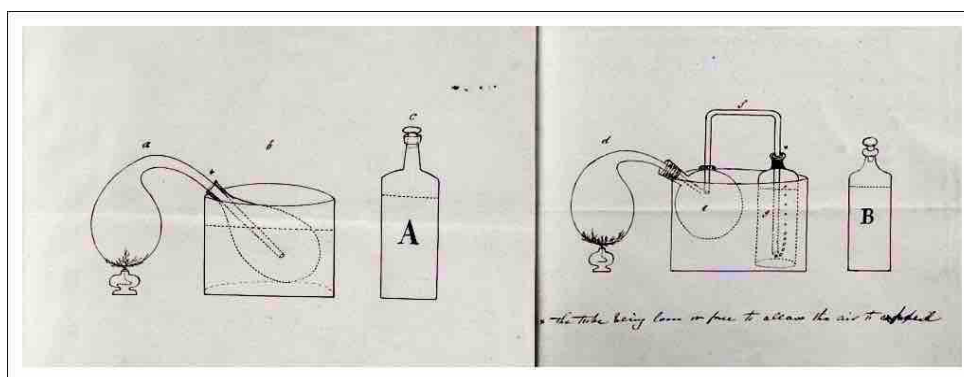

Figure 51. Apparatus for preparing A & B mixtures, August 6, 1841. The Royal Society, AP/24/21.

Goddard's directions for preparing the A & B mixtures prove that, even though he experimented with bromine, the formula provided to the Beard Patentees did not contain any. The reason it was not immediately adopted is that bromine was extremely challenging to manage and success with it was far from certain. J. M. Skegagur (sp) writing to fellow daguerreian, J. H. Mifflin in Savannah, Georgia on February 16, 1843 advised that in New York city, "they have abandoned Bromine altogether", and with chloride of iodine there is "much greater certainty than the old process" enabling the best operator to produce "ten perfect impressions out of twelve, all day long".³⁹¹

Richard Beard required the predictability of Goddard's A & B mixtures to market his photographic system to potential patentees. Who would invest in uncertain methods, or could afford to spend time and effort in failed experiments, given the asking price for a franchise was £1,000?³⁹² Johnson described the temperamental bromine process of 1841:

Mr. John Goddard, of London, (who was associated with myself,) discovered a rather valuable combination of chemicals, consisting of a mixture of iodine, bromine, iodus acid, and a proper combination of these bodies gave an action somewhat more sensitive than chloride of iodine — but the "high lights" of the portrait would become solarized or overdone,

³⁹¹ Skegagur, J. M. [sp], "Letter to J. H. Mifflin Esquire, Fellow Daguerreian in Savannah Georgia." National Gallery of Canada collection, date Feb. 16, 1843.

³⁹² Dr. Robert Fisher, "The Beard Photographic Franchise in England: An Overview of the Licensed Daguerreotype Portrait Galleries and Their Products in the 40's." *The Daguerreian Annual: Official Yearbook of the Daguerreian Society* (1992): 75.

more frequently with this combination than with the chloride of iodine...the difficulty of exactly combining the three elements above mentioned, in order to produce a certainty of result with harmony of effect, was the work of many months, with great labor and study, the slightest modification requiring a long series of practical experiments, a single change consuming, frequently, an entire day in instituting comparisons, &c., &c.³⁹³

The Wolcott and Johnson mirror camera continued to be used by Beard Patentees using chloride of iodine until 1842 because its quick working reflecting optics offered a speed advantage over Claudet, their only competitor in London, who worked with lenses. In early 1842, John Johnson and Alexander Wolcott, (Wolcott left the New York studio and moved to England in July 1841) discovered a way to combine iodine, bromine and chlorine that proved to be reliable and increased the sensitivity to the degree that the fast working reflecting camera was no longer necessary. Wolcott's mixture, as it came to be known, was sold in liquid form, sealed in glass ampoules. The daguerreians who used it simply diluted "6 to 12" drops of the mixture with "6 or 8 ounces of water".³⁹⁴ The additional speed provided by Wolcott's mixture enabled Beard and his patentees to finally abandon the reflecting camera in favour of one with a lens. The reflecting camera was limited to head and shoulders portraits for reasons explained in the coming chapter on optics. The lens, on the other hand, can record a wider view with more depth as apparent in these portraits of Goddard and Claudet taken around the same time (Fig. 52). Claudet's self-portrait is taken in front of a painted backdrop; the details of which could only be rendered well by the depth of field available from a lens. Claudet actually received a patent for the use of painted backdrops in 1841.³⁹⁵

³⁹³ Johnson, "Daguerreotype." *The Daguerreian Journal*. Vol. 2 (1851): 79.

³⁹⁴ Samuel D. Humphrey, *American Hand-Book of the Daguerreotype ... Containing the Daguerreotype, Electrotype And ... Other Processes ... Fifth Edition*. New York, 1858: 118. Humphrey kept a bottle of Wolcott's mixture in his office for posterity. The formula, as relayed to him by John Johnson was..."One part bromine, eight parts of nitric acid, sixteen parts of muriatic acid, water one hundred parts."

³⁹⁵ Antoine Claudet, "Improvements in the Daguerreotype Process." Royal Letters Patent, No. 9193. England, December 18, 1841. The painted backdrop was the third of five improvements described in the patent.

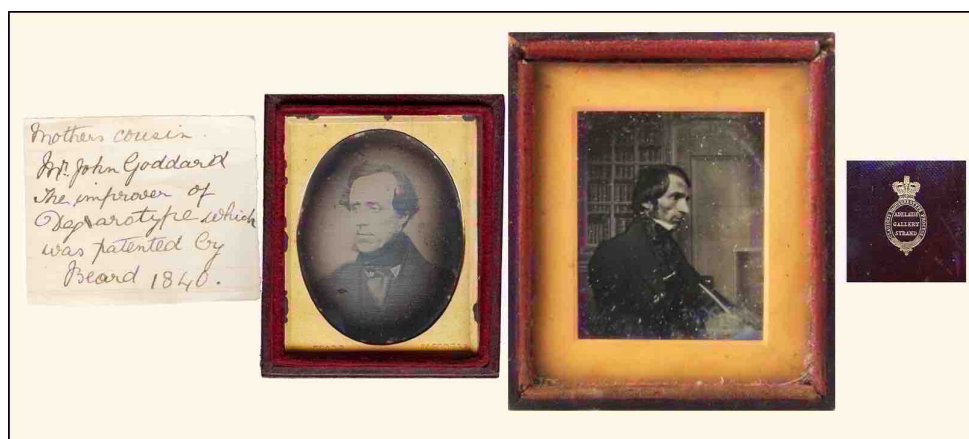

Figure 52. *Portrait of John F. Goddard*, taken with the Wolcott camera. Private collection (left). *Antoine Claudet, Self-portrait*. Private collection (right).

A youngish, dark-haired, Antoine Claudet is presented in a leather case blind stamped "Claudet's Daguerreotype Process - Adelaide Gallery Strand".³⁹⁶

Claudet's daguerreotype process with chloride of iodine was prepared and used in a different manner than Johnson or Goddard. Goddard, as discussed, experimented with bromine and published his success with it without providing specific details for his preparations. Nevertheless, the *Literary Gazette* notice of December 12, 1840 combined with Hughes' later articles in support of Goddard have resulted in historians recognizing him as the one to introduce bromine into the sensitizing processes. What I have shown is that this is not accurate. Though exceedingly quick working, bromine more often than not, resulted in blue (solarized) or foggy (veiled) images. Chlorine compounds though slower were far more predictable and it is these that Goddard's A & B mixtures were comprised of and used at the Beard franchises, in combination with the Wolcott reflecting camera. The A & B Mixtures were used in combination with iodine in a single sensitizing box.

The addition of a second sensitizing box containing chlorine or bromine or both was introduced by Antoine Claudet and provided greater control over the single,

³⁹⁶ This ca 1842 daguerreotype is the only known image of Claudet with dark hair. Claudet, born in 1797 had snow-white hair in images from 1851.

Robinson: The Techniques and Material Aesthetics of the Daguerreotype

all-in-one, sensitizing box. The next section will introduce Claudet's Daguerreotype process and conclude with the transition to bromine.

5.4 Sensitizing Accelerators: Claudet's Chloride of Iodine

Antoine Claudet recognized Goddard for his contribution to the art in 1848, though backhandedly admonished him for keeping the details a secret, noting that to be credited for a discovery it is not enough to simply claim it; one has to prove it by providing the information for others to test it.³⁹⁷ Claudet freely communicated his discovery of chlorine acceleration to the Royal Society and the following month sent a letter to his friend Lerebours, to be published in the French scientific journal, *Comptes rendus hebdomadaires des séances de l'Académie des sciences*.³⁹⁸ *The Literary Gazette* notice of December 1840, and the *Penny Mechanic* article in May 1841, published by Goddard contained insufficient details for others to replicate his results. Goddard was even more guarded when he gave a public lecture at the Royal Polytechnic only three days after Beard's Photographic Institution opened. He was very forthcoming with plate rolling and polishing information, but as to his mode of sensitizing, he merely said that it was "different" than Daguerre's method based on experiments he conducted the previous autumn.³⁹⁹ His reason for secrecy was to protect the Beard patentees, proven in a letter written in 1864 to Mr. White of the Royal Society, when he apologized for the late submission of a document describing the preparation and use of his A & B mixtures:

I shall feel it a great favour if you will also express my unfeigned regret that his has not been done before, or on the expiration of Daguerre's Patent. But, unfortunately, I was prevented carrying out my intentions by circumstances over which I had no control until 1856.⁴⁰⁰

³⁹⁷ Antoine Claudet, "Question of Priority Respecting the Discovery of the Accelerating Process in the Daguerreotype Operation." *The London, Edinburgh, and Dublin Philosophical Magazine and Journal of Science* XXXII, no. CCXIV (March 1848): 215-16.

³⁹⁸ Antoine Claudet, "Sur un nouveau procédé d'iodage pour les planches destinées à recevoir des images photographiques, Procédé qui abrège considérablement la durée du temps nécessaire pour que la lumière produise une impression suffisante. -- Lettre de M. Lerebours à M. Arago." *Comptes rendus hebdomadaires des séances de l'Académie des sciences*, no. Séance Du Lundi 7 Juin 1841 (1841): 1059-60.

³⁹⁹ "On the Application of the Daguerreotype to the Taking of Likenesses from the Life." *The Polytechnic Journal: A Monthly Magazine of Art, Science, and General Literature*, no. 4, (April 1841): 248-51.

⁴⁰⁰ John F. Goddard, "Letter to Mr. White Esq., Assistant Secretary of the Royal Society." GB 117, The Royal Society, 1864. Reference number AP/24/21. The Daguerre Patent expired in 1856

Claudet on the other hand had no reason to be secretive. He asserted his own priority of discovery, fifteen years before Hughes appeal for Goddard, when he wrote, "I made the discovery of the acceleration property of chlorine, bromine and iodine combined with certain proportions in May 1841, and I communicated a paper on the subject to the Royal Society, which was read the 10th of June following".⁴⁰¹ The paper reads:

Communicated by the Marquis of Northampton, Pres. R.S.

"My improvement", says the author, "consists in using for the preparation of the plates, a combination of chlorine with iodine, in the state of chloride of iodine. I follow the preparation recommended by Daguerre. After having put the plate in the iodine box for a short time, and before it has acquired any appearance of yellow colour, I take it out, and pass it for about two seconds over the opening of a bottle containing chloride of iodine; and immediately I put it again in the iodine box, where it acquires very soon the yellow colour, which shows that the plate is ready to be placed into the camera obscura. I have substituted to the chloride of iodine, chloride of bromine, and have found nearly the same result; but I prefer chloride of iodine as producing a better effect; and besides, on account of the noxious smell of bromine. "The result of my preparation is such, that I have operated in ten seconds with the same apparatus, which, without any chlorine, required four or five minutes; when using only the original preparation of Daguerre, I have obtained an image of clouds in four seconds."⁴⁰²

The manner in which chloride of iodine was prepared for Claudet's process was "difficult and dangerous", and best left to a skilled chemist with the proper

and Goddard had only recently relocated the draft formula for his A & B mixtures that was provided to the Beard Patentees. He was unaware that the document was still in his possession, having forwarded the materials eight years earlier to a Mr. Malone, who was supposed to, but did not, forward them to the Royal Society on his behalf.

⁴⁰¹ Antoine Claudet, "Photographic Phænomena Referring to the Various Actions of the Red and Yellow Rays on Daguerreotype Plates When They Have Been Affected by Daylight". *The London, Edinburgh, and Dublin Philosophical Magazine and Journal of Science* XXXII, no. CCXIV (March 1848): 203. Claudet's articles from the *Philosophical Magazine* were reprinted in volume 1 of *The Daguerreian Journal*, the first American journal of photography.

⁴⁰² Antoine Claudet, "New Mode of Preparation of the Daguerreotype Plates, by Which Portraits Can Be Taken in the Short Space of Time of from Five to Fifteen Seconds, According to the Power of Light, Discovered by A. Claudet in the Beginning of May 1841." Paper presented at the Proceedings of the Royal Society, June 10, 1841. Claudet's paper coincidentally was read immediately following William Henry Fox Talbot's communication regarding his newly discovered calotype negative process.

laboratory apparatus.⁴⁰³ In the same apparatus pictured in Goddard's illustration for Mixture A, chlorine gas is generated when hydrochloric acid is poured onto manganese dioxide in a carefully heated retort. The chlorine gas passes over to a receiving flask containing solid iodine flakes. This is precisely the same procedure Goddard used for making his A mixture, except when preparing chloride of iodine, the reaction is halted as soon as the iodine solid and chlorine gas form a deep red liquid. This substance is known today as iodine mono-chloride. Goddard allowed the reaction to continue until iodine tri-chloride was formed, which according to Valicourt was unsuitable as an accelerator. It worked for Goddard because it was co-mixed with iodine and iodous acid in a single sensitizing box. Chlorine gas was never used on its own to accelerate a daguerreotype because it is practically impossible to control its strength within a sensitizing box. The solution, literally, was to combine chlorine gas with iodine crystals or bromine liquid to form liquid chloride of iodine, or chloride of bromine. Claudet may have prepared his own chloride of iodine, but it is just as likely he asked Mr. Turner of Dymond & Company, located just down the street, to prepare it for him, as did John Johnson.

Claudet's sensitizing procedure as read before the Royal Society on June 10, 1841 was different than what Goddard provided to the Beard Patentees. Claudet applied his accelerator separately and *after* very lightly iodizing the plate, by holding the plate over an open bottle of chloride of iodine. He completed his sensitizing with a second pass over the iodine vapour. Claudet reported that he was the first to know that bromine will not work without first coating the plate with iodine.⁴⁰⁴ He made no mention of the importance of a second iodizing after

⁴⁰³ Edmund de Valicourt, *Nouveau manuel complet de photographie sur métal, sur papier et sur verre*. Roret, 1851: 77. Valicourt's treatise was transcribed into English and printed in parts over several numbers of *The Photographic and Fine Art Journal*, Vol. 7, 1854. In Article 121, Valicourt credits Claudet for the discovery of chloride of iodine, and in the next Article 122, he gives precise instruction on its making for the benefit of those who might not have access to a chemist.

⁴⁰⁴ Claudet, "Question of Priority Respecting the Discovery of the Accelerating Process in the Daguerreotype Operation." (March 1848): 216. "Bromide of Iodine alone is not sufficient in the preparation of the Daguerreotype plate; its vapours must be applied when the plate has already been coated with pure iodine" wrote Claudet. In my experience, if bromine is inadvertently applied first, the result will be a blank plate veiled with mercury.

acceleration even though his use of the method pre-dates Laborde's publication in *L'Echo du Monde Savant* by three years.

The relative speed difference between Daguerre's iodine sensitizing process of 1839, compared with Claudet's iodine with chlorine process of 1841 and Laborde's method with iodine and bromine, ubiquitous after 1847, is evident from DagTest 11-13-2014 shown in figure 53. Three plates were sensitized according to Daguerre, Claudet and Laborde's methods. Fortunately, for optical veracity, I had access to an original American daguerreotype camera from 1841 fitted with a plano-convex triplet lens with an aperture of $f/2.9$ (by today's standards).⁴⁰⁵ The daguerreotypes are mercury developed and not gilded.

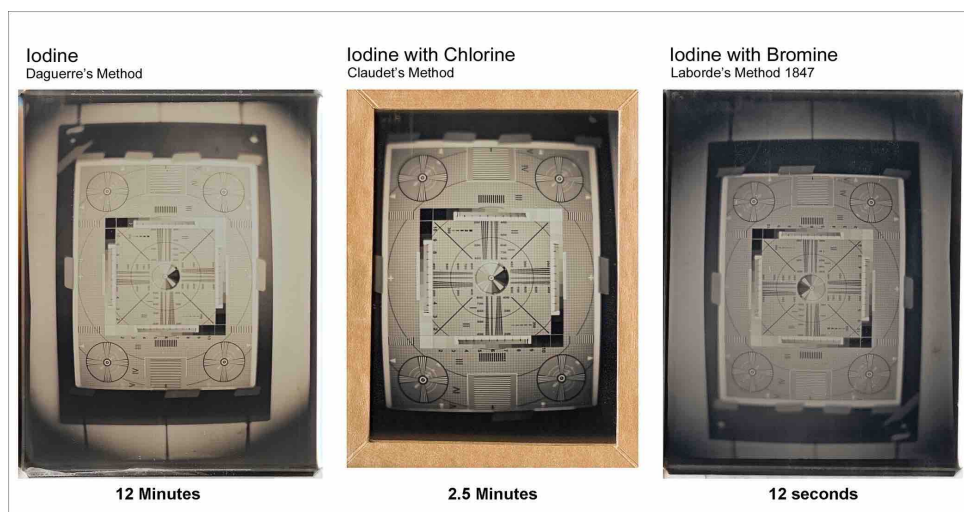

Figure 53. DagTest 11-13-2014. Sensitizing experiments with iodine, chlorine and bromine.

The light levels varied slightly between each experiment. When adjusted to normalize the exposure value (ev), a twelve minute exposure is required for plates prepared with iodine, chloride of iodine requires two and a half minutes, roughly five times faster than iodine, and plates sensitized with bromine are about twelve times faster than chloride of iodine, and *sixty* times faster than iodine used on its own, turning minutes into seconds. Furthermore, if a Wolcott reflecting camera

⁴⁰⁵ This lens combination is non-achromatic, and has significant chromatic aberration and barrel distortion. These defects were corrected by Petzval's design.

were used the speeds would be roughly five minutes for iodine, one minute with chlorine, and five seconds with bromine given the same subject illumination.⁴⁰⁶

Claudet preferred chloride of iodine in 1841 because it produced a “better effect” without having to endure the noxious smell of bromine. This better effect he refers to is the tone of the image. Figure 54 compares the relative speed and tones obtained with bromine compared to chlorine on plates prepared according to 1841 sensitizing methods. Even without the after treatment of gilding, the chlorine plate is warm and bright, while that sensitized with bromine, *without second iodizing*, is bluish and solarized. This result is similar to Johnson and Goddard’s experiments with bromine, noted in the previous section.

⁴⁰⁶ These exposure times are estimated based on the effective f/no. of the Wolcott reflecting camera which had an eight inch diameter mirror of fourteen inch focal length. This equates to $f/1.7$, (focal length/diameter) however the plate blocked roughly ten percent of the incident light, so the effective aperture is $f/2$, or 1.33 stops faster than the $f/3.2$ lens used in DagTest 11-13-2014.

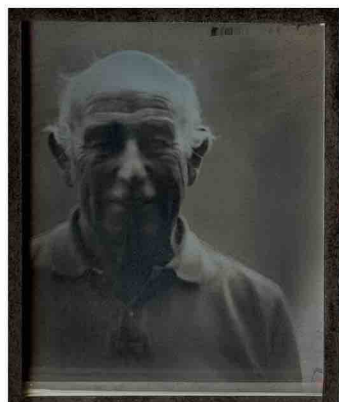

Wolcott reflecting camera (replica)
Iodine with bromine
5 second exposure (ev 11)

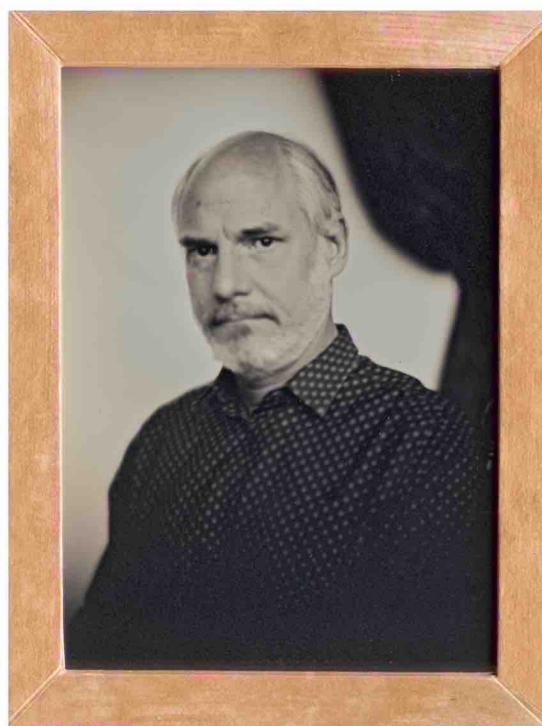

1841 American refracting camera
Iodine with chlorine
90 second exposure (ev 7.66)

Figure 54. *Portrait of Roger Smith, 2014*, taken at Lacock Abbey in 2014 using the camera that he built (Left). *Mike Robinson, self-portrait, 2014* (right).

Claudet presented an early history and progress of the daguerreotype art in 1845 and from his writing it seems by this time he had stopped using chlorine in favour of bromine.⁴⁰⁷ Furthermore, Claudet communicated his formula for preparing bromide of iodine to be included in Valicourt's new manual.⁴⁰⁸

Chloride of Iodine was not completely discontinued with the development of reliable bromine compounds as it was still considered an excellent accelerator for

⁴⁰⁷ Antoine Claudet, "The Progress and Present State of the Daguerreotype Art." *Journal of the Franklin Institute* 40, no. 1 (1845): 45. Claudet wrote, "In the year 1811, Coutrois discovered the chemical substance called Iodine, and, as late as 1826, Balard discovered Bromine; the two elements are the only substance which, in the daguerreotype, form with the silver a compound sufficiently sensitive to the rays of light, and without such substances the daguerreotype could not have existed".

⁴⁰⁸ Edmund de Valicourt, *Nouveau manuel complet de photographie sur métal, sur papier et sur verre*. Roret, 1851: 91.

landscape work. S. D. Humphrey, daguerreian and editor, extolled its virtue for this purpose as late as 1858:

Chloride of Iodine as an Accelerator.

This is probably one of the best accelerators that can be used for coating the plate for taking views; it works too slow, however, to meet the wants of the operating room, yet its use was formerly, for a long time, adhered to by some of our best professors. In producing views with this, we are successful in obtaining well-developed impressions, with a depth of tone and richness of appearance not to be met with in the productions of any other substances.⁴⁰⁹

Portrait photographers gradually introduced bromine due to its unquestionable speed advantage at five or six times quicker than chlorine, and bromine eventually became the main constituent of all accelerating compounds.

This section has shown that Goddard's reticence to divulge the working details of his sensitizing methods was related to protecting the investment of the Beard franchisees while Daguerre's patent was in force, while Claudet, free from this restraint published his methods. Claudet's process of using two separate sensitizing boxes became standard practice over Goddard's all-in-one-box mixtures. I have also shown that chlorine acceleration remained in use, due to its reliability and the tone it produced, until effective methods to manage bromine vapour were developed. The next section will discuss some of the creative ways adopted by daguerreians between 1841 and 1845 to control this exceedingly volatile substance and mitigate the likelihood of solarization and veiling.

⁴⁰⁹ Samuel D. Humphrey, *American Hand-Book of the Daguerreotype ... Containing the Daguerreotype, Electrotype And ... Other Processes ...* Fifth Edition. New York, 1858: 126.

5.5 Sensitizing Accelerators: Managing Bromine

Claudet's experiments with chloride of iodine were first published in France by way of a letter from his friend Lerebours to François Arago, read at the June 7, 1841 meeting of the Academy of Science.⁴¹⁰ Two weeks later, Louis Fizeau, a Parisian physicist, published his experiments with bromine as an accelerator. Fizeau acknowledged Claudet's contribution, and then noted the speed difference between the two halogens. With chloride of iodine, he successfully exposed daguerreotypes in 120 seconds, with bromine, the time required was only 20 seconds or six times faster.⁴¹¹

In 1841 Fizeau used diluted bromine after iodizing, as pure bromine in concentrated form is exceedingly strong. The most direct way to reduce the strength of bromine is to mix it with pure water and make what was referred to as *bromine water*. Bromine water introduced three new problems to the daguerreian system. First, the solution was so volatile that each time the bottle was opened, bromine vapour escaped, altering its concentration and making it virtually impossible to evaluate successive test results. Second, one could not inspect the plate for colour changes to determine the appropriate coating, as was possible with iodine or slower working sensitives. If this were attempted, the result would be heavily veiled. Third, it was realized that while the vaporization rates of both iodine and bromine change with ambient temperature, iodine vaporization is more affected by temperature than that of bromine so the compensation in timing during sensitizing required for temperature fluctuation is not the same for each element. Fizeau developed five specific principles to address these concerns.

⁴¹⁰ N. P. Lerebours, "Sur un nouveau procédé d'iodage pour les planches destinées à recevoir des images photographiques, Procédé qui abrège considérablement; La durée du temps nécessaire pour que la lumière produise une impression suffisante." *Compte rendus hebdomadaires des séances de l'Académie des sciences*, no. Séance du Lundi 7 Juin (1841): 1059.

⁴¹¹ Armande Hippolyte Louis Fizeau, "Note sur l'emploi du brôme dans la photographiesur plaqué." *Compte rendus hebdomadaires des séances de l'Académie des sciences*, no. Séance du Lundi 21 Juin (1841): 1189. Fizeau's plates were made with Daguerre's single achromatic landscape lens. The aperture was *f*/15.

1st In making a saturated solution of bromine in distilled water.

2d. In taking a fixed and determinate volume this solution, and to dilute it with a known volume of rain water.

3d. To take from this solution a known quantity sufficient to cover the bottom of the bromine dish from $\frac{1}{4}$ to $\frac{1}{2}$ inch.

4th. To expose the plate properly iodized to the emanations of the bromine water, for a space of time which can only be determined by experiment.

5th To renew the dose of bromine for every experiment.⁴¹²

Léon Foucault designed a sensitizing box, specifically for use with bromine water in 1843 (Fig. 55). It had adjusting screws at its base to set the interior pan perfectly level and incorporated a tube through the side wall. A measured amount of bromine water was poured into the box through a funnel connected to the tube. The operator waited thirty seconds to a minute before sensitizing to allow the vapours within the box to normalize. A meter-long swinging pendulum determined the seconds.⁴¹³ In every instance it was essential to always pour in the same volume of bromine water, to wait the same length of time before use, and to discard the solution after each use and replace it with fresh solution. This procedure was wasteful, time consuming and exposed the operator to harmful bromine vapours each time the sensitizing box was opened. Lerebours advised that it was better to abandon bromine water in favour of the less volatile bromide of iodine compound or other sensitives if one was not willing to change the bromine water after each experiment.⁴¹⁴

⁴¹² Charles Chevalier, *Nouvelles instructions sur l'usage du daguerreotype, Description d'un nouveau photographe, suivie d'un memoir sur l'application du brôme*. 1841: 68-9. The English text comes from a later translation of de Valicourt's treatise in *The Photographic and Fine Art Journal* 7 (1854): 241.

⁴¹³ N. P. Lerebours, *Traité de photographie, derniers perfectionnements apporté au Daguerreotype*. Quatrième Édition. Paris, 1843: 109-11. Years later, Foucault would use the pendulum to demonstrate the Earth's rotation.

⁴¹⁴ Lerebours. *Traité de photographie, Quatrième Édition*. Paris, 1843: 45-8.



Figure 55. Foucault's design sensitizing box for bromine water (left). Iodine box incorporating an absorbent card after Séguier's design (right). Source, www.collection-appareils.fr

Even with such precautions, it usually required several experiments to determine the best bromine timing to achieve the maximum sensitivity, as the correct coating could not be determined by inspection without fogging the plate. According to Valicourt, there had to be a certain quantity of bromine absorbed by the plate, "below or above which the proof is either incomplete or veiled".⁴¹⁵

Louis Daguerre also developed a complicated method to manage bromine in 1844. Not resting on his laurels after August 19, 1839, he continued to work five more years on improving the daguerreotype. He was bound by the terms of the bill granting his lifetime pension to make public any improvements or later discoveries he might make with the daguerreotype or the diorama.⁴¹⁶ He did so via letters to François Arago, who read them before weekly meetings of the Academy of Science, published then in *Comptes Rendus*.⁴¹⁷ Arago first hinted that Daguerre had discovered an improved means to prepare his plates in January 1844, followed

⁴¹⁵ Edmund de Valicourt, "A New and Complete Photographic Manual for Metal Plates and Paper -- Containing All the Latest Discoveries. Translated from the French of E. De Valicourt, by A. B. W. Grigg", *The Photographic and Fine Art Journal* 7 (1854): 242.

⁴¹⁶ Louis Jacques Mandé Daguerre, *Historique et description des procédés du Daguerreotype et du Diorama*. Alphonse Giroux et Cie ed. Paris: Delloye, Libraire, 1839: 6.

⁴¹⁷ Arago in *Compte rendu* published Daguerre's improved iodizing method on December 23, 1839. His improvements in the sensitivity of iodized plates by introducing an electric spark at the instant of exposure was read on June 28th, and July 5th, 1841.

by full disclosure of the method on April 22, 1844.⁴¹⁸ The details of Daguerre's method have been dismissed as too complicated to be useful.⁴¹⁹ They take on a renewed significance with the knowledge that his method was developed specifically to deal with bromine veil, and show that his chemical and scientific knowledge was supported by effective experimental design.

By adding gold to the metals which I first used, I am enabled to avoid the great difficulty which the use of bromine, as an accelerating substance, presented. It is known that only very experienced persons could employ bromine with success, and that they were able to obtain the maximum of sensibility only by chance, since it is impossible to determine this point very precisely, and since immediately beyond it the bromine attacks the silver, and is opposed to the formation of the image...for the application of the layer of gold is opposed to the formation of what is called the veil of bromine.⁴²⁰

There is only one known scenic daguerreotype by Daguerre taken after he left Paris to settle in Bry-sur-Marne. It is a view from the tower of his house overlooking the town. There is a circular bright region on the center left area of the plate. Curators at the Société française de photographie have speculated that the defect may have been caused by a botched and undocumented attempt at conservation.⁴²¹ On the contrary, I believe it was made as a test or demonstration plate to show of the effect of precipitated gold on the silver plate *before sensitizing*

⁴¹⁸ Louis Jacques Mandé Daguerre, "Photographie.— Sur un nouveau moyen de préparer la couche sensible des plaques destinées à recevoir les images photographiques.". *Compte rendus hebdomadaires des séances de l'Académie des sciences* (April 22, 1844): 756-62. Arago's first mention of this appears in *Compte rendu* on January 29, 1844.

⁴¹⁹ Gary Ewer, in reference an English report noted...The writer's comment about Daguerre's "improvement" being a "rather complicated process" seems to have been shared by daguerreotypists of 1844. This process seems to have received little notice and was not adopted into practice. See Gary Ewer, "The Daguerreotype: An Archive of Source Texts, Graphics, and Ephemera" Ewer archive no. N844002. http://www.daguerreotypearchive.org/texts/N8440002_DAG-PROCESS_NTL-INTEL_1844-05-23.pdf (Date accessed, 18 March 2017)

⁴²⁰ Louis Jacques Mandé Daguerre, "On a New Mode of Preparing the Plates Destined to Receive Photographic Images." *The Chemist*, no. v. 5 (1844): 260-3. This is an English translation from *Comptes rendus hebdomadaires des séances de l'Académie des sciences*, April 22, 1844: 756-62.

⁴²¹ I was part of a group from the Daguerreian Society that visited the Société française de photographie in the autumn of 2013 and this daguerreotype, which has been in their collection since 1891, was passed around. The origins of the circular 'defect' were questioned.

for the prevention of bromine veil.⁴²² The effectiveness of a process or technique is best illustrated when the experimental variables are produced on a single image. This minimizes the effect of process variables not relevant to the test. According to his new method, Daguerre poured mercuric chloride, gold, and platinum solutions on the silver surface to deposit the metals. He then re-polished the plate and sensitized it with iodine and bromine. It is difficult to apply a poured solution locally on a plate without some sort of retainer for the liquid puddle. In testing my hypothesis on DagTest 10-20-2013, I poured weak gold chloride solution into a plastic ring placed on a dry and polished plate. The ring retained the solution well, except for a small semi-circular spot that seeped beyond its boundary. Daguerre's view of Bry has a similar semi-circular artefact beyond the edge of the main circle (Fig. 56).

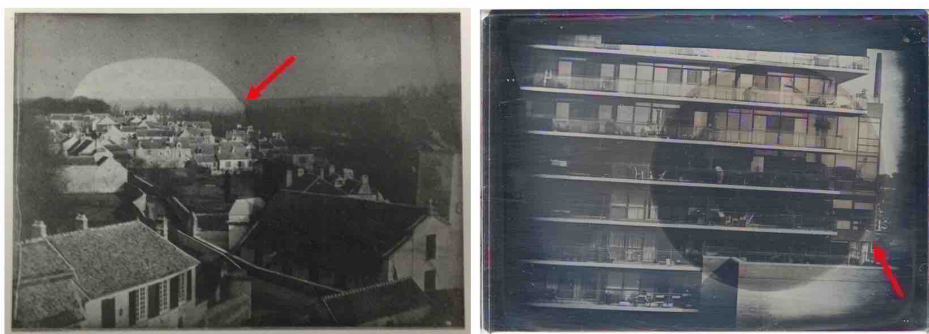

Figure 56. Daguerre's *View of Bry-sur-Marne*, 1844. Collection of the Société française de photographie (left). DagTest 10-20-2013. Gold chloride solution applied locally before sensitizing (right). The red arrows indicate the location of the semi-circular seepage.

The view from my window, DagTest 10-20-2013, was sensitized under candlelight with iodine, followed by bromine only, with no second iodine. The exposure was forty seconds using a replica of the Giroux camera and achromatic landscape lens.

⁴²² The verso of the plate is inscribed, "Epreuve daguerrienne faite par M. Daguerre à Bry-sur-Marne - Hommage de M. Forest" a gift to a M. Forest. The bright circle on this plate does not seem to be accidental and I know of no conservation treatment that would leave such a pattern. If the circular pattern then is deliberate, I tend to think it is a demonstration plate. At the May 1875 meeting of the Société française de photographie, a M. Forest made a gift of one of Niépce's engraved plates to the society. This plate was inscribed to Daguerre. It is possible that Forrest received the *View of Bry* and the Niépce plate at the same time though Daguerre's image was given later in 1891. See *The British Journal of Photography*, (May 14, 1875): 237.

If only iodine was used the exposure time required would have been about ten minutes. My experiment used gold chloride solution without platinum or mercuric chloride, as Daguerre suggested. This may be the reason for the tonal differences between it and the Bry image. Nevertheless, DagTest 10-20-2013 does imply an experimental methodology similar to Daguerre's, and adds a new interpretation for his *View of Bry-sur-Marne*, and his working methods. It also shows that Daguerre had an understanding of the chemical relationship between different metals and their affect on the daguerreotype plate. He learned that silver plates containing copper tended to fog compared to pure silver, as has been shown in the plate chapter, and he applied platinum and gold (metals of greater nobility) to the silver to retard the fog from bromine. Daguerre understood what later was to be known as the electro-motive series between metals where copper has a greater oxidation potential than gold. DagTest 10-20-2013 shows that gold, when added to the plate in trace amounts before sensitizing, is effective in restraining bromine veil. Daguerre was not the first to treat the plate with gold in advance of sensitizing. That credit is possibly due to Robert Cornelius and Paul Beck Goddard of Philadelphia.

J. Egerton translated Lerebours' *Traité de photographie*, in 1843. In the preface he praised daguerreotypes by Cornelius, that he had seen two years earlier, as "the most beautiful specimens of the Daguerreotype then in existence".⁴²³ Cornelius and his silent partner, Paul Beck Goddard, had begun to experiment with bromine as early as December 1839. To corner the market and protect their secret they proceeded to buy up all the available bromine on the eastern seaboard.⁴²⁴ A clue to how they succeeded with bromine, at such an early period, comes from an obscure reference. One sentence from the minutes of the March 4, 1842 meeting of the American Philosophical Society reads:

⁴²³ N. P. A. Lerebours, *Treatise on Photography; Containing the Latest Discoveries and Improvements Appertaining to the Daguerreotype*. By N. P. Lerebours. Translated by J. Egerton. London: Longman, Brown, Green, and Longmans, 1843: vii.

⁴²⁴ M. Susan Barger and William B. White, *The Daguerreotype: Nineteenth-Century Technology and Modern Science*. 2nd ed. Baltimore: John Hopkins University Press, 2000: 34.

Dr. Goddard presented specimens of Daguerreotypes on a surface of gilded silver, and stated that the surface of iodide of gold was more susceptible to the Daguerreotype action of light than that of the iodide of silver, that the surface of the plate might be polished without injury before the action of the iodine and that the lights came out better than on the silver surface.⁴²⁵

Goddard's sentence provides scant information to precisely replicate his experiment; nevertheless DagTest 4-21-2015 is very informative (Fig. 57). I poured gold chloride solution on half of a polished plate and I immediately observed the gold solution was *too strong*.⁴²⁶ The silver and gold reacted instantly and the surface darkened to a mottled dark brown colour requiring several minutes of hand buffing to bring it back to a shiny surface equal to the pure silver side. The plate was sensitized with iodine followed by bromine under a red safelight, *without* second iodine. The gilded silver side, though imperfect, has a partially formed image, while the pure silver side is completely veiled.

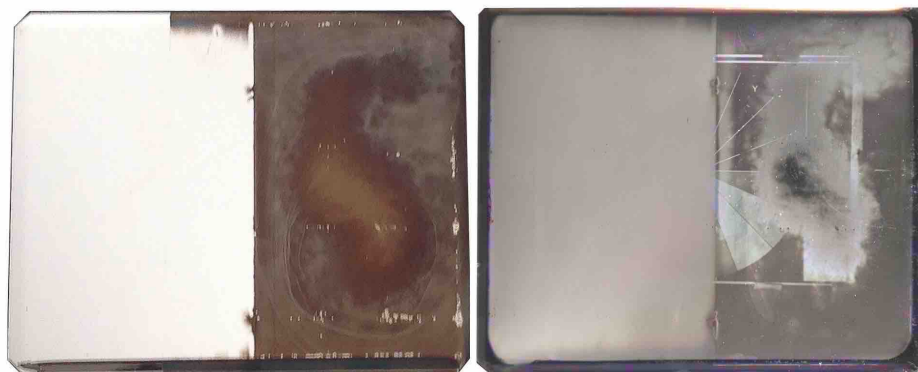

Figure 57. DagTest 4-11-2015. Plate with mottled gold deposit on right half before re-polishing (left). Completed image with left half completely veiled and the right half partially formed (right).

In order to work successfully, the gilding of the silver must be very delicately performed, enough to retard the veiling from bromine, but not enough to restrain all photosensitivity. George Fisher in *Photogenic Manipulation* (1843 edition) makes mention of the experiments in Philadelphia with pre-gilded plates but he

⁴²⁵ American Philosophical Society, *Proceedings of the American Philosophical Society*. Vol. II. 1842: 150.

⁴²⁶ A subsequent experiment using gold chloride diluted 1:5, (DagTest 3-19-2016) resulted in a fully formed image and showed that very little gold was required to effectively inhibit bromine veil.

misinterprets the materials. Without understanding the nature of Paul Goddard's 'gilded silver' he dismissed the method as too expensive, assuming the work was performed on gold plates, and makes the counterpoint that one of England's pre-eminent photographic researchers, Robert Hunt, has yet to find any paper produced with salts of gold sufficiently sensitive to use in a camera.⁴²⁷

Applying noble metals to plates in advance of sensitizing to control bromine veil was practically obsolete as soon as it was introduced. Less than four months after Daguerre published his complicated method, Laborde revealed a far more practical and reliable technique which included a second iodizing step after bromine.⁴²⁸ Once the problem of bromine veil had been solved with the introduction of the second iodizing step, the next desideratum for the daguerreian was to find a reliable and uniformly working sensitive for all weather conditions. During the period between 1844 and 1850 sensitizing materials and methods continued to evolve toward this goal. The daguerreian artist, working with sensitizing methods capable of producing successive plates with matched speed, tone and spectral sensitivity had the freedom to concentrate on the artistic aspects of the task, rather than sensitizing variables.

Each of the accelerating formulae discussed so far; bromine water, chloride of iodine, bromide of iodine, and Wolcott's mixture, were liquid compounds diluted with water. Liquid sensitizers and warm weather presented another challenge. Moisture from the sensitizer was liable to condense upon the daguerreotype plate during the process and spoil the image. Robert Bingham, chemical assistant to Michael Faraday at the Royal Institution of Great Britain, found a remedy for this

⁴²⁷ George Thomas Fisher [Jr.], *Photogenic Manipulation: Containing Plain Instructions in the Theory and Practice of the Arts of Photography, Calotype, Cyanotype, Ferrottype, Chrysotype, Anthotype, Daguerreotype, Thermography*. By George Thomas Fisher [Jr.] Illustrated by Wood Cuts. London: Published by George Knight and Sons ..., 1843 (Printed by Stewart and Murray), 1843: 45.

⁴²⁸ C. Laborde, "Moyen certain de prévenir le voile des substances accélératrices, et de donner plus de sensibilité à la couche impressionnable." *L'Echo du monde savant, travaux des savants de tous les pays dans toutes les sciences*. 11, no. 13 (Jeudi, 15 Août 1844): 304. Due to Laborde's discovery Daguerre's process was not incorporated into practice and has heretofore received little attention.

problem with liquid accelerators when he introduced slaked lime as a medium to dilute bromine and chlorine compounds in 1846. Sensitizers with slaked lime, or calcium hydroxide, were referred to as dry sensitives and they emerged as the quickstuff of choice by the 1850s.⁴²⁹ They offered much better plate-to-plate regularity because they could retain their halogen vapours at a uniform concentration for weeks before requiring replenishment. The development of mixed halogen accelerators to combine the speed advantage of bromine with the tonal qualities chlorine, and the search for uniformity of action with them is the focus of the next section.

⁴²⁹ Quickstuff or simply quick is a term used by daguerreians for chemical accelerators.

5.6 Sensitizing Accelerators: Mixed Halogens

The previous sections of this chapter have investigated chemical acceleration up to 1845. The alterations in the sensitizing methods of one, accomplished, practitioner effectively illustrate the advancement in sensitizing technique from the mid-forties to 1850. Jean-Baptiste-Louis Gros, chargé d'affaires for the French government, used the daguerreotype process while on diplomatic missions to record views in Bogota Colombia in 1841, Athens Greece in 1850, and London England in 1851. He published his own treatise, and contributed to others, and from these volumes it is clear that he used different sensitizing methods in the years 1844, 1846, 1847 and 1850, each method incrementally improving on the former to attain the desired speed of bromine, and tonal qualities of chlorine into a uniform, long-lasting, transportable, and uncomplicated sensitizing system that did not require constant maintenance.

Baron Gros, on returning to Paris from South America, published a thirty page pamphlet that explained the theory of the daguerreotype and detailed the latest advancements in 1844.⁴³⁰ The section on chemical acceleration details a new methodology developed by the daguerreian partners, Marie-Charles-Isadore Choiselat and Stanislas Ratel. They deposited a sealed packet with the French Academy of Science, on May 30, 1842, to claim priority of their method.⁴³¹ Their accelerator was a mixture of bromine and bromoform vapours *injected* into the sensitizing box; the purpose being to eliminate moisture from the system. A graduated glass syringe, made to fit the cap of half-filled bottles containing saturated solutions of each substance, was used to draw out a measured amount of the vapours that formed above the surface of the liquids. Choiselat, the chemist of the two partners, then injected the vapour into a Foucault-style sensitizing box

⁴³⁰ *Essai de théorie daguerrienne et résultats pratiques par un Profeseur de sciences*. J. B. Gros, 1844.

⁴³¹ *Compte rendus hebdomadaires des séances de l'Académie des sciences*. (May 30, 1842): 840. At the May 30 meeting, the academy accepted three sealed packets on deposit; one from Messrs. Choiselat and Ratel, another from M Gros, "chargé d'affaires de France à la Nouvelle-Grenade" and a third unrelated to daguerreotypy.

through the attached tube, (originally designed for bromine water). They had worked out the precise quantity required for the most common sized plates.⁴³²

For a $\frac{1}{4}$ plate, 1 $\frac{1}{4}$ cc bromine vapour, plus $\frac{3}{4}$ cc bromoform vapour
a $\frac{1}{2}$ plate, 2 $\frac{1}{2}$ cc bromine vapour, plus 1 $\frac{1}{2}$ cc bromoform vapour
a full plate, 4 cc bromine vapour, plus 2 $\frac{1}{2}$ cc bromoform vapour

Charles Chevalier, the Parisian optician, published his own pamphlet in December 1847. It was a compendium of working methods by the most accomplished daguerreians of the day, who, not so coincidentally used Chevalier's lenses for their work. The volume served as both an informative manual of photography and a promotional advertisement for the lens maker.

Baron Gros submitted his contribution to Chevalier on October 1, 1846, providing full details of his methods.⁴³³ He humbly admitted that he had invented nothing, and that his success was due to continued practice using the best materials and methods developed by others. Gros declared that he never made portraits; all of his images were views of Paris or the places he visited while on diplomatic missions. He reminded Chevalier that his successful images of the Panthéon, the port of Saint-Denis, Notre-Dame etc., were only possible because, when he wished to take a view, he always prepared six plates in his workroom before setting off. One or two, or perhaps three trials would be enough for him to know the correct camera exposure, leaving four or so plates in reserve to expose correctly.⁴³⁴ His sensitizing method in 1846 was as complicated as any ever used. For iodine he used a sensitizing box built after Séguier's plan with an iodine saturated board, this he followed with chloride of iodine applied with a specially made box of his own design, and finally he injected bromine and bromoform

⁴³² *Essai de théorie daguerrienne et résultats pratiques par un Profeseur de sciences*. J. B. Gros, 1844: 20. Choiselat and Ratel presented their theory of the daguerreotype to the Académie des sciences in 1843.

⁴³³ Charles Chevalier, *Recueil de mémoires et de procédés nouveaux concernant la photographie sur plaques métalliques et sur papier*. Charles Chevalier, 1847: 1-15.

⁴³⁴ Gros would develop the plates on location to ensure his exposures were correct. Fixing and toning could wait until he returned to his workroom.

vapour (the same method as Choiselat) into a third style box of Foucault's design. Gros provided figures with explanations to accompany his text (Fig. 58).

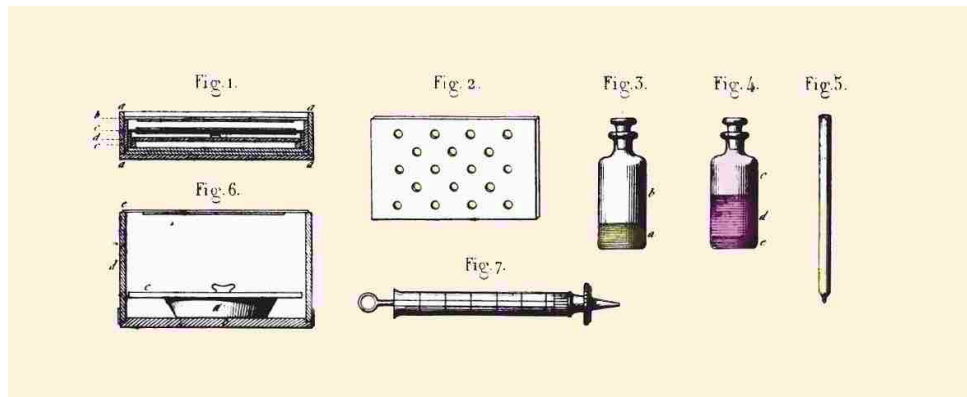

Figure 58. Baron Gros' apparatus (enhanced with colour), *Recueil de mémoires et de procédés nouveaux concernant la photographie sur plaques métalliques* 1847.

In the bottom of Gros' chloride of iodine box was a porcelain tablet with eighteen "hazel nut sized" depressions (2). With a pipette (5), he placed a few drops of pure undiluted chloride of iodine in each depression and covered it cotton wool and a flat lid (6c). The tablet and lid were placed in the bottom of a twelve-inch tall wooden box (6) that had a seam around the lower perimeter to allow Gros to remove the side walls of the box, quickly remove the flat lid, and replace the box sides. After two minutes precisely had elapsed, the iodized plate received its coating of chlorine vapour. While this was proceeding, Gros drew 1 cc of bromine (4) and 2 cc of bromoform (3) into the syringe (7) and injected it into the third sensitizing box (not illustrated). The proportions of bromine and bromoform were necessarily different with that of Choiselat and Ratel due to the chlorine combined on the plate. The illustration of the apparatus and accompanying description perfectly describe the painstaking and complicated process Gros was willing to endure for image quality. He continued to modify and adjust his methods to simplify the process but some of the alterations he tried had negative consequences.

Chevalier received an addendum from Gros dated July 10, 1847, in time to be included in the pamphlet.⁴³⁵ Gros acknowledged that his application of chloride of iodine was very complicated and that his attempts at simplifying the process by injecting chlorine vapour into a box, as he had done with bromine and bromoform, was impractical due to the large volume of vapour required. Furthermore, when he tried to use chloride of iodine diluted with water in the Foucault style sensitizing boxes, (liquid quicks were easier and more convenient to make ready when travelling), he suffered a hundred failures, with blue toned images due to the excess moisture.⁴³⁶ He then summarized his thoughts on sensitizing:

I am convinced that the vapours of pure chloride of iodine provide the most vibrant colours that we have been able to obtain thus far in photography, and in adding the bromine and bromoform, the plate acquires the greatest sensitivity to light.⁴³⁷

The colours that Baron Gros was able to render on his plates using chlorine and bromine in combination are remarkable indeed and are an excellent indication of what is possible when chlorine and bromine halogens are in perfect balance. Janet Buerger, while looking at one of his full-plate views of Paris described them as “pearly, cream-colored highlights set among soft, iridescent pink and peach upper-midtones”.⁴³⁸

Printed among the pages of Chevalier’s pamphlet were three improvements that Gros incorporated into his own practice. The first, from M. Laborde, being the addition of ether vapour to the mercury vapour during development, which is addressed in the chapter on latent image development.⁴³⁹ The second, from M. Rochas, being the practice of galvanizing pure silver onto the plate to attain a more perfectly polished surface, which is covered in the chapter on the silver plate.⁴⁴⁰

⁴³⁵ Chevalier, *Recueil de mémoires*: 51-8.

⁴³⁶ Laborde made the observation that sensitizing with chlorine is even more susceptible to moisture than bromine. *L’Echo du monde savant*. 1844.

⁴³⁷ Chevalier, *Recueil de mémoires*: 52.

⁴³⁸ Janet E. Buerger, *French Daguerreotypes*. Chicago; London: University of Chicago Press, 1989: 156.

⁴³⁹ Chevalier, *Recueil de mémoires*: 56-7.

⁴⁴⁰ Chevalier, 65-75.

The third improvement, from Mr. Bingham, relative to sensitizing accelerators is the use of *bromure de chaux* or bromine mixed with slaked lime (calcium hydroxide). Warren Thompson, the expatriate American daguerreian living in Paris, submitted this improvement to Chevalier for inclusion in Chevalier's pamphlet. His note is dated February 9, 1847, and he credits the discovery to Robert Bingham of London.⁴⁴¹ The great advantage of Bingham's dry sensitive is that slaked lime is able to absorb a great deal of bromine and release the vapour at a uniform rate. Thomson added that it was very easy to replace bromide of iodine or chloride of iodine with the new substance, and that "Mr. Bingham assured me that the use of his compound was as simple as could be, if one had a sensitizing box with a tight seal".⁴⁴²

This was welcome news for Baron Gros. Dry sensitives were the inspiration for Gros to completely re-design his sensitizing boxes. Their compactness made them ideal for travel. They could be carried in any position without spilling, and they lasted a year or more before needing to be replenished. Gros also discovered that he could combine chlorine and bromine with lime into a single sensitizing box, reducing his apparatus from three sensitizing boxes to two and significantly simplifying his process:

A long experience has led me to believe that pure chloride of iodine was the substance that gave daguerreian images the warmest and most brilliant tones, and I used it constantly despite the difficulties I had using rather complicated apparatuses. But I believe I have succeeded in making it play an important role in the preparation of the sensitive surface, without changing the method used by everyone else. I make the bromide of lime absorb some chlorine...This forms evenly on the plate itself and gives me such good results.⁴⁴³

⁴⁴¹ Chevalier, 44-5. Robert Bingham, at the time of his discovery, assisted Michael Faraday at the Royal Institution. Around 1855 he moved to Paris to join in partnership with Warren Thomson. Bingham's Bromide of Lime came to be known as part of the American Process due to Warren Thompson, the American in Paris.

⁴⁴² Chevalier, 45.

⁴⁴³ Jean-Baptiste-Louis Gros, *Quelques notes sur la photographie: Sur plaques métalliques*. revised 2nd edition, July 1850 ed. Paris: Roret, 1850: 39.

Baron Gros' excellent results were achieved by careful testing to determine the correct balance of iodine and chloro-bromine for every situation. His newly designed sensitizing boxes had the added advantage of allowing him to prepare several combinations of sensitizing times on a single plate by masking the surface sequentially. On a full-plate, he applied three levels of iodine (150, 100, and 50 seconds) by replacing the cover glass of the box with three strips of wood of equal width. He withdrew the first strip, counted 50 seconds, then withdrew the next, counted another 50 seconds and withdrew the final strip. After 50 more seconds he transferred the plate to the second sensitizing box. He then added three levels of chloro-bromine (60, 40, and 20 seconds) perpendicular to the iodine by drawing out the cover glass incrementally in 20-second intervals. Returning to the first box, he applied the final iodine as one uniform overall coat of 80 seconds. The test plate then had nine distinct combinations of halogens appearing in different hues. One section, Gros reported, would be the best overall, others fair, and some very poor. Gros used the times determined from the best section, to prepare all the plates that particular day, but he was careful to advise, that on the following day the times may need to be very different due to the circumstances of subject matter and weather.⁴⁴⁴

A recreation of Gros' 9-section sensitizing test provides excellent evidence of the differences in speed, tone and contrast obtainable with different combinations of iodine and chloro-bromine. Immediately apparent is that the best tone reproduction of the colour wheel occurs in centre-middle and centre-right sections. The top left section is slightly brighter but lower in contrast than the centre section. The top-centre and top-right sections are over-exposed and the remaining sections are underexposed (Fig. 59).

⁴⁴⁴ Gros, *Quelques Notes sur la photographie*: 2nd edition, 1850: 73-77.

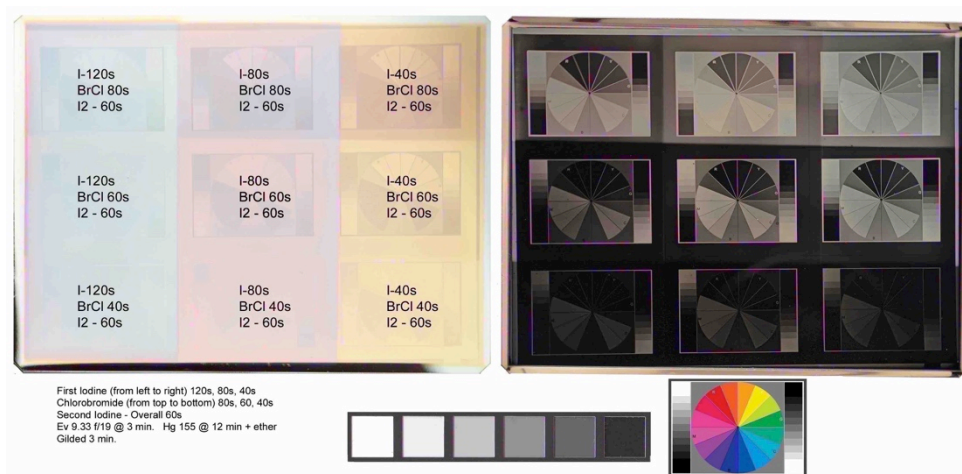

Figure 59. DagTest 4-24-2015. Baron Gros' 9-section sensitizing testing method.

The brightness of the greyscale steps of the top two rows (being the best six sections) is plotted against the reflected brightness of the steps in the test target (see Appendix B, p 385).⁴⁴⁵ The graphs indicate that the 80-second iodizing is twice as sensitive as the 120-second iodizing, and this is confirmed visually. The plate was photographed before fixing to record the colours for the different sensitizing times, so in terms of colour, a plate sensitized to a final colour of magenta, *provided the dose of chloro-bromide is sufficient*, will give the greatest sensitivity.

The previous chapter on iodine sensitizing shows that when used alone, the plate speed and tone is best when the layer also appears magenta. This reinforces the finding that maximum sensitivity, with or without quickstuff is related to light absorption, as determined by the coating colour. In view of this, it is now possible to understand why Schreiner found the recommended colours and proportions of iodine and bromine used by daguerreotypists to “all be different” when he surveyed the literature.⁴⁴⁶ If a light yellow coating is given for first iodine, a proportionally longer second iodine time is required to bring the plate to the same

⁴⁴⁵ This was determined by L*a*b* values from the digital image with Adobe Photoshop® CS5.

⁴⁴⁶ Charlie Schreiner, "In Their Own Words." *The Daguerreotypist: a Newsletter for Contemporary Daguerreotypists* (1998). <http://daguerre.org/resource/dagtypist/cs06-15-98.html>. (Date accessed, 30 March 2012)

sensitizing hue after bromine. If a plate is sensitized with reddish appearing first iodine, the plate will require proportionally shorter second iodine after bromine to achieve the same hue. Furthermore the spectral curves for magenta layers, with or without quickstuff, are nearly identical (Fig. 60). This indicates that there is no difference for each in terms of the colours that can be recorded, or spectral response; the only difference is the tremendous gain in speed (60x) with the addition of bromine.⁴⁴⁷

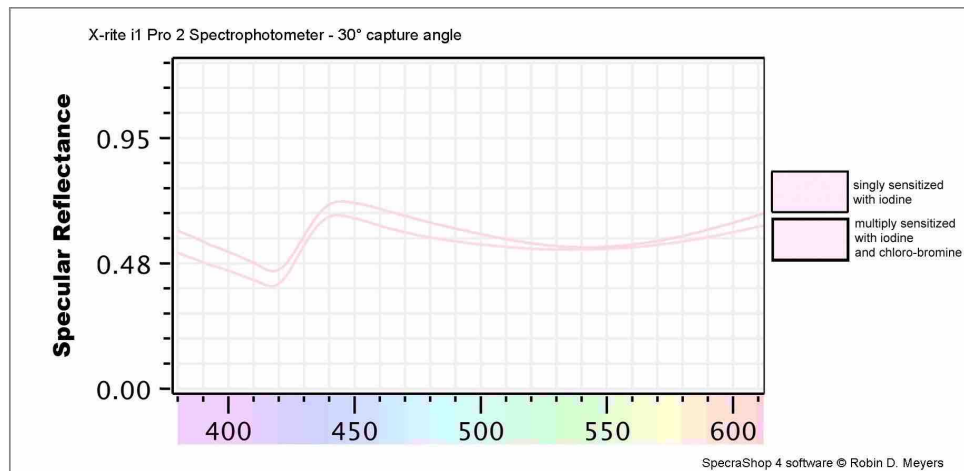

Figure 60. Graph of singly sensitized vs. multiply sensitized magenta layers.

When the colour of the completed sensitized layer changes from yellow, to magenta, to blue, with increasing iodine time, the hue of the image shifts dramatically with chloro-bromine quick, from cool blue, to warm yellow, to warm pink. The upper left section of the DagTest 4-24-2015 conforms to Janet Buerger’s description of “pearly, cream-colored highlights set among soft, iridescent pink and peach upper-midtones”. Baron Gros noted that sensitizing times are affected by the perfection of the plate’s polish, temperature and concentration of the sensitizing vapours, and due to these circumstances, the best method to judge the application of the halogens was by its colour. When sensitizing a plate, Gros recorded the time required during the first iodizing to reach the point at which it appeared “red

⁴⁴⁷ The slight difference between the two curves is due to the colour of the incident daylight during the measurement. The singly sensitized curve was measured with 5236°K illumination, the multiply sensitized curve with 4929°K illumination.

turning to pink”. He then quickened the plate over chloro-bromine until it appeared pink approaching violet. The second iodizing was for two-thirds of time required for the first iodine, because at this point the plate had to be handled in darkness. His preferred colour of the plate after the final iodine exposure was “steel blue, almost colourless”.⁴⁴⁸ The closest match to the colours described by Gros in DagTest 4-24-2015 occur in the first row, first column, where the plate was given 120 seconds first iodine, 80 seconds chloro-bromine, and 60 seconds final iodine.

Spectrophotometer readings graphed in figure 61 for this section and the right adjacent section (the most sensitive combination) show that the steel blue almost colourless section absorbs less light across the spectrum, which explains why this combination requires twice as much exposure in the camera. Interestingly, though slower working, it has a very uniform response across the spectrum above 450 nanometers.

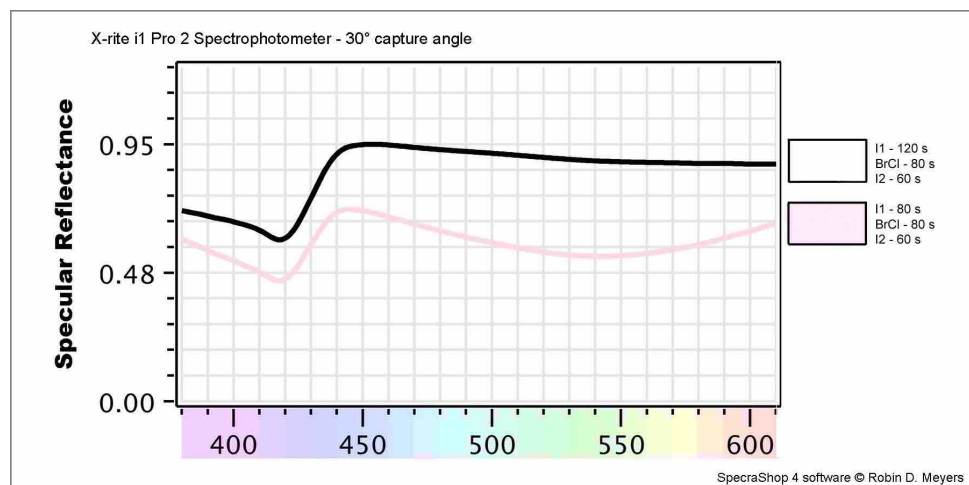

Figure 61. Graph of Baron Gros' preferred sensitizing (black line) compared to the fastest working combination (magenta line).

It is understandable that Gros preferred the slower “steel blue” sensitizing colour because he rarely made portraits, only landscapes. Maximum sensitivity was not a concern, as he desired the warm-toned images obtained with increased first iodine. Another advantage of a blue coating is that it absorbs *less* blue light than a yellow

⁴⁴⁸ Gros, *Quelques Notes sur la photographie: Sur plaques métalliques*. revised 2nd edition, July 1850 ed. Paris: Roret, 1850: 72. After camera exposure and mercury development, but before fixing, it is possible to view image in light for a brief period without harming the results.

or magenta coating. This helps to avoid overexposed skies while simultaneously allowing for enough exposure to record the less actinic landscape colours of green and brown. Gros used sensitizing colour as a means of controlling the contrast in his images. A sunlit scene in Athens, or anywhere for that matter, has a brightness range of approximately 160:1, whereas in a north facing portrait studio, in the northern hemisphere, the maximum contrast ratio is 60:1. In studio lighting conditions, the magenta coating is ideal, both for speed and correct contrast rendering a full range of values from light to dark. If a blue coating is used, the corresponding contrast of the portrait is dull and leaden.

Gros had worked out his preferred sensitizing colours at the close of the 1840s. His last report of a modification to his sensitizing substances was in 1851, in *La Lumière*, where he recommended the addition of magnesia to the lime.⁴⁴⁹ Samuel Dwight Humphrey in 1858 noted that bromide of magnesia was particularly adapted to hot climates and was used in America by a few who considered it a well guarded secret, though plain bromide of lime was “the principle accelerator in used in the American practice, and is the best of all dry combinations at present employed”.⁴⁵⁰

Valicourt, in *Nouveau manuel complet de photographie*, reviewed over fifty variations of chemical accelerators as they evolved over a ten-year period and one can clearly understand the evolution from liquid, to vapour, to dry media during the 1840s for managing the chemicals. It is the most comprehensive text on accelerators with exact formulae given and attribution for the innovator of the method provided. An unedited English translation was printed over several numbers of *The Photographic and Fine Art Journal* in 1854. The review concludes with a ranking from slowest to quickest for all of the variations of accelerators as follows: Chloride of Iodine, Chloro-Bromide of Iodine equal to Bromides of Iodine,

⁴⁴⁹ Jean-Baptiste-Louis Gros, "Chambre obscure blanchie à l'intérieur. Iode et substance accélératrice." *La Lumière* 1, no. 3 (Février 23, 1851): 9.

⁴⁵⁰ Samuel D. Humphrey, *American Hand-Book of the Daguerreotype ... Containing the Daguerreotype, Electrotype And ... Other Processes ... Fifth Edition*. New York, 1858: 77-9.

Bromine water, Bromoform, Bromide of Lime, and finally Chloro-bromide of Lime being the most prompt agent.⁴⁵¹

Humphrey's 1858 edition of *American Handbook of the Daguerreotype*, similar to Valicourt's text, also included an overview of chemical acceleration describing the relative merits of a variety of accelerators used in the 1850s.⁴⁵² Distinctly different is that while some formulae are given, many are presented with proprietary names, such as Roach's Triple Compound, Wolcott's American Mixture, Meade's Accelerator and Gurney's American Compound, indicating that sensitizing practice had evolved from chemical preparations performed by the operator to commercially prepared, ready-to-use substances, comprised of iodine chlorine and bromine; the formula very likely unknown to the photographer. Daguerreotypy had reached the point of commercial standardization and there was little change in sensitizing materials and methods throughout the industry for the remainder of the nineteenth century.⁴⁵³

⁴⁵¹ Edmund de Valicourt, *Nouveau manuel complet de photographie sur métal, sur papier et sur verre*. Roret, 1851:113-14.

⁴⁵² Humphrey, *American Hand-Book of the Daguerreotype*. New York, 1858: 113-130.

⁴⁵³ Bromine mixed with lime has been the preference of nearly all contemporary practitioners. In 2003, I introduced silica gel as a replacement for the lime (calcium hydroxide). It performs the same function as lime, merely as a dry medium contributing no photographic effect, but is far easier to handle and prepare the sensitizers than lime. Another advantage is the concentration of the accelerator is readily known by the colour of the silica gel as it absorbs and loses halogen vapour.

5.7 Sensitizing Accelerators: Conclusion

Antoine Claudet using chlorine, and John Frederick Goddard using bromine, have emerged through written histories to be recognized as the inventors of chemical acceleration, although the full story, according to John Johnson, was, "Too jumbled a mass to pass for history of great interest, or contribution the History of Photography".⁴⁵⁴ This chapter has un-jumbled the mass and provided new information in regards to the earliest days of chemical acceleration. In 1841, the year preceding the establishment of London's first commercial studios, the developmental work occurred in a very small area in Holborn Bars, with all of the competing interests in close proximity. At this time, New Yorkers, Wolcott and Johnson through their developments in optics, lighting, and chemical accelerators, and through the efforts of Johnson's father William, significantly influenced the progress in London.

A clearer understanding of how Daguerre's Patent in England has affected the history of chemical acceleration, and to a greater extent the understanding of the evolution of the daguerreotype is an unexpected but important outcome of my research for this chapter. John Frederick Goddard, shown via his letters to the Royal Society, was restrained from publishing clear details of his working methods to protect the interests of the patent franchisees. This concealment of the working details and his *Literary Gazette* announcement, reinforced by Hughes' letters claiming Goddard's priority in 1864, have established him as the innovator and user of bromine in late 1840. Claudet, unrestricted by patent concerns, freely published his chloride of iodine discovery in 1841. These are the textual records that account for Goddard and Claudet's position in the history of photography. Goddard's details for preparing the A & B formula placed with the Royal Society in 1864, revealed here for the first time, prove that he never actually used or recommended bromine in the early days of photography. The reason, clearly

⁴⁵⁴ John Johnson in response to Claudet's "Letter to Mr. P. Foster." *The Philadelphia Photographer*, no. V (1868): 174.

understood by replicative experiments, is that it was unreliable, difficult to control, and tended to yield bluish solarized images with veiled shadows, though it was capable of producing plates with great speed. Between 1841 and 1845, daguerreians tried several methods to mitigate the veil of bromine and control its volatility, and J. H. Mifflin's letter of 1843 is evidence that chlorine was preferred for its certainty at this time. Comparing plates prepared with iodine against iodized plates accelerated with chlorine or bromine shows a 5X speed increase with chlorine, and a 60X increase with bromine. In terms of image tone, the experiments clearly show that chloride of iodine produces clear, warm-toned images, as reported by Claudet. Bromine however, in the absence of a second iodine step tends to produce bluish and veiled images. Letters, documents and historic images show that as late as 1844, bromine acceleration had yet to be perfected. The significance of this is that daguerreotypes with muted, veiled and bluish tonalities from imperfect brominizing could have been produced in 1843 or 1844, rather than from the incunabula period of 1839 or 1840 as has often been assumed. The daguerreotype views attributed to Jabez Hogg, of *Greenwich Hospital* and *Folkestone Viaduct* (completed in late 1843) exhibit imperfect technique and reinforce this last point. Insight provided here into the effects of imperfect brominizing lead to a clearer picture of Daguerre's later research in controlling bromine veil.

Daguerre's last known image taken from his window in 1844, *View of Bry-sur-Marne*, has a circular bright area in its central left region that has puzzled conservators and curators. In testing Daguerre's 1844 recommendations for applying noble metals to plates before sensitizing to prevent the veil of bromine, I poured gold chloride solution into a retaining ring on a polished plate. The result has a remarkable similarity to Daguerre's image, possibly indicating that the circular area was a deliberate act to localize the noble metals on the plate in order to show their effect. The experiment proves that Daguerre's complicated method worked, that he understood metals chemistry, and that he was still working on

solving problems with the process well after he had received his pension and retired in Bry-sur-Marne.

I have shown that throughout the 1840s daguerreians continually modified their sensitizing apparatus and mixtures to attain quick repeatable images. They understood that chlorine compounds produced better tones, meaning warmer images with plates less liable to be solarized, and that bromine provided better speed, as much as a twelvefold increase according to Fizeau. Naturally, achieving maximum sensitivity and a pleasing tone was desirable. This is shown in the writing of Jean-Baptiste-Louis Gros who described different sensitizing methods in the years 1844, 1846, 1847 and 1850, each new method an improvement over the former to combine chlorine and bromine into a transportable, and uncomplicated, low-maintenance sensitizing system.

Gros' *Quelques notes sur la photographie: Sur plaques métalliques* contains a sensitizing test he devised that created nine distinct combinations of iodine and chloro-bromine on a single plate. Each combination would yield better or worse images in terms of speed, contrast and image colour, with one section best of all for the subject he photographed. His preferred sensitizing colours were pink for first iodine, violet after chloro-bromine and steel blue almost colourless after second iodine. DagTest 4-24-2015 replicates this experiment and by documenting the colours of the sensitizing combinations before fixing the plate, using a camera and spectrophotometer, explicit details of cause and effect based on these variables have been determined. This test confirms that maximum photosensitivity occurs when the final sensitizing colour presented to the scene appears magenta. This same colour produced with only iodine is also the quickest coating for singly sensitized plates as shown in the iodine chapter, though sixty times slower than multiply sensitized plates. The test shows that even if the coating appears magenta, maximum sensitivity is only achieved when the accelerator is at its optimum, which is difficult to determine by color changes on the plate and best determined by timing the quickstuff. A very informative result of this test is the

change in image tone from cool, to warm, to pink as the coatings shift from yellow, to magenta, to blue. The last observation, determined visually and from spectrographic sampling is that the steel blue coating resulting from the heaviest iodine dose requires twice as much light exposure as the magenta coating because it absorbs less blue light. This tends to limit solarization with high contrast outdoor scenes and is the sensitizing colour that Baron Gros, renowned for the pearlescent pink upper middle tones in his landscapes, preferred.

A seemingly infinite variety of quickstuffs and formulae incorporating mixed halogens entered into the daguerreian marketplace throughout the 1850s and beyond. Sensitizing practice had evolved to prepared brand-name mixtures but the simplest, most reliable, and most preferred quick was bromine with lime and has remained so into the contemporary daguerreian era. Irving Pobboravsky, and a few others, have experimented with mixed halogens but ultimately have abandoned the idea. My work to understand the relative speeds possible with chlorine and bromine is the first to be done since the mid-nineteenth century and has greatly contributed to the interpretation of the historic literature.

Once sensitized, the plate was ready for exposure. Under normal circumstances, the plate would be exposed immediately after sensitizing, but it is possible to delay the exposure if necessary for hours or even days after sensitizing when working away from the darkroom and studio. Furthermore, Henry Goode, chemical assistant to Professor Draper at the University of New York, relayed Draper's observation that the sensitivity and uniformity of the plate improved with keeping and advised that French plates after sensitizing be kept for half an hour before use, and with American-made plates being less pure, a full hour or more delay gave favourable results.⁴⁵⁵ In my experience plates kept for two hours are twice as sensitive as freshly sensitized plates, but with longer keeping small

⁴⁵⁵ W. H. Goode, "The Daguerreotype and Its Applications." *American Journal of Science and Arts* (1841): 140-41. Draper had observed the entropic re-ordering of silver iodide, a phenomena now known as Ostwald ripening. Over time, the silver halide grains coarsen into fewer and larger grains from initially smaller ones. This accounts for the gain in photosensitivity.

localized white rings form around dust specs on the plate.⁴⁵⁶ The reason for this is a ripening or coarsening of the halide crystals on the plate over time. Small halide clusters are more entropic and having a greater surface area to mass ratio, and tend to combine with each other to form fewer but larger particles over time. This is a spontaneous process known as Ostwald ripening. Photographic film manufacturers maintain the gelatine emulsion at melting temperature for extended time to promote Ostwald ripening and produce high-speed, large-grained films. I became aware of this phenomena when preparing chlorine exposed daguerreotype samples to replicate a mechanism of image deterioration peculiar to important images by Southworth and Hawes.⁴⁵⁷ Plates exposed to chlorine were covered with silver chloride particles. Over a ten-day period the surface of the plate became increasingly more hazed. In summation, I have shown how sensitivity and image tone is affected by different accelerating halogens, but the interval between sensitizing and exposure is another variable affecting speed and image quality that must be considered. The next chapter addresses optics technology, and its influence on the same.

⁴⁵⁶ One negative effect of Ostwald ripening is that the coarsening is accelerated around surface defects such as dust particles when exposure is delayed for several hours or days after sensitizing. This results in white spots or ringed artefacts in the image, which are frequently seen in landscape images. White rings are commonly seen in the landscape views of Jules Itier. For example his *Entrance gate at the Temple of Denderah, Egypt*, in the J. Paul Getty Museum, accession number 84.XT.184.2, has several throughout, indicating that he had sensitized his plates some time before use.

⁴⁵⁷ Michael Robinson and Edward P. Vicenzi, "A Twin Paradox: A Study of Preservation and Disfigurement of Southworth and Hawes Daguerreotypes." *Topics in Photographic Preservation* 16 (2015): 196-97. Appendix A, p 366.

6.1 Optics: Overview

The silver plate and sensitizing variables affect photographic speed, tone and spectral sensitivity. This chapter focuses on optics, which are integral to the photographic system. Mirrors and lenses influence exposure time and image quality and must be considered for their contribution to the final results. Advances in photographic optics were driven concurrently by the quest for speed and sharpness over the entire field of view. This will be explained later but in general short focus lenses work faster by projecting a brighter image to the sensitized surface than longer focus lenses of the same diameter. This gain comes at the expense of increased optical defects such as spherical aberration, chromatic aberration and linear distortion. In addition to its effects on image quality, the lens is the sole component in the daguerreian system that directly influenced daguerreotype plate size, as this chapter explains.

The chapter begins with an investigation into Daguerre's knowledge of optics. This, along with information about lens achromatism, lens cell orientation, apertures and exposure times gleaned from the literature combine to present a clear understanding of the development of Daguerre's first commercial lens and camera. Lens development is directly linked to the production of flint glass for achromatic optics. Discussed here is the advantage the French had over the English in optics technology due to government encouragement in France and excise taxes that restricted innovation in England. The records of Henry Fitz Jr., American telescope maker who surveyed the optics industry in England and France and applied his skills to American daguerreotypy and astronomy, support this point.

Fifteen-minute exposures on average were necessary with Daguerre's achromatic lens, which produced images with astonishing detail and resolution.⁴⁵⁸

⁴⁵⁸ Chevalier's lens was a crown and flint glass achromatic lens with an 81 mm diameter of 380 mm focal length. An aperture of 27 mm diameter was placed in front. The *f*/no. is approximately *f*/14. In comparison, John Draper's non-achromatic lens intended for portraiture was 8-inch focus with a diameter of 3 1/2 inches, providing an aperture of *f*/2.2.

The artist and inventor, Samuel Morse, while examining Daguerre's views of Paris that seemed to him miraculous for their tone and detail, could not help but notice the effects of exposure time in the camera.

Objects moving are not impressed. The Boulevard, so constantly filled with a moving throng of pedestrians and carriages, was perfectly solitary, except an individual who was having his boots brushed. His feet were compelled, of course, to be stationary for some time, one being on the box of the boot-black, and the other on the ground. Consequently, his boots and legs are well defined, but he is without body or head because these were in motion.⁴⁵⁹

When Morse inquired if it were possible to take portraits of living persons, Daguerre replied with scepticism on account of the lengthy exposures ranging from five to forty minutes necessary with this lens.⁴⁶⁰ Daguerre understood that short-focus lenses would operate quicker but they were imperfect, producing images with spherical aberration and diffraction toward the edges.⁴⁶¹ He must have relaxed his optical standards occasionally, because John Lubbock reported to William Henry Fox Talbot that Daguerre had made a successful self-portrait sometime before October 1839.⁴⁶²

In the section on Daguerre's Lens, replications using materials and a lens concurrent with 1835 technology prove exposures as brief as seventy-five seconds

⁴⁵⁹ Samuel Finley Breese Morse, "The Daguerrotipe." *New-York Observer*, April 20, 1839: 62. This was the first eyewitness account of the daguerreotype published in America. A tremendous loss to our cultural heritage occurred when the daguerreotype of the bootblack along with two other images was destroyed by a botched attempt at conservation in the early 1970s. See Ulrich Pohlmann and Marjen Schmidt, *Das Münchner Daguerre-Triptychon. (The Munich Daguerre Triptych.)* Fotogesichte, Vol. 52, 1994: 3-13.

⁴⁶⁰ Samuel Finley Breese Morse, "Who Made the First Daguerreotype in This Country?". *The Photographic and Fine Art Journal* 8 (1855): 280.

⁴⁶¹ Nicéphore Niépce, M. Bonnet, and J.L. Marignier, *Niépce, correspondance et papiers*. Maison Nicéphore Niepce, 2003. p. 907. Daguerre's letter of October 12, 1829 illustrates Daguerre's knowledge of optics when he explained to Niépce, "The meniscus lens that you use does not help in perfecting the image because it does not completely eliminate the spherical aberration and is ineffective with refractive aberrations." Online at <http://www.niepce-letters-and-documents.com/book/#/906/> (Date accessed, 18, March 2017)

⁴⁶² John William Lubbock, "The Correspondence of William Henry Fox Talbot." Leicester: DeMontfort University, 1839. (Document no. 3968) In a letter dated November 2, 1839, Lubbock informs Talbot, "...though Daguerre said it was impossible. Daguerre has done a portrait of himself, said to be excellent." <http://foxtalbot.dmu.ac.uk/letters/transcriptDocnum.php?docnum=3968> (Date accessed, 22 March 2017)

were possible. This indicates that Daguerre was capable of making portraits with quick-working imperfect lenses, but there is no physical or textual evidence that Daguerre made portraits before 1839.⁴⁶³ It seems he was clearly motivated by a desire for full-field sharpness requiring a lens design that extended exposure times beyond the range of portraiture. He left portraiture for others to pursue.

Portraits from life were on exhibit at Claudet & Houghton's glass works at 89 High Holborn, London from the beginning of March 1840.⁴⁶⁴ In September that same year, John Draper of New York published his account on applying the daguerreotype to taking portraits.⁴⁶⁵ Draper used two simple magnifying glass lenses of sixteen-inch focus together to give a combined focus of eight inches. This combination reduced exposures but the lens was non-achromatic and difficult to work with. Non-achromatic lenses are incapable of bringing the various wavelengths of the spectrum to the same point of focus. What this meant for the daguerreotypist was that the focus on the ground glass of the camera was not the same as required for the plate. This was described in the literature as *visual* compared to *chemical* focus and replications using non-achromatic optics prove that a significant post-focus adjustment of a half-inch or more was necessary.

⁴⁶³ A portrait of a M. Huet dated 1837 has been presented as Daguerre's work, but the attribution is contested. See André Gunthert and Jacques Roquencourt, "Note sur le portrait de M. Huet", *Études photographiques*, May 6, 1999, [Online], <http://etudesphotographiques.revues.org/299>. (Date accessed, 18 March 2017)

⁴⁶⁴ Times [London, England] 3 Mar. 1840: 3. The Times Digital Archive. <http://find.galegroup.com/ttda/start.do?prodId=TTDA&userGroupName=dmu> (Date Accessed, 1 Nov. 2014.) This is the first advertisement in a London newspaper by Claudet and Houghton concerning the daguerreotype. An excerpt reads... "Messrs. Claudet and Houghton, 89, High Holborn, beg leave to announce that having obtained a license from the patentee, they have on hand a collection of splendid specimens of this wonderful discovery, representing the most interesting monuments, ancient and modern, of Paris, Rome, and other cities, also panoramic views of these towns, landscapes, portraits taken from nature, &c."

⁴⁶⁵ John W. Draper, "On the Process of Daguerreotype and Its Application to Taking Portraits from the Life." *The London, Edinburgh, and Dublin Philosophical Magazine and Journal of Science* XVII, no. CIX (September 1840): 217-25. Five to seven minutes in diffuse light was reduced to forty seconds to two minutes by a system of illumination developed by Wolcott and Johnson and copied by Morse and Draper, and Goddard and Cornelius. The sitter was illuminated axially with sunlight directed upon the sitter by mirrors. To ease the eye strain the sunlight was filtered through blue glass or a trough containing blue copper sulphate solution.

Portraits made before 1842 with early optics, whether with refracting lens cameras or reflecting mirror cameras, were a mere fraction in size of Daguerre's whole-plate due to the limited field of acceptable sharpness. To explain this, the second part of the chapter on First Portraits illustrates the limitations and capabilities of these optics through replication using authentic cameras from the period.

Originally camera optics were based on designs developed in the field of astronomy.⁴⁶⁶ The first lens specifically developed for the requirements of photography in terms of speed and spectral sensitivity was the portrait lens designed by Josef M. Petzval and marketed by Voigtländer and Sohn in Wien (Vienna).⁴⁶⁷ The chapter closes with experiments that make explicit the optical signature of the famed German portrait lens, compared to its closest rival, the one by American optician Charles C. Harrison. Though essentially a copy, the American lens had significantly different resolution, contrast and tonal characteristics due to the different approaches each optician used to achromatize their lens. Petzval's portrait lens design, though copied by opticians in England, France and America, was not improved upon in terms of quickness and remained the primary lens for portraiture beyond the daguerreian era into the twentieth century.⁴⁶⁸

⁴⁶⁶ Daguerre's first lens, built by Chevalier was essentially a telescope lens mounted in reverse with an aperture in front and Wolcott's mirror camera was inspired by the Casgrain reflecting telescope.

⁴⁶⁷ Chevalier's portrait lens, the *Verres Combinés*, was the same as Daguerre's lens with an accessory front achromat to shorten the focus. Petzval designed his lens specifically achromatized for actinic light.

⁴⁶⁸ Dan Colucci, "The Petzval Lens." *The Journal: New England Journal of Photographic History*, no. 171 (2013): 39-58. Colucci estimates that Voigtländer and Sohn produced approximately 25,000 Petzval lenses between 1840 until 1920. This informative article is available online at <http://www.antiquecameras.net/petzvallens.html>. (Date accessed, 18, March 2017)

6.2 Optics: Daguerre's Lens

The contract between Niépce and Daguerre signed in 1829 stated that Daguerre's contribution of his newly designed camera, his talents and industry was equal to Niépce's yet to be improved Heliographic process. Later historians have not maintained the significance of Daguerre's contribution concerning optics. Gernsheim for example claimed that "Daguerre's much-vaunted camera turned out to be nothing fundamentally new" just a Wollaston periscopic meniscus improved by Chevalier (made achromatic) based on Daguerre's research.⁴⁶⁹ Mark Osterman, process historian at the George Eastman Museum, dismissively remarked that in 1829 "Niépce had invented photography...all Daguerre had to offer was a camera".⁴⁷⁰ Niépce, however, was convinced of the value of Daguerre's lens:

In order to obtain a decided success it is indispensable that the effect be accomplished as promptly as possible, this presupposes a great luminosity and sharpness in the image of the object; It would be necessary to have a camera [lens] as perfect as that of M. Daguerre.⁴⁷¹

This quote from Niépce's letter to Lemaître dated October 25, 1829 reveals two problems with the Heliographic process. The foremost issue was the photosensitivity of bitumen. Lemaître critiqued Niépce's views from nature taken at Gras in a letter dated October 12, and Daguerre agreed, that both sides of house were equally illuminated and the shadows were confused due to the lengthy exposure times.⁴⁷² The second problem was optics. Niépce had experimented

⁴⁶⁹ Helmut and Alison Gernsheim, *L.J.M. Daguerre: The History of the Diorama and the Daguerreotype*. 2nd revised ed. New York: Dover, 1968: 68.

⁴⁷⁰ Mark Osterman, February 21, 2012. Mark made this remark while lecturing on the history of the daguerreotype on the first day of a workshop I taught at the George Eastman Museum, Rochester N.Y.

⁴⁷¹ Victor Fouque and Edward Epstein, *The Truth Concerning the Invention of Photography: Nicéphore Niépce; His Life, Letters and Works* [in English]. New York: Tennant and Ward, 1935: 85. This source provides an English translation for Niépce's letter to Lemaître, dated October 25, 1829. The original French is transcribed online at <http://www.niepce-letters-and-documents.com/book/#/912/> (Date accessed, 18, March 2017)

⁴⁷² Fouque and Epstein, *The Truth Concerning the Invention of Photography: Nicéphore Niépce; His Life, Letters and Works* [in English]. New York: Tennant and Ward, 1935: 84. This again is the source for the English translation of a letter from Lemaître to Niépce, dated October 12,

with a three-element achromatic lens built by the Parisian optician Vincent Chevalier, but had abandoned it in favour of a simple meniscus lens designed by William Hyde Wollaston.⁴⁷³ Daguerre's letter of October 12 to Niépce reveals the extent of his optical knowledge. He advised Niépce that the meniscus lens was incapable of projecting a perfect image because it was not totally free from spherical aberration and it was “ineffective with refractive aberration”. Daguerre explained that light is modified by each body (glass surface) that it passes through, as in the case of a bi-convex lens or meniscus, which decomposes the light, and those effects were “visible on all the edges of your landscape photos”.⁴⁷⁴ He further explained that the edges were more blurred when the lens was positioned so the convex surface faced the subject.

Daguerre's use of the term “l'aberration de réfrangibilité” (refractive aberration) refers to chromatic aberration. Through a prism or lens, light is decomposed into its component colours by refraction. Violet light (380 nm) is refracted more than red light (760 nm) and the degree of refraction varies according to wavelength for all colours between violet and red as it passes through glass at an oblique angle. The effect is that all colours of the spectrum do not converge at the same point of focus with a simple bi-convex or meniscus lens; blue light comes into focus nearer the lens than green light, which comes into focus nearer than red light. Thought to be insurmountable by Sir Isaac Newton, the problem of chromatic aberration was resolved in the 1750s by English optician John Dolland who found that a convex lens of crown glass with a focal length of 4 inches, when cemented to a concave

1829. The original French is transcribed online at <http://www.niepce-letters-and-documents.com/book/#/908/> (Date accessed, 18, March 2017)

⁴⁷³ Corrado D'Agostini, *Photographic Lenses of the 1800's in France*. Bandecchi & Vivaldi, 2011: 62. The three-element achromat was made with two bi-convex crown lenses separated by a bi-concave flint lens. This combination would have greater spherical aberration than a meniscus.

⁴⁷⁴ D'Agostini, *Photographic Lenses of the 1800's in France*. 2011: 64-5. D'Agostini has translated Daguerre's letter to Niépce of October 12, 1839. In that same letter, Daguerre explained that in order to record sharp shadows, the exposure time must be within 15 minutes. The original French is transcribed online at <http://www.niepce-letters-and-documents.com/book/#/906/> (Date accessed, 18, March 2017)

lens of flint glass of 6 inch focus combined to form an achromatic doublet.⁴⁷⁵ Flint glass containing lead is denser than crown glass and therefore has a higher refractive index. The convex flint element served to disperse the shorter wavelengths of light and extend their focus to align with the longer wavelengths at nearly the same point. Daguerre's knowledge of refractive aberration and achromatism was most likely developed over weekly visits with Chevalier in the 1820s.⁴⁷⁶ These concepts are best illustrated with light ray diagrams. Figure 62 compares chromatic aberration with a simple bi-convex lens to an achromatic doublet made from crown and flint glass.⁴⁷⁷

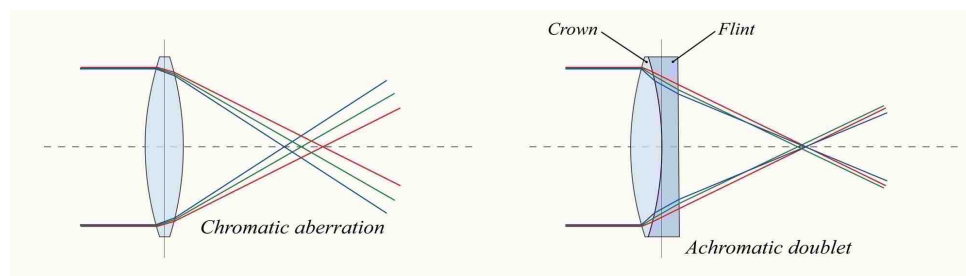

Figure 62. Chromatic aberration (left). Chromatic correction of focus with a crown and flint glass doublet (right). Illustration credit, Bob Mellish, Wikimedia Commons, 2006.

Niépce recognized that Daguerre's motivation and research tended toward perfection, meaning a singular, stable, and well defined camera image, rather than

⁴⁷⁵ Sir David Brewster and A.D. Bache. *A Treatise on Optics*. Lea & Blanchard, 1841: 76. The ratio of focus at 4.33 to 7.66 for crown-flint doublets became the standard formula for achromatic telescopes.

⁴⁷⁶ Charles Chevalier, "Éloge de Daguerre. - Documents historiques, lettres inédites de N. Niépce, etc.". Chap. Troisième Partie. In *Guide Du Photograph*. Paris, Palais Royale 158: C. Chevalier, 1854. 23.

⁴⁷⁷ Bob Mellish, "Chromatic Aberration Lens Diagram." CC-BY-SA-3.0 (<http://creativecommons.org/licenses/by-sa/3.0/>), via Wikimedia Commons from Wikimedia Commons 2006. (Date accessed, 11, June 2016)

Bob Mellish, "Achromatic Doublet Lens Diagram." CC-BY-SA-3.0 (<http://creativecommons.org/licenses/by-sa/3.0/>), via Wikimedia Commons from Wikimedia Commons 2006. (Date accessed, 11, June 2016) The human eye is most sensitive to green light (555 nm) while the daguerreotype is most sensitive to UV~blue light (<430 nm). If using a non-achromatic lens, images that appeared to be in focus on the ground glass would be out of focus in the daguerreotype because the actinic focus was at a point closer to the lens. This was referred to as visual vs chemical focus in nineteenth century manuals.

multiplicity by producing of a photo-engraved printing plate.⁴⁷⁸ At the time of their first meeting, Daguerre had not yet achieved a permanent camera image, but he had a far greater understanding of optics. Niépce's process with bitumen required days of exposure in a camera which resulted in blurred shadows as they moved with the earth's rotation. Daguerre advised that in order to arrest the motion of shadows, exposures had to be fifteen minutes or less.⁴⁷⁹ He was conscious of this because he worked with phosphorescent substances that were so rapidly altered by light as to be compared with an electric current.⁴⁸⁰ Though impermanent, Daguerre was able to observe the qualitative affects of the lenses he used on phosphorus images free from blurring due to lengthy exposures. His work with phosphorous informed his decisions in designing lenses in collaboration with Vincent Chevalier.

By 1832 Daguerre had placed all his other optics aside in favour of an achromatic doublet when he advised Niépce:

The most successful combination is an achromat with two lenses when glued together, forms a periscopic [meniscus] lens; and the aperture is determined by the diameter of the glass. The resulting sharpness is such that it outperforms everything we have, even better than contact images from engravings.⁴⁸¹

⁴⁷⁸ Fouque and Epstein, *The Truth Concerning the Invention of Photography: Nicéphore Niépce; His Life, Letters and Works* [in English]. New York: Tennant and Ward, 1935: 67. This source for the English translation of a letter from Niépce to Lemaître dated February 2, 1827. The original French is transcribed online at <http://www.niepce-letters-and-documents.com/book/#/750/> (Date accessed, 18, March 2017)

⁴⁷⁹ Niépce, N., M. Bonnet, and J.L. Marignier. *Niépce, correspondance et papiers*. Maison Nicéphore Niépce, 2003: 908. Letter 497 dated Paris, October 12, 1829. Daguerre to Niépce. Online at <http://www.niepce-letters-and-documents.com/book/#/908/> (Date accessed, 18, March 2017)

⁴⁸⁰ Fouque and Epstein, *The Truth Concerning the Invention of Photography*. New York: Tennant and Ward, 1935: 75. Niépce visited Daguerre in Paris while waiting for export papers for London and described his experiments with photo-luminescence in a letter to his son Isidore. Grant Romer has made experiments with phosphorous using a Wollaston camera obscura having an effective aperture of $f/6.6$. In answer to my question in October 2016 he confirmed that two minutes exposure are necessary to render a "photographic" looking image with phosphorous.

⁴⁸¹ Nicéphore Niépce, M. Bonnet, and J.L. Marignier, *Niépce, correspondance et papiers*. Maison Nicéphore Niépce, 2003: 1016. Letter 549 dated Paris, October 3, 1832. Daguerre to Niépce. Online at <http://www.niepce-letters-and-documents.com/book/#/1016/> (Date accessed, 18, March 2017)

The following spring, Daguerre sent his partner a drawing of a camera with a six-inch focus achromat mounted with the convex surface facing the scene and the diaphragm facing the plate. He explained, "By this arrangement, the light intensity is increased by one-half, at least". Daguerre's drawing is precise, down to the mounting screws and light ray tracings through the aperture mounted behind the lens (Fig. 63).⁴⁸²

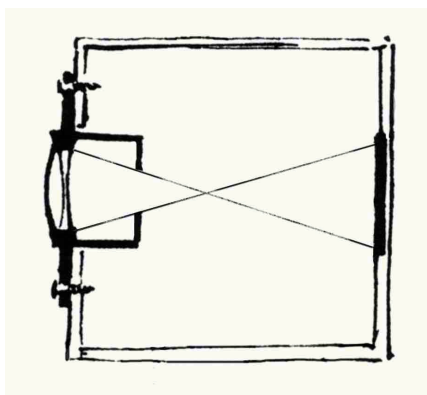

Figure 63. Drawing by Daguerre, sent to Niépce on April 19, 1833. From a reproduction in Kravets, *Dokumenty po istorii izobreteniiia fotografii*, 1949: 411.

If this drawing is to scale then the diaphragm behind this 6-inch (151 mm) achromat can be accurately figured at 20 mm in diameter and 40 mm behind the lens. Jacques Roquencourt estimated that a six-inch achromat in the above orientation would be equivalent to $f/4$, however based on the data from the drawing this is overly optimistic; the lens in this configuration is a little more than a stop slower at $f/6$.⁴⁸³

I have in my collection a six-inch achromat made by French optician Jean Theodore Jamin ca 1850. With a 20 mm aperture set into the lens tube 40 mm behind the lens, when viewed through the glass in the above orientation the

⁴⁸² D'Agostini, *Photographic Lenses of the 1800's in France*. 72. Corrado's source for his illustration is from Kravets, T. P. 1949: 411. Letter from Daguerre to Niépce, Paris, April 19, 1833. The illustration is also poorly reproduced in the catalogue, *Niépce, correspondance et papiers*, 2003: 1023. I have enhanced the illustration for clarity.

⁴⁸³ Jacques Roquencourt, "Daguerre et l'optique." *Études Photographiques* No. 5 (1998) endnote 24. Roquencourt's simulation overstates the effective apertures at $f/4$ and $f/6$ depending on orientation. This over-estimates the factor due to reversing the lens. I have shown the factor to be in agreement with Daguerre at 1.5X with apertures of $f/6$ and $f/7.5$ respectively.

aperture is magnified to 25 mm resulting in an effective aperture of $f/6$. With the lens turned backwards so the diaphragm faces the subject and the concave surface the plate, the image is less bright as the effective aperture becomes $f/7.5$, but the image is better resolved from corner to corner. This is precisely what Daguerre understood and relayed to Niépce. I have made images to test the performance and speed of a lens identical to Daguerre's 1833 optic. For DagTest 6-11-2016 (Fig. 64), the plates were sensitized only with iodine to explicitly show the image quality and exposure times possible with such an optic used as above and in reverse orientation.⁴⁸⁴ When mounted according to Daguerre's drawing, the daguerreotype (Fig. 64 top) is very sharp in the centre and rapidly falls out of focus due to spherical aberration; however, the exposure time necessary was *only 75 seconds*. With the lens reversed, (Fig. 64 bottom) the field of focus is flatter with better corner to corner resolution, as indicated by the clearly rendered architectural details and telephone wires in this view. It is however not as critically sharp as in the centre of the upper image, and the exposure time increased to 120 seconds.

⁴⁸⁴ A lux-meter placed at the focus plane measured 34 lux with the lens oriented as in Daguerre's diagram. With the lens reversed, the reading fell to 21 lux showing the light intensity was reduced by one-half, exactly as Daguerre explained in his letter to Niépce.

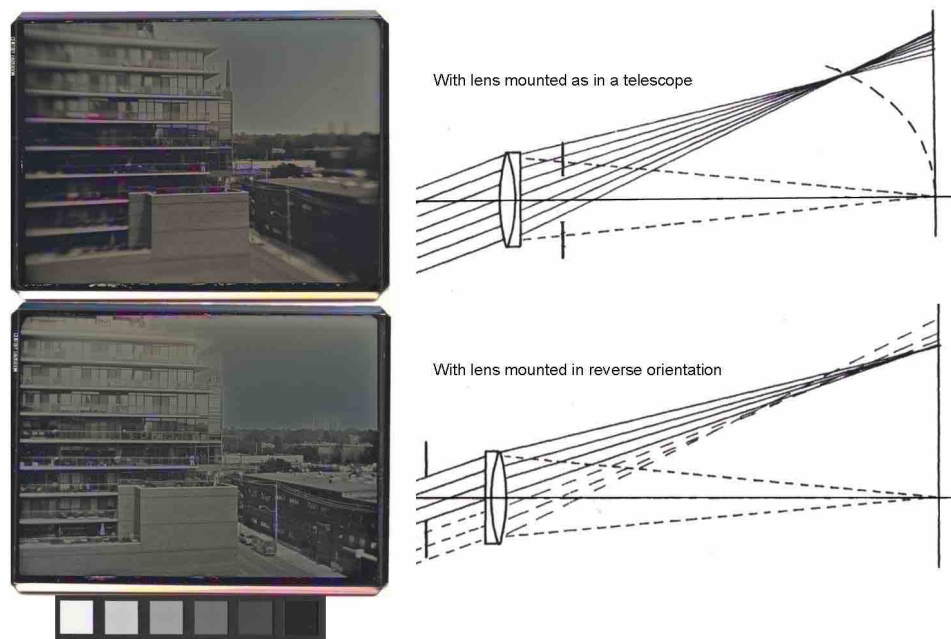

Figure 64. DagTest 6-11-2016. 75 seconds exposure (top), 120 seconds exposure with the lens reversed to project a flatter field (bottom). These images are quarter-plates.

Significantly, an exposure time of seventy-five seconds is sufficiently short for portraiture. It is not my intention to enter the debate as to who made the first portrait of a living person, but to be clear that it was well within Daguerre's capability to take portraits with this lens in 1835, had he wished to do so. That he seems not to have actively pursued taking portraits is explained by his desire for perfect sharpness across the entire image. This he achieved by using the lens backwards and reducing the aperture further. Daguerre's final configuration for his 1839 lens, ground and cemented by Chevalier, was an achromatic plano-convex doublet, 81 mm in diameter, 380 mm focus, with a 27 mm diaphragm placed 68 mm in front of the plane surface.⁴⁸⁵ This lens had an effective aperture of $f/14$ and just covered a plate sized 164 mm x 216 mm.

Daguerre's adoption of the full-plate size, as it came to be known, was due to the technological limits and expense of optical glass manufacturing at the time. The six-inch (150 mm) focus achromat previously discussed had a diameter of 40

⁴⁸⁵ Charles Chevalier, *Mélanges photographiques: Complément des nouvelles instructions sur l'usage du daguerréotype*. Chez l'auteur, 1844: 25.

mm and an image circle, when stopped down, that covers a plate 72mm X 100 mm, roughly a quarter of the whole-plate size. The difficulty facing opticians when making larger diameter lenses was to obtain optical quality flint glass blanks that were free from uneven density (striae) and internal stress or bubbles. Lead-oxide, being one third of the mass in the molten flint glass, tended to sink to the bottom of the crucible if not constantly stirred during the initial melt. The glass then had to be slowly cooled in the annealing oven to make it homogenous.⁴⁸⁶ The art of optical glass making was stymied in England due to the high excise tax imposed by the government. Glass making ovens were padlocked by officials and unlocked given twelve hours advance notice and excise taxes were levied according to the weight of the glass produced.⁴⁸⁷ Optical glass production in France, on the other hand, was free from such restrictions and nurtured by the Société d'Encouragement pour l'industrie Nationale established by the post-revolutionary government in 1801.⁴⁸⁸ The challenge of sourcing quality flint glass in England and France is clear in the correspondence of Henry Fitz Jr., a New York telescope maker.

Henry Fitz Jr. travelled to England and Europe at the time of the daguerreotype's unveiling to study optical fabrication techniques. He wrote to his father on October 9, 1839:

Tell Wolcott [Alexander S.] that I have only called on Spencer, Browning and Rust, among the other Opticians and one of the firm told me that he had just come from Paris where he had been to buy glass for objects, and bought good. Fariday's [sic] experiments came to naught, and that good glass could not be made any where but in France, and the English made all other

⁴⁸⁶ Henry C. King, *The History of the Telescope*. 3rd ed.: Dover Publications, 2003: 176-179. Pierre Louis Guinand from les Brenets, Switzerland developed effective stirring techniques to produce homogeneous flint glass and pressed the material into moulds to form high quality discs of common sizes up to 6 inches in diameter and rare sizes up to 20 inches diameter.

⁴⁸⁷ Melvyn C. Usselman, "Michael Faraday's Use of Platinum in His Researches on Optical Glass." *Platinum Metals Review* 27, no. 4 (1983): 176-7. I thank Mark S. Johnson for providing me with this reference.

⁴⁸⁸ Pierre Louis Guinand's sons Henri and Aimé learned the secrets of flint glass production and Henri established the firm Guinand Verrier (Glassmaker) in Paris at rue Mouffetard 281 & 283. The firm received a gold medal for glassmaking from the Société d'Encouragement in 1839.

instruments over 1 ½ [inches] of French glass and found it good for any size as large as they had tried, being 6 in.⁴⁸⁹

Michael Faraday was tasked by the Royal Society to experiment with flint glass production in 1824 in hopes of re-establishing England's reputation in optics. He poured the molten glass into flat circular platinum pans (made by Wollaston) hoping to minimize contamination and cast flat, homogeneous lens blanks. His costly method turned out to be no better than what the French could produce at a cheaper price. This explains why W. H. F. Talbot's calotypes for *The Pencil of Nature* were made with Daguerre's cameras adapted for paper negatives.⁴⁹⁰

During his travels, Henry Fitz Jr. noted the name and address of the glassmaker for French optical glass as Henri Guinand, Verrier, 281 & 283 rue Mouffetard. He obtained Guinand's price list for first quality flint and crown un-finished blanks. The glass discs were sold individually in specific diameters; those less than 100 mm were catalogued in lignes (an historic French unit of measure) and pieces 100 mm and larger were catalogued in inches (Fig. 65).⁴⁹¹

⁴⁸⁹ Mark S. Johnson, "Henry Fitz Jr.: A Portfolio of Open Research." *The Daguerreian Annual: Official Yearbook of the Daguerreian Society* (2015): 152. This letter is extremely informative in that it confirms the collaboration between Fitz and Wolcott and John Johnson in telescope making, before the daguerreotype was known. Fitz upon his return to the US polished the speculum mirrors for Wolcott and Johnson's reflecting cameras. Fitz operated as a daguerreian in Baltimore from 1841 to 1845 before retuning to telescope making full-time. He purchased his flint and crown glass discs from Henri Guinand who also supplied raw glass blanks to Lerebours and Chevalier.

⁴⁹⁰ W.H.F. Talbot, "The Correspondence of William Henry Fox Talbot." Leicester: DeMontfort University. <http://foxtalbot.dmu.ac.uk/index.html>. (Date accessed, 31, Oct. 2014) Document number 5248, Alphonse Giroux et Cie, to William Lubbock, dated October 10, 1839 included a bill of sale for two Giroux cameras with lenses (160 francs each) that were forwarded on to Talbot at Lacock. Document number 5286, W. H. F. Talbot to Améline Petit de Billier, dated Dec 5, 1841. "For the Calotype views, I use a camera obscura which I had sent from Paris, like the ones M. Daguerre had constructed." Talbot had the Giroux (Daguerre's) camera plate holders modified for calotype use. The cameras and apparatus are in the collection of National Science and Media Museum, Bradford UK and the lenses are identical to Daguerre's.

⁴⁹¹ I am indebted to Mark Johnson for informing me of this reference, and to Amy Folk, Collections Manager at the Southold Historical Society, NY for providing the digitized copy. Fitz was interested in buying second quality glass for making telescopes. He had developed a method to locally correct for the imperfections during the final polishing of the glass. On the verso of this list are prices for flint glass up to 20 inches in diameter.

MÉDAILLE D'OR. EXPOSITION 1839.

MÉDAILLE D'OR. Académie Royale des Sciences 15 Aout, 1836.

MÉDAILLE D'OR. Société d'Encouragement 1859.

RAPPEL DE MÉDAILLE D'OR. EXPOSITION 1844.

FABRIQUE DE FLINT & CROWN GLASS
à Paris, rue Mouffetard, 281 & 283.

GUINAND
VERRIER.

TARIF

des prix du Flint et Crown-Glass, 1^{re} qualité.

Savoir:

FLINT - GLASS.		CROWN - GLASS.	
En plaques le kilog	2	En plaques le kilog	18
Disques.	4	18 lignes la Douzaine	5
15 lignes la Douzaine	5	17 " " "	7
17 " " "	6	19 " " "	15
19 " " "	10	22 " " "	24
22 " " "	18	25 " " "	40
25 " " "	36	27 lignes la Pièce	6
27 " la Pièce	5	30 " " "	10
30 " " "	8	33 " " "	15
33 " " "	12	36 " " "	20
36 " " "	18	40 " " "	30
40 " " "	30	42 " " "	55
42 " " "	55	4 Douces	60
1 Douce	100	4 " 5 "	70
4 " 1/2 "	50	5 " " "	100
5 " " "	100	5 " 1/2 "	120
5 " 1/4 "	120	6 " " "	200
6 " " "	200		

Nota: Le prix des grands diamètres se traitent de gré à gré.

144 l. 400 f. best quality 400 second

Figure 65. Guinand price list dated 1844 for crown and flint optical disc found among Henry Fitz Jr's papers. Courtesy of the Southold Historical Society, Southold, NY.

The lens blanks Chevalier obtained for Daguerre's lens were 36 lignes diameter (81 mm) costing 38 francs for the crown and flint pair. The next largest pair (40 lignes or 90 mm) were priced significantly more at 60 francs, and a 4 inch-set in the

raw cost 120 francs, nearly as much as the complete Giroux-built outfit.⁴⁹²

Daguerre it seems, quite consciously designed his camera, apparatus and plates based on the largest economically practical lens dimensions, of a size beyond the technological capability of English competition, but not so large as to produce plates impractical for the printing press. This lens, with its 27 mm stop placed 68 mm in front, cast a sharply focused image circle which determined the rectangular dimensions of his plate.⁴⁹³ The next largest optical discs available would not only be significantly more expensive, but the plate size if made to fit within the larger size image circle would exceed the dimensions of a quarto printed page.⁴⁹⁴ Finally, the 27 mm stop was small enough to render a sharp image from corner to corner, yet large enough to keep the average daguerreotype exposures within 15 minutes; Daguerre's pre-determined maximum for sharpness in fixing shadows which he understood by working with phosphorous compounds more than a decade earlier.

The achromatic doublet was adopted by Lerebours, Jamin and other Paris opticians and came to be known as the French landscape lens. With its small $f/14$ aperture and 40° angle of view, it was the only optic specific to landscape use until the Orthoskop, designed by Petzval and made by Voigtländer in the late 1850s. Daguerre's lens was not only expensive but also impractical for portraiture. It was universally understood that shorter exposure times were necessary for successful portraiture. The previous chapter has shown how this was accomplished through modifications in sensitizing; this chapter next explains how this was achieved with optics.

⁴⁹² A Giroux camera with lens sold for 160 francs. A complete outfit including plates, sensitizing box and mercury box and accessories cost 400 francs.

⁴⁹³ Rudolf Kingslake, "Charles Chevalier and the 'Photographe a Verres Combines'." *Image, Bulletin of the George Eastman House of Photography* 10, no. 5 (1961): 18. According to Kingslake, if the 27 mm stop were placed further away than 68 mm in front of the lens, the projected image circle would no longer cover the full-plate dimension. The position of the stop is arbitrary and its location determines the angle of view and degree of spherical aberration.

⁴⁹⁴ Daguerre understood the practicality of camera images serving as printing plates, by engraving or etching, through his relationship with Lemaître and Niépce. Quarto size is 10 x 8 inches and Daguerre's full-plate size would fill the page with three quarters of an inch surround.

6.3 Optics: First Portraits

The achromatic refracting telescope lens served as the inspiration for Daguerre's lens design. Telescopes alternatively use concave reflecting mirrors in lieu of lenses and the optical principles of Sir Isaac Newton's telescope served as the inspiration for Alexander S. Wolcott's mirror camera, the first quick working camera designed for portraits. Wolcott was an avid astronomer, mechanic and maker of dental prostheses in New York. On October 6, 1839 his friend John Johnson excitedly arrived with a brief account of Daguerre's process from a London newspaper. Wolcott agreed to fabricate a camera after his dental obligations were complete and Johnson set off to find silver plates and chemical supplies. Johnson returned to find that Wolcott had cobbled together a camera using a concave mirror borrowed from a small telescope. On that day and the next Wolcott made portraits of Johnson on plates three-eighths of an inch square. Wolcott, having little information to guide his experiments described his first attempts at portraiture in a letter to James J. Mapes, Professor of Chemistry and Natural Philosophy at the National Academy of Design:

My first experiment was I think in October, with a reflector of 1 ½ inches aperture and 2 inches focus. With this I took the profile of a person standing opposite a window; and here having but the three principal facts relating to M. Daguerre's Process, viz: the exposing the plates to vapour of iodine, afterwards to that of mercury, and washing with hyposulphite of soda, or in common salt, I fell into the same error as probably many others, which was, that I supposed it necessary to keep the plate in the camera until the image was visible. This error prevented my making a larger instrument immediately; that which I now use is 7 inches clear aperture...⁴⁹⁵

Henry Fitz Jr., as mentioned in the previous section, learned of their experiments after his return from Europe in November 1839. He agreed to assist his friends in

⁴⁹⁵ Alexander S. Wolcott, "Letter to J. J. Mapes, Editor in Mr. A. S. Wolcott's Improvements on the Daguerreotype." *The American repertory of arts, sciences, and manufactures* 3, no. 1 (March 13, 1840): 193-97. Wolcott's error (excessive overexposure) explains Johnson's recall that with their two attempts that day, the first came out negative and the second one positive. Wolcott's letter also proves that they did not yet have a copy of Daguerre's manual. James Mapes published an English translation as soon as it was available. For Johnson's account of their early experiments see John Johnson, "Daguerreotype." *The Daguerreian Journal*. Vol. 2 (1851): 56-57, 72-80.

re-shaping the concave surface of a 7-inch telescope speculum to shorten its focus.⁴⁹⁶ A scaled-up version of the prototype camera was patented on May 8, 1840 in America and the following year in Britain. The mirror had a concave radius that brought the reflected image into focus twelve inches in front. The camera had to be taken to a darkroom after focusing where the sensitized plate was inserted facing away from the front of the camera. This necessity leads to pre-determined poses, with little to no difference in framing for every portrait subject. The reflecting camera had the advantage of transmitting far more light to the plate than Daguerre's lens and shortened exposures for iodine sensitized plates to less than a minute. In addition, the camera produced non-reversed portraits, free from chromatic aberration and barrel distortion. A major disadvantage was severe spherical aberration that limited acceptable sharpness to plates 2 X 2.5 inches in size. Figure 66 is an illustration of this defect along with a daguerreotype of a resolution target taken with a Wolcott style camera.

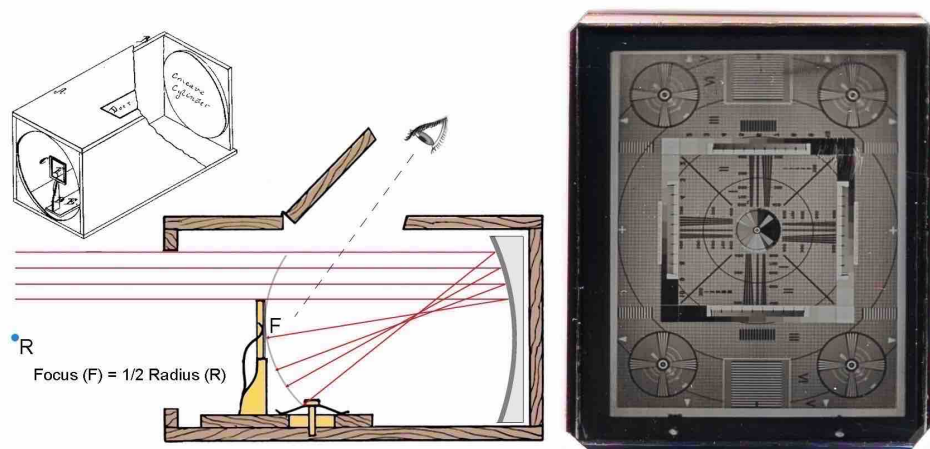

Figure 66. Illustration of Wolcott patent drawing and spherical aberration (left). DagTest 4-13-013 taken with a Wolcott camera replica (right).

The daguerreotype in the above test was made on a plate 2 X 2.5 inches, sensitized only with iodine. Spherical aberration is held to an acceptable level

⁴⁹⁶ Speculum metal is an alloy of two parts copper with one part tin. Trace levels of arsenic are added to balance the spectral reflection of the polished metal to appear white. Fitz and Wolcott were amateur astronomers and worked together on polishing the mirror for a Casgrain style telescope in 1837.

when the plate height is limited to one-third the diameter of the mirror. Even with such a small plate, the corner targets in the resolution test are less sharp than the centre, but this would not be distracting for a head and shoulders portrait. The exposure for this test was 4 minutes with diffuse north-light illumination. This helps to explain why Wolcott and Johnson developed a lighting scenario using mirrors to direct sunshine on axis with the subject.⁴⁹⁷ Johnson and Beard improved on this lighting system for the first commercial London studio; they created a circular room with a canopy glazed entirely with dark blue glass. The camera and sitter's platform could rotate in concert with the sun, and a mirror was mounted on a gimbal bracket above the camera to bounce sunlight directly at the sitter.⁴⁹⁸ Dark blue glass did not accelerate the action of the light, nor did it hinder its action. Antoine Claudet provided a visual example of this with his *Photogenic Paradox* test on display at the Crystal Palace in 1851:

Photogenic paradox, showing that what is light for the eyes is darkness for the photogenic action a frame containing, on one half, the portrait of the Queen, covered with yellow glass, and on the other half the portrait of Prince Albert, covered with deep blue glass, being represented on a daguerreotype plate. The result is that the yellow glass, although showing clearly to the eyes the picture of Her Majesty, has prevented the photogenic action, and that the deep blue glass, although completely hiding the portrait of Prince Albert, the photogenic rays reflected by his picture through the blue glass have had the same action on the daguerreotype as if the engraving had been covered with transparent glass, or with no glass at all.⁴⁹⁹

I re-created the photogenic paradox according to the above description to explicitly understand the visual effects of Claudet's experiment (Fig. 67). This result clearly shows how dark blue glass would serve to protect the sitters from the intense sun

⁴⁹⁷ See Figure 50, p 198 in the previous chapter.

⁴⁹⁸ "The Photographic or Daguerreotype Miniatures." *Times*, The Times Digital Archive London, Wednesday, March 24, 1841: 6. Beard and Johnson glazed their studio with dark blue glass based on Daguerre's advice. See *Historique et Description des Procédés du Daguerreotype*: 27.

⁴⁹⁹ Roger Taylor, "Photographic Exhibitions in Britain 1839 - 1865." <http://peib.dmu.ac.uk/detailphotographer.php?photogNo=73&inum=31&listLength=230&orderBy=coverage>. (Date accessed, 18, March 2017) Exhibit number 296.13, v 1, Class 10, United Kingdom. Claudet, Antoine François Jean. Claudet's *Photogenic Paradox* exhibit is a clear example of the spectral sensitivity of the daguerreotype process.

light directed at them as in Wolcott and Johnson, Richard Beard and Robert Cornelius' lighting arrangement in their first studios. Furthermore, this test dramatically indicates that light yellow glass photographs nearly as black, raising acute awareness of the spectral sensitivity of the daguerreotype, and confirms why light yellow glass is an effective photographic safe-light in the darkroom; another of Claudet's discoveries.



Figure 67. Claudet's *Photogenic Paradox* recreation (daguerreotype reversed for illustration).

The camera to subject distance for a Wolcott camera was between five and ten feet depending on how much of the upper body was focused within the frame of the plate. Full-length views required a camera to subject distance in excess of thirty feet, which was too long for the dimensions of most studios. Landscape views were not practical due to the narrow angle of view.⁵⁰⁰ The reflecting camera was unwieldy for the size of the plate it produced. Albert S. Southworth commissioned Amasa Holcomb, a telescope maker in Boston, to make a thirteen-inch mirror from speculum metal which had a thirty-inch focus and weighed fifty-five pounds.⁵⁰¹ Fitted into a camera, the apparatus would have exceeded three feet in length by sixteen inches square and extremely cumbersome to operate for

⁵⁰⁰ During a workshop at Lacock Abbey in 2014, attendee Roger Smith, using his replica Wolcott camera could barely frame the top of Sharrington's Tower from a distance 150 feet away. A rare example of a Wolcott camera at the Science Museum of Birmingham (accession no. D/1038) has an external focus knob, pointer and an engraved scale, which indicates the practical working range from six to twenty-seven feet from the subject.

⁵⁰¹ Albert S. Southworth, "The Early History of Photography in the United States." In *Photography: Essays and Images*, edited by Beaumont Newhall: The Museum of Modern Art, 1980: 38. Originally published in *The British Journal of Photography* 18 (November 1871) : 530-32.

the sake of a portrait no larger than a quarter-plate in size. In terms of its cost, Southworth paid more for Holcomb's thirteen-inch speculum in 1841 than for a year's rental of the new studio space in 1844 proving optics were by far the most expensive part of the daguerreian system.⁵⁰² The reflecting camera served for a brief period from 1840 to 1842 until made obsolete by combined improvements in sensitizing and lenses.

Lenses ultimately proved to be more practical than mirrors. François Gouraud, a self-proclaimed pupil of Daguerre whose intention was to introduce the daguerreotype to America described the state of portraiture in March 1840. Success at this time necessarily required lenses inferior in sharpness (compared to Daguerre's achromatic doublet) for the sake of speed:

Within fifteen days after the publication of the process of M. Daguerre, in Paris, people in every quarter were making portraits. At first they were all made with *the eyes shut*. . . Mr. Abel Rendu . . . produced to the admiration of some of the Paris circles, portraits of men and women, with the *eyes open*, executed in the most satisfactory manner. The mathematical perfection in the representation of the eyes, which M. Daguerre had been seeking for so long a time, was to be sure, not to be found in these portraits; but this difference was so minute, that it was scarcely perceptible at first sight even by the most practiced eye. . . M. Abel Rendu . . . told me immediately that he had obtained these first results by means of a Meniscus! . . . The portraits I had made in Paris, as well as those obtained by Mr. Abel Rendu, were formed in from ONE *minute* to TWO *minutes twenty-seven seconds*, at the farthest. . . M. Rendu did not attach any great importance to a discovery which did not offer the positively mathematical perfection which M. Daguerre required, and which M. Daguerre had undoubtedly himself, already disdained, he did not wish to make the thing an affair of *reputation*, but authorized me to make any use of it in America which I pleased.⁵⁰³

⁵⁰² Grant B. Romer Brian Wallis, *Young America: The Daguerreotypes of Southworth and Hawes*. International Center of Photography and George Eastman House, 2005: 30. The rental agreement, dated October 1, 1844 stipulated 50 dollars per annum for the large (studio) room. A letter written by John Roach, a New York optician to a Mr. van Deusen, dated May 7, 1841 has recently come to light. According to Roach, "A speculum of about 7 inch diameter and 7 or 8 inch foci is worth about \$35.00, we know of one for sale and those about 10 in diameter \$50 to \$60". John Roach, "Letter to Mr. Van Deusen," This letter along with another were sold on eBay (June 4, 2016) to American collector, Dan Colucci.

⁵⁰³ François Gouraud, "Manner of Taking Portraits by the Daguerreotype." *Boston Daily Advertiser and Patriot*, March 26, 1840. Gary Ewer ed. *The Daguerreotype: an Archive of Source*

Gouraud's advertisement in the *Boston Daily* provides a clue to why Daguerre did not make portraits. He had the means well in hand to do so, but the most likely explanation, implied by Rendu, is that he was motivated by precision and could not bring himself to work with imperfect lenses. Others were not so concerned. Morse, Draper and Fitz in New York realized that Daguerre's expensive achromatic lens was not necessary. Chromatic aberration created problems for telescope and microscope users because they were tools to aid human vision. The daguerreotype process (photographic vision) is most sensitive in the ultra-violet and blue range of spectrum, requiring exponentially more exposure with increasing wavelengths of light. Draper understood that non-achromatic lenses would work for the daguerreotype if the operator made sure to reset the focus of the camera to coincide with blue light, and with its quicker response, the exposure would be complete before the other colours had time to take affect.⁵⁰⁴ An image of a colour wheel target superimposed on a daguerreotype illustrates the normal spectral sensitivity of the daguerreotype; magenta, violet, blue and cyan record as light values, and reds, yellows and greens record dark with abrupt transitions between the two (Fig. 68).

Texts, Graphics, and Ephemera. N8400002

http://www.daguerreotypearchive.org/texts/N8400002_GOURAUD_BOS-DAILY-ADVERT_1840-03-26.pdf (Date accessed, 18, March 2017)

⁵⁰⁴ John W. Draper, "Remarks on the Daguerreotype." *The American Repertory of Arts, Sciences, and Manufactures* (New York) 6, no. 1 (July 1840): 402-3.

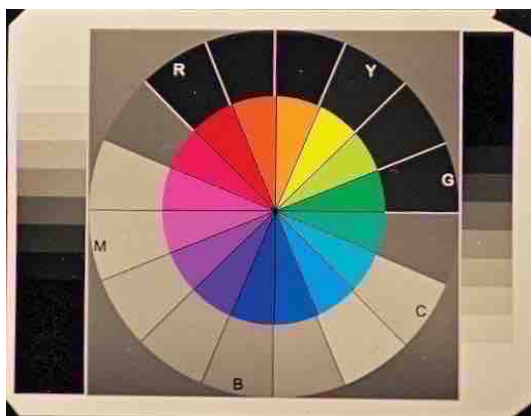

Figure 68. DagTest 12-19-2010. Spectral sensitivity of the daguerreotype.

Draper cautioned, "The risk of failure by employing an uncorrected lens, is greater than the risk by a good achromatic, or a reflector".⁵⁰⁵ He was referring to the challenge in re-focusing the camera to blue light. Morse recorded in his notebook, "The chemical focus is 59/100 of an inch less than luminous focus, according to Professor Draper's successful experiment January 18th [1840]".⁵⁰⁶ Wolcott, near the end of 1839, made a successful portrait of Henry Fitz Jr. on his second attempt by focusing the camera on a point sixteen inches more distant. His first attempt failed because the camera was focused on Fitz's features and the result was a blurry image.⁵⁰⁷ The difference between chemical and visual focus with non-achromatic lenses depended on the number of elements combined together and whether the lenses were made with crown or flint glass. Flint glass required a greater adjustment for chemical focus because of its higher refractive index but compared to crown glass, worked faster because it transmitted more ultraviolet light.⁵⁰⁸ Wolcott and Draper's earliest attempts to shorten focus and achieve faster working optics involved combining two identical lenses together spaced a certain

⁵⁰⁵ Draper, "Remarks on the Daguerreotype." 1840: 403.

⁵⁰⁶ Samuel Finley Breese Morse, "Memoranda of Daguerreotype." In *Samuel Finley Breese Morse papers, 1793-1944*: Library of Congress, 1840.

⁵⁰⁷ Mark S. Johnson, "Henry Fitz Jr.: A Portfolio of Open Research." *The Daguerreian Annual: Official Yearbook of the Daguerreian Society* (2015): 150.

⁵⁰⁸ John T. Towson, "On the Proper Focus for the Daguerreotype." *The London, Edinburgh, and Dublin Philosophical Magazine and Journal of Science* XC, no. XCVII (November 1839): 383-84. Towson noted that flint optics gave shorter exposures than crown optics because they transmitted more UV light.

distance apart. Draper originally used a pair of four-inch diameter *bi-convex* lenses to shorten the focal length to eight inches. With a special camera designed like an optical bench, Draper could quickly exchange the elements or adjust their orientation, and the design enabled him to tune the focal length of the combination by sliding the rear lens support back and forth as seen in figure 69.⁵⁰⁹



Figure 69. John Draper's experimental lens camera apart and assembled. National Museum of American History, Smithsonian. Accession number 72.072A.08. Author photograph.

Wolcott described a nearly identical setup using two *plano-convex* lenses of four-inch diameter with a combined focus of eight inches. These combinations were not corrected for spherical aberration leading Wolcott to advise that the largest image of the head practical with such an arrangement was only one inch. For life-sized likeness (taken from life), Wolcott calculated the necessary optics to be *three feet in diameter*. He offered further combinations involving more lens elements but dismissed the whole thing as impossible, suggesting rather for life-sized images, a small image could be taken then magnified by copying it with normal-sized optics.⁵¹⁰

Between 1840 and 1842 opticians in New York, Boston and Philadelphia built cameras empirically; lens elements were ground and tested then assembled with wooden spacers set into brass tubes. Convergent lenses (plano or bi-convex)

⁵⁰⁹ The camera, part of the Draper family fonds at the NMAH Smithsonian, currently has a 3-inch plano-convex element mounted in the front with the plane surface outward, and a 2 ¾ diameter bi-convex lens in the rear position. The combined focus is eleven inches.

⁵¹⁰ Alexander. S. Wolcott, "On the Daguerreotype." *The American Repertory of Arts, Sciences, and Manufactures* 6, no. 2 (January 1841): 401-05.

were combined to shorten the focus, and divergent (plano or bi-concave lenses) were added to reduce spherical aberration. Few attempted to make the lenses achromatic. John Roach, a New York Optician, advised a prospective daguerreian, that “the kind of lenses generally used now are not achromatic and succeed very well”.⁵¹¹ Roach’s early cameras were built with four inch Wollaston periscopic lenses with a turned wood aperture behind the lens. There was an ivory knob at the rear, connected to a threaded shaft that moved the inner box forward or backward within the outer box. A pointer connected to the sliding box ran through a slotted groove in the top of the fixed box and this was dressed with a graduated scale marked on an ivory plate. This allowed the operator to precisely adjust the camera for chemical focus after visual focus was determined. With most camera designs, chemical focus adjustments had to be determined in other ways.⁵¹² Whatever the style or lens arrangements, the early American cameras for portraiture had large four-inch diameter lenses and produced small plates in sizes ranging from ninth (2 x 2.5 inch) to just shorter than quarter-plate in size (3.25 X 4 inch). Figure 70 shows two such examples, one built by an unknown maker and the other with the ivory focusing scale engraved with “J. Roach, Optician. 72 Nassau St. New York”.⁵¹³ Roach re-located from 293 Broadway in 1841 to Nassau Street in 1842.

⁵¹¹ John Roach, "Letter to Mr. Van Deusen", date May 7, 1841. This letter is signed Roach and Warner. Henry Warner and John Roach were located at 293 Broadway at this date. The other letter dated November 25 is signed John Roach, 72 Nassau Street, Late Roach Warner.

⁵¹² Antoine Claudet invented a focimeter, which was a target of eight numbered wedges arranged in a circle, each wedge set on inch behind the next. To use it one would focus on a mid-pint number (4 or 5 for example) and take a daguerreotype of the device. The sharpest wedge in the image, perhaps number 7 or 8 would be re-focused in the camera to determine the necessary adjustment to correct for chemical focus.

⁵¹³ The late Matthew R. Isenburg acquired the camera shown at left in figure 70 from Donald P. Lokuta. He referred to this as the “Lokuta” camera. Isenburg acquired the John Roach camera from Fritz Van Houten Raymond, the grandson of the original owner. He installed an 1860’s vintage French landscape lens on the front to replace the missing optics. For the illustration (Fig. 70), I digitally added the lens from an image of a nearly identical camera in the collection of the NMAH, Smithsonian.



Figure 70. Cameras circa 1840 - 41 from the National Gallery of Canada collection. Unknown maker "Lokuta" camera, LFA 21500_600_8 (left). Camera built by John Roach, New York, LFA 21500_600_5 (right). Author photograph.

I had the opportunity to work with the "Lokuta" camera for a few days in 2014. I carefully disassembled and cleaned the lenses. The combined optics were three plano-convex elements. The rear two, 4-inch diameter and 14-inch focus, are identical and separated by a half inch spacer between the plane sides. In front of this pair is a 3.25-inch diameter lens of 10.5-inch focus. It is set in a wooden ring with the plane side facing the subject. When I took it apart it was reversed with the curved surface outwards. Turning it around gave a much better image. Between the rear group and front element is a paper diaphragm roughly 2 inches diameter. The brass shutter is mounted about 3 inches in front of the foremost lens providing an effective aperture of $f/2.9$. The lens suffers from chromatic aberration and significant barrel distortion (see Fig. 53, p 212 and Fig. 54, p 214). I determined the necessary chemical focus to be 7 mm, which is a significant adjustment; without which the image would be excessively blurred, as was the case for Wolcott's first portrait attempt of Fitz.

I also experimented with a camera and lens engraved 'William H. Butler, 7 ½ Bowery, New York'. This address is significant because in 1840-41 John Plumbe Jr., William H. Butler, John W. Draper, James R. Chilton, and Samuel F. B. Morse collectively opened a studio there to experiment in taking daguerreotypes.⁵¹⁴ The

⁵¹⁴ Wilmot M. Chapman, "Our First Photographers." *Sun (New York)*, February 4, 1896: 6. Gary W. Ewer, ed., *The Daguerreotype: an Archive of Source Texts, Graphics, and Ephemera*, EWER ARCHIVE N8960003 <http://www.daguerreotypearchive.org> (Date accessed, 26, June 2016)

camera was found complete with two sensitizing boxes, three plate holders for ninth, sixth and quarter-plate size, and mercury bath and is thought to have been designed under the supervision of John Draper for his neighbour, Mr. Rowley of Hastings on the Hudson (Fig. 71).⁵¹⁵

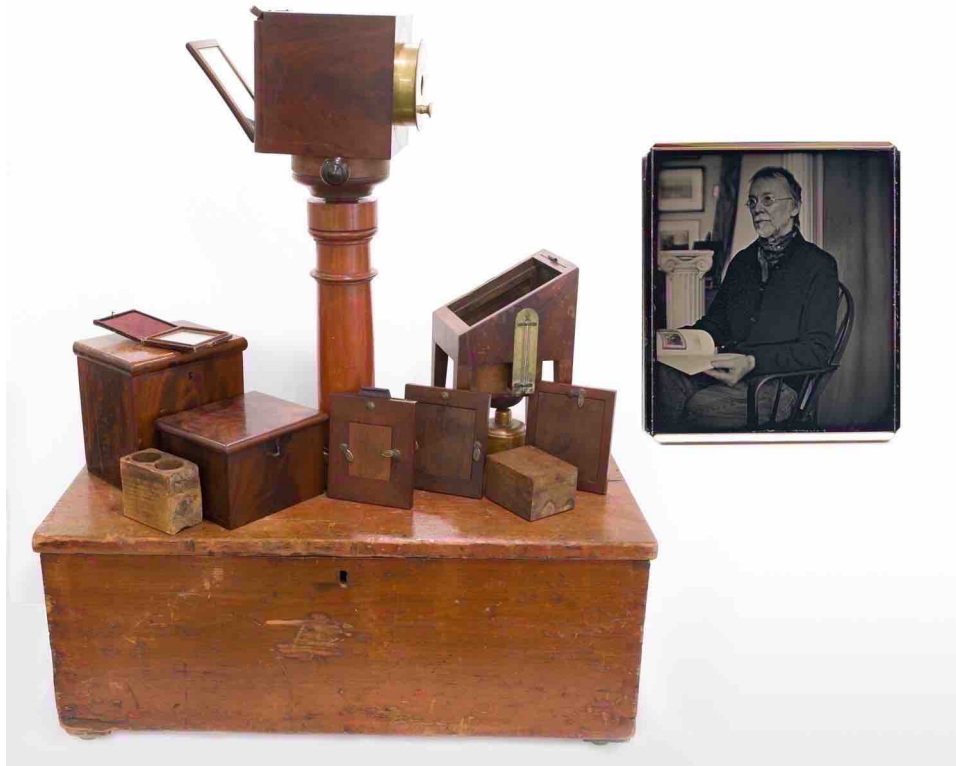

Figure 71. William H. Butler camera outfit, ca 1842, from the National Gallery of Canada collection. LFA 21500_600_3 (left). Ninth-plate portrait of Grant Romer taken with the same camera (right).

The veneered wood and hardware is identical to Draper's camera (fig. 69) indicating that the same carpenter may have made both.⁵¹⁶ The lenses are more complex than those in the "Lokuta" camera, consisting of one plano-concave, one asymmetric bi-convex and one plano-convex lens. Crude wooden rings marked in pencil 3333, 2222 and 1111 separate each element. Also written on the rearmost

⁵¹⁵ Matthew R. Isenburg, "Early Equipment." In *The Daguerreian Annual: The Daguerreian Society*, 1993: 209.

⁵¹⁶ Smith & Brothers Clock Establishment was located in the same building at 7 ½ Bowery. Clock cases made by them have the same veneered wood species and the necessary brass turning machinery would have been available to make the tubes and engraving for the lens.

1111 ring is "This curve first to the outside screw" which refers to the plano-convex element. The-ninth plate portrait of Grant Romer (Fig. 71) was not quite as sharp as I had thought it should be. It was evident that the elements had been taken out of the brass tube several times and may have been replaced in the wrong orientation. I flipped the front most plano-concave element 180° and the image worsened. With the first and third element in their correct orientation, I flipped the centre element around and overall sharpness improved. The effective aperture of the lens cell is $f/7.2$, which is six times slower than the lens on the "Lokuta" camera. The slowness of the lens was counteracted with bromine acceleration.⁵¹⁷ I made images of my studio on all three plate sizes with the center lens in the same position as the portrait of Grant. I repeated the exposures with the centre lens oriented correctly. The results of DagTest 11-24-2013 (Fig. 72) show that spherical aberration is worse with the centre, asymmetric bi-convex element positioned so the shorter radius surface faces the subject.

⁵¹⁷ The larger sensitizing box has "Bromine" written in pencil on the underside of the lid.



Figure 72. DagTest 11-24-2013. Daguerreotypes taken with the William H. Butler camera. Three sizes with centre element transposed incorrectly (top). Three sizes with the correct orientation for the centre element (bottom). Portrait of a man on quarter-sized plate masked to conceal spherical aberration. National Gallery of Canada, LFA. 21500_186_83 (right).

With the lenses correctly mounted, spherical aberration is limited to the edges on the ninth and sixth sized plates but clearly present on the largest sized plate. This size is 3.25 x 4 inches, a quarter of an inch shorter than what was to become the industry standard quarter-plate size. The nineteenth century portrait of the man shown in the above figure was made on an early Corduan & Co. plate of precisely these dimensions. It is housed in a flip-top case with a very unusual presentation being a paper mat to crop the image to ninth plate size (not shown) to mask the spherical aberration from the primitive optics.⁵¹⁸

As Wolcott suggested, and proved by this example, portraits taken with early optics whether with a refracting lens camera or a reflecting mirror camera were necessarily small, ninth or sixth-plates. Quarter-plate images were possible, however those images suffered in sharpness beyond the centre of the plate.

⁵¹⁸ The light halo surrounding the cropped area is actually silver chloride haze from contact with the paper mask. The man's body in the image continues to the plate's edge under the haze but it is extremely out of focus due to the lens. The image was originally thought to be a ninth-plate fitted into a quarter-plate case, but was discovered to be a 3.25 X 4 inch plate made by Corduan & Co. (see also figure 20, p 111).

Proven by re-enactments, the size, look and pose of portraits taken before 1843 are linked to the limitations of mirrors and early lenses in terms of spherical aberration and camera to subject working distances. These issues would soon be greatly improved with two achromatic lenses mounted facing each other. The first to develop high quality portrait lenses were Charles Chevalier, Daguerre's lens maker, and Josef M. Petzval whose design was manufactured and sold by Voigtländer & Sohn in Vienna.

6.4 Optics: Petzval's Lens

M. le baron Séguier, Vice President of the Société d'Encouragement pour l'Industrie Nationale, proposed a competition for a lens design that was more luminous than Daguerre's $f/14$ achromat. The deadline for entries was year's end 1840.⁵¹⁹ Charles Chevalier set to work on the challenge by pairing a second achromatic doublet of 65 mm diameter with the same optic he built for Daguerre in 1839. He developed a combination of aperture discs and extension tubes to allow a daguerreian to customize the focal length and speed of the lens as required. Chevalier engraved the brass-work of his modified lens "Photographe à Verres Combinés". The lens could be used without the additional optic, thus being identical to the former lens at $f/14$. With the extra optic screwed onto the tapered cone, the combination became a wide-angle lens, which doubled its luminosity, yet was still too slow for portraits having an effective aperture of $f/10$. The third combination, for portraits, required the auxiliary lens to be mounted further from the main lens on an extension tube. This offered an effective aperture of $f/4.9$ and allowed for exposures eight times quicker than the original lens. The angle of view in this orientation restricted the lens coverage, limiting the practical size of portraits to half-plate.⁵²⁰

Chevalier's lens was completed and submitted to the Société d'Encouragement for evaluation on December 1, 1840. The only other submission, which arrived three months after the deadline, was designed by Josef Max Petzval and built by the German optical firm, Voigtländer & Sohn. Chevalier won the platinum medal for his versatile lens and the German lens was awarded a silver medal even though it was late to enter the contest.⁵²¹

⁵¹⁹ Rudolf Kingslake, "Charles Chevalier and the "Photographe a Verres Combines"." *Image, Bulletin of the George Eastman House of Photography* 10, no. 5 (1961): 18.

⁵²⁰ I observed the limited angle of view when testing an original Photographe à Verres Combinés lens from the National Gallery of Canada collection. LFA 21500_600_68.

⁵²¹ Kingslake, "Charles Chevalier and the "Photographe a Verres Combines": 18.

Andreas von Ettingshausen, Chair of Physics at the University of Vienna, was present for the August 19 announcement of the daguerreotype. Upon his return to Vienna, he discussed the need to develop a faster lens with Josef Max Petzval, his colleague and mathematician. Petzval, with the assistance of the army's corps of engineers, required six months to calculate the necessary curvatures for the flint and crown combinations.⁵²² After the prototype lens was successfully tested, Petzval approached Peter Friedrich von Voigtländer to produce it and the first lenses entered the market in January 1841, which accounts for its late entry to the French contest. Figure 73 illustrates the lenses of Daguerre, Chevalier and Petzval to clearly show how the change in achromatic lens arrangements affected image size and relative exposure times over a sixteen-month period. The trend was towards a reduction in image size in favour of speed, as was with the non-achromatic lenses reviewed in the previous section.

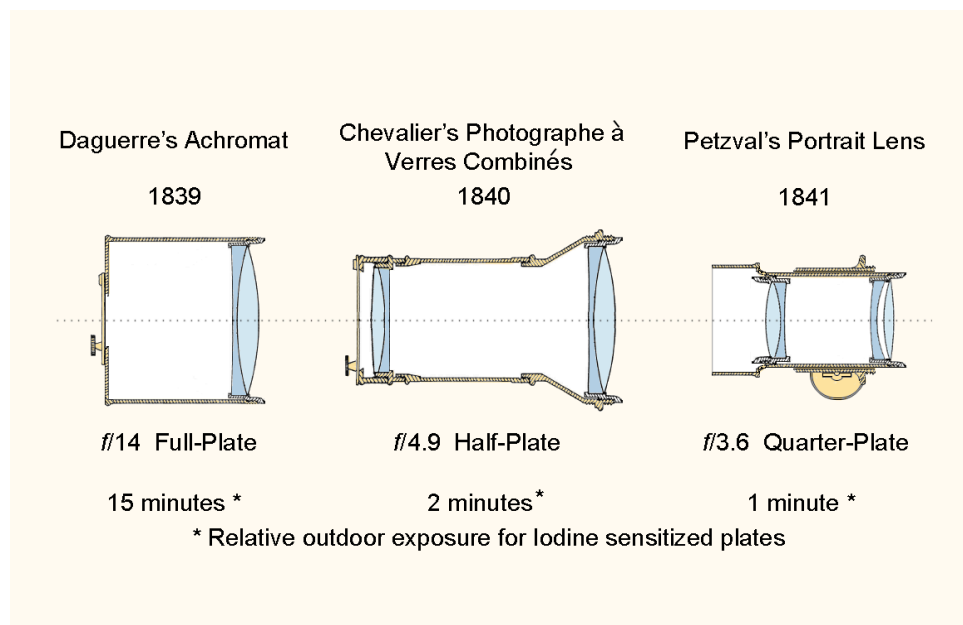

Figure 73. Achromatic lens evolution from 1839 to 1841 comparing image size and relative speed.

⁵²² J.M. Eder and E. Epstean, *History of Photography*. Dover Publications, 1978: 292. Petzval's portrait lens was the first mathematically designed optic for photography. Previously, lenses were developed empirically.

Chevalier won the highest honour from the Société d'Encouragement for his lens, but the Petzval-Voigtländer lens won in marketplace, outselling the Verres Combinés by a wide margin due to its superior image quality and speed.

Chevalier, obviously disgruntled by the competition, complained:

Mr. Voigtländer, in March 1841, three months after the expiry of the deadline, submitted an apparatus for quarter-plates. It was a bizarre, little portable device that used round plates, a shape by the way, intended to conceal the aberrations of the lens. The clear field was only suitable for sixth or quarter-plates at most.⁵²³

The camera was indeed bizarre and quite ridiculous in its operation, similar to using a Wolcott mirror camera in that it had to be taken into the darkroom to load the sensitized plate, while the sitter had to remain motionless until the photographer returned. Unwieldy as it was, the lens produced high quality images in sizes equal or larger than what was possible with Wolcott's reflecting camera, or the American four-inch combination lenses mentioned in the previous section. Figure 74, DagTest 6-27-2016, is a daguerreotype of a lens resolution target taken with a Voigtländer all-metal round camera.⁵²⁴

⁵²³ Charles Chevalier, *Mélanges photographiques: Complément des nouvelles instructions sur l'usage du Daguerreotype*. Chez l'auteur, 1844: 113.

⁵²⁴ This camera is a Voigtländer factory replica, number 68 of 100 produced in 1978 from my collection. For the test, I replaced the modern optics with an original daguerreian era Voigtländer lens made in 1852, serial number 3933.



Figure 74. DagTest 6-27-2016. Voigtländer all-metal round camera (left). Resolution test, quarter-plate lens serial. no. 3933 (right).

The lens is rectilinear, meaning free from barrel distortion, has good definition corner to corner, and a sixth-plate (3.25 X 2.75 inches) fits conveniently into the four-inch image circle projected by the lens, as the above test shows. The lens was far superior to prior portrait optics.

Alexander Beckers, who began his daguerreian career in 1843, recalled his first introduction to the Voigtländer camera in the studio of William and Frederick Langenheim in Philadelphia:

The camera rested on a candlestick-like tripod, with three setscrews for adjustment, and was placed on an ordinary table. To interchange the ground-glass and round daguerreotype plates, it was necessary to unscrew a flanged ring and replace the same by a reverse motion...The round plates were used only for a short time, and so far as I know Langenheim was the first to introduce a square camera, plates and holders...In the summer of 1843 the first dozen of small Voigtländer objectives were imported.⁵²⁵

⁵²⁵ Alexander Beckers, "My Daguerreotype Experience." *Anthony's Photographic Bulletin* 20, no. 7 (April 13, 1889): 209-11. Becker's date for the first allotment of Voigtländer objectives imported into the United States is specific to lenses only. In 1842 the Langenheim's were selling the complete all metal camera that used round plates. According to an unpublished letter from Chas G. Page to Albert S. Southworth on January 12, 1843, Page purchased an all-metal camera

The Langenheim brothers were German immigrants living in Philadelphia. By fate of family ties they were introduced to the daguerreotype and became American agents for the new camera. Their brother-in-law, Johann Bernhard Schneider, was a professor at the Polytechnic Institute of Vienna and Peter Friedrich von Voigtländer was his student.⁵²⁶ Schneider sent one of the new cameras to Philadelphia with instructions and advice not to attempt daguerreotyping unless they had "courage enough to try five hundred times more after failing with the first one hundred pictures".⁵²⁷ William and Frederick Langenheim opened a studio at the Merchants' Exchange Building in 1842. With the new Petzval lens re-fitted to a wood camera body, they took the first successful full-length standing portrait of a young Samuel Troth in June.⁵²⁸ The historically significant daguerreotype was copied by Julius F. Sachse and reproduced for an article in *The Practical Photographer* fifty years later.⁵²⁹

for \$275.00. This was more than three times the cost Bemis paid for an original Giroux outfit in 1840. Page soon discarded the camera body, but pronounced the lens as excellent. See Newhall, Beaumont. *The Daguerreotype in America*. 3rd revised ed. ed. New York: Dover Publications [etc.]; London: Constable, 1976: footnote 4 page 160.

⁵²⁶ Beaumont Newhall, *The Daguerreotype in America*. 3rd revised ed. New York: Dover Publications [etc.]; London: Constable, 1976: 49

⁵²⁷ Alexander Beckers, "Fifteen Years Experience of a Daguerreotyper." *The Photographic Times and American Photographer* 19, no. 391 (1889): 131. Beckers said Peter Friedrich von Voigtländer was a former classmate of William Langenheim and sent the camera directly to him in Philadelphia. Newhall in *The Daguerreotype in America* said the camera was sent by Schneider, Voigtländer's teacher who was married to Louisa Langenheim. Voigtländer, through this relationship met and later married Nanny, sister to Frederick, William and Louisa Langenheim.

⁵²⁸ Matthew Surface, "The First Full-Length Child Portrait." *The Practical Photographer* (June 1, 1894): 134.

⁵²⁹ I have recently re-discovered the original daguerreotype in the collection of the Historical Society of Pennsylvania with the assistance of D'Arcy White, a former student of mine who catalogued the material. The copy image is marked "JFS95", assumed to be Julius F. Sachse, who wrote several articles on the early history of Photography in Philadelphia.

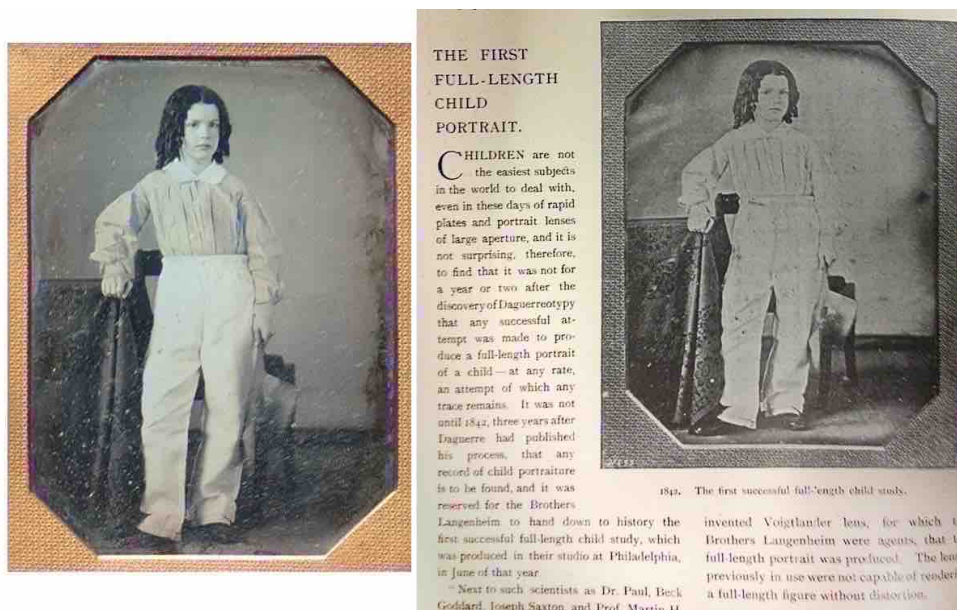

Figure 75. Quarter-plate daguerreotype of Samuel Troth, 1842. Courtesy of the Historical Society of Pennsylvania (left). Clipping from *The Practical Photographer*, June 1, 1894 (right).

Lenses prior to Petzval's design were incapable of capturing a standing child without distortion or chromatic blur. As can be seen in this example, the lens worked well for quarter-plates if the camera to subject was increased to include a more distant view. This design, with excellent corner-to-corner sharpness also made it possible to take groups of two or more people on a single plate with careful attention to ensure each face was positioned in the curved focus plane of the lens.

It's narrow depth of field, due to its wide $f/3.6$ aperture, and a curved focus plane produced a unique visual signature. For example, the image would appear distorted if the camera was level and focused on a seated subject framed to include the head and hands. With a camera aimed level, the hands would have to be positioned about a foot nearer the lens than the head for both to be in focus, making them appear disproportionately large compared to the head. To mitigate this, photographers raised the camera well above eye level and tilted it down to keep the hands and head equidistant from the lens. The Petzval lens's optical signature accounts for a commonality with seated portraits taken from an elevated vantage point. Before the decade was out, the Langenheim's had sold over 1500

Voigtländer Petzval lenses.⁵³⁰ The small version being the most popular has left a lasting legacy in terms of image size in that approximately seventy percent of all extant daguerreotypes are sixth-plates.

By 1845, Voigtländer lenses were also available in sizes for half-plate at \$70.00 and full-plate, selling for \$140.00.⁵³¹ William H. Sherman recalled that a New York optician, as soon as he got hold of a half-plate version, took it apart to make casts of the lenses in order to grind his own copies.⁵³² Petzval and Voigtländer did not extend their patent beyond Austria, so opticians of high reputation in France, England and America freely copied the lens design. The *Daguerreian Journal* carried several testimonials touting the superiority of C. C. Harrison's New York made cameras (lenses) over those made by Voigtländer. Albert Litch, in a letter to Harrison dated April 1, 1851, and an eleven-year veteran of the art having just acquired one, pronounced it superior to all others, "not excepting those made by 'Voigtländer & Sohn' ".⁵³³ Charles C. Harrison, who was apprenticed to Henry Fitz Jr. and served as his shop foreman, began manufacturing lenses under his own name in 1849 and his reputation quickly spread.⁵³⁴ The only lens maker

⁵³⁰ W.H.F. Talbot, "The Correspondence of William Henry Fox Talbot." Leicester: DeMontfort University. Letter from W & F Langenheim to W. H. F. Talbot, dated Feb. 5, 1849. Document number 6210. "Our brother in law, Mr. Voigtländer in Vienna, appointed us his Agents, for the Sale of his Daguerreotype and other optical instruments. We have sold more than 1500 of them, and this has made us more or less acquainted with every operator in the Country". The Langenheim's started negotiations to with Talbot to buy patent rights for the calotype in America. They lost a fortune on the venture.

⁵³¹ Southworth and Hawes paid 140 dollars for a full-plate Voigtländer lens in 1845 and 70 dollars for a half-plate Voigtländer lens in 1846. They were purchased from E. White, N.Y. according to original receipts in the collections of the George Eastman Museum and the National Gallery of Canada.

⁵³² William H. Sherman, "The Rise and Fall of the Daguerreotype." *The Photographic Times and American Photographer* 21 (1891). Reprinted in the *Daguerreian Annual*, 1997: 212-13. Sherman noted that though the lens looked the same, and the curves were duplicated the optician did not understand that glass of different refractive indexes (crown and flint glass) were required. A full-plate forgery marked with "Voightlander, New York" is in the technology collection at the George Eastman Museum. Voigtländer is frequently misspelled with an "h" included.

⁵³³ S. D. Humphrey and L L. ed. Hill. *The Daguerreian Journal*. 2, no. 2 (June 1, 1851): Advertisement inside front cover.

⁵³⁴ John S. Craig, *Craig's Daguerreian Registry*. 2nd Revised ed. Vol. I, Torrington, CT. 2003: 166-67.

representing the United States, Harrison's entry at the 1851 Great Exhibition at Crystal Palace was titled as follows:

Specimens of daguerreotypes, exhibited for sharpness of outline, distinctness, and delicacy of shading. The camera obscura with which they were taken accompany them. These instruments are exhibited both for their construction, and for the perfect manufacture of their achromatic glasses.⁵³⁵

The Crystal Palace judges, having no means to test the lenses having been sent unattached to cameras, offered no awards or honours to Harrison but the lenses did get noticed by the photographic trade.⁵³⁶ America's commissioner for the Crystal Palace exhibitors, Mr. N. J. Dodge, Esq. returned a letter asking for price and availability because Harrison's lenses were eagerly sought by European Daguerreotypists, being superior to any made there. This encouragement prompted Harrison to leave the daguerreian profession to concentrate fully on lens manufacturing.⁵³⁷ Four years after the Great Exhibition, the state of the art in optics was described an article by Thomas Woods, reprinted in *The Photographic and Fine Art Journal*:

We are mainly indebted to Professor Petzval, of Vienna, for the present photographic camera. Until within two or three years, Messrs. Voigtländer & Son, of Vienna — who adopted Professor Petzval's formulae for grinding and setting the lenses — were the most successful manufacturers of this instrument, and they obtained a world-wide fame...In the United States, where Daguerreotypists have for years been acknowledged the best artists in the world in the beautiful process to which they are devoted, the cameras

⁵³⁵ Roger Taylor, "Photographic Exhibitions in Britain 1839 - 1865." 1851, London, Great Exhibition. No 223, v 3, United States. <http://peib.dmu.ac.uk/detailphotographer.php?photogNo=73&inum=31&listLength=230&orderBy=coverage>. (Date accessed, 18, March 2017) In this instance "camera obscura" is referring to the lens only, not a lens and box combination.

⁵³⁶ *Reports by the Juries on the Subjects in the Thirty Classes into Which the Exhibition Was Divided*. Royal commission, 1852: 275. Harrison (United States, No. 223. p. 1450) "...has exhibited two or three cameras, but as they are not mounted in boxes, can consist only of the brass-work and lenses. There were not means of trying their performance. They are constructed on the usual principle of double achromatic object-glasses, to give a flat field. The largest is about 4 inches aperture." Harrison made lenses in the usual sizes *and* double whole-plate and mammoth plate covering a 24-inch plate. These were the largest Petzval lenses ever made.

⁵³⁷ Snelling, Henry Hunt ed. *The Photographic Art-Journal* 2, no. 2 (August 1851): 127. Snelling predicted, "In a few years, Mr. Harrison's cameras will be more celebrated than even the Voightlander".

of C. C. Harrison, of New York, stand predominant, their superiority over all others being of the most marked character. They are always perfectly achromatic, cover a greater field than those of Voigtländer, at the same time preserving the focal length or sharpness of the latter. They are also free from that defect, so common to all others, a difference between the visual and chemical focus.⁵³⁸

Lenses requiring compensation for chemical focus worked thusly. When focused to show a sharp image on the ground glass or visual focus, the lens to plate distance had to be shortened slightly to coincide with the shorter wave (380~430 nm) portion of the spectrum, to which the daguerreotype plate was most sensitive. This was deemed the chemical focus. The reason that Voigtländer optics required re-adjusting for chemical focus while Harrison's lensed did not is due to how each optician ground their divergent flint lenses to achieve achromatism.

Petzval, with the assistance mathematicians from the army corps of engineers calculated the refractive indexes of his optical glasses to the third decimal place. He relied on Fraunhofer's system, which mapped specific colours of light according to dark lines in the spectrum. With the understanding that silver salts were insensitive to red light, Petzval designed his lens so that the Fraunhofer F (blue) and D (yellow) lines of the spectrum would coincide in focus, omitting the longer red wavelengths.⁵³⁹ This was the first optic designed specifically to work within the limits of photosensitivity and explains the need to re-adjust the lens for chemical focus. As mentioned, C. C. Harrison received his training from Henry Fitz Jr. Fitz trained as a telescope maker and achieved achromatism, as did all other telescope makers, by observing the image a point source of white light (to simulate a distant star).⁵⁴⁰ The flint lens was incrementally polished, tested and re-polished until the

⁵³⁸ Snelling, Henry Hunt ed. "Photography -- Its Rise and Progress." *The Photographic and Fine Art Journal* 8, no. 1 (January 1855): 5: The author, Thomas Woods, M.D. also mentions worthy lenses by A. Ross of London, and Chevalier in Paris, but few of them found their way to America.

⁵³⁹ J.M. Eder, *Ausführliches Handbuch Der Photographie: Die Photographischen Objektive*. W. Knapp, 1899:113-19. Eder located Petzval's original designs and reproduced the exact radii for the seven glass surfaces of the lens. Eder did not mention the significance of Petzval's choice to achromatize the lenses to coincide with the actinic rays of the spectrum. Antoine Claudet invented a focimeter to determine the precise adjustment required for the chemical focus of a lens.

⁵⁴⁰ Peter Abrams, "Henry Fitz: A Preeminent nineteenth Century American Telescope Maker." *Journal of the Antique Telescope Society* 6 (1994): 10.

red or blue fringes were eliminated, thereby achromatizing the lens for visible light. Harrison's lens, though it did not require re-adjustment, was essentially over-corrected for the actinic rays of the spectrum. Figure 76 compares half-plate daguerreotypes taken with each lens from the same camera position.

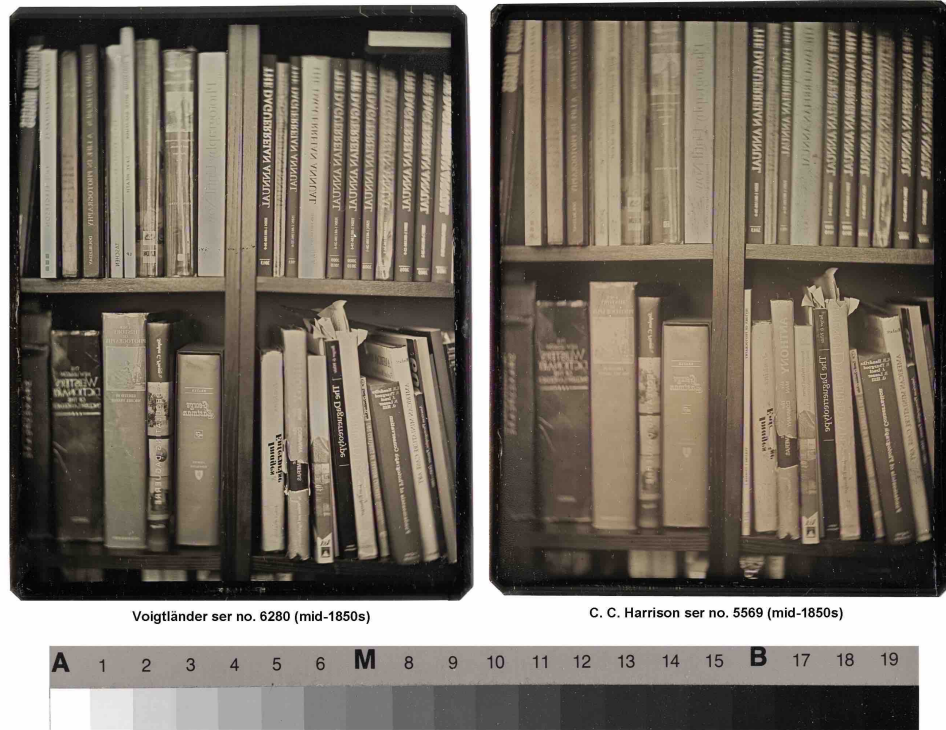

Figure 76. DagTest 1-18-2016. Half-plate daguerreotypes taken with a Voigtländer lens (left), and C. C. Harrison lens (right).

In touting the superiority of the American lens over the German, Woods claimed a greater field of coverage, though as my test indicates the opposite is true. Harrison's lens actually covers a slightly narrower field than Voigtländer's lens of equivalent size but this is a minor point. Significantly, Harrison's over-corrected lens yields images with less acutance and contrast compared to Voigtländer's very sharp and contrasty lens when correctly adjusted for chemical focus. The optical signature of Harrison's lens, rendering a diffuse and slightly softened image, was beneficial for portraits; particularly for individuals with less than perfect complexions or aged and coarse facial features. Optics can also influence image particle morphology that affects image tone. The two plates for DagTest 1-18-2016

were prepared and processed the same, yet the plate made using C. C. Harrison's lens is more warm-toned than that of the Voigtländer lens image. In portraiture, the daguerreotype process does not flatter and is particularly unforgiving when coupled with the contrast and sharpness of the German Petzval lens. Due to its relative insensitivity to green, yellow and red light, ruddy, suntanned or freckled complexions are significantly exaggerated. It was, and remains, a challenge for a daguerreian artist to please sitters with less than alabaster complexions. Ralph Waldo Emerson considered his likenesses taken by Southworth and Hawes to be rueful and wrote, "...I must not sit again, not being of the right complexion which Daguerre & iodine delight in".⁵⁴¹ To soften contrast and acutance when using the Voigtländer lens, a simple remedy was to line the interior of the camera with white paper. This adaptation, referred to as the illuminated camera, was first published in late 1850 in *Comptes rendus hebdomadaires des séances de l'Académie des sciences*, by Louis Désiré Blanquart-Evrard.⁵⁴² Bates and Isabel Lowry wrote about the debate that ensued in their article "Secrets of the White Chamber". Antoine Claudet, who had invented the focimeter to achieve the ultimate in sharpness, believed the method was detrimental and Southworth and Hawes countered that they had been using the technique as early as 1845.⁵⁴³ The Lowrys asked me to make daguerreotypes to compare the results between a normal and whitened camera. The 'white camera' image was softer in acutance and contrast, had more shadow detail and was obtained in one-third less time. Furthermore, the subject's freckled complexion was smoother in the plate taken in a whitened camera (Fig. 77, left).

⁵⁴¹ Melissa Banta, *A Curious & Ingenious Art: Reflections on Daguerreotypes at Harvard*. Iowa City: Published for Harvard University Library by University of Iowa Press, 2000: 98.

⁵⁴² Louis Désiré Blanquart-Evrard, "Note sur la photographie; Moyens accélérateurs." *Comptes rendus hebdomadaires des séances de l'Académie des sciences*, (lundi 23 Décembre 1850): 864-65.

⁵⁴³ Bates and Isabel Lowry, "Secrets of the White Chamber." *The Daguerreian Annual: Official Yearbook of the Daguerreian Society* (2002-2003): 332-41. Southworth and Hawes purchased Voigtländer lenses according to invoices retained in the studio business papers.



Figure 77. Daguerreotype portraits of Fiona Christie taken January 3, 2004 with a Voigtländer lens.

Images made with a Voigtländer lens using a whitened camera are comparable to those made using a C. C. Harrison lens in a normal camera with a black interior in terms of contrast and sharpness. In other words, it is possible with this method to alter the optical characteristics of the Voigtländer lens in the studio to soften its effects and yield images similar to those taken with Harrison's lens. On the other hand, I have found the results when using the Harrison lens in combination with an illuminated camera too indistinct and lacking contrast. In the post-daguerreian era, Petzval's design was modified by J. H. Dallmeyer to allow for variable diffusion by altering the separation of the rear lens elements.⁵⁴⁴ Voigtländer in the late 1870s also modified the rear lens elements of their to eliminate the need to adjust for

⁵⁴⁴ John Henry Dallmeyer, "United States Patent Office; Compound Lens for Photographic Portraiture." June 11, 1867. The patent specification "consists in arranging them so that the lenses composing one of the combinations are of such form and so positioned that by a slight variation of distance or separation between its elements, any desired amount of spherical aberration can be obtained, without at the same time materially deranging the other necessary corrections of a photographic objective or lens. With a lens or objective so constructed the operator can, by sacrificing intense sharpness of definition on one plane, distribute the definition over several planes, and so obtain a more artistic and pleasing result."

chemical focus.⁵⁴⁵ The extreme sharpness of perfectly corrected lenses ultimately was not desirable for portraiture.

The optic commonly used for landscape views before the 1860 was the single achromatic meniscus lens, which was essentially unchanged from Daguerre's design of 1839 having a maximum aperture of $f/16$. Portrait lenses, once bromine acceleration was introduced, yielded instantaneous, one second or less exposures, and had limited depth of field due to their $f/3.6$ aperture. To counteract this, an inventive photographer known only as the "Frenchman" fabricated a lens cap with a five-eighth's inch hole in it while working in Venice in 1845.⁵⁴⁶ This slight modification to his quarter-plate portrait lens lengthened the exposures to a more manageable three to six seconds while simultaneously increasing the depth of sharpness in his images. This adaptation introduced a telltale circular vignette. It is likely the Frenchman was using a Voigtländer lens because French-made lenses available around 1845 had apertures included in their design that were fitted close to the front glass to avoid the problem of vignetting. A hole cut in the lens cap is far enough ahead of the lens to cause the vignetting as shown in figure 78.⁵⁴⁷

⁵⁴⁵ J.M. Eder, *Ausführliches Handbuch Der Photographie*, 1899: 115. German patent No. 5761, dated June 25, 1879. In this patent the crown and flint radii were re-ground to allow visual focus to coincide with the chemical focus.

⁵⁴⁶ John Ruskin purchased a number of daguerreotype views from a Frenchman working in Venice 1845 and returned later to make his own daguerreotypes. A trove of daguerreotypes from Ruskin's archive were sold at auction in 2006. For a full account of the re-discovery of this important collection see Ken and Jenny Jacobson, *Carrying Off the Palaces, John Ruskin's Lost Daguerreotypes*. London: Bernard Quaritch Ltd., 2015.

⁵⁴⁷ The diffusion at the edge of the image circle is related to the distance between the aperture and the front of the lens. The size of the image circle is determined by aperture. I made several experiments varying the aperture and found a five-eighths hole to be a close match to the Ruskin plates.

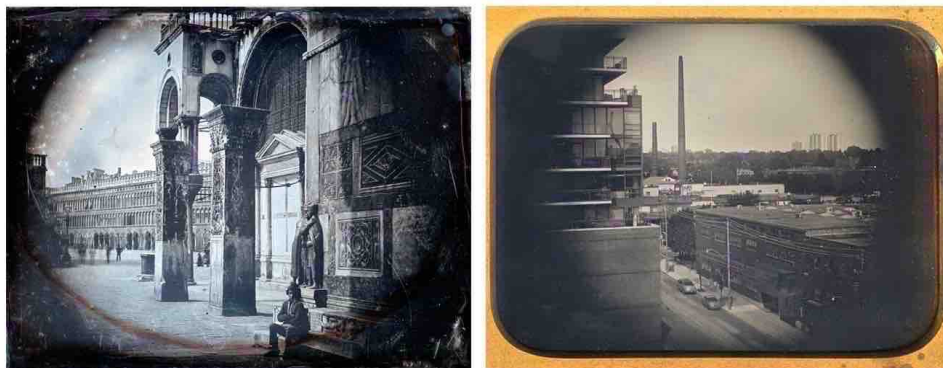

Figure 78. The Frenchman, Venice, St. Mark's and the pillars of Acre looking towards the Piazza, c. 1845, courtesy of Ken and Jenny Jacobson (left). DagTest 4-8-2015 taken with a Voigtländer lens with a 5/8-inch hole in the lens cap (right).

By 1858 Voigtländer and other manufactures supplied their portrait lenses with a set of apertures designed to be inserted between the front and rear elements through a slot cut in the lens barrel. Voigtländer also produced an *Orthoskop* landscape lens, which was rectilinear with a maximum aperture of $f/8$. Petzval originally designed this lens at the same time as his portrait lens in 1840, but the design was not put into production until 1857. The lens used the same cemented front element but had a longer focus rear combination, providing a flatter field. C. C. Harrison introduced his own version of this lens in 1858.⁵⁴⁸

The discussion has been limited to the portrait lenses made by Voigtländer and C. C. Harrison, as they were the most well-known and preferred lenses in the early 1850s during the peak of daguerreian practice. The Petzval formula and its variant copies was used exclusively for studio portraits after 1843 and well into the collodion era because it remained the fastest working optic available.

⁵⁴⁸ J.M. Eder and E. Epstean, *History of Photography*. Dover Publications, 1978: 297-302.

6.5 Optics: Conclusion

Now, since I showed my article to Mr Daguerre after I had written it but before it was published, he told me that he had also observed this condition in experiments and that he had varied the Curvatures of his periscopic lens which had been rendered achromatic, until he was satisfied that he had achieved the maximum sharpness...he found that the greatest effectiveness was obtained in the blue rays, consequently very near the greens which are nearly in the middle of our chromatic spectrum...But you can see what wisdom such remarks show in a man who had never studied optics or specialised chemistry before he came to this Subject which he has investigated constantly for fourteen years with tireless passion.⁵⁴⁹

The French scientist, Jean-Baptiste Biot was clearly impressed by Daguerre's knowledge of optics when he wrote the above to W. H. F. Talbot. This aspect of Daguerre's contribution to the history of photography has been trivialized by Gernsheim and Osterman and received little study otherwise. In truth, Daguerre had done his homework and maintained a close relationship with Vincent Chevalier the optician. He clearly understood the concepts of spherical and chromatic aberration when critiquing Niépce's images in 1829. Daguerre's knowledge was not theoretical, it was learned through experience. He was able to directly observe lens characteristics during his optical research because he worked with phosphorous compounds that were exceedingly sensitive to light. Daguerre knew that to successfully fix shadows free from blur exposures had to be fifteen minutes or less; a goal he finally achieved with latent image development in 1835 that is the subject of the following chapter.

Daguerre explained to Niépce in a scaled drawing that the single achromatic telescope lens in its normal orientation worked fifty percent faster than when the lens was reversed but the image was only sharply rendered in the centre. The advantage of reversing the lens was a reduction in spherical aberration that increased overall sharpness. Experiments replicating Daguerre's optics of 1833

⁵⁴⁹ Jean-Baptiste Biot, "The Correspondence of William Henry Fox Talbot." Leicester: DeMontfort University, 1839. Document no. 3882, dated May 27, 1839. <http://foxtalbot.dmu.ac.uk/index.html> (Date accessed, 18, March 2017)

allowed me to recognize the unusual focus signature for two daguerreotypes of Thun Switzerland taken by John Ruskin and his valet in 1854 (Fig. 79). In one plate the centre is sharp while the perimeter falls rapidly out of focus, in the other the perimeter is sharp and the center is out of focus. This unusual distortion occurs when the rear element of the Voigtländer portrait lens group is removed and the front achromat alone is used. Removing the rear element of a half-plate lens increases the focal length from approximately 6 ½ to 9 ½ inches. From the elevated vantage point, the town of Thun must have appeared too distant on the camera's ground glass so Ruskin removed the rear lens elements to narrow the field of view and bring the scene closer.⁵⁵⁰ Ruskin used these daguerreotypes to serve as reference for a chromolithograph, so the fact that two daguerreotypes with different focus were necessary to record all the details of the scene is understandable.⁵⁵¹

⁵⁵⁰ Some lens designs, such as the Jamin Cone Centralisateur and Darlot portrait lens allowed for the front element to be reversed in place of the rear element to function as a single achromat lens. The brass work and thread diameter of the front and rear cells of Voigtländer lenses built before 1860 were not the same and so the front element could not be interchanged to the rear position. The necessity to bracket the focus leads me to deduce that Ruskin and Crawley were using a Voigtländer Petzval lens.

⁵⁵¹ Ken and Jenny Jacobson, *Carrying Off the Palaces, John Ruskin's Lost Daguerreotypes*. London: Bernard Quaritch Ltd., 2015: 121-23. My original interpretation of these images was that the front stop of a single achromat lens was removed to gain more speed under fleeting light conditions. I revised my hypotheses to the one presented here after seeing the results from DagTest 6-11-2016, page 250. The optical signature of the Ruskin pair is identical to the image projected when the rear element is removed from a Voigtländer Petzval lens.

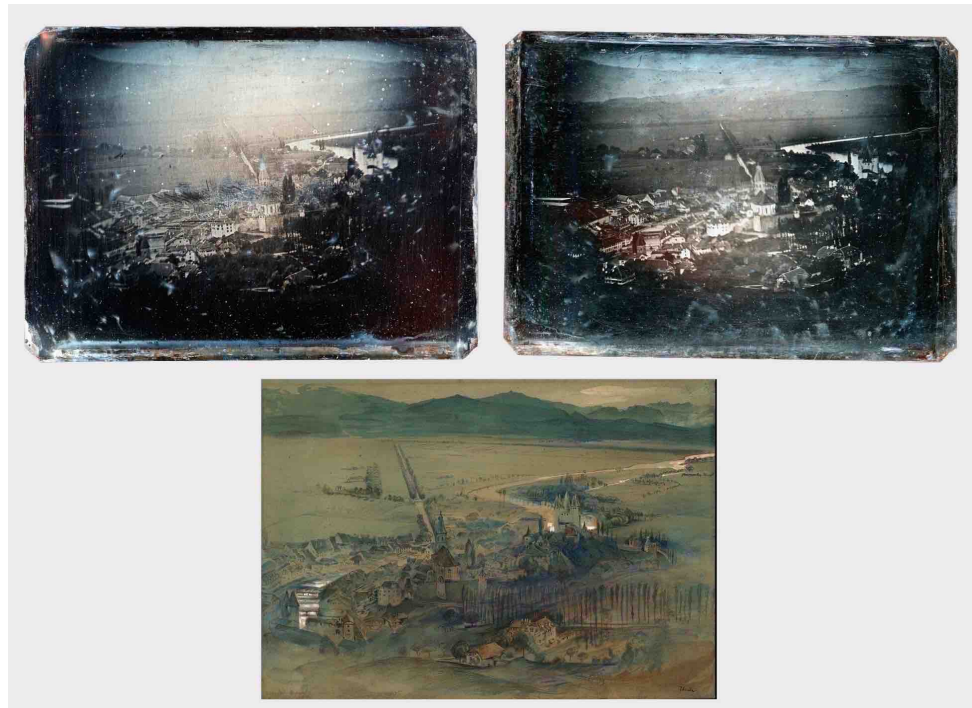

Figure 79. Half-plate daguerreotypes by Ruskin and Crawley with bracketed focus, courtesy of Ken and Jenny Jacobson (top). Chromolithograph after a drawing by John Ruskin *Panoramic view of Thun and the River Aar*, private collection (bottom).

Unlike these Ruskin examples, Daguerre positioned his achromatic lens in the reverse orientation for the best overall sharpness. I have argued that the whole-plate size was established by the capacity and economics of flint glass manufacturing. Flint glass is essential for correcting chromatic aberration in crown glass lenses. According the Guinand Verrier price-list, the French opticians excelled in casting quality optical crowns and flint in common sizes up to six inches in diameter, while the English opticians, Fitz wrote, could not produce flint discs greater than $1\frac{1}{2}$ inches in diameter. Daguerre's choice of 36 lignes diameter (81 mm) lens blanks shows shrewd business acumen combined with economic practicality. The lenses were twice as large as what the English could produce, giving his imaging system an advantage over potential foreign competition in terms of size. Having selected the lens, he then determined the diameter and position of the aperture in front of the lens that was small enough for the desired sharpness, yet large enough to allow average exposures to be within fifteen minutes;

Daguerre's pre-determined maximum based on his experience with phosphorous compounds. With the lens and aperture decided, the camera's dimensions were designed around a 216 mm x 162 mm rectangle that just fit within the projected image circle of the lens focused on a distant view. This dimension then became the standard. I suggest that Daguerre may have settled on 81 mm diameter as the largest practical size because a full-plate engraved for printing would fill a quarto-sheet of paper. Furthermore the next largest lens blanks offered by Guinand cost nearly twice as much, which would increase the expense and size of the entire apparatus (camera, sensitizing box and mercury bath) and produce a plate larger than practical for print reproduction.

Portraits were not possible with Daguerre's lens due to its relatively small aperture. Fitz and Wolcott borrowed reflecting optics from the field of astronomy to develop and patent a lensless mirror camera that worked sixteen times quicker. The reflecting camera was limited to an extremely narrow field of view and a plate size ten times smaller in area than the full-plate. The same was true for the first refracting lens cameras applied to portraits. Lenses were arranged by combining two, three or four elements to shorten exposures while sacrificing image size. The Wm. Butler camera of 1842 is a prime example of this. Though supplied with plate holders capable ninth, sixth and quarter-plate size, image quality suffered when the largest size plate was attempted. The quarter-plate portrait of the man in figure 72, likely taken with a similar lens is a unique example were a paper mask was included to conceal the extreme spherical aberration beyond the centre, reinforcing the point that the first portraits were necessarily small. The first portrait lenses were designed empirically and it became aware to experimenters like Fitz, Draper and Towson that expensive achromatic lenses were unnecessary, provided the lens was refocused to coincide with the short wave region of the spectrum. The correction required was so significant that a calibration scale was incorporated into the body of cameras built by New York optician, John Roach. Dr. John Draper calculated the correction necessary at $59/100^{\text{ths}}$ of an inch with two bi-convex lenses, and I have found the necessary adjustment to be 7 mm with a three-

element lens camera from 1841. Portraits taken during the incunabula period reveal the challenges and limitations of early optics in their small size and limited framing, generally showing only the head and shoulders of a single sitter.

Petzval's quick working portrait lens, made perfectly achromatic for the actinic rays of the spectrum using precise calculations based on Fraunhofer's research, was also rectilinear. This lens was a breakthrough in that it allowed for a wider field of view and excellent sharpness overall. It provided the photographer the freedom to move near or far from the sitter, take images of groups of people, or capture a full-length standing portrait of a child as seen in the historically significant image of Samuel Troth, taken in 1842 by the Langenheim brothers. The Langenheim's incidentally entered the daguerreian business after receiving and becoming agents for the Petzval portrait lens which was being produced in Vienna by their brother-in-law, Peter Voigtländer. The German lens, as it came to be known, was renowned for its sharpness and contrast. C. C. Harrison's version of the Petzval lens was also revered for its optical qualities. These two lenses, as I have demonstrated, create significantly different images in terms of resolution, contrast and image tone due to the different approaches their makers employed when achromatizing the lens. Petzval used precise mathematical calculations to correct his lens for the green-blue region of the spectrum, being the first to design a lens to work within the spectral sensitivity of the daguerreotype process. C. C. Harrison on the other hand was trained in the traditional methods used by astronomers by judging the achromatism of a lens against a distant point of white light. Harrison's full spectrum approach produced a lens that was slightly more diffuse than Voigtländer's, which ultimately was ideal for pleasing portrait results. The Petzval lens combined with multiple sensitizing produced the maximum of photosensitivity. Under bright conditions outdoors exposure times were reduced from an average of five to ten minutes in 1839 to nearly instantaneous or under one second duration five years later.

The final factor affecting speed is mercury development, which also contributes to image tone along with gilding or gold toning. Latent image development, fixing and gilding is the subject of the next and final chapter.

7.1 Image Development Fixing and Toning: Overview

The camera lens has been known since Giambattista della Porta described its use as a drawing aid for artists nearly five centuries ago.⁵⁵² The camera as a photographic tool, with the means to record the lens image, became possible with advancements in light sensitive materials. Daguerre's use of iodized silver plates for such a purpose began in 1831, but the process inverted the lights and shades of nature. He laboured for four years to correct this with an after-treatment to convert the image details from black to white and the unexposed white silver metal to black. This work ultimately led to his discovery of the latent image and mercury development in 1835.

Daguerre's discovery has never been clearly understood. His use of mercury was so extraordinary and unique in terms of photochemistry that it has been presented in nearly all histories of photography as the result of a fortunate accident. The purpose of this chapter is to retrace his pathway of discovery from the few historical accounts that contain details of the process, and present fresh insight into this history. This chapter also proffers an explanation for the obscure announcement in *Journal des Artistes* from September 1835 that Daguerre had attained the goal of fixing an image in the camera obscura.

Mercury vapour plays an important role in terms of speed, image colour and contrast, and this chapter explicitly details the development variables that contribute to the look of a daguerreotype. The chemical mechanism for the reaction between the latent image and mercury has been posited as mass silver transport by other researchers based on scanning electron microscopy. That model does not fully account for the range of image particle microstructures possible with development variables. This chapter re-establishes that amalgamation is the mechanism for image particle formation. This work introduces the remarkable effects on image colour and photosensitivity possible with the addition of ether to the mercury bath, which was little used and a relatively

⁵⁵² G.D. Porta, *Magiae Naturalis Sive De Miraculis Rerum Naturalium Libri IV*. 1561.

unknown process outside of France. Lastly this chapter presents new information about the gilding process, the final procedural step in daguerreotypy, in how it enhances image brightness, contrast and stability.

Re-enactments presented in this chapter are designed to understand the effects of time or ether with mercury development. These experiments clearly show the changes in image colour, contrast and photographic speed due to changing development conditions and pre and post treatment photographs reveal changes in image colour due to the gilding process. The look of a daguerreotype is dependent on image particle size, shape and frequency and scanning electron micrographs made from these experimental daguerreotypes clearly correlate image particle morphology with the colours seen in the images.

Daguerre's discoveries are presented in this chapter through historical accounts that contain procedural details. These details have informed modern re-enactments and in some instances knowledge gained from re-enactments for previous chapters has informed the reading and comprehension of historical sources that heretofore have not been considered significant. Re-enactments and a procedural review of historical text are the basis for my argument that mercury development, the discovery of the latent image, and the achievement of a stable photograph in 1835 was no accident and that Dr. Larry Schaaf's remark that "Daguerre had not been trained in scientific methodology, and was incapable of building on his experiences" is quite off the mark.⁵⁵³

⁵⁵³ Larry J. Schaaf, *Out of the Shadows: Herschel, Talbot and the Invention of Photography*. Yale University Press, 1992: 66.

7.2 Image Development: The Magic Cupboard

In 1839 DAGUERRE'S carelessness gave the world photography

To the studied research of the French chemist, Louis Mandé Daguerre, printing owes much . . . to his absent-mindedness it owes infinitely more! For until Daguerre grew negligent, there was no photography as we understand it today. There was only a tedious and impractical art called "Camera Printing" in which photographic plates had to be exposed for eight hours to secure a picture.

Then one day Daguerre happened to store a plate, which he believed spoiled by under-exposure, in a closet where he had carelessly left an uncovered saucer of mercury. Vaporized by the heat of the room, the mercury became a reagent. It clarified the image on the discarded plate and developed the world's first, true photograph, the Daguerreotype.

To printing, Daguerre's discovery was of first importance. For it not only made possible realistic illustration, but it gave new clues to the search for methods by which the cost of fine printing could be reduced.

This search has reached its latest development in Kleeffect, The Perfect Printing Paper.

For Kleeffect offers in unusually generous proportions the five qualities so long sought in printing papers. First of all, in making Kleeffect, special processing eliminates two-sidedness of surface and color for all practical purposes and makes possible printing of uniformly high quality on both sides. Kleeffect has strength and high opacity. It possesses a neutral color that gives proper contrast with the greatest number of printing inks and types of illustration . . . a non-glaring color that is easy on the eye and permits the maximum true reproductive power of one to four colors.

To see samples of the work this perfect paper makes possible—to learn the economy of its cost and the name of the merchant nearest you who stocks Kleeffect, please write our advertising office in Chicago.

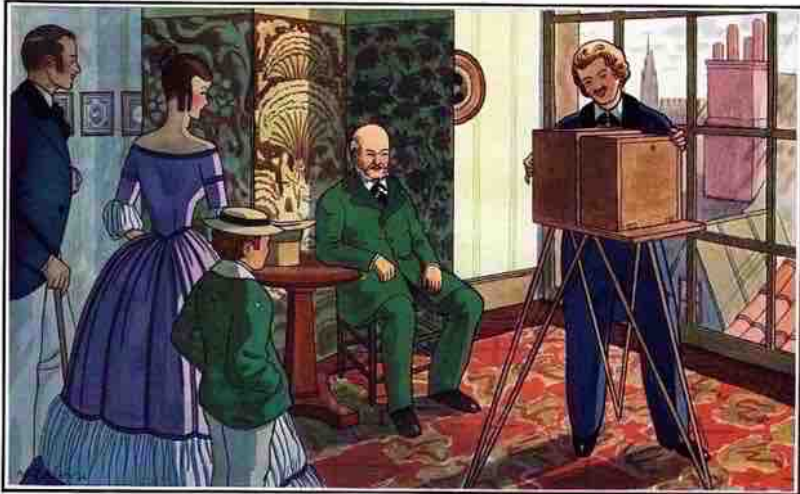

Kleeffect
THE PERFECT PRINTING PAPER

KIMBERLY - CLARK CORPORATION
ESTABLISHED 1870
KEENAH, WISCONSIN

CHICAGO, 8 South Michigan Avenue NEW YORK, 122 East 42nd Street
LOS ANGELES, 310 West Sixth Street

Figure 80. 1934 advertisement for Kimberly-Clark corporation.⁵⁵⁴

The copy editor for Kleeffect printing paper presents Daguerre as the inventor of photography by way of accidental fortune and negligence. This notion has

⁵⁵⁴ (Advertisement), Kimberly-Clark Corporation. "In 1839 Daguerre's Carelessness Gave the World Photography." In *Sales Management: Survey of Buying Power*: Dartnell Corporation, 1934: 323.

persisted since the start because the daguerreotype process when revealed, was so extraordinary and unique in terms of photochemistry that some thought it couldn't possibly be the result of inductive reasoning, and was most likely discovered by chance.⁵⁵⁵ My aim here is to explain that inductive reasoning may have been precisely how Daguerre discovered latent image development using mercury vapour. In this section, I retrace his pathway of discovery from the few historical accounts that contain details of the process, and offer fresh insight into this history based on re-enactment experiments.

Sources are incomplete concerning latent image development with mercury vapour; one of Daguerre's most significant discoveries. Consequently, conflicting third-person accounts have told the story. Justus von Liebig tells an apocryphal account, published fifteen years after Daguerre's death; an exposed plate left in a chemical cabinet for weeks having formed an image due to an unnoticed basin of mercury amongst the chemicals.⁵⁵⁶ Gernsheim's story is materially different from Liebig with the plate merely left a few days in a cupboard containing a few drops of spilt mercury from a broken thermometer.⁵⁵⁷ Neither of these scenarios makes sense because they describe an under-exposed plate with an invisible (latent) image left in a chemical cupboard. My argument, which I support with Daguerre's comments that have been re-viewed from a material perspective and informed by practice and replication, was that he was working with visible images printed-out in

⁵⁵⁵ "Original Papers on Science, No. II Photographic Portraits." *The Mirror of Literature, Amusement, and Instruction III* (1843): 119. According to the author, "The process of Daguerre's was totally different from any attempt hitherto made, and the result altogether so extraordinary and unexpected, that it appears impossible that anything like inductive reasoning could have led to the results which it is more than probable were accidentally obtained."

⁵⁵⁶ Justus Von Liebig, "Induction and Deduction." *The Cornhill Magazine*, July to December. (1865): 302.

⁵⁵⁷ Helmut and Allison Gernsheim, *The History of Photography from the Camera Obscura to the Beginning of the Modern Era*. revised 2nd ed.: Thames and Hudson, 1969. To test this scenario, I placed an exposed plate in a 35 litre light tight box along with 5 mL of mercury. I periodically inspected the plate no image appeared, even after several months.

camera and trying to convert them from negative to positive by a subsequent treatment with chemicals in a step-by-step progression towards mercury vapour.⁵⁵⁸

The earliest reagent Daguerre explicitly mentions by name is carbonic acid gas (carbon dioxide). Significantly he explained, "At this period, I did not know that the image existed on the surface of the iodide of silver before it was visible".⁵⁵⁹ If Chevalier's observation that Daguerre ensconced himself in his laboratory passionately studying chemistry is reliable, or that he took Jean-Baptiste Dumas up on his offer of support, he most certainly would have been aware of Justus Liebig's work with carbonic acid.⁵⁶⁰ Chemists like Berzelius and Gay-Lussac commonly measured the amount of carbonic acid obtained from combustion reactions volumetrically for the analysis of organic compounds.⁵⁶¹ In 1831, the same year Daguerre began his research with iodized silver plates, Liebig published a description of his newly developed kaliapparat for chemical analysis in *Annales de Chimie et de Physique*, which was directly followed by Dumas' review of it.⁵⁶² Here then are two possible routes for information on the kaliapparat to reach Daguerre; either by reading *Annales de Chimie* or in conversation with Dumas.

⁵⁵⁸ My replication of an in camera printed-out image on silver (DagTest 2-16-2013, Fig. 34, p 151) provides an indication of the kind of image Daguerre was attempting to convert from negative to positive.

⁵⁵⁹ Louis Jacques Mandé Daguerre, "Des procédés photogéniques considérés comme moyens de gravure. — Lettre de M. Daguerre à M. Arago". *Compte rendu hebdomadaire des séances de l'Académie des sciences*, no. Séance du Lundi 30 Septembre (1839): 423-30. Daguerre worked with images made visible in camera before his discovery of the latent image in the late summer of 1835. Daguerre's meaning of "at this period" is the four years between 1831 and 1835.

⁵⁶⁰ Charles Chevalier, "Éloge de Daguerre. - Documents historiques, lettres inédites de N. Niépce, etc.". Chap. Troisième Partie. In *Guide du photograph*. Paris, Palais Royale 158: C. Chevalier, 1854. 23. For Dumas' offer of assistance see J. B. Dumas, "Discours de M. Le Sénateur Dumas, Président". *Bulletin de la Société d'Encouragement pour l'industrie Nationale* XI, no. deuxième série (April 6 1864): 199-201. Daguerre's wife thought him mad for abandoning his painting and obsessively pursuing photography. She approached Dumas in hopes that he would persuade her husband to cease. After visiting Daguerre, the opposite occurred. Dumas offered him financial assistance and the use of his laboratory.

⁵⁶¹ Alan J. Rocke, *Nationalizing Science: Adolphe Wurtz and the Battle for French Chemistry*. MIT Press, 2001: 38. Liebig, a German chemist who was fluent in French, studied under Gay-Lussac in Paris from 1822 to 1824, so he may never have met Daguerre in person but he was well known in Paris and a contemporary of Dumas.

⁵⁶² Justus Von Liebig, "Sur un nouvel appareil pour l'analyse des substances organiques; et sur la composition de quelques-unes de ces substances." *Annales de Chimie et de Physique* 47, no. 2 (1831): 147-97.

The kaliapparat was important for Daguerre because of the way it operated. Liebig placed copper oxide in the rearmost globe of the kaliapparat to confirm that no carbonic acid escaped beyond the calcium chloride contained within the device to absorb it. Copper oxide is black and when exposed to carbonic acid is converted to a light salmon colour. The copper oxide served as an indicator, and if it changed colour, Liebig knew the combustion experiment was a failure due to the incomplete absorption of the gas.⁵⁶³ At this time, Daguerre must have thought the dark printed-out image was silver oxide and with the knowledge that copper oxide lightens with exposure to carbonic acid gas, its use was a logical attempt to transpose the image tones on his own plates.⁵⁶⁴

The other substance Daguerre mentions in his letter to Arago in *L'Academie des Sciences* on September 30 was chlorate of potassium. This was heated in an enclosed vessel to generate fumes from the white crystalline substance, which he hoped would condense on the darker areas of the plate. Daguerre had prior experience with fumes because he had used kerosene vapour to preserve the fine details of the Physautotype. Carbonic acid gas and heated chlorate of potassium were partially successful in whitening the dark values of the plate because both compounds contained chlorine vapour. Although carbonic acid is a by-product of combustion, copious fumes are given off by pouring muriatic acid on lime. This method would likely have been the preferred means for Daguerre to generate carbonic acid in an enclosed vessel but it is difficult to separate the chlorine component from the carbon dioxide. The reason Daguerre had partial success with these chlorine containing compounds is that they reacted with silver metal, not

⁵⁶³ Melvyn C. Usselman, Alan Rocke, Christina Reinhart, and Kelley Fousler, "Restaging Liebig: A Study in the Replication of Experiments." *Annals of Science* 62, no. 1 (2005): 23.

⁵⁶⁴ Daguerre wrote that carbonic acid gas did reverse the tones on the iodized and exposed silver plates but the results were very imperfect in the middle tones. On June 24, 1831, Niépce replied to Daguerre, "My results in this respect have been entirely similar to those which the oxide of silver gave me; and promptitude of operation was the sole advantage which these substances appeared to offer".

silver oxide. I observed a similar reaction when using chlorine vapour to replicate the formation of white haze on daguerreotype plates.⁵⁶⁵

The final two compounds that Daguerre experimented with immediately before discovering mercury vapour were corrosive sublimate and calomel. Shortly after the daguerreotype process was revealed on 19 August 1839, Daguerre attended a gathering of scholars, artists and distinguished gentlemen at the home of M. Senard.⁵⁶⁶ He responded to inquiries about his progress of discovery and wonder of excitement he must have felt. Daguerre replied sadly that fourteen years of experimentation and disappointment had robbed him of any sense of joy. He explained:

I got there step-by-step. I had first tried corrosive sublimate; it marked the images a little but the results were grainy and coarse; I then tried sweet mercury or calomel; this was already better. That day, hope returned to me more than ever, and brought back my old zeal.⁵⁶⁷

Corrosive sublimate (mercuric chloride or HgCl_2) is a highly poisonous white crystalline mercury salt that readily vapourizes from solid to gas (sublimation), and then returns to solid again (condensation) on a surface. With these characteristics it is understandable why Daguerre chose it to reverse the tones of his plates. Calomel (mercurous chloride or Hg_2Cl_2) is a soft, white substance made by mixing mercury with corrosive sublimate. One of its uses was to replace corrosive sublimate in medicines because it was less toxic to patients. Calomel is refined and purified by condensing vaporized calomel to an impalpable pure white

⁵⁶⁵ Michael A. Robinson and Edward P. Vicenzi. "A Twin Paradox: A Study of Preservation and Disfigurement of Southworth and Hawes Daguerreotypes." *Topics in Photographic Preservation* 16 (2015): 196-97. The article is reproduced in full as Appendix A, p 366.

⁵⁶⁶ It is possible that M. Senard was Antoine Marie Jules Senard (1800-1885) a French politician who later became Minister of the Interior.

⁵⁶⁷ Mayer and Pierson, " Histoire de sa découverte." In *La photographie*. Paris: Librairie L. Hachette et Cie., 1862: 29-30. The Gernsheims provided a translation in *L.J.M. Daguerre* on page 76 of the Dover edition but it is misleading. The original text says that Daguerre experimented for fourteen years (1825-1839). The Gernsheims change it to eleven years to situate the beginning of Daguerre's research after Niépce's first camera image.

powder.⁵⁶⁸ Daguerre found that calomel performed better than mercuric chloride at whitening his plates and remarked that the transition from calomel to mercury vapour was the one final step that “mon bon génie” inferred from experiments inspired him to take.⁵⁶⁹

If Daguerre knew from chemical treatises that calomel contained more mercury than corrosive sublimate, he may have deduced that mercury was the active ingredient for whitening silver plates, or perhaps a few drops of mercury splashed on a plate from a broken thermometer provided an instance for inductive reasoning. Of course this is speculative because the historical evidence has yet to be found or is forever lost. To partially fill in the gap, DagTest 1-21-2011 (Fig. 81) shows that a tiny drop of mercury placed on a silver plate will amalgamate after a time into to a brilliantly white crystalline spot. Interestingly, tiny beads of mercury less than a half-millimetre in diameter became amplified by roughly fifty times over the course of a day. Viewed in a light microscope and in hand these spots look exactly like the white highlights of a well-made daguerreotype.

⁵⁶⁸ R.M. Swiderski, *Calomel in America: Mercurial Panacea, War, Song and Ghosts*. Brown Walker Press, 2008: 23-24.

⁵⁶⁹ The original line in *La Photographie* reads, “De là aux vapeurs métalliques il n'y avait qu'un pas, et mon bon génie me le fit franchir”. Mon bon génie literally means “my good genius”. Daguerre was speaking about an internal ability, or tacit understanding, which allowed him to take the last step from calomel to mercury. I interpret this sentence to mean experiments and the knowledge gained from them inspired the discovery of mercury vapour. The Gernsheims translation of “mon bon génie” is simply “good fortune led me” which diverts the meaning away from Daguerre’s ability and reinforces the myth of the magic cupboard.

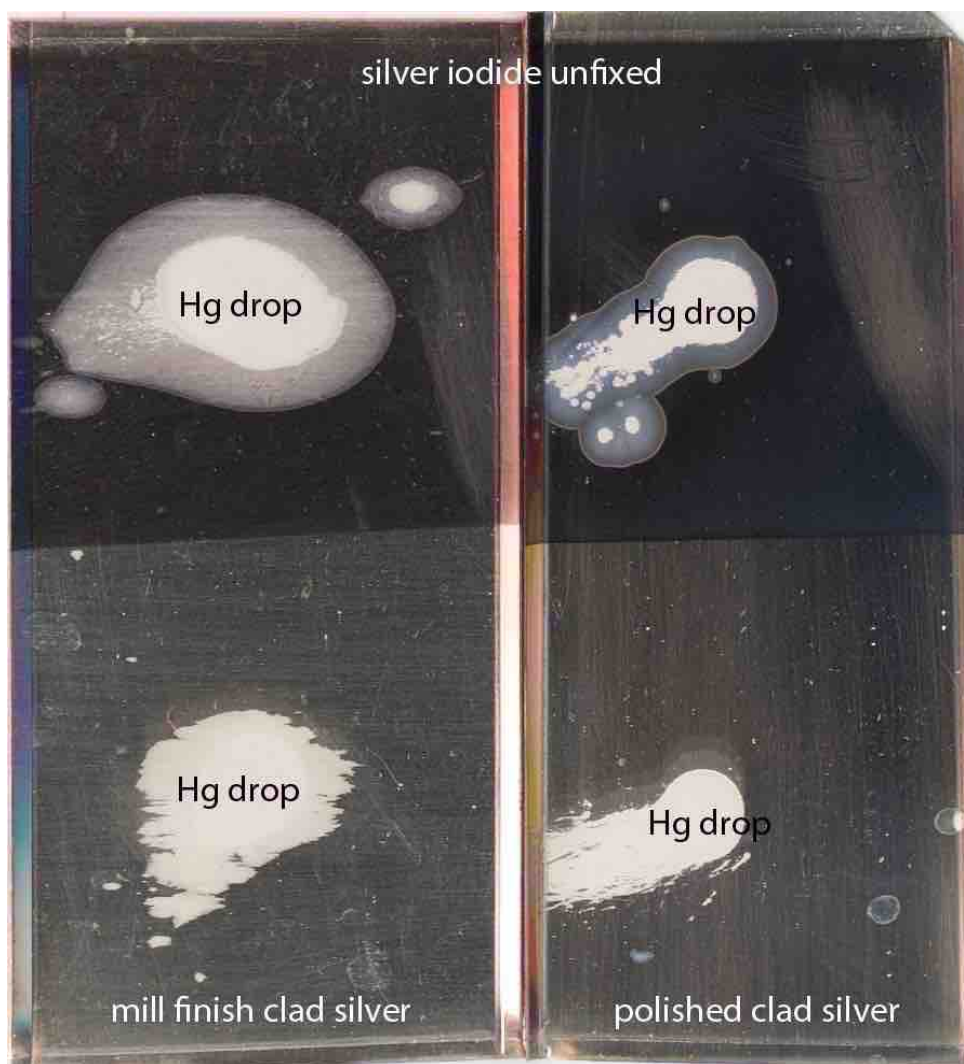

Figure 81. DagTest 1-21-2011. Mercury droplet test.

Sometime after Niépce's death in 1833, Daguerre realized that light decomposes silver iodide to metallic silver. Perhaps Dumas or others in the French scientific community provided the information, or perhaps he was able to infer it from chemical treatises. However he knew this, he makes the point explicitly clear in his manual.⁵⁷⁰ In the experiment above, I applied liquid mercury droplets to polished

⁵⁷⁰ Louis Jacques Mandé Daguerre, *Historique et description des procédés du Daguerreotype et du Diorama*. Alphonse Giroux et Cie ed. Paris: Delloye, Libraire, 1839: 39 footnote. "It is of importance to point out to the reader that the use of iodine here made by Mr. Niepce only to blacken his plates, proves that he was not acquainted with the property possessed by this substance, when in contact with silver, of being decomposed by light." J. S. Memes, translator for the English edition elaborated further, "[Daguerre's own method, as the reader will hereafter understand, depends on

and unpolished, plain and light darkened iodized silver surfaces. For this test, mercury and silver were in bulk form and gradually amalgamated together. Liquid mercury easily penetrated the silver iodine layer, clearly showing that in this form it would not be suitable for image development. The printed-out silver metal on an exposed silver iodine surface is infinitely finer than the bulk silver of the plate. Mercury levels have to be reduced significantly to maintain the correct proportions to amalgamate with the image silver and not penetrate the silver iodide layer to react with the plate itself, which would fog the shadows. Once again, Daguerre resorted to vapour to balance the image silver and mercury reactants.

The exposure times described by Daguerre in the summer of 1835 indicate that he had yet to discover the latent image and was still trying to convert the visibly dark images on his plates to white.⁵⁷¹ I am further convinced of this by his own account of discovery told in person to an American daguerreotypist. Charles R. Mead, a New Yorker, travelled to Bry-sur-Marne in 1848 to interview and photograph the inventor. Mead's account was printed in Levi Hill's *A Treatise on the Daguerreotype: and the Whole Art Made Easy*:

How a man could ever think of combining so many things to produce such a result is quite astonishing. He stated that after iodizing his plate and exposing it in the camera he held it over mercury heated in an iron crucible, by means of a furnace, to the *boiling point*. Every one acquainted with the art knows what would be the result with mercury at such a heat.⁵⁷²

Anyone acquainted the daguerreotype, as a practitioner, knows that boiling mercury is not only extremely dangerous but the fumes given off would be in such excess for latent image development that the entire plate would be veiled with a white fog. However, to determine if it were possible to convert a dark printed-out image to white, I exposed un-polished and iodized plate, with a visible design

this decomposition of iodine. This is the great distinction between the old and new processes-between Niepce's and Daguerre's systems-in a word, between the approximation and the real principle. —TRANSLATOR]".

⁵⁷¹ See Chapter 3, p 74. The Silver Plate: Technological Progression to Silver.

⁵⁷² Levi L. Hill, *A Treatise on Daguerreotype; and the Whole Art Made Easy*. Lexington, N. Y.: Holman & Gray, 1850: 6-7.

created by daylight, to mercury vapour held at 177°F for one hour, about ten times longer than necessary for latent image development (Fig. 82).



Figure 82. DagTest 1-14-206. Mercury reversal of a visible negative image.

Daguerre's method of reversing printed-out camera images with mercury vapour is proved feasible by this replication. In the late summer of 1835 then all the elements were in place for Daguerre to discover the latent image, not by accident, but through further experiments. Searching for shorter exposures, Daguerre likely reduced them to the state of invisibility and correspondingly reduced the temperature of the mercury to maintain the right balance of latent image silver and mercury vapour concentration for effective amalgamation.⁵⁷³ Effective amalgamation in this case means amplifying the invisible latent image to the point of visibility, similar to the fifty-fold amplification witnessed in the droplet test, and producing an image with good contrast, not unlike the goal of all other means of photographic development. The greatest advantage provided by the discovery of the latent image is that exposure times of just a few minutes in good light were possible.

That story of accidental discovery has been told and re-told, so much so as to be indelible in the fabric of photographic history. I have shown that Daguerre's use of mercury vapour to develop images, though extraordinary and astonishing, can

⁵⁷³ M. Susan Barger presents a model different than amalgamation, that mercury serves as a vapour phase mineralizer and plays no chemical role in development. This is addressed in the fourth section of this chapter, p 308.

be traced as a step-by-step process of inductive reasoning, and not due to chance. I argue that the magical notion of latent image discovery as presented in different accounts doesn't materially work due to the incorrect proportions of latent image silver and mercury vapour, though I do present an alternative interpretation for the tale of a few drops of spilled mercury, in my example reacting directly on a plate in liquid form. Liebig's account which described a greater quantity of mercury applied over a longer period of time was written fifteen years after Daguerre died and is most likely a misinterpretation of the details. The mercury box that Daguerre used does have a basin in the bottom for mercury and it could be taken for a cupboard. My revised interpretation of this history has been achieved by re-visiting the historical record with a perspective informed by practice and augmented with historical re-enactments.

In September 1835, Daguerre announced that he was successful in fixing permanently the image from the camera obscura. This announcement has received little attention, dismissed as premature, and described as "pretended improvements and discoveries were only-just as up to now, -vainglorious imaginings of Daguerre".⁵⁷⁴ One of the most significant re-enactments connected with this study, which now follows, provides credible evidence that Daguerre's announcement was not pretended or imagined.

⁵⁷⁴ Victor Fouque and Edward Epstean, *The Truth Concerning the Invention of Photography: Nicéphore Niépce; His Life, Letters and Works* [in English]. New York: Tennant and Ward, 1935: 113.

7.3 Image Fixed: Louis Daguerre's 1835 Discovery

It is said that Mr. Daguerre has discovered a means of receiving on a plate of his own preparation the images produced by the camera obscura, so that a portrait, a landscape, a view of any kind, projected on this plate in the ordinary camera obscura, leaves its imprint there in light and shade, and thus presents the most perfect of all drawings--*Journal des Artistes*, *Septembre 27, 1835*.⁵⁷⁵

News that images from a camera obscura had been preserved on a plate in values of light and shade received little fanfare because Daguerre, intending to make further refinements, never publicly showed his results at this stage, and a year later few had seen any physical proof.⁵⁷⁶ Alphonse Eugène Hubert, an architect who had an interest in photochemistry, wrote critically in the same journal that Daguerre's images, if they did exist, must only have been shown by moonlight, kept hidden from daylight between pages of black paper in a night album. Hubert's dismissive response was informed by his own experience with the then impermanent nature of silver chloride images exposed to light after their creation.⁵⁷⁷ The debate about Daguerre's first permanent image has continued with the majority of historians accepting the date of 1837, based on the dedication and inscription written on the back of the earliest extant daguerreotype. "This test was used to record the discovery of the daguerreotype offered to Monsieur de Cailleux, by his very devoted servant. Daguerre [1837]".⁵⁷⁸ Stephen Pinson questions this date based on etymology because the word "Daguerréotype" wasn't adopted until April 1838, and speculates that "Daguerre probably produced his first

⁵⁷⁵ "Diorama." *Journal des Artistes* 13 (September 27, 1835): 202-4.

⁵⁷⁶ There is evidence that some had seen his early work. A foreign correspondent, most likely a French national, wrote that he had seen examples of Daguerre's images made four years earlier and noted a "haziness that he has since overcome". In "Foreign Correspondence." *The Athenaeum, Journal of English and Foreign Literature, Science and the Fine Arts*, no. 587 (January 26, 1839): 69.

⁵⁷⁷ Hubert, "M. Daguerre, la chambre noir, et les dessins qui se font tout seuls." *Journal des Artistes* 2, no. Séance du Lundi 11 Septembre (1836): 166-8. For a comprehensive review of the 1835 announcement in *Journal des Artistes* and Hubert's response see Paul-Louis Roubert, "Hubert, ou l'honneur de Daguerre." *Études photographiques* 16, no. May (2005): 41-49.

⁵⁷⁸ Stephen C. Pinson, *Speculating Daguerre: Art and Enterprise in the Work of L. J. M. Daguerre*. University of Chicago Press, 2012: 201-2.

daguerreotypes as early as 1834” from the evidence given in *Journal des Artistes*. This is vague, however, concerning the date of his first *fixed* daguerreotypes.⁵⁷⁹ Pinson devotes a section to image permanence in *Speculating Daguerre* but he avoids the question of light fastness altogether and focuses on coatings applied to the plate as after-treatments to prevent tarnish.⁵⁸⁰ The question remains as to when the first stable, fixed, or permanent daguerreotype was made. I include these three terms because historians have generally interpreted the term “fixed” to mean the chemical removal of light sensitive silver salts to prevent the continued reaction to light, once the image is made. In the context of this section, *fixed* is not defined by a chemical treatment, but is considered as the original intent; a still image made in a camera and resistant to further changes in daylight.

Daguerre informed Isadore Niépce that he had found several ways to secure the image by removing the light sensitive silver iodide.⁵⁸¹ Two of these fixing methods are mentioned obliquely in a letter dated October 5, just one week after the notice in *Journal des Artistes*. One was acid to etch away the silver halide, but the acid partially destroyed the developed images as well.⁵⁸² Daguerre elaborated on his many failures using this method four years later.⁵⁸³ The second method contained in this letter has gone unnoticed in all previous histories. Daguerre wrote, “I had let the sun in my laboratory without any precaution to preserve

⁵⁷⁹ Pinson, *Speculating Daguerre*. 2012: 232.

⁵⁸⁰ Pinson, 136.

⁵⁸¹ See Chapter 3, p 86. Daguerre to Isidore on December 15, 1839. “I have found several ways to make the first substance [silver iodide] disappear which is of utmost importance to the secret of securing the image, yet none is perfectly suitable”.

⁵⁸² Louis Jacques Mandé Daguerre, “Letter to Isidore Niépce - October 5, 1835.” In *Dokumenty Po Istorii Izobreteniiia Fotografii* [Documents on the History of the Invention of Photography], edited by Torichan Pavlovich Kravets. Moscow: Izd-vo Akademii nauk [Academy of Sciences], 1949: 436. Kravets reproduced the original letter in French and the important line here is “le moyen qui me servait à détruire la substance première a aussi contribué à détruire en partie les images que j’avais obtenues”.

⁵⁸³ Louis Jacques Mandé Daguerre, “Des procédés photogéniques considérés comme moyens de gravure. — Lettre de M. Daguerre à M. Arago”. *Compte rendus hebdomadaires des séances de l’Académie des sciences*, no. Séance du Lundi 30 Septembre (1839). 423-30. Daguerre wrote, “I tried a dilute mixture of nitric and muriatic acid, and likewise several acid vapours, but the results were defective”. Daguerre intended to fill the etched portions of the plate with black pigment to enhance contrast.

them".⁵⁸⁴ I was able to comprehend the meaning of the text because of my re-enactments based on printed-out silver iodide. I formed an hypothesis that after a latent image was developed with mercury vapour, it might be possible to *fix* the image by allowing the silver iodide to be decomposed by light, thereby converting the shadows to black printed-out silver. DagTest 11-27-2014 (Fig. 83) proves my hypothesis correct. I cleaned an unpolished plate with dilute nitric acid and iodized it to a golden yellow. After an exposure time consistent with what Daguerre might have used in December 1835, I developed the latent image with mercury vapour.⁵⁸⁵ I then placed the image upright on a shelf in my studio to expose the plate to fifty consecutive days of daylight. Within five hours the shadows had darkened to render a positive image. It grew a little darker the following day and essentially remained unchanged for nearly two months at which point I sealed it with tape behind glass to protect the plate from tarnishing. It looks the same now, more than two years after sealing it.

⁵⁸⁴ Daguerre, "Letter to Isidore Niépce - October 5, 1835." In Kravets. 1949: 436.

⁵⁸⁵ This presumes Daguerre was using his six-inch single achromat stopped down to *f*/7.5 as explained in Chapter Six. For this experiment I used a single achromat at *f*/16. Daguerre reported 15 minutes in mid-December. I required 45 minutes in late November with a smaller aperture.



Figure 83. DagTest 11-27-2014. Mercury developed latent image highlights with silver iodide printed-out shadows.

This experiment shows that it was possible, with the materials and methods available in 1835, for Daguerre to fix the image in a camera by any measure of permanence we reserve for photographs today, and that the description in those few lines in *Journal des Artistes* that September was accurate.

The notice closes with “Physical science has probably never presented a marvel comparable to this” yet Daguerre did not publicly show his results.⁵⁸⁶ He was not yet ready to market this system because he felt more work was needed to improve on image clarity and contrast, and implored his business partner to be patient.⁵⁸⁷ It seems natural that Daguerre, who has made a career of painting realistic illusions with his Diorama scenes, would be dissatisfied with his 1835 results and strive for a better tonal range. Daguerre tried and abandoned various acids to bite in the shadows to receive black pigment, and realized the only way he

⁵⁸⁶ "Diorama." *Journal des Artistes* 13 (September 27 1835): 204.

⁵⁸⁷ Daguerre, "Letter to Isidore Niépce - December 15, 1835." In Kravets. 1949: 441.

could preserve the microscopically fine details present in the mercury amalgam image particles, while achieving the desired contrast, was to polish the silver plate before sensitizing. This technique creates reflective shadows that appear much darker and richer than the black of darkened silver iodide and for this to succeed Daguerre had to find a means to chemically remove the silver iodide. This he discovered in 1837 with salt water electrolytic fixing as described in the section on experimental design (see Chapter 2, p 63). In 1839 and beyond the preferred fixer was sodium hyposulphite (thiosulphate). Salt water or 'hypo' both serve to fix the daguerreotype though the later is much more expedient. The use of one or the other has no visual effect on the daguerreotype image tone or contrast so this is the extent of discussion on the chemical fixing process.⁵⁸⁸ Figure 84 compares a salt-water fixed plate with a sodium thiosulphate fixed plate that I made for research purposes for the Library of Congress in 2010.

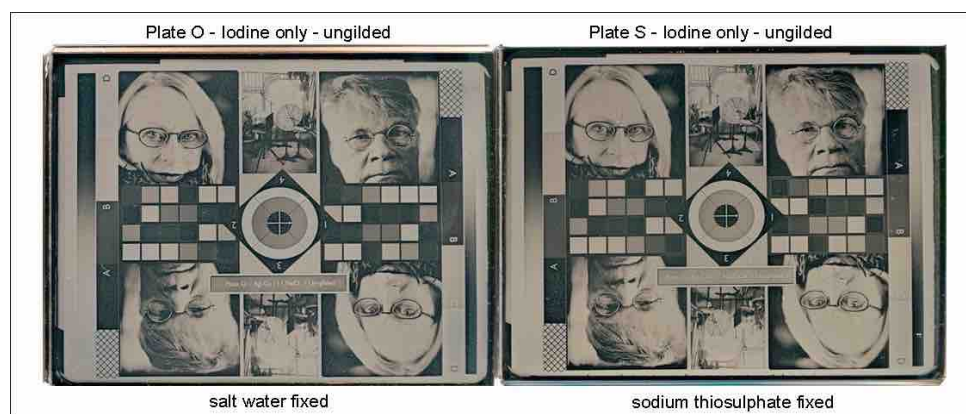

Figure 84. Salt fixed daguerreotype (left). Sodium thiosulphate fixed daguerreotype (right).

⁵⁸⁸ I know from my re-enactments that image colour is not affected by fixing methods, however, if the sodium thiosulphate solution is too strong (more than 10% solution) it will create defects and tidelines in the highlights that appear in the gilding process.

Mercury development conditions of time and temperature affect speed and tone because these variables influence the formation of the image amalgam particle in terms of size, frequency and shape. Their physicality directly affects the appearance of a daguerreotype because the image is visible by incident light that has been scattered by the particles. Development variables and their influence on image particle morphology are explained in the next section.

7.4 Image Development: Time and Temperature

Daguerreian James F. Ryder recalled his early days as a daguerreian and the many difficulties with the process. Regarding the mercury he wrote:

I had been much troubled at first on account of the shirt bosoms and other parts which should have taken white in the picture but came out blue...I asked [a visiting daguerreotypist] if he knew a remedy for it. He said, "Oh, yes but I shall want \$10 for it."...He told me to slightly increase the blaze of my spirit lamp under my mercury bath and try a picture. This I did, and my trouble in that respect was gone.⁵⁸⁹

Ryder improved his results by raising the heat to increase the vapour pressure, or concentration of mercury within the bath. On the other hand, S. D. Humphrey listed the effects produced by the mercury vapour at different lengths of time. He described results ranging from an overall deep blue impression at thirty seconds, to hard and chalky shadows misty with excess mercury at three minutes. The ideal time, he suggested, with the mercury temperature at ninety degrees centigrade was two and a half minutes yielding images that were "clear and pearly; shadows clear and positive, of a purple tint; drapery, jet black, with the dark shades slightly frosted with mercury".⁵⁹⁰

To understand the effects of development time, I designed an experiment that allowed for a single plate, divided in quadrants, to be exposed to mercury vapour for one, two, four and eight minutes at 177°F. I focused the camera on a printed target with four identical colour wheels and 11-step grey scales placed so that each one would be situated within one of the quadrants. After the main exposure, I added a second exposure to create an intentionally over-exposed perimeter while masking out the first with a nonpareil shaped blank (Fig 85). The experiment, DagTest 3-18-2011, was repeated and cut into pieces to fit within the chamber of a scanning electron microscope.

⁵⁸⁹ James Fitzallan Ryder, *Voigtländer and I in Pursuit of Shadow Catching; a Story of Fifty-Two Years' Companionship with a Camera*. Cleveland: Cleveland Printing & Publishing Co., 1902: 23-4.

⁵⁹⁰ Samuel D. Humphrey, *American Hand-Book of the Daguerreotype ... Containing the Daguerreotype, Electrotype And ... Other Processes ...* Fifth Edition. New York, 1858: 41.

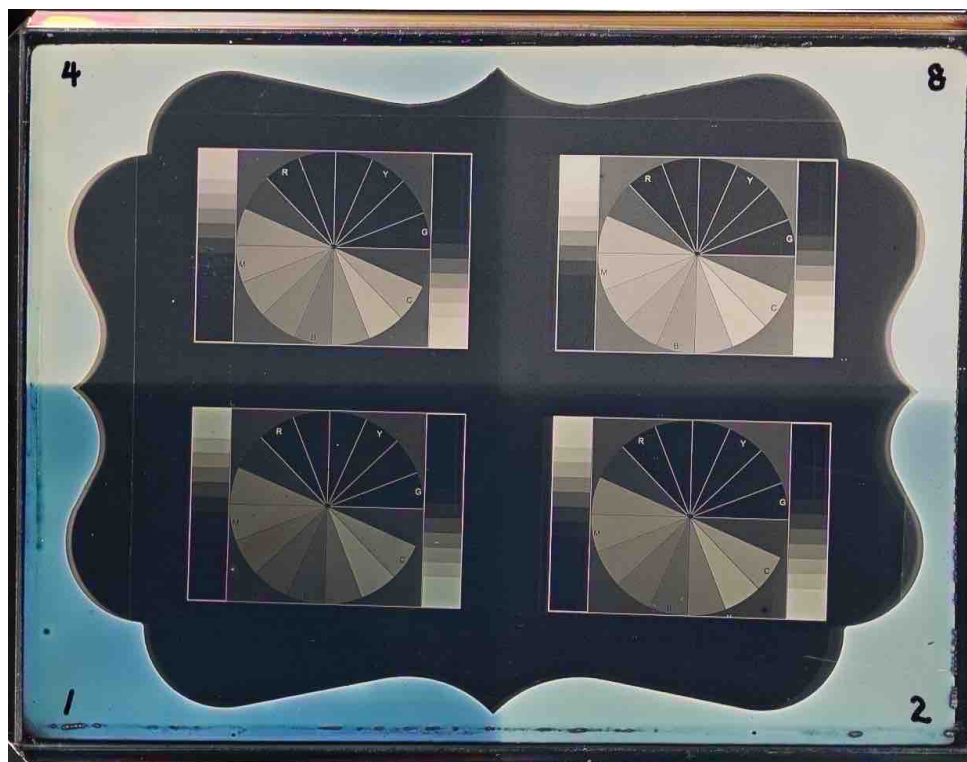

Figure 85. DagTest 3-18-2011. Plate developed for 1,2,4 and 8 minutes at 177°F, fixed and gold toned.

Three conclusions about image quality arise from this experiment. First, overexposed areas that appear blue at one minute of development appear less blue at twice the time, and fully white with magenta hues given eight times more mercury vapour. Increasing development by time or temperature agrees with J. F. Ryder's lesson heading this section. Second, increasing development to gain brighter whites comes at the expense of reflectivity in the dark tones of the plate because these values become frosted with mercury as S. D. Humphrey observed. The final conclusion is that increasing development time allows for shorter camera exposures. This information is supported by brightness measurements recorded for each step of the greyscale targets (Fig. 86).⁵⁹¹

⁵⁹¹ The measurements are obtained from L*a*b* readings taken from a digital reproduction of the daguerreotype using Adobe Photoshop® software.

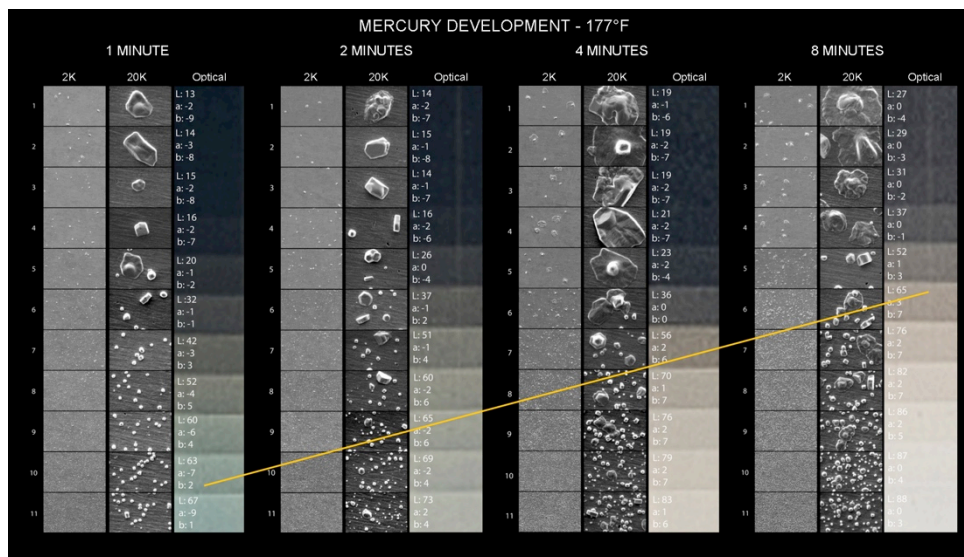

Figure 86. DagTest 3-18-2011. SEM micrographs at 2K and 20K and L*a*b* values for each step of the test targets at four development times. The SEM images indicate the image particle size, frequency and shape which determines image colour, and the yellow sloping line indicates a gain in photographic speed.

Increasing development from one to four minutes at 177°F essentially allows for a camera exposure in one-third the time.⁵⁹² Eight minutes development provides more speed still, but yields excessively large shadow particles that are counterproductive for image quality. SEM images of the dark steps in the test targets show a mercury rich apron surrounding shadow particles that become increasingly larger with extended mercury time or temperature.⁵⁹³ This is the nature of the frosted dark shades described by Humphrey. Daguerreian frosting occurs primarily in the deepest shadows. The reason being proportionally more mercury molecules available to amalgamate with the relatively few latent image or photolytic silver particles, so the particle grows at a greater rate than highlight particles. The shadow particle agglomerates can be as much as fifty times larger than highlight image particles. The relationship between mercury vapour and latent image intensity also explains the appearance of highlight areas in the

⁵⁹² At two minutes development, Step 9 of the target has the same brightness as Step 6 given eight minutes development. The reflection density of Step 6 is Log 0.45, or 1.5 stops darker than step 9. This is a factor of three which means the relative exposure required to achieve the same brightness can be reduced to 1/3 the time.

⁵⁹³ Confirmed by SEM microanalysis.

daguerreotype and accounts for the blue colour (solarization) in areas of extreme light exposure.

Barger and White offered four reasons for blue appearing images. The most relevant here is “extreme solarization...[where] image particle density is increased, and the average image particle size and spacing are similarly decreased, especially in the highlight regions”.⁵⁹⁴ This description is true when comparing the image particle frequency, size and spacing of a range of tones on a single daguerreotype that is visibly solarized (blue), however, SEM images of the solarized corners of DagTest 3-18-2011 given four levels of mercury development when viewed together offer much broader understanding of image particle formation, and provide precise information about image particle frequency and spacing that cause solarization (Fig. 87).

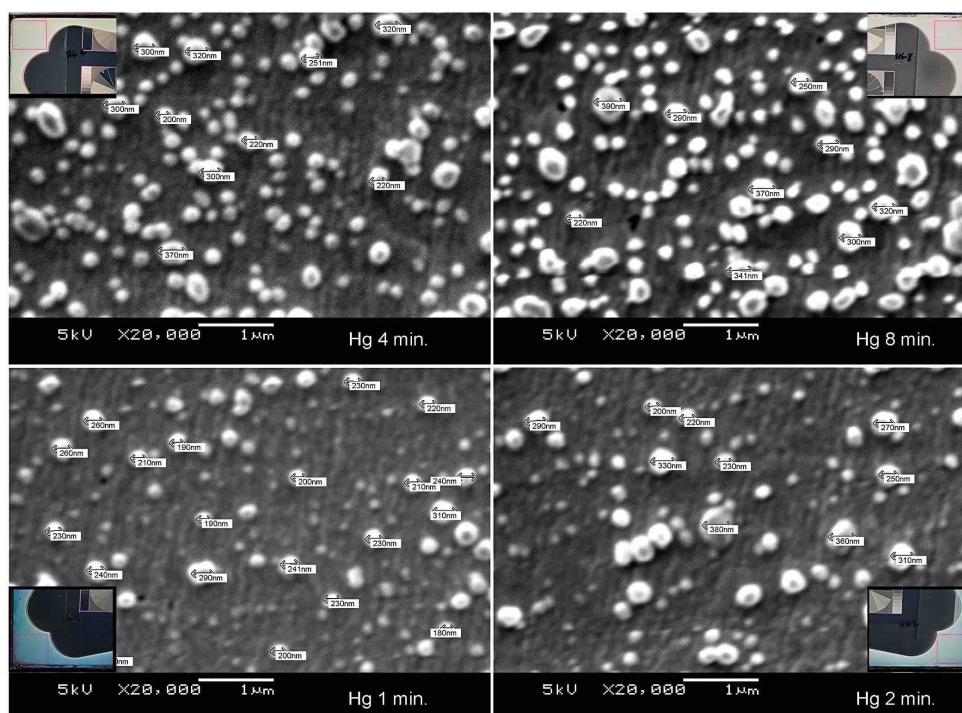

Figure 87. DagTest 3-18-2011. Solarized highlight particle size and frequency.

⁵⁹⁴ M. Susan Barger and William B. White, *The Daguerreotype: Nineteenth-Century Technology and Modern Science*. 2nd ed. Baltimore: John Hopkins University Press, 2000: 128-30. The other three causes for blue appearing images listed were, moisture during sensitizing, development for several hours over cold mercury (which is irrelevant to nineteenth century practice) and over-gilding (which is entirely incorrect). Extended gilding can convert a blue solarized highlight to white.

Each SEM image covers an area of roughly 27 square microns. One-minute development yields a frequency of about 80 particles over this area, and the average particle diameter is 230 nm. With two minutes, the frequency increases to 100 particles, four minutes 160 particles, and eight minutes 200 particles with an increased average diameter of 330 nm.⁵⁹⁵ In other words, a blue solarized highlight has a particle count of approximately 3 million per square millimetre, a pale blue highlight about 4 million particles, and a bright white highlight about 6 million particles per square millimetre. The mid-tones in a daguerreotype have on average only two hundred thousand particles per square millimetre so Barger and White are partly correct in saying that solarized highlights have a decreased particle spacing relative to mid-tone particles.⁵⁹⁶ What is new here is the observation that quadrupling the development time allows for twice as many latent image particles to be developed, and further decreases particle spacing along with an increase in highlight particle size causing a shift from blue to white. This also accounts for the three-fold gain in speed related to exposure as additional development promotes the amplification of more latent image particles.

Barger and White's model of latent image development does not take this into account. In their model, image particle formation follows sequentially from tiny particles dispersed uniformly over the plate into mercury rich gamma-phase (Ag_3Hg_4) amalgams. Further development, they suggest, alters the particle to a silver biased epsilon-phase amalgam ($\text{Ag}_{11}\text{Hg}_9$) and complete development yields a pure silver particle, with no mercury component.⁵⁹⁷ The authors posit that mercury essentially serves as a vapour phase mineralizer to cause metastable

⁵⁹⁵ Diameter is not entirely accurate to describe image particle shape. Pobboravsky and Wiegandt have recently made SEM images of daguerreotypes with the plate positioned at a 45° angle to the microscope objective. These unpublished images show a variety of shapes including elongated particles standing on end. Nevertheless, my SEM images taken with the plate at 90° to the objective show an increase in particle size and frequency with extended mercury development.

⁵⁹⁶ A mid-tone area having 200,000 particles per square millimetre provides a good indication of the resolving power of the daguerreotype. In comparison, a 100 megapixel digital sensor produced by Phase ONE®, the largest currently available, has a resolution of a little more than 45,000 pixels per square millimetre.

⁵⁹⁷ Barger and White, *The Daguerreotype: Nineteenth-Century Technology and Modern Science*. 2000: 156-7.

latent image silver to organize into discreet particle clusters of pure silver.⁵⁹⁸ They explain that shadow particle platelets or agglomerates remain as an amalgam due to insufficient latent image silver and the presence of them in highlights along with irregular shaped particles indicate that the daguerreotype was produced by a novice.⁵⁹⁹ Their model was developed in part by producing new daguerreotypes in the lab and micro-imaging them after 2 seconds, 15 seconds and 90 seconds mercury vapour development at an unspecified temperature. EDX-micro-analysis of these samples showed very little to no discernible mercury in the highlights with some in the mid-tones and the highest mercury levels in the shadows.⁶⁰⁰ Finding little or no mercury present in the highlight areas of their samples led them to conclude that mercury does not chemically contribute to the fully developed image particles, but plays the part of a solvent for silver crystal growth.⁶⁰¹ The challenge with analyzing the composition of un-toned daguerreotype image particles is that they lie on a solid silver surface. Barger and White analyzed their samples with high electron voltage (20keV) which, as has been discussed in the plate chapter, penetrates deep into the sub-surface resulting in excessively high silver counts compared to mercury. High electron voltage cannot accurately determine the chemical makeup of the image particles at the surface, thus their model for latent image development is questionable.

In 2016, Ravines et al. presented an updated model for latent image development inferred from scanning electron images of modern and nineteenth century daguerreotypes cross sectioned with a focussed ion beam. Ravines et al suggest that latent image development is a two-step process. At first, mercury vapour amalgamates with latent image silver to form cubic shaped gamma-phase (Ag_3Hg_4) amalgams or hexagonal shaped zeta phase ($\text{Ag}_{11}\text{Hg}_9$) amalgams.⁶⁰² Once these seed amalgam particles are formed, the mercury vapour then

⁵⁹⁸ This interpretation follows the model of silver gelatine emulsion developers.

⁵⁹⁹ Barger and White, *The Daguerreotype*. 2000: 158.

⁶⁰⁰ Barger and White, 121.

⁶⁰¹ Barger and White, 156.

⁶⁰² Barger and White referred to ' $\text{Ag}_{11}\text{Hg}_9$ ' particles as epsilon phase. Zeta is the more recently preferred Greek symbol for this particular amalgam species.

seamlessly transitions into an atomic mass-transfer mechanism, an updated term for vapour phase mineralizer suggested by Barger and White, to evoke additional silver from beneath and well beyond the image particle locations to supply more silver for the continued growth of silver-mercury amalgams into visible image particles. This model, the authors claim, explains the existence of the “sub/meso-surface” voids found in daguerreotype plate cross sections.⁶⁰³ I argue that these sub/meso-surface voids are caused by the gilding process, which is explained in the upcoming section, and that image particle formation is entirely a one-step process of amalgamation between mercury and latent image silver, silver sourced from the silver-halide coating, and bulk silver in direct contact with the latent image speck at the plate surface.⁶⁰⁴

Ravines et al surmise that there may be more than beta or zeta species amalgams present on the plate because of the variety of particle shapes ranging from trapezoidal solids, many-sided columnar shapes and other sub-micron sized geometries. Visual inspection, they acknowledge, is insufficient to determine the metallic mixtures and offer that XRF diffraction may provide more information on the amalgam species of the various particle shapes.⁶⁰⁵ I have found a simpler method. Daguerreotype image particles after fixing and before gilding, are loosely attached to the plate. It is possible to analyze the chemical composition of newly made unglided image particles separate from the plate by lifting them off the surface with a piece of Scotch brand cellophane adhesive tape.⁶⁰⁶ Micro-analysis of the image particles adhered to the tape show that on average, unglided highlight

⁶⁰³ Patrick Ravines, Lingjia Li, Lisa Chan, and Rob McElroy, "Some Science Behind the Daguerreotype: Nanometer and Sub-Micrometer Realities on and beneath the Surface." In *Nanoscience and Cultural Heritage*: Atlantis Press, 2016: 141-48.

⁶⁰⁴ The influence of the silver halide coating on image particles is clearly evident in the re-enactment of Baron Gros' test in Chapter 5, p 231.

⁶⁰⁵ Patrick Ravines, Lingjia Li, and Rob McElroy, "An Electron Microscopy Study of the Image Making Process of the Daguerreotype, the 19th Century's First Commercially Viable Photographic Process." *Journal of Imaging Science and Technology* 60, no. 3 (May 2016): 6, and Ravines, et al. "Some Science Behind the Daguerreotype: Nanometer and Sub-Micrometer Realities on and beneath the Surface." In *Nanoscience and Cultural Heritage*: Atlantis Press, 2016: 141.

⁶⁰⁶ Image particles after mercury development cannot be rubbed off the plate when the silver iodide is still present. After fixation they are easily detached. This method is destructive to the image and should not be considered for cultural heritage objects.

image particles are a solid solution of 32 atomic percent mercury and 68 atomic percent silver or nearly equal proportions by weight (Fig. 88). Sampling the various particle shapes showed differing atomic percentages of mercury and silver.

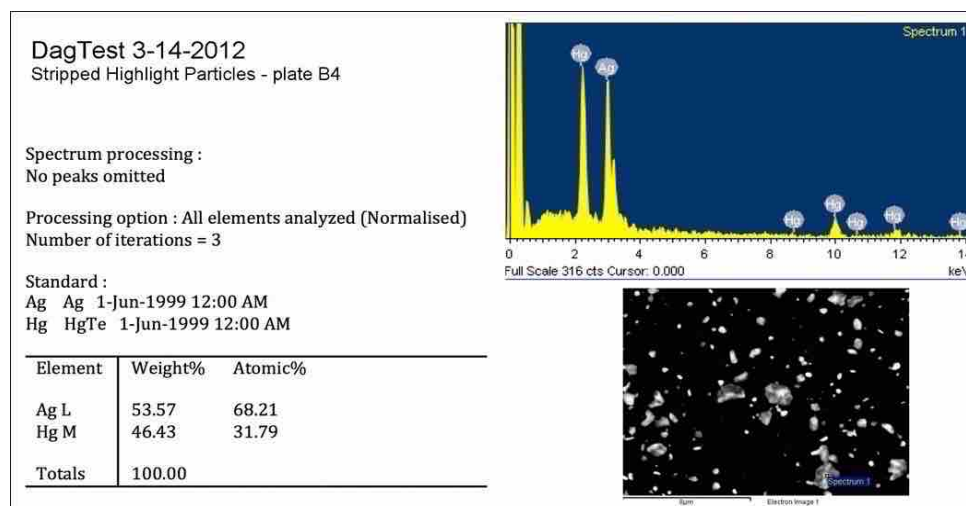

Figure 88. DagTest 3-14-2012. Analysis of highlight particles removed from the plate with adhesive tape.

This method of SEM analysis confirms the role of mercury in latent image development in that it combines to form an amalgam or solid solution in varying ratios with silver. Furthermore, variations in image particle shape and the presence of platelets in the mid-tones or highlights is not an indication of the work of novice practitioners as proposed by Barger and White (see Chapter 2, p 44). It is related to the rate of image particle growth as affected by sensitizing and mercury processing conditions. Though the specific amalgam species was the focus of Ravines et al, this study is concerned with how the various sizes and shapes of the image particles influence image tone and how their structure is controlled by the development process. Ravines et al noted that, “The presence of these [structures] will also depend and vary according to the steps followed and other procedural nuances exercised by each daguerreotypist”.⁶⁰⁷ I have made replications throughout this dissertation to examine many of these procedural nuances.

⁶⁰⁷ Ravines et al, “An Electron Microscopy Study of the Image Making Process of the Daguerreotype” *Journal of Imaging Science and Technology* 60, no. 3 (May 2016): 6.

Nineteenth century daguerreians did not agree on the ideal time and temperature for development. S. D. Humphrey worked with 90°C, Southworth and Hawes preferred 70°C, and Herman Krone recommended cycling through rising and cooling heat levels for the mercury.⁶⁰⁸ This discrepancy is partly due to the volume and design of the mercury apparatus, typically called a bath even though its purpose was to regulate vapour. The American cast iron full-plate bath, shaped like an inverted pyramid, has an internal volume of 2.45 litres, the half-plate version 0.85 litres, and the quarter-plate bath 0.45 litres. A typical French half-plate bath made with vertical wooden sides is 3.1 litres and Daguerre's full-plate wooden bath was 6.2 litres.⁶⁰⁹ The first law of thermodynamics dictates that at a given temperature, vapour pressure is inversely proportional to volume, so when the liquid mercury is heated to 70° Celsius for example, the vapour pressure within a quarter-plate bath will be greater than in a bath having a larger interior. Larger baths require more heat to generate an equivalent vapour pressure and achieve the same particle structure and visual effects of speed, tone, and contrast as that of a smaller bath operated at cooler temperature.⁶¹⁰ Consequently, mercury bath volume is another variable to consider along with time and temperature for latent image development.

Vapour pressure is directly proportional to gas molecule concentration. At a given heat, mercury vapour fills the internal space within the bath to reach equilibrium providing a uniform concentration at the surface of the plate.⁶¹¹ This

⁶⁰⁸ Samuel D. Humphrey, *American Hand-Book of the Daguerreotype ... Containing the Daguerreotype, Electrotype And ... Other Processes ...* Fifth Edition. New York, 1858: 41.

Beaumont Newhall, *The Daguerreotype in America*. 3rd revised ed. ed. New York: Dover Publications [etc.]; London: Constable, 1976: 125.

H.Krone and I. Schmidt, *Die Für Alle Zeit Von Praktischem Wert Bleibenden Photographischen Urmethoden*. Fotokinoverlag, 1985: 32-34.

⁶⁰⁹ These volumes were obtained from measurements of original apparatus in the collection of the National Gallery of Canada and the George Eastman Museum (see Chapter 2, p 59 Fig. 9).

⁶¹⁰ I usually operate my half-plate mercury bath at 158°F and my whole-plate mercury bath at 176°F. In each case, I develop the plate for eight minutes to produce the same results.

⁶¹¹ Due to this equilibrium, it makes little difference if the plate is placed horizontally on the bath as in the American design, or diagonally so the development process can be viewed through a red glass window as in the French design. I know of an English designed mercury bath for stereo plates where two plates at once are inserted into the vapour nearly vertical.

law of thermodynamics explains why shadow particles are large and highlight particles (particularly blue solarized ones) are very small. The mercury available at the plate surface is maintained at a constant concentration while the latent image distribution is controlled by camera exposure. There is proportionally less mercury available for amalgamation in the highlight areas, which limits the growth of the image particles, whereas in the shadows there is a proportional excess of mercury to do the work of amalgamation so very large mercury-rich particles are formed. This dynamic explains the formation of a uniquely daguerreian image effect seen as a bright white thin line that separates a solarized blue highlight from an adjacent shadow. This phenomenon is apparent along the nonpareil pattern in the one-minute development quadrant in figure 85, p 309. There is little mercury demanded from shadow zones immediately adjacent highlight zones and therefore available to fuel the amalgamation of larger image particles appearing as a thin white line along the intersection. The rest of the overexposed region is blue due to the demand for mercury from the vast amount of latent image silver in these areas. The formation of these so-called Mackie lines is not explained by the model of latent image development proposed by Barger and White or Ravines et al but is comprehensible if development is considered to be solely an amalgamation process in combination with the laws of thermodynamics within the mercury bath.⁶¹² The key point is that the varying quantities of latent image silver amalgamate with a relatively fixed quantity of mercury at the plate surface yielding the variety of silver-mercury mixtures and particle shapes.

The quantity of mercury available is established by time, temperature and volume of the apparatus and this controls image particle size, shape and frequency, and ultimately, the look of the daguerreotype. Image quality and characteristics of speed, tone, and prismatic effect are directly related to the physicality of the silver-mercury amalgam particles, which is influenced by the

⁶¹² I use "so-called" because 'Mackie line' refers to a narrow rim of white or black that occurs at the boundaries between adjacent highlight and shadow areas when inducing the Sabbattier (partial reversal) effect with modern gelatine silver emulsions in the darkroom. The mechanism is not the same.

processing variables chosen by each practitioner. Extending development by increasing time or temperature can prevent unwanted solarization and allow for reduced camera exposures but the technique is limited to the point when excessively large particles in the dark tones compromise image contrast and reduce the depth of the shadow values. In 1847, C. Laborde discovered that by introducing ether into the bath during development, a remarkably warm-toned image could be obtained.⁶¹³ Another benefit of the judicious use of ether is that it restrains the formation of large shadow particle agglomerates; an interesting and important revelation gained from replication experiments designed to test the advantages of ether. Though the combinations are endless, the next section provides an indication of the effects sensitizing halogens, mercury time and temperature, and ether have on image particle formation.

⁶¹³ Jean-Baptiste-Louis Gros, "Quelques notes -- A ajouter a la lettre de M. Le Baron Gros". In *Recueil de mémoires et de procédés nouveaux concernant la photographie sur plaques métalliques et sur papier*, edited by Charles Chevalier. Paris: Charles Chevalier, 1847: 53.

7.5 Image Development: Mercury and Ether

On October 4, 1846, Jean-Baptiste-Louis Gros wrote to Charles Cavalier to describe his methods in detail for inclusion in an upcoming publication of newly developed processes for the daguerreotype. He felt obliged to send an addendum the following summer to include further improvements in his sensitizing methods and alterations to his development process to use ethereal mercury.⁶¹⁴ Gros explained the benefits of ether in his own publication, *Quelques notes sur la photographie*, in 1850:

Few operators use the sulphuric ether advised by M. Laborde, physics professor at Corbigny, nevertheless an ethereal image is much warmer, bolder, and whiter in tone than one that is not and which was made under the same conditions as the first...It seems that under the influence of ether fumes the mercury molecules are deposited on the plate in new ways, and, without a doubt for me, this is completely favourable as to the beauty of the image.⁶¹⁵

Gros dipped the corner of a centimetre square of cotton velvet into ether to wick up some of the liquid and then dropped it into the mercury bath.⁶¹⁶ In replicating this procedure, I discovered the method was often a hit-or-miss depending on how much ether was absorbed by the cotton. The abuse of ether, Laborde warned, would cause the whites to merge with the mid-tones and shadows and destroy the contrast of the image.⁶¹⁷ Laborde advised that the ground end of a glass rod would retain sufficient sulphuric ether to develop a plate without overdoing it. The rod, wetted with ether was inserted through a hole in the side of the apparatus just above the liquid mercury. Sometime after 1847 Baron Gros modified his own

⁶¹⁴ Charles Chevalier, *Recueil de mémoires et de procédés nouveaux concernant la photographie sur plaques métalliques et sur papier*. Paris: Charles Chevalier, 1847.

⁶¹⁵ Jean-Baptiste-Louis Gros, *Quelques notes sur la photographie: Sur plaques métalliques*. revised 2nd edition, July 1850 ed. Paris: Roret, 1850: 87.

⁶¹⁶ Chevalier, *Recueil de mémoires et de procédés nouveaux concernant la photographie sur plaques métalliques et sur papier*. Paris: Charles Chevalier, 1847: 54.

⁶¹⁷ Edmund de Valicourt, "A New and Complete Photographic Manual for Metal Plates and Paper -- Containing All the Latest Discoveries. Translated from the French of E. De Valicourt, by A.B.W. Grigg". *The Photographic and Fine Art Journal* 7 (1854): 304. The original text excerpt from a brochure by N. P. Lerebours was published under the heading "Procédé de M. Laborde" in *Recueil de mémoires et de procédés nouveaux*.

mercury bath in a similar manner. An illustration at the end of his manual shows a glass tube with a drop or two of ether retained in one end sufficient for a full-plate. For this updated method, Gros heated the mercury to sixty degrees then after extinguishing the alcohol lamp, because ether is extremely flammable, inserted the glass tube containing ether into the side of his mercury box. He then placed the exposed daguerreotype plate over the mercury for development. Once the temperature had dropped by twenty-five degrees, the development process was complete.⁶¹⁸

To understand the effects ether has on image colour, I conducted several experiments in 2015 where one side of a plate was developed without and the other side with ether. I prepared plates with and without galvanizing, accelerated some with bromine and others with chlorine and bromine mixed, and tried different temperature settings for the mercury. Figure 89 shows three such experiments to correlate the effects of the above-mentioned variables when tested with and without ether. In all three experiments the etherized side appears more yellowish and warm-toned than the side developed without ether. Baron Gros' suggestion that the ether fumes caused the mercury to be deposited on the plate in new ways is confirmed by the image particle morphologies seen the scanning electron microscope images made from these plates. The SEM images provide a clear indication of how ether affects image particle shape and size throughout the tonal scale. Image particle growth in the highlights and mid-tones when ether was used is constrained to uniform spherical particles, and irregular image particles and platelets are present on the half developed without ether, particularly if chlorine was used during sensitizing. Furthermore, shadow particles in steps eight through eleven are twice if not thrice as large as their etherized counterparts.

⁶¹⁸ Gros, *Quelques notes sur la photographie*. 2nd edition 1850: 86-8 and illustration number 20 at the end of the text. Gros does not specify if his thermometer was calibrated in Celsius or Réameur. If the scale was Celsius the equivalent start and end points are 145° and 95° Fahrenheit. I suspect Gros used the French Réameur scale in which case his start and end points would be 167° and 110° F, which is more in line with practical working temperatures.

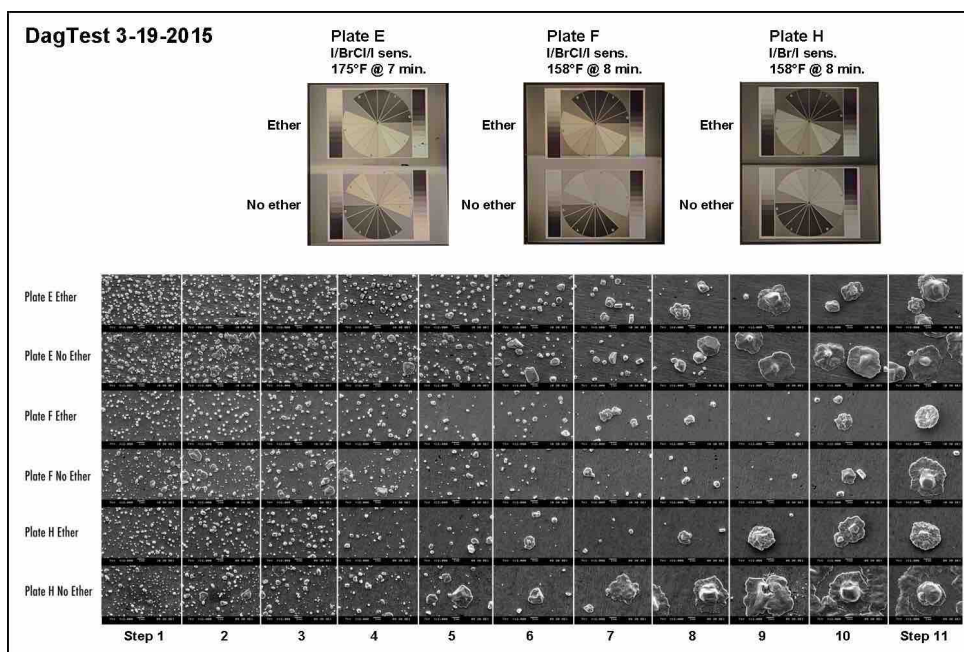

Figure 89. DagTest 3-19-2015. Variations in time and sensitizing, with and without ether with corresponding SEM images of the 11-step tablets.

An unexpected observation is that prismatic effect is lost with the use of ether. Prismatic effect, in which the apparent colour of the plate flips from cyan to magenta with a slight change in viewing angle, is a phenomenon that occurs in the mid-tones.⁶¹⁹ In DagTest 3-19-2015, the prismatic effect is most apparent on plates sensitized with chlorine (E and F) and on the plate accelerated with bromine only (H), the prismatic effect is less pronounced. The etherized half of all three tests, though warmer, did not change colour with slight changes of viewing angle. SEM images of mid-tone particles of Plates E, F and H (Fig. 90) present distinctly different particle morphologies. When image particles are uniformly spherical the apparent mid-tone colour remains unchanged with viewing angle. With the irregularly shaped mid-tone particles present in the non-etherized plates, particularly with the use of chlorine in sensitizing, the prismatic effect is strong. Hues apparent on the daguerreotype are due to the incident light being absorbed

⁶¹⁹ For an example of prismatic effect see Fig.1 in Chapter 1, p 7. Thomas Sutton when providing the definition of a fine daguerreotype admired this quality, and many of the daguerreotypes by Southworth and Hawes exhibit prismatic effect.

or scattered by the image particles and irregular shaped mid-tone particles with platelets seem to be main the reason for the prismatic affect phenomenon.

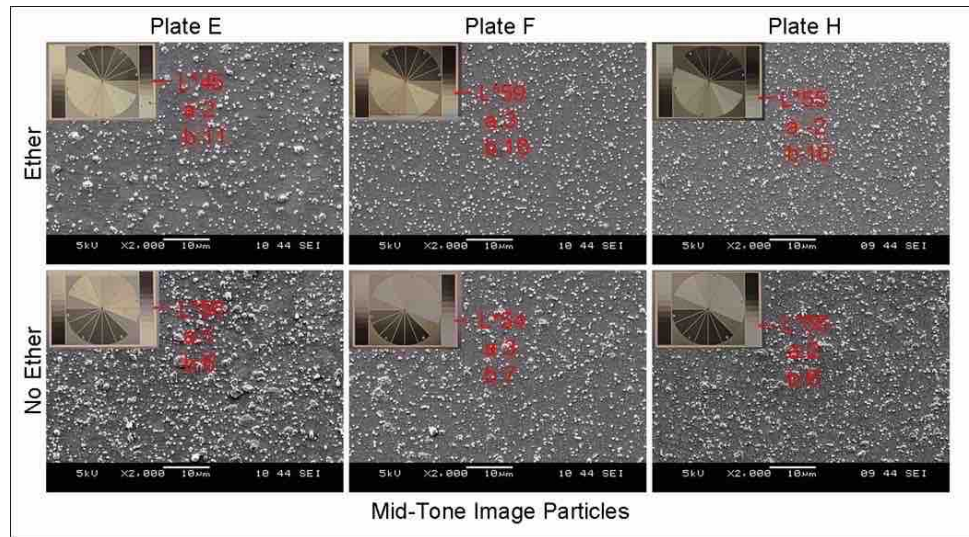

Figure 90. DagTest 3-19-2015. SEM images of mid-tones.

Comparing digital colorimetric values (CIELAB L*a*b) makes the warming effects of ether explicit.⁶²⁰ Plates E and H have yellow shifted in the mid tones by 5 and 4 units respectively and Plate F, with the most apparent difference in colour shifted in yellow by 9 units. The L* value is an indication of changes in brightness levels, which can also be taken to mean a change in photographic speed. Plate E lost speed with the application of ether, indicated by a brightness reduction of 11 units, Plate F gained speed by 5 units and Plate H remained nominally the same. These speed gains and losses are not related to sensitizing or plate variables, but are most likely due to the imprecise quantity of ether introduced to the system for each experiment because I used the wetted square of cotton velvet method described by Gros in 1847.⁶²¹

⁶²⁰ L*a*b* is a three-dimensional model for colour. L* is a luminance scale, the darkest value at 0 and brightest at 100. Zero values in the a* and b* axis indicate neutrality. The a axis is for green-red tints, minus a values for green and plus a for red. The b axis indicates the blue-yellow values. Minus b for blue and plus b for yellow.

⁶²¹ I was unwilling to drill a hole in the side of my mercury bath to insert a more precise measure of ether.

Ether effectively restrains daguerreian frosting in the shadows, but when too much is introduced it negatively affects speed. The additional manipulations and precision necessary to manage this volatile and flammable liquid partially explains why few daguerreians used it. American manuals by Snelling, Humphrey, Hill and Bisbee, and the English treatises by Hunt, Hogg and Bingham make no mention of ethereal mercury development. Furthermore, there are no historical records extant to indicate that the process was practiced outside of France.⁶²²

Late in the daguerreian era, Frenchman Eugène Mulon patented an apparatus to precisely regulate the introduction of ether (or chloroform) into the mercury vapour (Fig. 91).

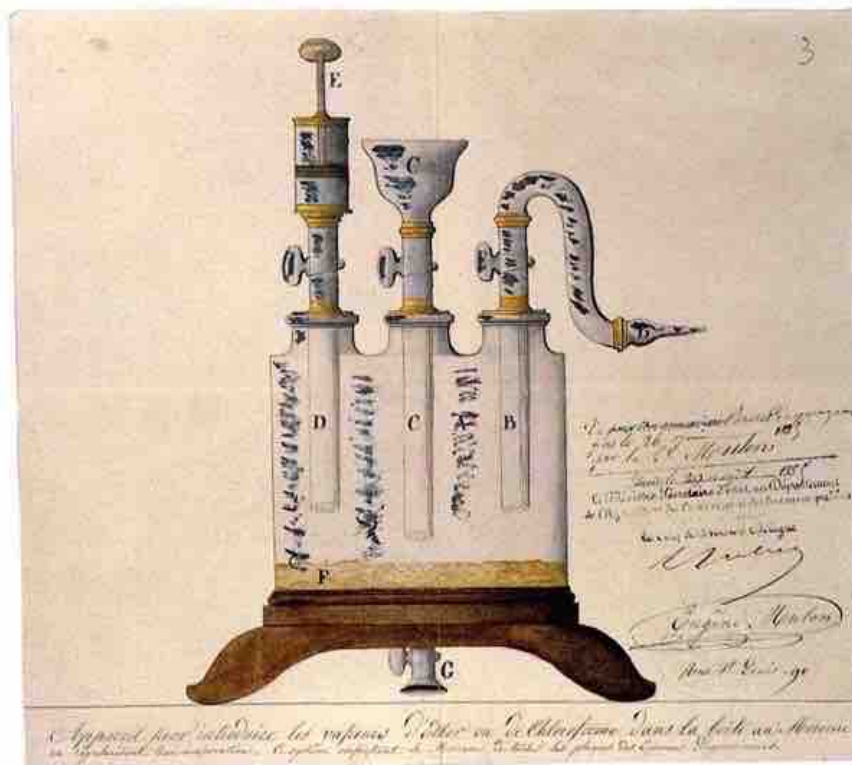

Figure 91. Patent by Eugène Mulon, 1855. Apparatus to introduce the chloroform or ether vapours into the mercury box by regularizing their evaporation. (*Paris et le Daguerreotype*, Musée Carnavalet, 1989: 26)

⁶²² The 1854 volume of the American *Photographic and Fine Art Journal* published a translation of Edmund de Valicourt's treatise, which includes Laborde's ethereal process. American studios, likely due to the extra complications it brought to the process, did not adopt it. Also, the American cast iron mercury bath design was not well suited for the use of ether.

Mulon's patent description makes no mention of the improved warmth and boldness of the images much admired by Baron Gros, but states that its use prevents the mercury from staining the plates, "C'est un système empêchant le mercure de tacher les plaques daguerriennes".⁶²³ Re-enactments with ether explicitly show that these stains refer to mercury frosting and that ether retards the formation of large shadow particle agglomerates. Ether use has significant implications for photographic sensitivity. Daguerreotype camera exposures can be significantly reduced and the underexposed details recovered with extended ethereal mercury development without fogging the shadow values. In fact Laborde recommended that for success with ether it was better to give the plates somewhat less than normal camera exposures.⁶²⁴ Ethereal mercury development must certainly have contributed to the short exposure times recorded by Baron Gros in 1850. With Chevalier's landscape lens and a one centimetre aperture and reversing prism his times were remarkably short between 4 and 6 seconds in Athens and 7 to 12 seconds in good light in Paris.⁶²⁵

Other beneficiaries of the use of ether may have been the brothers Hippolyte and Cyrus Macaire while daguerreotyping steam and sailing ships entering and leaving the port of Le Havre. The Macaire brothers became known for instantaneous daguerreotypes and Francis Wey lavished praise on their work:

⁶²³ Musée Carnavalet, Direction des affaires culturelles. *Paris et le Daguerreotype*. [Paris]: Paris-Musées, 1989: 26. Figure 8.

⁶²⁴ Edmund de Valicourt, "A New and Complete Photographic Manual". *The Photographic and Fine Art Journal* 7 (1854): 304.

⁶²⁵ Gros, *Quelques Notes sur La Photographie*. 2nd edition 1850: 84-5. Gros' lens with a one-centimetre aperture was stopped down to approximately *f*/40. His reported exposure times are between four and eight time faster than my experience using a similar lens and prism without ether. When I have used ether in the studio for portraits, have succeeded with four-second exposures that normally require twelve.

Every one admires at this moment in Le Havre the labours of M. Hippolyte Macaire, who, in the space of a fraction of a second, and by means of such rapid exposure...obtained such clarity in skies, waves and fire with flames...These drawings unite the sky with its clouds, the ship, all sails in the wind, with its pavilions agitated by the breeze...as if they had been placed before the lens in an instant of immobility.⁶²⁶

Weston Naef in *After Daguerre: Masterworks of French Photography (1848-1900)* dismissed the idea of rapid exposures for their daguerreotypes of ships leaving port, claiming that the Macaires merely relied on “trick photography” because ships moving on axis with the camera lens would appear motionless.⁶²⁷ Had Naef seen the daguerreotype that resurfaced in a French auction in early 2014 he may have offered a different opinion about instantaneous exposures. This warm-toned daguerreotype clearly indicates an exposure of fraction of a second with still clouds and waves and nearly motionless flags waiving from the mastheads (Fig. 92).

⁶²⁶ Francis Wey, "Des progrès et de l'avenir de la photographie." *La Lumière: journal non politique hebdomadaire: beaux-arts, héliographie, sciences* 1, no. 35 (Octobre 5 1851): 138-9. Cyrus Macaire arrived in North America from France in 1840. He practiced daguerreotypy in the southern states, New York state and Canada. He operated out of Eli Palmer's old studio in Toronto for a few months before returning home to join his brother in Le Havre.

⁶²⁷ B. Marbot, B. de France, M. Art, and M. du Petit Palais, *After Daguerre: Masterworks of French Photography (1848-1900) from the Bibliotheque Nationale*. Metropolitan Museum of Art, 1980: 30.



Figure 92. Cyrus and Hippolyte Macaire. *Navire quittant le port du Havre* (ca. 1851-53), collection of Jean and Leonard Walle.

Ethereal mercury, though little used, is the last of sequence of improvements that contribute to a gain in photosensitivity, after polishing, sensitizing and fast working optics. In 1840, Armand Hippolyte Fizeau, French chemist and inventor introduced

the mixed solutions of gold chloride and sodium thiosulphate to react with the silver-mercury amalgam image particles and silver plate surface. Gold toning is the final step in the production of a daguerreotype. The procedure does not influence photographic speed but contributes so significantly to image tone, contrast and improved stability of the image particles that it was quickly incorporated into practice.

7.6 Image Toning: Gilding

APPLIED CHEMISTRY. - NOTE on a means of fixing the photographic images by M. H. FIZEAU. [August 10, 1840]

(Excerpt)

(Commissioners, Messrs Arago, Dumas, Pelouze).

Since the publication of photogenic processes, everybody including M. Daguerre immediately recognized that a few steps still had to be taken to give his marvellous images all possible perfection; by this I mean to fix the plates and give to the lights of the tableau more intensity.

The procedure which I submit to the Academy seems to me destined to solve in large part this double problem. It consists in treating the plates with a gold salt prepared in the following manner:

One gram of gold chloride is dissolved in half a litre of pure water, three grams of hyposulphite of soda in half a litre of pure water. The solution of gold is then poured into that of soda, gradually and by stirring; the mixed liquor, at first slightly yellow, soon becomes perfectly clear...

The treatment with gold salt is of the greatest simplicity; it is sufficient to place the plate on the wire frame found in all the apparatuses, and pour on it a layer of gold salt sufficient for the plate to be entirely covered, and to heat with a strong lamp; we then perceive the test to clear and take, in a minute or two, Great vigour. When the effect is produced, pour off the liquid, wash the plate and dry.⁶²⁸

The title for Fizeau's note "a means of fixing photographic images" must not be confused with the removal of light sensitive silver salts. In this instance, fixing refers to a physical change in the structure whereby the treatment actually causes the delicate silver mercury amalgam image particles to be firmly attached to the surface of the plate. Without gold treatment, image particles are dislodged with the slightest touch but a gilded image can withstand the stippling and brushing necessary to apply finely ground colour pigments and bronze powder accents by hand.

⁶²⁸ Armand Hippolyte Louis Fizeau, "Chimie appliquée. — Note sur un moyen de fixer les images photographiques." *Compte rendus hebdomadaires des séances de l'Académie des sciences*, no. Séance du Lundi 10 Août (1840): 237-8.

The gilding formula introduced by Fizeau, containing gold chloride and sodium thiosulphate, remained essentially unchanged throughout the daguerreian era.⁶²⁹ Other means of toning by applying copper or gold overall or locally deposited via electroplating were attempted but these methods produced unusual colours on the plate and examples of images done this way are extremely rare.⁶³⁰ The common process was performed as Fizeau described; the fixed and washed plate was placed on a level support, the gilding solution poured on and the plate heated from below with an alcohol flame.⁶³¹ The operation was performed in good light to observe the toning reaction. It is best look at the plate with the meniscus of gilding solution filling its surface from an oblique angle to see a white reflection. In this way, the image appears negative and the toning reaction appears very much the way S. D. Humphrey observed:

It is not unfrequent that the surface assumes a dark, cloudy appearance. This is generally the best sign that the gilding will bring out the impression with greatest degree of distinctness. Soon, the clouds gradually begin to disappear, and, "like a thing of life" stands forth the image, clothed with all the brilliancy and clearness that the combined efforts of nature and art can produce.⁶³²

Gold toning improves the contrast in two ways. Gold ions from the toning solution bond with the image particles to increase their size. Larger particles scatter light more effectively so the whites of the image gain in apparent brightness after toning. The blacks of the image are improved because the silver surface, which has been corroded from the sensitizing process, is made smoother and more reflective.

⁶²⁹ S. D. Humphrey's *American Handbook of the Daguerreotype* recommended fifteen grains of gold chloride and sixty grains of sodium thiosulphate per pint to formulate the gilding solution. This is one-fourth more thiosulphate than Fizeau's formula. Nathan Burgess added extra sodium and ammonium chloride to the mixture. Extra salts in the solution increase the activity of the toning reaction.

⁶³⁰ Daniel Davis Jr, "Improvement in Coloring Daguerreotype-Pictures." United States Patent Office: Assignee John Plumbe Jr, Letters Patent No. 2,826, dated October 22, 1842, and Charles G. Page, "Mode of Coloring Daguerreotype Pictures." *Journal of the Franklin Institute* 37, no. 5 (1844): 312-13. The few examples I've seen coloured by Plumbe's patent are stained and mottled and images toned with gold by electroplating are quite gold coloured. See Ruitenbergh, L. "Two Golden Daguerreotypes: A Research Project" in *The Daguerreian Annual*, 2001: 2-12.

⁶³¹ See Fig. 10 in Chapter 2, p 61.

⁶³² Samuel D. Humphrey, *American Hand-Book of the Daguerreotype ... Containing the Daguerreotype, Electrotype And ... Other Processes ...* Fifth Edition. New York, 1858: 47-8.

Barger and White presented the gilding reaction as merely gold replacing mercury in the image particles and stated, "The shadow regions of the daguerreotype are not made darker, although by comparison with highlight areas they may appear blacker".⁶³³ This assumption is incorrect. Photo-documentation of modern daguerreotypes pre and post gilding confirm whiter whites and blacker blacks. I have recorded gilding effects on several modern images and on a re-used nineteenth century plate (Fig. 93).

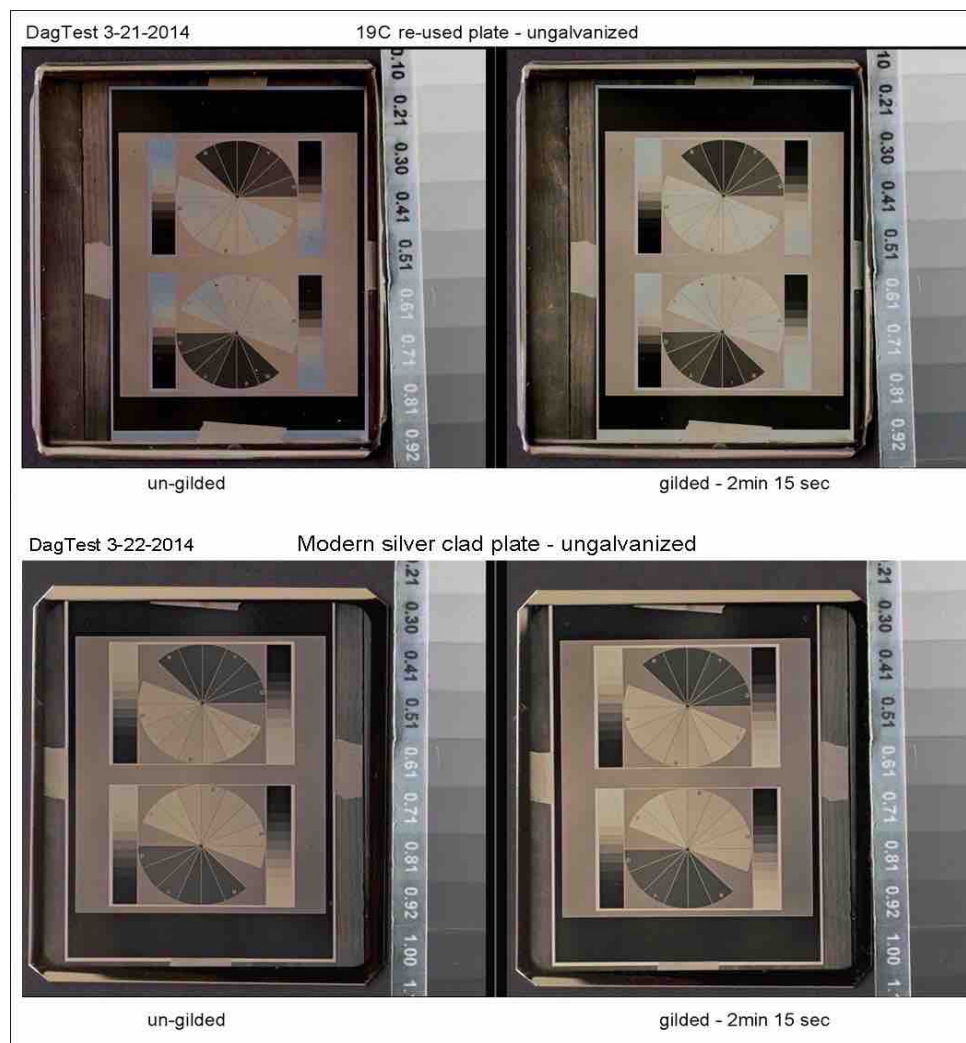

Figure 93. DagTest 3-21-2014. Nineteenth century plate (top). DagTest 3-22-2014. Modern plate (bottom). Before and after gilding.

⁶³³ M. Susan Barger and William B. White, *The Daguerreotype: Nineteenth-Century Technology and Modern Science*. 2nd ed. Baltimore: John Hopkins University Press, 2000: 146.

The highlights on the nineteenth century plate in pre-gilded condition were blue solarized and recovered to a bright white with 135 seconds toning. In both examples contrast was significantly improved with blacker dark values and the overall tone of the plate shifted from reddish to warm yellow mid-tones.⁶³⁴ Gold improved the highlight brightness by increasing the bulk of the image particles, improved the shadow values by creating a more reflective surface and in some manner fixed the image particles firmly to the plate. Within the last ten years there have been studies to understand the nature of gold toning on a nano-scale.⁶³⁵

Bigelow, Wiegandt and McIntyre, using FIB-SEM technology, cross-sectioned a series of nineteenth century plates and found sub-surface voids on gilded images and none on ungilded images. This unpublished work was presented at the Daguerreian Society Annual Symposium in 2014.⁶³⁶ Ravines, West, Minter and Gutierrez used ultra-high resolution SEM imagery to decipher the nanostructure of one nineteenth century daguerreotype. These authors concluded that gold formed in a discontinuous coating "composed of silver nodules with their tops covered with gold, similar to snow capped mountains" and argued this was the reason gold did not protect the daguerreotype entirely from tarnish. This conclusion about gilding structure was solely based on high-magnification SEM imagery without chemical micro-analysis.⁶³⁷ Recently, Vicenzi et al successfully analyzed a cross section of a gilded highlight particle on a nineteenth century plate using scanning transmission electron microscopy-energy dispersive spectroscopy (STEM-EDS) and nano-X-ray fluorescence spectrometry (nano-XRF). This work refutes the

⁶³⁴ The nineteenth century plate and modern plate were prepared identically yet the historic plate was about a third of a stop overexposed. The difference between the two images is most likely due to harder silver on the modern plate.

⁶³⁵ A nano-meter is one-billionth of a meter. One thousand nanometers is equivalent to one micron. Modern SEM microscopes used with low voltages can produce good surface detail images at 250,000 X magnification.

⁶³⁶ Nicholas Bigelow, Ralph Wiegandt, and Brian McIntyre, "Research on the Gilding of Daguerreotypes." Paper presented at the Daguerreian Society Symposium, Austin, Texas, 2014.

⁶³⁷ P. Ravines, A. West, J. Minter, and R. Gutierrez, Jr., "The Daguerreotype under High Magnification: An Ultra-High Resolution SEM Study of a 19th Century Daguerreotype's Surface Nanostructure." In *International Materials Research Congress, IMRC-Cancun 2009, and 2nd Latin-American Symposium on Physical and Chemical Methods in Archaeology*. Cancun: Art and Cultural Heritage Conservation & Archaeological and Arts Issues in Materials Science, IMRC 2009, 2009: 5.

“snow-capped mountains” theory presented by Ravines et al because it shows an image particle encapsulated by the gilding layer (Fig. 94).⁶³⁸

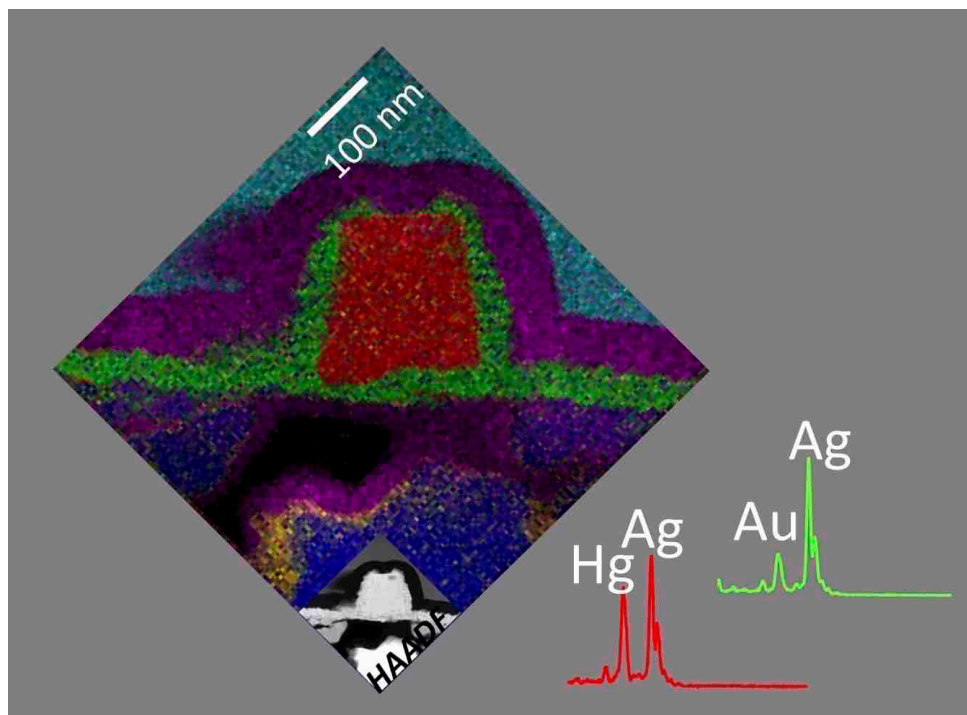

Figure 94. EDX chemical map showing daguerreotype image composition. Image (adapted) courtesy of Dr. Edward P. Vicenzi.⁶³⁹

Chemical mapping shows the image particle to be an amalgam of nearly equal parts silver and mercury and the gilding layer to be a silver biased mixture with gold. That silver is present in a mixture of the gilding layer and not covered by gold explains why daguerreotypes react with atmospheric sulphur and become tarnished. It is also clear in this chemical map that the gold silver mixture not only covers the image particle and the plate, it forms beneath the image particle creating a firm bond between it and the plate surface, which explains why gilded plates are far more resistant to image particle loss through abrasion. The TEM

⁶³⁸ Edward P. Vicenzi, T. Landin, A. A. Herzig, B. Stripe, and V. Rose, "On the Nanoscale Chemistry of a 19th Century Daguerreotype Photograph." In *23rd Australian Conference on Microscopy and Microanalysis (ACMM23) and the International Conference on Nanoscience and Nanotechnology (ICONN 2014) and Nanoscale Spectroscopy and Nanotechnology 8*. Adelaide Convention Centre, South Australia and Gleacher Center, Chicago, 2014.

⁶³⁹ Edward P. Vicenzi, T. Landin, and T. Herraiz, "Examination of a 19th Century Daguerreotype Photograph Using High Resolution Scanning Transmission Electron Microscopy for 2d and 3d Nanoscale Imaging and Analysis." *Microscopy and Microanalysis* 20, no. S3 (2014): 2000-01.

illustration in figure 94 also shows a void beneath the gilded layer under the image particle. This void is not caused by mercury development as suggested by Ravines et al but is due to the gilding process.

In 2008, I observed patterns on the substrate of newly made gilded daguerreotypes that were not present on un-gilded ones in SEM images made using 20kV for the electron beam.⁶⁴⁰ Barger and White assumed these patterns to be the result of cyanide etching caused by past conservation treatment. These patterns occurred on ninety-eight percent of the daguerreotypes they looked at leading them to conclude that almost all daguerreotypes have been compromised by corrosion due to conservation.⁶⁴¹ They did not realize that their micro-scope, set at 40kV, was imaging voids 200 nano-meters beneath the surface, as has been explained in chapter three. In reality, what Barger and White observed were artefacts of gilding, not cyanide etching, and it is very reasonable to state that ninety-eight percent of the daguerreotypes they looked at were gold toned. Figure 95 shows SEM images of an un-gilded modern plate, a gilded modern plate and a gilded nineteenth century plate. The void pattern is distinct though different between the modern and historic gilded plates and the un-gilded plate is void free providing strong evidence that the voiding phenomenon is gilding related. The cause of the difference in void pattern between the new and vintage plate can only be speculative; perhaps due to the hardness of the silver, the nuance in procedure or formula chosen by the maker or a combination of these or other factors.

⁶⁴⁰ Eric Da Silva, Mike Robinson, Christopher Evans, Ana Pejovic-Milic, and Darrick V. Heyd, "Monitoring the Photographic Process, Degradation and Restoration of 21st Century Daguerreotypes by Wavelength-Dispersive X-Ray Fluorescence Spectrometry." *Journal of Analytical Atomic Spectrometry* 25, no. 5 (2010): 654-61. For this work, samples were imaged at 5kV and 20kV. Un-gilded samples did not show the pattern at either voltage. On gilded plates the pattern is visible at 20kV but disappears at 5kV. The penetration depth of the electron beam increases with voltage so low voltages are best to reveal surface details.

⁶⁴¹ M. Susan Barger and William B. White, *The Daguerreotype: Nineteenth-Century Technology and Modern Science*. 2nd ed. Baltimore: John Hopkins University Press, 2000: 187.

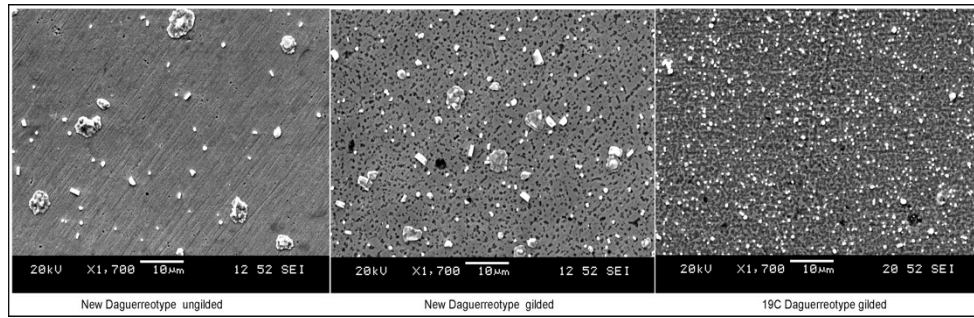

Figure 95. SEM micrographs of a void-free un-gilded plate and voids on gilded plates.

The nano-scale research mentioned earlier presents nineteenth century images in isolation making it difficult to co-relate void creation with gilding conditions. The ability of the SEM electron beam to reveal subsurface voids from a top-down perspective over the entire area scanned provides a useful tool to monitor the gilding process. This method is simpler and more cost effective than focused ion beam sections and provides a better indication of the overall void pattern than from single or multi-sectioned slices of the plate. DagTest 3-28-2016 is a series of SEM micrographs showing void growth as gold toning processes from un-gilded condition, ninety seconds gilding, three minutes and finally six minutes gilding time (Fig. 96).

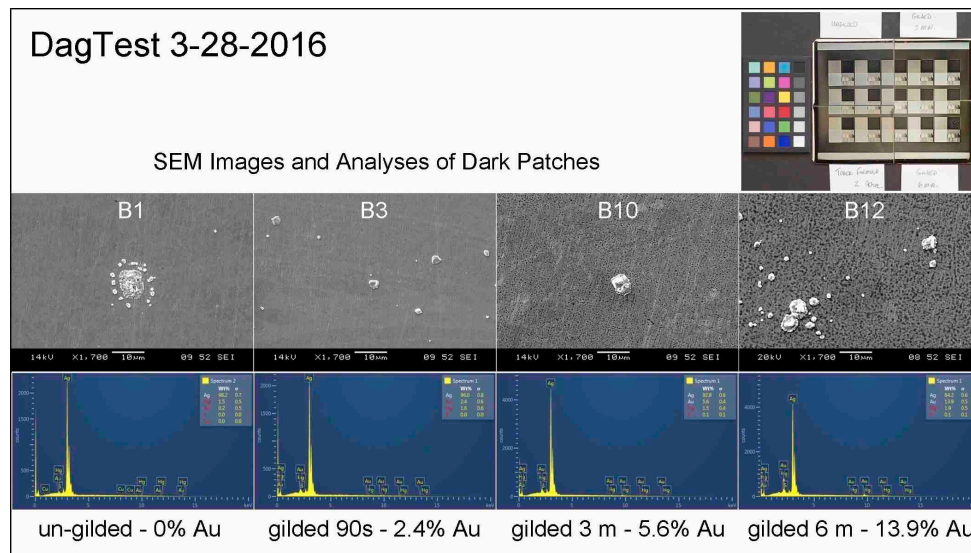

Figure 96. DagTest 3-28-2016. Void patterns and gold percentage at 0, 90s, 3m, and 6m.

It is clear that the voids are non-existent without gilding and increase in size as gilding progresses; proof again that the void phenomenon is gilding related. The levels of gold analyzed using XRF area scans increased by slightly more than double with each doubling of gilding time.⁶⁴²

The mechanism for void creation is galvanic corrosion. Gold, the more noble metal, functions as the cathode and silver the anode in the system. Studies of galvanic exchange on a nano-scale show that silver metal is oxidized in contact with gold chloride solutions and donates an electron for gold atoms to be “epitaxially deposited onto the surface as a thin layer”. As this gold layer increases to cover and protect the silver surface, corrosion becomes progressively stronger at the unprotected silver site leading to pinholes and eventually voids.⁶⁴³ Over-gilding and excessive heating can lead to catastrophic exfoliation of the gilded layer which occurs when the underlying corrosion advances beyond the point of structural integrity as can be seen in modern and historic examples in figure 97.

⁶⁴² In order to image B12 to clearly see the voids, the voltage in the microscope had to be increased from 14 kV to 20 kV because the thicker gilding restricted the electron beam depth.

⁶⁴³ Edgar González, Jordi Arbiol, and Víctor F. Puntes, "Carving at the Nanoscale: Sequential Galvanic Exchange and Kirkendall Growth at Room Temperature." *Science* 334, no. 6061 (2011): 1377.



Figure 97. Modern exfoliated plate (left). Southworth and Hawes image (right).
Courtesy of GEM.

The daguerreotypist decides when the toning operation is complete by observing the reaction. Of all the steps in the daguerreotype process, gilding is the one that is the least variable. Baron Gros devoted nearly a third of his treatise to galvanizing steps yet only a page and a half to gilding:

I have little to say about this operation, which is so well known by everyone. Cover the plate that is on the grill [levelled support] with as much gold chloride solution that its surface can hold...heat this plate with a strong ethanol lamp that heats it evenly throughout until the moment when the plate, which darkens at first, ends up whitening and achieving a tone of great vigour. Once it is good don't go trying to make it better or you will most certainly ruin it.⁶⁴⁴

One need only observe the destruction of a plate or two by staining or exfoliation to get a feel for the right time to quit the gilding process.

The improvement in brightness, tone and contrast that gold toning provides is explicit in the pre and post gilding images of DagTest 3-21-2014, page 329. Visual

⁶⁴⁴ Jean-Baptiste-Louis Gros, *Quelques Notes sur La Photographie: Sur Plaques Métalliques*. revised 2nd edition, July 1850 ed. Paris: Roret, 1850: 91.

qualities aside, it is equally important for conservators to fully understand the nature of gold toning. Most realize through misfortune that the daguerreotype surface is delicate and some historically important daguerreotypes, including Daguerre's still life from 1837, have been destroyed by well meaning but misguided conservation attempts because the image particles were not adhered by gold. Under certain conditions, a well-gilded daguerreotype can withstand careful swabbing with a very soft cloth without loss or scratching yet other gilded daguerreotypes will be ruined by such treatment. Furthermore, daguerreotypes with incipient exfoliation may be irreparably damaged with the slightest disturbance. It is difficult to know by visual inspection the condition of the gilded daguerreotype. Tools such as hand-held XRF machines, which are in vogue with the conservation community, will detect gold but this may provide a false sense of security for the conservator feeling it is safe to proceed with a conservation treatment. This work raises awareness that more research is needed to evaluate the integrity of the gilded layer on historic daguerreotypes.

7.7 Image Development, Fixing and Toning: Conclusion

The research for this chapter on latent image development, fixing and toning serves to clarify ambiguity surrounding the invention of the daguerreotype which is important for scholars of photo-history. This chapter also addresses the interaction between metals such as latent image silver, mercury, gold and the silver plate in a novel way with re-enactments designed to show the effects at different time intervals. This work is of interest to curators, collectors, conservators and material scientists because it provides a much clearer model for development and gilding than what is possible by nano-structure studies of historic or modern daguerreotypes examined in isolation.

Daguerre's progress of discovery has been presented here as a step-by-step process based on his experience with various chemicals to convert silver iodide camera images from negative to positive between 1831 and 1835. This fresh perspective has been achieved by examining the historical record for clues contained in the scant details directly attributable to Daguerre regarding the materials he used during this time. My interpretation of these sources has been informed by experience and re-enactments to fill in some gaps. For example, I have shown Daguerre's choice of carbonic acid may have been motivated by developments in organic chemistry based on its brightening action on copper oxide in Liebig's newly introduced kaliapparat apparatus, and my research with chlorine compounds and their hazing affect on silver plates provides an explanation for Daguerre's limited success with carbonic acid and potassium chloride.⁶⁴⁵ He continued with the mercury containing compounds, corrosive sublimate and calomel, and I argue that his intuition, or as Daguerre indicated "mon bon genie" in response to the gathering at M. Senard's, ultimately led him to mercury.⁶⁴⁶

⁶⁴⁵ See Appendix A, p 366. Twin Paradox: A Study of Preservation and Disfigurement of Southworth and Hawes Daguerreotypes.

⁶⁴⁶ Mayer, and Pierson, " Histoire de sa découverte." In *La photographie*. Paris: Librairie L. Hachette et Cie, 1862: 29-30.

Daguerre was speaking about a tacit understanding that allowed him to take the last step from calomel to mercury.

A simple mercury drop on a silver plate experiment to illustrate the amalgamation process reinforces the argument against accidental discovery in a magic cupboard. The magic cupboard scenario could not have occurred in the various ways it has been presented because to convert the decomposed silver of printed-out camera images to white required the extremely high concentration of vapour produced by boiling the liquid, a dangerous process that Daguerre revealed to Mead in 1848. Re-enactments presented here confirm that the balance of silver to mercury is critical for image particle amalgams to form in a structure that results in visible images.

Material evidence predating 1837 does not exist to show when Daguerre achieved his first fixed photograph, but through the replication of experimental procedures informed by his correspondence, I have verified that the previously disregarded announcement of this achievement in *Journal des Artistes* is probable. Daguerre had achieved a permanent photographic image produced by latent image development with mercury vapour sometime between August 4 and September 27, 1835. My claim is based on Daguerre's correspondence with Isidore Niépce during this time. The exposure times mentioned by Daguerre, which I have been able to interpret based on re-enactments for this chapter and the chapters on optics and iodine indicate precisely the transition from printed-out camera images to latent image exposures. The proof of permanence has been established by DagTest 11-27-2014 in that it is possible to fix an image by allowing the unexposed silver iodide on a mercury developed image to darken in daylight.

The key to this understanding, which led me to reproduce this effect, comes from Daguerre's comment "I had let the sun in my laboratory without any precaution to preserve them".⁶⁴⁷ My experience with printed out silver iodide on

⁶⁴⁷ Louis Jacques Mandé Daguerre, "Letter to Isidore Niépce - October 5, 1835." In Kravets. 1949: 436.

silver plates allowed me to understand the significance of this sentence; an important clue that has been overlooked by other historians.

The results possible in 1835 did not meet Daguerre's standard for quality and he continued to refine the process. Frustrated with etching to fill the shadows with carbon black, which also disturbed the delicate mercury amalgam image, led Daguerre to achieve better shadow values with polished silver. The success of this approach requires the removal of the silver-iodide coating and I have shown that Daguerre's use of salt water for the purpose is equally successful (provided silver clad copper plates are used) as sodium thiosulphate, with no discernible difference in image colour.

Daguerreotypes produced with different levels of mercury vapour applied to the same plate, and the SEM images obtained them, provide a clear indication of the limits of development. Over-exposed images will appear blue (solarized) with insufficient development and shadow values are veiled with mercury frosting given excess development. This research has shown that image particle frequency and size increases with development; over exposed highlights may have three million particles per square millimetre, and given the same camera exposure these same highlights developed four times longer may have six million particles per square millimetre. This, along with my analysis of image particles stripped from the surface with adhesive tape, proves that Barger and White's suggestion that mercury is "not a chemical reactant in the process" is incorrect.⁶⁴⁸

Experiments with the addition of ether during mercury development confirm Baron Gros' observation that the technique yields warm tones and bright whites. SEM micrographs that compare image particle morphology produced by development without and with ether clearly show that ether promotes spherical uniform particles with restrained shadow particle growth. This phenomenon allows for significantly reduced camera exposures recoverable by extended development

⁶⁴⁸ M. Susan Barger and William B. White, *The Daguerreotype: Nineteenth-Century Technology and Modern Science*. 2nd ed. Baltimore: John Hopkins University Press, 2000: 156.

providing a significant gain in relative speed. This explains the short exposures with small apertures the Baron Gros reported and may account for the Macaire brothers' ability to record ships under sail leaving Le Havre in a fraction of a second.

The SEM images obtained from experiments with ether also reveal how image particle morphology influences prismatic effect. Prismatic effect, where the apparent colours change with viewing angle of the daguerreotype occurs when the mid-tone image particles are irregularly shaped, but the effect is lost with uniform particles induced by ether. The important observation here is that if desired irregular image particle morphology is controllable by development conditions, not the attributable to the work of inexperienced practitioners as suggested by Barger and White.⁶⁴⁹ Development conditions affect speed and tone because these variables influence the formation of the image amalgam particle in terms of size, frequency and shape and these particles directly affect the look of a daguerreotype because the image is made visible by incident light that has been scattered by the particles.

Gold toning, introduced to the process in 1840, increases the size of image particles to scatter more light, which warms and brightens the image as clearly seen in pre and post gilded experiments. The shadow values are improved by increased reflectivity of the plate caused by the gold and silver mixture that coats the surface. This layer also accounts for the bonding of image particles to the surface as the gold combines with silver to encapsulate the image particle. Daguerreotype processing results in the formation of voids in the sub-surface of the plate. It has recently been suggested by Ravines et al that the formation of these voids is caused by mercury vapour that, during development, first serves to amalgamate with the latent image, and then somehow transitions into a mass transport system to evoke silver from beneath the silver plate and from beyond the latent image site. I have shown how the scanning electron microscope can be

⁶⁴⁹ Barger and White, *The Daguerreotype*. 2000: 158.

used to image these void features from above the surface with sufficient penetration of the electron beam, and that area scans of un-gilded and gilded plates prove that the voids are due to gilding, not mercury. SEM images and XRF analysis of daguerreotypes produced in a geometric time-lapse sequence clearly reveal that gilding is a galvanic corrosion process that accounts for sub-surface features in the silver plate.

This information has significant implications for daguerreotype conservation. It is well-known that gilded daguerreotypes, due to their robust nature can withstand certain aqueous and physical treatment to remove surface debris and corrosion, while some un-gilded daguerreotypes have been irreparably damaged by such treatment. What this work shows is that the gilding process, though relatively straightforward, is a product of human agency because the duration of gilding is a matter of judgment based on observation. Not all daguerreotypes are gilded equally which means even if analysis indicates the presence of gold, some daguerreotypes may still be damaged if under-gilded because their image particles may not be firmly adhered to the plate, while over-gilded ones may be at risk of exfoliation due to excessive sub-surface voids.

The observation from my research, that the percentage of gold present at the surface increases with gilding time, may with further experiments and analyses, provide a guide for conservators to evaluate the integrity of the gilding layer on historic daguerreotypes and provide a more informed means to judge if a proposed treatment is safe.

8.1 Conclusions: Research Questions and Methodology

This study is the first to explain the daguerreotype process in detail with empirical evidence for how and why the medium evolved. The answers to why daguerreotypes look the way they do are contained within these chapters however the causes for observed effects are comprised of a complex set of variables. In 1854, J. J. Bardwell in *Cause and Effect* observed that daguerreotypes from different galleries looked different, and he appealed to practitioners to reveal their techniques and materials to know the cause.⁶⁵⁰ *Cause and Effect* serves as motivation for my research questions because the search for better techniques and materials was driving force behind its evolution. I am interested in how the changes in materials and techniques influenced the aesthetics of the daguerreotype. Processing variables differed, not only between the practitioners Bardwell queried, but were in constant flux from the start in 1839 with alterations designed to improve speed, tone and spectral sensitivity. This thesis delves deeply into the minutiae of the daguerreotype process to explain why daguerreotypes appear different along the timeline of process innovation, and in doing so, has uncovered new information that questions and revises the established canon of the daguerreotype.

Chapter one frames the challenges for historical studies of the daguerreotype. First, the historic record presents conflicting formation because improvements in materials and methods necessary for portraiture evolved through human agency for each step of the process. Second, textual sources contain incomplete information because details have been omitted from the written record as a matter of course, tacitly understood by the daguerreian community. Third, textual records often require artisanal or gestural knowledge to be fully comprehended. Replicating nineteenth century daguerreotypes is an effective method to recover tacit knowledge of the process, indicate unwritten human agency concerning an

⁶⁵⁰ J. J. Bardwell, "Cause and Effect." *The Photographic and Fine Art Journal* 7 (1854): 270-1.

historical actor's methods, and shed light on the meaning or clarify conflicting information in textual sources.

During the incunabula period, before journals dedicated to the daguerreotype were established, the greatest teacher was the process itself with knowledge of improvements gained tacitly through experience and observation. On the other hand at its zenith in the early 1850s, when the daguerreotype was well established, dedicated journals and guides condensed the art into a nutshell, leading historians such as Beaumont Newhall to claim that by consulting standard treatises one could "reconstruct in detail every step of the process".⁶⁵¹ Historians, curators and material scientists, engaging with the latter historic literature, have perceived a standardization of practice, and lacking tacit and gestural knowledge of the art, have not recognized that the daguerreotype is a highly malleable process dependent on upon the nuances of human agency. A hands-on approach adopted here, supported by sixteen years practical experience as a contemporary daguerreotype practitioner, has allowed me to conduct replicative experiments fully aware of the malleability of the process and effectively isolate the variables in question.

Chapter one re-establishes an awareness of human agency in the daguerreotype process and illustrates where traditional library research has lead to speculation about historic images. In regards to materiality, scientists adopting an analytical approach to explain nineteenth century daguerreotypes have limited practical experience with the techniques and materials of the past, and in many instances attributed their research findings to questionable causes. My approach involves re-examining the literature with a perspective informed by practice, which allows for a more thorough understanding of the history of daguerreian materials and techniques. This research is then combined with the scientific method in evaluating the materials and methods of the past by synthesizing new

⁶⁵¹ Beaumont Newhall, *The Daguerreotype in America*. 3rd revised ed. New York: Dover Publications [etc.]; London: Constable, 1976: 115. See also Simons, Montgomery. P. *Photography in a Nut Shell*. 1858.

daguerreotypes. The results of these experiments have closed gaps in the literature and have explicitly shown how process variables affect the visual qualities of a daguerreotype.

Chapter two explains and justifies my research methodology. Laboratory re-enactments have long served to reveal the methods of historical actors and clarify meaning in historical texts in the history of science and examples are given, but this methodology is new to the study of photographic history. Marignier effectively used synthesis to determine the photosensitivity and appearance of Niépce's bitumen process on iodized silver plates in the absence of historic examples. This is the first study to use synthesis with the daguerreotype process to re-discover and reveal new knowledge about the first photographic process to yield many thousands of unique cultural heritage objects. I provide a clear picture of how materials and methods affect the daguerreotype in terms of speed, tone and spectral sensitivity by isolating process variables as they evolved, testing methods in the laboratory, and presenting the results. Another outcome of this investigation is that the written record has been closely re-examined with the support of tacit knowledge and empirical evidence. This method has served to clarify meaning, fill gaps in understanding, uncover errors in interpretation, and in a few instances, show where the historical record has been altered intentionally or otherwise to support the historian's preferred actor.

Chapter two next explains how the re-enactments performed for this dissertation conform sufficiently to past historical material conditions to avoid the critique of anachronism levied against the Hockney-Falco thesis.⁶⁵² Equally important, the section on experimental design makes it clear that I have the requisite tacit knowledge as practicing daguerreotypist to understand and isolate the processing variables to perform effective and informative replications. This multi-disciplinary approach to daguerreian history is presented step-by-step in

⁶⁵² David Hockney, in *Secret Knowledge*, claimed to uncover the working methods of renaissance artists, but the work has been criticized for relying on modern optics and unpublished methods, essentially non-conforming to the material conditions of the past.

chapters linked with the daguerreotype process beginning with the silver plate, iodine sensitizing, halogen acceleration, and optics concluding with mercury development and gilding.

Each chapter begins with the technological history of the components of the original daguerreotype system. Advancements, aimed at improving speed, tone and spectral sensitivity are then presented, aided by replication to explicitly show when, why and how these techniques and materials influenced the look of a daguerreotype. This chapter structure provides new perspectives on the historical actors involved, makes explicit the technological limitations and look of the daguerreotype at different points along its history, and offers a clear indication of the cause and effect of processing variables. Chapter summaries and significant findings related to each step of the process are now presented in order.

8.2 Chapter Summaries and Findings

Chapter 3: The Silver Plate

Summary

Silver plates serve not only as the support for the daguerreotype image but are inextricably linked to photographic sensitivity. Daguerreotype plates were made by the cold-rolled cladding process and methods differed between England, America and France in the finishing steps of plate manufacture. This chapter explicitly demonstrates ways to observe the plate surface to ascertain its surface condition and origin.

Plate in hand, the daguerreotypist tacitly learned the skills to impart a well polished surface necessary to achieve uniform image quality, good contrast and deep shadow values. This chapter reviews the evolution of handiwork and mechanical aids towards this goal. The final technique addressed in this chapter is galvanizing; a process by which the daguerreian uses electro-chemistry to add a soft, large-grained deposit of silver to the polished plate. Galvanizing is explained as materially different than electro-plating and its value in the process is clearly indicated.

Findings

Daguerre's choice to work with silver coated copper was the culmination of progressive techniques in search for the fastest working light-sensitive materials.⁶⁵³ The material qualities of the silver plate have heretofore not been thoroughly addressed. This study has shown that softer silver offers a beneficial gain in photosensitivity and improved image tone. Significantly, this work resolves questions concerning of the role of copper. Re-enactments prove that copper alloyed with silver negatively affects images with veiled shadows. This explains

⁶⁵³ I have found that the Gernsheim's have confused history by *altering the text* of Daguerre's broadside to imply that iodized silver plates offered a 70:1 improvement in photosensitivity to Niépce's heliograph rather than the more refined physautotype.

Talbot's observation that London plated metal (likely sterling silver) did not perform as well as French-made plates. It also explains why Barger incorrectly found silver copper alloy with EDX analysis on plates made by Robert Cornelius before 1842. Finally, experiments designed to compare pure silver clad copper, sterling clad copper and solid silver provide a clear reason why Daguerre claimed clad metal performed better than solid silver plate. First and foremost, the complete removal of silver iodide occurs when a clad plate is immersed in salt water due to an electrolytic reaction. Prior to this dissertation, the mechanism for Daguerre's ability to fix plates in 1837 had not been understood. Furthermore replication proves that pewter grey-blue tonalities cannot be attributed to salt fixing, as the results are no different than thiosulphate fixing in terms of image colour.

Transitioning from findings concerning the purity of silver to those related to plate polishing, Cornelius' renowned image quality was not aided by the mechanical strength of alloyed silver as Barger suggested, but due to his superior metal-finishing skills. Clues to identifying Cornelius' handiwork in burnishing silver can be seen in half-shadow illumination. This lighting arrangement, as has been shown in this chapter, is also useful to observe rolling mill artefacts such as pores, pits and indentations from debris on non-planished surfaces of early American-made and English-made plates. This provides a non-invasive means for curators, collectors, caretakers and historians to estimate when and where a daguerreotype was made based on the surface condition. The planishing hammer was a tool used exclusively in France to smooth out the above-mentioned rolling mill artefacts. Planished plates polish more readily than rolled plates due to their smoothness, which is another reason for Daguerre's preference for clad material. French-made plates can be identified by observing the hardness differential patterns in light reflected from the plate much like the way one observes the image reflected from a Chinese magic mirror. (An interesting example of this is shown in figure 98.) Planishing hammer marks, normally invisible, can also be seen half-shadow illumination while the plate is submerged in water.

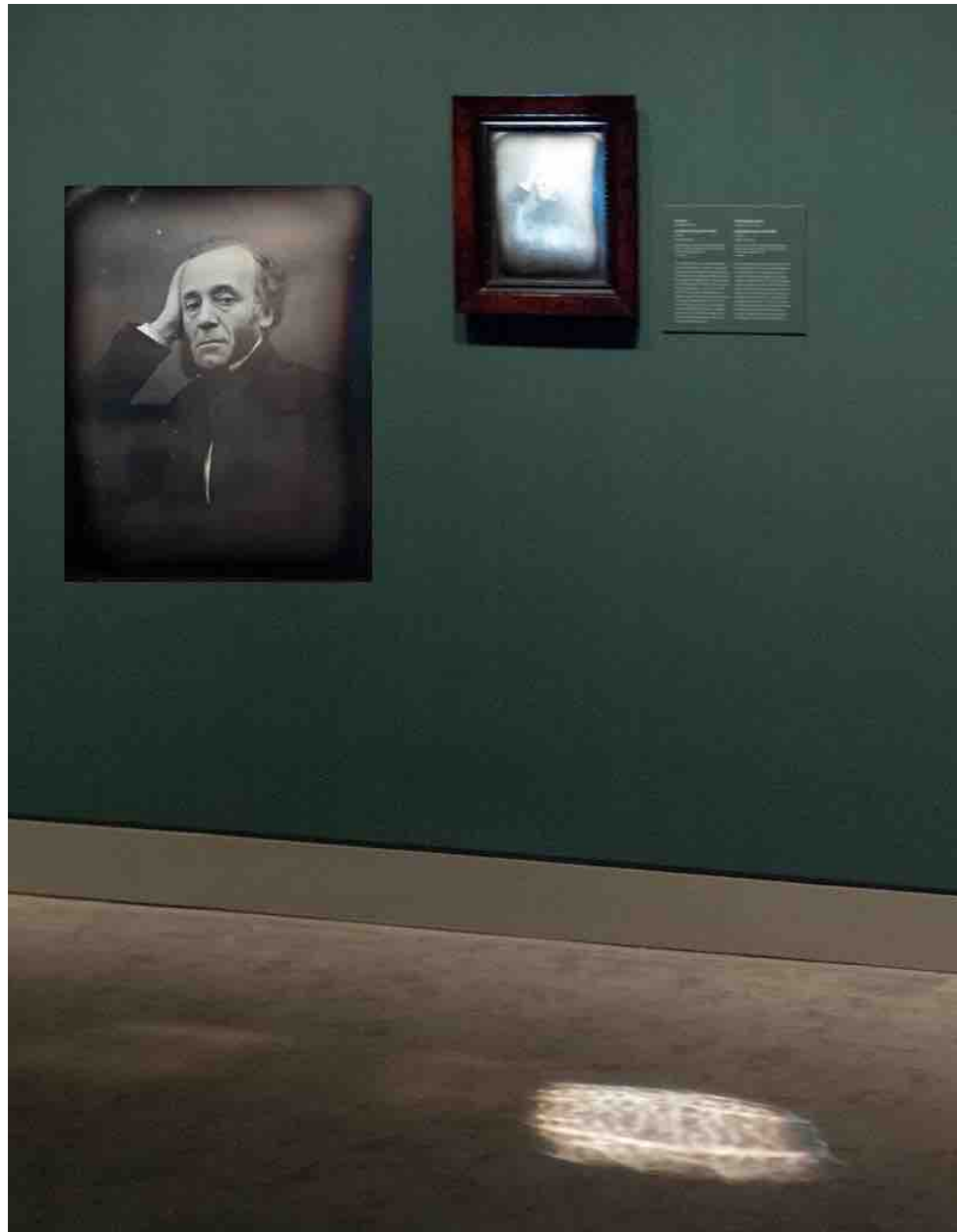

Figure 98. Oversized daguerreotype of John Barritt Melson by J. E. Mayall. (Additional image inset for clarity) *19th Century British Photographs* exhibit, National Gallery of Canada, 2012. Planishing hammer marks are plainly visible in reflections on the gallery floor. Author photograph.

The quality of the polish on the plate directly influences contrast and shadow values. Artefacts of polishing, including nitric acid defects, the benefit of reciprocating versus circular hand work, adhesives and holding devices are made explicit through replication, and are presented chronologically to assist historians in

attributing dates to historic daguerreotypes. Galvanizing, a process used by some daguerreians, further improved plate preparations by providing a uniform and pure silver microstructure that greatly contributed to repeatable results. Galvanizing has been found to be significantly softer and more large-grained than electroplating due to lower electric current density, providing greater photosensitivity and brighter highlights when applied over harder silver. Re-enactments have explicitly shown the effects on daguerreotype image quality due to human agency concerning the techniques of polishing, and the material conditions of the silver plate due to purity and hardness.

Chapter 4: Sensitizing with Iodine

Summary

Silver iodide is formed on a silver plate by exposing it to iodine vapour, which imparts photosensitivity. Historical anecdotes suggest that Daguerre discovered the light-sensitivity of silver iodide by accident and this chapter presents reasons to question that claim. More importantly, Daguerre recognized the extreme advantage in speed that iodized silver plates had over other methods that he and Niépce experimented with. Daguerre noted that iodized plates were seventy times more light sensitive than the physautotype, yet sensitivity varied according to the quantity of silver iodide formed on the plate. Re-enactments explicitly indicate how different silver iodide coatings affect image quality.

The apparatus for iodine vapour, namely the iodine sensitizing box, can influence the uniformity of the silver iodide coating and this chapter reviews the various styles used, from the earliest by Daguerre to the specially designed boxes suited for travel by Baron Gros. Visual effects on daguerreotype images due to sensitizing uniformity or lack thereof related to the iodine box design are explained.

Findings

Re-enactment of the spoon-left-on-a-plate anecdote shows that the iodized plate is visibly darkened by diffuse light in five minutes, which confirms the findings Daguerre reported to Niépce on May 21, 1839. Experiments to replicate Joseph Saxton's trials at the U. S. Mint with a cigar box type camera and simple bi-convex lens yielded a visible negative image on iodized silver in twenty minutes in dull winter light. The negative camera image produced in so brief a time provides a clear understanding of why Daguerre favoured silver iodide over other materials and sought a means to transpose the dark and light values of the plate.

Daguerre explained that yellow iodine coatings are the most sensitive and blue coatings are insensitive. This has been confirmed and dramatically illustrated by a re-enactment of the Talbot/Waller iodine rings experiment. The rate of sensitization is determined by the observed colour of the silver iodide coating reflected from the plate's surface. For the first time, a spectrophotometer has been successfully used to quantify and obtain colorimetric data of the silver iodide coatings. The spectral curves generated from these readings link the sensitizing colours to light absorption, reflectance and scattering, which conform to observed effects on daguerreian images prepared with different levels of iodine vapour.

This chapter presents a new model for the structure of silver iodide on a daguerreotype plate. Previously thought to be a coating defined by thickness, SEM imagery presented here shows that silver iodide is formed in discrete particles that increase in frequency and size with iodine vapour exposure. An important finding, never before shown, is that overall fogging occurs on plates that have insufficient light yellow iodine coatings with mercury developed plates. The cause of fogging is explained by this new model of silver iodide formation as sites of unreacted silver between the silver iodide particles are in the right balance with mercury vapour to form visible amalgam particles that present as fog. (Plain polished plates exposed to the same level of mercury do not fog.)

The ideal sensitizing colour for speed and tone, either with the Talbot rings print-out reaction, Becquerel development or Mercury development is magenta. After his manual was published, Daguerre changed his recommended iodizing colour from golden yellow to rose-violâtre which in modern colour language is magenta. (The word magenta did not exist when Daguerre described this colour) This study found that first and second cycle magenta coatings are equivalent in photo-sensitivity, which confirms John Draper's finding in 1840, but contradicts Pobboravsky's work in 1971, the reason being Pobboravsky did not use mercury development. Second cycle magenta coatings however excessively corrode the plate diminishing shadow values.

This study is the first to illustrate that image quality can be affected by the sensitizing box. The perimeter of plates may be under-coated causing the localized fog mentioned above, or over-coated which results in a color shift from cool to warm. Furthermore, turbulence generated when inserting the plate will agitate the iodine vapour and yield mottled tones on uniform subject areas.

Chapter 5: Sensitizing Accelerators

Summary

Chemical experiments to quicken camera exposures began within the first year of the daguerreotype process and beyond. This chapter follows the evolution and use of chlorine and bromine accelerators beginning within the interconnected community at Holborn Bars, London. Antoine Claudet is credited with introducing chlorine and his competitor John Goddard, employed by patentee Richard Beard, has been given priority for the discovery and use of bromine for plate acceleration. Close scrutiny of the historical record, supported by replicative experiments, provides clear evidence to revise this facet of daguerreotype history. The relative sensitivities of chlorine and bromine are revealed through experiments giving bromine the clear advantage in speed but more difficult to use successfully.

Daguerreians tried several means to avoid solarization and veiling and achieve consistency and reliability when using highly volatile bromine vapour before 1846. Once Laborde's second iodizing step to manage bromine became commonplace, further advancement with dry sensitives continued to 1850. Baron Gros' evolving iterations of sensitives co-mixed with chlorine and bromine are reviewed, culminating with a replication of his 9-variant chloro-bromine with lime test. This experiment clearly illustrates why chlorine combined with bromine was preferred for maximum sensitivity and beautifully warm image tones.

Findings

Secrecy, to protect the interests of daguerreotype patentees, has affected the history of chemical acceleration resulting in an altered perception of the timeline of bromine use. Goddard never disclosed details of his accelerating formula (except to patentees) as indicated in his letters to the Royal Society in 1864. This, combined with Hughes' articles in support of Goddard's priority in which he substituted the word bromine for chlorine, have led historians to believe that bromine was in use by the end of 1840. Goddard's A & B formula, re-discovered at the Royal Society and explained in the chapter, prove that bromine was not used or recommended to Richard Beard's studio franchisees in 1841 and 1842 because chlorine compounds were more reliable.

Re-enactments to understand the effects of halogen acceleration show chloride of iodine to be five times more sensitive than iodine on its own, and bromine acceleration twelve times faster than chloride of iodine (and a factor of sixty over iodine alone). Furthermore, the use of bromine before 1844 was much more difficult to manage, frequently yielding bluish, veiled or solarized images while chloride of iodine produced warm-toned images generally free from over-exposure. The issue for historians interpreting daguerreotypes unaware of the photosensitive, tonal or other visual effects due to chlorine and early bromine use is that daguerreotypes with muted, veiled and bluish tonalities may be mistakenly thought

made in 1839 or 1840 when they actually were produced at a much later date.⁶⁵⁴
This work benefits historians in this regard.

This dissertation re-calibrates the timeline for the efficient use of bromine which then provides a clearer understanding why Daguerre announced a complicated process to control “le voile de brome” in April 1844.⁶⁵⁵ This thesis is the first to reveal and prove by replication how Daguerre in France, and Cornelius in Philadelphia, may have used gold in advance of sensitizing to mitigate bromine’s tendency to veil. The circular spot on Daguerre’s *View of Bry sur Marne*, thought to be a botched conservation attempt, may actually be an experiment designed to show the effectiveness of his method. In the future, elemental analysis would confirm my hypothesis if gold or platinum metal were to be found within the bright circle on this plate. Beyond this dissertation, I will be exploring Cornelius’ pre-sensitizing gilding method with a research group at the Library of Congress. This investigation is important because gold applied prior to sensitizing if detected by XRF analysis may lead a conservator to conclude the image stable, but pre-gilding without after-gilding does not enhance the stability of the image particles.

During the mature period chlorine was frequently mixed with bromine in dry slaked lime. An ideal balance exists between iodine, the accelerating halogens and the second iodizing step for maximum photosensitivity. In replicating Gros’ 9-variant test, I have recorded the sensitizing colours on the plate digitally, and with a spectrophotometer, to show a direct relationship between the coating colours and the final image in terms of speed, tone and contrast. When the colour of the final coating ($I_1/BrCl/I_2$) changes from magenta to blue, the image hue also shifts from cool to warm. This is the first empirical proof to show how sensitizing colours influence image speed, tone and spectral sensitivity simultaneously. As found in

⁶⁵⁴ Clear examples of this are the tones in Hogg’s views of Greenwich Hospital and the Folkestone Viaduct taken in 1843 (see Fig. 48, p 190).

⁶⁵⁵ Louis Jacques Mandé Daguerre, “Photographie. — Sur un nouveau moyen de préparer la couche sensible des plaques destinées à recevoir les images photographiques”. *Compte rendus hebdomadaires des séances de l’Académie des sciences* 17 (April 22, 1844): 757. “Le voile de brôme” translated means bromine veil or fog.

the previous chapter on iodine sensitizing, a plate sensitized to a final colour of magenta, *provided the dose of chloro-bromide is sufficient*, will give the greatest sensitivity. This finding provides further evidence that sensitizing colours conform in part to the Grotthuss-Draper Law of photochemistry.⁶⁵⁶ According to this law, and in my experience, sensitizing colour can be used to control contrast, and this is particularly effective for landscape views. Gros preferred to extend his sensitizing into the blue colour for landscapes. Blue coatings absorb *less* blue light than a yellow or magenta coating, and require twice the exposure time, but this is immaterial for landscape views. This technique effectively prevents blue skies from solarizing and the extended exposure allows for the less actinic green and brown scenic colours to be rendered better in the daguerreotype image.

Chapter 6: Optics and Exposure

Summary

The lens mounted to the Giroux-built camera signed and sealed by Daguerre was the culmination of years of iterative design. This chapter traces the development of Daguerre's lens according to his quest for excellent corner-to-corner sharpness with enough brightness for shadow arresting exposures of fifteen minutes or less. Due to its slowness Daguerre's lens was impractical for portraiture. This chapter details the first attempts at improving of optics towards that goal, and then transitions to the renowned portrait lens designed by Josef M. Petzval.

English, French and American competitors copied Petzval's lens built by optician Voigtländer and Sohn in Vienna. Modern daguerreotypes made with Voigtländer's lens and C. C. Harrison's American-made lens reveal surprising differences between the optical signatures of the two most popular portrait lenses of the daguerreian era. Each lens design imparts a unique look to an image and

⁶⁵⁶ This Gotthuss-Draper law states that only light which is absorbed by a system can bring about a photochemical change.

experiments presented in this chapter inform a nuanced reading of the optical conditions germane to historic daguerreotypes.

Findings

Daguerre's correspondence between 1828 and 1833 reveals the extent of his optical knowledge and has served to guide replicative experiments, thus providing new knowledge for photo-history. Daguerre's lens according to his 1833 sketch was a six-inch achromat with an effective aperture of $f/6$. Significantly, new daguerreotypes produced with such a lens prove that exposures as brief as 75 seconds were possible in 1835, well within the realm of portraiture. The lens, with its convex surface towards the subject and rear-facing aperture suffers in perimeter sharpness due to spherical distortion. When reversed the field becomes flatter, however the illumination is reduced by one-half, which confirms Daguerre's information accompanying the sketch. Daguerre further developed his lens, transposed relative to a telescope, because of his desire for perfect sharpness across the entire image.

I argue that the full-plate dimension introduced in 1839 is directly related to the optics industry. Guinand, the French glassmaker, discovered a means to produce large flint glass discs necessary for achromatic lenses. The lens diameter that Daguerre selected from the list of available diameters was 36 ligne (81 mm), twice as large as flint discs produced in England. Furthermore, the field of coverage this lens projected when fitted with an aperture small enough to maintain corner to corner sharpness, yet large enough to keep exposure times within his pre-determined maximum, was the determining factor for the full-plate size (217 mm x 162 mm).

Optics used in the first portrait studios were the reflecting mirror camera invented by Wolcott and Johnson and a variety of large non-achromatic lenses arranged to shorten the focus, thus reducing exposures. Re-enactments with both optical systems clearly demonstrate that pre-Petzval optics were incapable of taking groups, limiting the likeness to head and shoulders portraits on small plates

commonly one-ninth the size (63 mm x 51 mm) of a full-plate. The information concerning early optics lends greater significance and a better appreciation for a daguerreotype touted as, "The first full-length child portrait" taken in June 1842. This quarter-plate daguerreotype of a young Samuel Troth, which I discovered in the collection of the Pennsylvania Historical Society, was made in Philadelphia at the Langenheim's studio using the new Petzval portrait lens produced in Vienna by their brother-in-law, Peter Voigtländer. American agents for the new lens, the Langenheim's price for the complete Voigtländer outfit was 275 dollars, two hundred dollars more than the original Daguerre camera system.⁶⁵⁷ Unprotected by patent outside of Vienna, the lens was soon copied by opticians in France, England and America.

The most renowned portrait lenses in the daguerreian era were Voigtländer's German-made and Charles C. Harrison's American-made lenses. Literature from the period describes differences in chemical focus and the look that each lens imparts to a daguerreotype portrait. New daguerreotypes made with each lens dramatically illustrate that Harrison's lens yielded more warm-toned images than Voigtländer's, but the latter has better sharpness and contrast. This chapter explains the reason for this also. Petzval designed the Voigtländer optic to be achromatized to the actinic region of the spectrum. He calculated (to the third decimal place) the curvatures necessary for the crown and flint combinations to bring the F (blue) and D (yellow) Fraunhofer lines to the same focus point. Harrison, who was trained by Fitz, achromatized his lens visually as a telescope maker would. This method incorporated the non-actinic (red) region of the spectrum essentially over-correcting it for daguerreotype use, which resulted in softer images.

Replicative test with Daguerre's 1833 lens, combined with an understanding of the construction of the Voigtländer Petzval lens gave me insight to interpret the

⁶⁵⁷ As previously noted in section on Petzval's lens, Chas G. Page purchased a Voigtländer outfit for \$275.00 (see footnote 525, p 273-4). This was more than three times the cost Bemis paid to François Gouraud for an original Giroux outfit in 1840.

look of two landscape views from the collection of John Ruskin. The first, a quarter-plate view of St. Marks in Venice has a distinctive circular vignette. I have shown experimentally that this was most likely due to a gerry-rigged lens cap with a five-eighths inch hole in it to serve as a reducing aperture. The other half-plate view of Thun is actually two separate images of the same view with different foci. The reason for this being the rear cell of the lens was removed to achieve a telephoto perspective and in doing so, the image suffered from spherical aberration, precisely the same as my replications for Daguerre's 1833 optics. To capture the entire scene to be reproduced later, Ruskin simply made two exposures with differing focus. This is the first research to show by empirical evidence that the full-plate dimension, and the much smaller size for the first portraits was due to optics. Furthermore, re-enactments with vintage lenses clearly explain the effects that optics have on image speed, tone, spectral sensitivity, resolution and contrast.

Chapter 7: Image Development, Fixing and Toning

Summary

The literature detailing Daguerre's discovery is sparse which has led to wonder and speculation about how he conceived of bringing silver and mercury together. This chapter retraces Daguerre's four-year progress towards the discovery of mercury vapour development beginning with attempts to chemically convert the tones of silver-iodide images from black to white. Replicative experiments enhance the interpretation of historical texts and provide plausible evidence for a permanent camera image in 1835. Mercury vapour significantly contributes to the appearance of daguerreotype images. Experiments designed to illustrate varying development conditions, explicitly show the relative effects in speed, image colour and contrast due to mercury.

Gold toning, introduced by Fizeau in 1840, was quickly integrated as the final step in daguerreotype processing due to the remarkable improvement in contrast,

tone and stability it provided. This chapter illustrates the effect gilding has on the look of a daguerreotype with 'before and after' images of modern daguerreotypes. The research on gilding incorporates scanning electron imagery and x-ray microanalysis to explain the mechanism of the reaction between gold and silver.

Findings

My interpretation of the historical record concerning Daguerre's discovery of the latent image has been tacitly informed through practical experience and replicative experiments. Daguerre tried four vapour substances prior to mercury to reverse the tones of printed-out silver iodide images. I have drawn a plausible explanation for his choice of the first substance, carbonic acid, based on Liebig's kaliapparat, which was introduced the same year Daguerre began working with iodized plates. I understand the efficacy of carbonic acid and the second substance, potassium chloride, because both in their application contain chlorine, which will form silver chloride which can lead to whitening on daguerreotypes (see Appendix A, p 375).

Daguerre approached the problem of tone reversal step-by-step through inductive reasoning, next with mercuric chloride then calomel vapours. Both compounds contain mercury (the latter twice as much) and one last step of induction led him to mercury. Daguerre's reasoning is clearly stated as "mon bon génie" (literally my good genius) during the gathering at the salon of M. Senard. The Gernsheim's translation of this account alters the historical record. Mon bon génie is translated as "my good fortune" which leans in meaning towards the anecdotes of accidental discovery, and Daguerre's fourteen years of research is reduced to eleven years. It seems an unlikely mistake to translate "quatorze ans" as "eleven years", but rather deliberate to situate Daguerre's first researches *after* the date of Niépce's earliest extant camera image in 1827.

The "magic cupboard" scenario of accidental discovery as presented in different accounts doesn't materially work due to the incorrect proportions of latent image silver and mercury vapour. The argument against these anecdotes is reinforced by the mercury drop on as silver plate experiment to illustrate that the amalgamation

process for image formation, which amplifies the particle size fifty-fold, is critically dependent upon the correct balance of the reactant metals. Furthermore, my experiments show that significantly more mercury vapour (than provided from a broken thermometer in a cupboard) is necessary to convert dark print-out silver to white silver mercury amalgam. The mercury reversal experiment provides clarity as to why Daguerre at first tried *boiling* mercury.

Image particles formed on the daguerreotype vary in size, frequency and shape, which determine image colour, contrast and prismatic effect. I have shown through experiments and SEM analysis that image formation is entirely an amalgamation process greatly influenced by thermodynamics within the enclosed mercury apparatus. (This refutes prior explanations by Barger in 1991 and Ravines in 2016.) The quantity of mercury available to amalgamate with the disparate latent image sites is established by time, temperature and volume of the apparatus. This controls image particle size, shape and frequency, and ultimately, the look of the daguerreotype. I have found that image particle frequency and size increases with development. Over-exposed highlights that appear strongly blue (solarized) have three million particles per square millimetre. Given the same camera exposure these same highlight regions developed four times longer have six million particles per square millimetre and appear bright white. This provides direct evidence that extending mercury development judiciously allows for reduced camera exposures.

Prismatic effect, a visual quality much admired in the work of Southworth and Hawes and others, by which the hue of the plate alternates between cyan and magenta with viewing angle, occurs under development conditions that promote irregularly shaped mid-tone image particles. Particle morphology is a function of the amalgam ratio or mercury-silver solid solution phase. This study lays the foundation for future work towards a more precise determination of the phases of silver and mercury due to development conditions. Finally, in terms of particle morphology, the remarkable effects due to ethereal mercury vapour development

are shown. Ether promotes uniform particle formation and restrains the growth of shadow particle agglomerates with extended development. This little used method partly accounts for Baron Gros' remarkably warm-toned images, and may explain how the Macaire brothers were able to instantaneously record ships under sail.

One of the most significant findings of this study is evidence that Daguerre may have achieved a permanent photographic image produced by latent image development with mercury vapour sometime between August 4 and September 27, 1835. Experience allowed me to understand the significance of Daguerre's comment to Isadore Niépce; that he allowed sunlight into his laboratory to react with the mercury developed, yet unfixed, image. An experiment to prove this indicates that it is possible to produce a permanent image on an unpolished silver plate by simply allowing the silver iodide in the shadows to print-out as black. The result of this experiment is a clear and quite stable positive image, proving that the brief announcement in *Journal des Artiste* on 27 September 1835, which described Daguerre's accomplishment, was likely accurate. Previous histories have been dismissive or unable to explain this.

In the interest of further improvement during the interval between 1835 and 1837, Daguerre tried to etch his plates to fill the shadows with black pigment. With little success, he then discovered salt-water fixation to remove the silver iodide. This method necessitated polished plates for good shadow contrast, which explains why Daguerre approached August Brassart at Gandois' establishment for smoother planished silver in 1838 and not earlier.

At the close of this chapter, the effects due to gold toning become explicit with newly made daguerreotypes. Highlights in pre-gilded condition that appear blue (solarized) can be recovered somewhat with gilding to appear bright white, and the overall tone of the daguerreotype shifts from cool to warm. Vicenzi has produced FIB-SEM and microanalysis to show that gold combines with the image silver to enlarge the particles, which accounts for the colour shift. Gilding has long been understood to impart stability to the image surface, the reason being that the gold

coating bonds image particles to the gilding layer as it forms on the silver substrate. I have extended this work to further understand the mechanism of gold toning. SEM images and XRF analysis of daguerreotypes gilded in time-sequence clearly reveal a galvanic corrosion process that accounts for sub-surface features in the silver plate. The voids are not due to mercury development as Ravines claims.

Over-gilding and excessive heating can lead to catastrophic exfoliation, and under-gilding may mean that image particles are not as firmly bonded to the substrate as one might imagine. Further research on gilding may provide a means to quantify the integrity of the gilding layer on historic daguerreotypes. This would provide vital information for conservators when deciding on a treatment approach, and a step towards a more informed way to preserve and care for our cultural heritage daguerreotypes.

8.3 Conclusions: Summary

Daguerreotypes look the way they do according to a complex set of variables. Unlike Cattani, Dunbar and Shapira in *Value Creation and Knowledge Loss: The Case of Cremonese Stringed Instruments* who recognized that too many potentially influential variables were in play to know the critical causal relationships that produced the violin's tone on the whole,⁶⁵⁸ I have separated the daguerreian system into its component parts providing causal evidence for image speed, tone and spectral sensitivity for each step of the process in turn, and chronologically.

The appearance of a daguerreotype is determined by a variety of process variables alone or in combination. Plate purity, microstructure and polish, sensitizing halogens by their choice, application or proportions, optical design, mercury development conditions of time, temperature, thermodynamics and ether use, and finally gilding duration each and combined influence image particle formation which affects the visual outcome. The historian, curator, collector, custodian and conservator of daguerreotypes can search these pages for detailed information about the daguerreotype process and the daguerreotype image. With the information provided by this research, one can more precisely evaluate daguerreotypes for their appearance, history, date, origin, condition, and perhaps develop a keen awareness of the human agency involved in the making of daguerreotypes and the achievements of its practitioners.

Hands-off historians who lack tacit, craft and gestural knowledge of the process in question have written the history of photography for the most part. Leor Halevi noted that hands-off historians, after extracting all they can from historical sources, might resort to speculation. This is certainly true with the history of the daguerreotype. Examples of speculation by highly regarded photo-historians have been refuted by my research, such as Stephen Pinson's claim that salt-water fixing

⁶⁵⁸ Gino Cattani, Roger L. M. Dunbar, and Zur Shapira, "Value Creation and Knowledge Loss: The Case of Cremonese Stringed Instruments." *Organization Science* 24, no. 3 (2013): 11. <http://pubsonline.informs.org/doi/abs/10.1287/orsc.1120.0768> (Date accessed, 30 Nov. 2016)

accounts for the pewter blue-grey tones on early daguerreotypes, Michel Frizot's questioning of Daguerre's scientific ability, and the Gernsheim's outright dismissal of Daguerre's 1835 discovery of a permanent image reported in *Journal des Artiste*. My research has significantly correcting the historical record here and in other ways. Moreover, in reviewing the historical record with knowledge informed by practical experience, I have understood, and presented the meaning and significance of important texts that have been overlooked in the past.

This dissertation demonstrates a new approach for photographic history studies. The significant findings here prove that recreating technologies of the past to generate empirical evidence is an effective methodology for photo-history. The caveat being the researcher has, or can learn while doing, the necessary tacit and procedural knowledge of the art to conduct experiments that convincingly conform to past practice. The results of my study have led to important research related to the exhibition and preservation of daguerreotypes. This work in colleague with Dr. Edward P. Vicenzi, titled *A Twin Paradox: A Study of Preservation and Disfigurement on Southworth and Hawes Daguerreotypes* was presented in 2015 at the bi-annual winter meeting of the Photographic Materials Group (PMG) of the American Institute for the Conservation of Historic and Artistic Works. A reviewer in attendance wrote:

For the first time a daguerreotype [full-plate] has been imaged and analysed using scanning electron microscopy and X-ray microanalysis and the results had lead to replicating the deterioration in modern daguerreotypes for a deeper understanding. This is a great advance because the study considers new factors of damage which could reduce the hazing in daguerreotypes, problem that had been considered untreatable until this moment.⁶⁵⁹

⁶⁵⁹ Marta Garia Celma, "Review." Paper presented at the AIC – Photographic Material Group – Biannual Winter Meeting 2015 / Conservation Conversations, Harvard University, Cambridge, 2015. Online at <https://iconsotland.wordpress.com/2015/03/26/review-aic-photographic-material-group-biannual-winter-meeting-2015/> (Date accessed, 18, March 2017)

The follow-up article published in *Topics in Photographic Preservation* immediately follows as Appendix A.⁶⁶⁰ All analogue photographic media can be served by the recreative approach to photographic history. With the rapid shift to digital imaging technologies, the need for this type of work has never been more acute, as Grant B. Romer, historian and conservation scholar noted:

The lessons of photographic history teach that there is an astonishingly rapid loss of knowledge and skill attending the usurpation of one commercially dominant system of photography by another. Much research effort in photograph conservation has been, is, and will be devoted to rediscovering and exploring past methods... The loss of knowledge of the craft of traditional photography is now ongoing...⁶⁶¹

The methodology applied here to revisit the History of Photography serves as an effective model for the burgeoning field of Science and Technology Studies (STS) and the History of Science. As traditional analogue methods yield to digital applications for research, textual information related to preliminary experiments, the progress of discovery and human agency involving tacit and gestural knowledge are not retained, and become increasingly more difficult to access from textual sources alone. Replicative experiments effectively recover this knowledge and help to preserve these histories.

⁶⁶⁰ Michael Robinson and Edward P. Vicenzi, "A Twin Paradox: A Study of Preservation and Disfigurement of Southworth and Hawes Daguerreotypes." *Topics in Photographic Preservation* 16 (2015): 196-97.

⁶⁶¹ Grant B. Romer, "What Is a Photograph?". Chap. Part 1 History of Photograph Conservation; Reading 14. In *Issues in the Conservation of Photographs*, edited by Debra Hess Norris and Jennifer Jae Gutierrez, Los Angeles: The Getty Conservation Institute, 2010: 108-9.

Appendix A

A Twin Paradox: A Study of Preservation and Disfigurement of Southworth and Hawes Daguerreotypes

Mike Robinson and Edward P. Vicenzi

Presented at the 2015 PMG Winter Meeting in Cambridge, Massachusetts.

Abstract

The Young America exhibition of Southworth and Hawes daguerreotypes in 2005 established new protocols for condition monitoring of daguerreotypes during the course of the traveling exhibit. The carefully annotated photographic records created for every image prior to exhibition provided direct evidence of spotting and hazing on the surface of a few of the daguerreotypes while on public display. In the aftermath of the Young America exhibition, the stability of daguerreotypes, once thought to be among the most enduring type of photograph, came into question. As a result of this uncertainty, curators are reticent to exhibit daguerreotypes and conservators have begun to work in collaboration with material scientists to determine the mechanism of this deterioration.

*Lot Number 75 of the David Feigenbaum Collection of Southworth and Hawes daguerreotypes, sold at Sotheby's in 1999, was comprised of two nearly identical full plate daguerreotypes entitled *Four Women Posed around a Table*. What makes them nearly identical is that these plates were produced as a stereo pair especially for viewing in the Grand Parlor and Gallery Stereo viewer. These plates are literally twins, exposed within seconds of each other and processed one directly after the other. Yet despite their commonality, one plate developed the problematic disfiguring white haze, while the other was found in nearly pristine condition. In addition to being made at the same time with the same materials and methods, the plates have been stored in the same environment for the duration of their existence. Until now, the cause of the deterioration of one of the two plates has been speculative. This pair provided a unique opportunity to study the mechanism that produces the hazing problem associated with Southworth and Hawes daguerreotypes.*

Our collaboration involving careful characterization of the full plate stereo pair, in addition to novel experimental replication methods, has uncovered a mechanism that accounts for the white haze disfigurement. For the first time, Southworth and Hawes full plate daguerreotypes have been imaged and analyzed using scanning electron microscopy and X-ray microanalysis. Morphological information within the images and chemical data obtained on the nineteenth century plates led to replication of the mechanism of deterioration using modern daguerreotypes. This new understanding allowed us to adopt a simple and successful conservation treatment to ameliorate this vexing problem. This is noteworthy because the problem has been considered untreatable given the haze has been associated with photo-reduced silver. The results of this study suggest that damage due to light sensitivity of daguerreotypes should be reconsidered.

Robinson, M, and E. P. Vicenzi

Southworth and Hawes Daguerreotypes

1. Problem: Daguerreotypes Observed to Deteriorate During Exhibition

Carefully annotated photographic records created in preparation for the *Young America* exhibition and catalogue provided direct evidence of spotting and hazing on the surface of a few of the daguerreotypes while on display. This was not the first occurrence of the problem however; Southworth and Hawes scholar, Dr. Charles L. Moore noticed a full plate daguerreotype of Lola Montez forming a white haze during the Spirit of Fact exhibition in 1976. (Romer 2014) In the aftermath of the *Young America* exhibition, the stability of the daguerreotype, once thought to be among the most enduring type of photograph, came into question. As a result of this uncertainty, curators became reticent to exhibit daguerreotypes and conservators began to work in collaboration with material scientists to determine the mechanism of this hazing phenomenon.

Of the 160 daguerreotypes on view, it was reported that “25 daguerreotypes had been damaged, five of them critically” over the course of the two-and-a-half year exhibition. (Grushkin 2012, 71) This was distressing news for the organizers of the exhibition, the owners of the plates, and for all who value daguerreotypes.

2. Preliminary Study: Chlorine is Found in Deteriorated Daguerreotypes

To shed light on the issue, two plates that had formed haze during the exhibition, from the collection of the George Eastman Museum, were sent to Silvia Centeno at the Metropolitan Museum of Art for analysis, along with a group of six daguerreotypes from the Met’s own collection showing similar deterioration. The results from this analysis indicated that silver chloride was present in the affected areas, and preliminary results were first published in *Topics in Photographic Preservation*, Volume 12 2007. In that article, a pre-exhibition photograph, taken in March 2005, of a daguerreotype of a seated woman is shown next to another photograph of the same plate taken in June. The images clearly show that pre-existing faint white haze had significantly worsened in one month’s time. (Wiegandt and Meller 2007) Another daguerreotype was shown to have developed whitish rings or halos around pre-existing nuclei of undetermined contamination. At this point, the source of the chlorine on the plate was speculative; residual processing chemicals, prior conservation treatments, the environment, and housing materials were all suggested possibilities.

3. Research: The Mechanism of Deterioration Is Proposed

Centeno et al published these findings in 2008 (Centeno et al. 2008) and followed-up with a study in 2011 attempting to replicate the chlorine-induced haze. (Centeno et al. 2011) The first study posited that the formation of silver chloride on the plate was possibly due to environmental chlorine from Boston’s saline atmosphere and the mechanism for the formation of the haze and white spots was the formation of print-out silver while on display, described by the authors as “redeposited silver”. The authors conclude;

These findings have profound implications for the exhibition and preservation of the daguerreotypes due to the photosensitivity of AgCl in the ultraviolet–visible range, which can generate metallic silver that would redeposit on the surfaces of the plates. (921)

Robinson, M, and E. P. Vicenzi

Southworth and Hawes Daguerreotypes

Centeno et al. made use of daguerreotype samples I prepared using 19th century materials and recipes for their 2011 follow-up study. SEM micrographs showed that these modern samples, compared to a 19th century daguerreotype, had similar image particle morphology and gilding layer microstructure, and therefore, would serve as a “suitable system[s] for mimicking the deposition of chlorides in real artworks”. (63) Modern samples were placed in a vacuum desiccator containing a saturated salt solution for three weeks. Cubic AgCl crystals formed over image particles as well as at surface defects in non-image areas, clearly indicating that the formation of silver chloride is independent of image areas on the daguerreotype (61). The study also reported that silver metal was redeposited from AgCl in seconds when struck by the electron beam of the scanning electron microscope. Extended exposure to the SEM electron beam (several minutes) formed a particle large enough at 400 nm, for EDS analysis within the SEM to determine it to be pure silver. (62) This study showed that AgCl can be reduced by the electron beam within a SEM; that museum illumination is sufficient to cause the same reaction was not rigorously addressed.

A two step scenario for the hazing has been postulated by Wiegandt; near-UV light may at first induce the formation of visible silver chloride crystals from chlorine contamination in the plate, and then museum illumination causes the re-deposition of silver from the silver chloride compounds. (Wiegandt and Meller 2007) If the haze is redeposited silver, it follows that such damage is irreversible. Wiegandt states that the only option for the long-term preservation of daguerreotypes is to enclose the plates in an inert argon gas atmosphere to prevent further degradation. (Grushkin, 2012, 73)

4. Reaction: Daguerreotypes are a Problem due to their Microstructure

If photolysis of silver chloride (redeposited silver) is the cause of the visible haze, then one would have to conclude that these plates are light sensitive. So, after these studies were published, curators and conservators began to mount daguerreotypes on walls covered with a dark curtain to block out light. This practice sends a clear message to the viewing public that all daguerreotypes are sensitive to light. Worse yet, the rigorous protocol deemed necessary to monitor changes over the term of an exhibition has resulted in the postponement of an important daguerreotype show due to the additional expenses and potential risk involved. This approach is appropriately conservative in light of the findings at this time. The issue reached the awareness of the general public when published in *The Scientific American* in 2012, and then the in the *New Yorker* in 2013; both articles reporting nearly the same story...

The Case Of The Disappearing Daguerreotypes, in *The Scientific American*, December 2012
Scientists theorize that the process draws silver to the surface to form subsurface voids. In the case of Southworth and Hawes, these voids may have trapped chlorine from Boston’s salty air. Light would then re-expose the sensitive silver chloride and form a haze that mars the image. (73)

A Portrait of Immortality, Faded, in *The New Yorker*, June 2013
Bigelow, Wiegandt, and others have theorized that the Eastman House images, originally taken in Boston, trapped chlorine from the sea air in their subsurface voids. When the images

Robinson: The Techniques and Material Aesthetics of the Daguerreotype

Robinson, M, and E. P. Vicenzi

Southworth and Hawes Daguerreotypes

were exposed to light, the chlorine reacted with the silver plate and clouded the surface.
(Nijhuis 2013)

Grushkin's article in *The Scientific American* reproduced a FIB-SEM section of a daguerreotype with sub-surface voids. Ralph Wiegandt suggested that voids beneath the surface daguerreotype may have trapped chlorine from Boston's salty air and during exhibition reacted with light to form the haze. Sub-surface voids in the daguerreotype were first identified with FIB-SEM in late 2007. The research was conducted by Patrick Ravines, then at the George Eastman House, with assistance from the Kodak Research Laboratory personnel.

I shared my own research on modern daguerreotype samples with Ralph Wiegandt and Patrick Ravines having been apprised of this discovery.

Hi Ralph & Patrick

I now suspect the pattern found in the substrate on a SEM daguerreotype mid-tone image as due to gold toning not cyanide etching as proposed by Barger & White. See this set of SEM images of a pristine condition newly made daguerreotype.

The pattern shows up only on gold toned plates using higher than 5 kV on all three sets of images I've studied so far. Does this mean the gold is penetrating the sample, causing voids, or what? Maybe the voids that Patrick has witnessed on cross sections is actually gold?
(Robinson 2008)

SEM imaging showed these voids in the late 1980s and early 1990s, though the cause was misidentified as due to conservation intervention. In *The Daguerreotype: Nineteenth-century Technology and Modern Science*, first and second editions, Barger and White reported that "the darker pattern on the substrate ...caused by cyanide cleaning treatment" was distinct on 98 percent of the daguerreotypes they imaged in the SEM. (2000, 187) Actually, the pattern thought to be cyanide etching is the imaging of the void field below the surface of the plate due to the penetration of the electron beam. The void field lies just below the gilding layer and is roughly 200 nm thick. The electron beam penetrates the sample relative to the voltage setting with greater voltage penetrating deeper into the sample. Barger and White's SEM images were created using a 40 keV electron beam. I have made SEM images of 19th century daguerreotypes and pristine modern samples, both gilded and ungilded, for my dissertation research. The dark pattern emerges around 9 keV when gradually stepping up the electron beam voltage in 1 keV increments, and becomes increasingly more pronounced with each increment, for *gilded* daguerreotypes. Figure 1 shows a modern un-gilded daguerreotype imaged at 30 keV having no visible dark pattern (upper left), a modern gilded daguerreotype imaged at 30 keV with a visible dark pattern (upper right) and the same plate imaged at 5 keV without it (lower left). The lower right image is an SEM image from Barger's research imaged at 40 keV. (*Note: The SEM at Ryerson has a maximum electron voltage of 30 keV.*)

Robinson, M, and E. P. Vicenzi

Southworth and Hawes Daguerreotypes

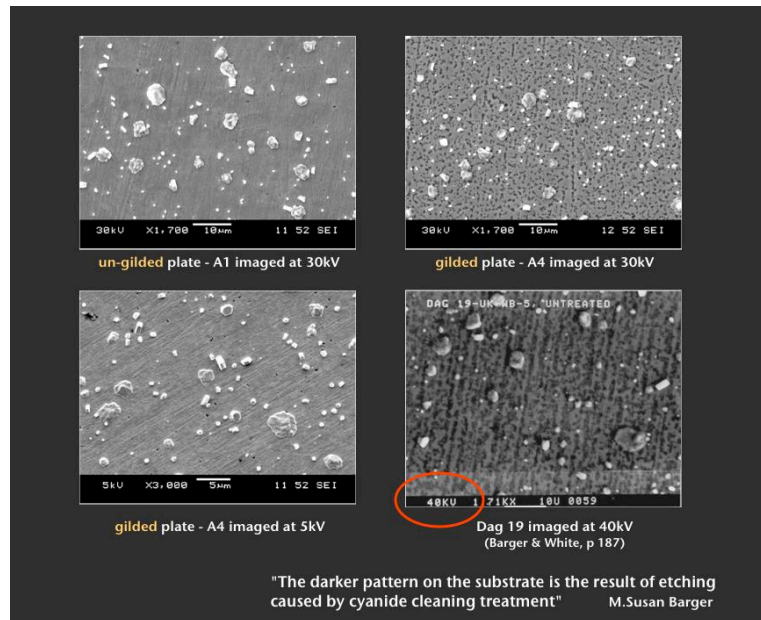

Fig. 1. Gilded and un-gilded SEM images of modern daguerreotypes, courtesy of Qiang Li, Ryerson University, (lower right) 19th century daguerreotype courtesy of Susan Barger, from *The Daguerreotype: Nineteenth-century Technology and Modern Science*, 187.

Ungilded daguerreotypes do not have sub-surface voids. The dark pattern is absent, regardless of the penetration depth of the electron beam, clearly showing that the gilding process causes the sub-surface voids. Ed Vicenzi et al. (2014 a, b), using more advanced focused ion beam microscopy (FIB), scanning transmission electron microscopy-energy dispersive spectroscopy (STEM-EDS) and nano-X-ray fluorescence spectrometry (nano-XRF), was able to determine the chemical makeup and nanostructure of daguerreotype image particles, the silver substrate and voids, and the layer produced by gold toning. (Vicenzi et al., 2014a) The gilding layer covers not only the surface of the silver-mercury amalgam image particle, but also the interface between the image particle and the plate, effectively bonding the image particle to the plate surface. This diffusion-driven process explains why gilded daguerreotype image particles are far more difficult to dislodge from the plate than ungilded image particles. Vicenzi, continuing his research, found the gilding layer to be comprised of roughly two-thirds silver to one-third gold. (Vicenzi and Robinson, 2015) The high silver content of the gilding layer explains the formation of the sub-surface voids as silver atoms migrate from the plate to mix with gold in the process. Silver available in the gilding layer also accounts for the formation of silver sulfide and silver chloride deterioration. Cross section and top-down SEM imaging, with stepping electron beam penetration, show that the void field is essentially *sealed* beneath a gilding layer that is ~85 nm thick. It seems unlikely the voids serve as traps for chlorine from Boston's salt air to be later activated by museum light and form the haze on the surface. It is far more plausible that chlorine

Robinson, M, and E. P. Vicenzi

Southworth and Hawes Daguerreotypes

and sulfur contaminants react with the silver available in the gilding layer *on the surface* of the daguerreotype.

5. Contrary Evidence: Is the Hazing Really Light Induced?

The suggestion that daguerreotypes are light sensitive is contrary to my experience. Nineteenth-century and modern well-sealed daguerreotypes, displayed on my north-light studio wall for over twelve years, receive continuous light exposure, and have remained unaltered. I have observed that white haze is not always induced by light exposure. There are several sixth-plate daguerreotypes from the Southworth and Hawes archive, held at the George Eastman Museum, that were received unsealed in wooden plate boxes that have rarely seen the light of day, yet are obscured by a white haze. Furthermore, a series of photographs taken between 1999 and 2013 of a whole-plate daguerreotype illustrate that hazing can continue to advance in dark storage, and is not necessarily a light induced phenomenon.

A hand tinted full-plate daguerreotype, titled *A Woman in Damask Evening Gown, Posed with a Chair*, Lot 52 in the David Feigenbaum Collection of Southworth and Hawes auction at Sotheby's New York on September 27, 1999 was purchased by collectors Michael Mattis and Judith Hochberg. The photograph taken for the auction catalogue provides a good record of the state of hazing deterioration in 1999. The presence of applied colour on this image indicates that it has not undergone any previous aqueous conservation treatment, as this tends to wash away applied colour. This plate was photographed for the *Young America* exhibition and catalogue in 2005, which clearly shows that hazing on the daguerreotype had advanced to obscure the hem of the lady's dress. Michael Mattis and Judith Hochberg, who were living in the dry climate of the American southwest at the time, assured me that the plate had not been on display during the years between the Sotheby's sale and the *Young America* exhibition. So, this change occurred while the plate was stored in a drawer, away from light. This was *not* one of the five plates reported to have changed critically during the *Young America* exhibition. Apparently the plate had remained stable, so an outgoing condition report and post-exhibition photograph was not done. If any change had occurred during the exhibition it had gone unnoticed by the curators, conservators and the owners.

However, in 2013 the plate was sent to me for consultation. I photographed the plate and it is plainly evident that further change has occurred during the interval between 2006 and 2013. Once again, the plate was kept in dark storage. In this instance, as stated, there was no noticeable change over the course of the *Young America* exhibition, however the plate had continued to deteriorate in dark storage, which contradicts the notion that the haze is due to light induced, redeposited silver. Figure 2 shows the progression of haze that occurred during dark storage from 1999 to 2005, and after exhibition to 2013.

Robinson, M, and E. P. Vicenzi

Southworth and Hawes Daguerreotypes



Fig. 2. Southworth and Hawes, *A Woman in Damask Evening Gown*, whole-plate daguerreotype ca. 1850, from the collection of Michael Mattis and Judith Hochberg, courtesy of Sotheby's (*left*), courtesy of the George Eastman Museum (*center*), courtesy of the first author (*right*).

Lot Number 75 (fig. 3) in the David Feigenbaum Collection of Southworth and Hawes daguerreotypes was comprised of two, nearly identical, full-plate daguerreotypes titled *Four Women Posed around a Table*. Michael Mattis and Judith Hochberg also acquired this pair at the auction. These plates are nearly identical because they were produced as a stereo pair especially for viewing in the Grand Parlor and Gallery Stereo viewer. These plates are literally twins, exposed within seconds of each other and processed one immediately after the other. Yet, despite their commonality, one plate developed the problematic disfiguring white haze, while the other was found in nearly pristine condition.

In addition to being produced at the same time, with the same materials and methods, the plates have been stored in the same environment for their entire existence. Photographs taken in 1998, by art dealer John Cira and given to Christopher Mahoney of Sotheby's during an initial condition survey of the collection, indicate that the severely deteriorated plate had changed while in storage; either during the interval between the 1860's until the mid-1930's when the collection was transferred to Holman's Print Shop for sale, or from that point until 1999 when they were discovered in a David Feigenbaum's garage, or both.

This pair, having been made at the same time and stored together under the same environmental conditions, offered us a unique opportunity to investigate the hazing problem associated with Southworth and Hawes daguerreotypes.

Robinson, M, and E. P. Vicenzi

Southworth and Hawes Daguerreotypes



Fig. 3. Southworth and Hawes, Left and right images of the full plate stereo pair, *Four Women Posed around a Table*, whole-plate daguerreotypes ca. 1853 from the collection of Michael Mattis and Judith Hochberg. Courtesy of the first author.

6. New Research: Understanding the Twin Paradox

Michael Mattis agreed to send the plates to the Metropolitan Museum of Art for non-destructive analysis. The analysis was inconclusive. Raman spectroscopy showed the presence of silver chloride but the system was unable to distinguish the relative quantities on clean versus hazed areas. (Sessa and Centeno 2013) I brought the plates to Washington, DC where Ed Vicenzi and I adapted the sample platform of the scanning electron microscope at the Museum of Natural History to safely examine, with greater precision, the full plate daguerreotypes using SEM imaging and microanalysis. The SEM images (fig. 4) of the disfigured right side stereo plate of an apparently clean mid-tone area (C7) and hazed area (E7) were distinctly different: the hazing is comprised of sub-micron amorphous particles roughly one-tenth the size of the image particles. The apparently clean area (C7) did not appear to be any different than the SEM images made from the same area on the pristine left hand stereo plate.

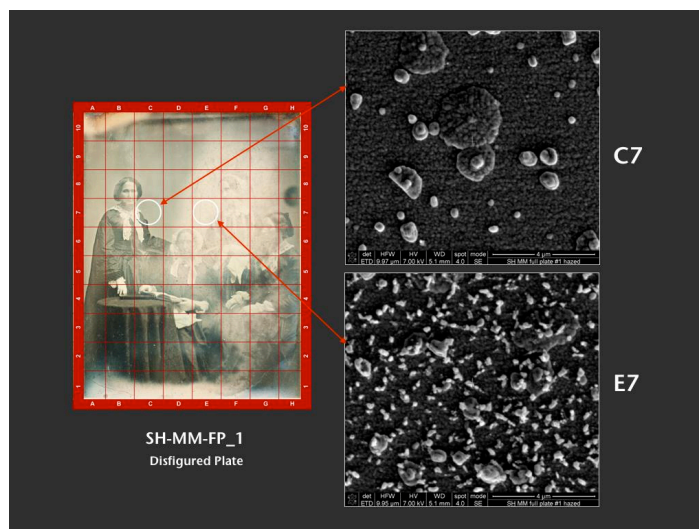

Fig. 4. Secondary electron imagery ($E_0=5$ kV) of the disfigured plate. Relatively clean area C7 (top), and strongly hazed area E7, of disfigured plate (bottom), courtesy of the authors.

Significantly, this was the first analysis of the chlorine contamination to link surface morphology to chemistry. Vicenzi, with SEM-EDX microanalysis, determined that the hazed area (E7) contained *five-times* more chlorine than the apparently clean area (C7) on the disfigured plate, and further, that the pristine plate had *zero* chlorine present. (Vicenzi and Robinson 2015) The morphology of chlorine containing particles in the SEM images reminded me of a similar microstructure I had seen on my own research samples made in 2010. In order to observe the silver halide morphology, I prepared iodized and iodo-bromized plates, unexposed and unfixed, and placed them in a scanning electron microscope. The amorphous silver-halide particles on my samples looked distinctly similar to the haze particles on the disfigured full-plate. This observation and the new SEM-EDX data led us to conclude that chlorine contamination was likely compounded as AgCl. These results confirmed the haze was due to silver chloride, but how one plate was affected and the other pristine was still a mystery at this point.

7. Revised Model: The Mechanism of Deterioration is Discovered through Replication

With the data from the 19th century stereo pair, I planned to replicate the formation of silver chloride on daguerreotypes made according to Southworth and Hawes practice. (Robinson 2005) I hoped they would serve as samples to test conservation treatment options for the historical photographs. I suspected that the tideline hazing on the disfigured plate had conformed to invisible drying traces, and wanted to see if I could replicate this patterning with chlorine contamination.

Robinson, M, and E. P. Vicenzi

Southworth and Hawes Daguerreotypes

While creating the test daguerreotypes, I held them with pliers and applied heat with an alcohol lamp to replicate 19th century drying practice. I then cut the plate in two and exposed one half to chlorine vapor by suspending it for twenty minutes over two grams of calcium hypochlorite contained within a glass jar, similar to daguerreian practice when sensitizing a plate with halogen vapor. I removed the plate and observed that the light brown colour of AgCl had formed on the plate, non-uniformly, more or less intense following invisible traces left by the drying process. I quickly photographed the chlorinated plate, along side the clean half, and placed it in dark storage. (fig. 5) Two days later, I was amazed to see a pronounced white haze had formed on the chlorinated plate according to the drying pattern. I re-photographed the plate and returned it to dark storage. After two more days the haze had worsened, and the plate was even more hazed ten days later, when taken to Ryerson University in Toronto for SEM analysis.



Fig. 5. Haze progression on chlorinated modern daguerreotypes. Courtesy of the first author.

The analytical spectrum obtained from my chlorinated modern plate using the SEM at Ryerson University matched the spectrum obtained from the disfigured Southworth and Hawes full plate at the Smithsonian. The chlorinated samples mimicked the deterioration on Southworth and Hawes plates, but aged in an accelerated manner. The morphology of AgCl induced on my plates is cubic and more atomically ordered than the amorphous material found on the 19th century plate, possibly due to the rate of the crystal growth. I produced the white haze deterioration on a new plate in just two days time, while the haze on the Southworth and Hawes daguerreotypes took some decades to form. Nevertheless, the chlorination did follow invisible traces from drying the plate as suspected, similar to the disfigured half of the stereo pair of *Four Women Posed around a Table*, and the hazing advanced while in dark storage as observed with *A Woman in Damask Evening Gown, Posed with a Chair*.

The research published in 2008 and 2011 by Centeno et al, implies that the disfiguring white haze is caused by redeposited silver from light exposed silver-chloride compounds. My experiments mimicking the problem seemed to contradict this notion, as the hazing occurred while the samples were stored in the dark. However, I had to consider the possibility of light induced haze, as my samples were exposed to daylight for photo-documentation. I prepared another experiment to investigate the reaction of light exposure on a daguerreotype image contaminated with silver chloride. I masked off half of a uniformly imaged mid-tone and gilded test plate and exposed it to chlorine vapor under safelight. I then covered the plate, perpendicular to the chlorination, to completely block light on half of the plate, and placed it in my studio window for 24 hours. The light intensity averaged 50x greater than the lux during the *Young America* exhibition. I packed the sample and shipped it overnight to Ed Vicenzi, in Washington,

Robinson, M, and E. P. Vicenzi

Southworth and Hawes Daguerreotypes

for SEM imaging and analysis. The un-chlorinated side of plate provided a baseline for the chemical composition and microstructure of a pristine plate. The un-exposed and the daylight exposed chlorinated samples were covered in AgCl crystals; however, the side exposed to daylight had fewer, but larger, crystals indicating a coarsening with a corresponding increase in apparent haziness. (fig. 6)

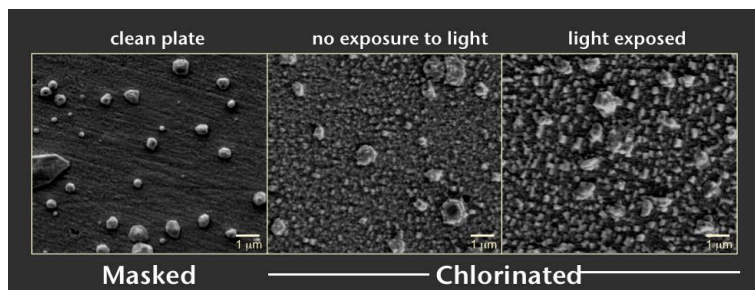

Fig. 6. SEM images of a modern daguerreotype showing clean vs AgCl formation in dark and light environments. Courtesy of Ed Vicenzi, Smithsonian Institution.

Significantly, microanalysis showed that the chlorine *counts* remained nearly the same for both the light exposed and un-exposed side. If the haziness was the result of print-out silver, as suggested by Wiegandt and Centeno, it should be expected that the chlorine counts would be *less* on the daylight exposed side of the plate. When light is incident on a halide molecule, such as silver chloride, different chemical reactions are possible. The most well known to photographers is a photolytic reaction, where high energy short-wave radiation breaks the chemical bond and prints-out silver deposits on the substrate while releasing the halogen into the atmosphere. This photolytic reaction is the foundation of the latent image in photography and the visibly darkened image in AgCl print-out photographs, such as salted paper prints. Chlorine net counts on the light exposed plate represent 93% of the chlorine kept in dark storage. These results indicate that photoreduction of AgCl to Ag plays a minor role even under the greatly enhanced light flux of the experiment. Furthermore, the micrographs show haziness is caused by larger particles that can more efficiently scatter light of all wavelengths, producing a white appearance on a daguerreotype. Print-out silver particles on an iodized daguerreotype plate are *several times* smaller and appear dark, creating a negative image, as Niépce and Daguerre understood, before mercury vapour was discovered as a means to amplify the latent image. Large mercury developed image particles also scatter light and appear brighter than the dark reflections in the polished plate.

Not previously considered is an alternative photo-activated reaction with AgCl crystals present on a daguerreotype plate. Rather than photolytic, a photochemical reaction causes the excitation of the electrons in a chemical bond raising their energy level coupled with increased lattice defects, causing the AgCl crystals to recrystallize and coarsen at a greater rate relative to unilluminated AgCl. Small particles are more entropic, having a greater surface area to mass ratio, and tend to combine with each other to form fewer but larger particles over time. This is a spontaneous process known as *Ostwald ripening*. Photographic film producers maintain the gelatine emulsion at melting temperature for extended time to promote Ostwald ripening and

Robinson, M, and E. P. Vicenzi

Southworth and Hawes Daguerreotypes

produce high-speed, large grained films. A sensitized daguerreotype plate increases in photosensitivity when it is kept in the dark for an hour before exposing, perhaps due to the same spontaneous Ostwald ripening process.

The mechanism for the appearance of increased haziness or white spots is not print-out redeposited silver; it is the AgCl present on the plate that is coarsening into larger, light scattering particles, as has been demonstrated with the modern chlorine contaminated daguerreotype samples. The coarsening is accelerated by light, but it will spontaneously occur in the dark, provided there is enough AgCl present to recombine into larger particles.

8. Chlorine Source: Storage Conditions are Key

Having replicated and determined the cause for the white haze on daguerreotypes, the question remained as to the source of the chlorine on the affected 19th century daguerreotypes. Many of Southworth and Hawes' daguerreotypes, when taken from the storage boxes, have silver-sulfide tarnish that conforms to the perimeter of the opening of a brass matt and sealing tape residue on the back. This indicates that these daguerreotypes had at one time been matted and glazed, likely displayed in the studio as an exemplar of their work or a portrait of a noteworthy individual. It is plausible that the daguerreotypes were removed from display after Southworth and Hawes updated their process with collodion negatives and albumen paper prints. The bulk of the Southworth and Hawes studio archive was stored unglazed, in wooden plate boxes supplied by the plate manufacturer. Some of the whole plates were in custom made tin boxes designed to house eighteen plates per box; more if placed back-to-back in the grooves. There were no custom tin boxes made for plates smaller than whole-plate. Christopher Mahoney recorded the box type and identifier for each of the sixty-eight whole plates in the Feigenbaum sale; twenty-two plates in "Tin Box A", twenty-four in "Tin Box B" and twenty-two in "Wooden Box 6A". (Mahoney 2013) I acquired one of these tin boxes after the Feigenbaum sale and noticed on the lid in Hawes' handwriting is "Selections for Copy". This is a clue that some of Southworth and Hawes' important images were unframed for copying, then stored bare in this tin box perhaps in the late 1850's. Also written in pencil on the box side, in another hand, most likely Lewis Holman's, is "Known" and "Known Men" (which is crossed out) and "Groups XVIII" is written on the lid. Holman wrote "Hopeful" on a half plate box, and "Known" on a quarter-plate box, which shows that he used the boxes to sort and re-sort the collection for the sales catalogues "Within the Compass of a Print Shop" held in the 1930s and 1940s, and also to ship plates to prospective buyers. Mahoney recorded that the Mattis-Hochberg stereo pair was not found in the same box. The pristine plate was found in "Tin Box A" and the disfigured plate was found in "Tin Box B". Another stereo pair from the sale was Lot 19, *The Letter* and Lot 20, *The Letter; (Chair on Left Closer to the Edge of the Frame)*. Lot 19 was found in "Tin Box B" and Lot 20 was in "Wooden Box 6A". It seems illogical that stereo pairs would be separated while at the studio, so finding these pairs in separate boxes is very likely due to the sorting and re-sorting of the collection later at Holman's Print Shop. Letters from Richard Holman to collector Zelda MacKay in 1944 indicate that Holman's shipped bare plates in boxes to interested collectors and museums for consideration based on their interests. (Murata 2003, 40-1) The point of this preamble is to make clear that all Southworth and Hawes plates, smaller than whole plate size, were stored in wooden plate boxes and that whole-plates may have been kept in custom built tin or manufacturer supplied wooden boxes, based on Hawes' preference. The plates were re-positioned later by

Robinson, M, and E. P. Vicenzi

Southworth and Hawes Daguerreotypes

Holman into wooden or tin boxes based on sales potential. The construction material of the storage box is germane to this investigation.

Within the ex-Matthew R. Isenburg Collection are twenty-four, unused, ninth-plates (not from the Southworth & Hawes studio) still in the original manufacturer's box. (fig. 7) The first plate in the row faced the adjacent sidewall of the box and is the most contaminated, with less deterioration on the plates behind it. All of the un-polished plates have two distinct bands of haze deterioration lengthwise where the plate had been in contact with the wooden grooves of the plate box. The centers of the plates that were behind others in the box are pristine. Ed Vicenzi and I analyzed one of these plates in Washington, DC and another plate was sent to Dusan Stulik and Art Kaplan at the Getty Conservation Center in Los Angeles, CA. The analysis of both plates showed high levels of chlorine near the edge that had been adjacent to the wooden grooves of the plate box, and no chlorine in the center of the plate.



Fig. 7. Box of unused 19th century ninth-plates (left), courtesy ACM-Toronto; 19C plate showing formation of haze on edges (right), courtesy of the author

It is clear that un-glazed daguerreotype plates in close proximity to softwood can be contaminated with chlorine. The hazing on *A Woman in Damask Evening Gown, Posed with a Chair* occurred on the sides and bottom of the plate where the metal was in direct contact with the box, while the top edge was clean due to the gap between the plate and the box lid. The disfigured stereo plate, *Four Women Posed around a Table*, was found heavily hazed in the center as well as the left, right, and bottom edge. Based on circumstantial evidence from the box of unused ninth plates, I believe that this plate may have been stored for some time in the first groove of a plate box with its silver side adjacent to the wooden side panel. This is conjecture as the plates have been shuffled during the selling process at Holman's Print Shop. The custom tin boxes also have grooved wood on two opposite sides to separate the plates; the other four sides are tinned metal. The lids are very close fitting and provide a much better seal against the atmosphere than the manufacturer's wooden boxes. Softwood may inherently contain chlorine, though there is evidence to show how wood is able to absorb halogen vapor, then transfer it to a

Robinson, M, and E. P. Vicenzi

Southworth and Hawes Daguerreotypes

silver plate in close proximity. Daguerre understood this principle. In late 1839, he found a quicker way to iodize his plates. He replaced his large 4.8 liter iodizing box with a thin pine board that had absorbed iodine vapor. In placing a polished plate in close proximity to a board saturated with iodine, Daguerre found that he could achieve his desired silver-iodide coating in one-tenth the time required for his large volume box. (Arago 1839, 824)

I have shown evidence that chlorine contamination occurs when a bare daguerreotype plate is stored in close proximity to chlorine bearing wood, and that wood can be a getter for atmospheric chlorine is informed by Daguerre's use of iodine saturated softwood to sensitize his plates. The fact that all of the Southworth and Hawes whole-plates have not suffered from haze formation, and that only one of two identically prepared stereo plates was disfigured, can be explained by the material of the storage box, wood or metal, and the plates' position within the box.

9. Treatment: Conservation of the Disfigured Plates

Bright daylight conditions, unlike those used in exhibition halls, caused no more than 7% silver to re-deposit from AgCl on my samples, but it did accelerate coarsening of the silver chloride particles. This means that haze formation is restructured AgCl and therefore treatable with a suitable solvent. Silver chloride is soluble in photographic fixer, and indeed, when I dipped and edge of one of my chlorinated test samples into a 3% w/v solution of sodium thiosulfate the haze instantly cleared, however, I was reticent to treat the historic plates in sodium thiosulfate solution because it contains sulfur. Sulfur bearing solutions used for fixing and gilding daguerreotypes can become stale. These when used stale, and thiourea, can cause black specks of concentrated sulfur to form on daguerreotypes. As a cautionary side note, thiourea has been found to remove gold from a daguerreotype. (Da Silva et al. 2010, 660) Silver chloride is also soluble in ammonium hydroxide solution, (NH₄OH) and in testing, was equally effective in removing the haze from my chlorinated samples.

Ammonium hydroxide solution has been used to treat other daguerreotypes, and was particularly effective in dissolving the obscuring white haze on a trove of John Ruskin daguerreotypes. The Ruskin plates were discovered un-glazed in a wooden box separated only by thin paper on the verso; a remarkably similar storage scenario to the Southworth and Hawes archive. They too suffered from an opaque white haze that formed according to contact with the paper backing between the stacked plates. Conservator Angels Arribas poured a 10% solution of NH₄OH over the surface of the plates and the haze quickly dissolved leaving no residues behind. (Jacobson and Jacobson 2015, 348-9)

I was presented with a challenge in treating *The Woman in Damask Evening Gown, Posed with a Chair*. Pouring ammonia over the surface, or immersing the plate in a solution, was out of the question because these treatments would rinse away the flesh colored tinting on the woman's face. The best course of action was to apply the NH₄OH solution locally. I tested the treatment with my own daguerreotypes and found that I could direct a stream of ammonia solution of 2~3% strength with a squeeze bottle on a local area, and with an after-rinse of distilled water in the same fashion, no demarcation between the wetted and dry surface was visible. Figure 8 shows the pre-and post treatment results.

Robinson, M, and E. P. Vicenzi

Southworth and Hawes Daguerreotypes



Fig. 8. pre-treatment (*left*); post-treatment (*right*), courtesy of the author

After treating the disfigured half of the stereo pair with NH_4OH solution, some trace hazing remained on the surface. To remove the remaining haze, while the plate was submerged in distilled water, I gently swabbed the surface with a microfiber cloth by applying only the pressure from the weight of the cloth itself. (fig. 9) I was confident with this procedure, because the plate was not hand colored, well gilded, and intact throughout. I had also tested the swabbing procedure on my own gilded daguerreotypes prior to treating the historical plate.



Fig. 9. Gently swabbing the surface with microfiber cloth, courtesy of the author
Figure 10 shows the pre-and post-treatment results for the disfigured right side of the stereo pair, *Four Women Posed around a Table*, using the treatments described.

Robinson, M, and E. P. Vicenzi

Southworth and Hawes Daguerreotypes



Fig. 10. pre-treatment (*left*); post-treatment (*right*), courtesy of the author

10. Conclusion: Integrated Analysis and Synthesis Techniques Resolve the Problem

This work reviews the sequence of events that followed from the observation of hazing on a few whole plate daguerreotypes during the *Young America* exhibition in 2005. Analytical research in 2008 on a number of Southworth and Hawes daguerreotypes showed chlorine in areas of visible white disfiguring haze. The proposed mechanism for the formation of the white haze was photolytic, or redeposited silver. ($\text{AgCl} + h\nu$ [UV-Vis] \rightarrow Ag metal) Concurrently with the analysis of the haze, FIB sections showed the presence of voids beneath the surface of daguerreotypes. The source for the chlorine was theorized to be saline atmosphere trapped in the sub-surface voids and activated by exposure to light.

These conclusions were speculative and did not account for other observations. Some plates hazed in the dark, some plates were unaffected, and uniquely, with a stereo pair of daguerreotypes, produced and stored under identical circumstances, one plate was heavily hazed while the other remained in pristine condition.

Analysis of the Twin Paradox pair of daguerreotypes confirmed higher levels of AgCl in the heavily hazed areas of the disfigured plate and no chlorine on the pristine plate. Synthesizing the hazing on modern daguerreotypes by exposing them to chlorine vapor has uncovered a different mechanism of deterioration than what has been previously published. This study has shown that hazing can occur in dark storage, and though accelerated by light, the mechanism of deterioration for the formation of disfiguring haze is the coarsening, otherwise known as Ostwald ripening, of the AgCl.

An explanation for the source of the chlorine contamination has been presented, based on the analysis of unused 19c plates found in their original box. The wood material of the storage boxes, as has been explained, can act as a getter for chlorine, which is then transferred to the bare

Robinson, M, and E. P. Vicenzi

Southworth and Hawes Daguerreotypes

daguerreotype plate. Some of the Southworth and Hawes plates were stored in wooden boxes and some were in tightly closed tin boxes. This storage scenario explains why only some of plates were affected with the hazing phenomenon. Daguerreotypes are not inherently light sensitive, although if contaminated with chlorine they may react to light, but these chlorine-affected plates are just as likely to haze in the dark. This study has shown that the disfiguring white haze due to chlorine contamination can be removed with conservation treatment as described in the previous section.

Materials science has been used since the 1970s to explain the daguerreotype and its preservation concerns. The present study illustrates how materials scientists have, on occasion, misinterpreted the data when solely examining historical objects. Experimental replication can effectively enhance the study of historical daguerreotypes when the samples are produced with a practical knowledge of the process. The “Twin Paradox” question has been resolved through the analysis of historical daguerreotypes, in combination with the study of modern samples that replicated the disfiguring white haze.

Finally, the two conserved whole-plates, presented here, have been displayed in the exhibition, *Through the Looking Glass: Daguerreotype Masterworks from the Dawn of Photography*, along with 150 other daguerreotypes from the Mattis-Hochberg collection. The show was installed in the Frances Lehman Loeb Art Center at Vassar College from April 10 to June 15, 2015. No daguerreotypes were harmed during this exhibition.

Acknowledgments

The first author gratefully acknowledges Michael P. Mattis and Judith Hochberg for permitting the analysis and publication of the whole-plate Southworth and Hawes daguerreotypes from their collection. I am also indebted to my colleague and co-investigator Dr. Edward P. Vicenzi, of the Museum Conservation Institute of the Smithsonian Institution, Washington DC. To conduct our study, Ed freely volunteered his time to perform the microanalysis and arranged for access to the laboratories at the Museum of Natural History and the Museum Conservation Institute. We are indebted to Silvia Centeno and Nora Kennedy of the Metropolitan Museum of Art for conducting preliminary research on the above plates. Thanks also to Dr. Chris Evans, Ryerson University, who arranged for access to the SEM in the Materials Science Department, Ryerson University, Toronto, and we thank Qiang Li, Technical Officer at Ryerson who performed the SEM imaging and analysis of the modern samples. I also thank my graduate students, Elizabeth Larew, Cassandra Zeppieri, and Ingrid Foster, in the FPPCM program at the School of Image Arts, Ryerson for their assistance in preparing the modern daguerreotype samples.

Christopher Mahoney, Head of Sotheby's Photographs Department in New York, shared his notes related to the physical and storage conditions of the Feigenbaum daguerreotypes in 1998 and provided the catalogue photograph for Lot 52, *A Woman in Damask Evening Gown, Posed with a Chair*. I thank Ralph Wiegandt, Taina Meller, and Stacey Vandenberg, of the George Eastman Museum for their input on the conservation of the daguerreotypes in preparation for *Young America*, and for providing the condition reports and photographs of the Mattis-Hochberg owned daguerreotypes loaned to the exhibition. I appreciate Grant Romer for the many

Robinson: The Techniques and Material Aesthetics of the Daguerreotype

Robinson, M, and E. P. Vicenzi

Southworth and Hawes Daguerreotypes

conversations on all daguerreian matters and particularly for his reminisces pertaining to the daguerreotype of Lola Montez that hazed during the *Spirit of Fact* exhibition. I especially thank Irving Pobboravsky for his continued encouragement of my work and for reminding me that silver chloride is soluble in ammonium hydroxide. I wish to acknowledge David Thomson for financial assistance related to travel expenses.

References

- Arago, F. 1839. Physique Appliquée. - Photographie. *Compte Rendu des Séances de L'Academie des Sciences* (Séance du Lundi 23 Décembre): 824.
- Barger, M. S. and W. B. White. 2000. *The Daguerreotype : Nineteenth-century Technology and Modern Science*. 2nd ed. Baltimore, John Hopkins University Press. 187
- Centeno, S., F. Schulte, N. Kennedy and A. Schrott. 2011. The formation of chlorine-induced alterations in daguerreotype image particles: a high resolution SEM-EDS study. *Applied Physics A* 105: 55-63.
- Centeno, S. A., T. Meller, N. Kennedy and M. Wypyski. 2008. The daguerreotype surface as a SERS substrate: characterization of image deterioration in plates from the 19th century studio of Southworth & Hawes. *Journal of Raman Spectroscopy* 39 (7): 914-921.
- Da Silva, E., M. Robinson, C. Evans, A. Pejovic-Milic and D. V. Heyd. 2010. Monitoring the photographic process, degradation and restoration of 21st century Daguerreotypes by wavelength-dispersive X-ray fluorescence spectrometry. *Journal of Analytical Atomic Spectrometry* 25(5): 660.
- Grushkin, D. 2012. The Case of the Disappearing Daguerreotypes. *Scientific American* 307(6): 70-73.
- Jacobson, K. and J. Jacobson 2015. *Carrying Off the Palaces, John Ruskin's Lost Daguerreotypes*. London, Bernard Quaritch Ltd. 348-9.
- Mahoney, C. 2013. Personal email communication related to plates and plate boxes. May 5, 2014.
- Murata, H. 2003. Investigation of Historical and Modern Conservation Daguerreotype Housings. Capstone project for the Andrew W. Mellon Advanced Residency Program in Photograph Conservation, George Eastman House: 40-41.
- Nijhuis, M. 2013. A Portrait of Immortality, Faded. *The New Yorker*. June 2013.
<http://www.newyorker.com/tech/elements/a-portrait-of-immortality-faded>
- Robinson, M. 2005. A Style Peculiar to Themselves: An Investigation into the Techniques of Southworth and Hawes. *Young America : The Daguerreotypes of Southworth & Hawes*.

Robinson: The Techniques and Material Aesthetics of the Daguerreotype

Robinson, M, and E. P. Vicenzi

Southworth and Hawes Daguerreotypes

New York, International Center of Photography; Rochester, N.Y. : George Eastman House; Gottingen : Steidl: 489-93.

- Robinson, M. 2008. Personal email communication related to the "cyanide" pattern sent to R. Wiegandt and P. Ravines.
- Romer, G. 2014. Personal communication in regards to the hazing of the *Lola Montez* daguerreotype during the *Spirit of Fact* exhibition in 1976.
- Sessa, C. and S. Centeno 2013. Examination and Analysis Report. Unpublished typescript, The Metropolitan Museum of Art.
- Vicenzi, E.P., T. Landin and A.A Herzing. 2014a. Examination of a 19th Century Daguerreotype Photograph using High Resolution Scanning Transmission Electron Microscopy for 2D and 3D Nanoscale Imaging and Analysis. *Microscopy and Microanalysis* 20: 2000-2001.
- Vicenzi, E. P. 2014b. On the Nanoscale Chemistry of a 19th Century Daguerreotype Photograph. Presented at Nanoscale Spectroscopy and Nanotechnology 8. Gleacher Center, Chicago. July 29, 2014.
- Vicenzi, E. P. and M. Robinson. 2015. The Twin Paradox: A study of preservation & disfigurement of Southworth and Hawes daguerreotype photographs. Presented at AMASXIII, The 13th Australian Microbeam Analysis Symposium, University of Tasmania, Hobart Tasmania, February 11-13, 2015.
- Wiegandt, R. and T. Meller. 2007. Advances in Daguerreotype Conservation: The Conservation Program for the Exhibition, "Young America: The Daguerreotypes of Southworth & Hawes". *Topics in Photographic Preservation*. 12: 37-47.

Mike Robinson

Faculty / Daguerreotypist, Historian, Conservator
Ryerson University / Century Darkroom

Edward P. Vicenzi

Research Scientist
Smithsonian Institution, Museum Conservation Institute

Papers presented in *Topics in Photographic Preservation, Volume Sixteen* have not undergone a formal process of peer review.

Appendix B

DagTest 4-24-2015 Baron Gros experiment

Mike Robinson

Date April 25, 2015

- R1 C1 — Iodine 120 s Chloro-bromine 80 s
- R1 C2 — Iodine 80 s Chloro-bromine 80 s
- R1 C3 — Iodine 40 s Chloro-bromine 80 s
- R2 C1 — Iodine 120 s Chloro-bromine 60 s
- R2 C2 — Iodine 80 s Chloro-bromine 60 s
- R2 C3 — Iodine 40 s Chloro-bromine 60 s

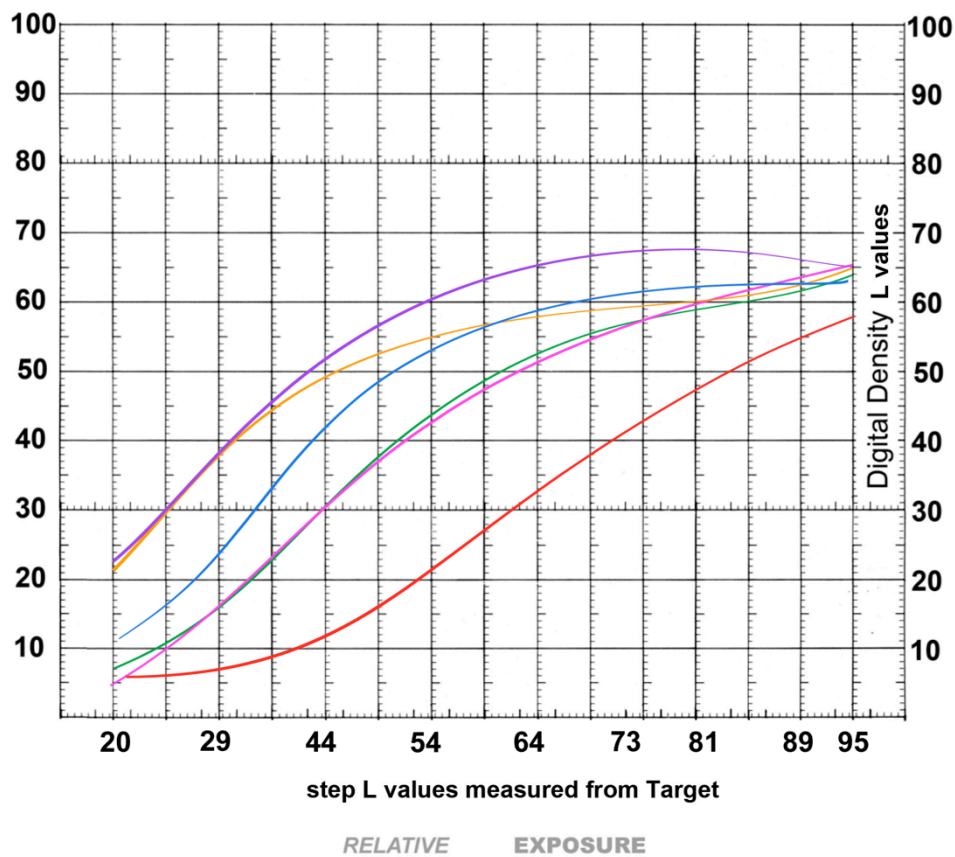

Relative Exposure on the horizontal axis plotted against daguerreotype step tablet brightness on the vertical axis. Curves that shift to the right indicate less photosensitivity.

Appendix C

US Patents Related to Daguerreotype Plate Polishing

Plate Holding Devices

A. Becker,

Daguerreotype Plate-Holder.

N^o 6812.

Patented Oct. 23, 1849.

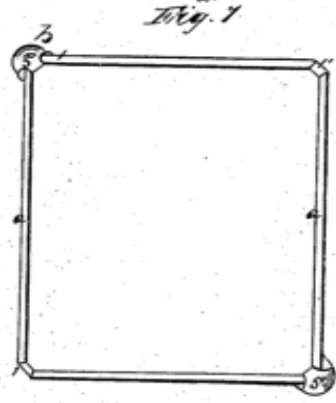
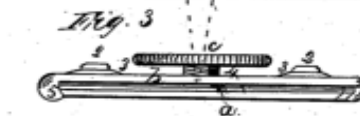
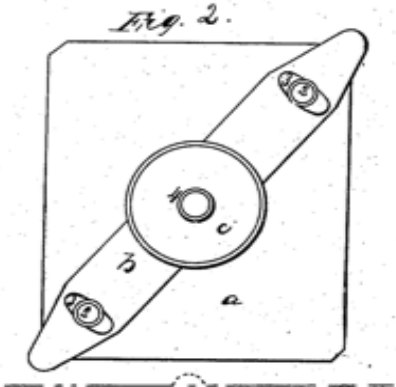

Witnesses
W. L. ...
Samuel W. ...

Inventor
Alex^r Becker



UNITED STATES PATENT OFFICE.

ALEXR. BECKERS, OF NEW YORK, N. Y.

BLOCK FOR HOLDING DAGUERREOTYPE-PLATES.

Specification of Letters Patent No. 6,812, dated October 23, 1849.

To all whom it may concern:

Be it known that I, ALEXANDER BECKERS, daguerreotypist, of the city of New York and State of New York, have invented and made
 5 and applied to use certain new and useful improvements in the means of holding daguerreotype-plates while polishing or cleaning them by so adapting a clip, acting at
 10 the diagonal corners of a holding plate on the plate to be polished, that by a center on the back of the clip a pin on a cross-lever holds the apparatus on a rotary polishing
 15 chuck and allows a rotary movement to the plate that is polishing or cleaning on the chuck; for which improvements I seek Letters Patent of the United States, and that
 20 the said improvements are fully and substantially set forth and shown in the following description and in the drawing annexed to and making part of this specification, wherein—

Figure 1 is a plan of the face. Fig. 2 is a plan of the back, and Fig. 3 is a side elevation of a holding plate, thus fitted, and
 25 holding the plate to be polished.

The same letters and numbers, as marks of reference apply to the same parts, in each of the three figures.

In these *a*, is the holding plate, and *b*, is a diagonally placed piece of metal, behind the plate *a*, each corner, 1, 1, of the plate *a*, is taken off, and beveled inward to the face, so that two opposite diagonal corners receive lips 5, 5, formed by so turning the
 30 ends of the cross piece *b*, upward and inward toward the center, that each lip forms a clip, on the bevels of the two diagonal corners on the plate *a*.

At 2, 2, are screws, having springs 3, 3, beneath their heads, the shafts of the screws 2, 2, going through the cross plate *b*, and the thread of each screw taking the plate *a*, to hold the plate *b*.

In the center of the cross piece *b*, is a thumb screw *c*, the point of which comes against the back of the plate *a*, and in the center is a countersunk space 4, opening to a center, punched into the back of the plate
 45 *a*; when thus completed this holding plate is to be used as follows: The screw *c*, is to be turned out, so as to leave the piece *b*, in contact with the back of the plate *a*, the lip clips 5, 5, will now admit the two diagonal

corners of a daguerreotype plate, to be entered between them, and the beveled angles
 55 of the plate *a*, then by turning the screw *c*, in, the plate *b*, is so far detached from the plate *a*, that the lip clips 5, 5, press strongly on the two angles of the daguerreotype plate, and hold it firmly on the face of the plate *a*;
 60 a small hand lever is to be attached by one end, to the frame, that carries the usual and well known rotary polishing chuck, so that the lever may be moved, as a radius to a circle, whose center is at the point, where
 65 the end of the lever is attached, and at that part of the lever, which is on a line with the axis of the polishing chuck, a stud, or pin, is to be fixed so that the pin shall project downward, through the hole 4, into the center hole in the plate *a*, below the thumb
 70 screw *c*, as shown by dotted lines in Fig. 3; and by means of the lever operated by the hand the plates, may be pressed upon and moved over it in alternate opposite
 75 directions on the face of the chuck, which chuck when put in rapid rotation, will give the plates a rotary motion, varied by the position of the plates on the chuck whether near the center, or near the edge of the chuck,
 80 and if held in one position, by the hand lever, the operation of the polishing chuck will be slow, partial, and unequal, but by moving the lever and plate, across the polishing chuck, in alternate opposite direc-
 85 tions, the chuck operates to bring an equal, clear, and effective polish, by the effect of the varying directions, in which the rotating plate is presented to the action of the revolving
 90 chuck; in most instances, the plate to be polished, is now held in the fingers of the operator, who partially gives to it, a corresponding motion over the face of the chuck, but has not the effective command of the plate, in all situations on the chuck,
 95 which this mode of fitting the plate will give him.

What I claim as new, and of my own invention, and desire to secure by Letters Patent, is—

The application of the cross piece *b*, and lip clips 5, 5, with the thumb screw *c*, to hold the plate to be polished, on the face of the plate *a*, the plate below the center 4, of the thumb screw *c*, being fitted to receive
 100 through an aperture in the center of the

2

6,812

screw a point, or stud, on a lever, by which the plate *a*, can be moved in alternate and opposite directions, across the face of a rotary chuck, for the purpose of polishing, or
5 cleaning daguerreotype plates, substantially as described and shown.

In witness whereof, I have hereunto set

my signature, in the city of New York, this twenty-seventh day of September, one thousand eight hundred and forty eight.

ALEXR. BECKERS.

Witnesses:

W. SERRELL,

LEMUEL W. SERRELL.

W. & W. H. Lewis
Daguerreotype Apparatus
Nº 6,819. *Patented Oct. 23, 1849.*

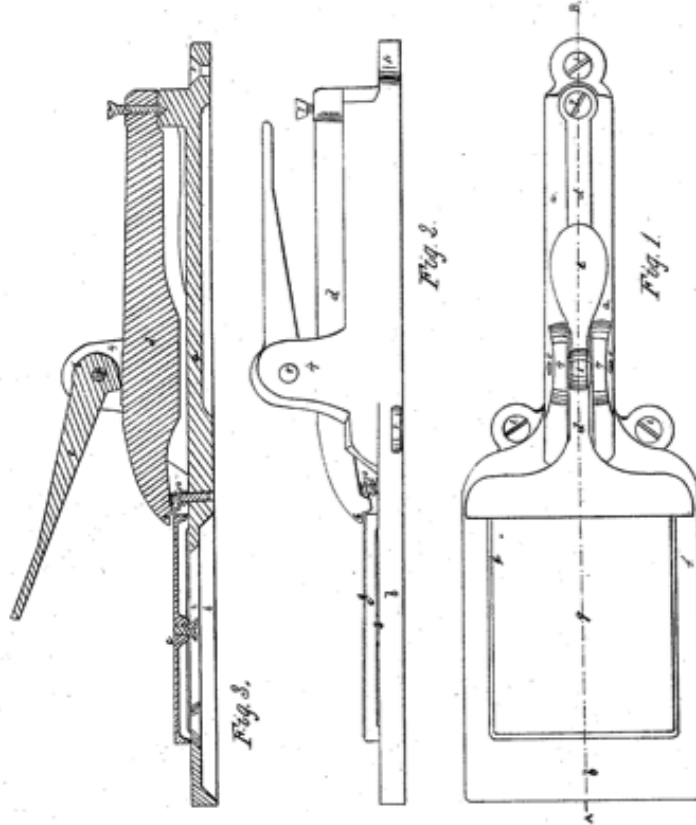

Witnesses.

W. Serrell
Lemuel W. Serrell.

Inventors.

W. H. Lewis
W. H. Lewis.

AM. PHOTO-LITHO. CO. N.Y. (DESIGNED TRADE)

UNITED STATES PATENT OFFICE.

W. LEWIS AND W. H. LEWIS, OF NEW YORK, N. Y.

APPARATUS FOR HOLDING DAGUERREOTYPE-PLATES.

Specification of Letters Patent No. 6,819, dated October 23, 1849.

To all whom it may concern:

Be it known that we, WILLIAM LEWIS and WILLIAM HENRY LEWIS, both of the city of New York, daguerreotype apparatus manufacturers, have invented and made and applied to use certain new and useful improvements in the means of securing the plates used in daguerreotype apparatus in place for the purpose of polishing them, such improvements consisting in so applying a horizontal vise to one end of the plate that it shall be firmly held in place for that purpose by mechanical means, for which we seek Letters Patent of the United States, and that the said improvements are constructively, operatively, and substantially set forth and shown in the following description and in the drawing annexed to and making part of this specification of our said improvements, in which—

Figure 1 is a plan, and Fig. 2 a side elevation of the apparatus completed, as in use; Fig. 3 is a sectional elevation, as through the line A, B, of Fig. 1, showing the parts, as when not in use.

Like letters and numbers, as marks of reference, apply to the same parts, in each of the several figures.

In these *a* is the metal stock piece, shown as to be secured on a bench, or table, by screws 1, 1, 1, and prolonged and spread out, to form a bed plate *b*, which is shown in Fig. 3, as having a slot 2, through the center, the outer end of the slot is enlarged, to pass the head of the screw 3, which passes into the under side of the changeable bearing plate *c*, this may be made larger than shown in the drawing, and cover the whole of the bed plate *b*, when used for polishing a larger plate, the center slot 2, serving for more than one size of bearing plates *c*; the stock piece *a*, is formed with a groove, to receive the jaw stock piece, *d*, which, at the outer end, is formed as a rabbeted jaw, or chop, 6, and on the side of the groove, two small standards 4, 4, receive, through them, a pin 5, that forms the fulcrum for a lever *e*, having a cam head 8, seen best in Fig. 3; a screw 7, goes through the tail end of the jaw stock *d*, into a cup, in a solid part of the stock piece *a*, to adjust the jaw stock *d*, for use; and a small helical expansive spring, 10, beneath the rabbeted jaw 6, lifts that

clear of the plate *c*, when not in use; and at this time, the lever *e*, and cam head 8 will generally be in the position shown in Fig. 3; and when the daguerreotype plate 9, see Figs. 1 and 2, is put in place to polish, and the lever *e*, thrown in the opposite direction, it will take the position, shown foreshortened in Fig. 1; but when the lever *e*, is depressed in the same direction, it will assume the position shown in Fig. 2, the cam 8, depressing the jaw stock *d*, spring 10, and chop 6, forces that down on the end of the plate 9, holding it firmly in place, until the polishing is effected; when the lever is turned back, to the position shown in Fig. 3, and the plate 9 is removed, for others to be successively put on, and held for polishing, in the same manner.

It will be seen, that if the screw 7, was placed between the standards 4, 4, so as to operate downward on the jaw stock, and the cam 8, with the lever *e*, placed at the tail end of the jaw stock, either beneath it, or in a fork at the end, nearly the same results will be obtained, by having the cam larger, on account of acting with the increased length of the jaw stock; but we do not recommend any such change, as it is not so convenient, in use, as when the cam is nearer the holding jaw 6, as we have described and shown it.

We do not claim to have invented a vise for this or any similar purpose; nor do we claim to have invented any of the parts, herein described, as all are well known; but

We do claim as new, and of our own invention, and desire to secure by Letters Patent of the United States—

The application of the cam 8, acting to depress the rabbeted chop 6, on the plate 9, beneath, conjointly with the screw 7, to adjust the parts, for the purpose of holding plates, while polishing the same, substantially as described and shown.

In witness whereof, we have hereunto set our signatures, this twenty-first day of July, in the year one thousand eight hundred and forty-eight.

WILLM. LEWIS.
W. H. LEWIS.

Witnesses:
WM. TERRELL,
LEMUEL W. TERRELL.

S. Peck,
Daguerreotype Plate-Holder,
No. 7,326, Patented Apr. 30, 1850.

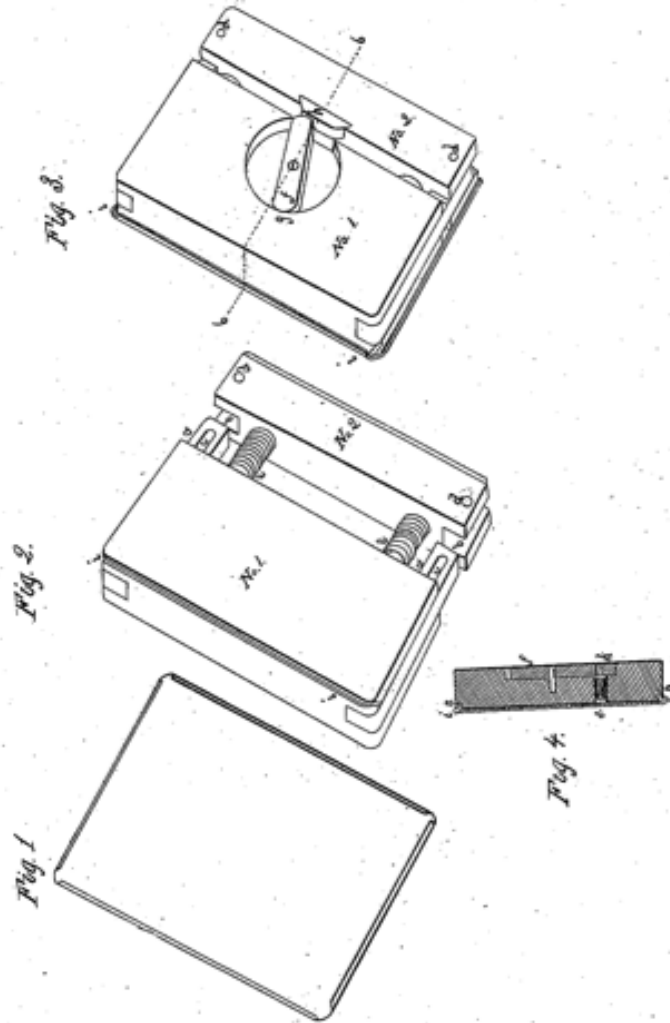

THE DODD PETERS CO., WASHINGTON, D. C.

UNITED STATES PATENT OFFICE.

SAMUEL PECK, OF NEW HAVEN, CONNECTICUT.

IMPROVEMENT IN HOLDING DAGUERREOTYPE-PLATES.

Specification forming part of Letters Patent No. 7,326, dated April 30, 1850.

To all whom it may concern:

Be it known that I, SAMUEL PECK, of the city and county of New Haven, and State of Connecticut, have invented a new and Improved Mode of and Instrument for Holding Daguerreotype-Plates while the Plates are being Polished, Burnished, or Buffed; and I do hereby declare that the following is a full, clear, and exact description of the construction and operation of the same, reference being had to the accompanying drawings, which make a part of this specification, in which—

Figure 1 is a perspective view of a daguerreotype-plate as prepared to be fastened on the holder. Fig. 2 is a perspective view of the upper side of the holder on which the plate is to be placed. The holder is shown in two parts, Nos. 1 and 2, in the position it assumes when the pins at the holes *d d* are removed and the spiral springs *e e* are extended. These pins are, however, never removed in actual use; but this position shows more completely all parts of the holder. Fig. 3 is a perspective view of the lower side or back of the holder in the position it assumes when a plate is fastened upon it to be polished, buffed, &c. Fig. 4 is a cross-section of the holder with the plate attached, the section being taken in the line *o o* of Fig. 3.

A section of the plate hooking over the corner of the holder is shown by the red line *i i*, Fig. 4. One of the springs is seen at *e*, a section of the button at *f*, and the projection on which the button rests at *h*.

n n is a strip of brass let into the corner of the holder to prevent wear by contact with the daguerreotype-plate.

The daguerreotype-plate is first prepared by bending over the edges toward the back from one-tenth to one-sixteenth of an inch, so as to form a catch, as shown in the drawings, Figs. 1, 3, and 4, at *i i*. This bending of the edge of the plate forms a catch for fastening it upon the holder and adds to the strength and stiffness of the plate itself.

The holder I construct of wood, with a strip of brass let into and forming the upper corner, as shown at *i i*, Fig. 2, so as to prevent wear by contact with the plate. The entire holder may be made of brass or any suitable metal. The construction and operation of the holder are shown in the drawings.

A a, Fig. 2, are square tenons projecting from the part No. 1 and fitted so as to play

back and forth closely but freely in the grooves *b b* of No. 2.

C c are mortises cut through the tenons *a a*. For the purpose of connecting the parts 1 and 2 together the tenons *a a* are pressed into the grooves *b b*, and pins passed through the holes *d d* and the mortises *c c*, as seen in Fig. 3. The length of the mortises regulates the lateral movement of the holder.

E e are spiral springs resting at each end in holes countersunk for that purpose, so as to press the holder open laterally till stopped (when the plate is off) by the pins through the mortises in the tenons at *d d*. When a plate is on the holder, as in Fig. 3, the pressure of the springs forces the holder open upon the bent corners of the plate, which rest in notches cut in the corners of the holders, as shown in Figs. 2 and 3 at *i i*. This notch is cut so that the edges of the plate hook into it when the plate is placed on the holder.

f, Fig. 3, represents a button, which works in a recess countersunk in the back of the holder secured by a screw in the center. When the plate is placed on the holder in the position just described, secured by the outward pressure of the springs, the button *f* is turned so as to rest one end upon the recess in the back of the holder at *g*, Fig. 3, the other upon the projection *h*. When the button is thus turned, the plate is firmly fastened to the holder by the outward pressure of the springs forcing the edge of the plate into the notch, as shown at *i i*, Fig. 3, while the holder is secured and prevented from being pressed together by the button resting one end at *g* and the other at *h*. To take off the plate, it is only necessary to turn the button and press the two parts of the holder together.

I use spiral springs, as shown in the drawings, as best to produce the outward pressure; but other than spiral springs may be used, or the springs may be dispensed with and a block or wedge inserted between the two parts of the holder.

What I claim as my invention, and wish to secure by Letters Patent, is—

1. The construction of a movable holder for securing daguerreotype-plates by pressure from within outward while the plates are being polished, burnished, buffed, or cleaned.

2. The construction or arrangement of a holder composed of two parts, with springs between the parts pressing them from within

2

7,326

outward against the bent edges or corners of the daguerreotype-plate, and secured from contraction by a button or wedge, substantially as in the drawings.

3. In combination with such a holder, the bending of the edges or corners of the plate, so as to secure the same to this holder.

4. The adaptation of a daguerreotype-plate with its edges or corners bent, as shown in

the drawings, to a movable holder constructed substantially as above described.

Dated originally at New Haven this 25th day of February, A. D. 1850. Amended and redated this 13th day of April, A. D. 1850.

SAMUEL PECK.

In presence of—

HENRY B. HARRISON,

LUCIUS G. PECK.

M. Finley,
Daguerreotype Plate-Holder,
Nº 10,093. Patented Oct. 4, 1853.

Fig. 1

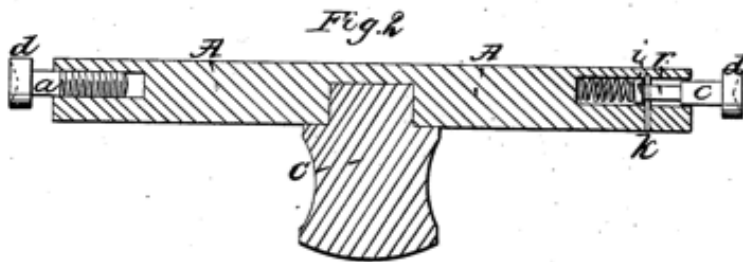
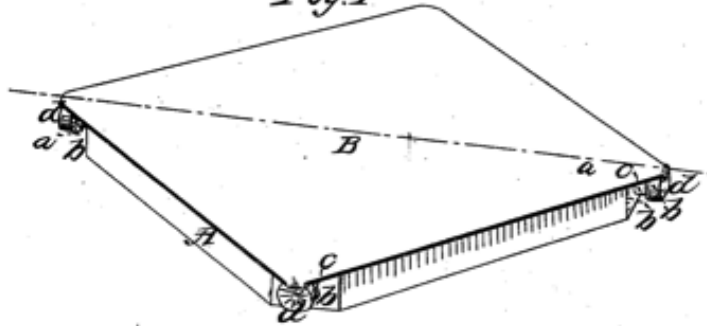

N. PETERS, PHOTO-LITHOGRAPHER, WASHINGTON, D. C.

UNITED STATES PATENT OFFICE.

MARSHALL FINLEY, OF CANANDAIGUA, NEW YORK.

IMPROVED DAGUERREOTYPE-PLATE HOLDER.

Specification forming part of Letters Patent No. 10,093, dated October 4, 1853.

To all whom it may concern:

Be it known that I, MARSHALL FINLEY, of Canandaigua, in the county of Ontario and State of New York, have invented certain new and useful Improvements in Apparatus called the "Daguerreotype-Plate Holder;" and I do hereby declare that the following is a full, clear, and exact description thereof, reference being had to the accompanying drawings, which form part of this specification, in which—

Figure 1 represents a perspective view showing the block or holder A, its beveled corners *b*, the pressing-screws *c*, the heads of which are made dishing or concave, and the plate in position with its four several corners clasping their corresponding screw-heads. Fig. 2 represents a vertical longitudinal section of the same with the plate removed for the purpose of showing more clearly its construction and operation.

To enable others skilled in the art to make and use my improved plate-holder, I will proceed to describe in detail the construction and operation of the same, which consists of a base or platform A, of suitable size and thickness, and usually in the form of a parallelogram. The four corners of this platform are beveled off, forming an oblong octagon, as represented in Fig. 1. Into two of these corners I insert in mortises of the required depth spiral springs *e e*, which constantly tend to force the pressers outward, as shown in Fig. 2. On the shank of each of these pressers is formed a wrist *r*, having on its end a head or cap *i*, the face of which is of the same size and is immediately in contact with the spring *e*. To prevent the spring from forcing the presser entirely out of its proper position, I insert through the platform A a key or pin *k* in such manner as to per-

mit the presser to move back and forth the required distance, but to prevent, by coming in contact with the shoulder formed by the cap *i*, all possibility of its becoming deranged. The head *d* of the presser may be more or less dishing or concave to suit different constructors, as represented in dotted lines, the object of which is to receive the corners of the plate B, which are necessarily bent or formed into the shape of hooks, grasping firmly the heads of the pressers or sliding screws, as shown in Fig. 1. Into the two opposite corners of the block or holder I insert adjustable screws *a*, with concave heads corresponding with their opposites, which admit of being set out or in to accommodate any variety in the size of the plate. In the center and on the under side of the platform is fitted a square stock or handle *c*, which is inserted into a socket prepared to receive it, for the purpose of holding the platform firmly while the plate is being buffed, or grasped by the hand in buffing the plate upon a wheel.

I do not claim holding daguerreotype-plates to be buffed by the outward pressure of spiral springs against the turned edges of the plate; but

What I do claim as new, and desire to secure by Letters Patent, is—

Constructing a sold daguerreotype-plate holder or block having fastenings at each corner made by spiral springs, in combination with tightening-bolts having concave heads, into which the bent or turned corners of the plate to be buffed are hooked so as to admit of a uniform buffing, as herein set forth.

MARSHALL FINLEY.

Witnesses:

JAMES G. MITCHELL,
SIMEON K. CUTLER.

C. W. Stimpson,
Vise for Photographic Plates,
Nº 10,433. Patented Jan. 17, 1854.

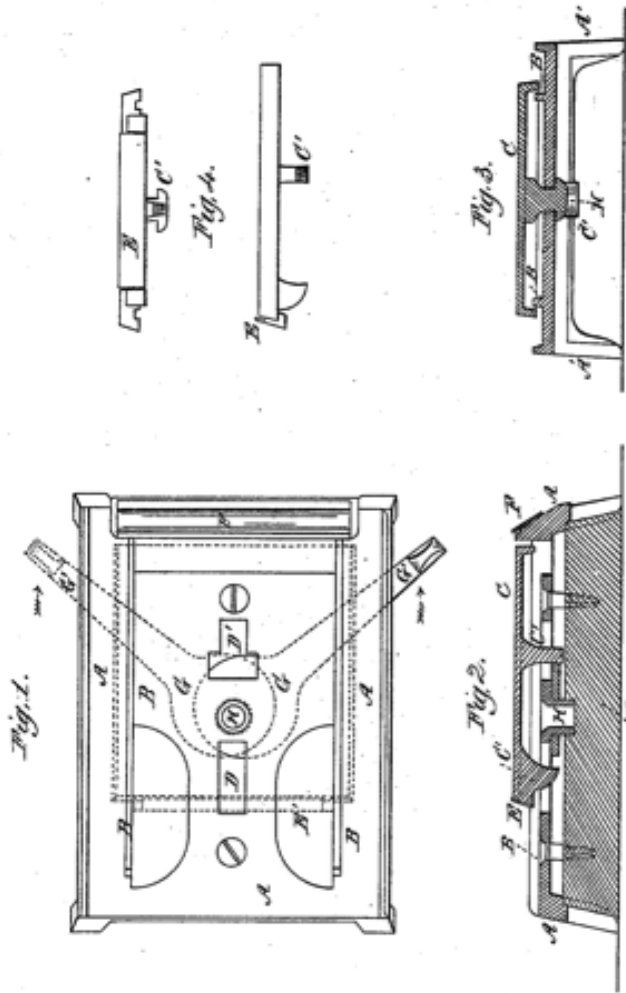

AM. PHOTO-LITHO. CO. N.Y. (SHEPHERD PROCESS)

UNITED STATES PATENT OFFICE.

C. W. STIMPSON, OF CLEVELAND, OHIO.

IMPROVED PHOTOGRAPHIC-PLATE VISE.

Specification forming part of Letters Patent No. 10,433, dated January 17, 1854.

To all whom it may concern:

Be it known that I, C. W. STIMPSON, of Cleveland, in the county of Cuyahoga and State of Ohio, have invented new and useful Improvements in the Construction of Plate-Vises for Photographic Use; and I do hereby declare that the following is a full, complete, and accurate description of the construction and operation of the same, reference being had to the accompanying drawings, and to the letters of reference marked thereon, like letters referring to like parts.

The nature of my invention consists in such a construction of the vise that all the surface of the plate is exposed to the action of the polishing wheel or buffer with no part of the instrument projecting above the surface of the plate, and so compact and complete within itself that it can be used in the hand upon a wheel or be fixed stationary to the bench.

I construct the vise of cast-iron or other suitable metal, the several parts being represented in Figures 1, 2, and 3.

Fig. 1 is a top view. Fig. 2 is a side view, and Fig. 3 is an end view.

The frame-work of the vise is shown by the letters *a a a*, &c., in the several figures. Its general figure is of a rectangular form. At the four corners there are feet, (marked *a' a'*), the space thus formed being filled with a piece of wood. On the top of the plate *A* near the sides are two elevations or ways running longitudinally and marked *B B*, &c., in the several figures. Upon these ways the carriage-plate *C* slides back and forth, and is indicated in its relative position by the red lines in Fig. 1. In Figs. 2 and 3 are seen a side and end view. In Fig. 4 the same plate is seen detached from the other parts. On the under side of this plate are two projections, (shown at *C' C'*, Fig. 4,) which pass through the slots *D D'*, Fig. 1. One of these projections has a *T*-head which passes under the plate *A* and serves to hold the carriage-plate *C* from rising out of its place. At the left-hand end of this plate, as seen in Fig. 2 at *E*, is a lip that projects about the thirtieth part of an inch above the face of the carriage-plate *C* and

extending nearly across the width of the plate, and is shown by the red lines at *E'*, Fig. 1, and also at *E*, Fig. 4. The use of this lip, which curves inward toward the plate *C*, is to clasp one end of the photographic plate while being polished, the other end of the photographic plate being secured in a like manner by a lip *F*, Figs. 1 and 2, attached to the right-hand end of the frame *A*. The distance between the lips *E* and *F* is regulated by means of a cam-lever *G*, Fig. 1. This cam *G* articulates upon the pin *H*, the eccentric circle resting against the projections *C' C'*. When the arm of the lever *G'* is moved to the right in the direction of the arrow, the lips *E* and *F* are brought nearer together by the sliding of the carriage-plate *C* on the ways *B B*, the cam or eccentric head of the lever being of such a form that it will set at any point, by which means a photographic plate is held firmly between the lips *E* and *F*, the under side of the plate resting firmly upon the upper side of the carriage-plate *C*. By a reverse movement of the lever *G'* the plate is released.

A number of carriage-plates *C*, varying in size to suit the several sizes of the photographic plates, may be fitted to each vise. These can be easily changed by bringing the lever to the extreme left in Fig. 1, when the *T*-head projection will pass through the slot *D'* and the carriage-plate can be removed and a larger or smaller one introduced.

This vise may be used upon a buff-wheel and held in the hand of the operator, or it may be firmly attached to a bench or table and used in the ordinary manner by hand without a wheel, as it serves either purpose equally well.

What I claim as my improvement, and desire to secure by Letters Patent, is—

1. The bed-plate *A*, with the ways *B B*, in combination with the carriage-plate *C*, with its projection, and *T*-head and lip *E*, operating in conjunction with the lip *F* upon the main frame *A*, the manner of securing the carriage-plate *C* to the ways *B B* by means of the slot and *T*-head and moving the same

backward and forward upon the ways BB by means of the eccentric or cam-lever in the manner specified.

2. The arrangement by which the carriage-plates can be changed from one size to another simply by bringing the lever-arm back to its farthest point to the left, or in the direction opposite to the course indicated by the arrow.

I disclaim the lips E and F and the cam-lever separately considered; but I do claim the several parts in combination, as herein set forth.

C. W. STIMPSON.

Witnesses:

JEHU BRAINEN,

GEORGE W. TIBBITTS.

P. H. BENEDICT.
DAGUERREOTYPE PLATE HOLDER.

No. 10,466.

Patented Jan. 31, 1854.

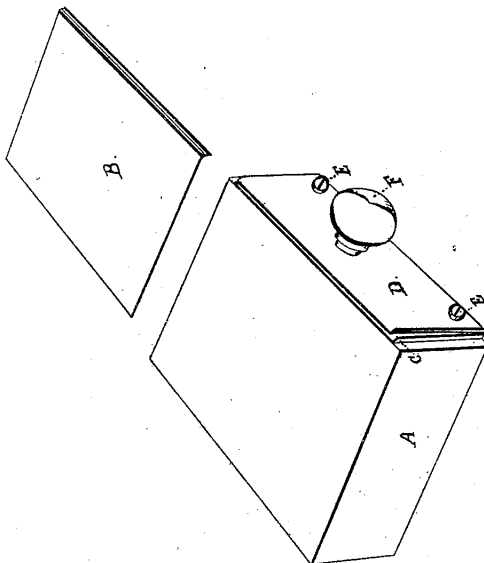

UNITED STATES PATENT OFFICE.

PHILANDER H. BENEDICT, OF SYRACUSE, NEW YORK.

LAGUERREOTYPE-PLATE HOLDER.

Specification of Letters Patent No. 10,466, dated January 31, 1854.

To all whom it may concern:

Be it known that I, PHILANDER H. BENEDICT, of the city of Syracuse, in the county of Onondaga and State of New York, have
5 invented a new and useful Improvement in
Devices for Holding Daguerreotype-Plates;
and I do hereby certify that the following
is a full, clear, and exact description of the
same, reference being had to the annexed
10 drawings, making part of this specification.

The nature of my invention consists in a
more convenient method than is at present
in use for holding daguerreotype plates
while they are being polished preparatory
15 to receiving the impression.

Construct a block (A) of wood of convenient size for holding the plate (B), and in thickness say one inch that it may be readily held by being screwed into an iron
20 vise. To one edge of the block (A) attach
an iron plate one sixteenth of an inch in
thickness, having its upper and outer edge
rounded as shown at (C). To the plate C
attach another iron plate (D) by means of
25 screws (E) near its lower edge holding the
plate loosely so as to admit of the two iron
plates being separated at their upper edges
after the manner of a vise. Through the
middle part of the plates (C and D) make
30 a hole for the passage of a screw (F) which
works into a nut inserted into the block.
The vise plates may be made of any suitable

metal, with such dimensions as may be
requisite according to the size of the plate
to be polished. The upper edge of the plate
35 (D) should be curved so that its inner surface
will be adapted to the rounded corner
of the inner plate.

The operation of my invention is as follows: Place the block (A) firmly in a vise.
40 Place the bent edge of the plate to be polished
between the upper edges of the plates
(C and D) and close them upon it by the
screw (F), the under surface of the plate
(D) in contact with the upper surface of the
45 block A.

The block (A) may be made of wood, or
it may be made of metal, the outer plate of
the vise acting against the side of the block
instead of the inner plate as first described.
50

What I claim as my invention, and desire
to secure by Letters Patent, is—

The arrangement of a vise, or analogous
device, upon the side or edge of blocks used
for holding daguerreotype plates while they
55 are being polished or buffed, the vise constructed
substantially as set forth, and operating
by holding the bent edge of the
plate between its jaws.

PHILANDER H. BENEDICT.

Witnesses:

S. C. WRIGHT,
RICHD. F. STEVENS.

R. Knecht,

Daguerreotype Plate-Holder.

Patented Feb. 7, 1854.

N^o 10,508.

Fig. 1.

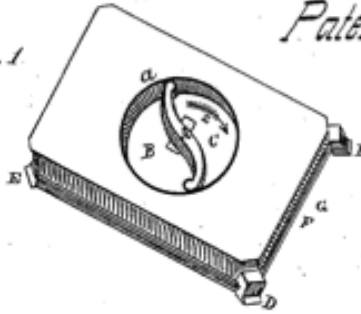

Fig. 2.

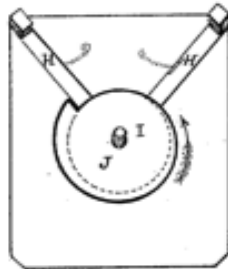

Fig. 3.

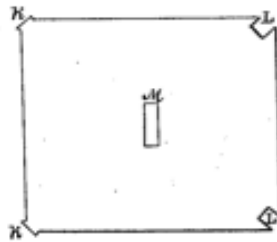
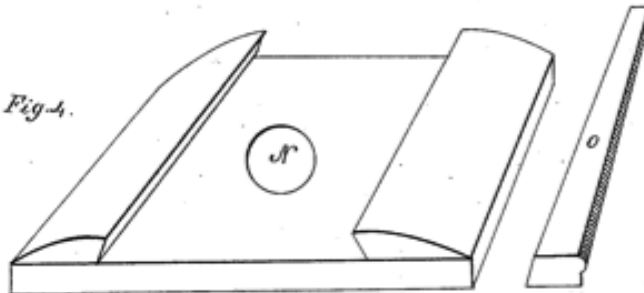

Fig. 4.



Witnesses

Inventor

UNITED STATES PATENT OFFICE.

REUBEN KNECHT, OF EASTON, PENNSYLVANIA.

IMPROVED DAGUERREOTYPE-PLATE HOLDER.

Specification forming part of Letters Patent No. **10,508**, dated February 7, 1854.

To all whom it may concern:

Be it known that I, REUBEN KNECHT, of the borough of Easton, in the county of Northampton and State of Pennsylvania, have invented a new and Improved Mode of Holding Daguerreotype-Plates for Cleaning and Polishings; and I do hereby declare that the following is a full and exact description thereof, reference being had to the accompanying drawings and letters of reference thereon.

The nature of my invention consists in providing two corners of the holder with two movable arms which are projected by an eccentric wheel turned by a swivel and providing the holder with an oblong aperture for the shaft of the eccentric wheel to move to one side or the other, according as one or the other of the arms require a further projection.

To enable others skilled in the art to make and use my invention, I will proceed to describe its construction and operation, reference being had to the annexed drawings, making a part of this specification, in which—

Figure 1 is an inverted view showing the swivel and the arms projected. Fig. 2 is a plan view of the arms and eccentric wheel with its upper shaft. Fig. 3 is a plan view of the surface of the holder and the oblong aperture, and in which Fig. 4 is a perspective view of the block and key for fastening the holder.

The part marked A represents the swivel, constructed of iron or other material, for turning the eccentric wheel J, to which it is attached; B, the oblong aperture for allowing the shaft I of the eccentric wheel J to move toward either side of the holder; C, a circle of such diameter that the swivel A may revolve within it, and the wood within the circle excavated of such depth that the swivel A and the adjoining wood *a* will form a level plane; D D, the ends of the arms as they appear when projected; E, one of the prominences of the part of the holder represented by F F; F F, that part which is attached by screws or otherwise to G G and forms a level plane and the surface of the holder, as represented in Fig. 3; G G, that part of the holder in the excavated circle C of which the swivel A turns, and in which on

its opposite side to the swivel A the eccentric wheel J and the arms H H are embedded to the depth of their own thickness, and through which the oblong aperture B is made, and the edges of which part are grooved for the purpose of fastening it into the block represented in Fig. 4; H H, the surface of each arm, which are placed diagonally and embedded in the wood; J, the surface of the eccentric wheel, its body being also embedded in the wood; I, the shaft of the eccentric wheel J, which turns and moves in the oblong aperture M in Fig. 3; K K, a plain view of both prominences of F F in Fig. 1, one which appears and is designated as E in said figure; L L, notches in the corners of F F aforesaid, so as to admit the arms to be thrown inward, and so that the surface of the thick part of the arms (which are thicker at their ends than elsewhere) and the surface of F F aforesaid or the surface of the holder will form a level plane; M, the oblong aperture in F F aforesaid, and in which the shaft I turns and moves; N, the head of a large screw embedded to the depth of its own thickness in the block, which screw extends through the bench or whatever the block may be placed upon for use. The lower end of this screw is fastened by a hand-bar, and by slightly unscrewing the hand-bar the block may be turned in any direction desired; O, the key for fastening the holder in the block represented by Fig. 4. One block suffices for all-sized holders. A small holder may be placed in the block lengthwise, a larger size sidewise, and when the holder is still larger a grooved frame-work of about the size or somewhat larger than and corresponding with G G in Fig. 1 may be placed upon the holder, in which case it is not necessary that the swivel A be inserted in the wood, as in the drawings.

The dotted lines 1 1 in Fig. 2 represent springs which throw the arms H H inward when the swivel A is unturned, which springs may or may not be applied, as they enhance the cost without adding materially to the value of the holder.

The arms H H, the eccentric wheel J, the shaft I, the swivel A, and F F, or Fig. 3, I construct of iron or other material that may answer the same purpose. The remaining part I construct of wood.

In order to fasten the daguerreotype-plate to the holder for cleaning and polishing or other purpose, I clip a small piece from each corner of the said plate, as usual, and then bend down the corners, so as to form a hook at each corner. I then place the two prominences K K of the holder, one of which is seen and designated as E in Fig. 1, into two of the hooks of the plate, and then by turning the eccentric wheel J from me by means of the swivel A, the two arms D D are projected and pass into the two remaining hooks of the plate and remain firm and stationary by its own friction. By reversing the motion of the swivel the arms D D pass inward and the plate is readily removed. The projection of the arms D D or H H is effected by the radius of the eccentric wheel J, gradually increasing as the swivel A is turned from me. The object of the oblong apertures B and M,

in which the shaft I and its opposite one work, is to allow the eccentric wheel to shift to one or the other of the sides, according as one or the other of the arms require a further projection.

What I claim as my invention, and desire to secure by Letters Patent, is—

The application of the eccentric wheel J to the projection of the arms H H or D D, which is effected by turning the swivel A, which is firmly attached to the wheel aforesaid in the direction of arrow 2, and the application of the oblong aperture B to the projection of either arm D D, according as one or the other of the arms require a further projection, for the purposes above particularly described.

REUBEN KNECHT.

Attest:

G. W. STOUT,
WM. J. BROWNE.

J. Hill,

Daguerreotype-Plate Holder,

N^o 11,565.

Patented Aug. 22, 1854.

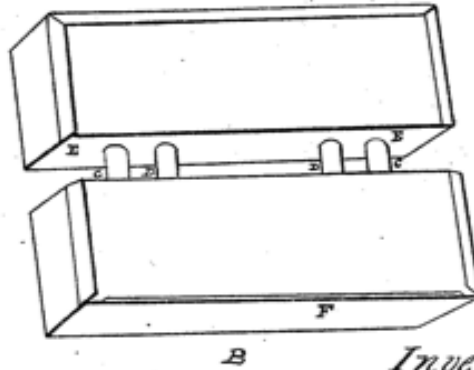
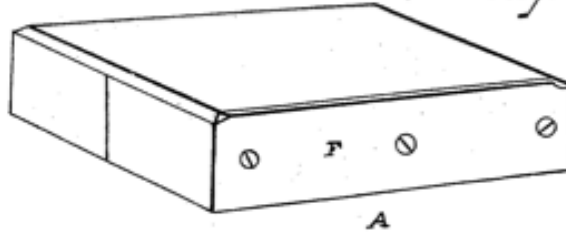

Witnesses.

H. H. Jewett.
H. L. Bean.

Inventor.

Joseph Hill.

UNITED STATES PATENT OFFICE.

JOSEPH HILL, OF SKANEATELES, NEW YORK.

IMPROVED DAGUERREOTYPE-PLATE HOLDER.

Specification forming part of Letters Patent No. **11,565**, dated August 22, 1854.

To all whom it may concern:

Be it known that I, JOSEPH HILL, of Skaneateles, in the county of Onondaga, State of New York, have invented a new and Improved Mode of Confining or Holding Daguerreotype-Plates while in the Act of Burnishing or Polishing them; and I do hereby declare that the following is a full and exact description.

The nature of my invention consists of providing blocks of a width and length equal to any size of daguerreotype-plates used.

The drawing filed herewith, signed by me, contains views of the block and its several parts, as follows:

A represents the block with the plate confined on it, ready for burnishing or polishing.

B represents the block extended to receive the plates, showing the separation of the block at E, the springs D D, and dowel-pins C C. The retaining force is caused by the springs D D, made of india-rubber, gutta-percha, composition, or any metallic substance fastened firmly to the separated portions of the block, and when unrestrained and at rest by their inward pressure keeping the separated portions of the block closely together at E. The daguerreotype-plates are

confined to the blocks by metallic plates being fastened on the edges of the blocks, as shown at F, and rising to a proper height above the surface of the block, so as to catch the edge of the daguerreotype plates and at the same time not to come in contact with the buff-wheel or polishing-surface. The edges of the block are slightly beveled to assist in retaining the daguerreotype - plates. The dowel-pins C C are used to keep the separated portions of the blocks in a true position to each other.

What I claim as my invention, and desire to secure by Letters Patent, is—

The application of the inward pressure by means of the springs by their force retaining the daguerreotype-plates to the block by the contact of the daguerreotype-plates with the plates on the edges of the block.

It is understood that the daguerreotype-plates may be confined by their ends as well as sides by the same principles. Blocks may be made of any substance.

JOSEPH HILL.

Witnesses:

W. H. JEWETT,
H. L. BEAN.

D. N. B. Coffin, Jr.,
Daguerreotype Plate-Holder,
No. 12,314, *Patented Feb. 6, 1855.*

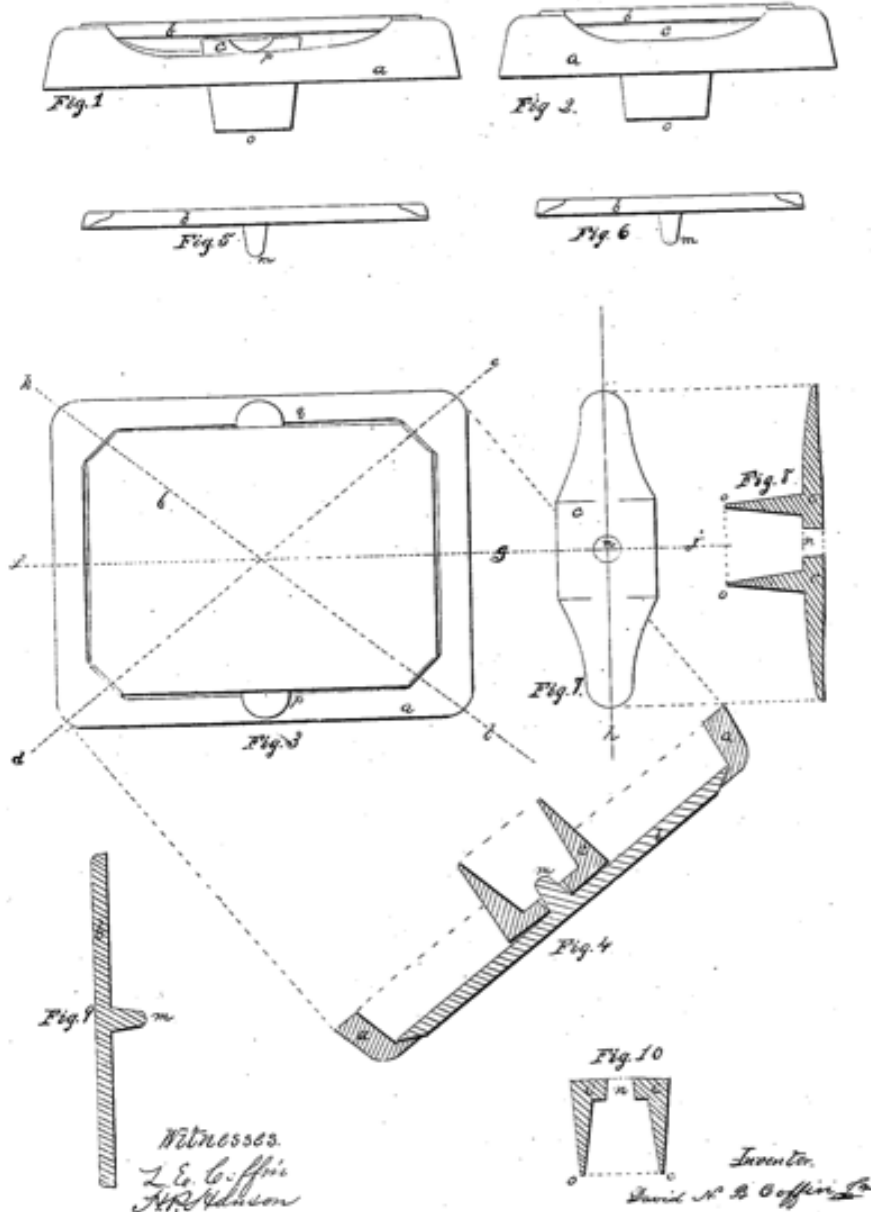

Witnesses.
L. E. Coffin
J. R. Hanson

Inventor.
David N. B. Coffin, Jr.

A. PETZEL, PHOTO-LITHOGRAPHER, WASHINGTON, D. C.

UNITED STATES PATENT OFFICE.

DAVID N. B. COFFIN, JR., OF LYNN, MASSACHUSETTS.

IMPROVED DAGUERREOTYPE-PLATE HOLDER.

Specification forming part of Letters Patent No. 12,344, dated February 6, 1855.

To all whom it may concern:

Be it known that I, DAVID N. B. COFFIN, Jr., of Lynn, in the county of Essex and State of Massachusetts, have invented a new and useful Device for the Purpose of Holding Daguerreotype-Plates while they are being Buffed, Polished, &c.; and I do hereby declare that the following is a full, clear, and exact description of the construction and operation of the same, reference being had to the annexed drawings, making a part of this specification, in which—

Figure 1 is a side elevation. Fig. 2 is an end elevation. Fig. 3 is a plan. Fig. 4 is a section through line *k l*. A section through line *d e* would be truly represented by the same. Fig. 5 is a side elevation of the block *b*. Fig. 6 is an end elevation of the same. Fig. 9 is a section of the same block through line *f g*. Fig. 7 is a plan of bed-piece *c*. Fig. 8 is a section of the same through line *h i*. Fig. 10 is a section through line *g j*.

Like letters indicate the same parts in all the figures.

This device consists of a block *b*, the frame *a*, and the bed-piece *c*. The block *b* is made about the same length and width as the plate which is to be held, and is provided with a pin *m* at its center, about which the bed-piece *c* turns. The plate is held upon this block by the frame *a*, as follows: The projecting part within the corners of the frame *a* overlap the corners of the plate and draw them against the depressed corners of the block. The frame is made to act on the corners of the plate and force them to conform to the space between the projections within the corners of the frame, and the depressed corners of the block by the force of the hand

or by the action of the bed-piece, which action is as follows: After the plate is placed on the block and the frame slipped on, over, and around it the bed-piece is slipped onto the pin *m* in such position that its ends may pass within the frame. Then the bed-piece is turned, or the block and frame may be turned with the same effect so as to cause the ends of the bed-piece to pass between the frame and the block and the surface of that part of the frame at *p* and *q* with which the ends of the bed-piece come in contact is inclined to the surface of the block, so that as the bed-piece turns its ends pass up the inclines *p* and *q* and the block is pressed farther into the frame, and so held there, and the friction will not allow the ends of the bed-piece to slide back on the inclines *p* and *q*, for they are but slightly inclined to the surface of the block. The bed-piece has a part *o*, which may be used as a handle or as a dowel, by which the whole may be secured to the bench.

The parts may be made of cast-iron or any other suitable material.

The device is useful because more simple and effectual than others. It also presents the surface of the plate to be polished more even and fairly than others.

I claim—

The peculiar combination and arrangement, substantially as herein described, of the block-frame and bed-piece, for the purposes specified, the same being constructed and operated substantially as set forth.

DAVID N. B. COFFIN, JR.

Witnesses:

Z. E. COFFIN,
H. P. HANSON.

D. Shive,
Daguerreotype-Plate Holder.
N^o 13665. Patented Oct. 9, 1855.

Fig: 1.

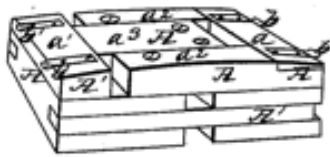

Fig: 2.

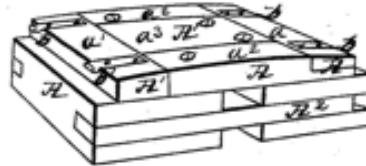
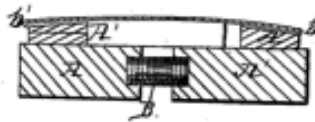

Fig: 3.



Witnesses:
Orin Morrison
Charles S. Peeman

Inventor:
David Shive

UNITED STATES PATENT OFFICE.

DAVID SHIVE, OF PHILADELPHIA, PENNSYLVANIA.

DAGUERREOTYPE-PLATE HOLDER.

Specification of Letters Patent No. 13,665, dated October 9, 1855.

To all whom it may concern:

Be it known that I, DAVID SHIVE, of the city of Philadelphia and State of Pennsylvania, have invented a new and useful Improvement in Daguerreotype-Plate Holders; and I do hereby declare that the following is a full, clear, and exact description of the construction and operation of the same, reference being had to the accompanying drawings, making a part of this specification, in which—

Figure 1, is a perspective view, showing the holder opened to the position required for receiving the plate; Fig. 2, a like view of the same previous to its being so opened; and Fig. 3, a transverse vertical section of the same (containing the plate) through the middle, showing one of the three spiral springs which tend to keep the holder closed, and cause it thus to clasp the plate by its edges when it is placed between the hooks attached to the top and projecting from the sides of the holder, like letters indicating the same parts when in the different figures.

The nature of my invention consists in so constructing a two-part daguerreotype plate holder, and combining together the several pieces forming the same, that by simply grasping or pressing firmly with one hand, the two opposite lower sides or edges thereof, the two parts are caused to slide within each other (their upper sides overlapping) so as to cause the two parts to separate on the upper side of the holder, sufficiently to admit of a daguerreotype plate being laid thereon by the other hand, between hooks which are attached to and project from the two opposite sides or edges of the plate, and so that when the pressure of the grasping hand is relaxed, the said separated parts on the top, by the expansive force or pressure of two or more springs fixed between the parts, beneath the upper side, the said separated parts are caused to return toward each other, so that the said hooks, attached and projecting from the two opposite sides, catch on the edges of the plate and hold it firmly down upon the upper side of the holder, thus avoiding the necessity of touching the polished surface of the plate, by the hand or fingers, (an objection incident to almost all other daguerreotype plate holders,) and thus also

avoiding the necessity of bending down small portions of the edges of the plate, as required for the improved holder patented by Samuel Peck, April 30/50.

Referring to the drawings, A, A, are the two parts of the holder, each part being composed of the several pieces so arranged, combined and interlaced with each other, that when the two parts are pressed together by the hand, the two outer overlapping pieces (a, a') on the upper side, and which are provided with the hooks ($b, b,$ and $b' b'$), separate or move outwardly, so as to admit of placing the daguerreotype plate thereon and between the said hooks.

Beneath the intersliding pieces (a^2, a^3) two or more spiral springs (B) are fixed, so as to tend continually to keep the two parts (A, A) separated at the lower part of the holder, and together or in contact at their inner edges on the face or upper side—the top pieces of each part overlapping the middle pieces of each other, and being held in place so as to slide in opposite directions with each other, without losing the parallelism which the two parts (a, a') have in relation to each other.

The hooks ($b b'$) are made of thin or sheet trap, and so bent and secured to the pieces ($a' a$) as to catch upon the edges of the plates without projecting above the surface of the same, so as to leave an even, unobstructed, and slightly arched or curved form to the surface of the plate holder, as shown in the drawings. The spiral springs (B) are secured by their ends being let into shallow holes made on the inner sides of the two parts of the holder as shown in Fig. 3.

Operation: The device being held between the fingers and the base of the thumb of one hand, by grasping it below the hooks (b, b'), the operator presses the two parts of the lower side toward each other, thus causing the overlapping pieces (a, a') with the hooks (b, b') attached thereto, to recede from each other, when, with the thumb and fingers of the other hand holding the plate by its edges, he places it on the face of the holder, and relaxing the pressure on the sides of the holder, the springs (B) force the lower parts from each other, thus causing the overlapping pieces to approach toward each other until the hooks (b, b')

catch upon the edges of the plate, thus securing the same firmly down upon the slightly curved face of the holder, when it becomes ready for placing in the polishing
5 machine.

The utility and superior advantages of my invention, in comparison with others heretofore used or known, are shown in the facts, that the action of the holder upon
10 the plate causes it to receive a slightly curved or arched form upon its faced surface or side, which is especially advantageous in the process of polishing, and in not requiring small portions of the edges
15 of the plate to be bent down so as to secure it to the holder, thus avoiding a very objectionable requisite in the two part holder of Mr. Peck, and also in the fact that the plate can be readily attached to, and separated from my improved holder, without
20 touching the surface of the same; an objection especially incident to the use of holders generally used, and finally in the greater convenience in using (being operated by one hand) and in the general adap-

tation of my invention for the purposes required in a daguerreotype plate holder.

I do not claim a two-part daguerreotype plate holder; nor do I claim actuating the two parts by means of springs and the
30 force of the hands, but

What I claim as my invention and desire to secure by Letters Patent is—

A daguerreotype plate holder so constructed that when its under side is compressed
35 by the hand of the operator as described, its upper side shall expand so as to admit of the plate being placed between the hooks (*b b* and *b' b'*) thereon, and so that when the pressure of the hand is relaxed, the said
40 upper side shall contract, causing the hooks (*b, b,* and *b' b'*) to catch upon the outer edges of the plate and hold it firmly upon the face of the holder, substantially as described and set forth.

DAVID SHIVE.

Witnesses:

BEN. MORRISON,
CHARLES D. FREEMAN.

S. S. Day,
Daguerreotype Plate-Holder,
N^o 13,701. Patented Oct. 23, 1855.

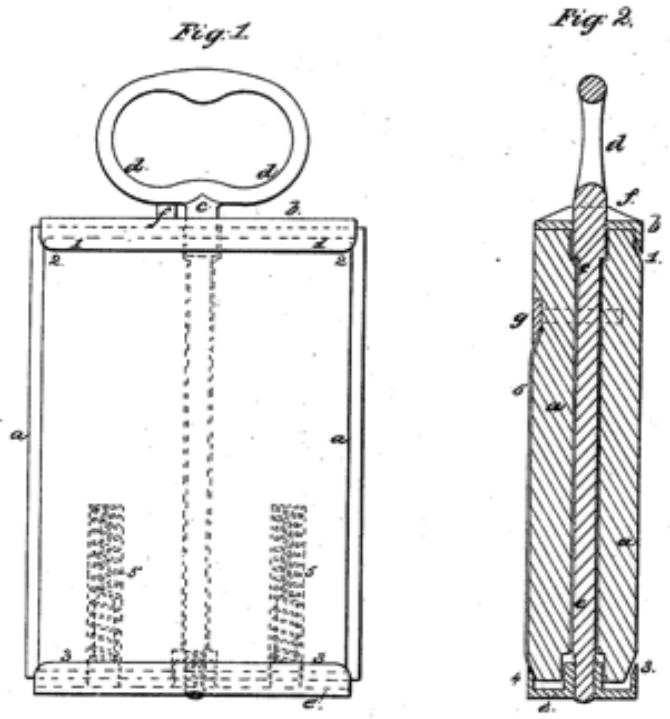

Witnesses:
Samuel M. Sewall
Thomas G. Karold

Inventor:
S. S. Day

AM. PHOTO-LITHO. CO. N. Y. (SHERMAN'S PROCESS)

UNITED STATES PATENT OFFICE.

SAMUEL S. DAY, OF NEW YORK, N. Y.

IMPROVED DAGUERREOTYPE-PLATE VISE.

Specification forming part of Letters Patent No. 13,701, dated October 23, 1855.

To all whom it may concern:

Be it known that I, SAMUEL S. DAY, of the city, county, and State of New York, have invented, made, and applied to use certain new and useful Improvements in Daguerreotype-Plate Holders; and I do hereby declare that the following is a full, clear, and exact description of the construction and operation of the same, reference being had to the annexed drawings, making part of this specification, wherein—

Figure 1 is a side elevation, and Fig. 2 is a longitudinal section, of my improved plate-holder.

The same parts are referred to by similar letters in each figure.

The nature of the said invention consists in the use of a clamp actuated by the combined operation of a screw-rod and cam-piece, whereby the screw on the rod furnishes the means for holding plates slightly varying in size, while the cam-piece, acting on the screw-rod as the same is turned, becomes a ready means for clamping the plate to the holder or releasing the same therefrom.

In the drawings, *a* is a block which I prefer to be of wood, having a metal end *b* and lip 1 formed thereon, which lip is level, or nearly so, with the face of the block *a*, and said block *a* is removed beneath the edge of the lip 1, so as to form a groove, into which one end of the plate is to be entered, as at 2 2, Fig. 1.

c is a metal rod passing through the end *b* and block *a*, and formed with a bow or handle *d* at one end, and the other end has a screw-thread cut thereon, which enters a nut on the movable end or clamp *e*, that is provided with lips 3 4 on its sides similar to the lip 1, and also with steady-pins running into holes in the ends of the block *a*, around which are helical springs tending to force said clamp *e* away from the block *a*. (See dotted lines at 5 5, Fig. 1.) The daguerreotype-plate to be held while being buffed or polished is entered at one end beneath the lip 1 and the other end pressed to the block *a*, so that the lip 3 of the clamp *e* can be drawn by means of the bow *d* over the same to hold the plate in place and to retain the bow *d* and clamp *e*. I make use of a beveled or cam-shaped piece

f, attached to the end *b*, over which one side of the bow *d* is turned, and should the plate not be held sufficiently tight the rod *c* is to be screwed into the clamp *e*, which tightens the lip 3 in its hold on the plate, and when the plate is to be removed by simply giving the bow *d* and rod *c* a quarter-turn the bow is removed from over the cam-piece *f*, and the springs throw the clamp *e* sufficiently away from the end of the block *a* to allow the plate to be removed.

In order to adapt my holder to two sizes of plates, I attach on one side thereof a strip of metal *g* with a lip formed beneath its edge, so as to receive a smaller plate 5 between said lip and the lip 4 on the clamp *e*, the same being held by the rod *c*, bow *d*, and cam-piece *f*, as before described.

In buffing or cleaning daguerreotype-plates the greatest difficulty arises in bringing the middle part of the plate to the requisite polish, because several of the holders tend to depress the middle and elevate the edge of the plate; but the reverse is the case with my holder, for although the block *a* is to be level the lips coming over the edge or ends of the plate act to spring up the center. Thereby the operation of cleaning is more perfectly performed, and it will also be seen that my holder is adapted to two or more sizes of plates. Thereby the number of holders used in a daguerreotype establishment can be proportionately decreased, and the holder is adapted to any slight variation in the size of the plate. The construction is simple and cheap and very convenient and efficient in its operation.

What I claim, and desire to secure by Letters Patent, is—

The combination of the clamp *e* with the screw-rod *c*, bow *d*, and cam-piece *f*, to hold the daguerreotype-plate between and beneath the lips 1 and 3 or 4 and *g*, in the manner and as specified.

In witness whereof I have hereunto set my signature this 27th day of September, 1855.

S. S. DAY.

Witnesses:

LEMUEL W. SERRELL,
THOMAS G. HAROLD.

Appendix C

US Patents Related to Daguerreotype Plate Polishing Polishing Machines

J. Johnson, ^{2 Sheets-Sheet 1.}
Polishing Metal Plates.
N^o 2,391. *Patented Dec. 14, 1841.*

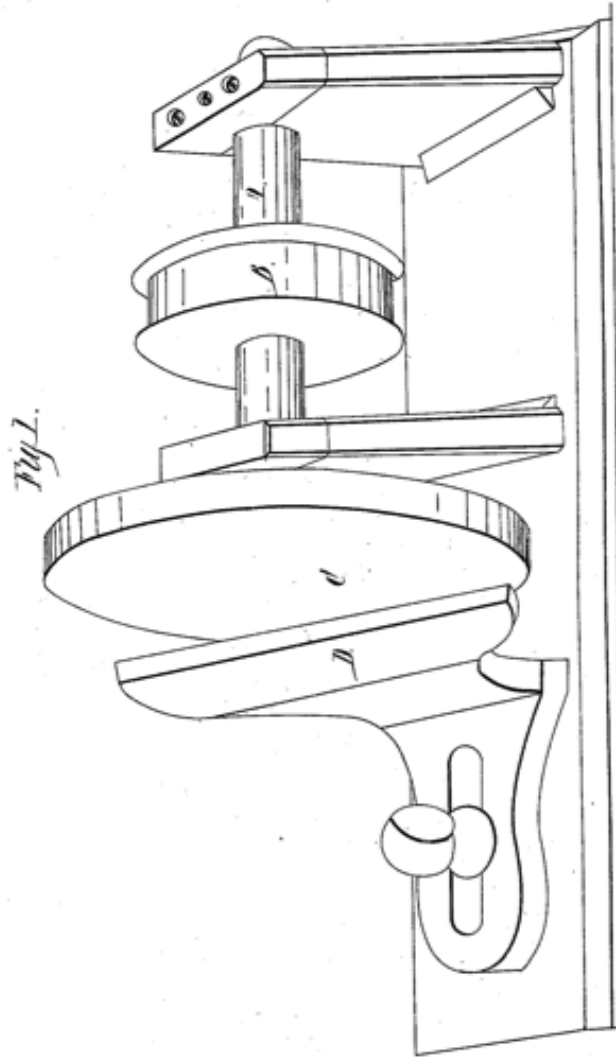

K. PETER, PHOTO-LITHOGRAPHE, WASHINGTON, D. C.

2 Sheets-Sheet 2.

J. Johnson,

Polishing Metal Plates.

No 2,391.

Patented Dec. 14, 1841.

Fig 4.

Fig 5.

Fig 2.

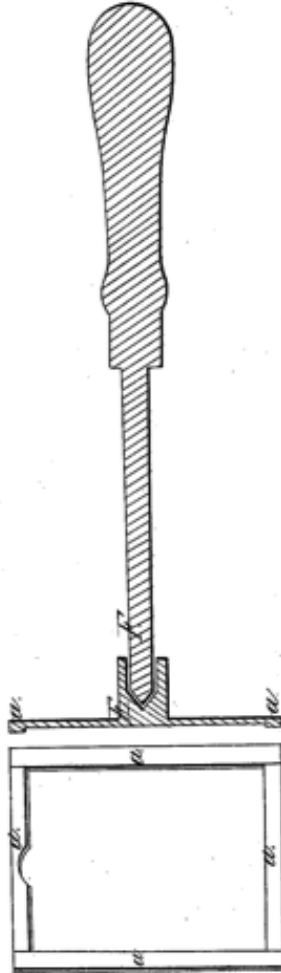

W. PETERS, PHOTO-LITHOGRAPHER, WASHINGTON, D. C.

UNITED STATES PATENT OFFICE.

JOHN JOHNSON, OF NEW YORK, N. Y.

APPARATUS FOR POLISHING THE PLATES USED IN TAKING LIKENESSES FOR OTHER OBJECTS IN WHICH SUCH PLATES ARE REQUIRED.

Specification of Letters Patent No. 2,391, dated December 14, 1841.

To all whom it may concern:

Be it known that I, JOHN JOHNSON, of the city of New York, in the State of New York, have invented a new and useful Improvement in the manner of and apparatus for polishing the plates used in taking daguerreotype likenesses or other pictures of a like kind and which apparatus and manner of procedure may be applied to the polishing of other articles; and I do hereby declare that the following is a full and exact description thereof.

The polishing of the metallic plates, is to be effected by means of a flat disk, attached to the mandrel of a lathe, or to a spindle or mandrel made for the purpose, and running in the manner of a lathe mandrel; for plates of the size ordinarily used for daguerreotype likenesses, a disk of five or six inches in diameter, is sufficiently large; but for larger plates the size must be correspondingly increased. These disks are converted into polishing buffs, by covering them with cotton velvet, corkwood, leather, or other suitable material, which may be charged with pumice-stone, rotten-stone, rouge, powdered charcoal, or other polishing substance. So far there is not anything new in the apparatus used by me; the novelty consisting in the manner in which the plate to be polished is held against the polishing disk, or buff. In this operation I use a flat piece of metal or other suitable substance a little larger than the plate to be polished, and around the edge on one face of this I affix a ledge or rim, within which the plate is to be received, said ledge not rising as high as the thickness of the plate to be polished; this instrument I will call my plate holder. On the other side of this plate holder and at its center I affix a socket of metal, which is to receive a pointed wire or rod, upon which it may revolve, said wire, or rod, being furnished with a suitable handle. At the front of the polishing buff I place a rest, upon which to sustain the rod or wire and upon this it is to be moved back and forth, so as to vary its distance from the center of the buff. The plate to be polished being held against the buff, by means of this apparatus, and the spindle being rapidly turned, the plate also

will revolve rapidly, and by this motion and by the gradual shifting of the rod toward and from the center of the buff, the polishing will be effected in a very short space of time, and that without the producing of lines upon the face of the polished metal, which can scarcely be avoided in any of the ordinary modes of procedure, while at the same time the polishing is performed with much greater rapidity than in any other way.

In the accompanying drawing Figure 1, represents the spindle, buff, and rest; A being the spindle, furnished with a whirl B. The buff is shown at C, and the rest in the front of it at D. Fig. 2, represents the face of my plate holder, surrounded by ledges *a a*. Fig. 3 is a section through the middle of said plate holder; E, being the socket which is to receive the point F, of the wire or rod, Fig. 2.

The operation of this apparatus will be similar to that of Bogardus' eccentric mill, but it differs from it both in the object for which it is employed and in the means of employing it; the object being to operate upon one of the revolving bodies, and the difference in the means consisting in the rendering of the body, or plate, to be acted upon capable of being shifted toward and from the center of the buff or operating disk.

Having thus fully described the nature of my invention and the manner of carrying the same into operation, what I claim therein as new, and desire to secure by Letters Patent is —

The polishing of metallic plates for daguerreotypes or other purposes, by means of an instrument such as I have denominated a plate holder in combination with a wire or rod, received within a socket upon which the said plate holder, and the contained plate, may revolve when held against a polishing disk or buff; and by which it may be shifted toward or from the center of said buff, the whole apparatus being arranged combined, and operating, substantially as herein set forth.

JOHN JOHNSON.

Witnesses:

THOS. P. JONES,
M. JONES,

Southworth & Hawes

Daguerreotype-Plate Holder.

N^o 1,573.

Patented June 13, 1846.

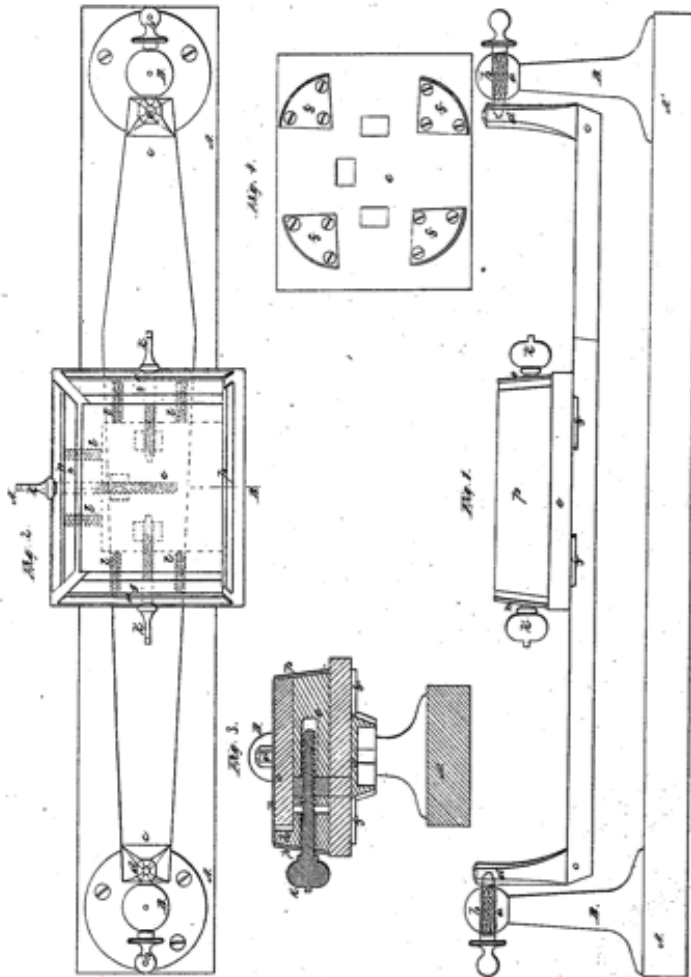

AM. PHOTO-LITHO. CO. N.Y. (STORRE'S PROCESS)

UNITED STATES PATENT OFFICE.

ALBERT S. SOUTHWORTH AND JOSIAH J. HAWES, OF BOSTON, MASSACHUSETTS.

IMPROVEMENT IN APPARATUS FOR HOLDING PLATES FOR POLISHING.

Specification forming part of Letters Patent No. 4,573, dated June 13, 1846.

To all whom it may concern:

Be it known that we, ALBERT S. SOUTHWORTH and JOSIAH J. HAWES, both of Boston, in the county of Suffolk and State of Massachusetts, have invented a new and useful apparatus for holding the plates used in the photographic art and by engravers and such metallic or other kind of plates as required to be held firmly during the process of polishing their surfaces, which apparatus we call the "self-regulating suspension plate-holder;" and we do declare that the following description, taken in connection with the accompanying drawings, hereinafter referred to, forms a full and exact specification of the same, wherein we have set forth the nature and principles of our said invention, by which it may be distinguished from others, together with such parts as we claim and desire to have secured to us by Letters Patent.

Metallic plates have heretofore during the process of polishing their surfaces been held down upon blocks or bed-pieces by clamps fitted round the edges of said blocks and which come over and bear down upon the top surfaces of the plates. This arrangement materially obstructs the process of polishing and frequently injures the buffing-sticks, which are covered with leather or cloth or some other similar substance. It has long been an object with those who use and those who polish plates to obviate these defects and also to suspend the plate-holder or block so that when touched by the polishing-tools the plate on the holder shall adapt itself oppositely and flatly to such tools. These results are completely effected in our new apparatus, in which the block or plate-holder is made with three adjustable sides, which, with the the back side of the block, are faced with metallic or other suitable plates, and all of which latter plates are set at an obtuse angle with the top surface of the block or plate to be polished. The tops of these side and back plates set angularly, as described, and project sufficiently above the top surface of the block to bite or bear against the four edges of the plate to be polished, taking in only about half the thickness of said plate from the bottom, so that when the three adjustable side plates are screwed up against the edges of the plate on the block (as will be explained in the se-

quel) the top surface of said plate will be entirely free from all obstructions to the operations of the polishing-tools. In order to have the plate adjust itself, as it were, to the faces of the polishing-tools when touched by them, the block on which the plate is confined, as above stated, is arranged so as to be easily adapted to and confined on a suspended bar which vibrates freely on its pivots or supports when the polishing-tool is applied to the plate.

The figures of the accompanying plate of drawings represent our new plate-holding apparatus.

Figure 1 is a front elevation of said apparatus. Fig. 2 is a plan, the plate to be polished being removed and the side bearing-plates unscrewed, some of the hidden parts being shown in this figure by dotted lines. Fig. 3 is a transverse vertical section taken in the plane of the line A B, Fig. 2.

A' A' is a wooden platform, which may be screwed or otherwise secured to a bench or table.

B B are two metallic standards, which are firmly secured at their bases to the platform A A, near each end of the same.

In the tops of the standards B B suitable female screws *a a* are formed, in which the male screws of the pivots *b b* work in the usual manner and as shown by dotted lines in Fig. 1. From the ends of these pivots *c c*, working in the standards B B, as described, is suspended the bar *c c* by means of its upright arms *d d*, arranged at each end of said bar, which arms have suitable holes in their sides near their tops, in which the pivots *b b*, fit, as shown in Fig. 1, so that the bar *c c* may be vibrated freely when any force is applied to it. This bar *c c* supports the block *e*, Fig. 2, on which the plate to be polished is confined, and for this purpose said bar is made of the wedging form shown in the plan, Fig. 2, and has its sides beveled inward, as shown in section in Fig. 3, so as to form a semi-dovetailed joint with the metallic cleats *f f f f*, screwed to the under side of the block *e*, as shown in Figs. 3 and 4. These cleats, four in number, are so arranged on the under side of the block *e* that it may be secured upon the bar *c c* in two positions, so as to allow the plate to be rubbed or polished in two directions. This arrangement is shown in Fig. 4,

which is a detail view of the under side of said block, and will be readily understood by inspection of said figure.

The block *e* is made with three adjustable sides *g h i*, which are adjacent to each other and fit together when screwed up against the block *e*, as will be understood by inspection of the plan, Fig. 2. These sides are shaped in section so as to slide in and out from the block *e*, as shown in Fig. 3, or in any other suitable manner. The adjustment or movement of these sides *g h i* is effected by thumb-screws *k k k*, which pass through said plates and work in proper female screws in the three sides of the block *e*. When these thumb-screws are turned back for the purpose of disengaging the plate from the block, the sides *g h i* are forced outward by the spiral springs *l l l l l*, which bear against the inner faces of the sides *g h i* and the faces of the block *e* opposite to them, the arrangement of said springs being as shown in Fig. 2 by dotted lines. The top faces of the sides *g h i* are on a level with the top face of the block *e*; but their exterior sides are faced each with a metallic plate *m n o*, which plates project above the top face of the block any distance less than the thickness of the plate to be held and polished, generally about half of said thickness. These plates *m n o*, with the stationary back plate *p*, are set at an angle somewhat obtuse with the face of the block *e* or with the plate *x*, Fig. 3, to be held on the same, as hereinbefore specified, which arrangement of said plates may be effected by making the outer faces of the movable side pieces *g h i* (to which said plates *m n o* are attached) beveling or inclining outward from their tops, as shown in Fig. 3, or in any other desirable manner.

It will readily be seen from the above-described mechanical arrangement that when a plate *x* to be polished is placed upon the

block *e*, one edge of said plate being set against the top of the back plate *p*, which projects, as specified, above the block, if the adjustable inclined plates *m n o* are screwed, respectively, against each of the other three edges of the plate on the block, the said plate will be held firmly and its top surface will be entirely free from all obstructions to the operation of the polishing-tools.

Where the plate to be polished is very large, it may be advisable to divide the adjustable sides *o h i* and plates *m n o*, and also to divide the back plate and make its parts adjustable and operate all the segments or divided portions of the same each by a separate thumb-screw; but this will not produce any variation of the principle of this part of our apparatus. The points of the pivots which sustain the vibrating bar *c c* should be in the same horizontal plane with the face of the plate to be polished; but any little variation of the position of these parts above or below said plane will not materially affect the operation of the suspended bar.

Having thus described our apparatus for holding plates to be polished, what we claim therein as our invention, and desire to have secured to us by Letters Patent, is—

The supporting the plate-holder on a bar constructed for holding the same firmly, substantially as hereinabove described, and suspended by right-angular arms *d d*, projecting upward from its ends and hung upon pivots *b b*, as set forth, so that the top of the plate in the holder will adapt itself, as it were, to the face of the polishing-tools when touched by the same, as hereinabove set forth.

Boston, November 25, 1845.

ALBERT S. SOUTHWORTH.

JOSIAH J. HAWES.

Witnesses:

EZRA LINCOLN, Jr.,
LUTHER BRIGGS, Jr.

W. & W. H. Lewis,

Buffer for Daguerreotype Plates,

No 8,235,

Patented July 22, 1851.

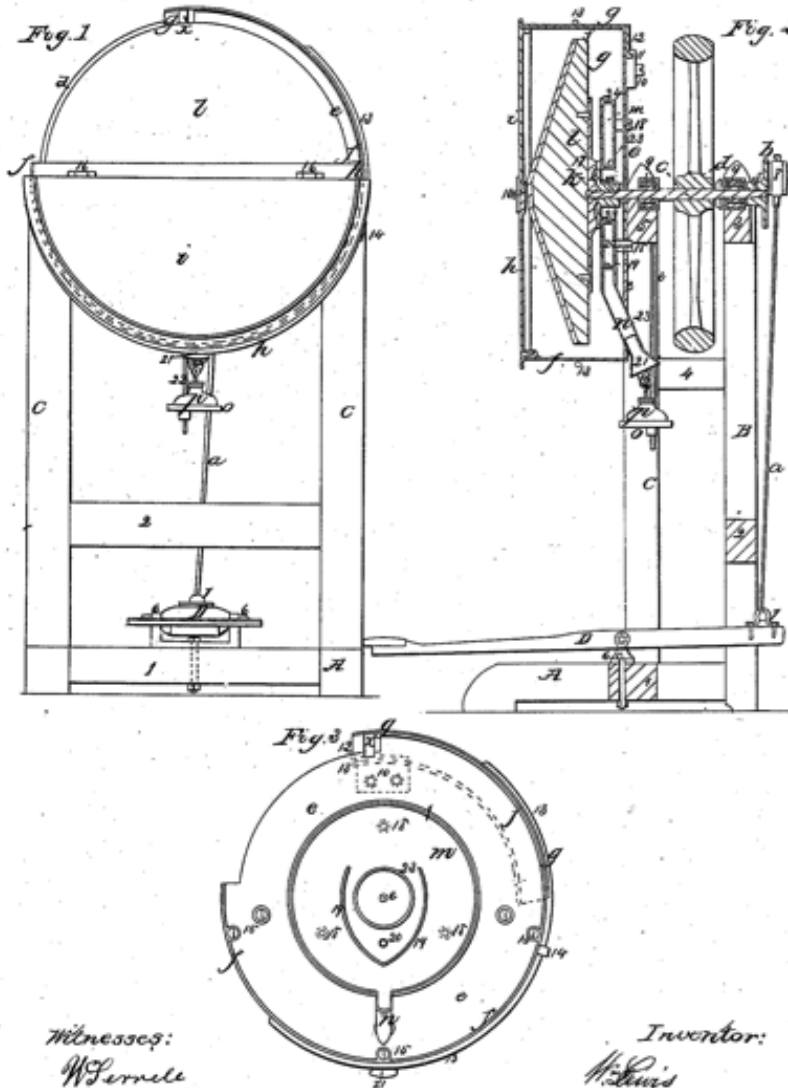

Witnesses:
W. Ferrelle
Samuel W. Howell

Inventor:
W. Lewis
W. H. Lewis

A. PETERS, PHOTO-LITHOGRAPHER, WASHINGTON, D. C.

UNITED STATES PATENT OFFICE.

WILLIAM LEWIS AND WILLIAM H. LEWIS, OF NEW YORK, N. Y.

IMPROVEMENT IN BUFFING APPARATUS FOR DAGUERREOTYPE-PLATES.

Specification forming part of Letters Patent No. 8,235, dated July 22, 1851.

To all whom it may concern:

Be it known that we, WILLIAM LEWIS and WILLIAM H. LEWIS, manufacturers of daguerreotype apparatus, of the city, county, and State of New York, have invented, made, and applied to use certain new and useful Improvements in Apparatus for Buffing Daguerreotype-Plates, by which improvements the buffer is warmed for use and other conveniences obtained, for which we seek Letters Patent of the United States; and we do hereby declare that the construction, operation, and effects of the said improvements are fully and substantially set forth and shown in the following description and in the drawings annexed to and making part of this specification thereof, in which—

Figure 1 is a front elevation of a buffing-machine fitted with our improvements; and Fig. 2 is a sectional elevation thereof, showing the interior parts in place that cannot be seen in Fig. 1; and Fig. 3 is a front elevation of the drum with section of heating-drum.

Like letters and numbers as marks of reference denote the same parts in each figure, as follows:

A is the foot-frame with a cross-tie 1.

B are back standards with a lower cross-tie 2 and a bearing-tie 3.

C C are front standards having each a tie 4 to the standards B, with a bearing-tie 5 at top.

D is a common treadle with journals 6, so set in a slot in the tie 1 that the treadle can be turned either side of the machine, so as to come convenient to the workman. The treadle takes the lower end of the pitman *a* by a ball-and-socket joint 7, (see Fig. 2,) the upper end of the pitman taking, by an anti-friction journal, a pin 8 in a face-plate *b*, which is on the back end of a mandrel *c*, set in anti-friction journals 9, and carries a fly-wheel *d* between the ties 3 and 5.

On the bearing-tie 5 is fixed the back plate *e* of an interrupted circular drum *f*, which goes about three-fourths round the plate *e*.

10 is a grooved plate (shown in dotted lines in Fig. 3) secured by screws to the plate *e*, the groove receiving a lip 11 on the edge of a flange 12 on one side of a movable segment *g*, which has a circular contractile spring 13 going through a guide-eye 14, and so that the workman can move the segment-plate *g* to complete the drum *f*, the lip 11 sliding in the

grooved plate 12, and the spring 13 drawing the edge of the plate 3 tight onto the edge of the drum *f* as they come in contact, and a small lug *x* on the plate 12 takes inside the edge of the plate *e* to form a guide to steady the plate *g* as it is moved around.

h is a half-cover secured by screws 15 to lugs on the inside and edge of the drum *f*.

16 are hinges on the cover *h* carrying the other half-cover *i*, which closes up to form a complete drum or circular box, inside of which is a box *k*, secured on the end of the mandrel *c*, and 17 is a plate screwed onto the nose of the mandrel, carrying a rotary face chuck or buffer *l*, which may be of any convenient form and covered with buff-leather or other suitable materials for polishing metallic surfaces; but these means are intended especially for daguerreotype-plates.

Behind the buffer *l* and around the box *k* is a circular drum *m*, formed of two flat rings connected by a ring or band 24 around the outside, and a similar ring 23 in the center opening, so as to form a tight drum, and inside this drum *m* is a division 19, and a small opening 20 receives a small pipe that passes outside through the back *e*. The drum *m* is attached to the back *e* by screws and washers 18, and connected to the lower end of the drum *m* is a pipe *n*, passing out through the back *e* and terminating with a funnel 21.

22 is a rod supporting a stand *o*, so fitted as to be turned around horizontally on the rod 22, and this carries a spirit or other lamp or heater *p*.

The uses and operation of this are as follows: In damp weather especially, and even at all times under ordinary circumstances, the leather composing the face of the buffer will receive moisture from the atmosphere, which prevents the requisite polish being obtained on daguerreotype-plates.

The main object of our improvements is to heat this buffer so as to dispel all moisture under any circumstances, and thereby render the buffer more effective. To effect this purpose the segment *g* is placed to close the drum *f*, and the cover *i* turned up so as to inclose the buffer. The spirit-lamp is then lighted, the heat of which passes into and heats the drum *m*, which heats and dries the buffer perfectly, so that on using the buffer the polishing is effected with ease and the

plate is left perfectly clean. The division 19 causes the heat to pass up inside the drum and then descend inside the division 19, and the hole 20 passes any vapor outside the drum, so as to prevent any condensation of the alcohol in the drum *f*, so as to render the buffer damp. It will be seen that the rotation of the buffer is effected by the treadle and parts, as usual, and also that the edge of the cover *h* forms a rest for the plate or other substance being polished, and that the sliding segment *g* enables the operator to work out to the very edge of the buffer, and the edge of the buffer may be also covered, if found convenient.

We do not claim heating the buffer, as that has been done by lamps operating on the plate on which the buffing material is stretched; but in that form the heat is uneven and the vapor from the spirit-lamp is liable to come in contact with the buffing material; but

What we claim as new and of our own in-

vention, and desire to secure by Letters Patent of the United States, is—

The inclosing drum constructed with the sliding segment or cover *g*, flange 12, and lip 11, sliding in the grooved plate 10 and retained by the spring 13 for the purposes specified, in combination with the drum *m* and pipe *n* to pass the heat from a spirit-lamp or other heater to the drum *m* for the purpose of heating the buffer, the drum *m* being fitted with a pipe or other means to pass any vapor from the spirit-lamp outside the case inclosing the buffer, substantially as described and shown.

In witness whereof we have hereto set our signatures this 23d day of January, 1851.

WILLM. LEWIS.
W. H. LEWIS.

Witnesses:

W. SERRELL,
LEMUEL W. SERRELL.

T. Durryea,
Polishing Daguerreotype Plates,
No. 9,018, Patented June 15, 1852.

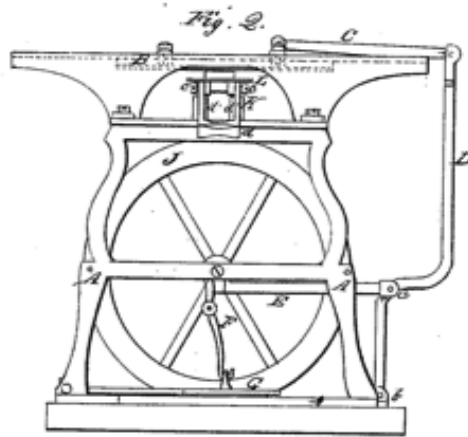
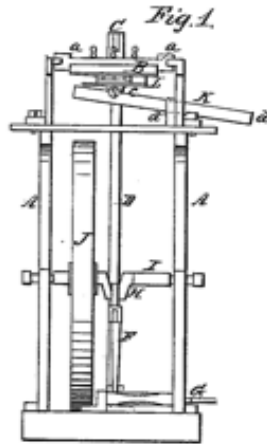

W. PETERS, PHOTO-LITHOGRAPHER, WASHINGTON, D. C.

UNITED STATES PATENT OFFICE.

TOWNSEND DURYEY, OF WILLIAMSBURG, NEW YORK.

MACHINE FOR POLISHING DAGUERRETYPE-PLATES.

Specification forming part of Letters Patent No. 9,018, dated June 15, 1852.

To all whom it may concern:

Be it known that I, TOWNSEND DURYEY, of Williamsburg, in the county of Kings and State of New York, have invented a new and Improved Machine for Polishing Daguerreotype-Plates; and I do hereby declare that the following is a full, clear, and exact description of the construction and operation of the same, reference being had to the annexed drawings, making a part of this specification, in which—

Figure 1 is a front elevation of the machine. Fig. 2 is a side elevation of the machine.

Similar letters of reference indicate corresponding parts in each of the two figures.

The nature of my invention consists in polishing daguerreotype-plates by means of a horizontal reciprocating bed, said bed having a strip of buff, chamois, or other suitable material attached to its under side. The plate to be polished is placed and secured in any proper manner to the end of a lever or frame having its fulcrum or bearing attached to the frame of the machine. The plate is so arranged on the end of the lever as to be in contact with the buff or chamois on the under side of the reciprocating bed when the opposite or outer end of the lever or frame is depressed. The plate is thus brought in contact with the polishing material, and the combination of the horizontal reciprocating bed with the lever or frame for holding or pressing the plate to or against it constitutes the invention.

To enable others skilled in the art to make and use my invention, I will proceed to describe fully its construction and operation.

A represents the frame of the machine, which may be constructed of metal or other suitable material. On the upper part of the frame is placed the reciprocating board or bed B, said bed having grooves *a a* in its sides in which a part of the frame fits, (see Fig. 1,) the portion of the frame that fits in the grooves being bent at right angles with the vertical portion. C is a connecting-rod attached by pivots to the bed B and to the lever D. (See Fig. 2.) The lever D has its fulcrum at *b*. Attached to the lever at the point *c* is a connecting-rod E, the opposite end of which is secured to a jointed pitman F, said pitman being secured to a treadle G—that is, the lower end of it, the upper end being attached to a crank H on the shaft I, the shaft having

its bearings in the frame of the machine. J is a fly-wheel upon the shaft I to assist the crank to pass its center.

The manner in which the reciprocating motion is given the bed B will be readily seen. As the treadle G is operated by the foot, a reciprocating motion is given the connecting-rod E, and this motion is communicated to the bed B by means of the lever D and connecting-rod C.

K is the frame or lever, on one end of which the plate to be polished is secured. The plate is arranged on the end of the frame in the following way:

L is a small platform attached to the end of the frame by a joint or joints *c*. The plate is secured on this platform in any proper way. Now when the outer end *d* of the frame is depressed the whole surface of the plate will be in contact with the buff or chamois on the under side of the bed B, as the platform L will be in a horizontal position owing to the joint attachment. The frame may consist of one or more levers. Two levers are represented in the drawings. I do not confine myself to any particular number. The fulcrum of the levers are at *d'*.

The operation will be readily seen. The plate being properly secured on the platform L, motion is given the bed B by operating the treadle G with the foot. The outer end *d* of the frame K is then depressed, which forces the plate against the buff or chamois on the under side of the bed B, the friction produced by the motion causing the plate to be polished.

The above machine is simple, not liable to get out of repair, and works in an effectual manner, the plate is polished more perfectly than can be done on the ordinary machines in use, and the expense of constructing one of my machines is not great.

I do not claim the platform L nor frame K; neither do I claim the reciprocating bed B separately; but

What I claim as new, and desire to secure by Letters Patent, is—

The horizontal reciprocating bed B, operated in the manner described, or in any other equivalent way, in combination with the frame K, for the purpose as herein specified.

TOWNSEND DURYEY.

Witnesses:

JAMES M. AYMEN,
JAMES H. CILLS.

T. Longking
Cleaning Daguerreotype Plates.

N^o 10,475.

Patented Jan. 31, 1854.

Fig. 2.

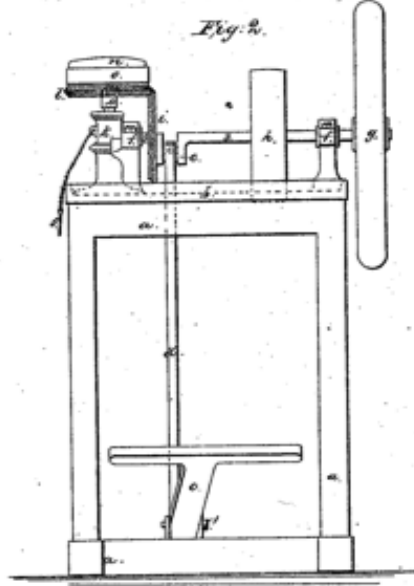

Fig. 3.

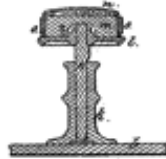
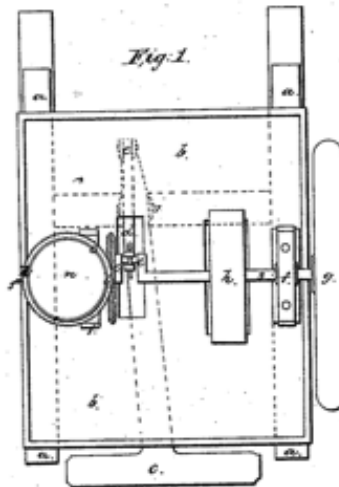

Fig. 1.



Witnesses:

Peter Van Schaack

Samuel W. Smith

Inventor:

T. Longking

UNITED STATES PATENT OFFICE.

THOMAS LONGKING, OF BROOKLYN, NEW YORK.

IMPROVED APPARATUS FOR CLEANING AND BUFFING DAGUERREOTYPE-PLATES.

Specification forming part of Letters Patent No. 10,475, dated January 31, 1854.

To all whom it may concern:

Be it known that I, THOMAS LONGKING, manufacturer of daguerreotype apparatus, of Brooklyn, in the county of Kings and State of New York, have invented and made certain new and useful Improvements in Apparatus for Cleaning or Scouring and Buffing Daguerreotype Plates; and I do hereby declare that the following is a full, clear, and exact description of the construction and operation of the same, reference being had to the annexed drawings, making part of this specification, wherein—

Figure 1 is a plan. Fig. 2 is a front elevation, and Fig. 3 is a section through the cleaning-pad.

The like marks of reference denote the same parts in all the figures.

The nature of my said invention consists in means for cleaning the plate previous to buffing. This has heretofore been done by hand, the operator using a piece of canton-flannel, on which he puts rotten-stone and oil or similar cleaning material and rubbing the daguerreotype-plate all over with the same; and for this purpose a plate-holder is used that can be turned around with one hand, while the plate is cleaned with the other. To accomplish the same object I use a rotary cushion, over which a cover of canton-flannel or similar substance is put and secured by a ring, the daguerreotype-plate being applied to the rotating cushion while held in a proper plate-holder, and in connection with this cleaning-cushion I use a buffing-wheel to finish the polishing of the plate.

a is a suitable frame, supporting a bed-plate *b* and carrying a treadle *c* on a fulcrum *l*.

d is a pitman, jointed at 2 to the treadle and passing through an opening in the bed *b* to a crank *e* on a horizontal shaft 3, supported in journals *f*, to the bed *b*.

g is a fly-wheel, and *h* is a buffing-wheel, which may be either conical or cylindrical.

i is a miter-wheel on the end of the shaft 3.

k is a step or column receiving a vertical spindle 4, that sets at the bottom on a steel plate (see Fig. 3) and carries near the top a miter-wheel *l*, matching to the miter-wheel *i*.

Above the wheel *l* is a block *m*, over which is a cushion stuffed with proper material; but I prefer that sponge should be used for this purpose. Over this cushion I lay a piece of canton-flannel or similar material *n* and secure the same by sliding on a ring *o*, which arrangement gives the facility of changing the cleaning fabric when worn out or dirty. By these means I am enabled to clean plates by placing on the cover *n* rotten-stone and oil or similar cleaning material and applying the daguerreotype-plate thereto, while the cushion is rotated by the foot applied to the treadle *c*, and when the buffing-wheel is in use the cleaning-cushion may be disconnected to avoid friction by raising the same and inserting a pin 5 through a hole made for that purpose through the shaft.

I do not claim the buffing-wheel nor any of the parts separately; but

What I desire to secure by Letters Patent is—

1. Fitting the revolving cushion *m* with the ring *o*, by which the canton-flannel or similar covering is secured to the cushion or removed and a new cover substituted when required, as specified.

2. The arrangement of the gearing and shafts by means of which the cleaning-cushion is combined with the buffing-wheel, in the manner substantially as set forth.

In testimony whereof I have hereunto set my signature this 5th day of October, 1853.

THOS. LONGKING.

Witnesses:

PETER VAN SCHAACK,
LEMUEL W. SERRELL.

B.F. Upton,

Polishing Daguerreotype Plates,

No. 11,709,

Patented Sept. 19, 1854.

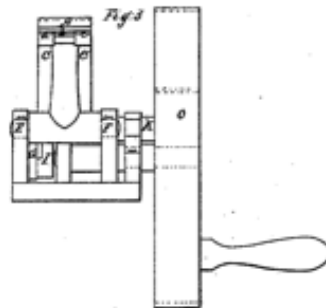
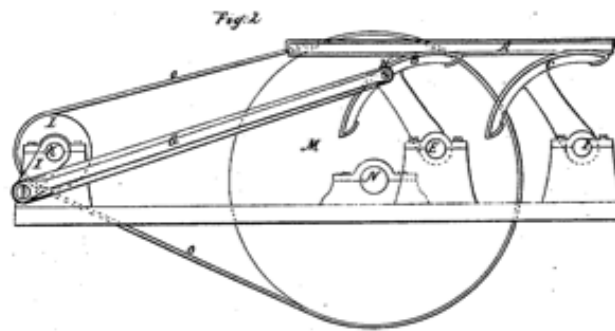
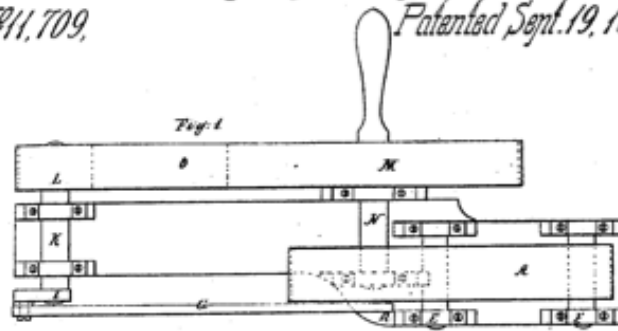

A.M. PHOTO-LITHO. CO. N.Y. (SEEKES PRICE)

UNITED STATES PATENT OFFICE.

BENJAMIN F. UPTON, OF BATH, MAINE.

IMPROVED APPARATUS FOR POLISHING DAGUERREOTYPE-PLATES.

Specification forming part of Letters Patent No. 11,709, dated September 19, 1854.

To all whom it may concern:

Be it known that I, BENJAMIN F. UPTON, of Bath, in the county of Sagadahoc and State of Maine, have invented a new and useful Machine for Polishing Daguerreotype-Plates; and I do hereby declare that the same is fully described and represented in the following specification and the accompanying drawings, letters, figures, and references thereof.

Of the said drawings, Figure 1 represents a top view, and Fig. 2 a side elevation, of my said machine.

In said drawings, A denotes a board having its upper surface covered with buff leather or other material suitable for polishing daguerreotype-plates. This board is supported on two rocker-sectors B C, whose radii are of equal length. The shafts of these sectors are supported in suitable bearings E F, and each sector is connected to the polishing-board by three belts *a b c*, they being represented in Fig. 3, which is an end view of the machine. Each belt has one end of it fastened to the polishing-board, while its other end is fastened to its rocker-sector, the belt being arranged between the polishing-board and sectors. The two outside belts in each set have their inner ends attached to the middle part of the under surface of the polishing-board, their outer ends being fastened to the outer ends of the sectors. Each of the middle belts *b* has its outer end fastened to one of the ends of the board, its inner end being fastened to the inner end of the arc of the sector, directly between which and such board the belt is placed. To one of the sectors one end of a connecting-rod G is affixed or jointed by means of a pin H, the other end of the connecting-rod being jointed to a crank I, which is jointed to a horizontal shaft K. On the said shaft K there is a pulley L, around which and a driving-pulley M, fixed upon a driving-shaft N, an endless belt O is made to travel.

When the driving-pulley is put in rotation, it produces a constant rotatory motion of the crank above mentioned, which by means of the connecting-rod will impart to that rocker-sector to which the said rod is attached a reciprocating rotative motion, such as will by means of the two sets of bands or belts hereinbefore mentioned impart to the polishing-board a reciprocating rectilinear motion. The two rocker-sectors serve to support the board and to maintain it in a horizontal plane or

in one plane during its reciprocating movements.

The guide-belts not only perform the function of causing the polishing-board to be moved by the sectors but they prevent the board from being moved laterally off by the sectors during their rapid reciprocating movements, while one of the sectors, or that one to which the connecting-rod is attached, performs the office of supporting the board and moving it longitudinally during a movement of said sector, as above described. The other sector serves to support the board and maintain its correct horizontal position during its reciprocating movements.

I am aware that there are various methods by which a board may be supported in a horizontal plane and have reciprocating rectilinear movements given to it, and that such modes may be considered as mechanical equivalents for my mode or device. Now such modes, and particularly those of them wherein the board is sustained and made to slide in stationary ways, are attended with much friction unless the parts moving in contact with each other are lubricated; and, besides, in polishing daguerreotype-plates it is desirable to have as little oil about the mechanism as possible and that such mechanism should operate with the least possible friction and noise, for as a matter of necessity the polishing-board has to be moved with great rapidity.

My mechanism, although equivalent to some other devices well known to mechanics, is not analogous to them. It forms a combination of parts to produce a like result, but in a better manner.

What, therefore, I claim is—

The combination and arrangement of mechanism for supporting the polishing-board, maintaining it constantly in one plane, and imparting to it a reciprocating motion, the said combination consisting of the two rocker-sectors, the two sets of forward and back draft belts, the connecting-rod, and crank, applied and made to operate together, essentially as hereinbefore specified.

In testimony whereof I have hereunto set my signature this 24th day of June, A. D. 1854.

BENJAMIN F. UPTON.

Witnesses:

R. K. HAINES,
AMMI R. MITCHELL.

D. Shive,

Polishing Daguerreotype Plates.

N^o 12,560.

Patented Mar. 20, 1855.

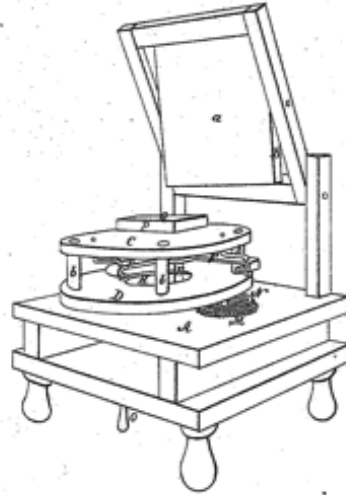

Fig. 1.

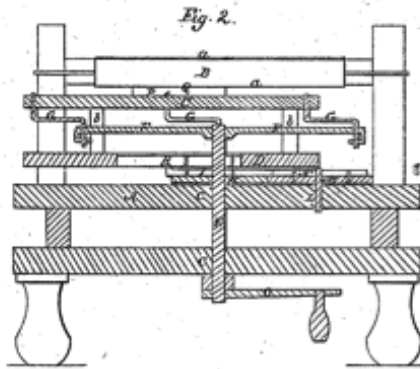

Fig. 2.

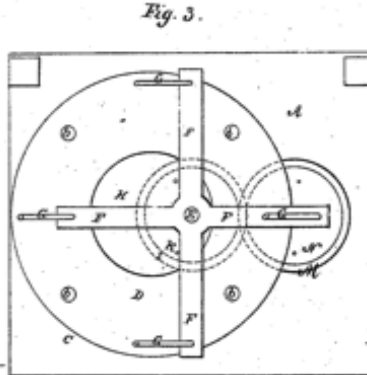

Fig. 3.

Witnesses
Ben. Benson
Jonathan B. Waters

Inventor
David Shive

UNITED STATES PATENT OFFICE.

DAVID SHIVE, OF PHILADELPHIA, PENNSYLVANIA.

MACHINE FOR POLISHING DAGUERREOTYPE-PLATES.

Specification forming part of Letters Patent No. 12,560, dated March 20, 1855.

To all whom it may concern:

Be it known that I, DAVID SHIVE, of the city of Philadelphia and State of Pennsylvania, have invented a new and useful Machine for Polishing Daguerreotype-Plates and other Like Surfaces; and I do hereby declare that the following is a full, clear, and exact description thereof, reference being had to the accompanying drawings, making a part of this specification, in which—

Figure 1 is a perspective view; Fig. 2, a vertical section of the same through the central shaft, and Fig. 3 a plan view having the pad and upper circular piece removed.

Like letters indicate the same parts when on the several figures.

The nature of my invention consists in providing a machine for polishing daguerreotype-plates and other like surfaces requiring the finest polish, adapted to cause either the plate or the polishing-pad to move in constantly-changing circles, the one piece against the other, or, in other words, the one to gyrate or whirl around against the other, so as to continually change by circular motions the relative position of every point of contact between the two surfaces.

In preparing daguerreotype-plates for receiving the picture the more perfect the polish the more perfect will be the heliographic effect, and experience has fully demonstrated that in procuring the polish required on the surface of the plate there is no motion that can be given to the pad comparable in its effects to a gyrating one; but this motion has heretofore required to be effected by hand, and is consequently dependent upon the skill or manual dexterity of the operator, and is always attended with the expenditure of much time and labor. To obviate these objections, and at the same time enable the most inexperienced operator to produce the most perfect polish upon the surface of such plates; is the object effected by the use of my invention.

Referring to the drawings, A is the frame which sustains the moving parts of the machine.

B is the adjustable pad-piece, hung in a frame and having a polishing-pad a' a'' on each of its two sides, as shown in the drawings.

C is the upper circular piece, which carries the plate \mathcal{P} around under the pad-piece B.

D is a like circular piece connected with the upper one by means of the posts or binders $b b b b$. These two united pieces are supported upon a shaft E, which is adapted to rotate in a perpendicular position, sustained by means of the two lower pieces $c c$ of the frame A. The shaft E and the upper circular piece C are connected together by means of four arms F F F F, which are fixed upon the upper end of the shaft and connect by means of four cranks G G G G near the ends of the arms with the said upper circular piece, as shown in the drawings. The shaft E passes eccentrically and loosely through a circular plate or disk H, which fits loosely in an appropriate hole in the center of the lower circular piece D, and also loosely through the center of a spur-wheel I, which is fixed to the bottom or lower side of the eccentric piece, and immediately below this spur-wheel another spur-wheel K, somewhat less in diameter, is concentrically fixed to the shaft.

Upon a stud fixed in the piece c of the frame A at L a pair of like spur-wheels M and N, riveted together concentrically, are adapted to rotate in gear connection, respectively, with the two spur-wheels on the shaft, so that when rotation is given to the shaft E by means of the hand-crank O beneath the frame or by any other suitable means the fixed spur-wheel K thereon causes a rotation of the united wheels M N, and the upper one N being in gear connection with the spur-wheel I, which is fixed to the eccentric plate H, and both turning loosely upon the shaft E, causes the two circular pieces D and C (which are rigidly united together and also connected by the cranks G and arms F to the driving-shaft E, as before described) to gyrate or whirl round horizontally. The plate or plates to be polished are fixed upon a block P, which is fixed centrally upon the upper surface of the upper circular piece C and the adjustable pad-piece brought down by hand, so as to rest with the pad upon the surface of the plate or plates to be polished. The pad-piece is made to swing in its frame, so as to enable the operator to use with facility either side or the coarse and fine pad in succession, as occasion may require.

In the operation of the machine it will be perceived from the description, illustrated by the drawings, that the circular pieces C D are carried round by the rotation of the shaft E and arms F, (they being connected therewith by means of the cranks G,) and that the eccentric H being confined in the center of the lower circular piece D and driven at a different speed from that of the shaft E, upon which it turns, the circular piece C, with the fixed block P, to which the plates are attached, is necessarily caused to gyrate or whirl around in continually-changing circular motions, and that, the pad being held down thereon by the hand of the operator or by a weight of any kind, the polishing is effected as desired. The diameter of the greater circle of motion, it is also apparent, will be proportionate to the throw of the eccentric, and the numerical relation between the smaller circles and the greater will be governed by the relative diameters of the spur-wheels, both of which are matters allowing discretionary latitude in the construction of the machine. It will be apparent, also, that the effect will be the same

if the pad and plates are made to change places, respectively, in the construction of the machine, so that the plates shall remain stationary while the pad gyrates with the circular piece C.

Having thus described the construction and operation of my invention, I proceed to state that I do not claim effecting a gyratory motion of the pad for polishing the surfaces of daguerreotype-plates or other like surfaces by means of machinery, as such has been so effected before for similar purposes; but

What I claim as my invention, and desire to secure by Letters Patent, is—

The shaft E, with its arms F, cranks G, the pieces C and D, (or their equivalents,) and the eccentric H, with its spur-wheel I, in combination with the united spur-wheels M and N and the spur-wheel K, when constructed and arranged substantially and for the purposes as described.

DAVID SHIVE.

Witnesses:

JONATHAN H. WATERS,
J. MITCHELL.

C. Ketcham,

Daguerreotype-Plate Cleaner.

N^o 20718.

Patented June 29, 1858.

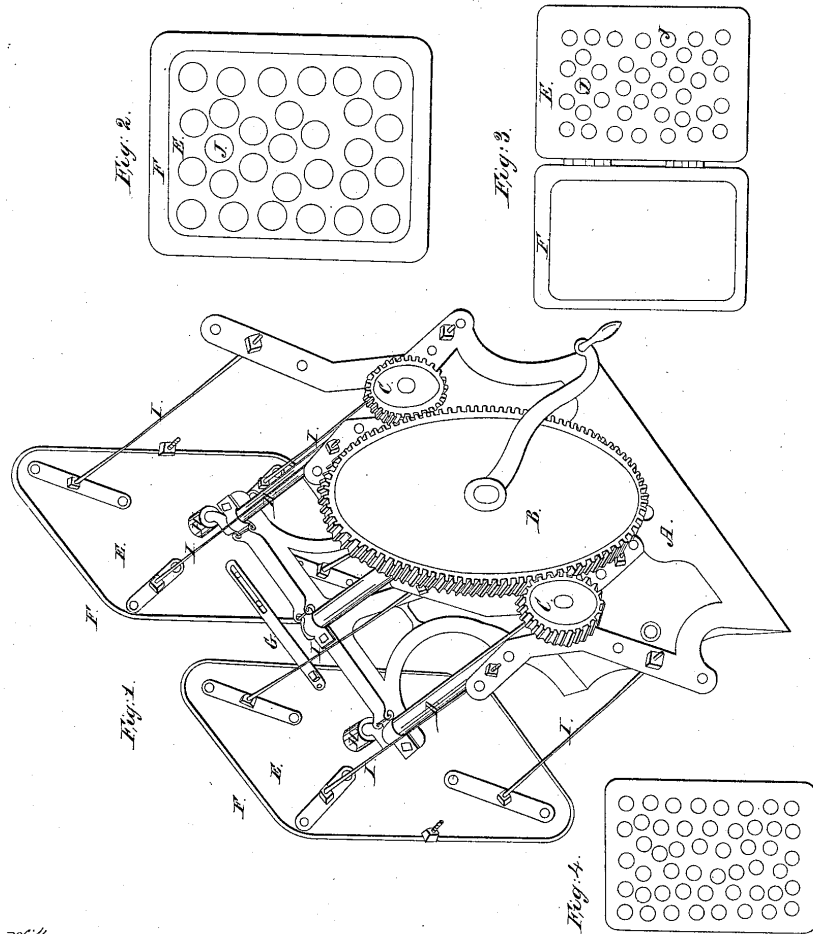

Witnesses:

*A. Oliver
C. J. F. J. J.*

Inventor:

Charles Ketcham

UNITED STATES PATENT OFFICE.

CH. KETCHAM, OF PENN YAN, NEW YORK.

MACHINE FOR CLEANING DAGUERRETYPE-PLATES.

Specification of Letters Patent No. 20,718, dated June 29, 1858.

To all whom it may concern:

Be it known that I, CHARLES KETCHAM, of Penn Yan, in the county of Yates and State of New York, have invented a new and useful Machine for Cleaning and Polishing Daguerreotype-Plates or other Materials; and I hereby declare the following to be a full, clear, and exact description of the construction and operation of the same, reference being had to the annexed drawings, making a part of this specification, in which—

Figure 1 is perspective view of the whole. Fig. 2 is front view of the cleaner. Fig. 3 is front view of the cleaner with the clasp opened. Fig. 4 is front view of a perforated cleaner-plate.

The letters refer to the same parts in each figure.

A, Fig. 1, is the frame which may be made of wood but metal is preferable, the size of which is made to suit the size of the cleaners and may be made in any style to suit the artist. B the driver of spur, or other gear may be used when another position of the cleaner is required the size is regulated by the size of cleaners required and motion of the same; to this wheel B I apply the crank or it may be applied to the shaft, and if other power is used it may be applied to the shafts D and D, D and D, shafts with a crank at the end of length to suit the required motion of the cleaners in the place of a crank an eccentric may be used to produce the same motion. I, I, I, I, I, I, I, I, are springing braces that serve to hold the cleaners in position, and are attached to the backs of the cleaners, and extend to the arms of the frame to which they are firmly attached with nuts which will allow the cleaners to be adjusted at pleasure, when eccentrics are used instead of cranks, the braces may be left off if the eccentrics are large enough to hold the cleaners firm.

G is a bar extending from one cleaner to the other, its use is to prevent the cleaners from revolving with the shafts D, D; H, H, boxes attached to the parts of the cleaners represented by E in which the crank turns, if eccentrics are used this box is made larger in diameter and has a plate with a hole in the center to let the shaft pass through and it is fastened to the box by screws and serves to hold the eccentric in the box.

E, E, are the main plates of the cleaners and may be made of any suitable material as tin, brass, wood or iron to which parts represented by J Figs. 2 and 3 are attached or they may be perforated as represented in Fig. 4 so that the parts J may be inserted; this method is preferable when a substance that cannot be cemented is used to make the parts J such as cork, wire or other substance that may be used for the same purpose.

F is a clasp surrounding the plate E and is attached to it by hinges or otherwise and held in position by a thumbscrew or other device, its use is to hold the cloth or other substance that may be used to cover the parts J. F has teeth raised on the inner edge to stretch and hold the covering above-mentioned.

The parts J are better to be made of soft or elastic substance and should project beyond the clasp F so there will be no danger of damage by the clasp coming in contact with the plate while being cleaned. Instead of the parts J, one uniform surface may be used for some kinds of work the surface should project as J for the same reason.

Fig. 2, represents the cleaner closed in the manner to hold the covering.

Fig. 3, represents the cleaner opened to receive the covering.

The parts represented by J may not be covered for some kinds of work.

G is a bar extending from one cleaner to the other it is made fast at one cleaner and loose at the other, but attached by a joint that will allow the cleaners to work without being bound or held by it if one works ahead of the other, it may be attached to any part of the cleaners.

What I claim and desire to secure by Letters Patent is—

Cleaners made as specified with projections J as set forth; also the means for holding them in position with respect to each other, and the means for giving motion to the cleaners when arranged as specified.

CHARLES KETCHAM.

Witnesses:
A. OLIVER,
CHAS. G. JUDD.

Bibliography

- Abrams, Peter. "Henry Fitz: A Preeminent 19th Century American Telescope Maker." *Journal of the Antique Telescope Society* 6 (1994): 6-10.
- Arago, François. "Physique appliquée. - Photographie." *Compte rendu des séances de L'Academie des sciences*, no. Séance du Lundi 23 Décembre (1839).
- Auslander, L., A. Bentley, L. Halevi, H. Otto Sibum, and C. Witmore. "Ahr Conversation: Historians and the Study of Material Culture." *American Historical Review* 114 (2009): 1355-404.
- Bache, Alexander Dallas. "The Daguerreotype Explained." *United States Gazette*, September 25 1839.
- Bajac, Q., D. de Font-Réaulx, Musée d'Orsay, and Metropolitan Museum of Art. *Le Daguerreotype Français: Un objet photographique*. Réunion des musées nationaux, 2003.
- Banta, Melissa, and Harvard University. Library. *A Curious & Ingenious Art: Reflections on Daguerreotypes at Harvard*. Iowa City: Published for Harvard University Library by University of Iowa Press, 2000.
- Bardwell, J. J. "Cause and Effect." *The Photographic and Fine Art Journal* 7 (1854): 270-1.
- Barger, M. Susan. "The Daguerreotype: Image Structure, Optical Properties, and a Scientific Interpretation of Daguerreotypy." PhD Dissertation, The Pennsylvania State University, 1982.
- . "Robert Cornelius and the Science of Daguerreotypy." In *Robert Cornelius: Portraits from the Dawn of Photography*. Washington, DC: Smithsonian Institution Press, 1983.
- Barger, M. Susan, and William B. White. *The Daguerreotype: Nineteenth-Century Technology and Modern Science*. 2nd ed. Baltimore: John Hopkins University Press, 2000.
- Batchen, Geoffrey. "Ere the Substance Fade." In *Photographs Objects Histories: On the Materiality of Images*, edited by E Edwards and J. Hart, 2004.
- "Beard's Apparatus for Taking Likenesses." *The Penny Mechanic and Chemist: A Magazine of the Arts and Sciences* 1 (May 1 1841): 166-8.
- Beckers, Alexander. "Fifteen Years Experience of a Daguerreotypy." *The St. Louis and Canadian Photographer* 7, no. 4 (1889).

Robinson: The Techniques and Material Aesthetics of the Daguerreotype

- Beckers, Alexander. "My Daguerreotype Experience." *Anthony's Photographic Bulletin* 20, no. 7 (April 13, 1889): 209-11.
- "Beer-Lambert-Bouguer Law." In *McGraw-Hill Dictionary of Scientific & Technical Terms*. <http://encyclopedia2.thefreedictionary.com/Beer-Lambert-Bouguer+law>.
- Bekhuis, Alan, and Jillian Pichocki. "Image Object: Contemporary Daguerreotypes." edited by Center for Alternative Photography Pneumbra Foundation. New York: Blurb, 2013.
- Berg, Paul K. *19th Century Photographic Cases and Wall Frames*. Huntington Valley Press, 1995.
- Besant, Sir Walter, and G. E. Mitton. *The Fascination of London: Holborn and Bloomsbury*. Adam and Charles Black, 1903.
- Bigelow, Nicholas, Ralph Wiegandt, and Brian McIntyre. "Research on the Gilding of Daguerreotypes." Paper presented at the The Daguerreian Society Symposium, Austin, Texas, 2014.
- Biot, Jean-Baptiste. "The Correspondence of William Henry Fox Talbot." Leicester: DeMontfort University, 1839.
- . "Letter to Wm. Henry Fox Talbot." In *The Correspondence of William Henry Fox Talbot*. Leicester: DeMontfort University, 1839.
- . "Physique chimique -- Note de M. Biot sur un papier sensible préparé par M. Daguerre." *Compte rendu des séances de L'Academie des sciences* 1, no. Séance du Lundi 18 Février (1839): 246-47.
- Bisbee, A. *The History and Practice of Daguerreotyping*. New York: 1853. Arno Press facimilie 1973.
- Bishop, Dr. Philip W. "Scovill and Photography." *The New Daguerreian Journal: Devoted to the Daguerreian and Photogenic Art Also embracing the Sciences, Arts, and Literature* 3, no. 2 (January 1975).
- Blanquart-Evrard, Louis Désiré. "Note sur la photographie; Moyens accélérateurs." *Comptes rendus hebdomadaires des séances de l'Académie des sciences* (lundi 23 Décembre 1850): 864-65.
- Blum, W., and G.B. Hogaboom. "Factors Governing the Character and Distribution of the Deposits." In *Principles of Electroplating and Electroforming: (Electrotyping)*, 85-119. New York: McGraw-Hill Book, 1930.

Robinson: The Techniques and Material Aesthetics of the Daguerreotype

- "A. Brassart of St. Louis Perfected the Process Which Made Daguerre Famous." *St. Louis Post-Dispatch*, August 21 1898, 23.
- Brewster, D., and A.D. Bache. *A Treatise on Optics*. Lea & Blanchard, 1841.
- Buerger, Janet E. *French Daguerreotypes*. Chicago; London: University of Chicago Press, 1989.
- Cattani, Gino, Roger L. M. Dunbar, and Zur Shapira. "Value Creation and Knowledge Loss: The Case of Cremonese Stringed Instruments." *Organization Science* 24, no. 3 (2013): 813-30.
- Celma, Marta Garia. "Review." Paper presented at the AIC – Photographic Material Group – Biannual Winter Meeting 2015 / Conservation Conversations, Harvard University, Cambridge, 2015.
- Chaffers, W. *Hall Marks on Gold and Silver Plate. To Which Is Now Added a History of L'orfèvrerie Française*. 1883.
- Chapman, Wilmot M. . "Our First Photographers." *Sun (New York)*, February 4, 1896.
- Chevalier, Charles Louis. "Éloge de Daguerre. - Documents historiques, lettres inédites de N. Niépce, Etc.". Chap. Troisième Partie. In *Guide du photographe*. Paris, Palais Royale 158: C. Chevalier, 1854.
- . *Recueil de mémoires et de procédés nouveaux concernant la photographie sur plaques métalliques et sur papier*. Paris: Charles Chevalier, 1847.
- . *Nouvelles instructions sur l'usage du Daguerreotype, descripton d'un nouveau photographe, suivie d'un memoir sur l'application du brôme*. 1841.
- . *Mélanges photographiques: Complément des nouvelles instructions sur l'usage du Daguerreotype*. Chez l'auteur, 1844.
- Claudet, Antoine François Jean. "Improvements in the Daguerreotype Process." edited by Royal Letters Patent. England, 1841.
- . "Letter to Mr. P. Foster." *The Philadelphia Photographer*, no. V (1868): 174.
- . "Photographic Phænomena Referring to the Various Actions of the Red and Yellow Rays on Daguerreotype Plates When They Have Been Affected by Daylight." *The London, Edinburgh, and Dublin Philosophical Magazine and Journal of Science* XXXII, no. CCXIV (March 1848): 203.
- . "The Progress and Present State of the Daguerreotype Art." *Journal of the Franklin Institute* 40, no. 1 (1845): 45-57.

Robinson: The Techniques and Material Aesthetics of the Daguerreotype

- Claudet, Antoine François Jean. "Sur un nouveau procédé d'iodage pour les planches destinées à recevoir des images photographiques, procédé qui abrège considérablement la durée du temps nécessaire pour que la lumière produise une impression suffisante. -- Lettre de M. Lerebours à M. Arago." *Compte rendu hebdomadaires des séances de l'Académie des sciences*, no. Seance du Lundi 7 Juin (1841).
- . "New Mode of Preparation of the Daguerreotype Plates, by Which Portraits Can Be Taken in the Short Space of Time of from Five to Fifteen Seconds, According to the Power of Light, Discovered by A. Claudet in the Beginning of May 1841." Paper presented at the Proceedings of the Royal Society, June 10 1841.
- . "Question of Priority Respecting the Discovery of the Accelerating Process in the Daguerreotype Operation." *The London, Edinburgh, and Dublin Philosophical Magazine and Journal of Science* XXXII, no. CCXIV (March 1848): 215-16.
- Colucci, Dan. "The Petzval Lens." *The Journal: New England Journal of Photographic History*, no. 171 (2013): 39-58.
- Compte rendu hebdomadaires des séances de l'Académie des sciences*, (May 30, 1842): 840.
- Craig, John S. *Craig's Daguerreian Registry*. 2nd Revised ed. Vol. I, Torrington, CT. 2003.
- Croucher, John H. "Practical Hints on the Daguerreotype." In *Plain Directions for Obtaining Photographic Pictures*. Philadelphia: A. Hart, late Carey and Hart, 1853.
- D'Agostini, Corrado. *Photographic Lenses of the 1800's in France*. Bandecci & Vivaldi, 2011.
- Da Silva, Eric, Mike Robinson, Christopher Evans, Ana Pejovic-Milic, and Darrick V. Heyd. "Monitoring the Photographic Process, Degradation and Restoration of 21st Century Daguerreotypes by Wavelength-Dispersive X-Ray Fluorescence Spectrometry." *Journal of Analytical Atomic Spectrometry* 25, no. 5 (2010): 654-61.
- Daguerre, Louis Jacques Mandé. "Daguerreotype." *Image: The Journal of the George Eastman House of Photography* 8, no. 1 (March 1959): 4.
- . *Historique et description des procédés du Daguerreotype et du Diorama*. Alphonse Giroux et Cie ed. Paris: Delloye, Libraire, 1839.
- . "Des procédés photogéniques considéré comme moyens de gravure. — Lettre de M. Daguerre à M. Arago." *Compte rendu hebdomadaires des séances de l'Académie des sciences*, no. Séance du Lundi 30 Septembre (1839): 423-30.

Robinson: The Techniques and Material Aesthetics of the Daguerreotype

- Daguerre, Louis Jacques Mandé. "Le Pavillion de Flore et Le Pont-Royal." Paris, musée des Arts et Métiers, inv 8745-1, October 2, 1839.
- . "Letter to Isadore Niépce - October 5, 1835." In *Dokumenty Po Istorii Izobreteniia Fotografii [Documents on the History of the Invention of Photography]*, edited by Torichan Pavlovich Kravets. Moscow: Izd-vo Akademii nauk [Academy of Sciences], 1949.
- . "On a New Mode of Preparing the Plates Destined to Receive Photographic Images." *The Chemist*, no. v. 5 (1844): 260-3.
- . "Photographie.— Sur un nouveau moyen de préparer la couche sensible des plaques destinées à recevoir les images photographiques." *Compte rendu hebdomadaire des séances de l'Académie des sciences*, no. Séance du Lundi 17 Avril (1844): 756-62.
- . "Physique appliquée: Lettre de M. Daguerre à M. Arago sur la substitution du tripoli à la ponce, pour le polissage des plaques destinées à recevoir les images du Daguerreotype." *Compte rendu hebdomadaire des séances de l'Académie des sciences*, no. Séance du Lundi 21 Octobre (1839): 512-13.
- Daguerre, L.J.M., and J.S. Memes. *History and Practice of Photogenic Drawing on the True Principles of the Daguerreotype, Tr. By J.S. Memes*. 1839.
- Daguerre, Louis Jacques Mandé, and Beaumont Newhall. *An Historical and Descriptive Account of the Various Processes of the Daguerreotype and the Diorama* [in Text of the Manuals in English and French, with French edition following the English]. New York: Winter House, 1971.
- "Daguerreotype." v. Boston, Mass.: J. M. Whittemore, 1847.
- "The Daguerreotype in London." In *The Morning Post*. London, England, 1839.
- "Daguerreotype Portraits." *The Morning Chronicle*, September 12 1840.
- "The Daguerreotype; or, Nature Delineated by Herself." In *Times*. The Times Digital Archive London, Tuesday, March 3, 1840: 3
- "Daguerreotypes - Mr. Pattinson's Address to the Literary and Philosophical Society." *Newcastle Chronicle*, December 5, 1840.
- Dallmeyer, John Henry. "United States Patent Office; Compound Lens for Photographic Portraiture." June 11, 1867.
- Davis Jr, Daniel. "Improvement in Coloring Daguerreotype-Pictures." edited by United States Patent Office: Plumbe Jr, John, 1842.

Robinson: The Techniques and Material Aesthetics of the Daguerreotype

- Davy, Humphrey. "Some Experiments and Observations on a New Substance Which Becomes a Violet Coloured Gas by Heat." *Philosophical Transactions of the Royal Society* (1814).
- de Valicourt, E. "A New and Complete Photographic Manual for Metal Plates and Paper -- Containing All the Latest Discoveries. Translated from the French of E. De Valicourt, by A. B. W. Grigg", *The Photographic and Fine Art Journal* 7 (1854).
- . *Nouveau manuel complet de photographie sur métal, sur papier et sur verre*. Paris: Roret, 1851.
- . *Nouveau manuel complet de photographie sur métal, sur papier et sur verre*. Paris: Roret, 1862.
- Description of the Establishment of Cornelius and Baker, Manufacturers of Lamps, Chandeliers and Gas Fixtures, Philadelphia*. Chandler, 1860.
- "Diorama." *Journal des Artistes* 13, September 27 (1835): 202-4
- Draper, John W. "Chemistry and Physics Experiments [Manuscript]: Journal, 1836-1842." In *Draper Family Collection*, edited by National Museum of American History Smithsonian Institution. Washington DC: Dibner Library.
- . "Experiments on Solar Light, Decomposition of the Salts of Silver." *Journal of the Franklin Institute* 20 (1837): 45.
- . "On Some Analogies between the Phenomena of the Chemical Rays and Those of Radiant Heat." *London, Edniburgh, and Dublin Philosophical Magazine and Journal of Science* 19, no. 123 (1841): 195-210.
- . "Remarks on the Daguerreotype." *The American Repertory of Arts, Sciences, and Manufactures* (New York) 6, no. 1 (July 1840): 401-4.
- Dumas, J. B. "Discours De M. Le Sénateur Dumas, Président." *bulletin de la societe d'encouragement pour l'industrie nationale* XI, no. deuxième série (April 6 1864): 194-201.
- Dupré, Sven. "Introduction. The Hockney-Falco Thesis: Constraints and Opportunities." *Early Science and Medicine* 10, no. 2 (2005): 125-36.
- Eder, J.M. *Ausführliches Handbuch Der Photographie: Die Photographischen Objektive*. W. Knapp, 1899.
- Eder, J.M., and E. Epstean. *History of Photography*. Dover Publications, 1978.
- Edwards, E., and J. Hart. *Photographs Objects Histories: On the Materiality of Images*. Taylor & Francis, 2004.

Robinson: The Techniques and Material Aesthetics of the Daguerreotype

- Edwards, Steve. "'Beard Patentee': Daguerreotype Property and Authorship." *Oxford Art Journal* 36, no. 3 (2013): 369-94.
- Essai de théorie daguerrienne et résultats pratiques par un Professeur de sciences.* J. B. Gros, 1844.
- Falco, Charles M. "The Hockney-Falco Thesis." <https://wp.optics.arizona.edu/falco/art-optics/>. (Date accessed, 17 March 2017)
- Figuier, Louis. *Merveilles de la science*. Paris: Jouvet & Cie, 1869.
- Fisher, George Thomas [Jr.]. *Photogenic Manipulation: Containing Plain Instructions in the Theory and Practice of the Arts of Photography, Calotype, Cyanotype, Ferrotypes, Chrysotype, Anthotype, Daguerreotype, Thermography.* By George Thomas Fisher, Jun. Illustrated by Wood Cuts. London: Published by George Knight and Sons ..., 1843 (Printed by Stewart and Murray), 1843.
- Fisher, Robert, M.D. "The Beard Photographic Franchise in England: An Overview of the Licensed Daguerreotype Portrait Galleries and Their Products in the 40's." *The Daguerreian Annual: Official Yearbook of the Daguerreian Society* (1992): 75.
- Fizeau, Armande Hippolyte Louis. "Chimie appliquée. — Note sur un moyen de fixer les images photographiques." *Compte rendu hebdomadaire des séances de l'Académie des sciences*, no. Séance du Lundi 10 Août (1840): 237-8.
- . "Note sur l'emploi du brôme dans la photographiesur plaqué." *Compte rendu hebdomadaire des séances de l'Académie des sciences*, Séance du Lundi 21 Juin (1841): 1189.
- "Foreign Correspondence." *The Athenaeum, Journal of English and Foreign Literature, Science and the Fine Arts*, no. 587 (January 26, 1839): 69.
- Fors, Hjalmar, Lawrence M. Principe, and H. Otto Sibum. "From the Library to the Laboratory and Back Again: Experiment as a Tool for Historians of Science." *Ambix* 63, no. 2 (2016/04/02 2016): 85-97.
- Fouque, Victor, and Edward Epstean. *The Truth Concerning the Invention of Photography: Nicéphore Niépce; His Life, Letters and Works* [in English]. New York: Tennant and Ward, 1935.
- Frazier, Arthur H., *Joseph Saxton and His Contributions to the Medal Ruling and Photographic Arts.* Smithsonian Studies in History and Technology 32: Smithsonian Institution Press, 1975.

Robinson: The Techniques and Material Aesthetics of the Daguerreotype

- Frizot, Michel. "Light Machines: On the Threshold of Invention." In *A New History of Photography*. Köln: Könemann, 1998: 15-21.
- Garrett, Graham W. "Canada's First Daguerreian Image." *History of Photography* 20, no. 2 June 1 (1996): 101-03.
- Gaudin, M. A. "A General View of the Daguerreotype." *The Photographic and Fine Art Journal* 5, no. 1 (January 1853): 5-12.
- Gaudin, M.A. *Traité pratique de photographie, exposé complet des procédés relatifs au Daguerreotype, avec description de sa nouvelle méthode pour travailler au bain d'argent*. J. J. Dubochet, 1844.
- Gernsheim, Helmut, and Alison Gernsheim. *The History of Photography from the Camera Obscura to the Beginning of the Modern Era*. revised 2nd ed.: Thames and Hudson, 1969.
- . *L. J. M. Daguerre (1787-1851) : The World's First Photographer*. Cleveland ; New York: World Pub., 1956.
- . *L.J.M. Daguerre : The History of the Diorama and the Daguerreotype*. 2nd revised ed. New York: Dover, 1968.
- Gillespie, Sarah Kate. *The Early American Daguerreotype: Cross-Currents in Art and Technology*. MIT Press, 2016.
- Gillespie, Sarah Catherine. "Samuel F. B. Morse and the Daguerreotype: Art and Science in American Culture, 1835--1855." 3232008, City University of New York, 2006.
- Goddard, John F. "Letter to Mr. White Esq., Assistant Secretary of the Royal Society." GB 117, The Royal Society, 1864.
- . "Notes, &C., of Discoveries in Daguerreotype, by John Frederick Goddard." GB 117, The Royal Society, 1841.
- . "Valuable Improvement in Daguerreotype." *Literary Gazette; and Journal of the Belles Lettres, Arts, Sciences, &c.*, no. 1247 (December 12 1840): 803.
- Godey's Lady's Magazine* 20 (April 1840): 190.
- González, Edgar, Jordi Arbiol, and Víctor F. Puentes. "Carving at the Nanoscale: Sequential Galvanic Exchange and Kirkendall Growth at Room Temperature." *Science* 334, no. 6061 (2011): 1377-80.
- Goode, W. H. "The Daguerreotype and Its Applications." *American Journal of Science and Arts* (1841): 137-44.

Robinson: The Techniques and Material Aesthetics of the Daguerreotype

- Gooding, David. "Mapping Experiment as a Learning Process: How the First Electromagnetic Motor Was Invented." *Science, Technology, & Human Values* 15, no. 2 (1990): 165-201.
- Gouraud, François. *Description of the Daguerreotype Process, or a Summary of M. Gouraud's Public Lectures, According to the Principles of M. Daguerreotype. With a Description of a Provisory Method for Taking Human Portraits* Boston: Dutton and Wentworth's Print., 1840. Online source, EWER ARCHIVE N8400001 Gary W. Ewer, ed., *The Daguerreotype: an Archive of Source Texts, Graphics, and Ephemera*, <http://www.daguerreotypearchive.org> (Date accessed, 17 March 2017)
- . "Manner of Taking Portraits by the Daguerreotype." *Boston Daily Advertiser and Patriot*, March 26, 1840: 2. Online source, EWER ARCHIVE N8400002 Gary W. Ewer, ed., *The Daguerreotype: an Archive of Source Texts, Graphics, and Ephemera*, <http://www.daguerreotypearchive.org> (Date accessed, 17 March 2017)
- . "Still Life of Plaster Casts." Museum of Fine Arts, Boston, September 7, 1840.
- Greeley, H. *Glances at Europe: In a Series of Letters from Great Britain, France, Italy, Switzerland, Etc., During the Summer of 1851. Including Notices of the Great Exhibition, or World's Fair*. Dewitt & Davenport, 1851.
- Gros, Jean-Baptiste-Louis. "View of the East Facade of the Propylaea on the Acropolis." Collection: Centre Canadien d'Architecture/Canadian Centre for Architecture, Montreal. Athens, 1850.
- . "Chambre obscure blanchie a l'intérieur. Iode et substance accélératrice." *La Lumière* 1, no. 3 (Février 23, 1851 1851): 9.
- . "Quelques notes -- A ajouter a la lettre de M. Le Baron Gros ". In *Recueil de mémoires et de procédés nouveaux concernant la photographie sur plaques métalliques et sur papier*, edited by Charles Chevalier. Paris: Charles Chevalier, 1847.
- . *Quelques notes sur la photographie: Sur plaques métalliques*. revised 2nd edition, July 1850 ed. Paris: Roret, 1850.
- Gunthert, André. "L'inventeur inconnu: Louis Figuiet et la constitution de l'histoire de la photographie française." *Études Photographiques*, no. No. 16 (2005): 6-18.
- Halleur, G.C.H., F. Schubert, and G.L. Strauss. *The Art of Photography: Instructions in the Art of Producing Photographic Pictures*. John Weale, 1854.
- Harmant, Pierre G. "Daguerre's Manual: A Bibliographic Enigma." *History of Photography* 1, no. 1 (January 1977).
- Hearn, Charles W. "New York Correspondence." *The Philadelphia Photographer* 5, no. 53 (1868).

Robinson: The Techniques and Material Aesthetics of the Daguerreotype

- Hellman, K. "Antoine Claudet, a Figure of Photography, 1839--1867." PhD, City University of New York, 2010.
- Henry H. Snelling, ed. "The Photographic and Fine Art Journal." 7 (1854).
- Hilaire-Pérez, Liliane, and Catherine Verna. "Dissemination of Technical Knowledge in the Middle Ages and the Early Modern Era: New Approaches and Methodological Issues." *Technology and Culture* 47, no. 3 (July 2006): 536-65.
- Hill, Levi L. *A Treatise on Daguerreotype; and the Whole Art Made Easy*. Lexington, N. Y.: Holman & Gray, 1850.
- Hogg, J. *Photography Made Easy: A Practical Manual of Photography Containing Full and Plain Directions for the Economical Production of Really Good Daguerreotype Portraits, and Every Other Variety of Photographic Pictures According to the Latest Improvements*. E. Mackenzie, 1845.
- Hogg, Jabez (attributed). "Folkestone Viaduct." daguerreotype, 1843. R. P. S. Collection 2003-5001/2/28227.
- . "Greenwich Hospital." daguerreotype, 1842. National Gallery of Canada collection. LFA 21500_160_5.
- Hubert. "M. Daguerre, la chambre noire, et les dessins qui se font tout seuls." *Journal des Artistes* 2, no. Séance du Lundi 11 Septembre (1836): 166-8.
- Hughes, Jabez. "The Bromine Question and Mr. J. F. Goddard, Being Two Chapters Connected with the Early History of Photography." *The Photographic Journal* 9, no. 145 (MAY 16 1864): 47-49.
- . "The Bromine Question and Mr. J. F. Goddard, Being Two Chapters Connected with the Early History of Photography." *The Photographic News: A Weekly Record of the Progress of Photography* VIII, no. 297 (May 13 1864): 232-33.
- . "The Discoverer and Use of Bromine in Photography: A Few Facts and an Appeal." *British Journal of Photography* (15 December 1863): 487-8.
- . "The Discoverer and Use of Bromine in Photography: A Few Facts and an Appeal." *The Photographic News: A Weekly Record of the Progress of Photography*, no. 12 (11 December 1863): 593-4.
- Humphrey, Samuel Dwight and L. L. Hill ed. *The Daguerreian Journal*. 2, no. 2 (June 1, 1851): adv.

Robinson: The Techniques and Material Aesthetics of the Daguerreotype

- Humphrey, Samuel Dwight. *American Hand-Book of the Daguerreotype ... Containing the Daguerreotype, Electrotype And ... Other Processes ... Fifth Edition*. New York, 1858.
- Humphrey, Samuel Dwight. *Humphrey's Journal of the Daguerreotype & Photographic Arts: Also Embracing the Sciences and Arts Pertaining to Heliography. Second Series*. New York, Published Semi-Monthly by S.D. Humphrey, 546 Broadway. Vol. 3: S.D. Humphrey, 1852.
- Hunt, R. *A Manual of Photography*. J.J. Griffin and co., 1853.
- Hunt, Robert. *A Popular Treatise on the Art of Photography, Including Daguerreotype, and All the New Methods of Producing Pictures by the Chemical Agency of Light*. Glasgow, 1841.
- Isenburg, Matthew R. "Don't Forget to Check Labels for Dating Clues." *The Daguerreian annual : official yearbook of the Daguerreian Society* (1992): 100-03.
- . "Early Equipment." In *The Daguerreian Annual: The Daguerreian Society*, 1993.
- Jacobson, Ken, and Jenny Jacobson. *Carrying Off the Palaces, John Ruskin's Lost Daguerreotypes*. London: Bernard Quaritch Ltd., 2015.
- Johnson, B.P. *Report of Benj. P. Johnson: Agent of the State of New York, Appointed to Attend the Exhibition of the Industry of All Nations, Held in London, 1851*. C. Van Benthuysen, Public Printer, 1852.
- Johnson, Geo. Lindsay M.A., M.D., B.Sc., F.R.C.S. "The History of Daguerre: The Story of His Invention." *The Photographic Journal* 45, no. 3 March (1905): 127-9.
- Johnson, John. "Apparatus for Polishing the Plates Used in Taking Likenesses for Other Objects in Which Such Plates Are Required. Us Letters Patent 2,391, Dec. 14, 1841." Google Patents, 1841.
- Johnson, John. "Daguerreotype." *The Daguerreian Journal*. Vol. 2 (1851): 56-57, 72-80.
- Johnson, Mark S. ed. "Henry Fitz Jr.: A Portfolio of Open Research." *The Daguerreian Annual : Official Yearbook of the Daguerreian Society* (2015): 146-63.
- Kimberly-Clark Corporation (advertisement), "In 1839 Daguerre's Carelessness Gave the World Photography." In *Sales Management: Survey of Buying Power*. Dartnell Corporation, 1934.
- King, H.C. *The History of the Telescope*. 3rd ed.: Dover Publications, 2003.
- Kingslake, Rudolf. "Charles Chevalier and the 'Photographe a Verres Combines'." *Image, Bulletin of the George Eastman House of Photography* 10, no. 5 (1961): 17-19.
- Krone, H., and I. Schmidt. *Die Für Alle Zeit Von Praktischem Wert Bleibenden Photographischen Urmethoden*. Fotokinoverlag, 1985.

Robinson: The Techniques and Material Aesthetics of the Daguerreotype

- Laborde, C. "Moyen certain de prévenir le voile des substances accélératrices, et de donner plus de sensibilité à la couche impressionnable." *L'Echo du monde savant, travaux des savants de tous les pays dans toutes les sciences*. 11, no. 13 (Jeudi, 15 Août 1844): 304.
- Lerebours, Noel Paymal. "Sur un nouveau procédé d'iodage pour les planches destinées à recevoir des images photographiques, procédé qui abrège considérablement; la durée du temps nécessaire pour que la lumière produise une impression suffisante." *Compte rendu hebdomadaire des séances de l'Académie des sciences*, no. Séance du Lundi 7 Juin (1841): 1059.
- . *A Treatise on Photography; Containing the Latest Discoveries and Improvements Appertaining to the Daguerreotype*. By N. P. Lerebours. Translated by J. Egerton. London: Longman, Brown, Green, and Longmans, 1843.
- . *Traité de photographie, derniers perfectionnements apporté au Daguerreotype, Quatrième Édition*. Paris, 1843.
- Levitt, T. "Biot's Paper and Arago's Plates - Photographic Practice and the Transparency of Representation." [In English]. *Isis* 94, no. 3 (Sep 2003): 456-76.
- The London Journal of Arts and Sciences*. London: Sherwood, Neely, and Jones, 1840.
- Lowry, Bates, and Isabel Lowry. "Secrets of the White Chamber." *The Daguerreian Annual: Official Yearbook of the Daguerreian Society* (2002-2003): 332-41.
- Lubbock, John William. "The Correspondence of William Henry Fox Talbot." Leicester: DeMontfort University, 1839.
- Mabee, C. *The American Leonardo: A Life of Samuel F.B. Morse*. A.A. Knopf, 1943.
- Marbot, B., B. de France, M. Art, and M. du Petit Palais. *After Daguerre: Masterworks of French Photography (1848-1900) from the Bibliothèque Nationale*. Metropolitan Museum of Art, 1980.
- Marignier, Jean-Louis. "Heliography: New Light on the Invention of Photography." *The Daguerreian Annual: Official Yearbook of the Daguerreian Society* (1996): 53-63.
- Mayall, J. E. "Letter from John E. Mayall to George Pyle." In *Gift of Francis C. Pyle Estate*: Chester County Historical Society, 1846.
- . "Receipt from John Mayall to George Pyle for Instructions in the Art of Daguerreotype Pictures." In *Gift of Francis C. Pyle Estate*: The Chester County Historical Society, 1846.

Robinson: The Techniques and Material Aesthetics of the Daguerreotype

- Mayer, and Pierson. " Histoire de sa découverte." In *La photographie*. Paris: Librairie L. Hachette et Cie., 1862.
- Mellish, Bob. "Achromatic Doublet Lens Diagram." CC-BY-SA-3.0 (<http://creativecommons.org/licenses/by-sa/3.0/>), via Wikimedia Commons from Wikimedia Commons 2006.
- . "Chromatic Aberration Lens Diagram." CC-BY-SA-3.0 (<http://creativecommons.org/licenses/by-sa/3.0/>), via Wikimedia Commons from Wikimedia Commons 2006.
- Moore, Charles Leroy. *Two Partners in Boston: The Careers and Daguerreian Artistry of Albert Southworth and Josiah Hawes*. (Volumes I and II). 1975.
- Morse, Samuel Finley Breese. "The Daguerrotipe." *New-York Observer*, April 20, 1839, 62.
- . "Memoranda of Daguerreotype." In *Samuel Finley Breese Morse papers, 1793-1944*: Library of Congress, 1840.
- . "Who Made the First Daguerreotype in This Country?". *The Photographic and Fine Art Journal* 8 (1855): 280.
- Mower, Gilman &. *The Photographer's Guide: In Which the Daguerrean Art Is Familiarly Explained*. Lowell, MA: Samuel O. Dearborn. Printer, 1842. (Facsimile reproduction edition of 50, gift from Gary Ewer)
- Musée Carnavalet and Paris (France). Direction des affaires culturelles. *Paris et le Daguerreotype*. [Paris]: Paris-Musées, 1989.
- Newhall, Beaumont. "An Announcement by Daguerre." *Image: Journal of Photography of the George Eastman House* 8, no. 1 (March 1859): 32-36.
- . *The Daguerreotype in America*. 3rd revised ed. ed. New York: Dover Publications [etc.]; London : Constable, 1976.
- . *The History of Photography: From 1839 to the Present*. Fifth ed.: Museum of Modern Art, 1982.
- Newton, W. *The London Journal of Arts and Sciences, and Repertory of Patent Inventions*. Sherwood, Gilbert, and Piper, 1843.
- Nickel, Douglas R. "Notes Towards New Accounts of Photography's Invention." In *Photography and Its Origins*, edited by T. Sheehan and A. Zervigon, Taylor & Francis, 2014: 104-16.

Robinson: The Techniques and Material Aesthetics of the Daguerreotype

- Niépce, N., M. Bonnet, and J.L. Marignier. *Niépce, correspondance et papiers*. Maison Nicéphore Niépce, 2003.
- "On the Application of the Daguerreotype to the Taking of Likenesses from the Life." *The Polytechnic Journal: A Monthly Magazine of Art, Science, and General Literature*, no. v. 4, nos. 1-6 (April 1841 1841): 248-51.
- "On the Discovery of M. Daguerre." *Chemist A Monthly Journal of Chemical and Physical Science* 1 (1840): 18-9.
- Page, Charles G. "Letter to A. S. Southworth." In *National Gallery of Canada collection*, April 14, 1843.
- . "Mode of Coloring Daguerreotype Pictures." *Journal of the Franklin Institute* 37, no. 5 (1844 1844): 312-13.
- "Paris Letter." *The Literary Gazette and Journal of the Belles Lettres, Arts, Sciences, &c* (March 18, 1843 1843): 185-86.
- Patents for Inventions: Abridgements of Specifications Relating to Photography*. Part 1. George E. Eyre and William Spottiswoode ed., Great Britain Patent Office. 1861.
- "The Photographic or Daguerreotype Miniatures." *Times*, 1841, Wednesday, Mar 24, 1841; pg. 6; Issue 17626.
- "Photography at the American Institute." *The American Journal of Photography and the Allied Arts and Sciences* Vol. 1 (1858): 10.
- "Physique. - Mémoire sur le rayonnement chimique qui accompagne la lumière solaire et la lumière électrique; Par M. Ed. Bequerel. (3e Mémoire. - Extrait Par L'auteur.)" *Compte rendu hebdomadaires des séances de l'Académie des sciences*, no. Séance du Lundi 2 Novembre (1840): 702-3.
- Pinson, S.C. *Speculating Daguerre: Art and Enterprise in the Work of L. J. M. Daguerre*. University of Chicago Press, 2012.
- Pobboravsky, Irving. "The Daguerreotype Plate as Seen by a Contemporary Daguerreian Artist." *The Daguerreian Annual: Official Yearbook of the Daguerreian Society* (1991): 114-22.
- . "Study of Iodized Daguerreotype Plates." Information Service, Graphic Art Research Center, Rochester Institute of Technology, 1971.
- Porta, G.D. *Magiae Naturalis Sive De Miraculis Rerum Naturalium Libri IV*. 1561.

Robinson: The Techniques and Material Aesthetics of the Daguerreotype

- Powel, Pamela. "The Daguerreotype: Portraiture at the Dawn of Photography." In *The Daguerreian Annual : Official Yearbook of the Daguerreian Society*, 60-1: The Daguerreian Society, 2000.
- Prangey, Joseph-Philibert Girault de. "Athènes. 1842. Propylées. Pris de l'intérieur." Christies, Important Daguerreotypes by Joseph-Philibert Girault de Prangey from the Archive of the Artist - Part II: Tuesday 18 May 2004, Lot 91. Athens, 1842.
- Pritchard, Michael. "The Development and Growth of British Photographic Manufacturing and Retailing 1839-1914." De Montfort University, 2010.
- Proceedings of the American Philosophical Society*. Vol. II: American Philosophical Society., 1842.
- Pyle, George. "George Pyle's Lesson Book Containing Notes from Mayall's Lectures." In *Gift of Francis C. Pyle Estate*: The Chester County Historical Society, 1846.
- Ravines, P., A. West, J. Minter, and R. Gutierrez, Jr. "The Daguerreotype under High Magnification: An Ultra-High Resolution Sem Study of a 19th Century Daguerreotype's Surface Nanostructure." In *International Materials Research Congress, IMRC-Cancun 2009, and 2nd Latin-American Symposium on Physical and Chemical Methods in Archeology*. Cancun: Art and Cultural Heritage Conservation & Archaeological and Arts Issues in Materials Science, IMRC 2009, 2009.
- Ravines, Patrick, Lingjia Li, Lisa Chan, and Rob McElroy. "Some Science Behind the Daguerreotype: Nanometer and Sub-Micrometer Realities on and beneath the Surface." In *Nanoscience and Cultural Heritage*: Atlantis Press, 2016.
- Ravines, Patrick, Lingjia Li, and Rob McElroy. "An Electron Microscopy Study of the Image Making Process of the Daguerreotype, the 19th Century's First Commercially Viable Photographic Process." *Journal of Imaging Science and Technology* 60, no. 3 (May 2016): 10.
- Reports by the Juries on the Subjects in the Thirty Classes into Which the Exhibition Was Divided*. Royal commission, 1852.
- Rinhart, Floyd, and Marion Rinhart. *The American Daguerreotype*. Athens: University of Georgia Press, 1981.
- Ritchey, Tom. "Analysis and Synthesis: On Scientific Method – Based on a Study by Bernhard Riemann." *Systems Research* 8, no. 4 (1991): 21-41.
- Roach, John. "Letter to Mr. Van Deusen." Manuscript, collection of Dan Colucci.
- Robinson, Michael. "The Making of Twenty Daguerreotypes." *The Daguerreian Annual: Official Yearbook of the Daguerreian Society* (2000): 239-67.

Robinson: The Techniques and Material Aesthetics of the Daguerreotype

- Robinson, Michael. "A Style Peculiar to Themselves: An Investigation into the Techniques of Southworth and Hawes." In *Young America: The Daguerreotypes of Southworth & Hawes*, 552 p. (152 p. of plates). New York: International Center of Photography; Rochester, NY: George Eastman House ; Gottingen: Steidl, 2005.
- Robinson, Michael, and Edward P. Vicenzi. "A Twin Paradox: A Study of Preservation and Disfigurement of Southworth and Hawes Daguerreotypes." *Topics in Photographic Preservation* 16 (2015): 196-97.
- Rocke, Alan J. *Nationalizing Science: Adolphe Wurtz and the Battle for French Chemistry*. MIT Press, 2001.
- Romer, Grant. B and Brian Wallis, Southworth, Hawes, International Center of Photography, and George Eastman House. *Young America: The Daguerreotypes of Southworth and Hawes*. International Center of Photography, 2005.
- Romer, Grant B. "Daguerre in the Library." In *Imagining Paradise: The Richard and Ronay Menschel Library at George Eastman House, Rochester*, 27-33: Steidl, 2007.
- . "What Is a Photograph?". Chap. Part 1 History of Photograph Conservation; Reading 14. In *Issues in the Conservation of Photographs*, edited by Debra Hess Norris and Jennifer Jae Gutierrez, 108-9. Los Angeles: The Getty Conservation Institute, 2010.
- Root, M.A. *The Camera and the Pencil, or, the Heliographic Art: Its Theory and Practice in All Its Various Branches ... : Together with Its History in the United States and in Europe: Being at Once a Theoretical and a Practical Treatise, and Designed Alike, as a Text-Book and a Hand-Book: Illustrated with Fine Engravings on Steel and on Wood*. M.A. Root, 1864.
- Roquencourt, Jacques "Daguerre et l'optique." *Études Photographiques* No. 5 (1998).
- Ryder, James Fitzallan. *Voigtländer and I in Pursuit of Shadow Catching; a Story of Fifty-Two Years' Companionship with a Camera*. Cleveland: Cleveland Printing & Publishing Co., 1902.
- Sachse, Julius F. "Early Daguerreotype Days II." *American Journal of Photography* v. 13, no. 151 (July 1892): 306-8.
- Schaaf, Larry J. "Niépce Abroad: Britain in 1827 & 1839 - Russia in 1839 & 1994." In *Nicéphore Niépce, Une Nouvelle Image*, 100-06. Chalon: La Société des amis du Musée Nicéphore Niépce, 1998.
- Schaaf, Larry J. *Out of the Shadows: Herschel, Talbot and the Invention of Photography*. Yale University Press, 1992.

Robinson: The Techniques and Material Aesthetics of the Daguerreotype

- Schreiner, Charlie. "In Their Own Words." *The Daguerreotypist: a Newsletter for Contemporary Daguerreotypists* 2012, no. March 30, 2012 (1998).
- Schwartz, Joan M. "Un Beau Souvenir Du Canada: Object, Image, Symbolic Space." In *Photographs Objects Histories: On the Materiality of Images*, edited by E Edwards and J. Hart, 116-31: Taylor & Francis, 2004.
- Schwartz, Vanessa R. "Color in the History of Photography." Paper presented at the Photography Historians: A New Generation?, Ryerson Image Centre, March 26-28, 2015.
- Sherman, William H. "The Rise and Fall of the Daguerreotype." *The Photographic Times and American Photographer* 21 (1891).
- Shive, David. "Machine- for Polishing Daguerreotype-Plates." Google Patents, 1855.
- Simons, Montgomery. P. *Photography in a Nut Shell; or, the Experience of an Artist in Photography, on Paper, Glass and Silver,; With Illustrations*. Philadelphia: Printed by King & Baird, no. 607 Sansom Street., 1858.
- Skegagur [sp], J. M., "Letter to J. H. Mifflin Esquire, Fellow Daguerreian in Savannah Georgia." National Gallery of Canada collection, date Feb. 16, 1843.
- Smith, P.H. *The Body of the Artisan: Art and Experience in the Scientific Revolution*. University of Chicago Press, 2004.
- Smith, P.H., A.R.W. Meyers, and H. Cook. *Ways of Making and Knowing: The Material Culture of Empirical Knowledge*. University of Michigan Press, 2014.
- Snelling, Henry Hunt. *The History and Practice of the Art of Photography, or, the Production of Pictures through the Agency of Light: Containing All the Instructions Necessary for the Complete Practice of the Daguerrean and Photogenic Art, Both on Metallic Plates and on Paper*. G.P. Putnam, 1849.
- Snelling, Henry Hunt ed. *The Photographic Art-Journal* 2, no. 2 (August 1851): 127.
- . "Photography -- Its Rise and Progress." *The Photographic and Fine Art Journal* 8, no. 1 (January 1855): 4-6.
- Southworth, Albert Sands. "Suggestions to Ladies Who Sit for Daguerreotypes." *Lady's Almanac* (1854): 103.
- . "The Massachusetts Register: A State Record for the Year 1852, Containing a Business Directory of the State with a Variety of Useful Information." George Adams, 1852.

Robinson: The Techniques and Material Aesthetics of the Daguerreotype

- Southworth, Albert Sands. "The Early History of Photography in the United States." In *Photography: Essays and Images*, edited by Beaumont Newhall: The Museum of Modern Art, 1980.
- Southworth, Albert S., and Josiah J. Hawes. "Reverend Rollin Heber Neale." George Eastman Museum, 1974:0193:0141.
- . "Unidentified Woman." daguerreotype, ca. 1850. George Eastman Museum, 1974:0193:0317, 1974:0193:0480, 1974:0193:0329, 1974:0193:0783.
- Southworth, Albert Sands. "The Early History of Photography in the United States." *The British Journal of Photography* 18, no. November (1871): 530-32.
- Southworth, Albert Sands, and Josiah Johnson Hawes. "Improvement in Apparatus for Holding Plates for Polishing, United States Patent 4573." Google Patents, 1846.
- Stapp, William F., Robert Cornelius, Marian S. Carson, M. Susan Barger, and National Portrait Gallery (Smithsonian Institution). *Robert Cornelius : Portraits from the Dawn of Photography*. Washington, D.C.: Published for the National Portrait Gallery by the Smithsonian Institution Press, 1983.
- Starl, Timm. "The Use and Spread of the Daguerreotype Process." In *A New History of Photography*, edited by Michel Frizot, 39-40. Köln: Könemann, 1998.
- Stork, David G. "Computer Vision and Image Analysis in the Study of Art: Hockney Theory." <http://www.diatrope.com/stork/FAQs.html>.
- Stulik, Dr. Dusan C. 2011.
- Stulik, Dr. Dusan C., and Art Kaplan. "Niépce and Daguerre: Daguerre and Niépce " In *The Daguerreian Society Symposium*. St. Petersburg, Florida: Getty Conservation Institute, 2011.
- Surface, Matthew ed. "The First Full-Length Child Portait." *The Practical Photographer* (June 1, 1894).
- Sutton, Thomas. "The Daguerreotype Process." *Photographic Notes, Journal of the Photographic Society of Scotland and of the Manchester Photographic Society* 1 (1856): 112.
- Swan, Alice, C. E. Fiori, and K. F. J. Heinrich. "Daguerreotypes: A Study of the Plates and the Process." *Scanning Electron Microscopy* 1 (1979): 411-24.
- Swiderski, R.M. *Calomel in America: Mercurial Panacea, War, Song and Ghosts*. BrownWalker Press, 2008.

Robinson: The Techniques and Material Aesthetics of the Daguerreotype

- Talbot, W.H.F. "The Correspondence of William Henry Fox Talbot." Leicester: DeMontfort University. <http://foxtalbot.dmu.ac.uk/> (Date accessed, 17 March 2017)
- Talbot, W.H.F. "Meeting of the British Association for the Advancement of Science." *The Athenaeum*, no. 618 (September 16 1839): 643.
- Taylor, Roger. "Photographic Exhibitions in Britain 1839 - 1865." <http://peib.dmu.ac.uk/detailphotographer.php?photogNo=73&inum=31&listLength=230&orderBy=coverage>. (Date accessed, 17 March 2017)
- Thompson, Warren. "Plaques Pour Le Daguerreotype Argentées." *La Lumière* (May 11 1851): 56.
- Towler, J. *The Silver Sunbeam: A Practical and Theoretical Text-Book on Sun Drawing and Photographic Printing*. Joseph H. Ladd, 1864. Facsimile ed. Morgan & Morgan, NY. 1969.
- Towson, J. T. "On the Proper Focus for the Daguerreotype." *The London, Edinburgh, and Dublin Philosophical Magazine and Journal of Science* XC, no. XCVII (November 1839): 381-84.
- Usselman, Melvyn C. "Michael Faraday's Use of Platinum in His Researches on Optical Glass." *Platinum Metals Review* 27, no. 4 (1983): 175-81.
- Usselman, Melvyn C., Alan Rocke, Christina Reinhart, and Kelley Fousler. "Restaging Liebig: A Study in the Replication of Experiments." *Annals of Science* 62, no. 1 (2005): 1-55.
- van Ravenswaay, Charles. "August P. Brassart, an Associate of Daguerre." *Image: Journal of Photography of the George Eastman House* 3, no. 3 (March, 1954): 18.
- Vicenzi, Edward P., T. Landin, and T. Herraiz. "Examination of a 19th Century Daguerreotype Photograph Using High Resolution Scanning Transmission Electron Microscopy for 2d and 3d Nanoscale Imaging and Analysis." *Microscopy and Microanalysis* 20, no. S3 (2014): 2000-01.
- Vicenzi, Edward P., T. Landin, A. A. Herzig, B. Stripe, and V. Rose. "On the Nanoscale Chemistry of a 19th Century Daguerreotype Photograph." In *23rd Australian Conference on Microscopy and Microanalysis (ACMM23) and the International Conference on Nanoscience and Nanotechnology (ICONN 2014) and Nanoscale Spectroscopy and Nanotechnology 8*. Adelaide Convention Centre, South Australia and Gleacher Center, Chicago, 2014.
- Von Liebig, Justus. "Induction and Deduction." *The Cornhill Magazine*, July to December 1865, 296-305.

Robinson: The Techniques and Material Aesthetics of the Daguerreotype

- . "Sur un nouvel appareil pour l'analyse des substances organiques; et sur la composition de quelques-unes de ces substances." *Annales de chimie et de physique* 47, no. 2 (1831): 147-97.
- Waller, Augustus, M.D. "Experiments on the Coloured Films Formed by Iodine, Bromine, and Chlorine Upon Various Metals." *London and Edinburgh Philosophical Magazine and Journal of Science*, no. 21 (1842): 422-27.
- Watson, R., and H. Rappaport. *Capturing the Light: The Birth of Photography, a True Story of Genius and Rivalry*. St. Martin's Press, 2013.
- Werge, John. *The Evolution of Photography with a Chronological Record of Discoveries, Inventions, Etc.* London: Piper & Carter, 1890.
- Wey, Francis. "Comment le soleil est devenu peintre. Histoire du Daguerreotype et de la photographie." *Musée des familles XX* (juin 1853, p. 257-265, juillet 1853, p. 289-300 1853).
- . "Des progrès et de l'avenir de la photographie." *La Lumière : journal non politique hebdomadaire: beaux-arts, héliographie, sciences* 1, no. 35 (Octobre 5 1851).
- White, E. "Invoice for Voigtlander ½ Plate Camera (Lens) " National Gallery of Canada collection, 1846.
- Wilder, Kelley E. "Ingenuity, Wonder and Profit: Language and the Invention of Photography." Oxford University, 2003.
- Wolcott, Alexander S. "Letter to J. J. Mapes, Editor in Mr. A. S. Wolcott's Improvements on the Daguerreotype." *The American repertory of arts, sciences, and manufactures* 3, no. 1 (March 13, 1840): 193-97.
- . "On the Daguerreotype." *The American Repertory of Arts, Sciences, and Manufactures* 6, no. 2 (January 1841): 401-05.
- Wood, John. *The Daguerreotype : A Sesquicentennial Celebration*. 1st ed. Iowa City: University of Iowa Press, 1989.
- Wood, R. Derek. "The Daguerreotype Patent, the British Government, and the Royal Society." *History of Photography* 4, no. No. 1 (January 1980): 53-9.
- . "Ste Croix in London. 1839." *History of Photography* 17, no. 1 (1993): 101-7.