

This is a repository copy of *Energy transfer catalysis mediated by visible light : principles, applications, directions*.

White Rose Research Online URL for this paper:  
<https://eprints.whiterose.ac.uk/151872/>

Version: Accepted Version

---

**Article:**

Strieth-Kalthoff, Felix, James, Michael J. [orcid.org/0000-0003-2591-0046](https://orcid.org/0000-0003-2591-0046), Teders, Michael et al. (2 more authors) (2018) Energy transfer catalysis mediated by visible light : principles, applications, directions. *Chemical Society Reviews*. pp. 7190-7202. ISSN 0306-0012

<https://doi.org/10.1039/c8cs00054a>

---

**Reuse**

Items deposited in White Rose Research Online are protected by copyright, with all rights reserved unless indicated otherwise. They may be downloaded and/or printed for private study, or other acts as permitted by national copyright laws. The publisher or other rights holders may allow further reproduction and re-use of the full text version. This is indicated by the licence information on the White Rose Research Online record for the item.

**Takedown**

If you consider content in White Rose Research Online to be in breach of UK law, please notify us by emailing [eprints@whiterose.ac.uk](mailto:eprints@whiterose.ac.uk) including the URL of the record and the reason for the withdrawal request.

## Energy Transfer Catalysis Mediated by Visible Light: Principles, Applications, Directions

Felix Strieth-Kalthoff, Michael J. James, Michael Teders, Lena Pitzer and Frank Glorius\*

Received 00th January 20xx,  
Accepted 00th January 20xx

DOI: 10.1039/x0xx00000x

www.rsc.org/

Harnessing visible light to access excited (triplet) states of organic compounds can enable impressive reactivity modes. This tutorial review covers the photophysical fundamentals and most significant advances in the field of visible-light-mediated energy transfer catalysis within the last decade. Methods to determine excited triplet state energies and to characterize the underlying Dexter energy transfer are discussed. Synthetic applications of this field, divided into four main categories (cyclization reactions, double bond isomerizations, bond dissociations and sensitization of metal complexes), are also examined.

### Key learning points

- Photophysical fundamentals of triplet-triplet energy transfer in solution.
- Analysis and prediction of triplet-triplet energy transfer rates and efficiencies.
- Applications of visible-light-mediated triplet-triplet energy transfer in organic synthesis.

### 1. Introduction

Excited (triplet) states exhibit unique reactivity modes, which differ significantly from the reactivity of the corresponding ground states.<sup>1</sup> Based on changes in polarizability, bond strengths or spin multiplicity, excited state reactivity has been used to enable a variety of different synthetic transformations, including pericyclic reactions, atom abstraction reactions or isomerization processes.<sup>2</sup> The most straightforward method to access these valuable excited (triplet) states is through a direct photoexcitation approach. However, due to the distinct absorption properties of most (organic) molecules, this typically requires harsh UV light irradiation, which has a negative impact on the selectivity, functional group tolerance and general applicability of the reaction.<sup>3,4</sup> To circumvent these issues, an alternative strategy employing milder conditions to access excited (triplet) states has been developed – visible-light-mediated photocatalysis.

Within the field of visible-light-mediated photocatalysis, and for the context of this review, electron and energy transfer processes need to be clearly distinguished. Electron transfer photocatalysis (photoredox catalysis) utilizes the high redox activity of an excited state molecule to induce a single electron transfer (SET) event. Whilst this sub-division has received great interest within the last decade,<sup>5,6</sup> the field of energy transfer (EnT) catalysis has remained relatively underdeveloped. Energy

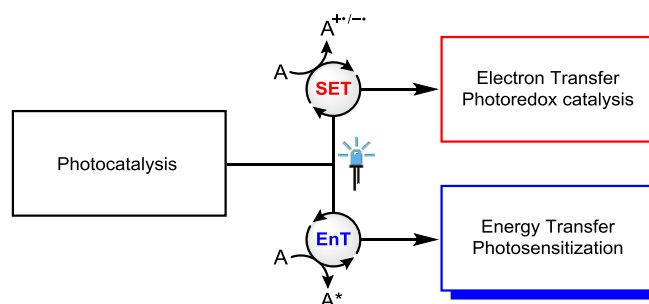

**Figure 1.** Simplified terminology of photocatalysis, as used throughout this review.

transfer is formally defined as “the photophysical process in which an excited state of one molecular entity (the donor D) is deactivated to a lower-lying state by transferring energy to a second molecular entity (the acceptor A), which is thereby raised to a higher energy state.”<sup>7</sup>

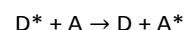

In this regard, the photocatalyst resembles the donor, which is excited by the direct absorption of visible light. The excited photocatalyst can subsequently transfer its excited state energy to the respective substrate (the acceptor), which is “indirectly excited” or “sensitized”. For clarity, the terms *photoredox catalyst* or *photosensitizer* can be used to describe excited photocatalysts which undergo SET or EnT, respectively (Figure 1).<sup>6</sup> However, it should be noted that many photoredox catalysts are also powerful photosensitizers, which can make deciphering their true mode of action difficult.

Westfälische Wilhelms-Universität Münster  
Organisch-Chemisches Institut  
Corrensstrasse 40, 48149 Münster (Germany)  
E-mail: glorius@uni-muenster.de  
Homepage: <http://www.uni-muenster.de/Chemie.oc/glorius/>

This tutorial review aims to provide a concise overview of the photophysical principles required to rationalize EnT and the recent emergence of synthetic methods using EnT catalysis. Finally, a short discussion on the potential future directions of this field is also provided.

## 2. Photophysical Fundamentals

All visible-light-mediated EnT processes initiate via the electronic excitation of the donor/photosensitizer (most commonly a transition metal complex or an organic dye) as depicted in Figure 2: First, absorption of a photon leads to excitation from the  $S_0$  state to an excited singlet state  $S_1$ . This mostly short-lived singlet state then rapidly decays back to the ground state (e.g. via internal conversion or fluorescence) or undergoes intersystem crossing to its triplet state ( $T_1$ ). As both non-radiative decay and emission are spin-forbidden from this triplet state, it possesses a lifetime of  $>100$  ns in solution, which is sufficient to enable bimolecular quenching processes – in this case EnT to the respective acceptor.<sup>8–10</sup>

In most cases, the acceptor does not exhibit significant visible light absorption, which therefore requires a non-radiative mechanism to be operative.<sup>11</sup> Two different mechanisms for non-radiative EnT have been proposed, which directly correspond to the two fundamental electron-electron interactions derived from quantum mechanics – namely coulombic interactions and exchange interactions.<sup>12</sup>

The first mechanism proceeds by means of classical dipole-dipole (coulombic) interactions, where energy can be transferred *via* a transmitter-antenna mechanism: Electronic oscillation in the excited state donor  $D^*$  induces a dipole and thus electronic oscillation in the ground state acceptor by charge repulsion through an electromagnetic field – or simply speaking, through space. A resonant interaction between donor and acceptor would eventually lead to the desired electronic

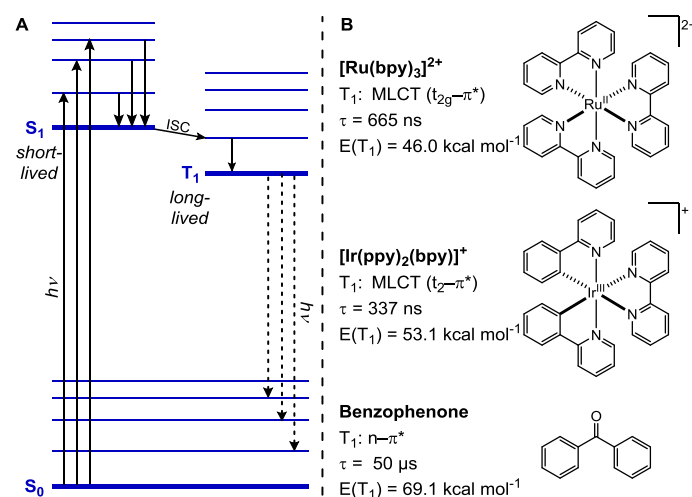

**Figure 2.** a) Simplified Jablonski diagram of photoexcitation from the singlet ground state  $S_0$  to the corresponding excited  $S_1$  state and intersystem crossing to the long-lived triplet states ( $T_1$ ). b) Triplet state properties (lifetime  $\tau$ , energy  $E_T$ ) of selected photosensitizers.<sup>10</sup>

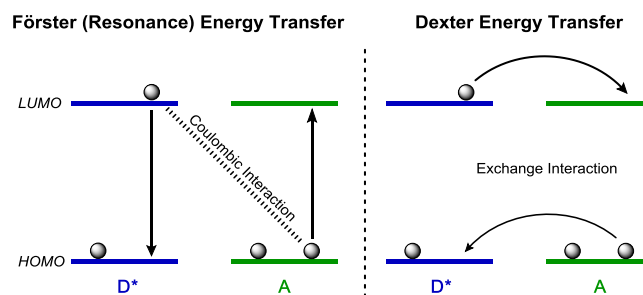

**Figure 3.** Schematic depiction of Förster and Dexter EnT processes.

transition, i.e. relaxation of the donor with simultaneous electronic excitation of the acceptor. This mechanism is referred to as *Förster (Resonance) Energy Transfer* (FRET)<sup>13</sup> and plays an important role in natural photosynthesis as well as fluorescence labeling and bioimaging.

However, an EnT process from an photocatalyst's excited triplet state to a substrate in solution cannot be described with Förster's theory. This would require conversion of the photocatalyst triplet state (see above) back to its singlet ground state and, induced by this dipole oscillation, a simultaneous excitation of the substrate from its singlet ground state to an excited triplet state. This would represent two spatially separated spin reversal processes, violating Wigner's spin conservation rules.<sup>14</sup> Considering this, the second fundamental EnT mechanism, which describes the simultaneous intermolecular exchange of ground-state and excited-state electrons, respectively, must be in action (Figure 3). This process was first reported and characterized by Dexter in 1953, during investigations into EnT kinetics:<sup>15</sup>

$$k_{\text{EnT}} = K \cdot J \cdot e^{-\frac{2R_{\text{DA}}}{L}} \quad (1)$$

where  $K$  is a parameter for specific orbital interactions between donor and acceptor: This parameter is e. g. largely influenced by steric repulsion, which can, in turn, have a huge impact on the energy transfer rate.<sup>10</sup>  $J$  represents the spectral overlap integral, which will be discussed later. The term  $R_{\text{DA}}/L$  is a measure of the distance between donor and acceptor. In analogy to Marcus theory for single electron transfer,<sup>16</sup> the rate of Dexter EnT decays exponentially with increasing donor-acceptor separation, dropping to negligibly small values if  $R_{\text{DA}}$  increases to the order of two or more molecular diameters. Consequently, intimate physical contact between donor and acceptor – i.e. orbital overlap – is required for Dexter EnT to occur.<sup>12</sup>

In solution, this leads to the mechanistic scenario depicted in Scheme 1: First, the donor and acceptor approach each other as isolated molecules through diffusion to eventually form a solvent-shared encounter complex. Within this encounter complex, collision and the resulting orbital overlap can lead to the formation of a collision complex, which, due to the greater polarizability of excited state molecules, is stabilized by strong dispersion interactions.<sup>17</sup> Only at this stage are the donor and

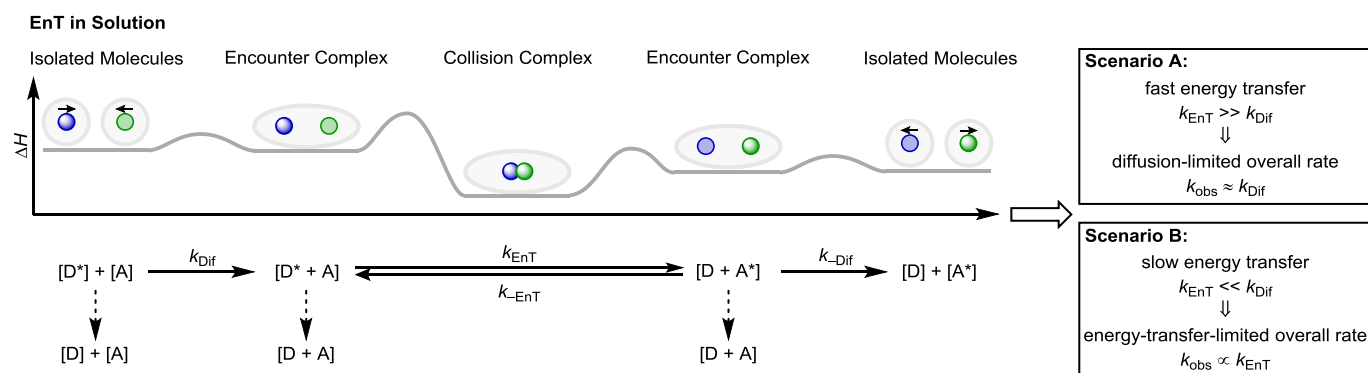

**Scheme 1.** Simplified overview of the molecular processes of triplet-triplet energy transfer in solution. Donor and acceptor diffuse through the solution until formation of an encounter complex. Within this encounter complex, energy transfer can occur by a collision mechanism (exciplex formation). Diffusion out of the solvent cage eventually releases the products of energy transfer. From this mechanistic scenario, two borderline cases, i. e. diffusion and energy transfer control, can be derived.

acceptor sufficiently close enough in space for Dexter EnT to proceed at a meaningful rate. As Dexter EnT is generally reversible, dissociation of the collision complex then leads to the formation of either encounter complex, which eventually releases the EnT products or reaction partners by diffusion out of the solvent cage. It should also be noted that all of the reaction steps described above are in competition with uni- or bimolecular excited state deactivation processes, such as phosphorescence or static quenching. Particularly for donors with comparatively short triplet state lifetimes, triplet deactivation can become a bottleneck for the overall EnT process.<sup>12</sup>

Kinetic analysis of this mechanistic pattern reveals that the overall rate of EnT depends on the rate constant of diffusion, weighted by the probability that EnT occurs during the lifetime of the encounter complex. From this, two borderline scenarios can be derived: **A**) If the EnT event is sufficiently fast, the overall rate will depend on the diffusion rate in solution, governed by temperature and solvent viscosity, or **B**) if EnT is inefficient, solvent effects are negligible and the EnT event itself becomes rate-limiting.<sup>12,18</sup>

Considering equation (1), the rate of EnT in a collision complex is mainly governed by the spectral overlap integral  $J$ . In the context of Dexter EnT, this is defined as

$$J = \int_0^{\infty} f_D(\nu) \cdot \varepsilon_A(\nu) d\nu \quad (2)$$

where  $f_D$  is the normalized donor emission spectrum (phosphorescence spectrum) and  $\varepsilon_A$  is the normalized acceptor (singlet-to-triplet) absorption spectrum. As both spectra are normalized, the rate of Dexter EnT does not depend on the oscillator strengths of the donor or acceptor.<sup>12,15</sup>

In a Jablonski scheme,  $J$  represents the number of  $T_1$ – $S_0$  transitions of the excited donor molecule, which can (energetically) induce a coupled  $S_0$ – $T_1$  transition in the ground-

state acceptor molecule. This number is directly correlated with the number of actual EnT events and consequently the actual rate of EnT.

However, the experimental determination of  $J$  turns out to be challenging in many cases, as particularly singlet-to-triplet absorption spectra are experimentally difficult to access. As a “rule of thumb”, the magnitude of  $J$ , and therefore the EnT efficiency, can be predicted based on the difference in the

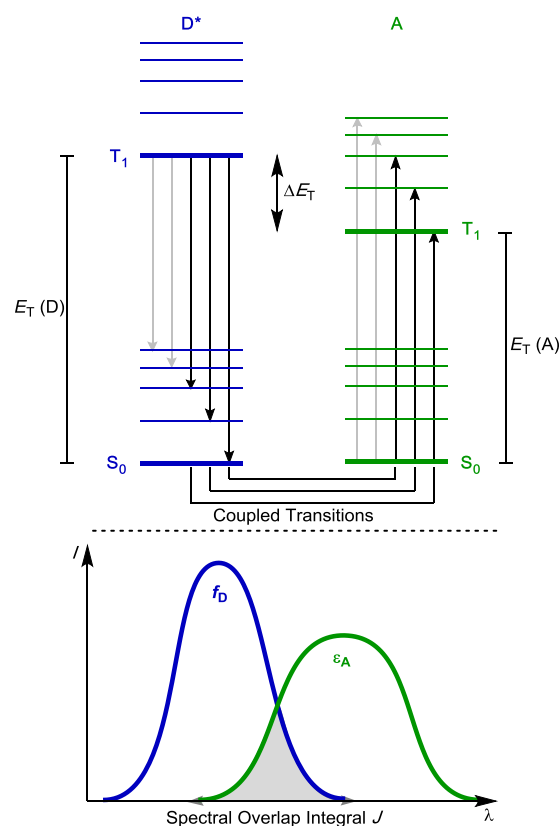

**Figure 4.** Simplified Jablonski Scheme of coupled transitions for collision (Dexter) energy transfer and the corresponding spectral overlap integral. Both absorption and emission spectra are normalized to unity.

triplet excited state energies  $\Delta E_T = E_T(A) - E_T(D)$ , defined as the energy gap between the two  $T_1$  states (see Figure 4).<sup>19</sup>

- A)** For  $\Delta E_T < 0$  (formal “downhill/exergonic” EnT), a large number of coupled transitions exists, which can populate the  $T_1$  state (or higher energy triplet states). It can be assumed that the spectral overlap integral is large. As a consequence, EnT occurs close to diffusion limit.
- B)** For  $\Delta E_T > 0$  (formal “uphill/endergonic” EnT), coupled transitions only exist from excited vibrational or rotational levels of the donor  $T_1$  state. In this regime, the overlap integral should depend on thermal population of the  $T_1$  vibrational and rotational states, i.e. following Boltzmann/Arrhenius-type kinetics, dropping to negligible values for large values of  $\Delta E_T$ :

$$J \propto e^{-\frac{\Delta E_T}{k_B T}} \quad (3)$$

In summary, photosensitized organic reactions in solution proceed via a double electron transfer mechanism (Dexter EnT), which requires diffusion to enable intimate physical contact between the donor and acceptor. The overall rate of EnT is thus dependent on both diffusion rates and the spectral overlap integral  $J$ , which can be estimated from triplet excited state energies.<sup>10,12,18</sup>

### 3. Experimental and Theoretical Approaches

#### Identification and Characterization of Energy Transfer Processes

In most cases, (triplet-triplet) EnT processes can be identified and analysed using transient absorption spectroscopy studies. By performing time-resolved pump-probe experiments, this methodology allows the excited states of the donor and acceptor to be identified and characterized by their respective transient absorption features immediately after direct excitation. Strong evidence for an EnT event can then be obtained by selectively exciting the donor and monitoring if upon addition of the acceptor: 1) the transient absorption

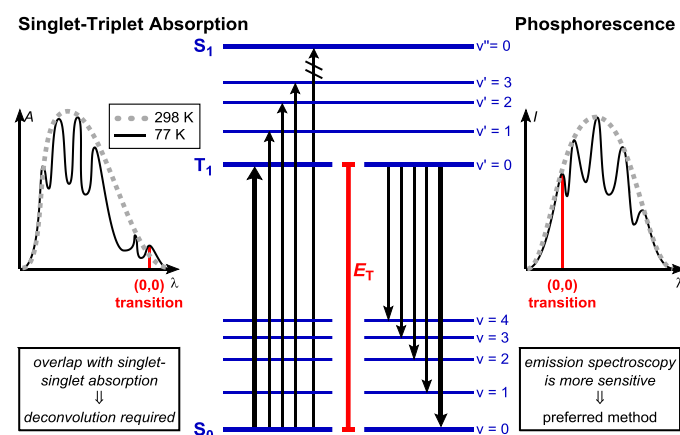

**Figure 5.** Spectroscopic approaches for the determination of the triplet state energy  $E_T$ .

feature of the excited donor is quenched, and 2) the transient absorption feature of the excited acceptor arises. Furthermore, through quantitative analysis of different donor/acceptor ratios, the EnT rate constants (both forward and reverse) can be directly determined using common kinetic models.<sup>18–20</sup>

However, transient absorption studies are often experimentally complex and require specialist equipment which is not widely available in common organic laboratories. In these cases, a number of strategic studies can be carried out to rule out competitive SET pathways and to substantiate the hypothesized EnT process.

First, through classical Stern-Volmer luminescence quenching analysis, electron and energy transfer can often be distinguished. Unlike electron transfer, which includes charge separation, the rate of EnT is largely solvent-independent (see chapter 2). Consequently, variation of the solvent properties (e.g. polarity) will result in similar quenching constants if an EnT process is operative.<sup>12,18</sup> The rate of EnT (and thus, the Stern-Volmer constant  $K_{SV}$ ) is however, greatly dependent on the triplet energy of the sensitizer (as well as other parameters, see above). An experimental correlation between the observed  $K_{SV}$  and the sensitizer's  $E_T$  can therefore serve as evidence for an underlying EnT mechanism.<sup>12,18</sup>

Alternatively, direct excitation experiments with UV light are often very informative and can be used to indicate if excited (triplet) state intermediates are indeed present in the reaction mechanism (see references 21 or 22 as examples). Finally, experimental or theoretical redox potential determination can also be used to exclude electron transfer processes and thus provide indirect evidence of a sensitization mechanism.

#### Determination of Triplet Excited State Energies

Experimentally, triplet excited state energies can be determined through different (spectroscopic) techniques. The preferred (and most reliable) method is to use the short-wavelength band of phosphorescence spectra for the determination of  $E_T$ . Usually, these spectra are recorded at cryogenic temperatures (77 K) in order to achieve the spectral resolution required for clear assignment of the (0,0) transition, which directly corresponds to the triplet excited state energy (see Figure 5).<sup>19</sup>

In principle, the (0,0) transition energy can also be obtained from singlet-triplet absorption spectra. However, this strategy is not generalizable, as the identification of (0,0) bands is difficult in many cases and extensive empirical data deconvolution is usually required. An approximate triplet excited state energy can also be indirectly determined by performing quenching experiments with a series of reference sensitizers or acceptors with known triplet energies. This experimentally tedious method best resembles photosensitization in solution, but provides a range of values rather than a precise triplet excited state energy.<sup>19</sup>

## a) Literature-known Photosensitizers

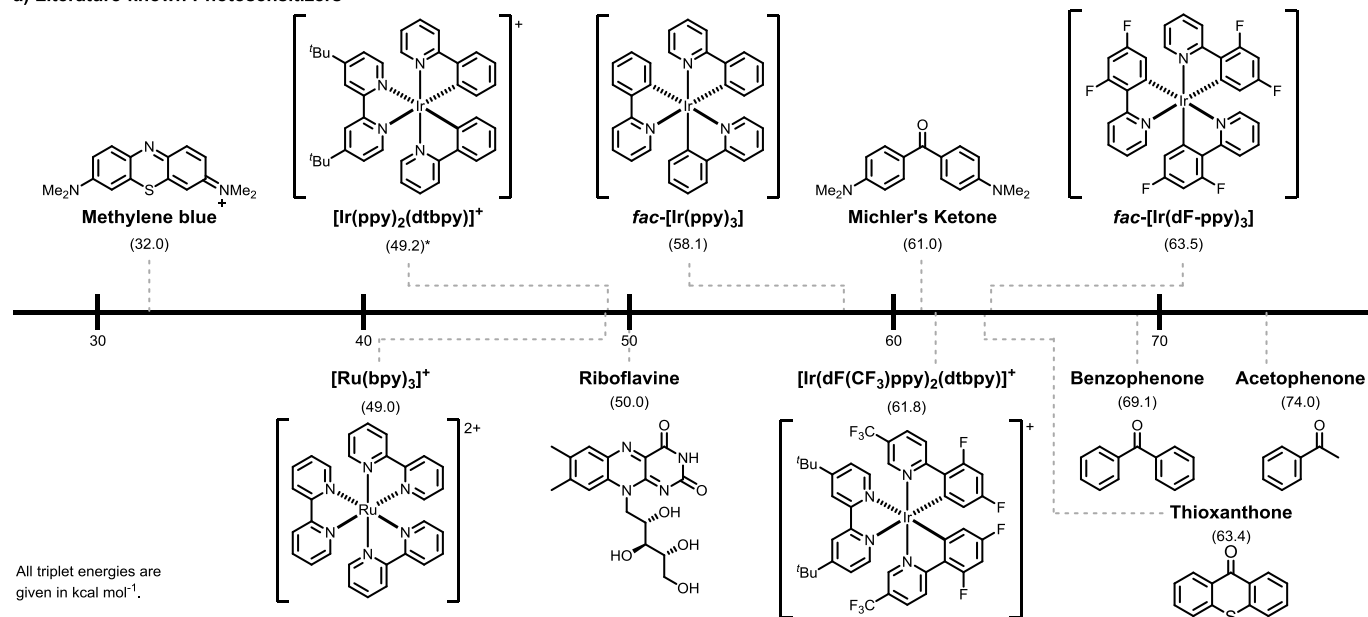

## b) Selected Substrates

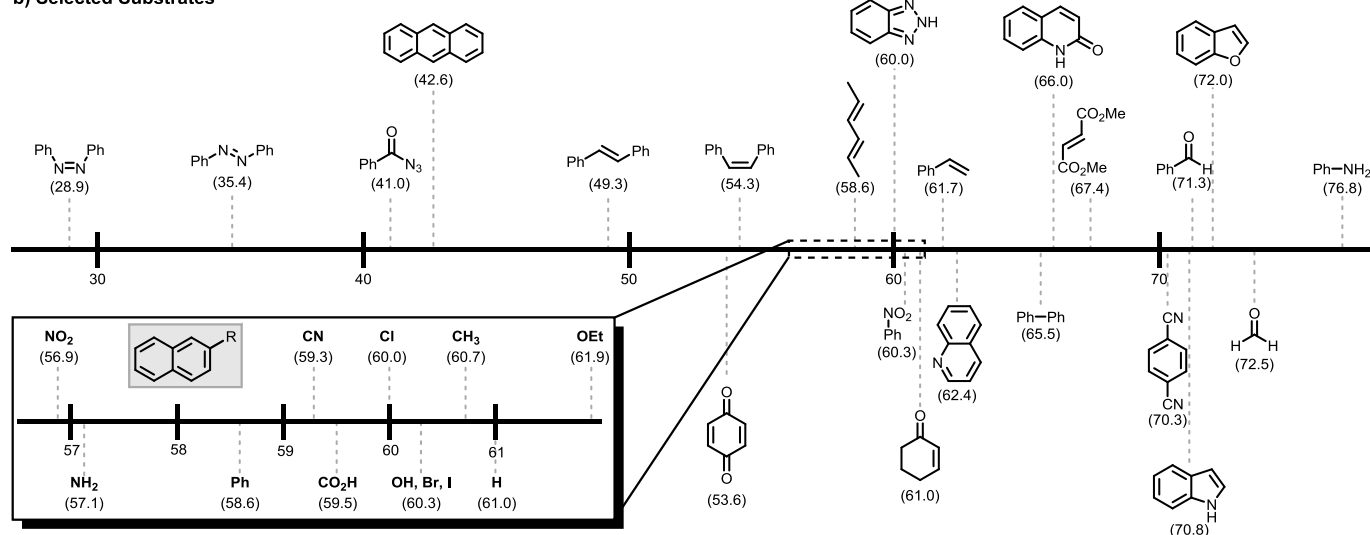

**Figure 6.** Overview of triplet excited state energies (given in kcal mol<sup>-1</sup>) of a) literature-known photosensitizers, b) selected organic molecules. Unless otherwise noted, all values were determined from phosphorescence spectra at cryogenic temperatures. \*Determined by room temperature emission spectroscopy.

Within the last years, the determination of triplet state energies through DFT analysis has also become a popular alternative approach, particularly in cases where experimental data is difficult to obtain. Although excited state characterization by means of DFT has remained an ongoing challenge,<sup>23,24</sup> the use of a hybrid functional (e.g. B3LYP, M06-2X) in a triple-zeta basis set (e.g. 6-311+(2d,p)) has been established as an adequate level of theory to generate reliable triplet energy data for a series of organic molecules.<sup>25,26</sup>

#### 4. Overview of Triplet Excited State Energies

Since the early 1950s, a vast number of spectroscopic studies have been performed in order to collect triplet excited state energy data for various (organic) compounds. Figure 6 aims to provide a broad overview of the triplet excited state energies of commonly used photosensitizers and selected substrates.<sup>10,19</sup>

However, it should be noted that there is often no obvious correlation between molecular structure and the corresponding triplet excited state energy. Whereas enlargement of the conjugated p-system usually results in decreasing triplet

## Moses (2009): [4+2] Cycloaddition with Singlet Oxygen

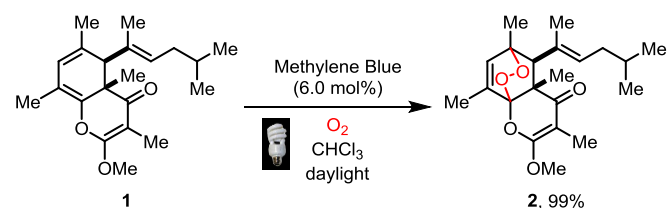

**Scheme 2.** Application of EnT catalysis in a singlet oxygen [4+2] cycloaddition. properties (e.g. electronic structure or steric demand) and triplet energy has remained elusive. As an illustration of this, the triplet energies of different 2-substituted naphthalenes are listed in Figure 6.

## 5. Applications in Organic Synthesis

This section aims to provide a broad overview of the major advances and applications of visible-light-mediated EnT catalysis in organic synthesis. These applications are divided into four main categories: cyclization reactions, photoisomerizations, bond dissociations and the sensitization of metal complexes. This tutorial review is not intended to be a comprehensive account and covers only selected examples to illustrate these different modes of reactivity.

## Cyclization Reactions

Photochemical cycloadditions and cyclization reactions provide a powerful synthetic tool for the construction of carbon–carbon and carbon–heteroatom bonds in a variety of strained ring systems, and have thus featured prominently in the synthesis of complex bioactive compounds. However, traditional methods using UV-irradiation to promote these processes typically suffer from competitive and uncontrollable side reactions, and so limit their widespread synthetic applicability. Considering this, these reactions are ideal targets for the development of mild visible light-mediated strategies using EnT catalysis.

The earliest applications of visible-light-mediated EnT catalysis in organic synthesis have been dominated by the photocatalytic generation of singlet oxygen and its use in a range of pericyclic reactions.<sup>27</sup> For example, Moses and co-workers reported using

## Yoon (2012): Intramolecular [2+2] Cycloaddition of Styrenes

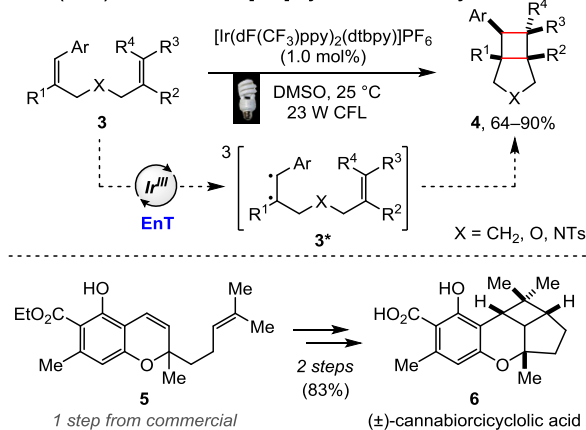

**Scheme 3.** EnT catalysis in the [2+2] photocycloadditions of styrenes.

## Bach (2014): Enantioselective [2+2] Cycloaddition

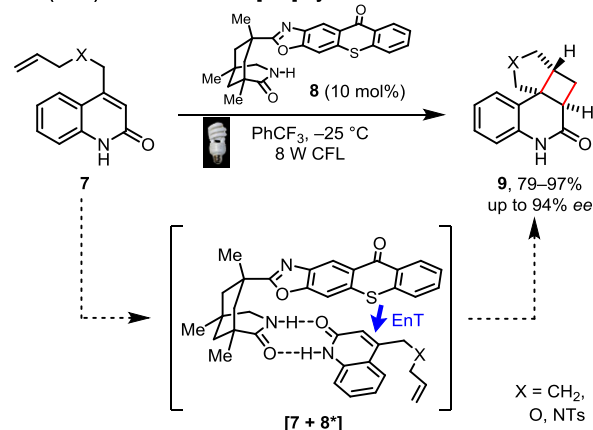

**Scheme 4.** Enantioselective [2+2] photocycloadditions enabled by EnT catalysis.

methylene blue (a typical visible-light-absorbing organic dye,  $E_T = 32.0 \text{ kcal mol}^{-1}$ ) to promote a [4+2] cycloaddition with singlet oxygen in their structural elucidation studies of tridachyahydropyrone (Scheme 2).<sup>28</sup> However, these processes will not be covered here as they have already been reviewed extensively elsewhere.<sup>27</sup>

Outside of singlet oxygen generation, the first major advances in modern visible-light-mediated EnT catalysis began with the pioneering work of Yoon and co-workers, who described the intramolecular [2+2] photocycloaddition of alkene tethered styrenes **3** (Scheme 3).<sup>29</sup> Here, EnT from a photoexcited iridium-based photocatalyst,  $[\text{Ir}(\text{d}(\text{CF}_3)\text{ppy})_2(\text{dtbbpy})]\text{PF}_6$  ( $E_T = 61.8 \text{ kcal mol}^{-1}$ ) was used to access the triplet styrenes **3\*** ( $E_T = \sim 55\text{--}60 \text{ kcal mol}^{-1}$ ), which readily react in an intramolecular fashion to afford the cyclobutane products **4** in typically excellent yield. The synthetic utility of this method was further demonstrated in a concise 3 step synthesis of (±)-cannabiorcycloic acid **6**. Yoon and co-workers also later extended the scope of this strategy beyond styrenes to include 1,3-diene substrates (which possess similar triplet energies).<sup>21</sup>

Following these studies, Bach and co-workers reported a ground breaking strategy to promote the first enantioselective [2+2] photocycloaddition using visible-light-mediated EnT catalysis (Scheme 4).<sup>30</sup> This approach was made possible through the use of a chiral thioxanthone-based photocatalyst **8**, which readily forms a hydrogen-bonded coordination complex with quinolone substrates **7**. Irradiation of these chiral complexes promotes EnT from the thioxanthone to the quinolone moiety, which then undergoes a [2+2] photocycloaddition on the opposite/unshielded face to form the cyclobutane product **9** in excellent yield and with excellent enantioselectivity. Recently, Baik, Yoon and co-workers have also reported a similar strategy using an iridium-based hydrogen bonding photocatalyst to promote similar reactions at reduced catalyst loadings.<sup>31</sup>

The next significant advancement in enantioselective EnT catalysis was reported by Yoon and co-workers, who utilized chiral Lewis acid catalysis to promote enantioselective [2+2]

## Yoon (2016): Asymmetric Intermolecular [2+2] Cycloadditions Enabled by Triplet Energy Lowering

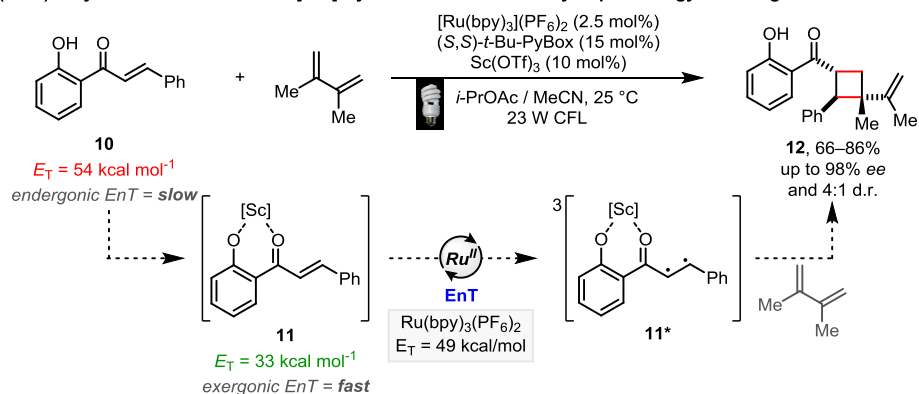

Scheme 5. Enantioselective [2 + 2] photocycloadditions through dual Lewis acid and EnT catalysis.

photocycloadditions through selective EnT (Scheme 5).<sup>25</sup> This approach was realised using 2'-hydroxychalcones **10** ( $E_T = 54 \text{ kcal mol}^{-1}$ ), which when coordinated to a chiral scandium catalyst form complexes **11** with dramatically reduced triplet energies ( $E_T = \sim 33 \text{ kcal mol}^{-1}$ ). This difference in triplet energy was sufficient to allow the photocatalyst,  $\text{Ru}(\text{bpy})_3(\text{PF}_6)_2$  ( $E_T = 49.0 \text{ kcal mol}^{-1}$ ) to selectively sensitize the coordinated complexes **11** in a fast exergonic EnT event. Following EnT, the chiral triplet intermediates **11\*** readily engage in [2+2] photocycloadditions with dienes to afford the vinyl cyclobutane products **12** with high levels of enantioselectivity. The full extent and general applicability of this Lewis acid catalysed strategy to reduce substrate triplet energies remains an area of rich synthetic potential.

Other than in the traditional straight [2+2] photo-cycloadditions described above, visible-light-mediated EnT catalysis has also been used by Kwon and co-workers to enable intramolecular *crossed* [2+2] photocycloadditions of dienones **13** for the synthesis of bridged cyclobutanes **15** (Scheme 6).<sup>26</sup> In this system the constrained nature of the dienone substrates was proposed to force the triplet intermediates **13\*** to cyclize into 1,4-diradical intermediates **14**, which then form the bridged cyclobutane ring system following radical-radical

## Kwon (2017): Intramolecular, Crossed [2+2] Cycloaddition

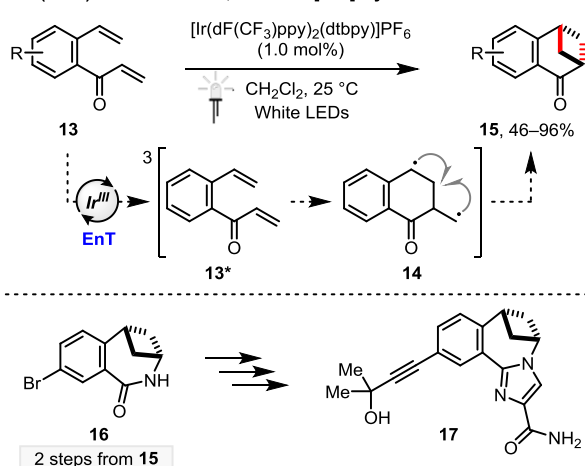

Scheme 6. Crossed [2+2] photocycloadditions enabled by EnT catalysis.

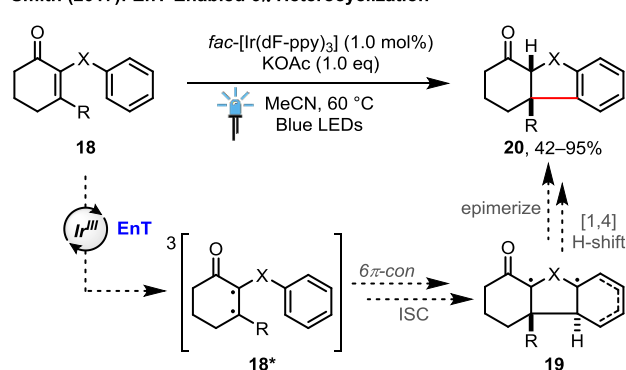
Smith (2017): EnT-Enabled 6 $\pi$  HeterocyclizationScheme 7. Application of EnT catalysis in a 6 $\pi$  heterocyclization.

recombination (as supported by computational studies). The bridged cyclobutane products were also readily diversified and used to access compounds with known therapeutic potential for inflammatory disease and cancer (e.g. conversion of **16** into **17**).

Finally, the application of visible-light-mediated EnT catalysis in a 6 $\pi$  heterocyclization reaction was recently described by Smith and co-workers.<sup>32</sup> Here, cyclic 2-aryloxyketones and related derivatives ( $E_T = \sim 58 \text{ kcal mol}^{-1}$ ) were activated with  $\text{fac-}[\text{Ir}(\text{dFppy})_3]$  ( $E_T = 63.5 \text{ kcal mol}^{-1}$ ) under irradiation with blue LEDs and in the presence of a base (KOAc) to afford the *cis*-fused cyclization products **20** in generally excellent yield and with near perfect diastereoselectivity. Computational studies suggest that the reactions initiate via EnT and the formation of triplet intermediates **18\***, which – following conrotatory heterocyclization and ISC – afford open-shell singlet intermediates **19**. The singlet intermediates **19** then undergo a facile [1,4] H-shift to afford the *trans*-cyclization products, which rapidly epimerize to the more stable *cis*-isomers by reaction with KOAc.

## Double Bond Photoisomerization

The  $E \rightarrow Z$  photoisomerization of alkenes is undoubtedly one of the most prominent applications employing an energy transfer activation strategy.<sup>33</sup> The early pioneering  $E \rightarrow Z$



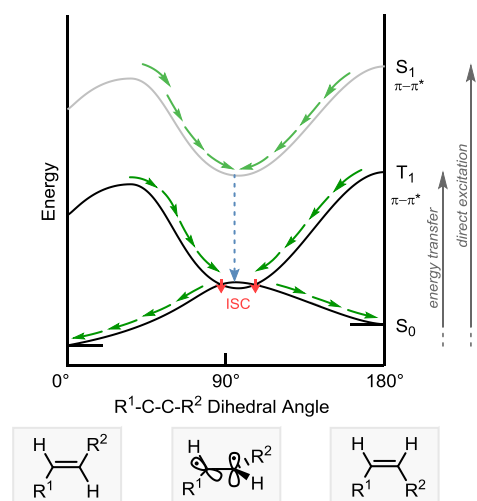
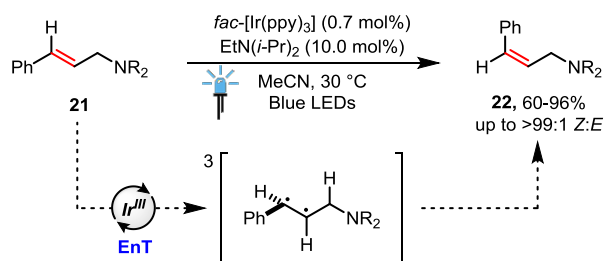

**Figure 7.** Simplified energy surface diagram explaining the effect of the  $R^1$ -C-C- $R^2$  dihedral angle during direct or sensitized isomerization of olefins. Green arrows = movement along the energy surface and its dependence on the torsion angle. Blue arrow = surface crossing without overall spin change. Red arrow = surface crossing with overall spin change (ISC).

photoisomerization protocols typically require the use of (hyper)stoichiometric amounts of photosensitizers, which in combination with harsh UV-irradiation lead to decreased functional group tolerance and, consecutively, a limited substrate scope.<sup>34</sup> Thus, as with the renaissance of photocatalysis in recent years, mild visible-light-mediated photoisomerizations of alkenes have also been developed.

Mechanistically, triplet sensitization of an alkene by a suitable photosensitizer results in the promotion of an electron from a  $\pi$ - to a  $\pi^*$ -orbital, thereby decreasing the bond order, which allows for rotation around the  $\sigma$ -axis. Hereby, a twisted minimum energy intermediate is generated (see Figure 7), which is a funnel for transitions to the twisted energy maximum on the ground state energy surface, allowing relaxation to the  $E$ - or  $Z$ -configured alkene. In this scenario, direct sensitization of an alkene yields a statistical mixture of  $E$ - and  $Z$ -isomers. However, if the alkene substrate is conjugated to another  $p$ -system, the triplet energies of the  $E$ - and  $Z$ - isomer can differ significantly: As excitation is a vertical process, i. e. the triplet structure reflects the ground state geometry, the  $Z$ -isomer triplet state is disfavored due to nonbonding interactions and

**Weaver (2014):  $E/Z$  Isomerization of Styrenyl Alkenes by Triplet Sensitization**



**Scheme 8.** Energy transfer catalysis allows the selective  $E \rightarrow Z$  isomerization of styrenyl alkenes **21** under kinetic control.

**Gilmour (2015): Bio-Inspired  $E/Z$ -Isomerization of Styrenyl Alkenes**

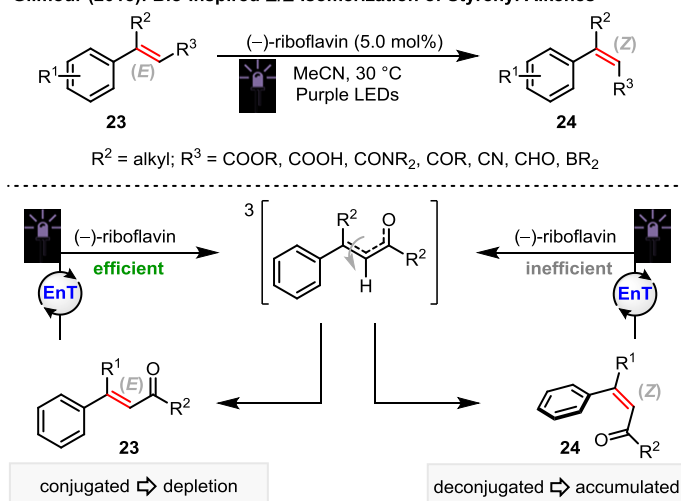

**Scheme 9.** Bio-inspired  $E \rightarrow Z$  photoisomerization of diverse  $\alpha,\beta$ -unsaturated styrenyl motifs by triplet sensitization utilizing  $(-)$ -riboflavin as photosensitizer. Substrate control results in high  $Z$ -selectivity.

steric effects disrupting conjugation. This allows a photocatalyst with  $E_T < E_T(Z\text{-alkene})$  to selectively sensitize the  $E$ -isomer, resulting in gradual accumulation of the  $Z$ -isomer. At this point, it should be noted that the distribution of ground state conformers can have an impact on rate and selectivity of sensitized olefin isomerization, too.<sup>33</sup>

An elegant example of this strategy, which was previously observed as a side reaction e.g. under photoredox conditions,<sup>35</sup> was reported by Weaver and co-workers in 2014, who described the triplet-sensitized, highly selective isomerization of styrenyl substrates **21** using *fac*-[Ir(ppy)<sub>3</sub>] ( $E_T = 58.1$  kcal/mol) as the photocatalyst (Scheme 8).<sup>36</sup> This work enabled the thermodynamically less stable  $Z$ -isomer **22** to be generated under kinetic control. The selectivity of this mild EnT activation mode resulted in a remarkably broad substrate scope while using extremely low catalyst loadings.

Next, taking nature as a blueprint, Gilmour and co-workers reported the highly selective  $E \rightarrow Z$  photoisomerization of diverse activated olefins **23** (Scheme 9).<sup>37,38</sup> Inspired by the dipodal  $Z \rightarrow E$  isomerization of retinal, the directionality inverted  $E \rightarrow Z$  isomerization was achieved by employing the organic photocatalyst  $(-)$ -riboflavin as an EnT catalyst. In this first report, the primarily  $\alpha,\beta$ -unsaturated ester styrenyl substrates **23** were converted into their corresponding  $Z$ -isomers **24** in generally quantitative yield and with excellent selectivity (up to 99:1  $Z:E$ ) under irradiation with purple LEDs (402 nm).<sup>37</sup> The  $E/Z$  selectivity was controlled by the incorporation of alkyl substituents on the alkene, resulting in a twisted  $\pi$ -system and minimized nonbonding interactions. This strategy allows for the efficient re-excitation of the undesired  $E$ -configured isomer, whereas the deconjugation of the  $Z$ -configured product shuts down re-excitation. This bio-inspired strategy was successfully expanded to the selective  $E \rightarrow Z$  photoisomerization of  $\alpha,\beta$ -unsaturated nitrile styrenyl moieties,  $\alpha,\beta$ -unsaturated borane

## A) Gilmour &amp; Ravoo (2018): Covalent Immobilization of (-)-Riboflavin

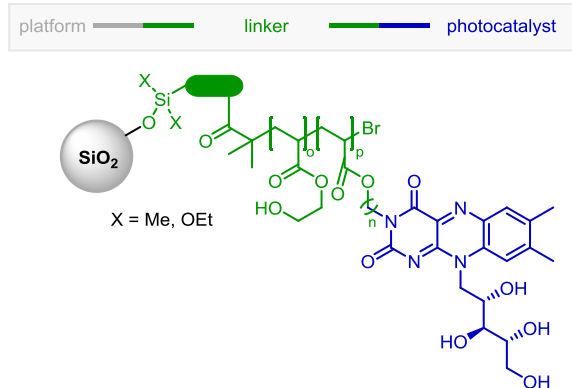

## B) Weaver (2017): Visible-Light-Induced Strain Conjugation

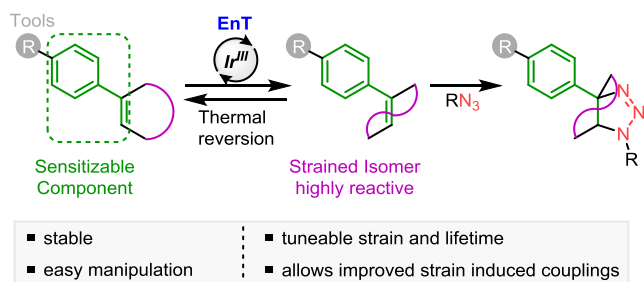

**Scheme 10.** A) Covalent immobilization of (-)-riboflavin using polymer functionalised silica particles. B) Utilizing the  $Z \rightarrow E$  triplet photoisomerization for strain induction, allowing improved bioconjugation reactions.

styrenyl motifs, as well as to the synthesis of coumarins by the utilization of two discrete photochemical activation modes using (-)-riboflavin as the photocatalyst.<sup>10</sup>

More recently, Gilmour, Ravoo and co-workers reported a heterogeneous catalyst system based on the covalent immobilization of (-)-riboflavin on polymer functionalised silica particles, which could importantly enable large-scale applications of isomerization approaches (Scheme 10, A).<sup>39</sup> Furthermore, Weaver and co-workers have beautifully demonstrated that intramolecular strain induced by a transiently  $Z \rightarrow E$  triplet sensitization of *cis*-cycloalkenes accelerates bioconjugation reactions between those alkenes and azide-functionalised insulin (Scheme 10, B).<sup>40</sup> This strain-loadable alkene strategy may set the fundamentals for powerful strategies to facilitate the synthesis of complex chemical systems, especially in a biomolecular environment.

## Bond Dissociation by Energy Transfer Sensitization

In contrast to the previous sections, where primarily aromatic  $\pi$ -systems or alkenes were activated by EnT, bond dissociation represents another pathway for the generation of versatile radical intermediates. While the  $E_T$  of a substrate can be used to determine if EnT is possible, the occurrence of a bond dissociation event from this high energetic state can be hard to predict. The number of reports utilizing this EnT activation strategy, which can be divided into heterolytic and homolytic bond dissociations, are therefore currently quite limited.

## A) Heterolytic N–N Bond Dissociation Induced by Triplet Sensitization

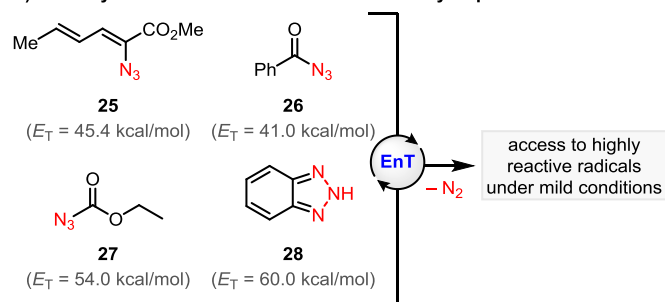

## B) Yoon (2014): Triplet Sensitization of Azides Yielding Pyrroles

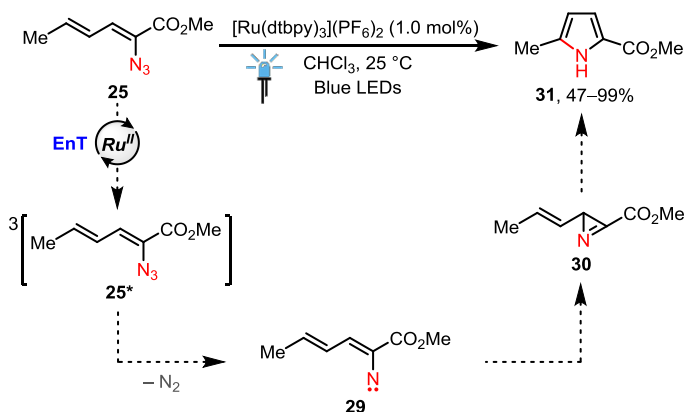

## C) König (2015): C–H Amidation of Heteroarenes Using Benzoyl Azides

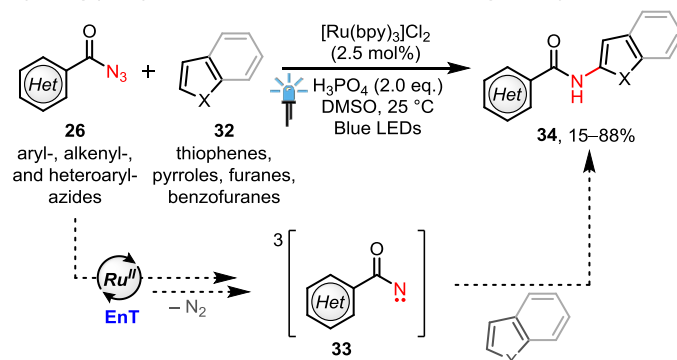

**Scheme 11.** A) Selected substrates suitable for heterolytic N–N bond dissociation induced by triplet sensitization. B) Triplet excited state induced bond dissociation of dieny azides **25** giving pyrroles **31**. C) Triplet sensitization of benzoyl azides leading to reactive nitrene intermediates used for the C–H amidation of electron-rich (hetero)arenes.

## a) Heterolytic Bond Dissociation

Substrates containing N–N bonds – such as alkyl and acyl azides (**25–27**)<sup>41–43</sup> or *2H*-benzotriazoles<sup>44</sup> – are prominent examples where heterolytic bond dissociation induced by EnT has been successfully employed (Scheme 11, A).

The construction of pyrroles from nitrene intermediates – obtained after triplet sensitization of azides – provides an elegant example of this activation strategy (Scheme 11, B).<sup>41</sup> Here, inspired by reports on the preparation of nitrene intermediates via the direct photolysis of azides under harsh

## A) Guldi &amp; Glorius (2018): The Energy-Transfer-Enabled Disulfide-Ene Reaction

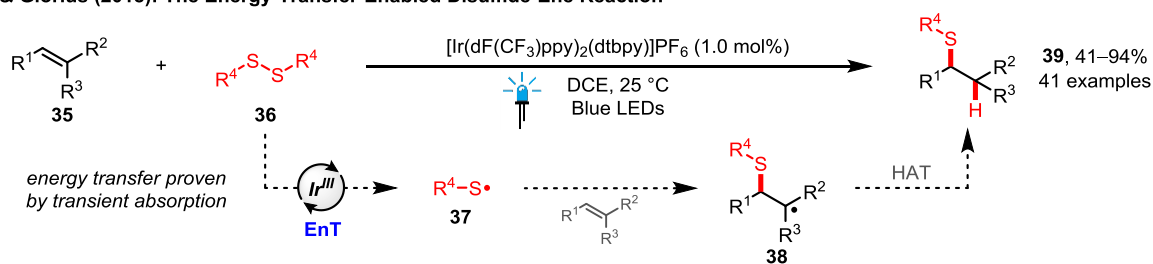

## B) Mechanistic Analysis by Transient Absorption Spectroscopy

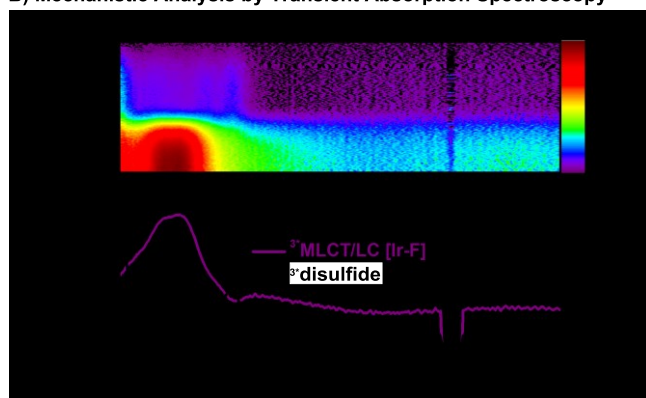

## C) Selected Scope Entries:

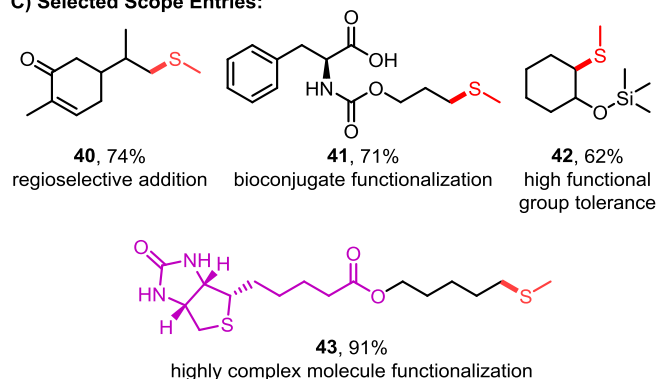

**Scheme 12.** The rationally designed disulfide–ene reaction enabled by visible-light-mediated EnT catalysis. A) Disulfide–ene reaction overview and mechanism. B) Transient absorption spectroscopy to investigate the nature of the photocatalyst/disulfide interaction. C) Selected scope entries.

UV-light irradiation ( $\lambda < 300$  nm), Yoon and co-workers envisioned that this approach would be amenable to a catalytic visible-light-mediated EnT approach. Their proposed strategy was further supported by calculating the first electronically ( $E_T = 45.4$  kcal mol $^{-1}$ ), which was well suited for EnT activation with Ru(dtbbpy) $_3^{2+}$  ( $E_T = 46.0$  kcal mol $^{-1}$ ). Consequently, visible-light irradiation of dieny azide **25** in the presence of the [Ru]-photosensitizer resulted in the formation of the desired nitrene intermediate **29**, which was found to consecutively react and rearrange into pyrrole **31**.

Following their initial report, Yoon and co-workers elegantly applied this concept in the spin-selective generation of triplet-nitrenes, which enabled the facile aziridination of olefins using azidoformates ( $E_T = 54.0$  kcal mol $^{-1}$ ) using [Ir(ppy) $_2$ (dtbbpy)]PF $_6$  ( $E_T = 49.2$  kcal mol $^{-1}$ ) as the photocatalyst.<sup>42</sup> The triplet sensitization of organic azides was also utilized by König and co-workers in 2015 for the C–H amidation of heteroarenes. This work utilized benzoyl azides ( $E_T = 41.0$  kcal mol $^{-1}$ ) and Ru(bpy) $_3^{2+}$  ( $E_T = 46.0$  kcal mol $^{-1}$ ) to amidate a wide variety of electron-rich heteroarenes under acidic conditions (Scheme 11, C).<sup>43</sup>

a) Homolytic  $\sigma$ -bond Dissociation

As discussed previously, bond dissociation events can be hard to predict based on  $E_T$  values alone. However, in combination with bond dissociation energies (BDE), the general likelihood of a dissociation event occurring under EnT conditions can be determined if the substrate BDE is approximately  $\leq E_T$ . Fortunately, many BDE have been determined either experimentally or theoretically, enabling the rational design of homolytic  $\sigma$ -bond dissociations promoted by EnT.<sup>45</sup>

Inspired by the S–S bond dissociation energies of aliphatic disulfides (BDE =  $\sim 65$  kcal/mol) and reports on the direct sensitization of aryl disulfides using UV light, our group recently reported the EnT-enabled disulfide-ene reaction, which proceeds *via* the homolytic  $\sigma$ -bond dissociation of alkyl- and aryl-disulfides **36** (Scheme 12A).<sup>20</sup> Using [Ir(dF(CF $_3$ )ppy) $_2$ (dtbbpy)]PF $_6$  ( $E_T = 61.8$  kcal/mol) as the photocatalyst, triplet-triplet EnT to the disulfide **36** leads to homolytic S–S bond cleavage and the generation of the corresponding thiyl radicals **37**. This radical then chemoselectively adds in an *anti*-Markovnikov fashion into the most electron-rich alkene functionality to form carbon-centred radical **38**. Next, depending on the nature of the disulfide and the solvent, a hydrogen atom abstraction event takes place between the radical **38** and either another disulfide molecule **36** or the solvent. Transient absorption spectroscopy was performed to explore and support the proposed EnT interaction between the photocatalyst and the disulfides (Scheme 12, B). These reactions were also notable for their remarkable functional group tolerance and biocompatibility, which was demonstrated both through a biomolecule-additive-based screen and an impressive substrate scope (Scheme 12, C). These results hint towards the powerful synthetic potential of these reactions, and EnT as an activation mode in general, as tools for diverse biochemical applications.

## Sensitization of Metal Complexes

Other than EnT processes to organic molecules, some recent elegant reports have been disclosed on triplet-triplet EnT to transition metal (TM) complexes. To date, the application of

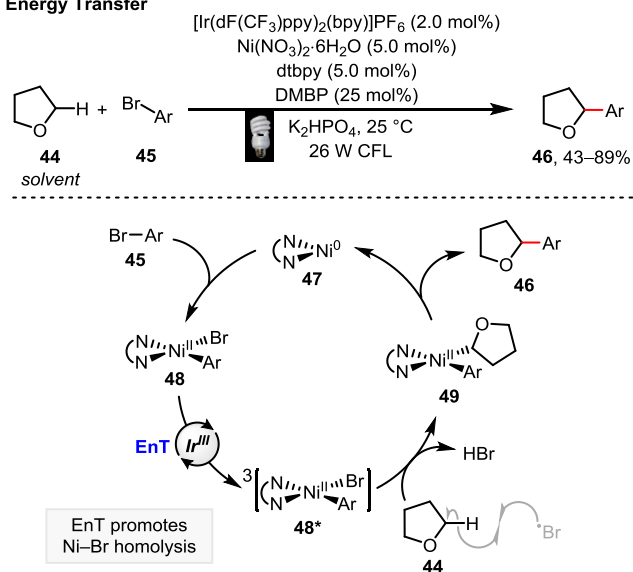
**Molander (2016): Transmetalation Enhancement by Energy Transfer**

**Scheme 13.** EnT mediated Ni-catalysed C(sp<sup>3</sup>)-H arylation reported by Molander and co-workers.

excited-state TM complexes (not including TM based photocatalysts) in organic transformation remains largely unexplored. However, in the few reports that are known to proceed via excited-state TM catalysis, new reactivity modes were observed which enabled valuable transformations, which were not possible via ground-state TM catalysis. Traditionally, excited-state TM complexes are accessed via direct excitation in cases where the ligands possess large  $\pi$ -systems. However, triplet-triplet EnT represents a potentially more general and ligand independent approach for the formation of valuable excited-state TM complexes. The earliest example of this approach was reported by Kobayashi and co-workers in 2015, who described a visible-light-mediated Ullmann-type C-N coupling.<sup>46</sup> In this work, an intermediate Cu<sup>I</sup> species was activated by EnT from *fac*-[Ir(ppy)<sub>3</sub>] to induce a SET event, which enabled the coupling of carbazole derivatives with aryl iodides.

Following this work, Molander and co-workers used EnT catalysis to facilitate a direct Ni-catalysed C(sp<sup>3</sup>)-H cross coupling (Scheme 13).<sup>47</sup> Here, triplet-triplet EnT from the Ir<sup>III</sup> photocatalyst to the Ni<sup>II</sup> complex **48** was proposed to generate a Ni-centered d-d triplet state. In this state, antibonding  $d_x^2-y^2$ -type orbitals are populated, inducing homolytic cleavage of the Ni-Br bond to afford a bromine radical and an intermediary Ni<sup>I</sup> complex (not shown in Scheme 13). The bromine radical then abstracts the labile C-H bond of **44** to form a C-centered radical, which upon recombination with the remaining Ni<sup>I</sup> complex affords Ni<sup>II</sup> complex **49**. The C-H arylation product **46** is then generated by reductive elimination. This novel C-H functionalisation process was also later extended to include acid chlorides as coupling partners by Shibasaki and co-workers in 2017.<sup>48</sup>

More recently, another prominent example of this strategy was reported by MacMillan and co-workers in 2017,<sup>22</sup> who showed

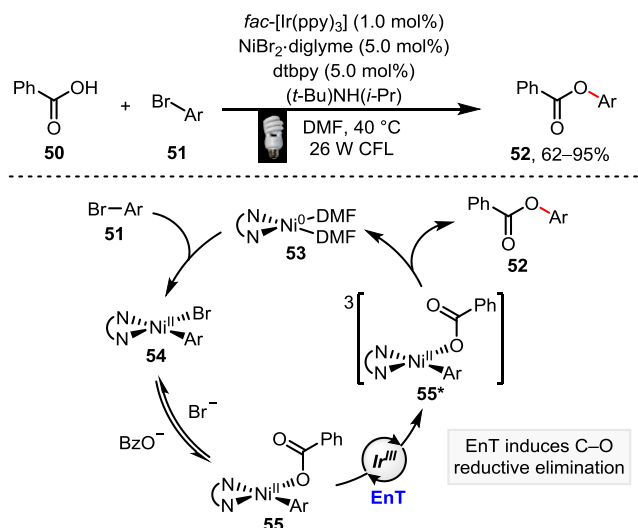
**MacMillan (2017): Reductive Elimination Enabled by Energy Transfer**

**Scheme 14.** EnT mediated Ni-catalysed C-O coupling of carboxylic acids with aryl bromides by MacMillan and co-workers.

that excited state TM complexes could be used to promote challenging reductive eliminations, which were not feasible from the ground state TM complexes. In this case, triplet-triplet energy transfer enabled the reductive elimination from aryl Ni<sup>II</sup> acetate complex **55\***, giving rise to a new C-O bond. In a later report, this concept was applied promoting a C-N bond-forming reductive elimination. (Scheme 14).<sup>49</sup>

## 5. Summary & Outlook

In summary, this review has covered the general applications of visible-light-mediated EnT catalysis in organic synthesis and the photophysical fundamentals required to rationalize them. Within the last decade, this field has seen significant advances in a number of synthetic applications. However, there still remain several major challenges and unexplored directions – for instance, the design of new visible-light-absorbing catalysts with higher triplet excited state energies, and preferably those based upon earth abundant transition metals or purely organic frameworks. Access to higher triplet excited state energies would enable powerful reactions that currently require UV irradiation to be performed under milder and more selective conditions. Alternatively, further investigations into the generality of using Lewis acid catalysis to lower the ET of the substrate, as developed by Yoon and co-workers, could potentially have a huge impact on this field of research.

Within each of the reaction categories discussed, there are several examples which highlight directions for future work. For example, the 6 $\pi$  heterocyclization developed by Smith and co-workers is significant for expanding cyclization reactions beyond variations of the [2+2] photocycloaddition. With regards to E $\rightarrow$ Z photoisomerizations, Gilmour and co-workers have shown how these processes can be used to enable complex cascade reactions. Furthermore, Weaver and co-

workers have demonstrated how EnT and photoisomerization can be used to control systems with biological function. Our own group has shown the power of rational design for the development of powerful (homolytic) bond dissociation reactions. Finally, the use of EnT to accelerate or enable reaction limiting steps in transition metal catalysis, as described by MacMillan and co-workers, is clearly a powerful strategy with great synthetic potential. A similar approach, exciting an organic photoredox catalyst by visible-light-mediated energy transfer, was beautifully demonstrated by König in 2017,<sup>50</sup> emphasizing the enormous potential of this research direction.

Overall, we hope that this tutorial review will provide an informative tool to aid the development of this re-emerging field of catalysis.

## Acknowledgements

Generous financial support by the Deutsche Forschungsgemeinschaft (Leibniz Award and SFB858) and the Alexander von Humboldt Foundation is gratefully acknowledged. The authors thank Frederik Sandfort (WWU Münster) and Christan Henkel (FAU Erlangen-Nürnberg) for helpful discussions.

## Notes and references

- G. S. Hammond and N. J. Turro, *Science*, 1963, **142**, 1541–1553.
- N. Hoffmann, *Chem. Rev.*, 2008, **108**, 1052–1103.
- T. P. Yoon, M. A. Ischay and J. Du, *Nat. Chem.*, 2010, **2**, 527–532.
- T. Gensch, M. Teders and F. Glorius, *J. Org. Chem.*, 2017, **82**, 9154–9159.
- C. K. Prier, D. A. Rankic and D. W. C. MacMillan, *Chem. Rev.*, 2013, **113**, 5322–5363.
- N. A. Romero and D. A. Nicewicz, *Chem. Rev.*, 2016, **116**, 10075–10166.
- J. W. Verhoeven, *Pure Appl. Chem.*, 1996, **68**, 2223–2286.
- Y. Ohsawa, S. Sprouse, K. A. King, M. K. DeArmond, K. W. Hanck and R. J. Watts, *J. Phys. Chem.*, 1987, **91**, 1047–1054.
- N. H. Damrauer, G. Cerullo, A. Yeh, T. R. Bousie, C. V. Shank and J. K. McCusker, *Science*, 1997, **275**, 54–57.
- For further reading, the reader is referred to the literature references given in the electronic supporting information.
- Radiative energy transfer (also: “primitive” EnT) refers to EnT by an emission-absorption mechanism. After absorption, the donor emits a photon which is absorbed by the acceptor. For visible-light-mediated processes, this mechanism can be neglected, see e.g.: J. Birks, *Photochemistry of Aromatic Molecules*, John Wiley, New York, 1970.
- N. J. Turro, *Modern Molecular Photochemistry*, University Science Books, Sausalito, 1991.
- T. Förster, *Ann. Phys.*, 1948, **437**, 55–75.
- E. Wigner, *Nachr. Akad. Wiss. Goettingen, Math-Phys. Kl.*, 1927, 375–381.
- D. L. Dexter, *J. Chem. Phys.*, 1953, **21**, 836–850.
- R. A. Marcus, *Rev. Mod. Phys.*, 1993, **65**, 599–610 and references therein.
- If the collision complex is significantly stabilized, it is commonly termed *exciplex*, see: J. B. Birks, *Nature*, 1967, **214**, 1187–1190.
- V. Balzani, P. Ceroni and A. Juris, *Photochemistry and Photophysics: Concepts, Research, Applications*, Wiley-VCH, Weinheim, 2014.
- S. L. Murov, I. Chermichael and G. L. Hug, *Handbook of Photochemistry*, Marcel Dekker Inc., New York, 1993.
- M. Teders, C. Henkel, L. Anhäuser, F. Strieth-Kalthoff, A. Gómez-Suárez, R. Kleinmans, A. Kahnt, A. Rentmeister, D. M. Guldi and F. Glorius, *Nat. Chem.*, 2018, under revision.
- A. E. Hurlley, Z. Lu and T. P. Yoon, *Angew. Chem. Int. Ed.*, 2014, **53**, 8991–8994.
- E. R. Welin, C. Le, D. M. Arias-Rotondo, J. K. McCusker and D. W. C. MacMillan, *Science*, 2017, **355**, 380–385.
- S. Huang, Q. Zhang, Y. Shiota, T. Nakagawa, K. Kuwabara, K. Yoshizawa and C. Adachi, *J. Chem. Theory Comput.*, 2013, **9**, 3872–3877.
- M. J. G. Peach, P. Benfield, T. Helgaker and D. J. Tozer, *J. Chem. Phys.*, 2008, **128**, 044118.
- T. R. Blum, Z. D. Miller, D. M. Bates, I. A. Guzei and T. P. Yoon, *Science*, 2016, **354**, 1391–1395.
- J. Zhao, J. L. Brosmer, Q. Tang, Z. Yang, K. N. Houk, P. L. Diaconescu and O. Kwon, *J. Am. Chem. Soc.*, 2017, **139**, 9807–9810.
- A. A. Ghogare and A. Greer, *Chem. Rev.*, 2016, **116**, 9994–10034 and references therein.
- P. Sharma, B. Lygo, W. Lewis and J. E. Moses, *J. Am. Chem. Soc.*, 2009, **131**, 5966–5972.
- Z. Lu and T. P. Yoon, *Angew. Chem. Int. Ed.*, 2012, **51**, 10329–10332.
- R. Alonso and T. Bach, *Angew. Chem. Int. Ed.*, 2014, **53**, 4368–4371.
- K. L. Skubi, J. B. Kidd, H. Jung, I. A. Guzei, M.-H. Baik and T. P. Yoon, *J. Am. Chem. Soc.*, 2017, **139**, 17186–17192.
- N. Münster, N. A. Parker, L. van Dijk, R. S. Paton and M. D. Smith, *Angew. Chem. Int. Ed.*, 2017, **56**, 9468–9472.
- J. B. Metternich and R. Gilmour, *Synlett*, 2016, **27**, 2541–2552 and references therein.
- W.-Y. Siau, Y. Zhang and Y. Zhao, *Top. Curr. Chem.*, 2012, **327**, 33–58.
- C. Wallentin, J. D. Nguyen, P. Finkbeiner and C. R. J. Stephenson, *J. Am. Chem. Soc.*, 2012, **134**, 8875–8884.
- K. Singh, S. J. Staig and J. D. Weaver, *J. Am. Chem. Soc.*, 2014, **136**, 5275–5278.
- J. B. Metternich and R. Gilmour, *J. Am. Chem. Soc.*, 2015, **137**, 11254–11257.
- J. B. Metternich and R. Gilmour, *J. Am. Chem. Soc.*, 2016, **138**, 1040–1045.
- J. B. Metternich, S. Sagebiel, A. Lückener, S. Lamping, B. J. Ravoo and R. Gilmour, *Chem. Eur. J.*, 2018, **24**, 4228–4233.
- K. Singh, C. J. Fennell, E. A. Coutσίας, R. Latifi, S. Hartson, J. D. Weaver, *Chem*, 2018, **4**, 124–137.
- E. P. Farney and T. P. Yoon, *Angew. Chem. Int. Ed.*, 2014, **53**, 793–797.
- S. O. Scholz, E. P. Farney, S. Kim, D. M. Bates and T. P. Yoon, *Angew. Chem. Int. Ed.*, 2016, **55**, 2239–2242.
- E. Brachet, T. Ghosh, I. Ghosh and B. König, *Chem. Sci.*, 2015, **6**, 987–992.
- M. N. Hopkinson, A. Gómez-Suárez, M. Teders, B. Sahoo and F. Glorius, *Angew. Chem. Int. Ed.*, 2016, **55**, 4361–4366.
- Y.-R. Luo, *Handbook of Bond Dissociation Energies in Organic Compounds*, CRC Press, Boca Raton, 2003.
- W. J. Yoo, T. Tsukamoto and S. Kobayashi, *Org. Lett.*, 2015, **17**, 3640–3642.
- D. R. Heitz, J. C. Tellis and G. A. Molander, *J. Am. Chem. Soc.*, 2016, **138**, 12715–12718.
- Z. Sun, N. Kumagai and M. Shibasaki, *Org. Lett.*, 2017, **19**, 3727–3730.
- T. Kim, S. McCarver, C. Lee and D. W. C. MacMillan, *Angew. Chem. Int. Ed.*, 2018, **57**, 3488–3492.

50 I. Ghosh, R. S. Shaikh and B. König, *Angew. Chem. Int. Ed.*, 2017, **56**, 8544–8549.

**Suggested TOC:**