



UNIVERSITY OF LEEDS

This is a repository copy of *Real-Time FIR Filter Equalisation of Analog Front Ends for Soft-Tissue Quantitative Ultrasound*.

White Rose Research Online URL for this paper:
<http://eprints.whiterose.ac.uk/151559/>

Version: Accepted Version

Proceedings Paper:

Carpenter, TM, Cowell, DMJ orcid.org/0000-0003-0854-542X and Freear, S orcid.org/0000-0001-7858-4155 (2019) Real-Time FIR Filter Equalisation of Analog Front Ends for Soft-Tissue Quantitative Ultrasound. In: IEEE International Ultrasonics Symposium, IUS. 2018 IEEE International Ultrasonics Symposium (IUS), 22-25 Oct 2018, Kobe, Japan. IEEE . ISBN 978-1-5386-3425-7

<https://doi.org/10.1109/ULTSYM.2018.8579691>

© 2019, IEEE. This is an author produced version of a paper published in IEEE International Ultrasonics Symposium, IUS. Uploaded in accordance with the publisher's self-archiving policy.

Reuse

Items deposited in White Rose Research Online are protected by copyright, with all rights reserved unless indicated otherwise. They may be downloaded and/or printed for private study, or other acts as permitted by national copyright laws. The publisher or other rights holders may allow further reproduction and re-use of the full text version. This is indicated by the licence information on the White Rose Research Online record for the item.

Takedown

If you consider content in White Rose Research Online to be in breach of UK law, please notify us by emailing eprints@whiterose.ac.uk including the URL of the record and the reason for the withdrawal request.



eprints@whiterose.ac.uk
<https://eprints.whiterose.ac.uk/>

Real-Time FIR Filter Equalisation of Analog Front Ends for Soft-Tissue Quantitative Ultrasound

Thomas M. Carpenter[†], David M. J. Cowell, Steven Freear

Ultrasonics and Instrumentation Group, School of Electronic and Electrical Engineering,

University of Leeds, Leeds, LS2 9JT, UK

Email: [†]t.carpenter@leeds.ac.uk

Abstract—A typical ultrasound imaging system analogue front end (AFE) consists of a series of stages, including transmit/receive switch, amplifiers and analog-digital converter (ADC). Each stage will have an impact on the signal in the form of noise, but also in the form of distortion from a frequency-dependent gain profile. This gain response will be applied to any ultrasound echo signal received by the system. This paper highlights the presence of this distortion and proposes a method of identifying the distortion caused by the front end and performing compensation in real-time using per-channel finite-impulse-response (FIR) filters. The University of Leeds Ultrasound Array Research Platform (UARP) was used as a typical example system for which the AFE frequency response was analysed, though any system using integrated analogue front ends will exhibit similar behaviour. The proposed method was used to determine the necessary inverse response filter for the UARP system. With the filter inserted into the digital signal processing path and the resulting frequency response is measured to verify functionality. The presented results demonstrate how digital FIR filters can be used to effectively equalise the gain profile of the AFE in real-time using hardware Finite Impulse Response (FIR) filters within the UARP research system.

I. INTRODUCTION

Analog Front Ends (AFE) in ultrasound systems consist of a series of different components chained together to collect and digitise ultrasound echo signals. A typical AFE will contain some form of transmit-receive (T-R) switch, one or more Low Noise Amplifiers (LNAs), Time Gain Compensation (TGC), anti-aliasing filters, and an Analog to Digital Converter (ADC) [1] [2]. Each of these stages may exhibit frequency-dependent impedance [3] and gain that cause the incoming echo signals to be distorted. For soft tissue Quantitative Ultrasound (QUS) techniques that rely on analysis of spectral content of the raw ultrasound measurements [4], frequency dependent distortion will have an impact on measurement accuracy.

Many modern compact ultrasound systems make use of Integrated Circuits (ICs) which neatly combine multiple stages of amplifiers and data converters onto a single package. One such example is the AFE5807 (Texas Instruments [5]) which contains integrated LNAs and anti-aliasing Low-Pass Filter (LPF) along with ADCs. While this level of integration allows a reduction in size and price, there results an inherent limitation in performance. Fig.1 shows for example the frequency response of the integrated LPF in the AFE5807 device, showing a 2 dB amplitude change across the pass band.

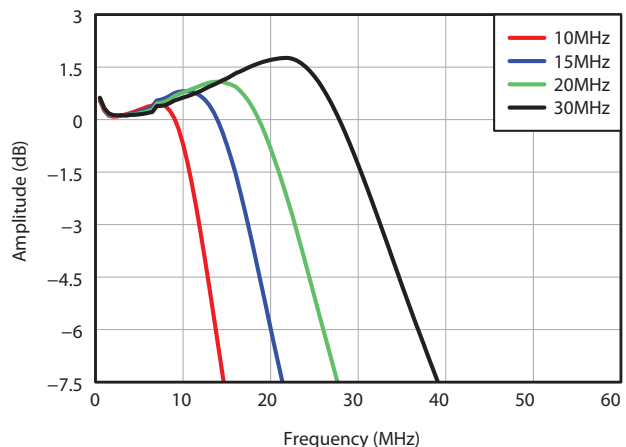

Fig. 1. Gain vs. Frequency of Commercial AFE LPF at Different Cut-off Frequencies (Adapted From [5])

Due to increasing levels of integration, the ability to make corrections to equalise the frequency response in the analogue domain using discrete filters becomes impractical. As such the burden of performing any correction falls to post-processing steps performed in the digital domain using techniques such as FIR filtering. For systems that require real-time imaging, this corrective filtering must be implemented with sufficient processing power to ensure minimal impact on frame rate.

II. DISTORTION MEASUREMENT AND EQUALISATION

To understand and correct for any distortion in the AFE, an approach for characterising the gain of the system of a range of frequencies is required. To perform this analysis, the AFE can be considered as effectively a filter and an ADC as represented in the box labelled AFE in Fig.2. A standard approach to estimating the frequency response called Empirical Transfer Function Estimate (ETFE) involves comparing input vs output signals in the Fourier domain [6]. As we are working with an AFE, the output signal is already available as a digitised data set. If the input signal is known the frequency response can therefore be directly calculated.

To provide a stimulus, the simplest approach is to connect an Arbitrary-Waveform Generator (AWG) to the input of the system in place of a transducer. As a range of frequencies is to be tested, a chirp signal can be used [7] as when

designed correctly with constant amplitude across the chirp, the Fast-Fourier Transform (FFT) of this type of signal will be flat across the frequency range of interest [8]. The input signal is additionally probed at the input to the AFE using an oscilloscope in order to measure the exact stimulus to the system.

The two collected data sets, one from the input signal measured by the oscilloscope, and the second the digitised output signal from the AFE, are then converted from time domain to frequency domain by taking the FFT of the signals. The frequency response of the system can then be calculated by normalising the signals to the same scale and dividing the output FFT by the input FFT. The full measurement setup is shown in Fig.2.

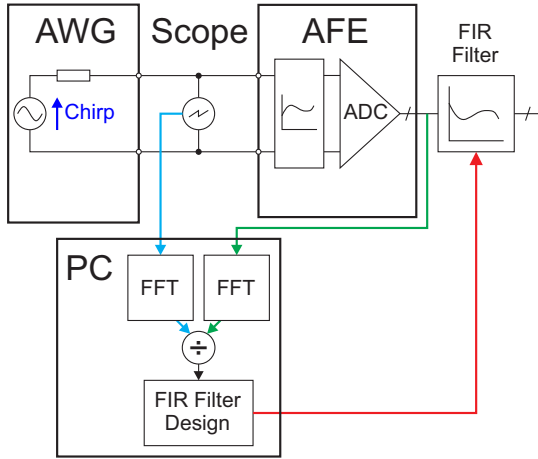

Fig. 2. Setup for Measuring Distortion of Analog Front End and Calculating Required Normalisation Filter Response

Once the response of the system is known, if significant distortion is found, correction is possible by passing the signal through a filter with an inverse gain response to the AFE. The inverse filter will compensate for the distortion caused by the AFE and equalise the systems pass-band range to improve accuracy of measurements performed by the system.

III. EXPERIMENTAL VALIDATION WITH THE UARP II SYSTEM

A. UARP II AFE Architecture

The Ultrasound Array Research Platform (UARP) consists of a fairly typical signal path in its AFE. The first step in this signal chain for each individual channel is a T-R switch integrated into a MAX14808 (Maxim Integrated) high voltage (HV) pulser IC which allows for switched excitation techniques in transmit [9] [10] and electrical protection for the receiver. The receive side of the switch is then fed via AC coupling capacitors into an integrated amplifier and ADC utilising an AFE5807 (Texas Instruments).

Once digitised, the echo signals are grouped into 16 channel sections. The data from each section is collected and processed by a custom firmware architecture running on a Stratix V 5SGSMD5K2F40C2 (Altera/Intel Corp.) Field Programmable

Gate Array (FPGA) node, the key receive (Rx) portion is shown in Fig.3. The UARP system was designed in this modular architecture to allow the system to be suited to many applications from low-channel-count industrial systems to much higher channel count imaging systems. Each of these nodes contains a back end Digital Signal Processing (DSP) pathway which includes a real-time fully reconfigurable digital FIR filter with up to 94 multiplier taps for each channel.

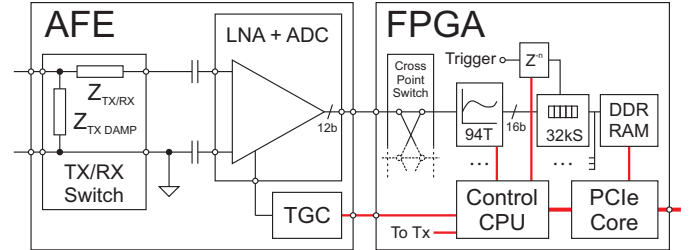

Fig. 3. Diagram of Rx Portion of UARP System Architecture

The FPGA nodes all connect back via a PCI Express (PCIe) backplane to a Personal Computer (PC) running Mathworks Matrix Laboratory (MATLAB) software. The processed receive data is copied back to the PC on-the-fly allowing real time viewing of the data. The PCIe link is further used to send configuration data to the UARP including FIR filter coefficients, and also to control the system using a diverse set of instructions. This control diversity could allow for the process of measuring the frequency response of the system and applying correction filters to be fully automated.

B. Frequency Response Measurement

To validate the necessity and effectiveness of the proposed method for normalisation, a 16-ch UARP system was used as a test bench. To first measure the frequency response of the UARP AFE, a 33612A AWG (Keysight Technologies) was used to provide the input stimulus, with an Infiniium S-Series MSO-S 104A 1GHz Bandwidth Oscilloscope (Keysight Technologies) was used to record a measurement of the signal directly at the transducer connection terminals on the front of the UARP. The scope was additionally connected via network to the same PC as the UARP to allow this measured signals to be downloaded directly into MATLAB. The experimental setup is shown in Fig.4. An external trigger output from the UARP system was connected to the oscilloscope to ensure the data collected by both devices has a consistent delay to allow proper analysis.

The AWG was programmed with a broadband chirp signal designed in MATLAB with start and stop frequencies of 100 kHz and 30 MHz respectively. This allows for a practical calibration range of 1 MHz to 29 MHz due to the windowing used on the signal. Additionally, both outputs of the AWG were used connected to different channels of the UARP to allow simultaneous calibration of two channels, and to allow comparison of the gain response of different channels to determine if a single correction filter could be used across all channels.

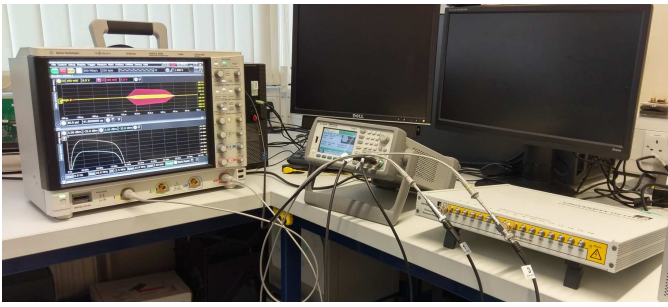

Fig. 4. Experimental Setup for Measuring UARP AFE Frequency Response

The chirp parameters were chosen to cover the full frequency range of the UARP AFE, but could be easily adapted to suit higher or lower frequency AFEs. Additionally, the amplitude of the chirp signal was chosen to be on the order of 200 mVpp to match the full scale range of the ADC in the UARP system but ensuring no clipping of the signal occurred. Due to limited bandwidth on the output of the AWG, the chirp waveform was pre-distorted to ensure that the output as measured on the oscilloscope had a flat frequency response, as shown in Fig.5(b).

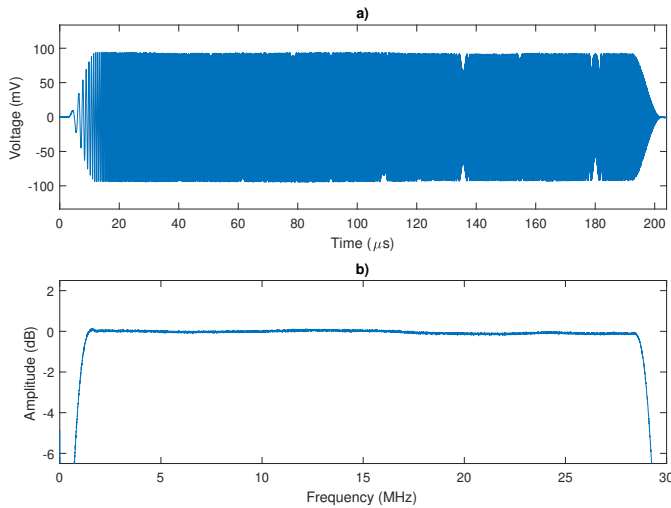

Fig. 5. Measured Voltage (a) and FFT (b) of Chirp Test Signal with 15 MHz Centre Frequency and 28 MHz Bandwidth Captured using Oscilloscope

A sequence of 32 receive triggers at a Pulse Repetition Frequency (PRF) of 100 Hz was performed and 200 μ s worth of data collected for each firing. The receive data from these firings were then averaged to reduce noise in the measurements to achieve a more accurate estimation of the response. The oscilloscope data was then time aligned and resampled in MATLAB to match the sample rate of the UARP, and the FFT of both waveforms taken.

The FFT of the data captured through the AFE of the UARP is shown in Fig.6. Comparing this data to the actual input signal as measured by the oscilloscope (Fig.5), it is quite clear that front end is causing significant distortion of signal - over

6 dB ($20 \log_{10}$) difference is seen across the 2-28 MHz range in which the input chirp signal is flat.

Comparing the shape of the response with that of the frequency response of the LPF in the AFE5807 (Fig.1), it is possible to identify that much of the distortion at the higher frequency end (>10 MHz) is caused at least in part by this component. The distortion at the lower frequency end is most likely resulting from the necessity to AC-couple the input to the system due to biasing requirements of the ADCs, leading to an attenuation at lower frequencies.

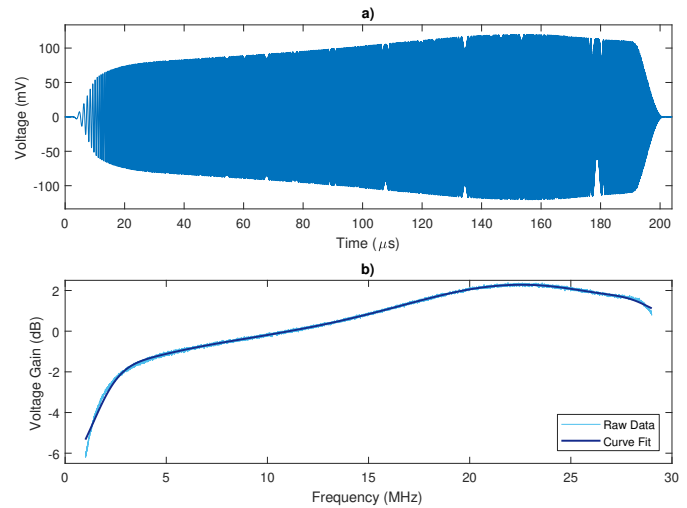

Fig. 6. Measured Voltage (a) and FFT (b) of Gain Frequency Response of UARP AFE with No Correction

C. Equalisation Using FIR Filters

In order to normalise this gain response, the filter must have a gain response that is inverse to that of the AFE. To design such a filter, first the MATLAB curve fitting toolbox was used to apply a smoothing spline to the FFT data to remove localised ripple in the spectrum and so reduce the effort required by the filter design tool to find a solution. The resulting smooth curve was then inverted to calculate the required equalisation filter response. This required filter response was fed into the MATLAB arbitrary magnitude FIR filter design tool, from which a 94-tap filter was designed using the Least Squares Linear Phase method.

The numerator coefficients were then extracted from MATLAB and then normalised to fixed point coefficients. The normalisation step is simply a scale factor applied to all coefficients to convert the MATLAB 0-1 floating point normalised range to a fixed point representation used by the Altera/Intel FIR Filter Core implemented within the UARP system.

The coefficients were then uploaded to the UARP and the measurements repeated with the filters enabled. The receive data was again measured using 32 averages, and the FFT taken. The corrected response is shown in Fig.7 which can be seen to be practically flat across the frequency range, with a minor bump at the low frequency end.

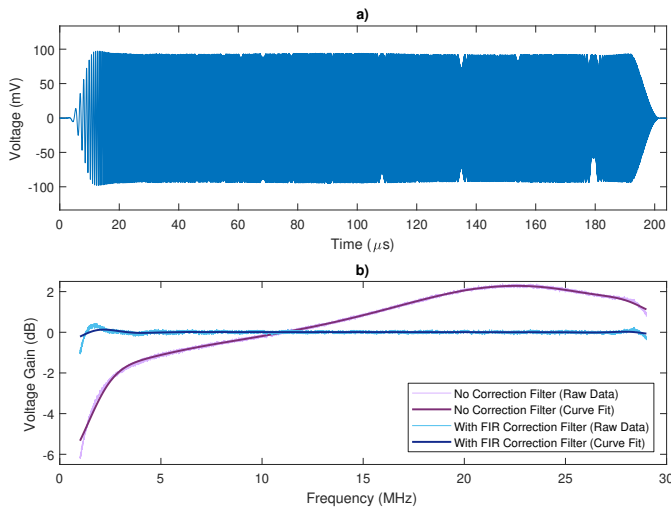

Fig. 7. Measured Voltage (a) and FFT (b) of Gain Frequency Response of UARP AFE with FIR Filter Correction Enabled

IV. CONCLUSIONS

Typical ultrasound systems have multiple components in the receive signal path, with each stage potentially causing a frequency dependent distortion. This distortion will not only impact signal quality, but can also by definition affect the accuracy of any quantitative measurements made using such a system.

In this paper, the existence of such distortion was demonstrated for an imaging system which uses commercially available integrated front end components. Similar circuitry will be present in many commercial and research ultrasound imaging systems.

By measuring and characterising this distortion, it has been shown that by designing and implementing correctly matched inverse FIR filters, it is possible to correct for this distortion and equalise over the systems usable frequency range. This correction is performed in the digital domain and as such is compatible with systems that use integrated electronics which prevents the addition of analogue filtering into much of the signal path.

The UARP imaging system implements per-channel 94-tap FIR filters within its data-acquisition hardware. These filters are typically used for performing Hilbert transformation, but can additionally be used for performing distortion correction in real-time without no loss in acquisition speed and image processing times.

REFERENCES

- [1] E. Brunner, "How ultrasound system considerations influence front-end component choice," *Analog Dialogue*, vol. 36, no. 2, p. 2, May 2002.
- [2] E. Boni, A. C. H. Yu, S. Freear, J. A. Jensen, and P. Tortoli, "Ultrasound open platforms for next-generation imaging technique development," *IEEE Transactions on Ultrasonics, Ferroelectrics, and Frequency Control*, vol. 65, no. 7, pp. 1078–1092, July 2018.
- [3] D. Cowell, T. Carpenter, B. Fisher, and S. Freear, "In-situ measurement of transducer impedance using afe active termination through analysis of ultrasound echoes," in *2017 IEEE International Ultrasonics Symposium (IUS)*, Sept 2017, pp. 1–1.
- [4] J. Mamou and M. L. Oelze, *Quantitative Ultrasound in Soft Tissues*. Berlin, Germany: Springer Science & Business Media, 2013.
- [5] Texas Instruments Inc., "Fully Integrated, 8-Channel Ultrasound Analog Front End with Passive CW Mixer," AFE5807 Datasheet, p. 14, Sept. 2010, [Revised May 2013].
- [6] C. R. Ilvedson, "Transfer function estimation using time-frequency analysis," Master's thesis, Massachusetts Institute of Technology, 1998.
- [7] X.-G. Xia, "System identification using chirp signals and time-variant filters in the joint time-frequency domain," *IEEE Transactions on Signal Processing*, vol. 45, no. 8, pp. 2072–2084, Aug 1997.
- [8] S. Harput, M. Arif, J. McLaughlan, D. M. J. Cowell, and S. Freear, "The effect of amplitude modulation on subharmonic imaging with chirp excitation," *IEEE Transactions on Ultrasonics, Ferroelectrics, and Frequency Control*, vol. 60, no. 12, pp. 2532–2544, Dec 2013.
- [9] D. M. J. Cowell, P. R. Smith, and S. Freear, "Phase-Inversion-based Selective Harmonic Elimination (PI-SHE) in multi-level switched-mode tone- and frequency- modulated excitation," *IEEE Transactions on Ultrasonics, Ferroelectrics, and Frequency Control*, vol. 60, no. 6, pp. 1084–1097, June 2013.
- [10] P. R. Smith, D. M. J. Cowell, and S. Freear, "Width-modulated square-wave pulses for ultrasound applications," *IEEE Transactions on Ultrasonics, Ferroelectrics, and Frequency Control*, vol. 60, no. 11, pp. 2244–2256, November 2013.