

# Enterprise Simulation Of The Precast Concrete Manufacturing Industry

Al-Bazi, A. F. and Dawood, N.

Author copy deposited in Coventry University repository

**Original citation:**

Al-Bazi, A. F. and Dawood, N. (2008) 'Enterprise Simulation Of The Precast Concrete Manufacturing Industry' , 'International Conference on Information Technology in Construction'. Held 15-17 July 2008 at Santiago, Chile.

<http://www.itcon.org/cgi-bin/events/Show?58d8>

Copyright © and Moral Rights are retained by the author(s) and/ or other copyright owners. A copy can be downloaded for personal non-commercial research or study, without prior permission or charge. This item cannot be reproduced or quoted extensively from without first obtaining permission in writing from the copyright holder(s). The content must not be changed in any way or sold commercially in any format or medium without the formal permission of the copyright holders.

## ENTERPRISE SIMULATION OF THE PRECAST CONCRETE MANUFACTURING INDUSTRY

Ammar Al-Bazi  
[1a.f.albazi@tees.ac.uk](mailto:1a.f.albazi@tees.ac.uk)

Nashwan Dawood  
[n.n.dawood@tees.ac.uk](mailto:n.n.dawood@tees.ac.uk)

Centre for Construction Innovation Research, School of Science & Technology, University of Teesside,  
Middlesbrough, TS1 3BA, UK

### ABSTRACT

The lack of applied innovative tools, for improving the performance of the precast concrete products manufacturing industry, has led the researchers in this paper to develop an Enterprise Simulation Precast Concrete (ESPC) model, to improve the performance of the precast industry. As an initial stage, a detailed layout for the precast concrete production processes is developed in order to understand the relationships amongst the manufacturing processes in such industry. In addition, simulation methodology is developed to analyse the precast manufacturing system and identify the resource bottlenecks. Heuristic searching rule is developed in order to simulate the accommodation process of the produced items in a temporary stockyard area.

The results indicated low utilisation of the used resources due to using only one curing area for storage and retrieval processes.

### KEYWORDS

Precast concrete products, enterprise simulation model, discrete event simulation modelling, manhole manufacturing system, heuristic searching rule.

### 1. INTRODUCTION

The precast concrete industry in the UK is very traditional and highly influenced by the fluctuated construction market. The industry has been utilising outdated tools and methods to plan and manage production processes. This has limited the growth and development in such industry.

Production managers are calling for more advanced systems that enable them to identify and model production processes and hence identify bottlenecks and production hotspots. This should lead to a better production, higher machine utilisation, and better workflow.

In order to achieve this, a holistic Enterprise Simulation of Precast Concrete (ESPC) is proposed in this paper. The ESPC is being developed as a part of a major research initiative with the objective of improving the performance of the industry by modelling and simulating the enterprise process.

### 2. STATE OF THE ART LITERATURE REVIEW

Several research projects, using simulation technology to improve the performance of the precast concrete product manufacturing systems, have been conducted. Dawood, N., (1995) developed a scheduling model using the simulation modelling approach in order to help production managers to make better planning decisions, and explore alternative options.

Liu, L.Y., (1995), used a discrete-event simulation methodology in modelling the construction of precast-concrete parking structures. Marasini, R., et al (2001), presented an innovative stockyard layout planning system for a precise building products industry.

Vern, K., (1998) developed a simulation model to capture many of the random elements, and facilitate the analyses of complicated “what-if” scenarios, within the precast concrete building elements. Sacks, R., et al (2004) emphasised on the importance of studying the precasting processes in order to find the ways in which companies can manage businesses to achieve best performance of their production systems. Bravo, E.B., (1998) used the simulation for the production of precast pieces in a workshop to obtain several working alternatives. The main objective was to improve productivity and therefore reduce the production

costs. Shi, J.J., et al., (1998) adopted the simulation technique for modelling and simulating public housing construction in order to speed up the public housing construction process with the intention to conclude the appropriate floor cycle construction time and necessary resource combinations. Benjaoran, V., et al. (2005) proposed an integrated, comprehensive planning system called Artificial Intelligence Planner (AIP) to improve the efficiency of the process by targeting production planning as it has a significant impact to the success of business.

The limitations in the above literature are that the modelling has been focused on one part of the system and the lack of applied innovative intelligent enterprise tools where a holistic approach would be more effective.

The rest of the paper is organized as follows: section 3 describes the research methodology; section 4 presents development of ESPC model, section 5 shows the experimental work, section 6 presents results analysis and interpretations, and section 7 outlines the conclusions and future developments.

The next section will define the research methodology and other related objectives.

### **3. RESEARCH METHODOLOGY**

The aim of this ongoing research is substantially to improve the current practices of production planning by applying simulation tools and methods that will integrate the whole precast concrete enterprise.

The main objectives of the research are:

- (1) To study current processes, and develop a detailed process map of the precast concrete products manufacturing plant, in order to understand the production flow processes that exist.
- (2) Develop a system framework and a simulation prototype to analyse the precast manufacturing system and to identify the resource bottlenecks.

To satisfy the above objectives, the following methodology has been developed:

1. Data collection from the precast manhole manufacturing industry has been conducted through data collection at different precast concrete products manufacturing companies.
2. Integration Definition for Function Modelling (IDEF0) has been used to model the decisions, actions, and activities of the production processes in the precast concrete industry.
3. Discrete Event Simulation methodology is used to develop an enterprise simulation model which will enable the planners to identify the bottlenecks and to improve the productivity to achieve the best course of action.

## **4. DEVELOPMENT OF THE ENTERPRISE SIMULATION PRECAST MODEL (CASE STUDY FOR THE MANHOLE PRECAST MANUFACTURING INDUSTRY)**

### **4.1 DEVELOPMENT OF THE ENTERPRISE SIMULATION FRAMEWORK**

The research framework is proposed in terms of how to improve the performance of the precast concrete products manufacturing system. This demonstration is useful to define the components of the proposed intelligent system and to understand how these components can be efficiently integrated with each other.

The enterprise simulation framework is illustrated as shown in Figure (1).

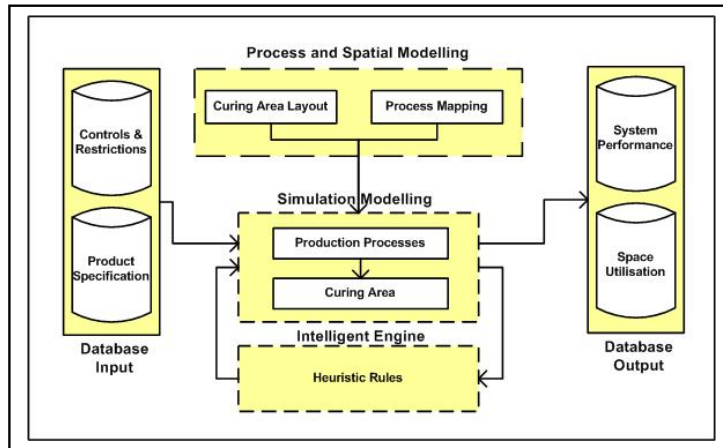

Figure 1: shows framework of the enterprise simulation model

The main core of the ESPC framework consists of:

- (1) Modelling of the processes for the whole enterprise.
- (2) Detailed modelling of the temporary stockyard area as an integral part of the production system.
- (3) Modelling of a heuristic rule as a decision rule to guide the process of accommodating products inside the temporary stockyard area.

To model the processes of the whole enterprise, a visual modelling language (IDEF0) has been developed to provide the simulation programmer with a full understanding about the relationships amongst the manufacturing processes.

By Depending on the product type, different layouts of the temporary stockyard area were drawn and sketched using AutoCAD.

A heuristic rule is developed to guide the process of accommodating products, ARENA simulation in conjunction with VBA were used to enable the modelling of this type of rule.

ESPC model is developed to improve the performance of the precast industry. Efficient management of the temporary stockyard area is required to achieve the best utilisation of the temporary storage area.

## 4.2 ENTERPRISE SIMULATION PRECAST CONCRETE DEVELOPMENT TOOLS

### 4.2.1 DEMONSTRATION OF THE ENTERPRISE SIMULATION THROUGH A CASE STUDY

The purpose of the developed case study layout is to provide a framework for applying logic that can simulate each of the manhole manufacturing sub-systems individually. See figure (2)

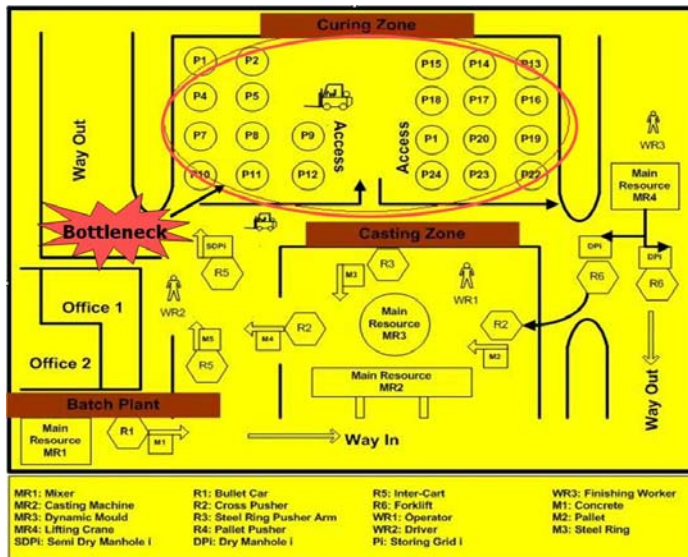

Figure 2: The layout of the case study.

In the layout showed in figure (2), the manufacturing system is consisting of three main zones: batch plant, casting, and curing zones.

In this first zone, the mixer works with the bullet car (mix transfer car) in order to provide concrete to the casting zone. A set of transporters are working together in the second zone to form the final shape of the produced manhole in terms of mould and other details. The third zone is temporary stockyard which used to accommodate products temporarily. (For more details, see the process flowchart in the next section)

#### 4.2.2 PROCESS FLOWCHART

Manufacturing of precast product elements is essentially performed in a job-shop environment. That is, the produced manhole has several variants depending on the order type. The production stages and details about the manufacturing processes are described in figure (3).

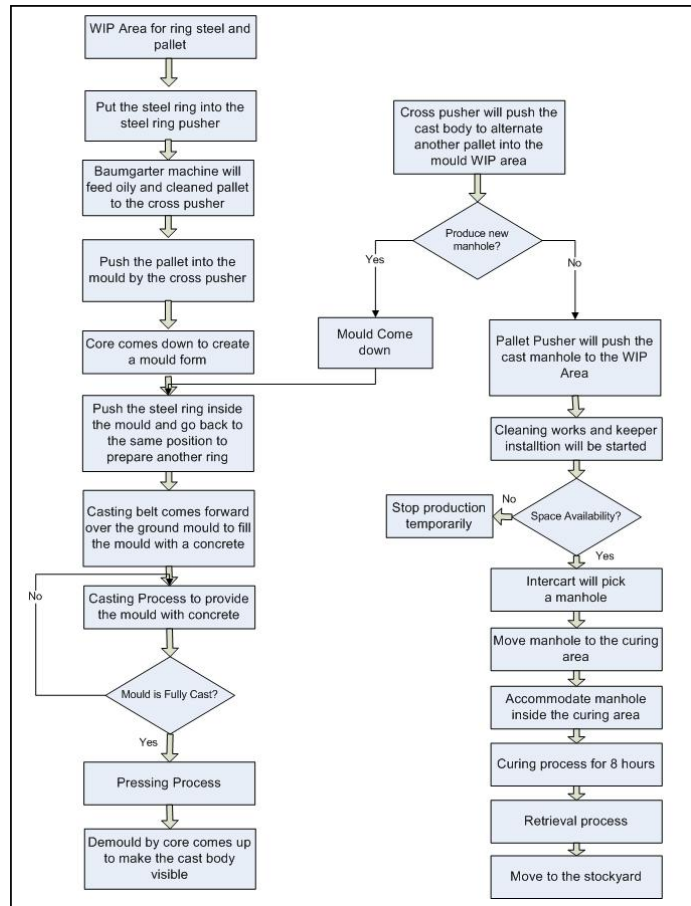

Figure 3: Flowchart represents the details of the production processes

The production process starts when the concrete material is moved from the mixer (main resource) using a special vehicle called a bullet car in order to provide the casting zone with the concrete required for casting.

At the casting zone, several mechanical operations are carried out to form the final shape of the manhole. Cross pusher performs the first activity to position the pallet assigned for each manhole. The dynamic mould is the second movement which takes place after the pallet is positioned to form the circular shape of the manhole ready to receive concrete. Before the casting process, a steel ring is placed inside the mould using a steel ring pusher arm by a positioning device.

The casting process is started when the concrete from zone one is received via a bullet transporter car. After the mould has been filled with concrete, a pressing shaft applies pressure to press the concrete inside the mould under vibration to form the manhole into the final shape. The manhole after pressing is pushed by the pallet pusher to enable finishing works to be conducted by two operatives.

A lifting transporter called an InterCart is used to grab the cast manhole, and transport / position it into the storage grid inside the curing area.

There is an access bottleneck in the storage and retrieval processes due to the limited space capacity in the curing area. The objective of the research is to optimise the curing area space utilisation in order to achieve the maximum output possible within the space constraints.

### 4.3 MODEL ASSUMPTIONS

In order to simplify the modelling process, assumptions were made while constructing this model, some examples of them are:

- Each order is processed by the same processing machines.
- All manufacturing machines can process one manhole at a time.
- Machine failure is not considered in this study and idealistic machines were assumed.
- The process setup time of the machines is considered in this model.
- All work process take place over a 24 hour period.
- Raw materials are already available at Work In Progress (WIP) Area.

### 4.4 DATA COLLECTION FOR ESPC SIMULATION MODEL

The fundamental conceptual approach used was to obtain reliable information about the duration of each production cycle and the resource that employs. The tools used were: *Time study* to measure the machine cycle, *Work Sampling* to measure the human work, *IT tools* (AutoCAD 2007) to estimate the distances from the casting zone to each of its storage places.

All information required in the ESPC model was gathered by conducting an on-site data collection. On-site measurements using measure tape were carried out to determine the scale of the job-shop. A scaled map of the manufacturing system was drawn using AutoCAD to estimate the distances between the casting machine and each storage place (in the form of a grid). Crane X,Y, and Z axis distances were estimated using AutoCAD. The intercart transfer vehicle paths and routes were determined after structured interviews with the intercart driver and curing area workers. See figure (4).

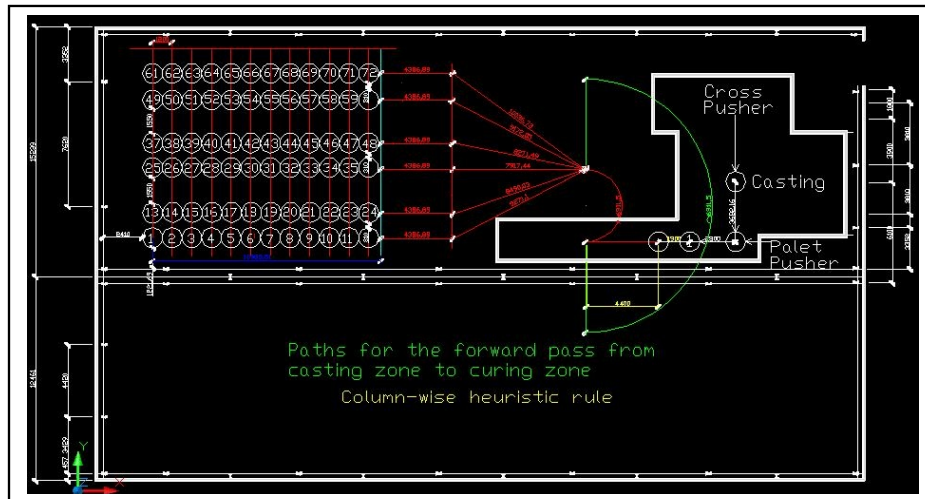

Figure 4: Snapshot for the forward pass from casting zone to curing zone using column wise heuristic storage rule

Figure (4) shows how AutoCAD was used to estimate all the relevant distances from the casting zone to curing area for the intercart forward pass.

Similarly, all other distance estimations were done for retrieval processes and crane x,y, and z distances to provide the simulation model with appropriate validated data.

### 4.5 SIMULATION OF THE MANHOLE PRECAST PRODUCTION SYSTEM

In this section, the conceptual model of the manufacturing system is converted into a dynamic version of modelling by adopting discrete-event simulation methodology. Simulation modelling is applied to imitate and visualise the production processes of the manhole precast manufacturing system to evaluate key performance indicators in such type of industry.

Figure (5) shows the application of ARENA simulation software.

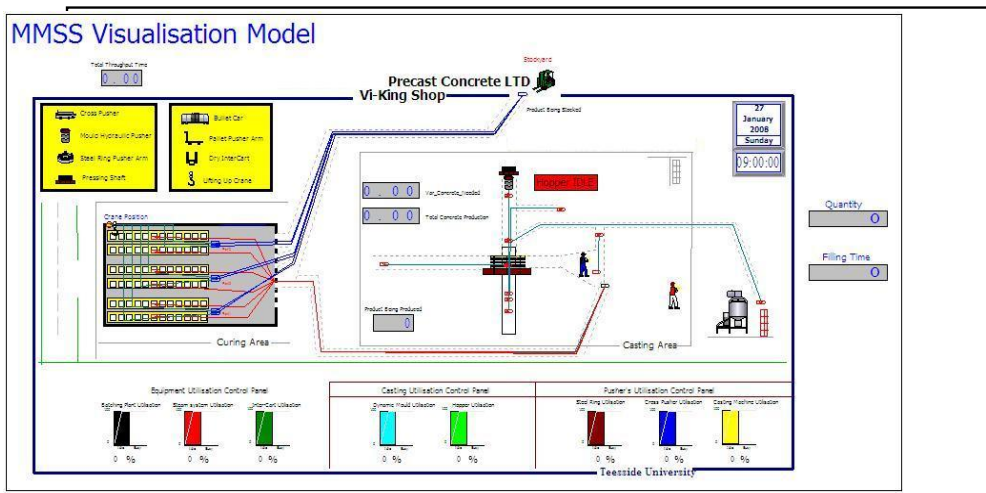

Figure 5: Snapshot of the ESPC model

#### 4.6 SIMULATION OF THE CURING AREA

As an integral part of the production system, the curing area is considered to be simulated in conjunction with the production system. This type of integration will enable the production planner to maximise the efficient use of the curing area in terms of space utilisation to increase the production productivity further. In the temporary stockyard area, each storage area is modelled as a resource. A set of twelve resources will form a storage zone. Six zones are considered as the whole storage capacity for the curing zone. See figure (6)

The temporary stockyard resources are: a grid of storage (12x6) places, intercart, forklift and overhead crane. Constraints on the storage and retrieval processes, are:

1. The intercart has its own paths in order to reach the curing storage places.
2. Some of the paths are identical and others are not depending on the curing area occupancy.
3. Retrieval process start after the whole curing area has been filled.

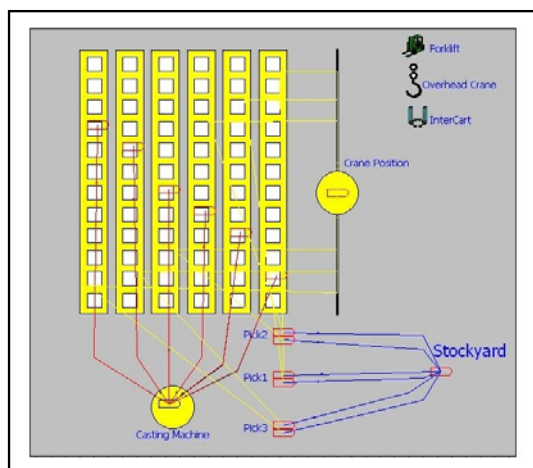

Figure 6: Snapshot of developed temporary stockyard simulation model (Part of ESPC model)



In figure (6), the applied storage rule was a column-wise heuristic storage rule. The retrieval heuristic rule used a First-In First-Out (FIFO) strategy.

The dry manhole is placed in-front of its zone (one over one) to be picked up by the forklift. (Two manholes in one go)

The difficulties faced in developing this type of simulation were:

1. How to accommodate manholes in each of those zones sequentially.
2. When to start retrieving manholes from the curing area.

The challenges in developing ESPC model were:

1. How to changeover between production process and the storage process.
2. How to synchronise the production rate with the capacity of storage area.
3. How to sustain the working of a production system as long as possible.
4. How to avoid clashes between curing area resources and the production process resources.

The simulation model was developed for each zone individually (*batch, casting and temporary stockyard* zones) as sub-models depending on the complexity of each sub-system. The sub-models then were simulated and combined together to generate the Enterprise Simulation Precast Concrete model.

#### **4.7 MODEL VERIFICATION AND VALIDATION**

Initial verification was carried out by tracking the animation of the entities using a trace function to track entities through the system, this technique is used to ensure that all entities are travelling to the proper location in accordance with the entity flow diagram. Additionally, to ensure the model accurately reflected the data supplied and that it generated the outputs required by the conceptual model. Two separate structured interviews were conducted: one with the production manager and other with a wider group of operators, to access the impact of the simulation on the users was performed during the validation procedure.

The validation was performed by comparing the actual time value of a cycle for a manhole with an estimated value obtained from simulation. From this outcome, was proven that the model reflects actual cycle time of the selected processes sufficiently and accurately.

#### **5. RUNNING THE EXPERIMENTAL WORK**

The following scenarios are considered after detecting the bottlenecks that were yielded due to the restrictions of the curing area in terms of space and other restrictions.

1. *Scenario 1:* Using one InterCart transporter to move out each produced manhole from the casting zone to the curing zone.
2. *Scenario 2:* Use of two Intercart transporters working together in moving the produced manholes.
3. *Scenario 3:* Use of the fastest InterCart transporters to speed up the process of moving the manholes to their storage grids.
4. *Scenario 4:* Use an additive material\* to speed up the curing process.

By running the simulation model for each scenario, their effects can be determined in terms of “throughout time” and “utilization of resources”. Figure (7) shows the reduction in total throughput time by running scenarios 1,2,3, and 4.

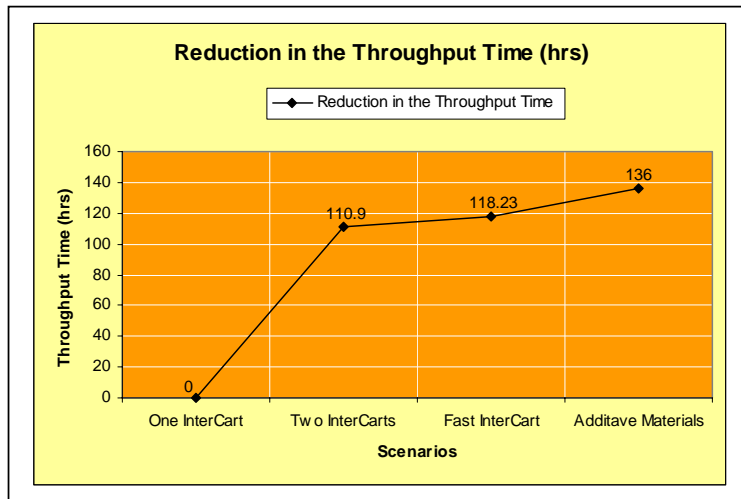

Figure 7: Represents the effects of adopting various curing area resources

Figure (7) reveals that scenario 4 has the maximum reduction (136hrs) out of 795.51 hrs. It means that by adding some additive to the concrete, the process of curing manholes will be faster which reflect the influence of running scenarios on the production flow.

The continuation of resources working in any production system has a great effect on the utilization of the resources used especially those in the production zone. See figure (8)

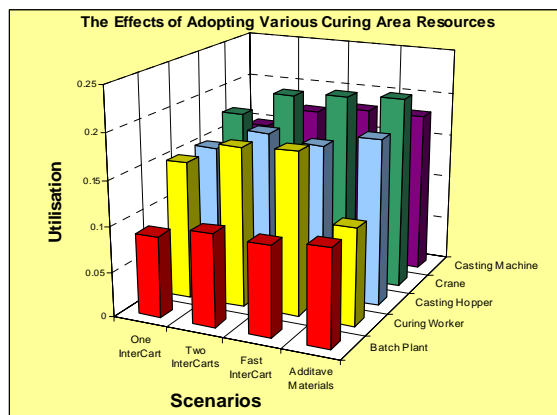

Figure 8: Represents the effects of adopting various curing area resources

\* Additive materials were used here to speed up the curing time while maintaining the quality of the product within the industry quality standard.

The best scenario in terms of maximizing the resource utilization was scenario 4. The resources utilization shows the effect of adding additive materials in speeding up the curing process by minimizing the curing time. Casting machine, batch plant and other production resources were improved in terms of utilization. Crane resource utilization is improved as well by providing a minimum curing time which diminishes the idle time of the crane.

## 6. ANALYSIS AND INTERPRETATION

The results above indicated low utilization of the used resources, and maximum throughput time. This bottleneck in the production system is caused due to using only one curing area for storage and retrieval processes. The problem is that, the production system is stopped each time the curing area is filled and that issue increases the idle time of the production resources. The production will not be started until all products have been removed from the curing area for health and safety purposes. The retrieving process

in the curing area is not allowed until the whole curing area is filled by manholes. The limited capacity of the curing area in terms of space, resources and other restrictions has caused the reduction in resource utilization and subsequently maximizes the total throughput time.

## **7. CONCLUSIONS AND FUTURE DEVELOPMENTS**

### **7.1 CONCLUSION**

The purpose of the study was to develop an Enterprise Simulation Precast Concrete model for a manhole production system as a case study. The production system was modeled using ARENA to identify bottlenecks and evaluate curing area performance.

In spite of the slight improvement in the performance of the manufacturing system, the curing area is still a crucial factor which needs to be deeply investigated in terms of the way of storing and retrieval products is undertaken, which will be the main functionality of the intelligent searching rule.

More intelligence is needed to investigate and run more scenarios in terms of investigating more alternatives.

### **7.2 FUTURE DEVELOPMENTS**

Another curing area will be considered and simulated to be worked together with the first one. Both of them will be working alternatively, one for storage when retrieving the other and vice versa. This solution will ensure the production system in terms of resources will be worked in a more continuous manner. Less idle time will be associated with waiting for the products to be cured and retrieved.

Different layout regarding the way of storage will be investigated as a later stage in this project. Column wise storage layout is adopted in this research, row, column block set, row block set, and clock-wise layout will be adopted to determine the best storage method and the fastest retrieval operation.

The optimization engine will be developed to optimize the performance of the manufacturing system by manipulating of the number and capacities of the used resources, a different layout for storage pattern, and various loading rules for both orders and the retrieval process. Therefore, a sequencing algorithm will have to take into account the effect of a lot of combinations. To solve this problem, an approach that combines simulation and an optimization engine in terms of heuristic rules to generate sequences of storage strategy, that leads to optimal or close-to-optimal performance, will be adopted.

## **REFERENCES**

- Benjaoran, V. Dawood, N. and Hobbs, B. (2005) "Flow scheduling model for bespoke precast concrete production planning". *Journal of construction management and economics*, Vol. 23, 93-105.
- Bravo, E.B., (1998) "Simulation of large precast operations", *Proceedings of the 1998 Winter Simulation Conference*.
- Dawood, N. (1995) "Scheduling in the precast concrete industry using the simulation Modelling approach". *Journal of Building and Environment*, 30(2), 197-207, 1995.
- Glover, F., Kelly, J.P., Laguna, M. (1999) "New advances for wedding optimisation and simulation". *Proceeding of the 1999 Winter Simulation Conference*.
- Liu, L.Y., (1995) "Simulating construction operations of precast-concrete parking structures". *Proceedings of the 1995 Winter Simulation Conference*.
- Marasini, R., and Dawood, N. (2002) "Simulation modelling and optimisation of stockyard layouts for precast concrete products". *Proceeding of the 2002 Winter Simulation Conference*.
- Pace, Dale, K. (2000) "Ideas about simulation conceptual model development". *John Hopkins APL Technical Digest*, 21(3), 327-336,2000.
- Sacks, R., Eastman, C.M. and Lee, G. (2004) "Process model perspectives on management and engineering procedures in the precast/prestressed concrete industry". *Journal of Construction Engineering and Management*, 130(2), 206-215,2004.
- Shi, J.J., Zeng, S.X, and Tam,C.M. (1998) "Modelling and simulation of public housing construction in Hong Kong". *Proceedings of the 1998 Winter Simulation Conference*.
- Vern, K., Gunal, A., (1998) "The use of simulation for construction elements manufacturing". *Proceeding of the 1998 Winter Simulation Conference*.