

# Theory and description in African Linguistics

Selected papers from the 47th  
Annual Conference on African  
Linguistics

Edited by

Emily Clem

Peter Jenks

Hannah Sande

Contemporary African Linguistics 4



## Contemporary African Linguistics

Editors: Akinbiyi Akinlabi, Laura J. Downing

In this series:

1. Payne, Doris L., Sara Pacchiarotti & Mokaya Bosire (eds.). Diversity in African languages: Selected papers from the 46th Annual Conference on African Linguistics.
2. Persohn, Bastian. The verb in Nyakyusa: A focus on tense, aspect and modality.
3. Kandybowicz, Jason, Travis Major & Harold Torrence (eds.). African linguistics on the prairie. Selected papers from the 45th Annual Conference on African Linguistics.
4. Clem, Emily, Peter Jenks & Hannah Sande (eds.). Theory and description in African Linguistics: Selected papers from the 47th Annual Conference on African Linguistics.
5. Lotven, Samson, Silvina Bongiovanni, Phillip Weirich, Robert Botne & Samuel Gyasi Obeng (eds.). African linguistics across the disciplines: Selected papers from the 48th Annual Conference on African Linguistics.

# Theory and description in African Linguistics

Selected papers from the 47th  
Annual Conference on African  
Linguistics

Edited by

Emily Clem

Peter Jenks

Hannah Sande



Clem, Emily, Peter Jenks & Hannah Sande (eds.). 2019. *Theory and description in African Linguistics: Selected papers from the 47th Annual Conference on African Linguistics* (Contemporary African Linguistics 4). Berlin: Language Science Press.

This title can be downloaded at:

<http://langsci-press.org/catalog/book/192>

© 2019, the authors

Published under the Creative Commons Attribution 4.0 Licence (CC BY 4.0):

<http://creativecommons.org/licenses/by/4.0/> 

ISBN: 978-3-96110-205-1 (Digital)

978-3-96110-206-8 (Softcover)

ISSN: 2511-7726

DOI:10.5281/zenodo.3365789

Source code available from [www.github.com/langsci/192](http://www.github.com/langsci/192)

Collaborative reading: [paperhive.org/documents/remote?type=langsci&id=192](http://paperhive.org/documents/remote?type=langsci&id=192)

Cover and concept of design: Ulrike Harbort

Typesetting: Peter Jenks, Felix Kopecky, Sebastian Nordhoff, Tessa Scott

Illustration: Sebastian Nordhoff

Proofreading: Ahmet Bilal Özdemir, Alexandr Rosen, Alexandra Vydrina, Andrew M. Lamont, Anna Belew, Felix Hoberg, Felix Kopecky, Jeroen van de Weijer, Kent Rasmussen, Ludger Paschen, Luigi Talamo, Martin Haspelmath, Michelle Natolo, Mykel Brinkerhoff, Jean Nitzke, Rachel Lee, Rosey Billington, Vadim Kimmelman, Varun deCastro-Arrazola

Fonts: Linux Libertine, Libertinus Math, Arimo, DejaVu Sans Mono

Typesetting software: Xe<sub>La</sub>TeX

Language Science Press

Unter den Linden 6

10099 Berlin, Germany

[langsci-press.org](http://langsci-press.org)

Storage and cataloguing done by FU Berlin

Freie Universität  Berlin

# Contents

<b>Preface</b>	<b>v</b>
<b>I Phonetics and phonology</b>	
1 A featural analysis of mid and downstepped high tone in Babanki Pius W. Akumbu	3
2 Metrically conditioned vowel length in Dagaare Arto Anttila & Adams Bodomo	21
3 “Backwards” sibilant palatalization in a variety of Setswana Wm. G. Bennett	41
4 Liquid realization in Rutooro Lee Bickmore	63
5 Tumbuka prosody: Between tone and stress Laura Downing	75
6 Hybrid falling tones in Limbum Siri Gjersøe, Jude Nformi & Ludger Paschen	95
7 Notes on the morphology of Marka (Af-Ashraaf) Christopher R. Green & Evan Jones	119
8 Implosives in Bantu A80? The case of Gyeli Nadine Grimm	135
9 Downstep and recursive phonological phrases in Bàsàá (Bantu A43) Fatima Hamlaoui & Emmanuel-Moselly Makasso	155

*Contents*

<b>10</b>	<b>Reconsidering tone and melodies in Kikamba</b>	
	Patrick Jones & Jake Freyer	177
<b>11</b>	<b>Acoustic correlates of harmony classes in Somali</b>	
	Wendell Kimper, Wm. G. Bennett, Christopher R. Green & Kristine Yu	199
<b>12</b>	<b>Prosody and the conjoint/disjoint alternation in Tshivenda</b>	
	Leland Paul Kusmer	213
<b>13</b>	<b>Obstacles for gradual place assimilation</b>	
	Andrew Lamont	231
<b>14</b>	<b>The phonetics and phonology of depressor consonants in Gengbe</b>	
	Samson Lotven & Kelly Berkson	249
<b>15</b>	<b>Factors in the affrication of the ejective alveolar fricative in Tigrinya</b>	
	Emily Moeng & William Carter	269
<b>16</b>	<b>Between tone and stress in Hamar</b>	
	Sara Petrollino	287
<b>17</b>	<b>Verbal gestures in Cameroon</b>	
	Betsy Pillion, Lenore A. Grenoble, Emmanuel Ngué Um & Sarah Kopper	303
<b>II</b>	<b>Syntax and semantics</b>	
<b>18</b>	<b>Contrastive focus particles in Kusaal</b>	
	Hasiyatu Abubakari	325
<b>19</b>	<b>Non-canonical switch-reference in Serer</b>	
	Viktorija Apel	349
<b>20</b>	<b>Upward-oriented complementizer agreement with subjects and objects in Kipsigis</b>	
	Michael Diercks & Meghana Rao	369

21	<b>Serial verb nominalization in Akan: The question of intervening elements</b> Obádélé Bakari Kambon, Reginald Akuoko Duah & Clement Kwamina Insaidoo Appah	395
22	<b>Verb and predicate coordination in Ibibio</b> Philip T. Duncan, Travis Major & Mfon Udoinyang	423
23	<b>On the derivation of Swahili <i>amba</i> relative clauses: Evidence for movement</b> Isaac Gould & Tessa Scott	441
24	<b>The Aorist and the Perfect in Mano</b> Maria Khachaturyan	463
25	<b>Nominal quantification in Kipsigis</b> Meredith Landman	481
26	<b>Stem modification in Nuer</b> Irina Monich & Matthew Baerman	499
27	<b>Negation coding in Ga</b> Yvonne Akwele Amankwaa Ollenu	521
28	<b>On the structure of splitting verbs in Yoruba</b> Alicia Parrish & Cara Feldscher	537
29	<b>Animacy is a presupposition in Swahili</b> Jonathan Pesetsky	555
30	<b>Hausa chat jargon: Semantic extension versus borrowing</b> Tristan Purvis	571
31	<b>Deriving an object dislocation asymmetry in Luganda</b> Rodrigo Ranero	595
32	<b>A case based account of Bantu IAV-focus</b> Naga Selvanathan	623

*Contents*

<b>III Areal features and linguistic reconstruction</b>		
<b>33</b>	<b>When Northern Swahili met southern Somali</b> Derek Nurse	<b>649</b>
<b>34</b>	<b>The syntactic diversity of SAuxOV in West Africa</b> Hannah Sande, Nico Baier & Peter Jenks	<b>667</b>
<b>35</b>	<b>Clicks on the fringes of the Kalahari Basin Area</b> Bonny Sands & Hilde Gunnink	<b>703</b>
<b>36</b>	<b>Central vowels in the Kru language family: Innovation and areal spreading</b> Lynell Marchese Zogbo	<b>725</b>
	<b>Indexes</b>	<b>751</b>



# Preface

This collection contains 36 papers presented at the 47th Annual Conference on African Linguistics at UC Berkeley from March 23-March 26, 2016.<sup>1</sup> This meeting of ACAL coincided with a special workshop entitled “Areal features and linguistic reconstruction in Africa”, and we are glad to include four papers from that workshop in this collection as well. Collectively, these papers add a sizable body of scholarship to the study of African languages, including valuable new descriptions of African languages, novel theoretical analyses of them, and important insights into our typological and historical understanding of these languages. These papers also provide an sample of the depth and richness of contemporary scholarship in linguistics, both in terms of the efficacy of current theories in analyzing language as well as the progress that has been made in describing African languages over the last few decades. Still, much work remains.

Organizing ACAL47 at UC Berkeley was a team effort, and we are grateful to the other members of the organizing committee: Pius Akumbu, Geoff Bacon, Nico Baier, Matthew Faytak, Paula M. Floro, Jevon Heath, Larry Hyman, Maria Khachatryan, Spencer Lamoureux, Florian Lionnet, John Merrill, and Nicholas Rolle. ACAL47 and the preparation of these proceedings also would not have been possible without the generous support of The National Science Foundation (Conference Grant #BCS-1546957), the UC Humanities Research Institute, a UC Berkeley Mellon Project Grant, the Doreen B. Townsend Center for the Humanities, the UC Berkeley Center for African Studies, the UC Berkeley Department of Linguistics, and the Association of Contemporary African Linguistics.

For additional technical assistance, help with the conversion of submissions to  $\LaTeX$ , and help implementing some of the proofreading changes, we are grateful to Steven Ho, Edwin Ko, Frank Lin, and Tessa Scott, along with the timely assistance and guidance of Sebastian Nordhoff and his team at Language Science Press. In addition, each paper in this volume benefited from the comments of reviewers, who we would like to thank for their work: Pius Akumbu, Felix Ameka, Arto

---

<sup>1</sup>There is one exception: the article entitled ‘Negation coding in Ga’ by Yvonne Akwele Amankwaa Ollennu was presented at ACAL44 at Georgetown University but was excluded from that proceedings due to an editorial error.

## *Preface*

Anttila, Nico Baier, Will Bennett, Lee Bickmore, Adams Bodomo, Gene Buckley, Mike Cahill, Emily Clem, Chris Collins, Denis Creissels, Michael Diercks, Mark Dingemans, Laura Downing, Phil Duncan, Chris Ehret, Matthew Faytak, Ines Fiedler, Hannah Gibson, Jeff Good, Christopher Green, Lenore Grenoble, Nadine Grimm, Scott Grimm, Fatima Hamlaoui, Brent Henderson, Ken Hiraiwa, Larry Hyman, Peter Jenks, Patrick Jones, Jason Kandybowicz, Maria Khachaturyan, Wendel Kimper, Sampson Korsah, Ruth Kramer, Connie Kutsch-Lojenga, Andrew Lamont, Michael Marlo, Adam McCollum, John Merrill, Irene Monich, Deo Ngonyani, Tatiana Nikitina, Marjorie Pak, Mary Paster, Doris Payne, Gérard Phillipson, Doug Pulleyblank, Kent Rasmussen, Bert Remijnsen, Nicholas Rolle, Sharon Rose, Hannah Sande, Bonnie Sands, Thera Scott, Elisabeth Selkirk, Naga Selvanathan, Ryan Shosted, Harold Torrence, Mauro Tosco, Jochen Trommer, Jenneke van der Wal, Mark Van de Velde, Valentin Vydrin, John Watters, Malte Zimmermann, and Lynell Zogbo. We are especially grateful to those few reviewers who agreed to review more than one paper.

Last, we would like to especially thank the contributors to this volume based in Ghana and Cameroon who were gracious enough not only to attend our conference at UC Berkeley but also to trust their work to us in these proceedings. Their contributions add a depth of perspective that it may be impossible to capture through fieldwork or any class, and we hope that fruitful collaboration between African and Western scholars continues to grow and develop.

## **Part I**

# **Phonetics and phonology**



## Chapter 1

# A featural analysis of mid and downstepped high tone in Babanki

Pius W. Akumbu

University of Buea, Cameroon

In this study, I examine the occurrence of the surface Mid (M) and downstepped High ( $\downarrow$ H) tone in Babanki, a Central Ring Grassfields Bantu language of Cameroon. Hyman (1979) has demonstrated that Babanki has two underlying tones, namely, High (H) and Low (L), and that on the surface, it contrasts three level tones, H, M, L, plus a downstepped High ( $\downarrow$ H). There is also contrast between a falling (L) and a level low (Lo) tone before pause in the language. I demonstrate in this paper that the M tone is from two different phonological sources and derived by the regressive spread of the high register feature of a following H tone while  $\downarrow$ H is caused by the progressive spread of the low register feature of a preceding floating L tone. The M and  $\downarrow$ H tone are phonetically identical in the language but differ in that  $\downarrow$ H establishes a ceiling for following H tones within the same tonal phrase.

## 1 Introduction

Part of the complexity of tone in Grassfields Bantu (GB) languages of Northwest Cameroon such as Babanki (a Central Ring GB language) is the lack of correspondence between underlying and surface tones as well as the presence of many floating tones. There is no underlying M tone in Babanki, yet it occurs on the surface with the constraint that it must be followed by a H tone. Hyman (1979) has given a historical account of this M tone which is unnecessarily abstract as a synchronic analysis. I demonstrate in this paper that M tone results from the regressive spread of the [+R] feature of high tones which is blocked only by a nasal in NC initial roots. Downstep on its part results from the progressive spread of the [-R] feature of a floating L tone. The synchronic reanalysis of Babanki surface tones in this paper addresses the following issues: 1) What are the underlying



sources of the M tone? 2) How should the M tone be represented, as opposed to the downstepped H? I begin by illustrating in §2 that the lexical tones of Babanki are H and L even though a number of other tonal distinctions are found on the surface. I then proceed to examine the sources of M tone in the language in §3 before turning to discuss how the M tone is derived in §4. In §5, I provide evidence that both M and ↓H are phonetically identical and differ only in that the register is reset to high after M tone but not after ↓H which establishes a ceiling for future H tones within the same tonal phrase.

## 2 Babanki lexical tone

Babanki has two underlying tones, namely H and L, illustrated in (1). As a native speaker, I have provided most of the data but have also taken some from prior literature, particularly Hyman (1979) and a lexical database of 2,005 Babanki entries in Filemaker Pro™.<sup>1</sup>

(1)

ndòŋ	‘potato’	ndónŋ	‘cup’
kà-bwìn	‘witchcraft’	kà-bwín	‘ridge’
à-sè	‘grave’	à-sé	‘profit(n)’
kà-mbò	‘bag’	kà-mbó	‘madness’

On the surface, however, several tonal realizations are possible. As noted by Hyman (1979: 160-161), there is a distinction between falling low (L) and level low (Lo) tones before pause as in (2):

(2)

L		L <sup>o</sup>		
kà-ntò	‘cross (n)’	kà-mbò <sup>o</sup>	‘bag’	/kà-mbò’/
nyàm	‘animal’	dzàm <sup>o</sup>	‘back’	/dzàm’/
tàn	‘five’	wàn <sup>o</sup>	‘child’	/wàn’/
à-sè	‘grave’	dzè <sup>o</sup>	‘kind of fruit’	/dzè’/

The level low tone is considered an effect of a floating high tone that follows the low tone and prevents it from falling. A mid (M) tone also occurs even though with an unusual constraint that it must be followed by a H tone:

<sup>1</sup>The IPA symbols for the following orthographic symbols used in this paper are given in square brackets: ny [ɲ], sh [ʃ], zh [ʒ], gh [gɥ], ch [tʃ], j [dʒ], y [j].

- (3) a. káŋ fāsés<sup>2</sup>  
 káŋ ´ fā-sés  
 fry IMP c19-pepper  
 ‘fry pepper’
- b. kùmá kākí  
 kùm ´ kà-kí  
 touch IMP c7-chair  
 ‘touch a chair’
- c. ghá? kāvú  
 ghá? ´ kà-vú  
 hold IMP c7-hand  
 ‘hold a hand’

The data show that the M tone is derived from a L tone found between two H tones as illustrated in §3.1 and discussed elaborately in §4. Finally, there is a downstepped H tone as in (4):

- (4) a. kà-fó` ↓ká nyàm  
 kà-fó` ká nyàm  
 c7-thing AM c9-animal  
 ‘thing of animal’
- b. kàmbó ↓ká wì?  
 kà-mbó` ká wì?  
 c7-madness AM c1.person  
 ‘madness of person’
- c. kàkáj ↓ká byí shóm  
 kà-káj` ká byí shóm  
 c7-dish AM goat.c10 mine.c10  
 ‘dish of my goats’

The data in (4) illustrate that the H tone of the associative marker (AM) is produced at a lower level than that of the preceding noun root because of the intervening floating L tone. This is discussed further and formalized in §5. The presence of both M and ↓H in the same language is of interest for two reasons. First, Babanki is unique in that Grassfields Bantu Ring languages are typically said to have either M or ↓H. As Hyman puts it:

<sup>2</sup>There is a change in the root vowel because in Babanki, /e/ and /o/ are realized as [ɛ] and [ɔ] respectively in closed syllables (Mutaka & Chie 2006: 75).

For example, it is known that the western Ring languages and Babanki (of the central Ring group) have similar downstep systems. The remaining languages of the central group (Kom, Bum, Bafmeng, Oku, Mbizinaku) all have systems with M tone instead of ↓H, a system which Grebe & Grebe (1975) have also documented for Lamnsoq of the eastern group (Hyman 1979: 176-177).

Second, although phonologically distinct, the M and ↓H tones are phonetically identical, as I shall show below, which is of particular interest to the study of tone in general. It is therefore necessary to examine how the M tone is derived and how it should be formally represented.

It is important to note that contour tones are rare in the language, allowed mainly in a few borrowed words. In the lexical database of 2,005 Babanki entries in Filemaker Pro™, only eight monosyllabic nouns with low-Rising (LH) and four with high-falling (HL) tones were found.<sup>3</sup>

### 3 Sources of Babanki M tone

The M tone is derived in Babanki from L via two separate processes which I will refer to as prefix L-Raising and stem L-Raising.

#### 3.1 Prefix L-Raising: H # L-H → H # M-H

The L tone of a prefix is raised to M if it appears between two H tones as in the following examples.

- (5) a. tətóʔ tətáʔ  
       tə-tóʔ   tə-táʔ  
       c13-bush c13-three  
       ‘three bushes’
- b. kəkím kə vətsoŋ  
       kə-kím kə vətsoŋ  
       c7-crab AM c2-thief  
       ‘crab of thieves’

---

<sup>3</sup>LH: *əŋkəpəm* ‘pig’, *bələŋ* ‘groundnut’, *fəndzəndzə* ‘type of bird’, *kəŋgü* ‘fool (n)’, *mbwí* ‘nail’, *ŋgü* ‘rake (n)’, *sə* ‘saw (n)’, *tələm* ‘cobra’.

HL: *bibi* ‘deaf’, *bəbó* ‘Lord’, *byə* ‘pear’, *lám* ‘lamp’, *kí* ‘key’, *chôs* ‘church’, *wás* ‘watch’.

The presence of words like *sə* ‘saw (n)’, *lám* ‘lamp’, etc. suggests that many of the Babanki words with contour tones are borrowings.



- c. tətʔ təbò  
 tət-tʔ tət-bò  
 c13-bush c13-two  
 ‘two bushes’
- d. kəkím ká vələmè  
 kət-kím ká vət-ləmè  
 c7-crab AM c2-sibling  
 ‘crab of siblings’

Raising applies in (5a) where the L is flanked by Hs but not in (5b) where it is followed by a L tone. I return to the issue in §4 to provide a featural analysis of the raising.

### 3.2 Stem L-Raising: L-L # H → L-M # H

In Babanki, the L tone of certain noun roots that also have a L prefix is realized as M if it is followed by a H tone. The following sets of data show stem L-Raising when the noun is in N1 position in an associative N1 of N2 construction (6a), when the noun is followed by a modifier (6b), and in verb phrases (6c). Forms without raising (i.e. with surface L tone) are given in (6d):

- (6) a. kəkəs ká wìʔ  
 kət-kòs ká wìʔ  
 c7-slave AM c1.person  
 ‘slave of person’
- b. fəkʔ fə nyàm  
 fət-kòʔ fə nyàm  
 c19-wood AM c9.animal  
 ‘wood of person’
- c. fəsò fə↓wén  
 fət-sò fə wén  
 c19-abscess AM him  
 ‘his abscess’
- d. kəkyē lá kəmùʔ  
 kət-kyè lá kət-mùʔ  
 c7-basket just c7-one  
 ‘just one basket’

- e. wyé kàzhwī tsú  
 wyé kà-zhwì tsú  
 put c7-air there  
 ‘inflate it’
- f. kú kàlāŋ lúwèn  
 kú kà-lāŋ lúwèn  
 give c7-cocoyam now  
 ‘give cocoyam now’
- g. nyàm à wì?  
 nyàm à wì?  
 c9.animal AM c1.person  
 ‘animal of person’
- h. kàkòs kà mù?  
 kà-kòs kà-mù?  
 c7-slave c7-one  
 ‘one slave’
- i. áshù kàlāŋ nè mú↓ú  
 á-shù kà-lāŋ nè múú  
 INF-wash c7-cocoyam PREP c6a.water  
 ‘to wash cocoyam with water’

To account for the raising in (6a-c), Hyman (1979: 168) offers a synchronic analysis which mirrors the historical developments, as in (7):

(7) kákòs ká → kákòs ká → kàkòs ká → kàkòs ká ...

As seen, the prefix originally had a H tone which spreads onto the L tone stem.<sup>4</sup> After spreading, the prefix H changes to L and then the resulting L-HL # H sequence becomes L-M # H by contour simplification. While this historical account derives the correct output, it appears to be unnecessarily abstract as a synchronic analysis. Instead, the H tone on the prefix can rather be analyzed as L (Akumbu 2011) and the change from L to M can be accounted for as a raising rule (see §4). There is, however, a complication that either analysis must deal with: L-L nouns that have a nasal as part of the root initial NC do not become L-M before H as illustrated in (8):

<sup>4</sup>Hyman’s pre-autosegmental analysis also posits a floating L after the L stem, i.e., /-kòs/ ‘slave’. This is ignored here because it is unnecessary and also an OCP violation.

- (8) a. kə̀ndò̀ŋ ká nyàm  
kə̀-ndò̀ŋ ká nyàm  
c7-neck AM c9.animal  
'neck of animal'
- b. tà̀ŋkà̀ŋ t́ ká kə̀?  
tà̀-ŋkà̀ŋ t́ ká kə̀?  
c13-comb AM c1.rooster  
'combs of rooster'
- c. fə̀ŋgə̀m f́ wí?  
fə̀-ŋgə̀m f́ wí?  
c19-gong AM c1.person  
'gong of person'

To account for this, Hyman (1979: 167) distinguished two classes of nouns based on whether the stem syllable has an oral (O) or nasal (N) onset and observed that “a noun in the O class changes from L-L to L-M when in the N1 position before a H tone associative marker. A noun in the N class ...remains L-L.” He illustrates that L-Raising is blocked when the N1 is from a nasal class and posits that “in N1 position, N L-L nouns and L-Lo nouns have an underlying L prefix, rather than the underlying H proposed for other noun prefixes” (Hyman 1979: 169). Since HTS does not occur, there is no L-HL # H sequence to become L-M # H. While that analysis is historically plausible, we can again propose a more concrete analysis by which L-Raising is simply blocked when a L tone root has an NC onset. As argued in Akumbu (2011: 9), there is a L tone linked to the N in NC sequences that blocks the raising. This is because in these cases, the nasal forms part of the root and bears the same L like the root vowel because of the OCP (Snider 1999) that is enforced morpheme-internally in Babanki. The multiple linking of the L (to the nasal and root vowel) violates the condition for raising, namely, that the tone that precedes the target L must be singly-linked (Akumbu 2011: 6). L-Raising will automatically not apply to L-L<sup>°</sup> nouns since they have a floating H after them that prevents raising from occurring. The fact that the roots in (8) all end with a nasal could be relevant in providing a possibility of tying the failure of L-Raising to apply to some phonetic motivation. A possibility might be that the extra nasal, an extra mora, gives the L tone more of a chance to manifest itself. If so, then we might expect the same if the stem has a long vowel (another manifestation of an extra mora). Unfortunately, Babanki does not have long vowels and two other problems exist: there are stems, e.g. fə̀ŋgù? f́ wí? ‘small stone of person’, without final nasal that do not also become M, as well as stems with final nasal, e.g. kə̀būm

*ká wì?* ‘mucus of person’, that do in fact become M. So far, the two sources of M tone have been presented: prefix L becomes M between Hs and stem L becomes M when preceded by a L prefix and followed by a H. It should be noted that this occurs over a word boundary although it is still unclear what the influence of the boundary is. In addition, there is another context in which a stem L becomes M. This arises when a coda consonant is deleted intervocalically (see Akumbu 2016 and references cited therein for more information on coda deletion in Babanki). As seen in (9), when the CVC stem is H and the following prefix vowel is L, the H+L sequence resulting from coda deletion is realized M:

- (9) a. *kàbā: kóm*  
      *kà-bán      à-kóm*  
      *c7-corn.fufu c7-my*  
      ‘my corn fufu’
- b. *kàŋkō: kóm*  
      *kà-ŋkón à-kóm*  
      *c7-fool c7-my*  
      ‘my fool’
- c. *kàbā: kóm*  
      *kà-báŋ      à-kóm*  
      *c7-home c7-my*  
      ‘my home’

I propose to account for this by invoking the prefix raising rule. Thus, in (9a) for example, the input /*kà-bán à-kóm*/ first undergoes prefix L-Raising to become *kà-bán ā-kóm*. Next, the coda consonant (alveolar or velar nasal) is deleted in intervocalic position, creating the structure *kà-bá ā-kóm*. This is followed by vowel (schwa) deletion which allows its M tone to float: *kà-bá<sup>-</sup>-kó*. The floating M tone docks leftwards and causes the deletion of the H tone, since HM contour tones are not permitted in the language. The vowel that causes vowel deletion then undergoes compensatory lengthening, resulting to the surface structure [*kàbā: kóm*].

#### 4 Featural analysis of Babanki M tone

In this section I show that the M tone can be insightfully accounted for using tonal features which spread. Various proposals for the use of features in the representation and analysis of tone have been addressed by Yip (1980), Clements

(1983), Pulleyblank (1986), Odden (1995), Snider (1999), Hyman (2011) and others. Following the tone features introduced by Yip (1980) and modified by Pulleyblank (1986), I assume the feature system in (10) for the two underlying Babanki tones:

(10)

	H	L
Upper	+	-
Raised	+	-

I propose that Babanki M tone be represented as [-U, +R] which can be derived directly from the leftwards spreading of the [+R] feature of a H tone to a preceding L tone, whose [-R] feature automatically delinks. I formulate the process in (11) where I link features directly to the TBUs even though there are arguments in the literature to link features to tonal nodes, e.g. Yip (1989) and Hyman (2011). This implies that linking features directly to TBUs is merely for expository convenience.

(11) Leftwards [+R] spread

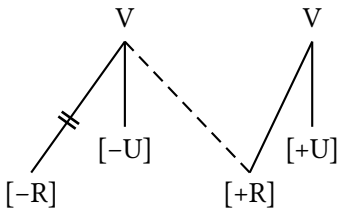

It should be recalled that there are two different morphological restrictions on the application of this rule: the L tone that is raised must either be that of a prefix found between two H tones (§3.1) or of a stem preceded by a prefix L tone and followed by a H tone (§3.2). The first is an instance of register plateau where [-R] becomes [+R] between [+R] specifications. In both cases, the application of the rule results in a M tone with the features [-U, +R], as illustrated in the following derivations:

(12)

UR		Leftwards [+R] spread	PR
tə- tóʔ tə- tsén		tə- tóʔ tə- tsén	[tətóʔ tətсэн]
	→	†	
[-R] [+R] [-R] [+R]		[-R] [+R] [-R] [+R]	

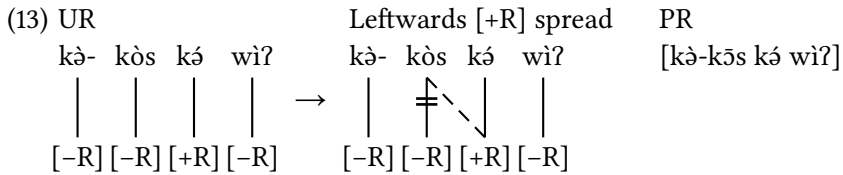

To summarize this section, the resulting feature system of Babanki is as follows:

(14)

	H	M	L
Upper	+	-	-
Raised	+	+	-

The use of features allows for a unified account of the Babanki derived M tone using one tone rule (albeit with constraints) thereby avoiding Hyman’s abstract intermediate contour tones which are not realized on the surface. In the next section, I address the analysis of the ↓H downstep tone.

## 5 Babanki downstepped high tone

While the different sources of the M tone have been discussed above and its realization shown, nothing has been said about the ↓H tone which, like M is also a derived tone in the language. Downstep is commonly used to describe successive lowering of H tones in an utterance. The two kinds of downstep commonly mentioned in the literature are non-automatic downstep, phonologically conditioned by a floating L tone (Clements & Ford 1979; Pulleyblank 1986) or by one that had been lost historically, and automatic downstep, caused by an associated low tone (Stewart 1965; Odden 1982; Snider 1999; Connell 2014). Downstep has been described as a downward shift in register (e.g. Snider 1990; Snider & van der Hulst 1993; Snider 1999; Connell 2014). Automatic downstep occurs in Babanki but the focus in this study is on non-automatic downstep which has been noted in the Babanki nominal system (Hyman 1979; Akumbu 2011) as well as in the verb system (Akumbu 2015). As seen in the following data, the floating low tone that causes downstep in Babanki may be underlying:

(15)

a.	á`-sé	→	á↓sé	‘to sharpen’
	á`-sám	→	á↓sám	‘to migrate’
b.	á`-bùm	→	ábùm	‘to meet’
	á`-sìm	→	ásìm	‘to tighten’

As shown in (15a), a H verb stem is realized as a downstepped H after the infinitive prefix. Downstep can be accounted for by assuming that the H tone schwa of the infinitive prefix is followed by a floating L. The presence of this floating L tone is justified by the fact that the H tone of the verb root is realized on a lower register than the preceding H tone. When the H tone prefix is followed by a L tone verb, the verb tone does not change (15b). These data are analyzed as involving ↓H as opposed to the previous cases analyzed as involving M specifically because it is shown, subsequently (see Figure 1), that ↓H sets a new ceiling for subsequent Hs producing a terracing effect as opposed to M which results from the local raising of L and is obligatorily followed by H.

In the noun system, certain H tone stems have a following floating L tone in their underlying representation. Evidence has been presented that in Babanki, “class 7 nouns fall into three subclasses, A, B, C [corresponding to (16a, b, c)] which behave differently in context” (Hyman 1979: 163-164).<sup>5</sup> Hyman illustrates the distinction between the three using noun-plus-noun (N1 of N2) associative constructions (AM). When H tone roots are in N1 position and are followed by the H tone of the AM, the latter is lowered to ↓H after A and B, but not C. Secondly, when in N2 position after a L toned AM, A and C become L-Lo, while B remains L-H. Finally, when in N2 position after the H toned AM, A becomes H-Lo, while B and C become H-↓H.

As said above, A and B cause the following H tone of the AM to be realized at a lower level than the preceding root H tone (16a,b):

- (16) a. kə̀fó ↓kə̀ wì?  
           kə̀-fó` kə̀ wì?  
           c7-thing AM c1.person  
           ‘thing of person’
- b. kəkáj ↓kə̀ ndòŋ  
           kə̀-káj` kə̀ ndòŋ  
           c7-tin AM c1.potato  
           ‘tin of potato’
- c. kə̀fú ↓kə̀ wì?  
           kə̀-fú` kə̀ wì?  
           c7-medicine AM c1.person  
           ‘medicine of person’

---

<sup>5</sup>The historical origins of the different classes adopted synchronically by Hyman (1979) were: A = \*LH, B = \*HL, C = \*HH.

- d. kàtyí ↓kə nyàm  
 kà-tyí' kə nyàm  
 c7-stick AM c9.animal  
 'stick of animal'
- e. kàkím kə kə↓kú  
 kà-kím kə kə-kú  
 c7-crab AM c7-gift  
 'crab of gift'
- f. kàshí kə kə↓təŋ  
 kà-shí kə kə-təŋ  
 c7-place AM c7-belt  
 'place of belt'

Downstep of the AM H tone is best explained by the presence of a floating L tone on N1 noun roots. Hyman's class C nouns (16c) do not cause downstep of the following H tone of the associative marker because they do not have a floating tone in their underlying representation. The forms in (16c) further show that the H tone of the AM spreads rightwards and delinks the L tone of the prefix of N2 nouns. It is this floating L tone that causes downstep of the H tone of N2 noun roots. Its [-R] feature spreads rightwards and delinks the [+R] feature of the following H tone as follows:

(17) Rightwards [-R] spread (Downstep)

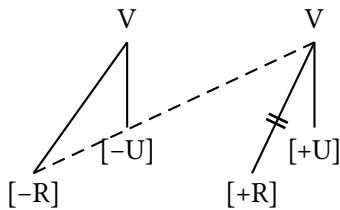

The application of this rule yields a ↓H tone with the features [+U, -R], as illustrated in the following derivations:

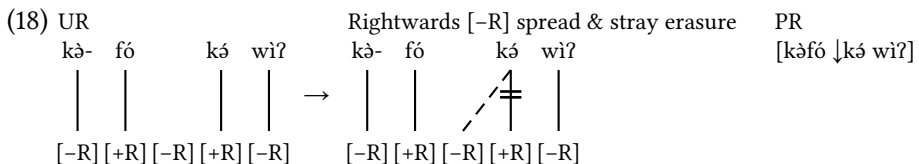



1 A featural analysis of mid and downstepped high tone in Babanki

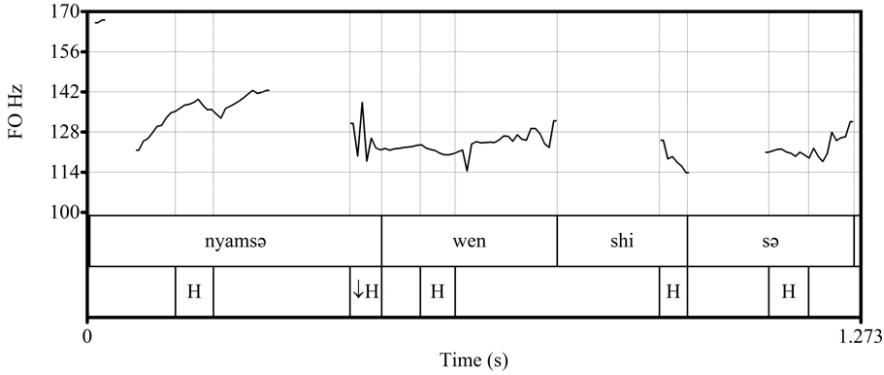
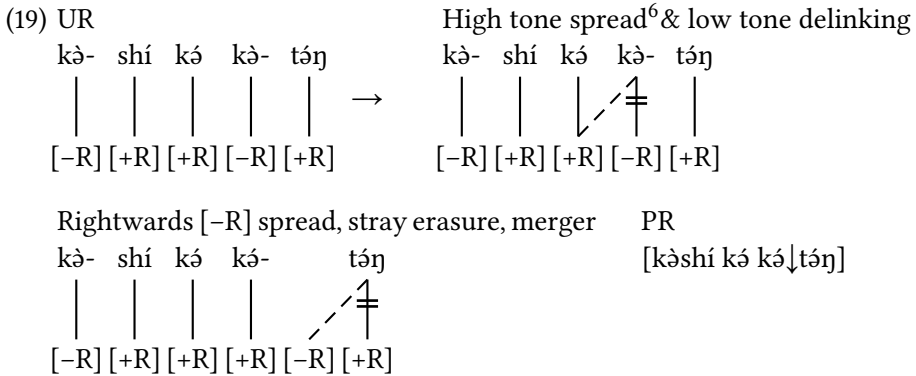

Figure 1: Downstep



Each [+U, -R], i.e., ↓H, sets a new ceiling for subsequent Hs such that H tones after the one downstepped in the same tonal phrase do not rise above it as seen in (20), where italics have been used to indicate downstep of all Hs following H:

- (20) kàkàŋ ↓ká byí shóm            ‘dish of my goats’  
 nyám ↓sá wén shí sá            ‘those animals of his’

The pitch traces in Figure 1 show lower F0 values (120Hz-125Hz) for all the H tones after ↓H compared to the F0 value of the H tone before ↓H which is

<sup>6</sup>I have shown only the spread of [+R] here but it must be said that it is the entire tone root node that spreads both [+U,+R] and delinks [-U,-R] of the L tone.

approximately 138Hz (In this and subsequent Figures, vowels are demarcated by vertical lines and marked by tone labels (L, H, M, ↓H) on the second tier.)<sup>7</sup>

We are now in a position to complete the tonal feature matrix to accommodate the downstepped high tone.<sup>8</sup>

(21)		H	↓H	M	L
	Upper	+	+	-	-
	Raised	+	-	+	-

An issue this raises is whether the M tone [-U, +R] and the ↓H tone [+U, -R] are phonetically distinguishable from one another. Hyman (1979: 162) has observed that “...the sequence H-M is identical, phonetically, to the sequence H-↓H.” He further states that “the two are distinguishable, however, since ↓H establishes a ceiling for future H tones within the same tonal phrase, while M does not.” The two tones therefore differ only in that they come from separate sources as well as on the effect they have on subsequent H tones. The pitchtracks in Figure 2 show that M and ↓H are not phonetically distinguishable.

In both phrases, the F0 of vowels with M and ↓H tones are around 120 Hz while the intervening H tone has an F0 of about 135 Hz, confirming that M and ↓H are phonetically very similar, particularly if all other factors surrounding the utterance are the same. It is not likely that the two tones are discriminable if they typically exhibit this small F0 difference. The phonetic sameness of Mid and downstepped H is not unique to Babanki as it has been reported in other languages e.g. Bimoba (Snider 1998).

Figure 3 and Figure 4 show that the phonetic pitch levels of H tones differ slightly depending on whether the preceding tone is M or ↓H. These pitchtracks show that a M tone may be followed by a H tone whereas the H tones following ↓H, are pronounced at the same level as the ↓H. Figure 3 shows that the F0 of vowels with H tone is about 126 Hz, slightly higher than the F0 of vowels with ↓H in Figure 4 which is about 120 Hz.

---

<sup>7</sup>The pitch traces used in this paper were obtained from recordings of the author’s speech at the Phonology Laboratory at UC Berkeley and analyzed in Praat (Boersma & Weenink 2016).

<sup>8</sup>The matrix is said to be complete because although Babanki has two contrastive underlying tone heights but five in derived forms, I do not treat the fifth - the prepausal level low tone as separate phonological tone features because I analyze it as the late phonetic effect of a floating high tone that follows the low tone and prevents it from falling.

1 A featural analysis of mid and downstepped high tone in Babanki

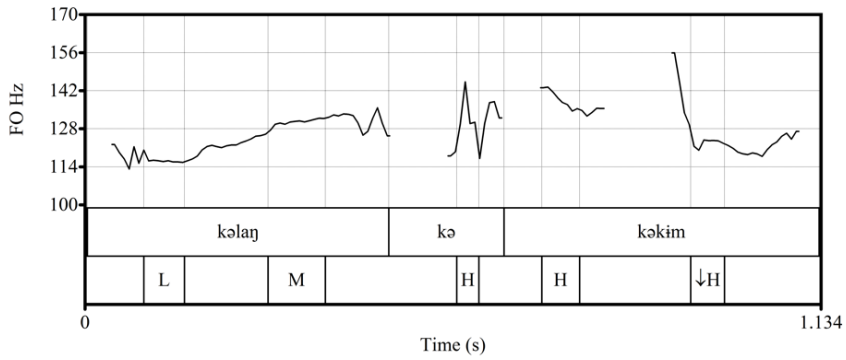
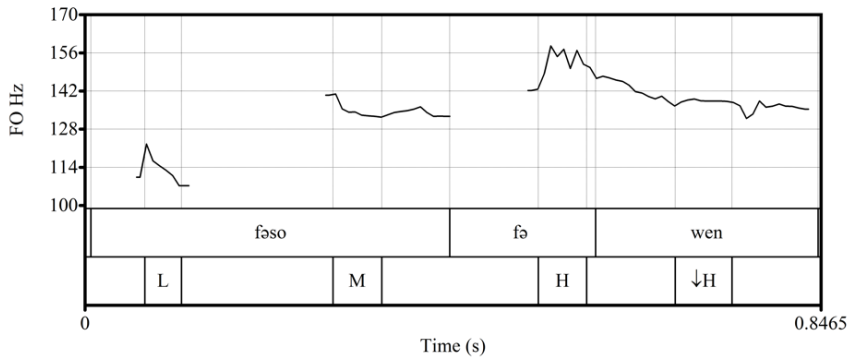

Figure 2: Comparison between M and ↓H

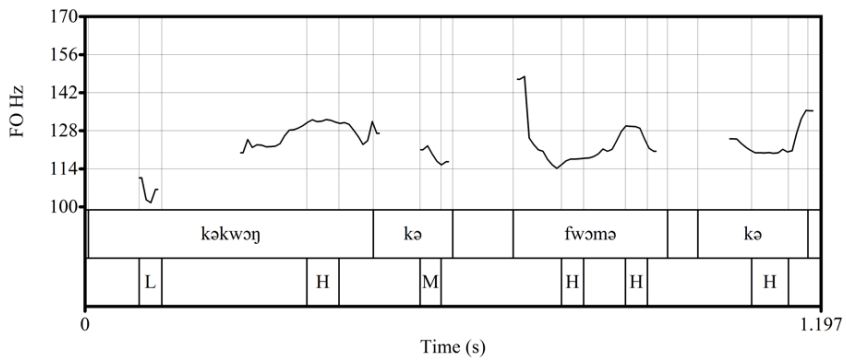

Figure 3: Comparison of H tone following M

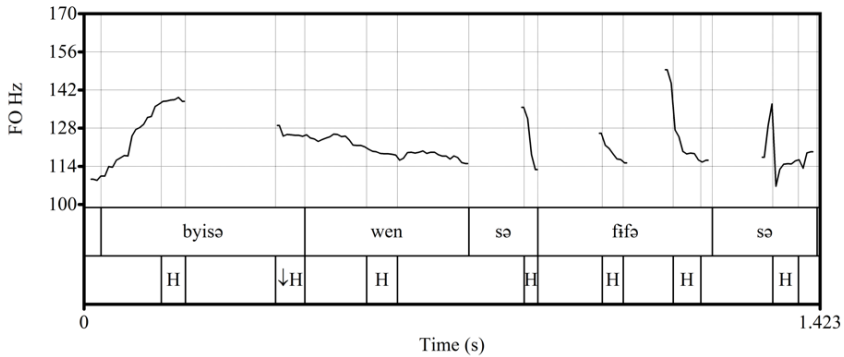

Figure 4: Comparison of H tone following ↓H

## 6 Conclusion

Although there is no underlying M tone in Babanki, it appears on the surface when a prefix or stem L tone is raised in two separate conditions: prefix L-Raising takes place if it is found between two H tones while stem-Raising takes place if preceded by a L prefix and followed by a H tone. I have given a synchronic account of the processes that derive the M tone, arguing that it results from the regressive spreading of the [+R] feature of high tones which is blocked only by a nasal in NC initial roots. Downstep on its part results from the progressive spread of [-R] feature of a floating L tone. Simple acoustic analyses have confirmed that both M and ↓H are realized with similar F0 levels.

It was stated above that the other Central Ring languages such as Kom have a much more general M tone (see Hyman 2005), while Western Grassfields Bantu languages instead have a downstepped ↓H. Babanki is unusual in having both M and ↓H. However, whereas the source of the M in other Central Ring languages is from an underlying /H/ that is lowered after a L, we have seen that Babanki creates output Ms from underlying /L/. Although Hyman's (1979: 166-168) account is unnecessarily abstract as a synchronic analysis, it clearly shows that M tone originates to avoid tonal ups and downs (Hyman 2010: 15). In particular, it is meant to avoid tonal contours surrounded by the opposite tone. As we have seen, unlike most other Ring languages, Babanki has rid itself of nearly all contours, but has developed a M tone level that is phonetically identical to ↓H, but phonologically distinct.

## Acknowledgements

I worked on this paper while at the University of California, Berkeley as a Fulbright research scholar (Sept. 2015-May 2016) and I would like to express profound gratitude to Larry Hyman for discussing the data extensively with me, reading the drafts and making very critical and thought-provoking comments. I also wish to thank Mike Cahill, Robert Hedinger and the audience at ACAL47 for their stimulating feedback.

## Abbreviations

AM	associative (possessive) marker	INF	infinitive
c1-19	class Marker	n	noun
IMP	imperative	PREP	preposition

## References

- Akumbu, Pius W. 2011. Tone in Kejom (Babanki) associative constructions. *Journal of West African Languages* 38(1). 69–88.
- Akumbu, Pius W. 2015. Babanki verb tone. *Studies in African Linguistics* 44(1). 1–26.
- Akumbu, Pius W. 2016. Babanki coda consonant deletion and vowel raising: A case of allomorphy. In Emily Clem, Virginia Dawson, Alice Shen, Amalia Horan Skilton, Geoff Bacon, Andrew Cheng & Erik Hans Maier (eds.), *Proceedings of the 42nd Annual Meeting of the Berkeley Linguistics Society*, 3–20. Berkeley, CA: Berkeley Linguistics Society.
- Boersma, Paul & David Weenink. 2016. *Praat: Doing phonetics by computer*. Amsterdam: University of Amsterdam. Version 6.0.14.
- Clements, George N. 1983. The hierarchical representation of tone features. In Ivan R. Dihoff (ed.), *Current approaches to African linguistics*, vol. 1, 1–17. Dordrecht: Foris Publications.
- Clements, George N. & Kevin C. Ford. 1979. Kikuyu tone shift and its synchronic consequences. *Linguistic Inquiry* 10. 179–210.
- Connell, Bruce. 2014. *Downdrift, downstep, and declination*. Paper presented at the Typology of African Prosodic Systems Workshop. Bielefeld University, Germany, May 18-20, 2001.
- Grebe, Karl & Winnifred Grebe. 1975. Verb tone patterns in Lamnsok. *Linguistics* 149. 5–23.

- Hyman, Larry M. 1979. Tonology of the Babanki noun. *Studies in African Linguistics* 10. 159–178.
- Hyman, Larry M. 2005. Initial vowel and prefix tone in Kom: Related to the Bantu augment? In Koen Bostoen & Jacky Maniacky (eds.), *Studies in African comparative linguistics with special focus on Bantu and Mande: Essays in honour of Y. Bastin and C. Grégoire*, 313–341. Köln: Rüdiger Köppe Verlag.
- Hyman, Larry M. 2010. *Do tones have features?* (Paper presented at Tones and Features: A Symposium in Honor of G. Nick Clements, Paris, June 18-19, 2009).
- Hyman, Larry M. 2011. The representation of tone. In Marc van Oostendorp, Colin Y. Ewen, Elizabeth Hume & Keren Rice (eds.), *The Blackwell companion to phonology*, vol. II, 1078–1102. Malden, MA: Wiley-Blackwell.
- Mutaka, Ngessimo M. & Esther P. Chie. 2006. Vowel raising in Babanki. *Journal of West African Languages* 33(1). 71–88.
- Odden, David. 1982. Tonal phenomena in KiShambaa. *Studies in African Linguistics* 13(2). 177–208.
- Odden, David. 1995. Tone: African languages. In John A. Goldsmith (ed.), *The handbook of phonological theory*, 444–475. Cambridge: Blackwell.
- Pulleyblank, Douglas. 1986. *Tone in lexical phonology*. Dordrecht: D. Reidel.
- Snider, Keith. 1990. Tonal upstep in Krachi: Evidence for a register tier. *Language* 66. 453–74.
- Snider, Keith. 1998. Phonetic realisation of downstep in Bimoba. *Phonology* 15(1). 77–101.
- Snider, Keith. 1999. *The geometry and features of tone*. Dallas: The Summer Institute of Linguistics & The University of Texas at Arlington.
- Snider, Keith & Harry van der Hulst. 1993. Issues in the representation of tonal register. In Harry van der Hulst & Keith Snider (eds.), *The phonology of tone: The representation of tonal register*, 1–27. Berlin: Mouton de Gruyter.
- Stewart, John M. 1965. The typology of the Twi tone system. *Bulletin of the Institute of African Studies, Legon* 1. 1–27.
- Yip, Moira. 1980. *The tonal phonology of Chinese*. Massachusetts Institute of Technology. (Doctoral dissertation).
- Yip, Moira. 1989. Contour tones. *Phonology* 6. 149–174.

## Chapter 2

# Metrically conditioned vowel length in Dagaare

Arto Anttila

Stanford University

Adams Bodomo

University of Vienna

There is little evidence for stress in Dagaare, but vowel length alternations in nominal and verbal morphology reveal the presence of a word-initial metrical foot. New evidence for the foot hypothesis comes from action nominals formed with the suffix /-UU/: if the root is CV, the root lengthens and the suffix shortens; if the root is CVV the suffix shortens; if the root ends in C nothing happens. Similar length alternations appear more idiosyncratically with number and aspect suffixes. A metrical analysis provides a simple account of these vowel length alternations.

## 1 Introduction

Dagaare (Gur, Mabia; Naden 1989, Bodomo 1997) is a two-tone language of north-western Ghana.<sup>1</sup> There is little direct evidence for metrical stress, but vowel alternations in nominal and verbal morphology suggest the presence of a word-initial metrical foot (Anttila & Bodomo 2009). New evidence for the foot hypothesis comes from vowel length alternations in action nominals, the topic of the present paper.

---

<sup>1</sup>The data represent the Jirapa district dialect of which the second author is a native speaker. Most of the data are previously unpublished; some can be found in (Kennedy 1966; Bodomo 1997; Anttila & Bodomo 2009), which are referred to in the text. The examples are given in Bodomo's (1997: 37) orthography. The digraphs <ky>, <gy>, <ny> stand for IPA [tʃ], [dʒ], [ɲ], respectively.



Kennedy (1966: 9) gives the vowel inventory for Dagaare word-medial syllables shown in Table 1.

Table 1: Dagaare vowels (Kennedy 1966)

	-round		+round	
	+ATR	-ATR	+ATR	-ATR
+high, -low	i, ii	ɪ, ɪɪ	u, uu	ʊ, ʊʊ
-high, -low	e, ie	ɛ, ɛɛ	o, uo	ɔ, ɔɔ
-high, +low		a, aa		

Vowel length is contrastive in Dagaare. High and low vowels can be short or long, but there is a striking gap in Kennedy’s inventory: long mid vowels are missing. Kennedy (1966: 8) notes that word-medially “there are high and low long vowels, but no mid long vowels” and suggests that in terms of the phonological system the diphthongs [ie], [ɛɛ], [uo], [ɔɔ] are in fact the missing long vowels /ee/, /εε/, /oo/, /ɔɔ/. This is an attractive interpretation because it makes the long vowel pattern symmetrical.

The problem is that long mid vowels do exist on the surface. There are even near-minimal pairs that demonstrate a phonemic contrast between a long mid vowel and the corresponding diphthong: *bée* ‘or’ vs. *bíé* ‘child.sg’, *gḡḡ* ‘left’ vs. *gúḡ* ‘thorn.sg’. Examples of long mid vowels are shown in Table 2. /E/ stands for a [-high, -low, -round] vowel and /I/ for a [+high, -low, -round] vowel, both underspecified for  $\pm$ ATR; /V/ stands for a [-high] vowel underspecified for [ $\pm$ back], [ $\pm$ round], and [ $\pm$ ATR].<sup>2</sup>

However, Kennedy’s insight is nevertheless well founded: long mid vowels are phonologically special. The long mid vowels in Table 2 are either underlying or result from the concatenation of two underlying short mid vowels; phonologically derived long mid vowels are systematically missing. In particular, the process of vowel lengthening stops short of creating long mid vowels as shown in Table 3.

<sup>2</sup>Tone does not figure into the vowel length alternations, but a brief note is warranted. Underlyingly there is a three-way contrast between H, L, and toneless; on the surface there is a three-way contrast H, ‘H, and L. Toneless morphemes surface as H or L depending on the context. We mark downstep as a raised exclamation point before a H toned syllable. Downstep seems analyzable as a floating L and contour tones as combinations of H and L. The underlying tone marking reflects our work in progress. For more details, see Kennedy (1966: 42-49) and Anttila & Bodomo (2000).



2 Metrically conditioned vowel length in Dagaare

Table 2: Long mid vowels

Underlying	Surface		Underlying	Surface	
/béé/	béé	‘or’	/bóò/	bóò	‘which’
/pɔg-léé/	pògléé	‘woman-DIM’	/tòò-rí/	tòòrí	‘ear-SG’
/gbé-É/	gbéè	‘leg-PL’	/dɔɔ-’/	dóó	‘man-SG’
/bar-ÈÉ/	bàrèé	‘leave-PERF’	/ɔɔ-rV /	òòró	‘chew-IMPF’
/téésì /	téésì	‘test.SG’	/lós-rí/	lósòrí	‘lorry-SG’

Table 3: Vowel lengthening in suffixed nouns

	Root	Suffixed form	N + A Compound
(a)	/bi-/	bíí-rí ‘child-PL’	bì-fáá ‘bad child’
	/pì-/	pìì-rí ‘rock-SG’	pì -fáá ‘bad rock’
	/kù-/	kùù-rí ‘hoe-SG’	kù-fáá ‘bad hoe’
	/gó-/	góó-rì ‘thorn-PL’	gó-’fáá ‘bad thorn’
(b)	/pò-/	pùò-rí ‘back-SG’	pò-fáá ‘bad back’
	/nó-/	nóó-rì ‘mouth-SG’	nó-’fáá ‘bad mouth’
	/dò-/	dò-rí ‘pig-PL’	dò-fáá ‘bad pig’
	/dè-/	dè-rí ‘room-PL’	dè-fáá ‘bad room’
	/lè-/	lè-rí ‘bead-SG’	lè-fáá ‘bad bead’
	/gbé-/	gbé-rì ‘leg-SG’	gbé-’fáá ‘bad leg’

Table 3 shows that the number suffix /-rí/ triggers vowel lengthening in high vowel stems, but not in mid-vowel stems where the result is either a diphthong or the vowel simply fails to lengthen, depending on the lexical item. The noun-adjective compound is given as a diagnostic for the underlying form of the noun: the nouns in Table 3 all have a short stem vowel. In contrast, the long mid vowel in *dóó* ‘man.SG’ given in Table 2 is underlying: *dòò-fáá* ‘bad man’. Lengthening is lexically conditioned even in high vowel stems: there are words like *bí-rì* ‘seed-SG’ and *yí-rì* ‘house-SG’ where lengthening does not happen. Finally, the data illustrate a characteristic aspect of Dagaare number morphology: /-rí/ may mean either singular or plural depending on the stem, an instance of “polarity morphology” that has attracted the attention of semanticists (Grimm 2012).

Vowel lengthening also occurs in singular forms with no overt suffix. Anttila & Bodomo (2009) propose that in such cases the root vowel lengthens in order to satisfy a bimoraic foot template.

Table 4: Vowel lengthening in unsuffixed nouns

Root	Suffixed form	N + A Compound
(a) /bi-/	bíé ‘child.sg’	bi-fáá ‘bad child’
/gó-/	góò ‘thorn.sg’	gó- <sup>1</sup> fáá ‘bad thorn’
(b) /dè-/	dié ‘room.sg’	dè-fáá ‘bad room’
/dò-/	dùó ‘pig.sg’	dò-fáá ‘bad pig’

Here is the reasoning: the singular form is a phonological word; therefore it must contain at least one foot; therefore it must be minimally bimoraic (McCarthy & Prince 1996). In Dagaare this generalization holds for almost all nouns.<sup>3</sup> In contrast, function words, weak forms of pronouns, and citation forms of verbs can be monomoraic. The question is why the vowel does not simply lengthen, yielding \*bíí, \*góò, \*dèé, and \*dòó. Anttila & Bodomo (2009) propose that this is due to two constraints: \*bíí and \*góò are blocked by a constraint against word-final high vowels; \*dèé, and \*dòó are blocked by a constraint against long mid vowels. Crucially, both constraints only apply in phonologically derived environments. The optimal outcome is a rising diphthong: *bíé*, *góò*, *dié*, and *dùó*.

In sum, we have seen that all the nine vowels of Dagaare can be underlyingly either short or long (Kennedy 1966). There are also underlying diphthongs, such as *tìè* ‘shoot’, *pùòrì* ‘thank’, *yíèlì* ‘sing’, *lòó-áá* ‘lion-sg’. However, long mid vowels [ee], [εε], [oo], [ɔɔ] are special in that they cannot be the result of lengthening.

This system of vowel length may seem complicated and one can reasonably question whether it has anything to do with foot structure. We will now provide new evidence suggesting that it indeed does. We first show that verbs exhibit parallel length alternations, complete with parallel exceptions. Particularly interesting is the action nominal paradigm where the length alternations are entirely regular and the foot template triggers both vowel lengthening and vowel shortening.

<sup>3</sup>We are aware of four monomoraic (CV) nouns: *bâ* ‘father.sg’, *mă* ‘mother.sg’, *nú* ‘hand.sg’, *zú* ‘head.sg’.

## 2 Length alternations in verbs

The key alternations in the verbal paradigm are illustrated in Table 5.

Table 5: Vowel length alternations in Dagaare verbs

	Root	Cit. form	Imperf.	Nominal	
(a)	/ba-/	bà	bàà-rá	báá-ó	‘stick into the ground’
	/baa-/	bàà	bàà-rá	báá-ó	‘grow (of child)’
(b)	/bar-/	bàrì	bà-rá	bár-óó	‘leave’
	/bàrr-/	bàrrì	bár- <sup>!</sup> rà	bár <sup>!</sup> r-óó	‘bargain’
	/bààr-/	bààrì	báá- <sup>!</sup> rà	báá <sup>!</sup> r-óó	‘finish’

The root and the citation form are identical except that consonant-final roots acquire a final epenthetic vowel in the citation form, either /i/ or /ɪ/ depending on ATR-harmony. This is because a Dagaare word must end in a vowel or in the velar nasal [ŋ]; in the latter case vowel epenthesis seems optional.<sup>4</sup> The imperfective suffix /-rV̄/ copies its vowel quality from the root. Our main focus is on the action nominals where both roots and suffixes alternate. We assume that the underlying form of the suffix is /-ŪŪ/, where /U/ stands for a [+high, -low, +round] vowel underspecified for [±ATR]. Here are the key generalizations. First, a short root vowel lengthens before the suffix, e.g., /ba/ ‘stick into the ground’ becomes *báá-ó* (long root vowel). Second, the suffix vowel is short after vowel-final roots, but long after consonant-final roots, e.g., /ba/ ‘stick into the ground’ yields *báá-ó* (short suffix vowel), but /bar/ ‘leave’ yields *bár-óó* (long suffix vowel).<sup>5</sup>

Tables 6 and 7 illustrate vowel length alternations in CV verbs. The above generalizations hold without exception in action nominals: the root vowel is always long and the suffix vowel is always short. Vowel height matters to root vowel lengthening: low and high root vowels lengthen (Table 6), e.g., /bà/, *báá-ɔ* ‘stick

<sup>4</sup>This word-final epenthetic /i/ or /ɪ/ is a systematic counterexample to the ban on word-final derived high vowels. It seems that the ban only holds in the lexical phonology and that these epenthetic vowels are postlexical.

<sup>5</sup>There exists another nominalizing suffix /-bŪ/, which results in doublets such as *díú ~ díúbú* ‘eating’, *íŋóó ~ ímmó* ‘putting’, *wónjúú ~ wómmú* ‘understanding’, and *zínjóó ~ zímmó* ‘sitting’. More examples can be found in Durand (1953). We have not conducted a systematic study of this suffix variation, but we speculate that it may depend on dialect and speech rate. The variation is not completely free: some verbs allow /-ŪŪ/, but not /-bŪ/, e.g., *pírjóó/\*píríbó* ‘sweep’, *sírjóó/\*síríbó* ‘touch’.

into the ground’ and /dì/, *díí-ú* ‘eat’, whereas mid root vowels diphthongize (Table 7), e.g., /kyɛ/, *kyɛ-ɔ* ‘cut’ and /bɔ/, *bɔ-ɔ* ‘want, look for’. The verbs are further divided into two sets (a) and (b) based on vowel length in the imperfective. We will return to the imperfective shortly.

The imperfective paradigm is more complicated. The suffix /-rV/ copies the root vowel except that a high vowel becomes mid, reflecting the constraint against word-final derived high vowels, e.g., /dì/, *díí-ré* ‘eat-IMPF’. The verbs are further divided into two sets (a) and (b) based on whether the root vowel undergoes lengthening and/or diphthongization. The choice is phonologically unpredictable: we have vowel lengthening in /ba/ *bàà-rá* ‘stick into the ground-IMPF’,

Table 6: CV verbs, low and high vowel roots

	Root	Cit. form	Imperf.	Nominal	
(a)	/ba-/	bà	bàà-rá	báá-ɔ	‘stick into the ground’
	/da-/	dà	dàà-rá	dáá-ɔ	‘buy’
	/wa-/	wà	wàà-ná	wáá-ɔ	‘come’
	/kpá-/	kpá	kpáá-rà	kpáá-ɔ	‘boil’
	/la-/	là	làà-rá	láá-ɔ	‘laugh’
	/mí-/	mí	míí-rè	míí-ù	‘rain’
	/bɔ́-/	bɔ́	bɔ́ɔ́-rò	bɔ́ɔ́-ɔ	‘come (of rain)’
	/bú-/	bú	búú-rò	búú-ù	‘measure, calculate’
	/nyú-/	nyú	nyúú-rò	nyúú-ù <sup>a</sup>	‘drink’
/zú -/	zú	zúú-rò	zúú-ù	‘steal’	
(b)	/tá-/	tá	tá-rà	táá-ɔ	‘reach’
	/ɪ-/	ì	ì-ré	íí-ɔ	‘do’
	/dî-/	dî	dî <sup>1</sup> -ré	dîí <sup>1</sup> -ɔ	‘take’
	/dì-/	dì	dì-ré	díí-ú	‘eat’
	/kɔ́-/	kɔ́	kɔ́-ró	kɔ́ɔ́-ɔ	‘give, offer’
	/yí-/	yí	yí-rè	yíí-ù	‘divorce a male’

<sup>a</sup>We mark contrastive nasalization with a subscript tilde to avoid clutter. The interpretation of nasalized vowels is controversial. Kennedy (1966: 12) derives them via absolute neutralization from vowel-/m/ sequences, e.g., /fààm/ → *fààm* ‘fail’: “There is a clear hole in the final nasal pattern. Though n and ŋ occur word final, m does not. Therefore nasalized vowels which are not contiguous to nasals are interpreted as vowel-m sequences.” Bodomo (1997: 9) assumes that nasalization is phonemic and notes that it is mostly found in long vowels.

but not in /tá/ *tá-rà* ‘reach-IMPf’ (Table 6); we have diphthongization in /gyé-/ *gyíé-rè* ‘refuse to take’, but not in /nyé-/ *nyé-rè* ‘see, understand’ (Table 7). This makes the imperfective suffix /-rV/ look rather similar to the number suffix /-rÍ/ which also exhibits lexically conditioned vowel lengthening.

Table 8 illustrates the same paradigms in CVV verbs. The pattern in action nominals is the same as with CV verbs: the root vowel is long and the suffix vowel is short. In imperfectives the root vowel typically remains long, but there is an interesting minor pattern: some verbs undergo vowel *shortening* in the imperfective, e.g., *tá-<sup>l</sup>rá* ‘have-IMPf’ and *gè-ré* ‘go-IMPf’.<sup>6</sup> These verbs provide evidence for a process of root vowel shortening which was not visible in CV verbs where we could only see root vowel lengthening. The verbs ‘be’ and ‘have’ are tonally idiosyncratic and given our uncertainty about the analysis we do not give underlying forms for them.

<sup>6</sup>The ablaut in *gè-ré* ‘go-IMPf’ is specific to this lexical item.

Table 7: CV verbs, mid vowel roots

	Root	Cit. form	Imperf.	Nominal	
(a)	/kyɛ-/	kyè	kyìè-ré	kyíé-ó	‘cut’
	/kpe-/	kpè	kpìè-ré	kpíé-ó	‘enter’
	/gyé-/	gyé	gyíé-rè	gyíé-ò	‘refuse to take’
	/ɲme-/	ɲmè	ɲmìè-ré	ɲmíé-ó	‘beat’
	/gbe-/	gbè	gbìè-ré	gbíé-ú	‘grind roughly’
	/bɔ-/	bɔ	bɔ́ɔ-rò	bɔ́ɔ-ò	‘want, look for’
	/kɔ-/	kɔ	kɔ́ɔ-rò	kɔ́ɔ-ò	‘farm’
	/yɔ-/	yɔ	yɔ́ɔ-rò	yɔ́ɔ-ò	‘roam’
(b)	/ko-/	kò	kò-ró	kúó-ú	‘dry’
	/kó-/	kó	kó-rò	kúó-ù	‘get ready for rain’
	/té-/	té	té-rè	tíé-ò	‘display’
	/zo-/	zò	zò-ró	zóó-ú <sup>a</sup>	‘run’
	/nyé-/	nyé	nyé-rè	nyáá-ò <sup>b</sup>	‘see, understand’

<sup>a</sup>The action nominalization *zóó-ú* is a counterexample to our generalization that there are no derived long mid vowels. Another such verb is /go-/: *gò, gò-rò, góó-ú* ‘wait for, keep watch’.

<sup>b</sup>With this verb, vowel lengthening results in [áá], not in the expected [íé].

Table 8: CVV verbs

	Root	Cit. form	Imperf.	Nominal	
(a)	/baa-/	bàà	bàà-rá	báá-ó	‘grow (of child)’
	/fáà-/	fáà	fáá- <sup>1</sup> rá	fáá- <sup>1</sup> ó	‘seize’
		wáá	wàà-rá	wáá-ó	‘be’
	/tɛ-/	tìè	tìè-ré	tíé-ó	‘shoot’
	/fɛ-/	fìè	fìè-ré	fíé-ó	‘whip’
	/dɛ-/	dìè	dìè-né	díé-ó	‘play’
	/yuo-/	yùò	yùò-ró	yúó-ú	‘open’
(b)		táá	tá- <sup>1</sup> rá	táá-ó	‘have, own’
	/gaa-/	gàà	gè-ré	gáá-ó	‘go’

We now turn to consonant-final roots. Table 9 illustrates the same paradigms in CVC roots. Here the action nominal suffix vowel is always long. The imperfective paradigm shows mixed behavior of the familiar kind: the initial syllable may be heavy (CVC.CV) as in (a) or light (CV.CV) as in (b), depending on the verb. One and the same verb may even allow both forms as in (c): /bal-rV/ ‘be.tired-IMPF’ may come out either as *bàl-lá* or *bàl-á*. Minimal pairs like /bɔŋ-rV/, *bòn-nó* ‘know-IMPF’ with a heavy initial syllable and /wòŋ-rV/ *wò-nó* ‘hear-IMPF’ with a light initial syllable suggest that the choice between the two is lexical. Note that the suffixal /r/ assimilates in place and/or manner to the root-final consonant; the details will be set aside here.<sup>7</sup>

The same paradigms for CVCC verbs are shown in Table 10. Again, the vowel in the action nominal suffix is always long. This time even the imperfective paradigm is uniform: the initial syllable is always heavy (CVC.CV), with no free or lexical variation.

Finally, Table 11 illustrates CVVC verbs. The action nominal suffix vowel is again always long and the imperfective paradigm is uniformly CVV.CV, with no variation.

Having the overtly vowel-final *sàà* ‘spoil’ listed among CVVC verbs deserves a comment. The citation form is clearly vowel-final, i.e., CVV, but there is good

<sup>7</sup>The CVC verb /gbîr-/ ‘sleep’ has the exceptional paradigm *gbi ri*, *gbí'ré*, *gós'ó*. The action nominal is exceptional in having a short suffix vowel, but since it differs segmentally from the root in several ways, including its [ATR] value, we suspect it is probably based on a different lexeme.

2 Metrically conditioned vowel length in Dagaare

Table 9: CVC verbs

	Root	Cit. form	Imperf.	Nominal	
(a)	/bɔŋ-/	bɔŋì	bɔn-nó	bɔŋ-óó	‘know’
	/dɔg-/	dɔgí	dɔg-rò	dɔg-òò	‘boil, brew’
	/ɪŋ-/	ɪŋì	ɪŋ-né	ɪŋ-óó	‘put’
	/biŋ-/	biŋì	biŋ-né~biŋ-né	biŋ-úú	‘put down’
	/sɪŋ-/	sɪŋì	sɪŋ- <sup>1</sup> né	sɪ <sup>1</sup> ŋ-óó	‘equal’
	/pɔg-/	pɔgì	pɔg-ró	pɔg-óó	‘(en)close’
	/sag-/	sagì	sag-rá	sag-óó	‘answer’
	/séɣ-/	séɣí	séɣ-rè	séɣ-òò	‘write’
	/sɔŋ-/	sɔŋì	sɔŋ-nó	sɔŋ-óó	‘help’
(b)	/bar-/	bàrì	bà-rá	bár-óó	‘leave’
	/bur-/	bùrì	bù-ró	búr-úú	‘soak’
	/êr-/	érì	é- <sup>1</sup> ré	é <sup>1</sup> r-óó	‘grind’
	/mar-/	màrì	mà-rá	már-óó	‘paste’
	/sar-/	sàrì	sà-rá	sár-óó	‘slip’
	/sór-/	sórí	só-rò	sór-òò	‘count’
	/wɔŋ-/	wòŋì	wò-nó	wóŋ-úú	‘understand’
	/yel-/	yèlì	yè-lé	yél-úú	‘speak’
	/zɪŋ-/	zìŋì	zì-né	zìŋ-óó	‘sit’
(c)	/bal-/	bàlì	bàl-lá~bàl-á	bál-óó	‘be tired’

evidence that the root is underlyingly /saŋ/: the velar nasal surfaces in the action nominal *sáŋŋ-óó*. It is as if the root-final /ŋ/ were present when the suffix vowel length is determined and then deleted leaving its nasal component behind, resulting in *sáŋ*. The coronal nasal in the imperfective *sáŋ-ná* results from place assimilation with the initial coronal consonant of the imperfective suffix /-rV/. Parallel examples from nouns include *kɔŋ* ‘water’, underlyingly /kɔŋ-/, as in *kɔŋ-fáá* ‘bad water’. In the free form the velar stop deletes leaving nasalization behind and the mid vowel diphthongizes to fill the foot template, resulting in (*kɔŋ*).

Not all verbs with nasal vowels behave in the same way. Compare *sáŋ* ‘spoil’ to *dɪɛ* ‘play’ and *fɪɛ* ‘whip’. Unlike *sáŋ*, the latter two must be underlyingly vowel-final since the corresponding action nominals are *dɪɛ-óó* and *fɪɛ-óó*, with a short suffix vowel. However, the two differ in the imperfective: in *dɪɛ-né* the coronal

Table 10: CVCC verbs

Root	Cit. form	Imperf.	Nominal	
/bârr-/	bárrì	bár- <sup>1</sup> rá	bár <sup>1</sup> r-óó	‘bargain’
/bell-/	bèlli	bèl-lé	bèll-óó	‘deceive’
/gɔll-/	gòlli	gòl-ló	góll-óó	‘go around’
/kann-/	kànnì	kàn-ná	kánn-óó	‘learn’
/kyell-/	kyèlli	kyèl-lé	kyéll-óó	‘listen’
/mánn-/	mánnì	mán- <sup>1</sup> ná	mán <sup>1</sup> n-óó	‘measure’
/nyunn-/	nyùnnì	nyùn-nó	nyúnn-úú	‘smell’
/pègl-/	pègli	pèg-lé	pégl-óó	‘carry’
/penn-/	pènnì	pèn-né	pénn-óó	‘rest’
/sìll-/	sìlli	síl- <sup>1</sup> lé	síl <sup>1</sup> l-óó	‘tell stories’
/tall-/	tàlli	tàl-lá	táll-óó	‘walk fast’

Table 11: CVVC verbs

Root	Cit. form	Imperf.	Nominal	
/báár-/	báárì	báá- <sup>1</sup> rá	báá <sup>1</sup> r-óó	‘finish’
/naan-/	nààni	nàà-ná	náán-óó	‘get ready, develop’
/saal-/	sààli	sààl-á	sáál-óó	‘sharpen’
/saaŋ-/	sàà	sàà-ná	sááŋ-óó	‘spoil’
/piir-/	pìirì	pìi-ré	píir-úú	‘discover’
/piir-/	pìirì	pìi-ré	píir-óó	‘sweep’
/sîir-/	sîirì	sîi- <sup>1</sup> ré	sîi <sup>1</sup> r-óó	‘touch’
/yíèl-/	yíèli	yíè- <sup>1</sup> lé	yíè <sup>1</sup> l-úú	‘sing’
/gíèr-/	gíèri	gíè- <sup>1</sup> ré	gíè <sup>1</sup> r-úú	‘belch’
/fúòr-/	fúòri	fúò- <sup>1</sup> ró	fúò <sup>1</sup> r-úú	‘sip’
/puor-/	pùòrì	pùò-ró	púór-úú	‘thank, greet, pray’
/kɔɔr-/	kòòrì	kòò-ró	kóór-óó	‘delay’
/ɔɔr-/	òòrì	òò-ró	óór-óó	‘chew’



stop of the imperfective suffix /-rV̄/ becomes a nasal, whereas in *fɪ̀ɛ̀-rɛ̀* it does not. We do not have a satisfactory analysis to offer and must leave the topic with these preliminary remarks.

### 3 Proposal

Our claim is that these vowel length alternations serve to optimize metrical structure. The key assumption is that the action nominal suffix /ÚÚ/ subcategorizes for a foot: the left edge of /-ÚÚ/ strives to be aligned with the right edge of a foot. This demands a well-formed foot that respects alignment. Vowel length adjustments are a way to achieve this goal: a short root vowel lengthens to make up a minimal foot and a long suffix vowel shortens because it is unstressed.

We illustrate the analysis in Table 12 with two vowel-final verbs: /ba/ ‘stick into the ground’ and /baa/ ‘grow (of child)’. The processes are described in terms of informal ordered rules. Foot boundaries are marked with parentheses and imply syllable boundaries.

Table 12: The derivation of vowel length in V-final roots

Process	/ba-úú /	/baa-úú /	Motivation
Footing	(bá)úú	(báá)úú	Initial foot needed
V lengthening	(báá)úú	–	No degenerate feet
V shortening	(báá)ú	(báá)ú	No unstressed VV
	[bááú]	[bááú]	

/ba-úú/ undergoes both root vowel lengthening and suffix vowel shortening; /baa-úú/ only undergoes suffix vowel shortening. In both cases, the outcome is (báá)ú, where the syllable containing the suffix vowel falls outside the foot, i.e., it is extrametrical. Kennedy (1966: 4) calls such word-final light syllables *secondary syllables*. Their prosodic structure is illustrated in (1) below.

- (1) A phonological word with a secondary syllable: (*báá*)*ɔ̃*

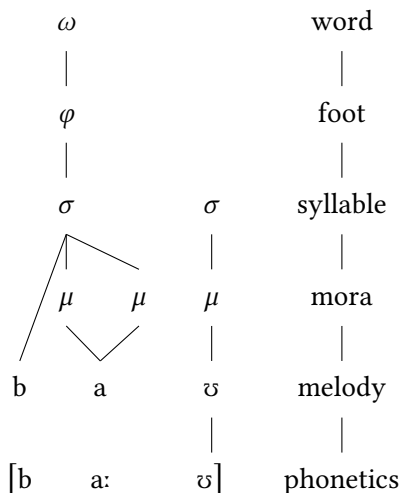

Consonant-final roots are different. Consider /bar/ ‘leave’: if suffix alignment were all that counts the input /bar-*ɔ̃**ɔ̃*/ should be footed \*(*bár*)*ɔ̃**ɔ̃*, but that is not possible because it implies the syllabification \**bár*.*ɔ̃**ɔ̃* which is illegal in Dagaare. Suffix alignment and word prosody are driven into conflict and word prosody wins: the solution is (*bá.rɔ̃*)*ɔ̃* where the long suffix vowel is split into two light syllables: the first is incorporated into the foot and the second remains extrametrical. This implies the syllabification CV.CV.V which is legal in Dagaare (Kennedy 1966: 3-4). Table 13 illustrates this for the consonant-final verbs /bar/ ‘leave’, /bàrr/ ‘bar-gain’ and /bààr/ ‘finish’ in terms of informal ordered rules. The prosodic structure of *bárɔ̃ɔ̃* is shown in (2) below.

Table 13: The derivation of vowel length in C-final roots

Process	/bar- <i>ɔ̃</i> <i>ɔ̃</i> /	/bàrr- <i>ɔ̃</i> <i>ɔ̃</i> /	/bààr- <i>ɔ̃</i> <i>ɔ̃</i> /	Motivation
Footing	( <i>bá.rɔ̃</i> ) <i>ɔ̃</i>	( <i>bár.<sup>!</sup>rɔ̃)<i>ɔ̃</i></i>	( <i>báá.<sup>!</sup>rɔ̃)<i>ɔ̃</i></i>	Initial foot needed
V lengthening	–	–	–	No degenerate feet
V shortening	–	–	–	No unstressed VV
	[ <i>bárɔ̃ɔ̃</i> ]	[ <i>bár<sup>!</sup>rɔ̃<sup>!</sup>ɔ̃</i> ]	[ <i>báá<sup>!</sup>rɔ̃<sup>!</sup>ɔ̃</i> ]	

- (2) A phonological word with a secondary syllable:  $(bár\acute{v})\acute{v}$

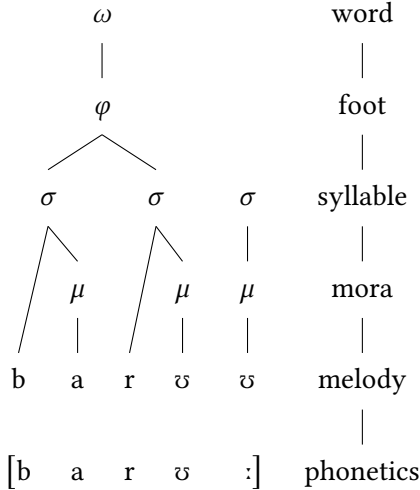

Summarizing, vowel length alternations in Dagaare action nominals can be understood from a metrical perspective. The three key facts, namely vowel lengthening in CV roots, suffix vowel shortening after vowel-final roots and absence of suffix vowel shortening after consonant-final roots receive a unified explanation. In the next section we will outline an optimality-theoretic analysis of action nominals.

## 4 Analysis

### 4.1 Constraints

To keep things simple we will make the following assumptions. Dagaare words have an initial trochaic foot; feet are binary under syllabic or moraic analysis; and degenerate feet, e.g.,  $*(ba)$ , and ternary feet, e.g.,  $*(ba.r\acute{v}\acute{v})$ , are excluded. At most one syllable may be extrametrical:  $(baa.\acute{v})\acute{v}$  is possible, but  $*(baa)\acute{v}.\acute{v}$  is not. Candidates that violate these high-ranking constraints will not be mentioned.

Four phonological constraints are needed to express the generalizations informally outlined in earlier sections. These constraints are given in Table 14.

The Weight-to-Stress Principle (WSP, Prince 1990) punishes unstressed heavy syllables. It is satisfied in  $(báá)\acute{v}$  where the suffix vowel has shortened and surfaces as the light extrametrical syllable  $\acute{v}$  that lacks an onset. It is also satisfied in  $(bár.r\acute{v})\acute{v}$  where the long suffix vowel has been parsed into two light syllables: the tail of the foot  $r\acute{v}$  and the light extrametrical syllable  $\acute{v}$  that lacks an onset. The

Table 14: Four constraints

WEIGHT-TO-STRESS PRINCIPLE	‘No unstressed heavy syllables’
MAX(V)	‘No vowel deletion’
DEP(V)	‘No vowel insertion’
ALIGN(SUFFIX, L, FOOT, R)	‘The left edge of a suffix coincides with the right edge of a foot’

latter is Kennedy’s (1966) “secondary syllable.” The WSP is violated in  $*(báá)úú$ ,  $*(bár)rúú$  and  $*(bár.rúú)$  where the long suffix vowel is parsed as a single heavy syllable.<sup>8</sup>

## 4.2 Deriving vowel length

The four constraints in Table 14 allow us to derive the vowel length alternations in action nominals. We start with CV stems. Tableau (3) establishes the crucial rankings. To simplify presentation, we have omitted tone and simply assume the correct vowel harmony (ATR, rounding). Candidates with ternary feet, degenerate feet, and multiple extrametrical syllables are systematically omitted.

### (3) Vowel length with CV roots

/ba-úú/	WSP	ALIGN	DEP(V)	MAX(V)
(a) $\text{ba}(\text{aa})\text{ú}$			1	1
(b) $(\text{ba.ú})\text{ú}$		1!		
(c) $(\text{ba.úú})$	1	1		
(d) $(\text{baa})\text{úú}$	1!		1	
(e) $(\text{baa.úú})$	1!	1	1	
(f) $(\text{ba.ú})$		1		1

The winner (a) exhibits both suffix vowel shortening and root vowel lengthening. The faithful candidate (b) is perfect in every way except that it fatally mis-

<sup>8</sup>An anonymous reviewer notes that the word /dàgáári/ ‘the Dagaare language’ violates the WSP given a left-aligned trochee, i.e.,  $(dà.gáá)ri$  and wonders why the vowel does not shorten. Two explanations seem possible. First, this could be an instance of nonderived environment blocking (Kiparsky 1993). Second, the intuitively strong syllable is the penult, suggesting the foot structure  $dà(gáári)$ . It should be pointed out that trisyllabic and longer words in Dagaare are often right-headed compounds with the morphological structure  $\sigma+\sigma\sigma$ , e.g.,  $lábíri$  ‘small axe’ from  $lári + bíri$  ‘axe-SG + seed-SG’. It is possible that /dàgáári/ is etymologically a compound, i.e., /dá+gáári/, although synchronically opaque.

aligns the suffix and foot boundaries. Since ALIGN dominates both faithfulness constraints, MAX(V) and DEP(V), the result is a double adjustment of vowel shortening and vowel lengthening. Candidates (c), (e), and (f) are grayed out to show that they are harmonically bounded: they can never win no matter how the constraints are ranked.

We now turn to CVV roots illustrated in Tableau (4). In this case, only suffix vowel shortening is needed in order to satisfy the WSP:

(4) Vowel length with CVV roots

/baa-ʊʊ/	WSP	ALIGN	DEP(V)	MAX(V)
(a)  (baa)ʊ				1
(b) (ba.ʊ)ʊ		1		1
(c) (ba.ʊʊ)	1	1		1
(d) (baa)ʊʊ	1!			
(e) (baa.ʊʊ)	1!	1		
(f) (ba.ʊ)		1		2

Consonant-final roots behave differently. What sets them apart from vowel-final roots is that they inevitably violate ALIGN when combined with a vowel-initial suffix. Given the input /CVC-VV/ the best-aligned candidate is (CVC)VV where the suffix boundary is crisply aligned with the foot boundary. But this foot structure entails the syllabification \*CVC.VV which is illegal in Dagaare.<sup>9</sup> We need a better syllabification, but that will inevitably violate ALIGN. This makes alignment irrelevant with consonant-final roots because it will have to be violated no matter what. We illustrate this for CVC roots in Tableau (5). The winner (ba.rʊ)ʊ has the syllable structure CV.CV.V which is legal in Dagaare.

(5) Vowel length with CVC roots

/bar-ʊʊ/	WSP	ALIGN	DEP(V)	MAX(V)
(a)  (ba.rʊ)ʊ		1		
(b) (ba.rʊʊ)	1	1		
(c) (baa.rʊ)ʊ		1	1	
(d) (baa.rʊʊ)	1	1	1	
(e) (ba.rʊ)		1		1

<sup>9</sup>A full analysis of Dagaare syllable structure cannot be undertaken here. Here we simply assume an undominated locally conjoined constraint ONSET & <sub>L</sub>\*CODA that is violated by the syllabification C.V where the first syllable has a coda and the second syllable has no onset. Other analyses are no doubt possible.

The following question raised by a reviewer is best quoted verbatim:

I see a potential inconsistency between the analyses of /ba-ʊʊ/ and /bar-ʊʊ/. If foot structure can make the suffix split across foot edges, why does /ba-ʊʊ/ need vowel lengthening? The structure (baʊ)ʊ has no degenerate foot and no unstressed VV. It doesn't have -ʊʊ attaching to a foot, but then neither does (ba.rʊ)ʊ.

The answer is characteristically optimality-theoretic: grammaticality is determined by competition. In the case of /ba-ʊʊ/, the candidate \*(baʊ)ʊ loses because there is a better candidate available: the winner (baa)ʊ that satisfies ALIGN. In the case of /bar-ʊʊ/ we have no such luxury: all candidates violate ALIGN and therefore we must settle for the suffix-splitting (ba.rʊ)ʊ.

We conclude by showing the tableaux for CVVC and CVCC roots. They behave analogously and present no additional complications.

(6) Vowel length with CVCC roots

/barr-ʊʊ/	WSP	ALIGN	DEP(V)	MAX(V)
(a) <sup>15</sup> (bar.rʊ)ʊ		1		
(b) (bar.rʊʊ)	1	1		
(c) (baar.rʊ)ʊ		1	1	
(d) (bar.rʊ)		1		1

(7) Vowel length with CVVC roots

/baar-ʊʊ/	WSP	ALIGN	DEP(V)	MAX(V)
(a) <sup>15</sup> (baa.rʊ)ʊ		1		
(b) (ba.rʊ)ʊ		1		1
(c) (baa)rʊʊ	1	1		
(d) (baa.rʊ)		1		1

### 4.3 Lexically conditioned length

Our metrical analysis of Dagaare action nominals is relatively straightforward. Much more intriguing are the number and imperfective paradigms. Table 15 below illustrates lexically conditioned length alternations with the imperfective suffix /-rʋ́/.

In CV-roots the vowel lengthens or stays short; in CVV-roots the vowel stays long or shortens; in CVC-roots the suffix creates a CC cluster /CVC-rʋ́/ which either survives or shortens, sometimes variably within a single lexical item. Why are length alternations so uniform in the action nominal paradigm, but riddled with lexical exceptions in the number and imperfective paradigms? To answer

Table 15: Lexical conditioning in the imperfective

	Underlying	Imperfective	Alternation	
(a)	/da-rV̄/	dàà-rá	lengthening	‘buy’
	/tá-rV̄/	tá-rà	–	‘reach’
(b)	/fáà-rV̄/	fáá- <sup>1</sup> rá	–	‘seize’
	/gaa-rV̄/	gè-ré	shortening	‘go’
(c)	/bɔŋ-rV̄/	bòn-nó –	‘know’	
	/woŋ-rV̄/	wò-nó	C-deletion	‘understand’
	/bal-rV̄/	bàl-lá ~ bàl-á	variation	‘be tired’

this question with any degree of confidence would require a deeper understanding of Dagaare morphophonology than we have at the moment. However, one is immediately struck by the observation that it is the *vowel-initial* suffixes that tend to have uniform paradigms. In addition to the action nominal /-ÚÚ/, the perfective /-ÈÈ/ and the plural /-V̄/ seem fairly regular. It is the *consonant-initial* suffixes that permit exceptions, in particular the number /-rÍ/ and the imperfective /-rV̄/.<sup>10</sup> Trying to explain these apparent suffix-related regularities is an interesting project, but must be left for future work.

## 5 Summary

We have provided new evidence for metrical structure in Dagaare based on vowel length alternations in action nominals. If the root is CV the root lengthens and the suffix shortens; if the root is CVV the suffix shortens; if the root ends in C nothing happens. Similar length alternations appear more idiosyncratically with number and aspect suffixes. We have proposed a metrical analysis that explains the length alternations in action nominals and lends further support to the metrical analysis of vowel length proposed in Anttila & Bodomo 2009 for Dagaare nouns.

<sup>10</sup>Space does not permit a discussion of the perfective /-ÈÈ/ and the plural /-V̄/ here. We hope to return to the topic in a more complete exposition in the future.

## Acknowledgements

This paper has benefited from presentations at the UC Berkeley Phonetics and Phonology Forum (April 30, 2012), the Stanford Phonology Workshop (May 18, 2012), and the 47<sup>th</sup> Annual Conference on African Linguistics at UC Berkeley (March 26, 2016). We thank Luca Iacoponi, David Odden, and two anonymous reviewers for helpful comments. We are responsible for any errors.

## Abbreviations

DIM	diminutive	PL	plural
IMPF	imperfective aspect	SG	singular
PERF	perfective aspect		

## References

- Anttila, Arto & Adams Bodomo. 2000. Tonal polarity in Dagaare. In Vicki Carstens & Frederick Parkinson (eds.), *Trends in African linguistics 4: Advances in African linguistics*, 119–134. Trenton, NJ: Africa World Press.
- Anttila, Arto & Adams Bodomo. 2009. Prosodic morphology in Dagaare. In Masangu Matondo, Fiona McLaughlin & Eric Potsdam (eds.), *Selected Proceedings of the 38th Annual Conference on African Linguistics (ACAL 38)*, 56–68. Somerville, MA: Cascadilla Proceedings Project.
- Bodomo, Adams. 1997. *The structure of Dagaare* (Stanford Monographs in African Languages). Stanford, CA: CSLI Publications.
- Durand, J. B. 1953. *Dagaare-English dictionary*. Diocese of Wa. Printed by Wa Catholic Press.
- Grimm, Scott. 2012. Individuation and inverse number marking in Dagaare. In Diane Massam (ed.), *Count and mass across languages* (Oxford Studies in Theoretical Linguistics), 75–98. Oxford: Oxford University Press.
- Kennedy, Jack. 1966. *Collected field reports on the phonology of Dagaari* (Collected Language Notes 6). Accra: The Institute of African Studies, University of Ghana.
- Kiparsky, Paul. 1993. Blocking in nonderived environments. In Sharon Hargus & Ellen Kaisse (eds.), *Phonetics and phonology*, vol. 4 (Studies in Lexical Phonology), 277–313. San Diego, CA: Academic Press.



- McCarthy, John J. & Alan Prince. 1996. *Prosodic morphology 1986* (Linguistic Department Faculty Publication Series 13). Amherst. [https://scholarworks.umass.edu/linguist\\_faculty\\_pubs/13](https://scholarworks.umass.edu/linguist_faculty_pubs/13).
- Naden, Anthony J. 1989. Gur. In John Bendor-Samuel & Rhonda L. Hartell (eds.), *The Niger-Congo languages: A classification and description of Africa's largest language family*, 140–68. Lanham, MD: University Press of America.
- Prince, Alan. 1990. Quantitative consequences of rhythmic organization. In Michael Ziolkowski, Manuela Noske & Karen Deaton (eds.), *CLS 26: Papers from the 26th Annual Regional Meeting of the Chicago Linguistic Society*, vol. 26, 355–398. Chicago: Chicago Linguistics Society.



## Chapter 3

# “Backwards” sibilant palatalization in a variety of Setswana

Wm. G. Bennett

University of Calgary and Rhodes University

Palatalization of coronals and stridents is well-known and widespread, and is most commonly associated with front vowels or glides as triggers. In some dialect(s) of Setswana, a much different type of palatalization occurs: alveolar stridents /s ts ts<sup>h</sup>/ become pre-palatal [ʃ tʃ tʃ<sup>h</sup>] before back vowels and the glide [w]. Clear empirical support for this pattern comes from productive alternations induced by the nominalizing suffix /-ɔ/, as well as alternations with an assortment of less productive morphemes, and lexical evidence. If palatalization before front vocoids is phonetically natural, then palatalization before back vocoids seems like it must be phonetically unnatural. However, this paper suggests that it is not the case: palatalization before back vowels actually makes phonetic sense, as a consequence of using lip rounding as a phonetic enhancement of the S~Š distinction.

## 1 Introduction

### 1.1 The puzzle

Palatalization of coronals and of stridents is well-known and widespread, and is most commonly associated with high front vowels/glides as triggers (Bateman 2007; 2010; Kochetov 2011; etc.). A common example is Japanese, in which the native lexical stratum exhibits allophony of [s] and [ʃ] depending on the following vowel: [s] occurs generally, but appears as [ʃ] before [i]. Similar patterns are reported in a vast number of languages; Bateman (2007) lists at least Nupe, Korean, English, Mandarin Chinese, Hausa, Mina, Romanian, Moldavian, and Yagua as having similar alternations.

This sort of [s]→[ʃ]/ \_\_\_ i alternation makes a lot of sense. It makes sense articulatorily in that [i] requires the tongue body to be elevated and close to the



palate, while [s] requires the tongue body to be much lower, such that the tip forms a constriction. Thus, it seems reasonable that [s] should be harder to produce than [ʃ] before [i], so we might expect to find the former turning into the latter in that context. This alternation also makes acoustic sense: in the sequence [si], coarticulation between the [s] and [i] should make [s] sound more like [ʃ]. This is because retraction of the tongue blade (to position the blade to produce [i]) increases the length of the cavity in front of the frication. This should shift the noise spectrum of [s] downward, towards that of [ʃ]. So, a s→ʃ alternation before a high front vocoid is phonetically natural, which seems to fit nicely with how common such processes are cross-linguistically.

Some varieties of Setswana give us a glimpse of a very different sort of pattern. In general, [s] and [ʃ] contrast (1). The examples in (2) (from Cole 1955) show underlying /s/ changing into [ʃ] before [ɔ].<sup>1</sup>

- (1) s and ʃ are contrastive in Tswana (Cole 1955: 25)

-sɛba	-ʃɛba
‘slander’	‘look round’

- (2) s → ʃ / \_\_\_ ɔ (!)

a. -hisa	sɪ-hiʃɔ
‘burn’	‘burner’
b. -ɔmisa	sɪ-wɔmiʃɔ
‘dry’	‘dryer’
c. -busa	m-muʃɔ
‘govern’	‘government’

If the s→ʃ/ \_\_\_ i pattern makes sense, then these examples seem downright weird. Here, we observe the same s→ʃ alternation induced by a vowel that is low and back, not high and front. This pattern is not merely s→ʃ, but rather S→ʃ: it holds for all the strident affricates and fricatives alike (as §2 will demonstrate).

The weirdness of this data makes it interesting. A large body of current work appeals to phonetic naturalness as a guiding factor in phonological systems, in various forms. For instance, Hayes (1999) argues that phonological constraints are functionally motivated, and must be phonetically sensible. Steriade’s (2008) P-map proposal, similarly, posits that input-output changes are moderated by perceptual distance, such that phonetically sensible changes are preferred. And

<sup>1</sup>While Cole describes this merely as “Setswana”, it seems to obtain only for certain Southern dialects, and not for standard Setswana. See §2.1 and §2.6 for more discussion.

### 3 “Backwards” sibilant palatalization in a variety of Setswana

the entire body of literature under the banner of “evolutionary phonology”<sup>2</sup> takes phonological patterns to be the direct result of phonetically-driven changes, coupled with morpho-phonological analogy. The pattern we observe in (2) seems phonetically as *un-natural* as can be, in that it is virtually the opposite of a pattern that is phonetically well-motivated. Instead of a high front vowel [i], we observe a relatively low back vowel [ɔ] causing palatalization.<sup>3</sup> As §2 will show, this is not a behaviour unique to [ɔ]; other back vowels also induce the same S→Š/ \_\_ U alternations.

Palatalization before back vocoids is not unprecedented. For instance, Bateman (2007: 68) notes palatalization before [u] in Tohono O’Odham. But, cross-linguistic surveys of palatalization (Bateman 2007; Kochetov 2011) consistently find that high front vocoids are the “best” triggers for palatalization. If palatalization is triggered by a back vocoid like [u], then front vocoids also trigger palatalization. Indeed, the generalization that Bateman reports for Tohono O’Odham is that palatalization is triggered not only by [u], but also by [i] and [e]. This dovetails with an observation (made by Bateman and Kochetov alike) that higher vocoids are better palatalization triggers. In other words, cases such as Tohono O’Odham show palatalization only before *high* back vocoids (which [ɔ] definitively isn’t), and high front vocoids also trigger the same palatalization. A further pertinent fact is that many Southern Bantu languages have palatalization triggered by [w] (Louw 1975/76; Ohala 1978; Herbert 1990; Bennett 2015; Bennett & Braver 2015, etc.). However, this phenomenon preferentially targets bilabials for palatalization, and only marginally applies to non-labials; it therefore seems dissimilatory in nature. Some previous analyses argue that it isn’t dissimilation (e.g. Kotzé & Zerbian 2008), by instead positing that the palatalization is really triggered by an /i/ or /j/ (which is typically covert). Neither of these lines of reasoning lead to a plausible analysis of the Setswana examples in (2). The /sɔ/→[ʃɔ] alternation is not obviously dissimilatory. There is also no evidence for a covert front vocoid in these examples, and indeed front vocoids in Setswana do not otherwise cause palatalization of /s/ (cf. (2a): sɪ-hiʃɔ, \*ʃɪ-hiʃɔ).

The question at hand, then, is how to understand the S→Š/ \_\_ U pattern seen in (2). Is this data reflective of a real process? If so, is it phonetic, phonological, or morphological? If it seems so squarely the opposite of a well-understood and phonetically natural pattern (S→Š/ \_\_ i), why and how does it also exist?

---

<sup>2</sup>(Ohala (1981; 1990; 2004), etc.; rehashed and renamed by Blevins (2004)

<sup>3</sup>A more direct opposite of [i] would be the vowel [a], but this does not exist in Setswana.

## 1.2 The proposal

The main claims of this paper are three. The first is that  $S \rightarrow \check{S}$  palatalization before back vowels is robust and productive in at least some variety of Setswana. The second is that the alternation seems entirely sensible when viewed from another angle: lip rounding may be a reason to prefer  $\check{S}$  over  $S$  before back vocoids. This leads to the third claim: if phonetics informs phonology, it does so in a non-deterministic way.  $S \rightarrow \check{S} / \_ U$  is the opposite of well-understood  $S \rightarrow \check{S} / \_ I$  alternations, in that it is triggered by back vowels instead of front vowels. Moreover, it seems intuitively unlikely that any language could have both  $S \rightarrow \check{S} / \_ I$  and  $S \rightarrow \check{S} / \_ U$ , because the occurrence of the one undermines the evidence for the other.

If opposite phonological patterns can *both* be phonetically natural, then phonetic naturalness cannot in principle give us a complete understanding of phonology.

The paper is structured as follows. §2 presents the Setswana  $S \rightarrow \check{S}$  process in further detail. §3 observes that the phenomenon does not appear to be unique to this language: parallels can be found in a few other Bantu languages, and perhaps further afield. §4 presents rounding as a potential basis for  $S \rightarrow \check{S}$  being phonetically natural before back vocoids like [ɔ]. §5 concludes and observes some of the broader ramifications.

## 2 Data and Support

### 2.1 Background about the data

Setswana (a.k.a. Tswana) is a southern Bantu language (Guthrie S.50) spoken mainly in northern South Africa and Botswana. Examples marked as “own data” were collected by the author, with the help of a native-speaker consultant from Taung, North-West Province, South Africa. This speaker did not report a specific name for his idiolect, but did report being clearly aware that his accent is typical of that area, and is non-standard.<sup>4</sup> Additional data comes from other sources on Setswana, chiefly Cole’s (1955) grammar (no specific dialect information is at hand for most of Cole’s data). For lack of a better name, I will refer to the dialect(s) represented in these sources of data simply as “Setswana”; but it should

---

<sup>4</sup>I thank Thabo Ditsele, Andy Chebanne, and an anonymous reviewer for confirming that Setswana dialects from further east (Gauteng) and north (Botswana) do not exhibit this  $S \rightarrow \check{S}$  pattern.

### 3 “Backwards” sibilant palatalization in a variety of Setswana

be noted that standard, prescriptive, Setswana does not exhibit the patterns described here.<sup>5</sup> On the basis of a dialect comparison by Malepe (1966), it seems that this is a characteristic found only in southern dialects, including those that Malepe calls Rolong, Tlhaping, and Tlharo, though further research is needed to verify how geographically widespread the phenomenon is.

The consonant inventory of Setswana is given in Table 1 (Bennett et al. 2016; see also Cole 1955; Chebanne et al. 1997, U. Arellano 2001). Consonants in parentheses are marginal. Unaspirated stops and affricates may be realized as ejectives (apparently in free variation). The affricate [qχ] is often analyzed as /q<sup>h</sup>/ or /kx<sup>h</sup>/, and [χ] is often characterized as /x/ (Cole 1955, etc.; see Bennett et al. 2016 for further discussion and data).

Table 1: Consonant inventory of Setswana

p p <sup>h</sup> b	t t <sup>h</sup> d			k k <sup>h</sup>		(ʔ)
	ts ts <sup>h</sup>	tɬ tɬ <sup>h</sup>	tʃ tʃ <sup>h</sup> dʒ		qχ	
(f)	s		ʃ		χ	h
m	n			ɲ		
	r					
w		l		j		

The vowel inventory is given in Figure 1 (Bennett et al. 2016). The vowel system has at least four contrastive degrees of height, possibly more.<sup>6</sup> To avoid a deluge of diacritics, the semi-close vowels [ɛ̣ ɔ̣] are rendered as ‘ɪ’ and ‘ʊ’ in all examples (rather than ‘e’ and ‘o’ as in the standard orthography and some previous transcriptions like those of Cole 1955; see also Le Roux & Le Roux 2008 for finer acoustic details). The tonal system of Setswana is complex and involves numerous alternations (see Chebanne et al. 1997 for an overview); as such, tones are not marked in the single-word examples given here. As far as I can tell, they do not affect the consonantal alternations of interest here.

<sup>5</sup>For instance, Arellano’s (2001) *Sound System of Setswana* does not mention the S→ʃ alternation as part of the phonology.

<sup>6</sup>This is a slight simplification. The transcriptions given here follow Cole’s (1955) orthographic ones, which do not generally reflect a vowel harmony process that produces raised counterparts of each pair of mid vowels; see Dichabe (1997) for further details on this harmony. Some sources claim that some or all of these additional degrees of height are not merely derived, but are also contrastive in that they occur in contexts not explainable by the vowel harmony (for example, see Chebanne et al. 1997; Creissels 2005, and also Khabanyane 1991 on Southern Sotho).

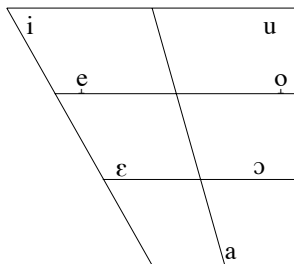

Figure 1: Vowel inventory of Setswana (Bennett et al. 2016)

## 2.2 On S and Š

The focus of interest for this paper is palatalization of stridents before back vowels, characterized in shorthand as  $S \rightarrow \check{S} / \_ U$ . The “S” denotes all anterior stridents, whether they appear alone or in NC sequences: {s ts ts<sup>h</sup> ns nts nts<sup>h</sup>}. The “Š” likewise denotes posterior stridents: {ʃ tʃ tʃ<sup>h</sup> nʃ ntʃ ntʃ<sup>h</sup>}. The “U” denotes back vowels and glides: {ɔ ʊ u w}. There is no evidence that the voiced posterior affricate [dʒ] participates in the pattern; this is consistent with the absence of [z ʒ] from the native consonant inventory.

## 2.3 Productive, synchronic S~Š alternations

The examples from §1 point to a neutralizing pattern. That is, S and Š are normally contrastive, and we find  $S \rightarrow \check{S}$ , but not the reverse  $\check{S} \rightarrow S$ . The most robust and productive source of synchronic S~Š alternations comes from nominalizations formed with the suffix /-ɔ/. Some examples are given below in Table 2. For /ts<sup>h</sup>/ → [tʃ<sup>h</sup>], it’s difficult to find examples showing this alternation because /ts<sup>h</sup>/ is relatively uncommon in stem-final position. But, it can be derived in irregular causatives; these forms do show  $S \rightarrow \check{S} / \_ U$  in the expected fashion.

The S~Š alternations we see here are not characteristic of nominalizations in general. Agentive nominalizations are formed with a suffix /-i/, and these don’t exhibit the same alternation (cf. -t<sup>h</sup>usa ‘help’ > mɔ-t<sup>h</sup>usi ‘assistant, helper’; \*mɔ-t<sup>h</sup>ufi). As such, the S~Š alternation evident in these forms must be due to the presence of the vowel [ɔ]. This is corroborated by other morphemes that also show the same related S~Š pattern.



### 3 “Backwards” sibilant palatalization in a variety of Setswana

Table 2: Productive S→Š alternations in /-ɔ/ nominalizations

/s/ → [ʃ]				
-hisa	‘burn’	si-hiʃɔ	‘burner’	(own data)
-ɔmisa	‘dry sth.’	si-wɔmiʃɔ	‘dryer’	(own data)
-busa	‘govern’	m-muʃɔ	‘government’	(Cole 1955: 77)
-t <sup>h</sup> usa	‘assist’	t <sup>h</sup> uʃɔ	‘assistance’	(Cole 1955: 90)
/ts/ → [tʃ]				
-bitsa	‘call’	piʃɔ	‘a call’	(own data)
-χɔpɔtsa	‘remind’	si-χɔpɔʃɔ	‘reminder’	(Cole 1955: 86)
-lɔtsa	‘whet, sharpen’	tɔʃɔ	‘whetstone’	(Cole 1955: 90)
-bɔtsa	‘ask’	pɔʃɔ	‘question’	(Cole 1955: 90)
-itsi	‘know’	kiʃɔ	‘knowledge’	(Cole 1955: 90)
-ikɔkɔbetsa	‘stoop (refl, caus)’	bɔ-ikɔkɔbetʃɔ	‘humility’	(Cole 1955: 205)
-ijatsa	‘despise (refl)’	ijatʃɔ	‘self-disparagement’	(Cole 1955)
/ts <sup>h</sup> / → [tʃ <sup>h</sup> ]				
-bɔnts <sup>h</sup> a	‘show’	pɔntʃ <sup>h</sup> ɔ	‘a showing’	(own data; cf. bona ‘see’)
-t <sup>h</sup> alifa	‘become wise’	-t <sup>h</sup> alrts <sup>h</sup> a, -t <sup>h</sup> alrtʃ <sup>h</sup> wa	‘make wise’	(Cole 1955: 205)

#### 2.4 S→Š in other morphological contexts

The S→Š alternation can also be observed in certain pronominal concords; examples are given in Table 3 below (from Cole 1955). The first set of forms are pronouns, demonstratives, and quantifiers with class 8/10<sup>7</sup> concord. In pronominal stems that have front vocoids like [ɛ], class 8/10 forms always have [ts]. However, class 8/10 forms have [tʃ] when the following vowel is [ɔ], manifesting the S→Š/ \_\_ U pattern. The second set of forms show class 7 behaving the same way: we find [s] in class 7 forms generally, but [ʃ] before [ɔ]. (These pronominal stems are few in number, and phonotactically non-diverse; in reading Cole’s (1955) grammar, I was unable to find any that have other vocoids.)

We can also observe S→Š/ \_\_ U in certain verbal suffixes. One is the reversive verb extension, variously /-ɔl-/ or /-ɔlɔl-/ (3) (Cole 1955:212ff). The form in (3a) looks on the surface like an applicative structure /-ts<sup>h</sup>-ɛl-a/, based on a root /-ts<sup>h</sup>-/ (which is not attested by itself). Related stems that have the reversive extension instead of the applicative one have [tʃ<sup>h</sup>] instead of [ts<sup>h</sup>] (3b,3c).

<sup>7</sup>Classes 8 and 10 are homophonous, so I will not distinguish them here.

Table 3: S~Š alternations in pronominal stems

Class 8/10: ts before ε		tʃ before ɔ	
tse	‘this’	tʃɔne	‘they’
tseʊ	‘that’	tʃɔsi	‘only they’
tseɳ	‘that one’	tʃɔɔpedi	‘both’
tsele	‘that one yonder’	tʃɔtʰε	‘all’
muχatse	‘his/her spouse’	muχatʃɔ	‘your spouse’
Class 7: s before ε		ʃ before ɔ	
sε	‘this’	ʃɔne	‘it’
sεʊ	‘that’	ʃɔsi	‘only it’
sεɳ	‘that one’	ʃɔtʰε	‘all’
sele	‘that one yonder’		

(3) Reversive verb extension

- a. -ts<sup>h</sup>εla ‘pour’
- b. -tʃ<sup>h</sup>ʊla ‘serve, dish out food’
- c. -tʃ<sup>h</sup>ʊkɔla ‘spill’

The passive suffix also shows evidence for the same S→Š/ \_\_ U alternation, albeit in a less simple way. This is illustrated in (4) and (5), based on data and observations from Cole (1955: 193–195). The basic form of the passive is /-w-/ (4a). However, Cole reports that the same extension is normally realized instead as /-iw-/ after roots ending with {s ts ts<sup>h</sup>} (4b); roots ending with /ts/ additionally change the /ts/ into [d] (4c). This is not direct evidence for the S→Š/ \_\_ U alternation, but the allomorphy is clearly phonotactically-based, and systematically fails to produce surface SU sequences.

(4) Passive suffix allomorphy (Cole 1955:193ff)

- a. -bɔn-a > -bɔn-w-a  
‘see’
- b. -bes-a > -bes-iw-a  
‘roast’
- c. -bits-a > -bid-iw-a  
‘call’

### 3 “Backwards” sibilant palatalization in a variety of Setswana

Furthermore, Cole (1955) does note that some Eastern dialects of Setswana use /-w-/ instead of /-iw-/ in these instances. In those forms, we *do* find the S→Š/\_\_\_U alternation, occurring just as expected (5). Thus, the passive suffix allomorphy avoids creating SU sequences; where it does create them, we find S→Š as usual.

#### (5) Setswana: Eastern dialects (Cole 1955)

- a. -bɛs-iw-a ~ -bɛʃ-w-a  
‘be roasted’
- b. -bid-iw-a ~ -bitʃ-w-a  
‘be called’

Palatalization can also be observed with the diminutive suffix /-ana/, which causes a host of changes to preceding consonants (for further details and discussion, see Cole 1955; Louw 1975/76; Herbert 1990; Bateman 2007; Kotzé & Zerbian 2008). The generalization of note here is that some of these changes can derive stridents from other, non-strident, consonants. These derived consonants follow the same S→Š alternation we see elsewhere. This is illustrated in (6): /d/ changes to [ts] generally (6a), but to [tʃ] when it precedes a back vocoid (6b).

#### (6) S→Š in diminutives (Cole 1955)

- a. pɔdi → puts-ana  
‘goat’
- b. lɪ-χɔdu → lɪχɔtʃw-ana  
‘thief’

## 2.5 Further lexical evidence

We can also observe the S→Š/\_\_\_U pattern in the lexicon. One source of evidence is from lexical doublets. These substantiate the same observation made about the diminutives above: when something changes a consonant into S, it also changes into Š before U. Cole (1955: 83ff) notes that certain nouns of class 5/6 have doublets, one with [ts] or [s], the other with {b l d r h χ}. Table 4 gives some examples of this variant S (mainly drawn from Cole 1955:83ff); for example, the first one [lɪ-tsatsi] ‘sun, day’ has [ts], while the usual plural form Cole reports is [ma-latsi], with [l] instead.

Table 4: Lexical doublets with S

-latsi	lɪ-tɕatsi (cf. pl. ma-latsi)	‘sun, day’	(l ~ ts)
-dibɔχɔ	lɪ-tɕibɔχɔ	‘ford’	(d ~ ts)
-bele	lɪ-tɕele	‘breast’	(b ~ ts)
-rapɔ	lɪ-sapɔ	‘bone’	(r ~ s)
-rama	lɪ-sama	‘cheek’	

Table 5: Lexical doublets have Š instead of S before U

-bɔχɔ	lɪ-tʃɔχɔ (cf. pl. ma-bɔχɔ)	‘arm’	(b ~ tʃ before U)
-bɔlɪ	lɪ-tʃwɪlɪ	‘fist’	
-rɔp <sup>h</sup> i	lɪ-tʃɔp <sup>h</sup> i	‘blister’	(r ~ ʃ before U)
-rɔpe	lɪ-tʃɔpe	‘ruin’	
-rɔɔ	lɪ-tʃ <sup>h</sup> ɔɔ	‘paw’	
-χɔdi	lɪ-tʃɔdi	‘starling’	(χ ~ ʃ before U)
-hulɔ	lɪ-tʃulɔ	‘foam, froth’	(h ~ ʃ before U)
-hudu	lɪ-tʃudu	‘hole for stamping corn’	

When a back vowel follows the initial consonant of the root, we do not find doublets with S; instead, they have Š. This is illustrated in Table 5 (examples again from Cole 1955).<sup>8</sup>

Additional support for S→Š/ \_\_ U comes from the distribution of stridents in the lexicon. The occurrence of SU, i.e. {s ts ts<sup>h</sup>} before a back vocoid, seems to be vanishingly rare. Some examples of SU forms are attested in Cole’s grammar, but many are presented as variant forms that may also be realized with Š. A few words systematically must have SU (not ŠU), but are clearly loanwords. These are illustrated in Table 6 below. It is worth noting, however, that there are also loanwords where source S *does* neutralize to Š before U. Such forms cannot be attributed by some general characteristic of the treatment of loanwords, because loans with [s] before non-back vocoids normally retain it faithfully as [s] (as in ‘stool’ in Table 6).

<sup>8</sup>Cole (1955: 83) notes some exceptional forms that deviate from this generalization in minor ways. For example, [lɪ-saχɔ] ‘buttock’ is listed with variant forms [lɪ-ts<sup>h</sup>aχɔ ~ lɪ-tʃaχɔ]. No [ʃ] is expected here, since the following vowel is [a]. But, interestingly, the plural is only given with [s], as [ma-saχɔ].

### 3 “Backwards” sibilant palatalization in a variety of Setswana

Table 6: Sporadic S→Š/ \_\_ U in loanwords

Exceptional SU sequences in loanwords		
lɪ-tsula ~ lɪ-sʊlɔ ~ lɪ-zʊlɔ	‘Zulu person’	< Zulu
pɔsɔ dʒɛsu zuu	‘post office’ ‘Jesus’ ‘zoo’	< Afrikaans
Loanwords with non-exceptional S→Š/ __ U		
lɪ-ʃɔlɛ ʃukiri sɪ-tulɔ	‘soldier’ ‘sugar’ ‘stool’	s→ʃ neutralization  normally s→s

In the native lexicon, Š may occur before any of the vowels: {ʃ tʃ tʃ<sup>h</sup>} are not as restricted as {s ts ts<sup>h</sup>}. Some examples of Š before non-back vowels are given in Table 7 below (from Cole 1955).

The preponderance of examples in Table 7 show Š before [a], rather than the other non-back (i.e. front) vowels. This is not an accident of presentation, but reflects the trend in the data that Cole (1955) provides. Š seems more common before [a] than before front vowels. ŠI sequences (where ‘I’ stands for front vowels) also seem less common than SI sequences, but they are not nearly as rare as ŠU. These observations, consolidated in Table 8, are based on my own impressions of data collected first-hand, as well as examination of Cole’s (1955) data. Cole’s (1955: 35) description of the relationship between S and Š agrees with my impressions.

The generalization that SU sequences are almost completely absent from the lexicon suggests that the S→Š/ \_\_ U generalization is not merely part of the morpho-phonology of the language, but also holds over the lexicon as a phonotactic generalization. The observation that Š is more common before back vowels than front vowels is not obviously expected. It is conceivable that Š is over-represented before back vowels because the S→Š/ \_\_ U neutralization derives Š in this context, but more extensive quantitative study is needed to be sure.

Table 7: Š may occur before non-back vowels (Cole 1955)

Ši	ma-fi	‘milk’
Šɪ	di-faɪ	‘coward’
	mʊ-fi	‘meerkat’
	-fɪna	‘(to) bare teeth’
	ntʃɪ	‘ostrich’
	bʊ-ratʃɪ	‘brush’
Šɛ	-fɛba	‘(to) look round’
	fɛɛɛŋ	‘shilling’
Ša	-fa	‘disperse’ (of mist)
	-fa	‘(to) burn (unacc.)’
	-fa(j)a	‘give child a name’
	-fa	‘new’
	mʊ-fa	‘young person’
	-faqχala	‘become angry’
	ntʃa	‘dog’
	-tʃa	‘dry up (unacc.)’
sɪ-tʃʰaba	‘nation, tribe’	

Table 8: Impressionistic trends in the distribution of S and Š before front, central, and back vowels

	Front {i ɪ ɛ}	Central {a}	Back {u ʊ ɔ}
S {s ts tsʰ}	common	uncommon	very rare
Š {ʃ tʃ tʃʰ}	uncommon	common	common

## 2.6 Historical and comparative support

Finally, there is also historical and comparative evidence that corroborates the S→Š/ \_\_\_ U pattern. According to Malepe’s (1966: 67ff) dialect survey and comparative analysis, the Rolong, Tlhaping, and Tlharo dialects underwent a historical change \*S > Š/ \_\_\_ {u ʊ ə}. Evidence for this change comes from dialect variation of exactly the sort expected based on the lexical variation seen so far. For example, Malepe identifies ‘hearth’ as [lɪ-ijə] in the Rolong dialect, but [lɪ-iso] in Kwena and other dialects. There is no S~Š dialect variation before front vowels.<sup>9</sup>

The point: circumstantial evidence confirms that the S~Š alternations seen above are a change *from* S, *to* Š – a change conditioned by *back* vocoids. It is not the case that there is back-and-forth allophony with no contrast. Nor is it the case that the alternating stridents were historically \*Š, with de-palatalization or fronting induced by front vowels.

## 3 Parallels elsewhere?

Setswana is not alone in having a “backwards” distribution of Š and S before vowels. A similar pattern is reported much further north, for Haya and Nkore-Kiga, Bantu languages spoken in Tanzania and Uganda. In both cases, the reported pattern is that [s z] occur before /i/, while [ʃ ʒ] occur before /e a o u/ (Byarushengo 1975; Hyman 2003b; see also Hansson 2001; 2010). This is more narrowly the opposite of patterns like the Japanese one, with a split between the high front vowel [i] versus all the other vowels.

In the Haya and Nkore-Kiga cases the origin of the “backwards” pattern seems to be morphological. Hyman’s (2003b) analysis of the S~Š alternations in Haya is that Proto-Bantu \*c spirantized to [s] before the short causative \*-i-, and the causative \*-i- was absorbed in the process, yielding a string of changes \*c-i- > sj > [s].<sup>10</sup> This resulted in synchronic s~ʃ alternations between related verb stems, e.g. [-ʃáaf-a] ‘hurt (intransitive)’ vs. [-ʃáas-a] ‘hurt (transitive)’ (Hyman 2003b: 85). The stem-final [s] in the latter form is due to the historical presence of \*-i-, while the unaffixed form retains [ʃ]. Such alternations were then generalized by analogy, in effect treating all s-final stems as “pseudo-causatives”.

<sup>9</sup>Malepe (1966) characterizes Rolong, Tlharo and Tlhaping as Southern dialects. He identifies the hometown of the primary consultant, Taung, as a Tlhaping area. Another consultant I worked with came from Kuruman, which Malepe notes as a Tlharo area.

<sup>10</sup>See also Bennett & Pulleyblank (2018) for an argument that morphology is a major factor in the synchronic distribution of [s] and [ʃ] in Nkore-Kiga.

The Setswana pattern is clearly not morphological in this way, however: it seems entirely phonotactic in nature. The S~Š alternation can be seen in a wide range of morphemes, and even root-internally. This includes many situations where any kind of spirantizing influence of a historical superhigh vowel is implausible, e.g. in demonstratives, possessives, and /-ɔ/ nominalizations. In short, the Setswana pattern is clearly not due to front vocoids; not historically, and not synchronically.

Examples of other languages more in line with Setswana, with *phonotactic* s~ʃ patterns induced by back vocoids, are less abundant. However, there is a possible example in Tigrinya<sup>11</sup>: numerals exhibit s~ʃ alternation, with ʃ appearing only before back, round, vowels. Thus, we find [s] in [səbʁa] ‘seventy’, but [ʃ] in [ʃobatte] ‘seven’ (Banksira 2000:231ff).

## 4 A roundabout explanation

### 4.1 Rounding as an enhancement for S~Š distinction

Why should back vowels have an affinity for [-anterior] stridents? One possible reason is rounding. Back vowels normally involve lip rounding, both in Setswana and cross-linguistically.

In at least some languages with s S~Š contrast, lip rounding serves as a redundant phonetic enhancement of that contrast (Stevens et al. 1986; Keyser & Stevens 2006). English is such a language: [ʃ] is normally articulated with some degree of lip rounding. This rounding makes good phonetic sense: it shifts the noise spectrum of [ʃ] downward, further away from that of [s].<sup>12</sup> With this in mind, an interaction between posterior sibilants and round vowels seems much less outlandish.

### 4.2 Conjecture: A historical pathway

If posterior sibilants have an affinity for rounding, then perhaps the situation we find in Setswana is a phonologization of that interaction. How would this work? One possibility is a historical pathway as follows.

---

<sup>11</sup>I thank Sharon Rose for pointing this example out to me.

<sup>12</sup>Keyser & Stevens (2006: 49) demonstrate this interaction for English, but the phonetic effect of rounding seems to be far more general. See Ní Chiosáin & Padgett (2001: 7) on Turkish, and McCollum (2015: 342-343) on Kazakh, for instance.



### 3 “Backwards” sibilant palatalization in a variety of Setswana

1. Proto-Bantu did not have a S≠Š contrast (Meinhof 1932; Hyman 2003a, etc.), but Setswana currently does. At some point, that contrast must have arisen in some intermediate ancestor of present-day Setswana; call it “Pre-Tswana”.<sup>13</sup>
2. Lip rounding serves to enhance the S≠Š contrast. Pre-Tswana would have used this enhancement, in much the same fashion as English and other languages.
3. In a SU sequence, normal C-V co-articulation would cause S to be produced with some degree of rounding.
4. Adding lip rounding to S shifts the spectral distribution down, making it closer to that of Š.
5. This means that SU sounds more like ŠU. Speakers of Pre-Tswana would be more likely to misperceive S as Š when it comes before U than before other vowels.
6. The result:
  - a) \*SU > ŠU: \*S and \*Š merge to Š before round (=back) vocoids.
  - b) \*SA > SA: \*S remains S before non-round (=non-back) vocoids.
  - c) \*ŠA > ŠA: \*Š also remains Š before non-round (=non-back) vocoids.The S≠Š contrast is retained, except before back vocoids.

This pathway is conjecture, with certain facts still to be confirmed. The use of rounding as an enhancement gesture on Š remains to be quantified. The degree of rounding on back vowels, likewise, remains to be documented. However, it is worth noting that at least one much earlier description corroborates the presence of lip rounding on Š before back vowels.

One of the earliest published descriptions of the phonetics and phonology of Setswana comes from Daniel Jones and Sol Plaatje (Jones & Plaatje 1916, *et seq.*). Jones & Plaatje (1916: xx.32) make a fine-phonetic distinction between two kinds of posterior sibilants, [ʃ] and [ʃ̹], the latter being essentially a rounded [ʃ]. In their transcriptions, [ʃ̹] corresponds to modern <šw>, and to <š> before any back (round) vowel. Thus, [tʃɔtʰɛ] ‘cl.10-all’ is transcribed by Jones & Plaatje (1916: 3)

---

<sup>13</sup>Based on Malepe’s (1966) list of historical changes, it seems that [s] comes primarily from Proto-Bantu velars (particularly \*k), while [ʃ] is more often from historical \*t and \*p (especially \*pw). This may be the reason why [ʃ] is more common with back vowels than front vowels.

as [cʰōtʰhě́], with rounded [ʰ] rather than plain [f]. This degree of rounding on /f/ is not distinct from sequences regarded in later work as Š-w clusters (e.g. Cole 1955; Chebanne et al. 1997, and in standard orthography). Thus, modern standard rendering <bêṭšwana> (= [betʃwana]; archaic variant of *baTswana*) is transcribed by Jones & Plaatje as [becʰana]. This implies that /f/ has considerable rounding before back vowels, in at least the Setswana dialect spoken by Plaatje. Jones & Plaatje do not indicate rounding on any other coronal consonants before back vocoids (e.g. [kxatwani]).

Although the presence of rounding on stridents before back vowels still needs to be documented instrumentally, the fact that Jones & Plaatje detected rounding in this position is highly suggestive. The point: while the historical pathway sketched out above is conjectural, the available evidence suggests that it's very much on the right track.

### 4.3 From diachronic change to synchronic phonology

Modern Setswana (or at least the variety considered here) has productive S→Š alternations, not merely a skew in its lexical items. This means that at some point, the interaction between stridents and back vowels must have changed from diachronic drift to part of the learned, synchronic, phonology.

Co-articulatory rounding blurring the phonetic distinction between [s] and [ʃ] seems insufficient to explain the synchronic situation. There is a contrast between Š and S. All Setswana speakers I have consulted seem to be entirely capable of distinguishing these consonants acoustically and articulatorily, and also capable of producing both anterior and posterior sibilants before all vowels. The S-Š pattern also seems to be a point of non-trivial salience from a sociolinguistic standpoint: compare modern spellings *Setswana* and *Tswana* with more archaic spellings *Sechuana* and *Chuana* (used by Jones & Plaatje (1916), for instance, and the apparent standard at that time). This entails the possibility that speakers could produce both ŠU and SU, and moreover have some awareness of the possibility of varying between them. So, it is plainly not the case that /s/ and /ʃ/ simply sound alike before back vocoids.

In the synchronic phonology, it seems like the S→Š pattern is a qualitative alternation, not merely the result of gradient gestural overlap or co-articulatory rounding of S. The phonetic pathway sketched out above is a plausible origin story for the pattern. But at some point, it must have been integrated into the phonology of Setswana, with a concomitant shift in representation.

## 5 Summary and conclusions

### 5.1 Summary

The primary aim of this paper has been to demonstrate the existence of a “backwards” pattern of sibilant palatalization in some variety of Setswana. As we have seen, there are speakers who robustly produce  $S \rightarrow \check{S}$  alternations conditioned by a following back, round, vocoid. These alternations apply systematically to the class of anterior stridents [s ts ts<sup>h</sup>], and yield their posterior counterparts [ʃ tʃ tʃ<sup>h</sup>]. They occur productively across various different categories of morphemes, including verbs, nouns, quantifiers, and demonstratives; the pattern also appears to hold over the lexicon in a near-complete way (with the exception of some recent loanwords). Though the pattern is not part of standard Setswana, evidence that it is real and robust comes not only from speakers I consulted, but also from the consultants who provided the data for Cole’s (1955) grammar, and from Sol Plaatje’s own intuitions (Jones & Plaatje 1916).

The secondary aim of the paper has been to argue that the  $S \rightarrow \check{S} / \_ U$  pattern is not as phonetically unnatural as it might at first seem. The use of rounding as an enhancement of the  $S \neq \check{S}$  contrast offers a very reasonable mechanism for stridents to shift away from S, and to  $\check{S}$ , in the context of a back, round, vocoid. The synchronic  $S \rightarrow \check{S} / \_ U$  alternations can be regarded as a sort of phonologization of co-articulatory rounding of stridents before back vowels. Though not immediately intuitive, the pattern is not wholly unnatural.

### 5.2 Broader conclusions

The existence of  $S \rightarrow \check{S} / \_ U$  in Setswana has broader ramifications for the relationship between phonetics and phonology.

If the claim that  $S \rightarrow \check{S} / \_ U$  is a natural development as suggested in §4, then we must conclude that two very different kinds of  $S \rightarrow \check{S}$  alternations are *both* natural:  $S \rightarrow \check{S} / \_ I$ , and  $S \rightarrow \check{S} / \_ U$ . The naturalness of these patterns comes from different sources: one is an interaction based on the tongue blade, the other based on the effects of lip position. But both are phonetically natural – despite seeming like near opposites.

The naturalness of  $S \rightarrow \check{S} / \_ U$  leads to a much broader conclusion: to the extent that phonetics guides phonology, it does so non-deterministically. The idea that phonological systems and mechanisms are somehow derived from phonetics is very much in vogue in some recent work (Ohala 1981; 1990; 2004; Hayes 1999; Steriade 2008; Kawahara 2008, to name just a few). But in this case, “Does it make



## Acknowledgments

For help in collecting Setswana data, and helpful discussion of the ideas presented here, I thank Tsholofelo Wesi, Maxine Diemer, Justine Kerford, Tracy Probert; two Setswana consultants (Katlego and Mpho); Thabo Ditsele, Aaron Braver, Wendell Kimper, Andries Coetzee, Rose Letsholo, Andy Chebanne, Sharon Rose, Doug Pulleyblank, Adam McCollum, Seunghun Lee, Mark de Vos, and two anonymous reviewers. This work was supported by a grant from the Rhodes University Research Committee, and its presentation at ACAL supported by a grant from the South African National Research Foundation.

## References

- Arellano, Jorge Eduardo. 2001. *The sound system of Setswana*. Gaborone: Lightbooks.
- Banksira, Degif Petros. 2000. *Sound mutations: The morphophonology of Chaha*. Amsterdam: John Benjamins.
- Bateman, Nicoleta. 2007. *A crosslinguistic investigation of palatalization*. University of California, San Diego. (Doctoral dissertation).
- Bateman, Nicoleta. 2010. The change from labial to palatal as glide hardening. *Linguistic Typology* 14(2). 167–211.
- Bennett, Wm G. & Aaron Braver. 2015. The productivity of ‘unnatural’ labial palatalization in Xhosa. *Nordlyd* 42(1). 33–44.
- Bennett, Wm. G. 2015. *The phonology of consonants: Harmony, dissimilation, and correspondence*. Cambridge: Cambridge University Press.
- Bennett, Wm. G., Maxine Diemer, Justine Kerford, Tracy Probert & Tsholofelo Wesi. 2016. Illustrations of the IPA: Setswana (South African). *Journal of the International Phonetic Association* 46(2). 235–246.
- Bennett, Wm. G. & Douglas Pulleyblank. 2018. Directionality in Nkore-Kiga sibilant harmony: Arbitrary or emergent? *Linguistic Inquiry* 49(1). 1–22.
- Blevins, Juliette. 2004. *Evolutionary phonology: The emergence of sound patterns*. Cambridge: Cambridge University Press.
- Byarushengo, Ernest R. 1975. *An examination of the segmental phonology of Haya*. University of Dar es Salaam. (MA thesis).
- Chebanne, A. M., D. Creissels & H. W. Nkhwa. 1997. *Tonal morphology of the Setswana verb*. München: LINCOM Europa.
- Cole, Desmond T. 1955. *An introduction to Tswana grammar*. Cape Town: Longman.

- Creissels, Denis. 2005. L'émergence de systèmes à neuf voyelles en Bantou S30. In Koen A. G. Bostoen & Jacky Maniacky (eds.), *Studies in African comparative linguistics, with a special focus on Bantu and Mande*, 190–198. Tervuren: Musée Royal de l'Afrique Centrale.
- Dichabe, Seipati Bernice. 1997. *Advanced tongue root harmony in Setswana*. University of Ottawa. (MA thesis).
- Hansson, Gunnar Ólafur. 2010. *Consonant harmony: Long-distance interaction in phonology* (University of California Publications in Linguistics 145). Berkeley, CA: University of California Press. Revised version of Hansson (2001).
- Hansson, Gunnar Ólafur. 2001. *Theoretical and typological issues in consonant harmony*. University of California, Berkeley. (Doctoral dissertation).
- Hayes, Bruce. 1999. Phonetically-driven phonology: The role of Optimality Theory and inductive grounding. In Michael Darnell, Edith Moravcsik, Michael Noonan, Frederick Newmeyer & Kathleen Wheatly (eds.), *Functionalism and formalism in linguistics, volume I: General papers*, 243–285. Amsterdam: John Benjamins.
- Herbert, Robert K. 1990. Labial palatalization in Sotho and Nguni languages: Internal and external evidence. *South African Journal of African Languages* 10. 74–80.
- Hyman, Larry M. 2003a. Segmental phonology. In Derek Nurse & Gérard Philippson (eds.), *The Bantu languages*, 42–58. London: Routledge.
- Hyman, Larry M. 2003b. Sound change, misanalysis, and analogy in the Bantu causative. *Journal of African Languages and Linguistics* 24. 55–90.
- Jones, Daniel & Solomon Tshekiso Plaatje. 1916. *A Sechuana reader*. London: University of London press.
- Kawahara, Shigeto. 2008. Phonetic naturalness and unnaturalness in Japanese loanword phonology. *Journal of East Asian Linguistics* 18(4). 317–330.
- Keyser, Samuel Jay & Kenneth N. Stevens. 2006. Enhancement and overlap in the speech chain. *Language* 82(1). 33–63.
- Khabanyane, Khathatso Evelyn. 1991. The five phonemic heights of Southern Sotho: An acoustic and phonological analysis. *Working Papers of the Cornell Phonetics Laboratory* 5. 1–36.
- Kochetov, Alexei. 2011. Palatalisation. In Colin Ewen, Elizabeth Hume, Marc van Oostendorp & Keren Rice (eds.), *Companion to phonology*, 1666–1690. London: Wiley Blackwell.
- Kotzé, Albert E. & Sabine Zerbian. 2008. On the trigger of palatalization in the Sotho languages. *Journal of African Languages and Linguistics* 29(1). 1–28.

### 3 “Backwards” sibilant palatalization in a variety of Setswana

- Le Roux, Mia & Jurie Le Roux. 2008. An acoustic assessment of Setswana vowels. *South African Journal of African Languages* 28. 156–171.
- Louw, J. A. 1975/76. Palatalization of bilabials in the passive, diminutive and locative in Xhosa and Tsonga. *Afrika und Ubersee* 49(4). 241–278.
- Malepe, Adam Tsele. 1966. *A dialect-geographical survey of the phonology of the central, eastern, and southern dialects of Tswana*. University of South Africa. (MA thesis).
- McCollum, Adam. 2015. Labial harmonic shift in Kazakh: Mapping the pathways and motivations for change. In Anna E. Jurgensen, Hannah Sande, Spencer Lamoureux, Kenny Baclawski & Alison Zerbe (eds.), *Proceedings of The 41st Annual Meeting of the Berkeley Linguistics Society*, 329–352.
- Meinhof, Carl. 1932. *Introduction to the phonology of the Bantu languages*. Berlin: Dietrich Reimer.
- Ní Chiosáin, Máire & Jaye Padgett. 2001. Markedness, segment realization, and locality in spreading. In Linda Lombardi (ed.), *Segmental phonology in Optimality Theory*, 118–156. Cambridge: Cambridge University Press.
- Ohala, John J. 1978. Southern Bantu vs. the world: The case of palatalization of labials. *Berkeley Linguistics Society* 4. 370–386.
- Ohala, John J. 1981. The listener as a source of sound change. In Roberta A. Hendrick, Carrie S. Masek & Mary Prances Miller (eds.), *Papers from the Parasession on Language and Behavior, 17th Annual Regional Meeting, Chicago Linguistic Society*, 178–203. Chicago: Chicago Linguistic Society.
- Ohala, John J. 1990. There is no interface between phonology and phonetics: A personal view. *Journal of Phonetics* 18. 153–171.
- Ohala, John J. 2004. Phonetic explanations for sound patterns: Implications of grammars of competence. In William J. Hardcastle & Janet Mackenzie Beck (eds.), *A figure of speech: A Festschrift for John Laver*, 23–50. Mahwah, NJ.: Lawrence Erlbaum Associates Inc.
- Steriade, Donca. 2008. The phonology of perceptibility effects: The P-map and its consequences for constraint organization. In Kristin Hanson & Sharon Inkelas (eds.), *The nature of the word*, 151–179. Cambridge: MIT Press.
- Stevens, Kenneth N., Samuel J. Keyser & Haruko Kawasaki. 1986. Toward a phonetic and phonological investigation of redundant features. In Perkell & Klatt (eds.), *Symposium on Invariance and Variability of Speech Processes*, 426–463. Hillsdale, NJ: Lawrence Erlbaum.





## Chapter 4

# Liquid realization in Rutooro

Lee Bickmore

University at Albany, SUNY & University of the Free State

This paper provides a description and analysis of the distribution of the liquids [r] and [l] in Rutooro (E.12), a Ugandan Bantu language. The allophone that appears is conditioned by the backness of both the preceding and following vowel. Assuming /r/ is underlying, it changes to [l] in contexts when the preceding vowel is back and the following vowel is front. A systematic set of apparent surface counter-examples, leading to phrasal minimal pairs, are argued to be the result of the rule applying twice – both lexically and post lexically, where a separate post-lexical rule of vowel deletion is responsible for the opacity.

## 1 Introduction

Rutooro (E/J.12) is a Bantu language spoken by roughly a half million speakers in western Uganda. Other closely related languages in the “Nyoooro/Ganda” group include: Luganda, Runyankore, Ruciga, Nyoooro, Soga, and Gwere. Previous work on the language includes a dictionary (Kaji 2007) a brief article on the tone (Kaji 2008), and a Runyoooro-Rutooro grammar (Rubongoya 1999). The data presented in this paper were collected from Barbara Balinda, a 26 year old native speaker from Fort Portal, currently residing in Albany, NY.

The goal of this paper is to describe and analyze the distribution of liquid consonants in Rutooro. It will be argued that the lateral [l], the flap [ɾ], and the trilled [r] are all allophones of a single underlying sound. While the realization of the trill is fairly straightforward to characterize, the complementary distribution between the lateral and flap is much more complex, and is the focus of this study. First, the distribution of these two allophones within single words is such that it is not immediately obvious which should be characterized as the elsewhere case and therefore chosen to be basic. Only after examining liquid realization



within phrases is it evident which of these must be posited as underlying. Second, whichever is chosen to be basic, the derivation of the other must include information about both the preceding and following vowels. Third, given the triggering environment, it does not appear that this process can be considered one of assimilation. Finally, while Kaji (2008) provides a solid description of the complementary distribution among these three allophones (completely consistent with what I found), it is based solely on word-level data. This study significantly expands our understanding of the realization of these sounds by considering phrasal data. Accounting for this allophony in a rule-based approach, it will be argued that the rule affecting a change in [lateral] actually has two chances to apply: once at the word level and again at the phrasal level. This cyclic-type ordering actually leads to phrasal minimal pairs involving the two liquids, even though they are not underlyingly contrastive.

## 2 Distribution of liquid consonants

### 2.1 Liquid realization at the word level

Phonetically, there are three liquid consonants in Rutooro: the lateral [l], the flap [ɾ] and the trilled [r], all in complementary distribution. (The articulation of the [r], while a trill in the speech of some Rutooro speakers, is realized as an alveolar approximate in that of others.) The practical orthography of the language represents the liquid as ⟨l⟩, the flap as ⟨r⟩ and the trill as ⟨rr⟩. I will use this more orthographic representation of these three sounds from here forward. In addition, while I will suggest below that it is not in fact immediately obvious whether the underlying segment should be posited as /l/ or /r/, evidence discussed later suggests it should be /r/. I assume that here and will defend it in §2.3.<sup>1</sup>

The trilled liquid is the phonetic realization of two underlying /r/s becoming adjacent due to a process that deletes a vowel (most commonly /i/) between them. This can be seen in the examples below.

- (1) a. omu-rro  
      /omu-riro/  
      c3-fire  
      ‘fire’

---

<sup>1</sup>With regard to the Rutooro transcriptions, no tone is marked. Rutooro is one of the relatively few Bantu languages where all lexical tone contrast has been lost. Synchronically, a High is predictably found on the penult of each phonological phrase.

- b. ku-rr-a  
 /ku-rir-a/  
 INF-cry-FV  
 ‘to cry’
- c. ba-kor-r-e  
 /ba-kor-ir-e/  
 3PL-work-APPL-FV  
 ‘that they work for’

I will now show that the distribution of the lateral and flap allophones of /r/ depends upon both what immediately precedes and follows the liquid. Specifically, it is the backness of any adjacent vowels which condition the distribution. The lateral is found when two conditions are met: 1) it is word-initial or preceded by a back vowel, and 2) it is followed by a front vowel. This is illustrated in the examples from nouns below (where the hyphen separates the nominal class prefix and the stem).

- (2) [l] in [+bk] — [-bk]
- |              |           |
|--------------|-----------|
| a. omu-gole  | ‘bride’   |
| b. oru-baale | ‘hail’    |
| c. e-gali    | ‘bicycle’ |
| d. eki-cooli | ‘corn’    |

- (3) [l] in [ω — [-bk]]
- |       |              |
|-------|--------------|
| leesu | ‘waistcloth’ |
|-------|--------------|

The liquid phoneme is realized as [r] when either: a) followed by a back vowel or b) preceded by a front vowel.

- (4) [r] in [+bk] — [+bk]
- |                 |           |
|-----------------|-----------|
| a. en-garo      | ‘hand’    |
| b. oru-kurato   | ‘meeting’ |
| c. aka-tuunguru | ‘onion’   |
| d. en-jora      | ‘cloth’   |
- (5) [r] in [-bk] — [+bk]
- |            |        |
|------------|--------|
| a. bendera | ‘flag’ |
|------------|--------|

- |    |             |           |
|----|-------------|-----------|
| b. | eki-bira    | ‘forest’  |
| c. | i-somero    | ‘school’  |
| d. | eki-cumbiro | ‘kitchen’ |
- (6) [r] in [<sub>ω</sub>— [+bk]
- |    |          |          |
|----|----------|----------|
| a. | raangi   | ‘color’  |
| b. | ruhanga  | ‘God’    |
| c. | rugabire | ‘sandal’ |
- (7) [r] in [-bk] — [-bk]
- |    |           |          |
|----|-----------|----------|
| a. | omu-zaire | ‘parent’ |
| b. | eki-gere  | ‘foot’   |
| c. | firimu    | ‘film’   |
| d. | omu-ceeri | ‘rice’   |

Given the distribution described and illustrated above, neither the environment where [r] is found, nor the one where [l] is found can be stated simply, i.e. without recourse to disjunction. In (8) we formulate the rule necessary if /r/ is chosen to be basic, and in (9) we formulate the rule necessary if /l/ is chosen to be basic. As can be seen both involve a disjunctive environment, requiring the use of curly brackets.

- (8) Assuming /r/ to be underlying

$$r \rightarrow l / \left\{ \begin{array}{l} \# \\ [+bk] \end{array} \right\} \text{—} [+bk]$$

- (9) Assuming /l/ to be underlying

$$l \rightarrow r / \left\{ \begin{array}{l} [-bk] \text{—} \\ \text{—} [+bk] \end{array} \right\}$$

While neither the distribution of [l], nor [r] is easily identified as the “elsewhere” case, we will see evidence later which favors the choice of /r/ as the phoneme. Until then, as noted above, I will assume /r/ in the discussion which follows.

The forms in (2–6) show the realization of the liquid in contexts where the liquid is tautomorphemic with the surrounding vowels. That this allophonic variation can in fact result in morphological alternations is shown in the examples below:

- (10) Verb roots ending Back Vowel + /r/
- |               |                     |
|---------------|---------------------|
| a. ku-har-a   | ‘to scratch’        |
| b. ba-hal-e   | ‘that they scratch’ |
| c. ku-zoor-a  | ‘to find’           |
| d. ba-zool-e  | ‘that they find’    |
| e. ku-sasur-a | ‘to pay’            |
| f. ba-sasul-e | ‘that they pay’     |

- (11) Alternations in class 5 nominal prefix /ri-/
- |                |                    |
|----------------|--------------------|
| a. e-ri-ino    | ‘tooth’            |
| b. li-ino      | ‘it is a tooth’    |
| c. e-ri-iso    | ‘eye’              |
| d. li-iso      | ‘it is an eye’     |
| e. e-rii-ndazi | ‘doughnut’         |
| f. lii-ndazi   | ‘it is a doughnut’ |

In (10) it can be seen that the root-final liquid, preceded by a [+back] vowel, surfaces as [r] before the [+back] default Final Vowel /-a/ (cf. 4), but as [l] before the [-back] subjunctive Final Vowel /-e/ (cf. 2). In (11) the liquid of the Class 5 noun prefix surfaces as [r] when preceded by the [-back] preprefix /e-/ (cf. 7), but as [l], when no preprefix precedes (cf. 3), signaling the copulative meaning.

Below, it is shown that [back] value of glides is equally relevant in the determination of the distribution of the liquid allophones.

- (12) Effect of glides
- |                 |                      |                |
|-----------------|----------------------|----------------|
| a. ba-sasul-e   | ‘that they pay’      | /ba-sasur-e/   |
| b. ba-sasur-w-e | ‘that they be paid’  | /ba-sasur-u-e/ |
| c. ba-zool-e    | ‘that they find’     | /ba-zoor-e/    |
| d. ba-zoor-w-e  | ‘that they be found’ | /ba-zoor-u-e/  |
| e. ku-gi-ry-a   | ‘to eat them (C4)’   | /ku-gi-ri-a/   |
| f. ku-ly-a      | ‘to eat’             | /ku-ri-a/      |
| g. e-ry-aato    | ‘boat’               | /e-ri-ato/     |
| h. ly-aato      | ‘it is a boat’       | /ri-ato/       |

The examples in (12a–12d) show that the glide [w] acts as a [+back] segment in triggering the realization of this liquid phoneme. As the liquid is surrounded by two [+back] vocoids in those cases, it surfaces as [r]. The examples in (12e–12h) show that the glide [y] acts as a [–back] segment in this regard. Since the liquid is word-initial and followed by a [–back] vocoid in those cases, it surfaces as [l]

## 2.2 Liquids realization at the phrase level

Having established the environments that [l] and [r] appear in at the level of the word, let us now turn to phrases. First we consider the short phrases in (13–15).

- (13) ku-leet-a      li-nu  
      INF-bring-FV C5-DEM  
      ‘to bring this one (C5)’

- (14) ba-leet-e      li-nu  
      3PL-bring-SUBJ C5-DEM  
      ‘that they bring this one (C5)’

- (15) e-ki-sani      li-ino  
      IV-C7-drawing C5-tooth  
      ‘the drawing is a tooth’

In (13–15) the word-initial (but phrase-medial) Class 5 noun prefix in each case is realized as [l]. We saw this in (15) and (11b, d, f) where the liquid was followed by a [–back] vowel but not preceded by any sound (being both word and phrase-initial in those cases). However, we have also seen that when the liquid is both preceded by and followed by [–back] vowels, as in (7) and (11a, c, e), it is realized as [r]. We conclude from the examples in (13–15) that it is not possible to simply say that the domain of application of the  $r \rightarrow l$  rule in (8) is the phrase (with no regard to word boundaries) as such would ungrammatically predict the realization of [r] in these cases. One way to account for these facts is to posit the  $r \rightarrow l$  rule in (8) as a word-level process, taking place before any post-lexical rules.

Before investigating liquid resolution in additional phrasal contexts, we must first examine a process of vowel deletion that operates across words. As seen in the phrasal data below, a [–hi] vowel at the end of a word deletes before a following word-initial vowel, with a compensatory lengthening of that second vowel.

- (16) a. ku-leet        oo-muu-ntu  
       /ku-leet-a    o-mu-ntu/  
       INF-bring-FV IV-C1-person  
       ‘to bring the person’
- b. ku-som        ee-ki-tabu  
       /ku-som-a    e-ki-tabu/  
       INF-read-FV IV-C7-book  
       ‘to read the book’
- c. ba-han        aa-baa-ntu  
       /ba-han-e     a-ba-ntu/  
       3PL-advise-SUBJ IV-C2-people  
       ‘that they advise people’

The rule accounting for this is formalized below:

- (17) Vowel Deletion  

$$V \rightarrow \emptyset / \text{---}]_{\omega} \omega [ V$$
 [-hi]

Given, this process we can now examine some additional phrases that are relevant to our understanding of liquid realization, namely those where an underlying liquid precedes a word-final vowel that will be deleted by the rule in (17). First let us examine the case where the vowel preceding the liquid is [-back], and the first vowel of the following word is [+back]

- (18) a. ba-zool        oo-muu-ntu  
       /ba-zoor-e    o-mu-ntu/  
       3PL-find-SUBJ IV-C1-person  
       ‘that they find the person’
- b. ba-zool        aa-baa-ntu  
       /ba-zoor-e    a-ba-ntu/  
       3PL-find-SUBJ IV-C2-person  
       ‘that they find the people’
- c. a-ka-tal        aa-ko  
       /a-ka-tare    a-ko/  
       IV-C13-market IV-DEM.13  
       ‘this market’

- d. o-bu-zaal      oo-bu  
 /o-bu-zaare    o-bu/  
 IV-C14-KINSHIP IV-DEM.14  
 ‘that kinship’

In each case above the liquid is underlyingly preceded by a back vowel. While it is followed by a [-back] vowel underlyingly, due to application of Vowel Deletion, it is followed by a [+back] vowel on the surface within the phrase. As can be seen, in each case the liquid is realized as [l]. Here again, if we were to assume that liquid realization is a phrase-level process that occurs after Vowel Deletion, we would incorrectly predict that the liquid should surface as [r], as it did in (4) between two back vowels. If, however, we consider the liquid realization rule to take place at the word level, we directly account for the patterns in (18), as we did in (16). This is illustrated in the derivation below of (18a), where Vowel Deletion counterbleeds the r→l rule.

- (19) /ba-zoor-e o-mu-ntu/      UR  
 ba-zool-e o-mu-ntu      r → l (word-level)  
 ba-zool oo-mu-ntu      V-Deletion (phrase-level)

Finally, let us examine the case where the vowel preceding the liquid is [+back], the word-final vowel after it is [-back], and the following word begins with a [+back] vowel.

- (20) a. ku-zool      ee-bi-tabu  
 /ku-zool-a e-bi-tabu  
 INF-find-FV IV-C8-book  
 ‘to find the books’  
 b. ku-hal      ee-bii-ntu  
 /ku-har-a e-bi-ntu/  
 INF-scratch-FV IV-C8-thing  
 ‘to scratch the things’  
 c. e-ky-aal      ee-ki  
 /e-ki-ara e-ki/  
 IV-C7-finger IV-DEM.7  
 ‘that finger’



- d. e-ki-kool ee-ki  
 /e-ki-koora e-ki/  
 IV-C7-dry.leaf IV-DEM.7  
 ‘that dry leaf’

In each case above the liquid is realized as [l]. Yet, this is unexpected given our current analysis. If the  $r \rightarrow l$  rule applies at the level of the word, we would expect it not to apply in these cases since the liquid within the word is both preceded and followed by a [+back] vowel, an environment where [r] is attested (cf. 4). In order to account for the realization of the liquid as the lateral in these phrases, we must assume that the  $r \rightarrow l$  rule applies *after* Vowel Deletion, as it must be fed by it. This is shown in the derivation below of (20a).

- (21) /ku-zoor-a e-bi-tabu/ UR  
 ku-zoor ee-bii-tabu V-Deletion (phrase-level)  
 ku-zool ee-bii-tabu  $r \rightarrow l$  (phrase-level)

Yet, if the  $r \rightarrow l$  rule is only a phrase-level one, it will fail to account for phrases such as the ones in (13–18), as detailed above. Within this rule-based derivational framework, one way to account for all of the phrases examined here is to posit the  $r \rightarrow l$  rule as *both* a word-level, as well as a post-lexical phrasal process. In crude terms, under this analysis an underling /r/ has two chances to become [l]: first if the structural description of the process is met within the word, and again if the structural description is met at the level of the phrase, after vowel deletion.

Next, it is interesting to note that while [r] and [l] are allophonic variations of a single phoneme in Rutooro, their complex realization patterns can actually lead to minimal pairs at the phrase level. This is shown below.

- (22) tu-bal aa-maa-ndazi  
 /tu-bar-e a-ma-ndazi/  
 1PL-count-SUBJ IV-C6-donut  
 ‘let’s count the donuts’

- (23) tu-bar-a a-maa-ndazi  
 /tu-bar-a a-ma-ndazi/  
 1PL-count-FV IV-C6-donut  
 ‘we count donuts (Habit)’

The example in (22) is in the Subjunctive which is formed by adding the suffix /-e/ onto the verb. The  $r \rightarrow l$  rule will apply at the level of the word as its structural description is met there. Vowel Deletion will eliminate the /-e/ resulting in a

compensatorily lengthened [aa] after the liquid. The example in (23) is in the Habitual which is formed by adding the default Final Vowel /-a/ onto the verb. The  $r \rightarrow l$  rule will not apply at the level of the word as the /l/ is both preceded and followed by a [+back] vowel. This remains true at the phrasal level as well, and thus the liquid is realized as [r]. Thus, even though these two phrases are minimal pairs, differing only in distinct realizations of [r] and [l], it is not evidence of an underlying contrast between these two sounds, as has been carefully shown throughout this paper.

### 2.3 Evidence for /r/

Having now considered all of these phrases, let us return to the question as to whether it would be equally plausible to set up the liquid as underlyingly /l/. In (13–18), one could assume the  $l \rightarrow r$  rule formalized in (9) would be applicable only at the level of the word. At that level it would not apply to a form such as /ba-zool-e o-mu-ntu/ (18a) since a [+back] vowel precedes the liquid and a [-back] vowel follows. Vowel Deletion would yield ba-zool oo-mu-ntu (the correct phonetic output). The structural description of the  $l \rightarrow r$  is now met, but we must prevent the rule from applying, as it would incorrectly predict the liquid should surface as [r]. We would therefore be forced to posit that the rule only applies at the word level, and not the phrasal one.

Under the /l/ analysis, the UR of (21) would be /ku-zool-a e-bi-tabu/. The structural description of the  $l \rightarrow r$  rule is met at the level of the word as the /l/ is followed by a [+back] vowel, yielding: *ku-zoor-a e-bi-tabu*. Vowel deletion would apply at the phrase level, producing the ungrammatical \**ku-zoor ee-bi-tabu* (whereas the grammatical output is [ku-zool ee-bi-tabu]). This, then, is evidence that under this rule-based account, the liquid must be set up underlyingly as /r/, and not /l/.

One final note on the allomorphy involving liquids should be noted here. As in many Bantu languages, the liquid(s) in Rutooro also alternate with /d/, the latter allophone appearing only after a nasal. Relevant Rutooro forms are given in (24), and the rule to account for this in (25).

- (24) a. ku-ras-a  
       INF-shoot-FV  
       ‘to shoot’  
       b. kuu-n-das-a  
       INF-1SG-shoot-FV  
       ‘to shoot me’

(25)  $r \rightarrow d / [+nas] \_$

The analysis proposed in this paper posits /r/ as the phoneme, with the  $r \rightarrow l$  rule in (8) and the fortition rule in (25). (It is not clear whether the existence of the trilled-*r* requires a third allophonic rule or is simply what happens to a geminate [rr] in the phonetic implementation component.) If one were to posit /d/ as the underlying segment, then both a  $d \rightarrow l$  rule (with the environment found in 8) as well as a  $d \rightarrow r$  rule (with the environment found in 9) would be required. I would submit that the /r/ analysis is to be preferred over a /d/ one since the rule in (25) is less complex, not having the disjunctive environment found within the rule in (9).

### 3 Character of rule

The last point of discussion concerns the character of the rule itself. The first point to be made is that liquid realization in Rutooro does not fall among the vast class of rules which are triggered by a single adjacent segment. We have provided ample justification above that this allophony is dependent on the backness of both the preceding and following vowels. Second, one can ask whether this process is one of assimilation. I would submit that there is no evidence to support that. In the distinctive feature model, the structural change of this process involves a single feature, [lateral], but what conditions the change is not [lateral] but [back]. Even from a more phonetic perspective, while one might be able to argue that in some language one of the liquids has a somewhat more fronted or backed realization vis-à-vis the other liquid, in Rutooro such a motivation seems impossible, since the allophone [r] is realized *both* in the most back context (i.e. between two [+back] vowels) as well as the most front context (i.e. between two [-back] vowels). Even saying that the lateral is phonetically motivated as a result of some kind of “transition,” from the tongue being more back and moving to the front is problematic, since the [l] also occurs word-initially before back vowels, where arguably no transition is involved. In summary, it seems that while canonical cases of allophonic variation are both postlexical and assimilatory in nature, liquid realization in Rutooro is neither – being required to apply at the word (lexical) level and involving changing one feature ([lateral]) due to the presence of a very different one ([back]).

## Abbreviations

APPL	Applicative	INF	Infinitive
C#	Class(Number)	IV	Initial Vowel
DEM	Demonstrative	SUBJ	Subjunctive
FV	Final Vowel		

## References

- Kaji, Shigeki. 2007. *A Rutooro vocabulary*. Tokyo: Research Institute for Languages, Cultures of Asia & Africa.
- Kaji, Shigeki. 2008. Tone and syntax in Rutooro, a toneless Bantu language of Western Uganda. *Language Sciences* 31(2009). 239–247.
- Rubongoya, L. T. 1999. *Modern Runyoro-Rutooro grammar*. Köln: Rüdiger Köppe Verlag.

## Chapter 5

# Tumbuka prosody: Between tone and stress

Laura Downing

University of Gothenburg

Tumbuka is spoken in the northern Lake Malawi region where it is typical for Bantu languages to have what has been called a restricted tone system: all words must have a High tone. This kind of prosodic system has stress-like properties, and functions similar to Kisseberth & Odden (2003). Vail (1972) suggests that Tumbuka is a purely stress language. This paper argues, in contrast, that because Tumbuka High tone realization has tone-like properties, as defined in Hyman (2006; 2009; 2012; 2014), as well as stress-like properties, it cannot be considered a canonical stress language. It is proposed that the synchronic Tumbuka prosodic system evolved from one where contrastive High tone takes a phrasal domain through processes – formalizable as an OT factorial typology – which made phrasal prosody more transparently predictable by eliminating most tonal contrasts.

## 1 Introduction

Since McCawley (1978) observed that the tone systems of Proto-Bantu and many synchronic Bantu languages have both tonal and accentual – i.e., stress-like – qualities, a tradition of research has investigated where the prosodic systems of particular languages fit on a typological continuum from more tonal to more stress-like. One goal of this research is to determine what properties define the two types of prosodic systems. As it is assumed that the direction of change in Bantu prosody has been from Proto-Bantu's more tonal system to a more stress-like one, another research goal is to determine what systemic factors favor the change from a more canonical tonal to a more stress-like tonal system. (See Clements & Goldsmith 1984; Hyman 2006; Odden 1999). As Gussenhoven (2006) ob-



serves, in pursuing both goals, it is the languages that lie between tone and stress that prove most instructive.

This paper takes as case study an analysis of the prosodic system of Tumbuka (N.20), where tone realization is mostly predictable, except in the substantial ideophonic lexicon. After presenting a sketch of Tumbuka prosody in §2, §3 shows that Tumbuka tonal distribution has both tonal and stress-like properties, as defined in Hyman (2012; 2014). That is, its prosodic system lies between tone and stress. §4 takes up the question of how Tumbuka's phrasal tone system fits into a historical scenario linking it to the more canonically tonal Proto-Bantu system. It is proposed that phrasal High tone realization is the triggering factor leading to loss of tonal contrasts. §5 concludes the paper.

## 2 Sketch of Tumbuka prosody

Tumbuka (Bantu N.21) is one of the three national languages of Malawi (with Chichewa N.31 and Yao P.21). The data presented come from my fieldwork on the language. (There is no grammar of the language, as far as I know, though there are some dissertation-length studies: e.g., Chavula (2016), Mphande (1989), and Vail (1972).)

### 2.1 Words in isolation – non-ideophones

As shown by the data in (1) and (2), cited from Downing (2008); Downing (2012), there are no lexical or grammatical tonal contrasts in the non-ideophonic lexicon of Tumbuka. (We turn to ideophones in §2.3, below.) Vowel length is also not contrastive: the penult of every word in isolation is lengthened and its first half bears a High tone:

(1) No tonal contrasts in nouns

Singular	Gloss	Plural
a. múu-nthu	'person'	wáa-nthu
b. m-líimi	'farmer'	wá-líimi
c. m-zíinga < *-dìngà	'bee hive'	mi-zíinga
d. m-síika	'market'	mi-síika
e. khúuni < *-kúni	'tree'	ma-kúuni
f. báanja	'family'	ma-báanja
g. ci-páaso	'fruit'	vi-páaso

h. ci-ndíindi	‘secret’	vi-ndíindi
i. nyáama < *-nyàmà	‘meat, animal’	nyáama
j. mbúuzi < *-búdi	‘goat’	mbúuzi

(2) No tonal contrasts in verbs or verb paradigms

a. ku-líima < *dim-	‘to farm’
ti-ku-líima	‘we farm’
ti-ka-líima	‘we farmed’
t-angu-líima	‘we recently farmed’
n-a-ŵa-limíira	‘I have farmed for them’
ŵ-a-líima	‘they have farmed’
wa-zamu-líima	‘s/he will farm’
b. ku-zéenga < *jèng-	‘to build’ zéenga! ‘build!’
ti-ku-zéenga	‘we build’
ti-ku-zéenga	‘we build’
nyúumba yi-ku-zengéeka	‘the house is being built’
ŵa-ka-zéenga	‘they built’
ŵa-ka-ku-zengéera	‘they built for you sg.’
ŵa-ka-mu-zengeráa-ni	‘they built for you pl.’
n-a-zéenga	‘I have built’
wa-zamu-zéenga	‘s/he will build’
ŵa-zamu-zengeráana	‘they will build for each other’

To put these Tumbuka prosodic patterns into a wider perspective, penult lengthening (especially phrase-penult), is considered a correlate of stress and is very common cross-Bantu (see, e.g., Doke 1954; Downing 2010b; Hyman 2013; Philippson 1998). It is also very common cross-Bantu for contrastive High tones to be attracted to the penult (see, e.g., Kisseberth & Odden 2003; Philippson 1998). And it is attested (though it is not clear how widespread this is) for other languages of the northern Lake Malawi region to have what have been called restricted or predictable tone systems: all words must have a High tone (Odden 1988; 1999; Schadeberg 1973). For example, Odden (1988) characterizes HiBena (a Bantu language spoken in SW Tanzania) as having a predictable tone system because every noun must have a High tone, realized on either the penult or the pre-stem vowel, and most verb forms require a High tone on the penult:

(3) HiBena (Odden 1988: 236)

a. *Nouns*

mú-goosi	‘man’
hí-fuva	‘chest’
mu-guúnda	‘field’
lu-fwíili	‘hair’
li-fulúha	‘cloud’

b. *Verbs*

kwaamíle	‘put to pasture’(subjunctive)
ndi-líma	‘I will cultivate’(near-future)
ndaa-limága	‘I used to cultivate’
ndaa-limiíge	‘I was cultivating’
ndihaa-limíle	‘I cultivated’ (intermediate past)
ndaa-limíle	‘I cultivated’ (far past)
hu-limíla	‘to cultivate for’

Is Tumbuka, then, another predictable tone language?

## 2.2 Tumbuka phrasal prosody

Tumbuka words have the isolation pronunciation illustrated in (1) and (2) only when they are final in a phrasal domain. That is, penult lengthening and a High tone on the initial mora of the lengthened penult are phrase-level properties, not word-level ones, as only some words in a sentence have this prosody. (See Gordon 2014 for recent discussion of the issue of disentangling word-level from phrase-level prosody.) Evidence that the relevant prosodic domain is the Phonological Phrase is that, as Downing (2006; 2008; 2010a; 2012; 2017) shows, neutral prosodic phrasing in Tumbuka is conditioned by the right edge of NP. Subject NPs and Topics are phrased separately from the rest of the clause. A verb plus its first complement form a single phrase, and following complements are generally phrased separately:

(4) Tumbuka prosodic phrasing (parentheses indicate phrasing)

- a. (ti-ku-phika síima)  
we-TAM-cook 9.porridge  
‘We are cooking porridge.’



- b. (ŵ-áana) (ŵa-ku-ŵa-vwira ŵa-bwéezi)  
 2-child 2SBJ-TAM-2.OBJ-help 2-friend  
 ‘The children help the friends.’
- c. (ti-ka-wona mu-nkhúungu) ku-msíika).  
 we-TAM-see 1-thief LOC-3.market  
 ‘We saw a thief at the market.’
- d. (m-nyamáata) (wa-ka-timba nyúumba) (na líibwe).  
 1-boy 1-TAM-hit 9.house with 5.rock  
 ‘The boy hit a house with a rock.’
- e. (ŵa-líimi) (ŵa-luta ku-múunda)  
 2-farmer 2-go LOC-fields  
 ‘The farmers have gone to the fields.’

In short, in the non-ideophonic vocabulary, tone is predictable and non-contrastive. Instead, it could be considered a correlate of phrasal stress – that is, intonational level pitch-accent – as High tones consistently occur on the first mora of penult syllables that are lengthened as another correlate of phrasal stress. (See Downing 2017 for detailed discussion of Tumbuka intonation.) For these reasons, Kisseberth & Odden (2003) and Vail (1972) classify Tumbuka as a stress language, suggesting that it has lost all Proto-Bantu tonal contrasts.

### 2.3 Tone is contrastive in ideophones

Even though it is true for much of the Tumbuka lexicon that High tone is analyzable as a predictable correlate of phrasal stress, it is not true that High tone is entirely predictable because tone is contrastive in the ideophonic lexicon. This has been extensively documented by Mphande (1989), Mphande & Rice (1995), and Vail (1972).

A couple of the minimal pairs listed in Vail’s and Mphande’s work that I have re-elicited in sentences are cited in (5). Notice that while ideophones are restricted to occur in phrase-final position – the position where we find predictable High tone on non-ideophonic words – the tone of ideophones is not predictable. As illustrated by the data below, we find contrastively level High and Low-tones on the ideophones, rather than the predictable pattern of a falling tone over a lengthened penult:

(5) Contrastive tone in Tumbuka ideophones (Downing elicitation notes); ideophones underlined>

- a. (Ku-díindi ) (ku-ka-βa yíi ) (sóno ni-la na wóofi)  
 Loc-cemetery LocSBJ-TAM-be IDEO so I-was with fear

‘At the cemetery it was deserted-quiet, so I got scared.’

*cf. tonal minimal pair:*

- b. (Ntcheŵe yíithu) (yi-ka-tchimbirira ku-ma-kúuni)  
 9.dog 9.our 9SBJ-TAM-ran.to Loc-4-wood

(Namiise) (ti-ka-ŵona kuti yi-kwiza yáayi)  
 Evening we-TAM-see that 9SBJ-come not

(Yi-li ku-zyeβa yìi)  
 9SUBJ-BE INF-Lost IDEO

‘Our dog ran into the woods. In the evening we saw that it was not coming. It got lost completely.’

- c. (Jéeni ) (wa-ku-líira. ) (Maso yáake) (ya-li cèè)  
 1.Jane 1SUBJ-TAM-cry 4.eye 4.her 4.SBJ-COP IDEO

‘Jane is crying. Her eyes are red.’

*cf. near minimal pair:*

- d. (ŵa-ka-mu-kora mu-nkhúungu) (wa-kw-iβa ngóoma )  
 2SBJ-TAM-1OBJ-catch 1-thief 1SBJ-TAM-steal 10.maize

(zúuβa) (li-li ngéé)  
 5.sun 5SUBJ-COP IDEO

‘They caught the thief stealing maize in broad daylight.’

While the ideophones in (5) are monosyllabic, Mphande (1989) amply demonstrates that ideophones can be longer and can have any combination of High and Low tones. Note that vowel length is also contrastive:

(6) Sample Tumbuka ideophones (Mphande (1989: 154-155))

- |         |                                       |
|---------|---------------------------------------|
| a. khùù | ‘blowing of wind’                     |
| b. mwàà | ‘of being scattered like sand’        |
| c. yíi  | ‘of absolute silence or desertedness’ |
| d. bí   | ‘of being very dirty’                 |
| e. pípí | ‘of pungent smell’                    |
| f. bulí | ‘appearing suddenly’                  |

g. wunjí	‘of being gathered together’
h. khwapú	‘of a trap suddenly released’
i. zotó	‘of hitting and denting a surface’
j. chwúbí	‘of plunging into a liquid’
k. lóólii	‘of staring stupidly’
l. kóti	‘of stopping weakly’
m. gáli	‘of sudden flash of light’
n. lípwíiti	‘of being completely non-stiff’
o. nyujumu	‘of sneaking away unnoticed’
p. vyálakáta	‘of sitting down in an exhausted way’
q. thélelele	‘of sliding off a slippery surface’
r. kíkíkí	‘of laughing in a shrill [way]’

It is important to point out that ideophones form a large subset of the lexicon: Mphande (1989)’s study investigates the grammatical properties of some 500 Tumbuka ideophones. As we can see from the examples above, the ideophones are not simply onomatopoeic words, though most do have some kind of depictive quality, said to be typical of ideophones (Dingemans 2012). This number and range of functions are typical: Childs (1994: 179) shows that ideophones make up a large and productive part of the lexicon in many African languages. They therefore cannot be considered a marginal part of the language.

To sum up this section, the fact that contrastive tone is characteristic of the substantial ideophonic lexicon makes it misleading to characterize Tumbuka as a purely stress language, as Kisseberth & Odden (2003) and Vail (1972) do.

### 3 Evaluating Tumbuka prosodic properties

Hyman (2009; 2012; 2014) argues, in fact, that it is a misleading shortcut in general to classify languages in terms of monolithic categories like stress language or tone language. He develops a property-driven approach to prosodic typology, which has the goal of characterizing the “same and different ways that *individual properties* are exploited within phonological systems.” I show in this section how this approach allows us to define precisely which canonical stress and tone properties are exploited in the Tumbuka prosodic system.

### 3.1 Stress-like properties

In order to evaluate the stress-like and tone-like properties of the Tumbuka prosodic system, one first needs to adopt an explicit set of canonical properties. I begin by evaluating the stress-like properties of Tumbuka prosody, adopting Hyman's (2012; 2014) definition of a canonical stress system, cited below. Properties a. and b. are proposed to be definitional of stress systems:

- (7) Canonical stress properties (Hyman 2014: 61)
- a. obligatory: all words have a primary stress
  - b. culminative: no words should have more than one primary stress
  - c. predictable: stress should be predictable by rule
  - d. autonomous: stress should be predictable without grammatical information
  - e. demarcative: stress should be calculated from the word edge
  - f. edge-adjacent: stress should be edge-adjacent (initial, final)
  - g. non-moraic: stress should be weight-insensitive
  - h. privative: there should be no secondary stresses
  - i. audible: there should be phonetic cues of the primary stress

To put Tumbuka in perspective, I evaluate its canonical stress properties in parallel with those of Swahili and English in the table in Table 1. I assume that readers of this article are familiar with the English stress system. Swahili is another Bantu language, and the prosody of words in isolation is very similar to that of Tumbuka. Words have a lengthened penult vowel, realized with falling intonation: see (8a) – (d). However, unlike Tumbuka, words in phrase-medial position also have lengthened penults and, often, a High tone – see (e) and (f):

- (8) Swahili stress prosody (Ashton 1947: 5; Mohamed 2001: 14; Polomé 1967)
- |                              |                              |
|------------------------------|------------------------------|
| a. nê:nda                    | 'go!'                        |
| b. ni-ta-ku-pî:ga            | 'I shall hit you'            |
| c. jî:ko                     | 'kitchen'                    |
| d. jîkô:ni                   | 'in the kitchen'             |
| e. sí:na hakî:ka             | 'I am not sure.'             |
| f. kija:na anau:mwa kidô:go. | 'The youth is a bit unwell.' |

Table 1: Stress-like distribution of High tones in Tumbuka?

Property	Tumbuka		Swahili	English
	word level	phrase level	word level	word level
obligatory		√	√	√
culminative		?	√	√
predictable		√	√	
autonomous			√	
demarcative		√	√	√
edge-adjacent		penult	penult	
non-moraic		√	√	
privative		?	√	
audible		√	√	√

As we can see in the table in Table 1, since the potential correlates of stress – High tone along with penult lengthening – are phrase level properties, Tumbuka actually has no word level stress properties:

Recall that the canonical, defining property for a stress system is that all (phonological) words should be stressed. Tumbuka thus contrasts with Swahili, which has a perfect canonical stress system. Surprisingly, as Hyman (2014) demonstrates, even though stress is a central phonological property of English, the stress system of English is far from canonical.

In sum, even though High tones have a stress-like distribution, the fact that stress correlates like High tone and penult lengthening are only phrase-level properties makes Tumbuka a non-canonical stress language, since stress is by definition a word-level property.

### 3.2 Tone-like properties of the Tumbuka prosodic system

Hyman (2006: 229), citing Welmers (1959; 1973), defines the following canonical property of a tone language:

- (9) A language with tone is one in which an indication of pitch enters into the lexical realization of at least some morphemes.

Even though High tone is a predictable correlate of non-ideophonic words in a position to be assigned phrasal stress, Tumbuka still satisfies this definition

of a tone language because, as we saw in §2.3, above, tone is contrastive in the substantial ideophonic lexicon.

While ideophones often have special phonology (Newman 2001, Dingemans 2012), this is no reason to dismiss them as the kind of morpheme that can provide evidence that Tumbuka prosody has some tonal properties. As Newman (2001) argues, the special phonology of ideophones can only be considered to ‘stretch’ the grammar of the prosaic language; it does not disregard it. Recent work by Shih & Inkelas (2015) on Mende tone patterns, for example, shows that ideophones in that language “operate within fairly conservative parameters of the overall Mende tonotactics grammar.” Echoing this viewpoint, Dingemans’s (2012:657) recent survey article concludes: “...if ideophones flout the rules, it is in orderly ways. They form a coherent system of their own, building on the regular system but orthogonal to it.” Indeed, Mphande (1989) argues that contrastive tone in one area of the Tumbuka grammar (ideophones) is more likely if tone is active in the phonology in general. In stress languages like Swahili, for example, it is not reported that ideophones have contrastive tone (Ashton 1947: 313ff; Lodhi 2004).

As Sharon Rose and Thilo Schadeberg (p.c.) point out, it is not surprising that the ideophonic lexicon is the area of the Tumbuka lexicon that preserves Proto-Bantu tonal contrasts. Ideophones typically must be pronounced with a particular prosody. Furthermore, in all the data I have collected, ideophones always come in phrase-final position, the position of phrasal stress where tone contrasts might be expected to be protected from neutralization. (See work like Beckman (1997), Harris (2004) and Steriade (1995), and references therein, on the correlation between stressed position and the realization of phonemic contrasts.) We return to these points in the next section

To sum up, while Tumbuka’s prosodic system uncontroversially has tonal properties – e.g. contrastive tone in the substantial ideophonic lexicon – Tumbuka is certainly a non-canonical tone language because only the ideophonic lexicon exhibits tonal contrasts. Elsewhere, High tone is a predictable correlate of phrasal stress. Since stress is a phrasal property of Tumbuka, not a lexical one, this aspect of its prosodic system is also non-canonical: stress is canonically a property of words, not just of phrase-level phonology (Hyman 2012, 2014, though see Gordon 2014).

## 4 The path to Tumbuka's prosodic system

The question naturally arises of how Tumbuka's prosodic system might have developed from Proto-Bantu's more canonically tonal one, reconstructed with a two-tone contrast (H vs.  $\emptyset$ ) for all lexical morphemes (Meeussen 1967). The analysis builds on the observation that, in a number of synchronic Bantu tone systems High tones surface on or near the stressed phrase penult syllable, whatever their input position. (See e.g., McCawley 1978; Clements & Goldsmith 1984; Philippson 1998; Kisseberth & Odden 2003; Downing 2010b.) What I propose is that phrasal tone realization can lead to a loss of tonal contrasts because the input source of the High tone becomes ambiguous when High tone realization takes a phrasal domain.

The first step in the development of a Tumbuka-like prosodic system from Proto-Bantu could be a language like Digo (Bantu E.73; Kisseberth 1984). If a verb word contains a single High tone, it surfaces on the (stressed) penult syllable, no matter which syllable in the word sponsors the High tone. These generalizations are illustrated in (10) with verbs in the *-na-* tense-aspect; the form of the verbs is SBJ-*na*-STEM:<sup>1</sup>

- (10) Digo High tone shift to penult of a toneless verb stem (Kisseberth 1984: 112, fig. (12)); underlyingly High-toned subject prefix is underlined
- |    |                     |                         |
|----|---------------------|-------------------------|
| a. | a-na-vuguúrâ        | 's/he is untying'       |
|    | cf. ni-na-vuguura   | 'I am untying'          |
| b. | a-na-βukuúsâ        | 's/he is shelling corn' |
|    | cf. ni-na-βukuusa   | 'I am shelling corn'    |
| c. | a-na-ramuúkâ        | 's/he is waking up'     |
|    | cf. ni-na-ramuuka   | 'I am waking up'        |
| d. | a-na-onjerééza      | 's/he is adding to'     |
|    | cf. ni-na-onjereeza | 'I am adding to'        |
| e. | a-na-raβííza        | 's/he is insulting'     |
|    | cf. ni-na-raβiiza   | 'I am insulting'        |

---

<sup>1</sup>I follow Kisseberth (1984) in characterizing the tone pattern of Digo as illustrating attraction of a High tone to the penult, even though, as we can see, Kisseberth transcribes the resulting tone pattern as a rise-fall over the final two syllables (except when the final syllable begins with a voiced consonant). Also, note that I am simplifying other complexities of the distribution of High tones in Digo in order to highlight the similarities with the Tumbuka system.

Following work like Clements & Goldsmith (1984) and Philippson (1998), one could posit the following steps in deriving a positionally restricted tone system like that of Digo from Proto-Bantu:

- (11) Diachronic steps from Proto-Bantu to Digo
- a. Loss of Proto-Bantu vowel-length contrast; predictable penult lengthening (stress).
  - b. Pre-penult High tones are attracted to the stressed penult.
  - c. Delinking of High tones from all syllables except the penult makes the connection between the input source of the High tone and its output position of realization surface opaque.

Digo is not Tumbuka, though. In Digo, High tone is contrastive – see the verbs with first person vs. third person subject prefixes in (10), above. However, just as in Tumbuka (non-ideophonic lexicon), the *position* of realization of High tone is not contrastive: it consistently targets the penult. To account for the loss of contrastive High tone, I would like to take up Philippson’s (1998) suggestion that languages where High tones have a phrasal domain of realization hold one key to this development. Digo is such a language.

As shown by the data in (12), in Digo verb-object combinations, the High tone from one word (e.g., the verb) can be realized on the penult of the following word (e.g., a noun object). That is, the domain for High tone realization is the phrase, not the word. As a result, the same word can be realized with High tone or Low tone depending on the phrasal tonal context – cf. (12b) vs 13c). This makes it syntagmatically opaque which word contributes the High tone to the output because a verb+object phrase can have the same tone pattern whether the High tone’s source is the verb or the noun:

- (12) Digo verb+noun combinations (Kisseberth 1984: 162ff)
- a. *Low toned verb + High toned noun*

ku-saga ma-peémbâ	‘to grind maize’
ku-vugura fuúndô	‘to untie a knot’
ni-na-tsora chi-daáfû	‘I am picking a young coconut’
  - b. *High toned verb + Low toned noun*

ku-onyesa njíirâ	‘to show the way’
ku-afuna nyaámâ	‘to chew meat’
ni-na-ezeka baándâ	‘I am thatching a shed’
a-na-henza mu-gaángâ	‘s/he is looking for a doctor’



c. *Low toned verb + Low toned noun*

ku-henza mu-gaanga            ‘to look for a doctor’

ku-saga mu-haama            ‘to grind millet’

The similarity in the tone of the Digo phrases in 13a, b) with the Tumbuka verb+object phrases illustrated in (4) is striking.

I propose that the phrasal domain of tone realization in languages like Digo can lead to misanalysis of the source of the High tone, and favor reinterpreting the occurrence of High tone as predictably linked to phrase penult position rather than linked to a particular morpheme or word in the phrase. To make this idea formally concrete, in OT terms, Digo High tones satisfy a constraint optimizing associating the High tone with a phrase penult syllable:<sup>2</sup>

(13) ALIGNR(H, PHONPHRASE) (AR(H,PP)):

Align every High tone with the right edge of a Phonological Phrase.

Since input lexical contrastive High tones are maintained in the output, Faithfulness constraints on the realization of input High tones must be high-ranked:

(14) FAITH-H

- a. MAX-H: Every input High tone must have a correspondent in the output, and
- b. DEP-H: Every output High tone must have a correspondent in the input.

However, High tones are not faithfully realized in their input position. Therefore, a Faith constraint on the position of the High tones must be ranked below the alignment constraint in (13):

(15) FAITH-Pos(ITION) (F-Pos)

- a. MAX-Pos: Every input TBU must have the same High tone in the output, and
- b. DEP-Pos: Every output TBU must have the same High tone in the input.

The constraint ranking for Digo is summarized below:

---

<sup>2</sup>An additional constraint, NONFINALITY, must outrank this alignment constraint to optimize realizing the High tone on the penult. I omit this constraint from the tableaux as it is never outranked in the languages under consideration here.

(16) Ranking 1: Digo attraction of High tones to phrase penult

FAITH-H » ALIGNR(H, PHONPHRASE) » FAITH-POS

As a result of this constraint ranking, the occurrence of a High tone on a phrase final word is not predictable from the input tone of the phrase final word. This point is exemplified in (17), where a High tone contributed by the verb optimally surfaces on the penult of the following low-toned noun to satisfy the alignment constraint in (13):

(17) Digo analysis

á-na-henza mu-gaanga	FAITH-H	AR(H,PP)	F-Pos
á-na-henza mu-gaanga		*!	
☞a-na-henza mu-gaángâ			*

However, as shown in (18), the lexical tone contrasts on verbs and nominal complements is preserved, as it is not optimal to insert a High tone to satisfy (13):

(18) Input tonal contrasts preserved

ku-henza mu-gaanga	FAITH-H	AR(H,PP))	F-Pos
☞ku-henza mu-gaanga			
ku-henza mu-gaángâ	*!		

In spite of the similarity found in some contexts, Digo phrasal prosody is not identical to that of Tumbuka because in Digo lexical tone contrasts are consistently maintained. To optimize the obligatoriness of High tones in Tumbuka (non-ideophonic) phrasal domains, we need an additional alignment constraint, the mirror image of (13), which is satisfied if every Phonological Phrase is right-aligned with a High tone:

(19) ALIGNR(PHONPHRASE, H) (AR(PP,H)): Align the right edge of every Phonological Phrase with a High tone.

It is this second alignment constraint which is the driving force behind the reanalysis of the relationship between a High tone and its phrasal domain: from High tone taking a phrasal domain of realization (to satisfy (13)), to High tone being an obligatory marker of a phrasal domain (to satisfy (19)).<sup>3</sup> The relative

<sup>3</sup>I thank one of the anonymous reviewers for stating this point so clearly.

rankings of (19) with FAITHFULNESS constraints define a factorial typology of High tone realization in phrasal domains that connects Digo and Tumbuka.

ALIGNR(PHONPHRASE, H) is obviously low-ranked in Digo, since High tone contrasts are maintained. If DEP-H (14b) is ranked below (19), then we derive a prosodic system where it is optimal to insert a High tone in order to satisfy the constraint in (19):

(20) Ranking 2: obligatory phrasal High tone

MAX-H » ALIGNR(H, PHONPHRASE), ALIGNR(PHONPHRASE, H) » DEP-H, FAITH-POS

Under this ranking, High tone realization takes a phrasal domain to satisfy the alignment constraints; lexical tone contrasts can be realized in the output. Like Digo, the position of High tones within the phrase is predictable. In contrast to Digo, a High tone obligatorily occurs on the penult of a Phonological Phrase, due to the ranking ALIGNR(PHONPHRASE, H) » DEP-H, even when no lexical High tones are found in the input. Some dialects of Shingazidja (Bantu G.44; Cassimjee & Kisseberth 1998; Patin 2017) illustrate this type of prosodic system.<sup>4</sup>

The tableaux in (21) exemplify how the ranking in (20) optimizes obligatoriness of phrasal High tone while maintaining some tonal contrasts. As we can see in (21b), even phrases without an underlying High tone optimally have one on the surface. Digo data is used here for ease of comparison; these data are to be considered Digo’:

(21) Shingazidja-like language analysis, using Digo data

a. High tone in the input

á-na-henza mu-gaanga	MAX-H	AR(H,PP)	AR(PP,H)	DEP-H	F-Pos
á-na-henza mu-gaanga		*!	*		
a-na-henza mu-gaanga	*!		*		
☞ a-na-henza mu-gaángâ					*

b. No High tone in the input

ku-henza mu-gaanga	MAX-H	AR(H,PP)	AR(PP,H)	DEP-H	F-Pos
ku-henza mu-gaanga			*!		
☞ ku-henza mu-gaángâ				*	

Even though high-ranked MAX-H optimizes maintaining all the input High tones in the output, the constraint ranking in (20) increases the opacity of the phrasal

<sup>4</sup>I am abstracting away from the details of the very complex Shingazidja phrasal tone realization system in order to highlight the aspects that are similar to Tumbuka. See Cassimjee & Kisseberth (1998); Patin (2007; 2017) and Philippson (2005) for detailed discussion and analysis.

tone system. A High tone on the phrase penult vowel might have its source in the input of either of the words in the phrase – or in neither.

In Tumbuka, High tone is obligatory at the phrase level, and tonal contrasts are lost in the non-ideophonic lexicon. This type of prosodic system is optimized by ranking all of the FAITHFULNESS constraints below the ALIGNMENT constraints:

- (22) Ranking 3: Tumbuka, obligatory and non-contrastive phrasal High tone  
 ALIGNR(H, PHONPHRASE), ALIGNR(PHONPHRASE, H) » FAITH-H,  
 FAITH-POS

When both Alignment constraints are high ranked, High tone realization not only takes a phrasal domain, High tone also ceases to be contrastive. A High tone occurs obligatorily on the phrase penult, even when no lexical High tones are found in input. This is illustrated in the following tableaux, where, again, Digo' data is used for ease of comparison:

- (23) Tumbuka analysis with Digo' data

a. Input High tone

á-na-henza mu-gaanga	AR(H,PP)	AR(PP,H)	FAITH-H	F-Pos
á-na-henza mu-gaanga	*!	*		
a-na-henza mu-gaanga		*!	*	
☞ a-na-henza mu-gaángâ				*

b. No input High tone

ku-henza mu-gaanga	AR(H,PP)	AR(PP,H)	FAITH-H	F-Pos
ku-henza mu-gaanga		*!		
☞ ku-henza mu-gaángâ			*	

What drives the re-ranking of FAITHFULNESS constraints, I propose, is the ambiguity of analysis of High tones that take a phrasal domain. When High tones optimally shift long distance and a High tone obligatorily occurs at the edge of every Phonological Phrase, the input source of the High tone, if any, is not syntagmatically recoverable. This favors reinterpretation of High tones as predictable correlates of Phonological Phrase edges, rather than as contrastive tones realized in a phrasal domain.

So far, the analysis does not account for why ideophones, unlike other lexical categories, maintain lexical tone contrasts in Tumbuka. Recall from the discussion in §3.2, above, that it is a defining property of ideophones that they must be realized with a particular prosody. In OT terms, this generalization could be formalized as a FAITH-PROSODYIDEOPHONE (F-IO) constraint, which is never out-ranked. (See Shih & Inkelas 2015 and Smith 2011 for discussion and analysis of

lexical-category specific phonological effects, including category-specific FAITHFULNESS.) Since ideophones always end a Phonological Phrase, an alignment constraint, ALIGNIDEO (A-IO), is necessary to optimize that requirement. The analysis is exemplified with the hypothetical example below where word 2 is an ideophone:

- (24) Word 2 (nyujumu) is an ideophone; | indicates a Phonological Phrase boundary

á-na-henza nyujumu	F-IO	A-IO	AR(H,PP)	AR(PP,H)	FAITH-H	F-Pos
á-na-henza nyujumu			*!	*		
a-na-henza nyujumu	*!					*
á-na-henza nyujumu				*	*	

Clearly more work on the prosody of ideophones in Bantu languages, especially in languages with reduced tonal contrasts in other areas of the lexicon, is needed in order to see how (a-)typical the Tumbuka system is in maintaining tone contrasts just in the ideophonic system.

## 5 Conclusion

To sum up, I have made the following two proposals about the Tumbuka prosodic system. First, Tumbuka High tone realization has both stress-like and tone-like properties, as defined in Hyman (2006; 2009; 2012; 2014). As a result, Tumbuka cannot be classified as a purely stress language, as Kisseberth & Odden (2003) and Vail (1972) suggest. It is at best a non-canonical stress language. Second, the synchronic Tumbuka prosodic system plausibly evolved from a Digo-like and/or Shingazidja-like prosodic system through a process – formalizable as an OT factorial typology – which made phrasal prosody more transparently predictable by eliminating tonal contrast except in the non-ideophonic lexicon: i.e., the area of the lexicon where FAITHFULNESS constraints are least susceptible to low ranking.

## Acknowledgements

I would like to thank my Tumbuka language consultants, especially Tionge Kalua and David Msiska, for their patience in helping me learn about their language. I would also like to thank the audience at ACAL47, two anonymous reviewers and the editor of this volume for thoughtful comments which helped improve both the content of the paper and its presentation. I alone am responsible for any errors.

## References

- Ashton, Ethel O. 1947. *Swahili grammar*. 2nd edn. London: Longmans.
- Beckman, Jill N. 1997. Positional faithfulness, positional neutralisation and Shona vowel harmony. *Phonology* 14. 1–46.
- Cassimjee, Farida & Charles W. Kisseberth. 1998. Optimal domains theory and Bantu tonology. In Charles W. Kisseberth & Larry M. Hyman (eds.), *Theoretical aspects of Bantu tone*, 265–314. Stanford: CSLI.
- Chavula, Jean Josephine. 2016. *Verb derivation and valency in Citumbuka*. Leiden University. (Doctoral dissertation).
- Childs, Tucker C. 1994. African ideophones. In Leanne Hinton, Johanna Nichols & John J. Ohala (eds.), *Sound symbolism*, 178–204. Cambridge: Cambridge University Press.
- Clements, George N. & John Goldsmith. 1984. Introduction. In George N. Clements & John Goldsmith (eds.), *Autosegmental studies in Bantu tone*, 1–17. Dordrecht: Foris Publications.
- Dingemans, Mark. 2012. Advances in the cross-linguistic study of ideophones. *Language and Linguistics Compass* 6. 654–672.
- Doke, Clement M. 1954. *The Southern Bantu languages*. London: Oxford University Press.
- Downing, Laura J. 2006. The prosody and syntax of focus in Chitumbuka. In Laura J. Downing, Lutz Marten & Sabine Zerbian (eds.), *Papers in Bantu grammar and description* (ZASPiL 43), 55–79. Berlin: ZAS.
- Downing, Laura J. 2008. Focus and prominence in Chichewa, Chitumbuka and Durban Zulu. *ZAS Papers in Linguistics* 49. 47–65.
- Downing, Laura J. 2010a. Accent in African languages. In Harry G. van der Hulst, Rob W. N. Goedemans & Ellen A. van Zanten (eds.), *A survey of word accentual patterns in the languages of the world*, 381–427. Berlin: Mouton de Gruyter.
- Downing, Laura J. 2010b. Prosodic phrasing in relative clauses: A comparative look at Zulu, Chewa and Tumbuka. In Karsten Legère & Christina Thornell (eds.), *Bantu languages: Analyses, description and theory*, 17–29. Cologne: Köppe.
- Downing, Laura J. 2012. On the (non-)congruence of focus and prominence in Tumbuka. In Nikki B. Adams, Michael R. Marlo, Tristan M. Purvis & Michelle Morrison (eds.), *Selected proceedings of the 42nd annual conference on African linguistics*, 122–133. Somerville, MA: Cascadilla Proceedings Project.
- Downing, Laura J. 2017. Intonation in Chichewa and Tumbuka. In Laura J. Downing & Annie Rialland (eds.), *Intonation in African tone languages*, 365–391. Berlin: Mouton de Gruyter.

- Gordon, Matthew. 2014. Disentangling stress and pitch-accent: A typology of prominence at different prosodic levels. In Harry van der Hulst (ed.), *Word stress: Theoretical and typological issues*, 83–118. Cambridge: CUP.
- Gussenhoven, Carlos. 2006. Between stress and tone in Nubi word prosody. *Phonology* 23. 193–223.
- Harris, John. 2004. Release the captive coda: The foot as a domain of phonetic interpretation. In John Local, Richard Ogden & Rosalind Temple (eds.), *Phonetic interpretation* (Papers in Laboratory Phonology 6), 103–129. Cambridge: Cambridge University Press.
- Hyman, Larry M. 2006. Word-prosodic typology. *Phonology* 23. 225–257.
- Hyman, Larry M. 2009. How (not) to do phonological typology: The case of pitch-accent. *Language Sciences* 31. 213–38.
- Hyman, Larry M. 2012. *Towards a canonical typology of prosodic systems*. UC Berkeley Phonology Lab Annual Report.
- Hyman, Larry M. 2013. Penultimate lengthening in Bantu: Analysis and spread. In Balthasar Bickel, Lenore Grenoble, David A. Peterson & Alan Timberlake (eds.), *Language typology and historical contingency: In honor of Johanna Nichols*, 309–330. Amsterdam: John Benjamins.
- Hyman, Larry M. 2014. Do all languages have word accent? In Harry van der Hulst (ed.), *Word stress: Theoretical and typological issues*, 56–82. Cambridge: Cambridge University Press.
- Kisseberth, Charles W. 1984. Digo tonology. In George N. Clements & John Goldsmith (eds.), *Autosegmental studies in Bantu tone*, 105–182. Dordrecht: Foris Publications.
- Kisseberth, Charles W. & David Odden. 2003. Tone. In Derek Nurse & Gérard Philippson (eds.), *The Bantu languages*, 59–70. London: Routledge.
- Lodhi, Abdulaziz Yusuf. 2004. Strategies of emphasis and intensity in Swahili. *Africa & Asia* 4. 142–150.
- McCawley, James. 1978. What is a tone language? In Victoria Fromkin (ed.), *Tone: A linguistic survey*, 113–131. New York: Academic Press.
- Meeussen, Achiel. E. 1967. *Bantu grammatical reconstructions*.
- Mohamed, Mohamed A. 2001. *Modern Swahili grammar*. Nairobi: East African Educational Publishers.
- Mphande, Lupenga. 1989. *A phonological analysis of the ideophone in Chitumbuka*. University of Texas at Austin. (Doctoral dissertation).
- Mphande, Lupenga & Curtis Rice. 1995. Chitumbuka ideophones. In Francis Katamba (ed.), *Bantu phonology and morphology*, 93–99. Munich: Lincom Europa.

- Newman, Paul. 2001. Are ideophones really as weird and extra-systematic as linguists make them out to be? In F. K. Erhard Voeltz & Christa Kilian-Hatz (eds.), *Ideophones*, 251–258. Amsterdam: John Benjamins.
- Odden, David. 1988. Predictable tone systems in Bantu. In Harry van der Hulst & Norval Smith (eds.), *Autosegmental studies on pitch accent*, 225–251. Dordrecht: Foris.
- Odden, David. 1999. Typological issues in tone and stress in Bantu (comments by s. Kaji). In Shigeki Kaji (ed.), *Cross-linguistic studies of tonal phenomena: Tonogenesis, typology, and related topics*, 187–219. Tokyo: ILCAA.
- Patin, Cédric. 2007. La tonologie du Shingazidja, langue bantu (G44a) de la Grande Comore: nature, formalization, interfaces: Université Paris 3. (Thèse de doctorat).
- Patin, Cédric. 2017. Tone and intonation in Shingazidja. In Laura J. Downing & Annie Rialland (eds.), *Intonation in African tone languages*, 285–320. Berlin: Mouton de Gruyter.
- Philippon, Gérard. 2005. Pitch accent in Comorian and Proto-Sabaki tones. In Koen Bostoen & Jacky Maniacky (eds.), *Studies in African comparative linguistics with special focus on Bantu and Mande*, 199–220. Tervuren: Musée Royal de l’Afrique Centrale.
- Philippon, Gérard. 1998. Tone reduction vs. Metrical attraction in the evolution of Eastern Bantu tone systems. In Larry M. Hyman & Charles W. Kisseberth (eds.), *Theoretical aspects of Bantu tone*, 315–329. Stanford: CSLI.
- Polomé, Edgar C. 1967. *Swahili language handbook*. Washington, DC: Center for Applied Linguistics.
- Schadeberg, Thilo. 1973. Kinga: A restricted tone system. *Studies in African Linguistics* 4. 23–46.
- Shih, Stephanie & Sharon Inkelas. 2015. *Morphologically-conditioned tonotactics in multilevel Maximum Entropy grammar*. Paper presented at AMP 2015.
- Smith, Jennifer L. 2011. Category-specific effects. In Marc van Oostendorp, Colin J. Ewen, Elizabeth Hume & Keren Rice (eds.), *The Blackwell companion to phonology*, 2439–2463. Malden, MA: Wiley-Blackwell.
- Steriade, Donca. 1995. *Positional neutralization*. Ms., UCLA.
- Vail, H. Leroy. 1972. *Aspects of the Tumbuka verb*. University of Wisconsin. (Doctoral dissertation).
- Welmers, William E. 1959. Tonemics, morphotonemics, and tonal morphemes. *General Linguistics* 4. 1–9.
- Welmers, William E. 1973. *African language structures*. Berkeley: University of California Press.



## Chapter 6

# Hybrid falling tones in Limbum

Siri Gjersøe

Leipzig University

Jude Nformi

Leipzig University

Ludger Paschen

Leipzig University

This paper examines the interaction between lexical tone and phrase-level intonation in Limbum. On the basis of an acoustic study of novel data, we claim that Limbum has a phrase-final low boundary tone (L%) that interacts with lexical tones to give rise to *hybrid* falling tones: tones whose specifications are partially lexical and partially phrasal. We argue that hybrid tones and other tonal processes in Limbum are readily captured in an analysis that assumes tonal geometry and empty nodes. We propose to represent L% as a floating low register feature (l) that links to lexical tonal root nodes, giving rise to various surface patterns depending on the tonal specifications of the root nodes. Our account supersedes previous analyses in terms of tone sandhi rules.

## 1 Introduction

Limbum is a Grassfields Bantu language spoken by about 1,340,000 speakers in the Donga Mantung division of the North West region of Cameroon. Limbum is an understudied language, especially with regards to its suprasegmental phonetics and phonology. In previous work (Fiore 1987; Fransen 1995), Limbum has been described as a tone language with three level tones (H, L, M) and four contour



tones (HL, LM, ML, LL).<sup>1</sup> It has also been observed that low-falling tones appear as level tones when they occur in a non-sentence-final position, a process which Fransen (1995) argues is the result of a sandhi simplification rule.

In this paper, we present an acoustic analysis of novel data from recordings of three native speakers of Limbum. We show that the data are actually more complex and Fransen's analysis fails to account for the whole range of tonal alternations. Instead, we claim that Limbum has a final low boundary tone (L%) in certain syntactic contexts. Adopting the decompositional approach by Snider (1999), we argue that L% is a floating low register feature that can create phrase-final falling contour tones by associating to lexical tonal root nodes. Crucially, we assume that falling contour tones are not falling underlyingly: they only differ from level tones by having an additional empty tonal root node associated to their TBU. L% interacts with lexical tonal specifications to create *hybrid* surface tones, i.e. tones that combine lexical and phrasal tonal features.

The paper is structured as follows. In §2, we present our acoustic study and offer a qualitative analysis of F0 tracks for all tested items. §3 comprises the formal part of this paper, in which we provide a unified analysis of the tonal processes described in the previous section. In §4, we discuss why our analysis fares better than alternative accounts and probe typological implications.

## 2 Acoustic Study

### 2.1 Data and Methods

Data presented in this study were collected from two male (ages 23 and 29) and one female (age 26) speakers of Limbum (Central/Warr dialect). Recordings of one of the male speakers were conducted at the phonetics laboratory at Leipzig University in the winter of 2015 using a T-bone SC 440 supercardioid microphone (sampling rate 44.1 kHz, 16-bit). The recordings of the two other speakers were conducted in Buea, Cameroon using an H5 Zoom recorder with a SM10A Shure microphone (same sampling and bit rates).

The speakers were given a reading task with a set of constructed test sentences. In the examples in (1), *lé* (in boldface) is the target word. We tested five sentence

---

<sup>1</sup>The sources mentioned also discuss a somewhat dubious fifth contour tone, HM. Fiore (1987) argues that HM is an allotone of HL and proposes segmental length as a factor conditioning allotony, a view that is shared in Fransen (1995). However, Fiore (1987) presents only two examples of HM-toned words, and our informants accept this tone on only a single lexical item, *báā* 'two'. On the basis of its highly limited distribution, we decided not to include HM in our study.

types: Declarative sentences in which the target word appears in a sentence-final position (*Decl.Fin*), declaratives in which the target word appears in a non-sentence-final position (*Decl.Med*), simple wh-questions with the target word as the last item (*Wh.Fin*), wh-questions with the final question particle *a* (*Wh.Prt*), and polar questions which always end in the particle *a* (*Pol*). The semantic difference between *Wh.Fin* and *Wh.Prt* is that the latter signals that the wh-element is a known referent.<sup>2</sup> A complete list of target words (two words per tone)<sup>3</sup> is given in Table 1.<sup>4</sup> In total, our study comprises 7 tones x 2 words x 5 sentence types x 3 speakers. Each sentence was pronounced 1–2 times by each speaker. Values for sentences with more than one repetition were aggregated in R studio (v. 3.2.2).<sup>5</sup>

- (1) Tánkó àm yē lé  
 T. PST see bat  
 ‘Tanko saw a bat.’ (Decl.Fin)
- (2) Tánkó àm yē lé fī  
 T. PST see bat new  
 ‘Tanko saw a new bat.’ (Decl.Med)
- (3) á ndā àm yē lé  
 FOC who PST see bat  
 ‘Who saw a bat?’ (Wh.Fin)
- (4) á ndā àm yē lé a  
 FOC who PST see bat PRt  
 ‘Who saw a bat?’ (Wh.Prt)

<sup>2</sup>See Driemel & Nformi (forthc.) for further discussion of the functional domains of particles in Limbum.

<sup>3</sup>We found two microprosodic effects of vowel height: (1) With low-vowel items, F0 values overlap for HL and ML; (2) with high-vowel items, LM undergoes flattening when it precedes a L tone. Since these effects appear to be due to phonetic variation and distract away from the actual tone patterns, we present the F0 traces of all items combined rather than separating them into high- and low-vowel items.

<sup>4</sup>We adopt the convention of writing two vowels for syllables with contour tones in order to accommodate the tonal diacritics. However, this also reflects the extra length observed especially (but not exclusively) on sentence-final contour tones. Note that the use of two vowel symbols does *not* represent a phonemic length contrast because such a contrast is absent in the dialect of Limbum under discussion.

<sup>5</sup>It was only possible to record *tāà* ‘father’ and *sōō* ‘basket’ for one speaker. We used two repetitions per item from that speaker, aggregated in R.

- (5) Tánkó àm yē lé a  
 T. PST see bat PRT  
 ‘Did Tanko se a bat?’ (Pol)

The aim of our acoustic study was to test prior observations that contour tones alternate with level tones phrase-medially (Fransen 1995), and also to examine whether lexical tones interact with boundary tones. In the following, we abbreviate alternating low-falling/level tones as *L(L)*, *M(L)*, and *H(L)*, and we use *T(L)* to refer to the whole group of alternating tones. Level tones are abbreviated as *L*, *M*, *H*, and *T*, respectively. Annotations were done in Praat (Boersma & Weenink 2016) and automatically extracted from TextGrid and PitchTier files. Starting from the M-toned verb *yē* ‘see’ (see (1)), the onset (O) and nucleus (N) of the target words and any syllables following them (*fī* in *Decl.Med* and the particle *a* in *Pol* and *Wh.Prt*) were annotated. A Praat script by Remijsen (2013b) was run to generate Pitch objects that are automatically trimmed for spikes using the algorithm in Xu (1999). The items were manually corrected for microprosodic effects on F0. Interpolation for words with voiceless consonantal onsets (for two out of our 14 test words) was done using the smoothing algorithm in Praat. F0 values at equidistant time points within intervals were then extracted using the Praat script by Remijsen (2013a). The F0 values were converted into semitones (st) in R, with the midpoint value of *yē* ‘see’ serving as base line for the semitone scale for each individual item.

Table 1: List of target words and attested tone types in Limbum

Tone	Word 1	Gloss 1	Word 2	Gloss 2
LEVEL TONES				
L	<i>bà</i>	‘bag’	<i>bì</i>	‘people’
M	<i>bā</i>	‘fufu’	<i>bō</i>	‘children’
H	<i>bá</i>	‘hill’	<i>lé</i>	‘bat’
LOW-FALLING CONTOUR TONES				
L(L)	<i>ràà</i>	‘bridge’	<i>rdòò</i>	‘going’
M(L)	<i>tāà</i>	‘father’	<i>bū</i>	‘co-wife’
H(L)	<i>dáà</i>	‘cutlass’	<i>kúù</i>	‘funnel’
RISING CONTOUR TONES				
LM	<i>yàā</i>	‘princess’	<i>sòò</i>	‘basket’

## 2.2 Results

The graphs below show the descriptive statistics of the tones in each tested context with F0 traces normalized for all three speakers.

### 2.2.1 Falling contour tones

The nuclei of L(L), M(L), and H(L) toned words are all falling sentence-finally (*Decl.Fin* and *Wh.Fin*, left graph in Figure 1). Sentence-medially, no pronounced falling movement can be observed in the nuclei, confirming the claim in Fransen (1995) that contour tones alternate with level tones sentence-medially (*Decl.Med*, right graph in Figure 1). LM is rising in all sentence-types and the F0 traces show that LM is not lowered sentence-finally. Low-falling L(L) is accompanied by breathy voice in *Decl.Fin* and *Wh.Fin* (see Gjersøe et al. 2016 for discussion). Pitch contours in *Decl.Fin* largely overlap with those in *Wh.Fin*.

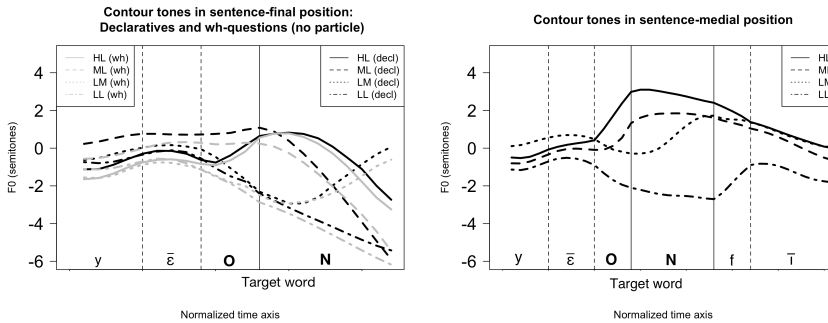

Figure 1: T(L) contour tones realized as falling tones sentence-finally (*Decl.Fin* and *Wh.Fin*, left graph); the same tones showing a flat pitch trace in non-final position (*Decl.Med*, right graph).

### 2.2.2 Level tones

Figure 2 shows F0 traces for the level tones L, M, and H in *Decl.Fin*, *Wh.Fin*, and *Decl.Med*. In sentence-medial position (right graph), the three level tones are realized with a stable flat contour. Sentence-finally (left graph), H and M are also flat. The L tone, however, shows a conspicuous falling contour extending to almost six semitones below the mid level of  $y\bar{e}$ . That the L tone is realized as low-falling sentence-finally is a new observation that has not been noted in Fiore

(1987) or Fransen (1995). As with contour tones, F0 movements in *Decl.Fin* were not different from those in *Wh.Fin*.

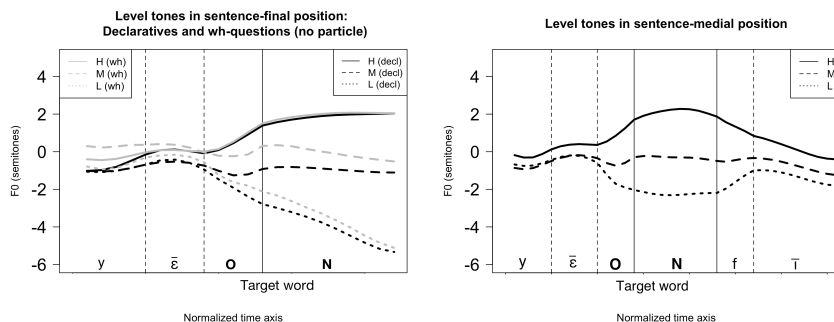

Figure 2: T level tones in final (*Decl.Fin* and *Wh.Fin*, left graph) and sentence-medial (*Decl.Med*, right graph) position.

### 2.2.3 Questions with the final particle *a*

There are a number of striking differences between the two sentence types with the final question particle *a*, i.e. between *Wh.Prt* and *Pol*. The main difference is that F0 trends on the particle are generally low-falling in *Wh.Prt* while F0 remains on the same level as that of a previous T tone in *Pol*. Following a T(L) tone, particles have a mid tone in *Pol*. In other words, *Wh.Prt* is very similar to *Wh.Fin* and *Decl.Fin* whereas *Pol* more closely resembles *Decl.Med*.

T(L) tones in *Wh.Prt* (left graph of Figure 3) reach a low target on the particle. Level tones in *Wh.Prt* (gray F0 traces in Figure 4) also reach a low target on the particle. Note that both the T(L) and level tones show a small anticipatory fall from the nucleus midpoint before the low target in the particle. The rising tone LM has only a small-scale rise from its nucleus to the particle. The flattened LM trace appears to be an effect of the L target of the following particle, conditioned by a tonal coarticulation effect which lowers the mid peak in the sequence LM.L. This effect was weaker for the low-vowel item (see footnote 3).

In polar questions, the particle has a mid tone when it follows a T(L) toned word (right graph in Figure 3). However, F0 on the particle remains stable after a level tone, continuing its low, mid, or high pitch level (black F0 traces in 4). F0 on the particle shows a small but insignificant rise after L, and the mid target of LM seems a little higher than that of T(L) tones. We will briefly consider explanations for these rises in §2.3. The divergent tonal behavior of polar and wh-questions

is another new observation missing in previous descriptions of Limbum. A final point to note is that F0 values for HL and ML appear to converge in pre-particle position. However, this convergence only seems to occur on low-vowel items (see footnote 3).<sup>6</sup>

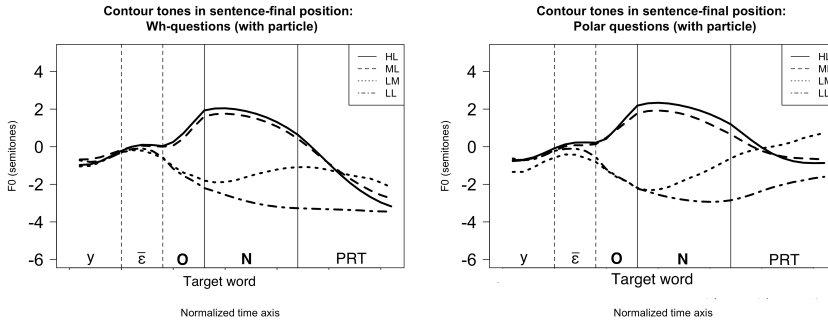

Figure 3: Words with a T(L) contour tone preceding a final particle in *Wh.Prt* (left graph) and *Pol* (right graph).

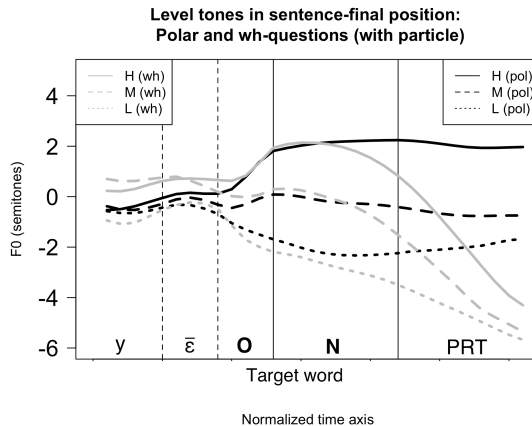

Figure 4: Words with a level tones preceding a final particle in *Wh.Prt* (gray F0 traces) and *Pol* (black F0 traces).

<sup>6</sup>At present, we cannot offer a convincing explanation why the M and H targets converge for some items in this context. We suspect that it is due to an independent process that does not interfere with the tonal alternations that we consider in this paper. Further studies are needed to scrutinize the conditioning factors and the productivity of this process.

### 2.2.4 Duration

Vowels on our target words are generally longer sentence-finally (*Decl.Fin* and *Wh.Fin*) than in other contexts. Duration differences are most prominent for alternating falling/non-falling tones, which are realized as TL sentence-finally and as T sentence-medially. For instance, in ‘bridge’, ‘father’ and ‘cutlass’, vowels are long sentence-finally (*ràà*, *tāà*, and *dáà*) but short sentence-medially (*rà*, *tā*, and *dá*). Level tones, in particular H, may also occasionally be longer sentence-finally. Thus, ‘hill’ and ‘bat’ are sometimes pronounced as long *báá* and *léé* in *Decl.Fin* and *Wh.Fin* but as short *bá* and *lé* in *Decl.Med* and *Wh.Prt*. The rising contour tone LM shows no durational differences across the different sentence types. Even though differences in vowel duration are attested in the recordings of all of our three speakers, there is a great deal of inter- and intra-speaker variation as to how big these length differences are, and failure to lengthen a final vowel in *Decl.Fin* and *Wh.Fin* is not considered ungrammatical. We therefore attribute the observed durational differences to an optional pre-boundary lengthening effect.

### 2.3 Interim summary

Table 2 summarizes the tonal alternations described in this section. Low-falling contour tones (LL, ML, HL) only occur in phrase-final position (*Decl.Fin* and *Wh.Fin*). Elsewhere, the fall to L is missing, and the first part of the contour is realized as a level tone. Non-low level tones are invariant in all contexts, while L is lowered phrase-finally. The question particle *a* receives a L tone in *Wh.Prt*, while in *Pol*, it copies the tone of a preceding level tone but receives a M tone when it follows a contour tone. L can thus be distinguished from L(L) only in *Pol*. LM is always realized as LM in all tested environments.

Table 2: Surface tones across all tested sentence types

	L	M	H	L(L)	M(L)	H(L)	LM
<i>Decl.Fin</i>	LL	M	H	LL	ML	HL	LM
<i>Decl.Med</i>	L	M	H	L	M	H	LM
<i>Wh.Fin</i>	LL	M	H	LL	ML	HL	LM
<i>Wh.Prt</i>	L.L	M.L	H.L	L.L	M.L	H.L	LM
<i>Pol</i>	L.L	M.M	H.H	L.M	M.M	H.M	LM



Our data also reveal a small number of minor phonetic effects. First, the mid target in the sequence LM.L is not reached in *Wh.Prt*. We assume that this is a coarticulatory effect conditioned by the two L targets, one from the lexical tone and other from the particle. As mentioned earlier, this effect is stronger for the high-vowel item than the low-vowel item. We do not have a straightforward explanation for the small rise on the particle in *Pol* following L and LM. For now, we do not consider this a relevant phonological process because the extra rise on L does not reach a M target and the extra rise on LM does not reach a H target.

### 3 A formal account of tone-intonation interaction

In this section, we present our formal analysis of tonal alternations in Limbum. We assume that each of our test sentences constitutes an Intonational Phrase (IP). The core idea of our analysis is that Limbum has a low boundary tone L% at the right edge of an IP in *Decl.Fin*, *Decl.Med*, *Wh.Prt*, and *Wh.Fin*, but not in *Pol*. We represent L% as a floating register feature *l*. Lowering of L, the falling/non-falling alternations, and the divergent tonal patterns on the particle *a* in *Wh.Prt* and *Pol* all result from the presence (or absence) of *l* and constraints governing if and how *l* associates to tonal root nodes.

#### 3.1 Theoretical background

##### 3.1.1 Tonal root nodes and floating tonal features

The central idea of our analysis is that boundary tones and lexical tones are crucially represented by the same tonal features. Adopting the idea of tonal decomposition and geometry (Clements 1983; Hyman 1986; Snider 1999; Yip 1999), we assume that tones – much like segments – can be decomposed into distinctive features. Following Snider (1999)'s Register Tier Theory (RTT), we distinguish four different tiers: a register tier (with register features *h* and *l*), a tonal tier (with tonal features *H* and *L*), a tonal root node (or *o*) tier, and a TBU tier. A register feature specifies whether it is higher or lower compared to an adjacent register feature, while a tonal feature specifies whether a tone is high or low within a given register. As shown in Figure 5, RTT thus allows to distinguish four pitch levels: High (*H/h*), Mid1 (*H/l*), Mid2 (*L/h*), and Low (*L/l*) (Snider 1999: 62). Since there is only one mid pitch level in Limbum, we represent *M* as *L/h* and assume that the combination *H/l* (Mid1) is not part of the tonal lexicon.

We represent contour tones as two *o*'s linked to a single TBU (following Fiore 1987 and Fransen 1995, we assume that the syllable is the TBU in Limbum). While

LM, the only rising tone in Limbum, is fully specified for both o's, low-falling contour tones have one fully specified and one empty tonal root node underlyingly (see Figure 6). Basing our analysis within the broader framework of featural affixation (Akinlabi 1996), we represent the boundary tone L% as a floating low register feature l. This floating feature interacts with lexically underspecified (and in some cases also with fully specified) o's, most notably by creating low-falling contour tones. Table 3 gives a summary of the tonal features of underlying tones in Limbum.

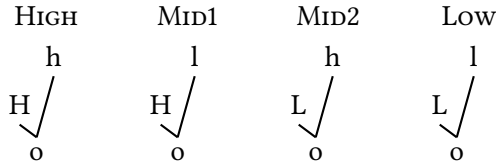

Figure 5: Tonal geometry in RTT

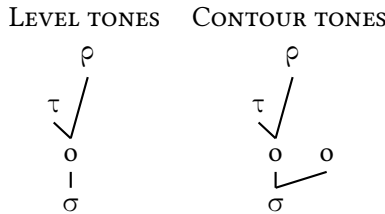

Figure 6: Level and partially specified contour tones

Table 3: Underlying tone inventory

	L	M	H	L(L)	M(L)	H(L)	LM	L%
TONE ( $\tau$ )	L	L	H	L o	L o	H o	L L	
REGISTER ( $\rho$ )	l	h	h	l o	h o	h o	l h	l

While equating phrasal tones with register features might seem ad-hoc and unwarranted at first sight, there is a crucial parallel between the two: both can be understood as abstract phonetic targets relative to a previous target. Boundary tones following a pitch accent of the same type have the effect of intensifying an already initiated downward or upward movement (Pierrehumbert 1980), while a sequence of two low register features is phonetically realized as further lowering in RTT. Lexical tone features show a strikingly different behavior from both reg-

ister features and boundary tones in this respect, as a sequence of three H-toned TBU's is not expected to show a rising contour under standard assumptions. Instead, it would be more likely for pitch to steadily decrease due to downdrift, or for some of the H tones to undergo downstep. For that reason, we believe that there is a natural ontological link between register features and boundary tones, and we capture this connection by the simplest formal means, viz. an identical representation of the low register feature  $l$  and the low boundary tone  $L\%$ .

### 3.1.2 Constraining tonal processes

Having established the representations of lexical and phrasal tones, we now detail how the tonal alternations described in the previous sections are derived, using the general framework of Optimality Theory (Prince & Smolensky 2004/1993). While our analysis is in principle compatible with most versions of OT, we couch our analysis in *Coloured Containment* (Trommer 2015; Zimmermann 2017), which provides the means to accurately constrain association lines within and across phonological (sub-)structures. *Containment Theory* (van Oostendorp 2004) restricts the generative power of GEN to manipulating association lines between phonological nodes and inserting epenthetic nodes. This means while GEN can add new lines and mark existing lines as invisible, it cannot delete any phonological material that is present in the input. This vastly reduces the number of possible candidates that need to be evaluated compared to analyses of tone in Correspondence Theory (Zoll 2003; Zhang 2007).

In our analysis, we do not invoke the powerful machinery of multi-level markedness in Containment. We employ Containment solely for its precise way to evaluate association relations between phonological nodes, as illustrated in very general terms in (6) and (7). For our analysis, the relevant nodes are the tonal root node ( $o$ ), register features ( $l, h; \rho$ ), and tonal features ( $L, M, H; \tau$ ). The constraint  $\rho \rightarrow o$ , for instance, should be read as “Count one  $\star$  for each register feature not associated to a tonal root node”.

(6)  $\begin{array}{c} \alpha \\ \downarrow \\ \beta \end{array}$       Count one  $\star$  for each  $\alpha$  not associated to a  $\beta$ .

(7)  $\begin{array}{c} \alpha \\ \uparrow \\ \beta \end{array}$       Count one  $\star$  for each  $\beta$  not associated to a  $\alpha$ .

Two constraints corresponding to classical OT faithfulness constraints MAX and DEP are given in (8) and (9), respectively. Note that IDENT does not apply in Containment because nodes present in the input cannot be altered in any way.

(8)  $\text{MAX}_{\beta}^{\alpha}$  Count one \* for each deleted association line between a node  $\alpha$  and a node  $\beta$ .

(9)  $\text{DEP}_{\beta}^{\alpha}$  Count one \* for each inserted association line between a node  $\alpha$  and a node  $\beta$ .

Another crucial set of constraints is given in (10) and (11). The first constraint militates against not fully specified tonal root nodes while the second constraint demands a TBU (the syllable) to be minimally specified for a tone and a register feature. Note that these constraints are different from a conjunction of  $\rho \leftarrow o$  and  $\tau \leftarrow o$ : while such a local constraint conjunction would penalize only those root nodes (syllables) that are linked to exactly zero tonal and zero register features, the constraints here demand full specification. The last constraint that needs to be introduced here is \*loh (12), which penalizes tonal root nodes associated to two non-identical register features.

(10)  Count one \* for each tonal root  $R$  such that  $R$  is not associated to both a register feature and a tonal feature.

(11)  Count one \* for each syllable node  $S$  such that  $S$  is not linked to both a register feature and a tonal feature by a path of association lines.

(12) \*loh Count one \* for each tonal root linked to both  $l$  and  $h$ .

We adopt the theory of morphological colors (van Oostendorp 2006) to restrain access to morphological information by the phonological component. The theory of morphological colors forbids morphological look-up but enables the phonology to distinguish between elements of different morphological provenience. This will become relevant in the analysis of particle tones below.

A final assumption underlying our analysis is a stratal organization of grammar as it is modeled in Stratal OT (Kiparsky 2000; Bermúdez-Otero 2012). All evaluations relevant for the tonal processes in Limbum that we are concerned with at this point take place at a postlexical level corresponding to the IP domain. The input to this stratum is a sentence, with all words bearing their lexical (and, if applicable, morphological) tones, plus either  $L\%$  or no boundary tone depending on sentence type. We do not engage in further discussion on tonal processes at lower levels and only concern ourselves with the level of the IP, i.e. the level where  $L\%$  is introduced.

### 3.2 Tonal hybridity and tone-intonation interaction

Recall from the previous section that there are three classes of tones in Limbum: level tones which remain level tones in all positions (L, M, H), level tones that alternate with falling contour tones at the end of declarative sentences and wh-questions (L(L), M(L), H(L)), and a rising contour tone (LM).

We begin with our analysis of T(L) (= falling/non-falling alternating) tones. These tones are equipped with a fully specified tonal root node and an additional empty tonal root node. In the presence of L%, i.e. a floating low register feature, a line is inserted between the empty root node and the low register feature and an epenthetic L tone is inserted to make the o fully specified. These processes are driven by three constraints:  $\tau \leftarrow o \rightarrow \rho$  militating against empty o's, ALT(ERNATION) penalizing insertion of lines between material of the same color, and DEP(H) prohibiting insertion of a H tone. The whole picture is given in the tableau in Table 4.<sup>7</sup> The faithful candidate in a. (which is also the input) violates  $\rho \rightarrow o$  and crucially also  $\tau \leftarrow o \rightarrow \rho$ . Candidate b. incurs violations of DEP(L) and DEP(Line) but is optimal compared to candidates c. (violation of DEP(H)) and d. (violation of ALT). The winning candidate b. is a tonal hybrid: it combines lexical tonal features on its first o and both phrasal and epenthetic tonal features on its second o. Note that in the case of LL, the optimal candidate has two identical tonal root nodes associated to the same TBU. The fact that LL is realized as falling follows directly from RTT: the second l must be realized low relative to the first l.

In phrase-medial position, empty tonal root nodes remain empty. The reason for this is the absence of a boundary tone locally adjacent to the o phrase-medially. The tableau in Table 5 shows how ALT and DEP( $\rho$ ) conspire to render the fully faithful candidate a., which violates the markedness constraint against empty o's, optimal. For the same reason, low-falling do not occur in polar questions *Pol* and wh-questions with the particle *Wh.Prt*: in *Pol*, no L% is present, and in *Wh.Prt*, the low register feature associates to the particle and is not available to fill the empty root node of the lexical word (see below).<sup>8</sup>

<sup>7</sup>Our analysis makes the prediction that if other boundary tones such as H% exist in Limbum, they should also interact with empty tonal root nodes. At present, we have not found any evidence of such boundary tones. Our impressionistic judgment of list intonation in Limbum is that non-final items are marked by a toneless prosodic boundary much like in polar questions, and T(L) tones are realized non-falling accordingly.

<sup>8</sup>It was mentioned in footnote 1 that there is (at least) one lexical item with a HM tone in Limbum. Our informants confirm that for this word, HM patterns like H(L) in that it alternates with a level H tone when not adjacent to L%. While this does not seem to be a productive alternation, it is compatible with our account if we choose to represent the second o of HM as being specified for a H tone and underspecified for a register feature.

Table 4: Combining L% and underspecified tonal root nodes creates hybrid tones

Input = a.	ALT	DEP H	*loh	$\tau$ o	DEP L	$\rho$ o	DEP o
a. 				*!		*	
b. 					*		*
c. 		*!					*
d. 	*!						*

Table 5: No falling contour tones in the absence of L%

Input = a.	ALT	DEP l	DEP h	$\tau$ o	$\rho$ L	$\rho$ o
a.				*		
b.	*!					
c.			*!		*	

The only rising contour tone in Limbum, LM, is unaffected by boundary tones.<sup>9</sup> The interplay of three constraints is responsible for the immunity of fully specified contour tones against overwriting by floating register features: a high-ranked MAX constraint against overwriting of register features, a DEP(o) constraint penalizing insertion of tonal root nodes, and the markedness constraint \*loh. The tableau in Table 6 shows how the fully faithful candidate a. is chosen as optimal.

Table 6: Full specification as a protective shield: LM in the presence of L%

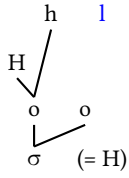
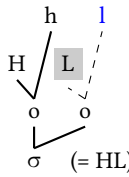
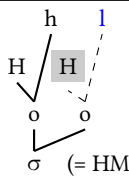
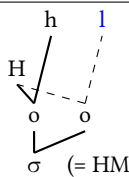
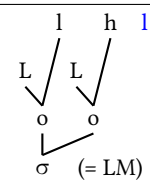
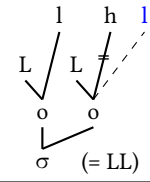
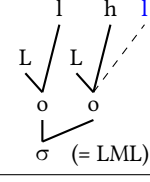
Input = a.	DEP o	MAX <sub>o</sub>	*loh	$\rho$ o
a.  (= LM)				*
b.  (= LL)		*!		
c.  (= LML)			*!	

We now turn to the discussion of level tones. One of the striking arguments in favor of an analysis with L% as opposed to a phrase-medial contour simplification rule (Fransen 1995) is the observation that L is realized as LL in *Decl* and *Wh*. These are the exact same environments for which we independently assume a L% based on the behavior of T(L) tones. The fact that L tones are further lowered in these environments is strong evidence for the presence of L%, and the fact that M and H tones are not affected by it follows directly from the constraint \*loh. The tableau in Table 7 illustrates this process. Candidate b. is a hybrid that hosts two l features of different affiliation under the same o, satisfying \*loh. In RTT, this configuration is equivalent to that of a low-falling LL tone spread over two tonal

<sup>9</sup>See §2.3 for a discussion of incomplete plateauing of LM before L% in *Wh.Prt*.

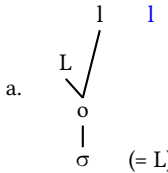
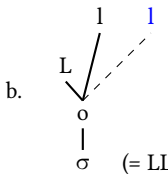
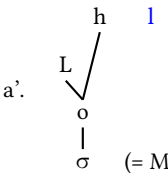
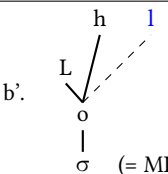

Table 7: L% affects L but not M

Input = a./a'.	DEP <sub>o</sub>	MAX <sub>o</sub>	*loh	o <sub>o</sub>	DEP <sub>o</sub>
a. 				*!	
b. 					*
a'. 				*	
b'. 			*!		*

root nodes. M and H level tones, however, have a h register feature that blocks association of a floating l feature. The immunity of M and H thus follows from the same set of constraints as the immunity of LM discussed above.

We now turn to polar and wh-questions with the final particle *a*. Polar questions are marked with a toneless particle *a* but lack the L% boundary tone. Recall from §2.2.3 that the flat contour of level tones extends to the particle *a* while the particle receives a M tone following T(L) toned words. As shown in the tableaux in Table 8 and Table 9, the tonal features of an underlying level tone with a single, fully specified o can spread to the tonally unspecified particle because this does not violate NoSKIP or ALT. When there is a o intervening between the fully specified root node and the tonal root node on the particle, spreading with skipping is ruled out by NoSKIP and across-the-board spreading is ruled out by ALT. Therefore, the optimal repair for the toneless TBU is insertion of a default M

tone. Empty o's remain empty in T(L) tones in *Decl.Med* because the DEP constraints penalizing M tone insertion outrank  $\tau \leftarrow o \rightarrow \rho$ . Leaving the particle o empty, however, would fatally violate higher-ranked  $\tau \leftarrow \sigma \rightarrow \rho$ .

Table 8: Spreading of a level tone in the absence of L%

Input = a.	No SKIP	ALT	$\tau \leftarrow \sigma \rightarrow \rho$	DEP H	DEP l	DEP h	$\tau \leftarrow o \rightarrow \rho$	DEP L	DEP $\left. \begin{smallmatrix} \rho \\ o \end{smallmatrix} \right\}$
a. 			*!				*		
b. 									*
c. 						*!		*	

Table 9: Default M insertion in the absence of L%

Input = a.	No SKIP	ALT	$\tau \leftarrow \sigma \rightarrow \rho$	DEP H	DEP l	DEP h	$\tau \leftarrow o \rightarrow \rho$	DEP L	DEP $\left. \begin{smallmatrix} \rho \\ o \end{smallmatrix} \right\}$
a. 			*!				**		
b. 	*!						*		*
c. 						*	*	*	

In *Wh.Prt*, the particle receives a low tone and the preceding T(L) tones are realized as level tones. This pattern follows assuming there is an additional markedness constraint  $^*\rho^{2o}$ : “Count one  $\star$  for each register feature associated to more than one o”, ranked below DEP(h) but outranking  $\tau \leftarrow o \rightarrow \rho$ . The floating l links to the particle o (because of  $\sigma \rightarrow \rho$ ) but not to the other empty tonal root node due to  $^*\rho^{2o}$ . In other words, it is better to use the floating l to fill one unspecified syllable but leave a o on a specified syllable empty than to violate  $^*\rho^{2o}$  and fill every o. Spreading of level tones to the particle in polar questions (tableau in Table 8) is not affected by  $^*\rho^{2o}$  because it is ranked below DEP(h), leaving the potential repair of  $\tau \leftarrow \sigma \rightarrow \rho$  by epenthesis suboptimal.

## 4 Discussion

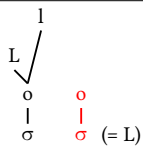
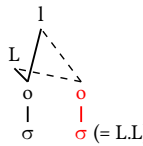
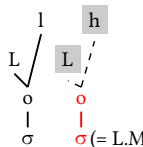
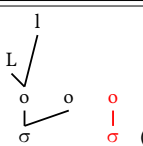
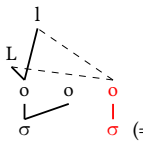
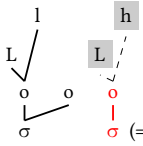
In this section, we briefly consider three potential alternative analyses and discuss some typological implications of our own account.

### 4.1 Alternative: Contour simplification

Our analysis differs substantially from the rule-based account in Fransen (1995). Fransen proposes an analysis in which T(L) tones are fully specified as LL, ML, and HL underlyingly. They are then subject to a tone sandhi rule,  $TL \rightarrow T$ , which applies in all environments except before a pause. This means that contour tones always surface faithfully phrase-finally in all sentence types. The tone sandhi rule seems rather arbitrary, and it seems like a mere stipulation that the rising tone LM is not subject to simplification. An even more severe drawback of Fransen’s sandhi analysis is that it fails to predict the lowering of L. On our account, the fact that L becomes LL in exactly the same environments in which T(L) are realized as TL follows from the presence of L%. Also, our account does not need to stipulate an exception to contour simplification for LM because its immunity follows directly from its full specification and higher-ranked MAX(Line) constraints.

### 4.2 Alternative: Moras

Another possible approach would be an account on which the mora is the TBU. Throughout the paper, we have followed Fiore (1987) and Fransen (1995) in assuming the syllable to be the TBU in Limbum. Since in §2.2.4 we reported that T(L) tones are longer phrase-finally than phrase-medially, it seems appropriate that we defend our decision to ignore the mora in our analysis. First, our informants

rejected all minimal pairs that were put forward to support a phonemic opposition of long vs. short vowels in Fiore (1987) and Fransen (1995). We therefore conclude that there is no independent reason to assume a moraic level of representation in the variety of Limbum discussed here. Second, in order to account for the shortness of medial T(L) tones, a moraic analysis would have to argue that a prosodically fully integrated mora is only realized when it is also tonally specified. This would require a rather unusual definition of structure integration and is at odds with standard assumptions about moras and prosodic structure (Hyman 1985; Hayes 1989; Davis 2011b,a; Zimmermann 2017). Third, phrase-final lengthening also applies to level tones, especially to H. This shows that there is no 1:1 relationship between contour tones and vowel length. Fourth, there seems to be a great deal of inter-speaker variation in how prominent the length differences are. It is therefore safe to assume that the emergence of vowel length is best ascribed to boundary effects and accommodation to contour tones and does not need to be reflected on an abstract phonological level.

### **4.3 Alternative: Cophonologies**

Another possible approach to the data discussed here would be to adopt cophonologies (Orgun 1996; Inkelas & Zoll 2007; Sande 2017). A cophonology approach to Limbum tone would assume that certain sentence types have their own grammar, each giving rise to a specific tone pattern. A cophonology analysis does not need resort to tonal decomposition, floating features, or assumptions about morphological colors. Rather, it would have to stipulate specific (sub-)rankings for declarative sentences, wh-questions, and polar questions. While such an approach might be technically feasible, we believe it would have a number of disadvantages over our unified item-based account as it would miss crucial generalizations about the data. For instance, the asymmetry between alternating T(L) tones and non-alternating LM persists through all sentence types. Also, under a cophonology account it would be entirely accidental that M and LM are both unaffected by L%-induced lowering regardless of the sentential context.

### **4.4 Typological considerations**

The interaction between lexical tones and intonation is a topic that has recently attracted growing attention by scholars (Hyman & Monaka 2011; Gussenhoven 2014; Downing & Rialland 2016). In Limbum,  $\rho \rightarrow o$  is ranked relatively low which has the effect that the boundary tone L% fails to be realized in some cases (in particular following non-low level tones and LM). Limbum can therefore be char-

acterized as an instance of *incomplete avoidance* according to Hyman's (2011) typology: *avoidance* because lexical M and H block L% from surfacing, *incomplete* because L and toneless root nodes do allow it to surface. It is also interesting to note that in Limbum, boundary tones affect only final syllables, as opposed to other languages where sequences of more than one syllable are affected (see Kula & Hamann 2017).

From a functional point of view, it is not surprising that Limbum makes use of intonational means to distinguish declarative sentences from polar questions, and neither is it unusual that wh-questions pattern differently from polar questions (see e.g. the surveys in Chisholm et al. 1984 and Jun 2005). Curiously, the two wh-question constructions in Limbum differ in the presence of the final particle *a* but not in their tonal make-up. A promising road for future research would be to investigate whether lexical optionality is more generally associated with prosodic uniformity, and if the opposite relation holds as well.

## 5 Conclusion

In this paper, we have argued that Limbum has a low boundary tone L% in declaratives and wh-questions but not in polar questions based on an acoustic study with three native speakers. We have shown how tonal alternations, both across lexical items and across sentence types, follow from basic assumptions about tonal geometry and from the distinction between fully specified and empty tonal root nodes. By representing L% as a low register feature, we have proposed a uniform way to model tonal alternations at phrasal edge positions. On our account, tonal hybridity follows straightforwardly from autosegmental linking of phrasal tonal features to lexical tonal root nodes. Limbum thus illustrates the benefits of register features and empty phonological representations, and provides justification for the use of geometry-oriented constraints for analyzing tone-intonation interactions.

## Acknowledgments

This research was funded by the DFG-funded research training group *Interaction of Grammatical Building Blocks* (IGRA) at Leipzig University. We thank Lukas Urmoneit and Sören E. Tebay for assisting with recording and annotating the data. We express our gratitude to Jochen Trommer as well as to the audiences of ACAL 47 and SpeechProsody 8 for their helpful feedback and comments.

## References

- Akinlabi, Akinbiyi. 1996. Featural affixation. *Journal of Linguistics* 32(2). 239–289.
- Bermúdez-Otero, Ricardo. 2012. The architecture of grammar and the division of labour in exponence. In Jochen Trommer (ed.), *The morphology and phonology of exponence*, 8–83. Oxford: Oxford University Press.
- Boersma, Paul & David Weenink. 2016. Praat, v. 6.0.2.1. <http://www.praat.org>.
- Chisholm, William, Louis T. Milic & John A.C. Greppin (eds.). 1984. *Interrogativity*. Vol. 4 (Typological Studies in Language). Amsterdam: Benjamins. DOI:10.1075/tsl.4
- Clements, George N. 1983. The hierarchical representation of tone features. In Ivan R. Dihoff (ed.), *Current approaches to African linguistics*, vol. 1, 145–176. Dordrecht: Foris Publications.
- Davis, Stuart. 2011a. Geminates. In Marc van Oostendorp, Colin J. Ewen, Elizabeth Hume & Keren Rice (eds.), *The Blackwell Companion to Phonology*, vol. II (Blackwell Companions to Linguistics), 873–897. Oxford: Wiley-Blackwell.
- Davis, Stuart. 2011b. Quantity. In John Goldsmith, Jason Riggle & Alan C. L. Yu (eds.), *The handbook of phonological theory*, 2nd edn. 103–140. Oxford: Wiley-Blackwell.
- Downing, Laura Jo & Annie Rialland (eds.). 2016. *Intonation in African tone languages*. Berlin: Mouton de Gruyter.
- Driemel, Imke & Jude Nformi. Forthcoming. Focus strategies in Limbum. In Elizabeth Bogal-Allbritten & Liz Coppock (eds.), *Proceedings of TripleA [the semantics of african, asian and austronesian languages] 4*. Tübingen: Universität Tübingen.
- Fiore, Lynne. 1987. *A phonology of Limbum*. Cameroon: SIL Cameroon.
- Fransen, Margo Astrid Eleonora. 1995. *A grammar of Limbum: A Grassfields Bantu language spoken in the North-West province of Cameroon*. Amsterdam: Vrije Universiteit. (Doctoral dissertation).
- Gjersøe, Siri, Jude Nformi & Ludger Paschen. 2016. The interaction of lexical tone and phrase-level intonation in Limbum. In *Speech prosody 2016*, 109–113. <http://dx.doi.org/10.21437/SpeechProsody.2016-23>. DOI:10.21437/SpeechProsody.2016-23
- Gussenhoven, Carlos. 2014. On the intonation of tonal varieties of English. In Markku Filppula, Juhani Klemola & Devyani Sharma (eds.), *The Oxford Handbook of World Englishes*. Oxford: Oxford University Press.
- Hayes, Bruce. 1989. Compensatory lengthening in moraic phonology. *Linguistic Inquiry* 20(2). 253–306.

- Hyman, Larry. 1985. *A theory of phonological weight*. Dordrecht: Foris.
- Hyman, Larry. 1986. The representation of multiple tone heights. In Koen Bogers, Harry Van der Hulst & Maarten Mous (eds.), *The phonological representation of suprasegmentals*, 109–152. Dordrecht: Foris.
- Hyman, Larry M. & Kemmonye C. Monaka. 2011. Tone and non-tonal intonation in Shekgalagari. In Sónia Frota, Gorka Elordieta & Pilar Prieto (eds.), *Prosodic categories: Production, perception and comprehension* (Studies in Natural Language and Linguistic Theory 82), 267–289. Springer.
- Inkelas, Sharon & Cheryl Zoll. 2007. Is grammar dependence real? A comparison between cophological and indexed constraint approaches to morphologically conditioned phonology. In *Linguistics*, vol. 45, 133–171.
- Jun, Sun-Ah (ed.). 2005. *Prosodic typology: The phonology of tone and intonation*. Oxford: Oxford University Press.
- Kiparsky, Paul. 2000. Opacity and cyclicity. *The Linguistic Review* 17. 351–367.
- Kula, Nancy C. & Silke Hamann. 2017. Intonation in Bemba. In Laura J. Downing & Annie Riailand (eds.), *Intonation in African tone languages*, vol. 24 (Phonology and Phonetics), 321–363. Berlin: De Gruyter.
- Orgun, Cemil Orhan. 1996. *Sign-based morphology and phonology: With special attention to Optimality Theory*. Berkeley, CA: University of California. (Doctoral dissertation).
- Pierrehumbert, Janet Breckenridge. 1980. *The phonology and phonetics of English intonation*. Cambridge, MA: MIT. (Doctoral dissertation).
- Prince, Alan & Paul Smolensky. 2004/1993. *Optimality Theory: Constraint interaction in Generative Grammar*. Wiley.
- Remijsen, Bert. 2013a.  $f_{0p}$ lotnormtraces. <http://www.lel.ed.ac.uk/~bert/praatscripts.html>.
- Remijsen, Bert. 2013b.  $f_{0i}$ rim&check. <http://www.lel.ed.ac.uk/~bert/praatscripts.html>.
- Sande, Hannah. 2017. *Distributing morphologically conditioned phonology: Three case studies from Guébie*. Berkeley, CA: University of California. (Doctoral dissertation).
- Snider, Keith L. 1999. *The geometry and features of tone*. SIL.
- Trommer, Jochen. 2015. Moraic affixes and morphological colors in Dinka. *Linguistic Inquiry* 46(1). 77–112.
- van Oostendorp, Marc. 2004. The theory of faithfulness. Amsterdam. <http://www.meertens.knaw.nl/medewerkers/marc.van.oostendorp/faithfulness.pdf>. Unpublished manuscript.

- van Oostendorp, Marc. 2006. A theory of morphosyntactic colours. Amsterdam. <http://egg.auf.net/06/docs/Hdt%7B%7DOostendorp%7B%7Dcolours.pdf>. Unpublished manuscript.
- Xu, Yi. 1999. Effects of tone and focus on the formation and alignment of  $f_0$  contours. *Journal of Phonetics* (27). 55–105.
- Yip, Moira. 1999. *Tone*. Cambridge: Cambridge University Press.
- Zhang, Jie. 2007. A directional asymmetry in Chinese tone sandhi systems. *Journal of East Asian Linguistics* 16. 259–302.
- Zimmermann, Eva. 2017. *Morphological length and prosodically defective morphemes*. Oxford: Oxford University Press.
- Zoll, Cheryl. 2003. Optimal tone mapping. *Linguistic Inquiry* 34(2). 225–268.



## Chapter 7

# Notes on the morphology of Marka (Af-Ashraaf)

Christopher R. Green

Syracuse University

Evan Jones

University of Maryland

This paper provides an overview of selected aspects of the nominal, pronominal, and verbal morphology of the Marka (Merca) dialect of Af-Ashraaf, a Cushitic language variety spoken primarily in the city of Merca in southern Somalia, as well as by several diaspora communities around the world, and in particular, in the United States. Marka is interesting to us for a variety of reasons, not the least of which is the general dearth of descriptive work on the language in comparison to two of its closest relatives, Somali and Maay. While many details of the structure of Somali are fairly well established (e.g., Bell 1953; Saeed 1999), and those of Maay are the subject of several recent works (e.g., Paster 2010; 2018), the various ways in which Marka relates to and/or differs from these languages, are yet poorly understood. Our goal in this paper is to begin to remedy this situation, beginning with a comparison of selected morphological characteristics across the three languages.

## 1 Introduction

This paper describes aspects of the morphology of Marka, a variety of Af-Ashraaf spoken in and around the city of Merca in Southern Somalia, as well as by diaspora communities in the United States and elsewhere. The data that we present are from our own fieldwork with our main consultant, a mother tongue speaker of Marka, conducted in three locations across the United States over a span of several years. The data were collected by the first author in Minneapolis, Minnesota, in October 2014 and in Phoenix, Arizona, in October 2015. Data were



also collected by the second author in Minneapolis in 2009 and 2010. These cities, among a few others in the United States, are home to sizable diaspora populations of Marka speakers.

Marka is one of two varieties of Af-Ashraaf, the other being Shingani, which is spoken primarily in and around the Somali capital, Mogadishu; Shingani is also sometimes called Xamar, which is the name locals attribute to Mogadishu itself. To our knowledge, there is one published theoretical article on Shingani which pertains to so-called “theme constructions” (Ajello 1984). There is also a self-published book of pedagogical materials for the dialect (Abo 2007) and a short grammatical sketch (Moreno 1953). There is less available for Marka; this includes an unpublished grammatical sketch [in German] (Lamberti 1980), and one article on aspects of its verbal inflection (Ajello 1988). In addition, both Ashraaf varieties are briefly mentioned in several classificatory works (as cited below) and in Banti (2011). Compared even to other African languages, the varieties of Af-Ashraaf are under-described and certainly under-documented.

In this paper, we present data highlighting certain morphological characteristics of Marka. Our immediate goal in this paper is to begin to establish (and in some instances reaffirm) characteristics of contemporary Marka. In order to better situate this language variety alongside two of its closest and better-described cousins, namely Somali and Maay, we provide comparable examples from these languages wherever possible. We believe that this is an important component of our ongoing work on Marka. While we have not yet explored it empirically, and despite all classifications of Ashraaf treating it as a dialect of Somali, our Marka speakers have intimated to us that both Marka/Somali and Marka/Maay intelligibility presents a challenge, though they deem Somali to be somewhat more intelligible to them than Maay. Our hope that by directly comparing these three languages throughout our ongoing research wherever possible, it will permit further discussion concerning the classificatory and structural relationships between them.

As we mention above, the Marka data that we present are our own. Comparative lexical and morphological data for Somali are drawn primarily from Green et al. (forthcoming), and the data therein are in line with other published sources on the language (e.g., Bell 1953; Saeed 1999). These data are from Northern Somali; hereafter, any reference to Somali refers to Northern Somali unless otherwise indicated. Corresponding Maay data are drawn from a recent grammatical sketch of the Lower Jubba variety of the language Paster & Ranero (2015), which itself is in line with other published materials on the language (e.g., Paster 2007; 2010; 2018). The comparative data that we present allow us to begin to draw some

generalizations, though preliminary, about morphological similarities and differences between Marka, Somali, and Maay. We highlight two unique characteristics of Marka that stand out in comparison to Somali and Maay; these include the morphological encoding of pluralization and grammatical gender.

The Marka data presented below are transcribed using the International Phonetic Alphabet (IPA). Somali data are given in the standard Somali orthography (Andrzejewski 1978); in this orthography, certain written symbols differ markedly from their IPA counterparts. These and their phonetic equivalents are as follows: c [ʃ], dh [d], kh [χ], x [h], j [tʃ], and sh [ʃ]. Although Maay does not have an official or standard orthography, we follow the conventions used in Paster & Ranero (2015) in presenting Maay data below. Like in the case of Somali, some Maay written symbols differ from their IPA counterparts. For Maay, these letters and their phonetic equivalents are as follows: j [tʃ], sh [ʃ], ny [ɲ], d' [d], y' [ʃ], and g' [g]. Data for all three languages include morpheme breaks which are indicated by a hyphen; finer-grained distinctions such as clitic boundaries are not indicated.

Arriving at a better understanding of Marka's place alongside Somali and Maay has broader implications, as its place (and of Af-Ashraaf, more broadly) in classifications of Lowland East Cushitic languages is not entirely clear. As we mention above, despite the fact that some classifications treat Ashraaf as a dialect of Somali, Marka and Somali appear not to have a high degree of mutual intelligibility, begging the question as to whether the former is properly classified as a dialect of the latter. Although it is not our intent to engage in a lengthy discussion of classification, we believe that it is nonetheless important to ground our paper in a short description of the state of the science concerning the internal classification of languages believed to be most closely related to Marka.

Generally speaking, there are several competing classifications concerning the composition of the so-called 'Somali' branch of the Lowland East Cushitic languages in the larger Afro-Asiatic language family (e.g., Abdhullahi 2000; Ehret & Ali 1984; Heine 1978; Lamberti 1984; Moreno 1955). Lamberti (1984) and Ehret & Ali (1984) are of importance to our interests, as they specifically refer to Ashraaf varieties in their classifications. Note that 'Somali' is the name of both the sub-group as a whole and of a language within the sub-group designated ISO:som in Lewis et al. (2016). Lamberti (1984) defines five dialect groups of 'Somali' wherein Ashraaf is considered a separate dialect group from both the better-described Northern and Benaadir Somali dialects. He further divides Ashraaf into Shingani and Lower Shabelle varieties, of which the latter is the Marka variety discussed elsewhere. Examples provided compare only the "peculiarities" (to use

Lamberti's term) of the Shingani variety to Af-Maxaad Tidhi (i.e., a group composed of Northern and Benaadir Somali), but no differentiation is provided pertaining to the Marka variety of Ashraaf, which is the focus of the current paper. Ehret & Ali (1984), on the other hand, group Xamar and Marka (i.e., Ashraaf) varieties with Benaadir Somali and little detail about their properties relative to one another or to other varieties/dialects is given. We certainly do not mean to imply that we are the first to look at Af-Ashraaf, nor is it our intent to engage in a classification debate in this paper, but we believe that there is much more to learn about the properties of this language group (i.e., Af-Ashraaf's two constituent varieties, Shingani and Marka) and its relationship to its closest relatives. In order to begin to do so, we turn our attention first in this paper to properties of Marka morphology.

## 2 Nominal morphology

Singular nouns in Marka are unmarked, and their plural counterparts are all formed by the addition of the suffix *-(r)ajjo* wherein an epenthetic rhotic appears after vowel-final stems. We illustrate in Table 1 that Marka adopts a single strategy to pluralize nearly every noun. The exception to this is a few high frequency nouns that are used in proverbs whose plurals are identical to those found in Somali (e.g., *ilig* 'tooth' vs. *ilko* 'teeth'). Corresponding Somali plurals are provided for comparison, wherever possible. The fact that outside of these few outliers, Marka adopts a single pluralization strategy distinguishes it from both Somali and Maay. This is because Somali adopts at least five different pluralization strategies (e.g., suffixation of *-o* or *-yaal*, partial suffixing reduplication, tonal accent shift, and both broken and sound pluralization in some Arabic borrowings), while Maay adopts two or three, depending on the particular noun (Paster 2010), all of which involve suffixation.

Like Somali and Maay, Marka encodes two grammatical genders in its nominal system: masculine and feminine. Nouns have inherent gender, however, there is no overt segmental indication of gender on nouns themselves. Rather, a given noun's grammatical gender is recoverable from the patterns of agreement that it requires on its modifiers. This can be seen, for example, in definite determiners, wherein the initial consonant of the determiner (except in one context discussed below) reveals the noun's gender. These consonants, however, often alternate following particular stem-final segments. The masculine definite determiner is *-e* after liquids and pharyngeals and *-ke* in most other contexts. The feminine definite determiner is *-de* after [d] and pharyngeals and *-te* in most other instances.

Table 1: Pluralization

Marka Singular		Marka Plural		Somali plural
dabaal	fool	dabaal-ajno	fools	dabbaal-o
af	language	af-ajno	languages	af-af
karfin	tomb	karfim-ajno	tombs	
khoor	necks	khoor-ajno	necks	qoor-ar
mind	knife	mind-rajno	knives	mind-yo
maro	head	mara-rajno	heads	madáx
guddoomije	chairman	guddoomija-rajno	chairmen	guddoomiya-yaal

Following vowel-final stems, the definite determiner is always *-re*, even in association with those nouns that are biologically masculine or feminine. This points towards a neutralization of the morphological encoding of gender in such contexts. Thus, both masculine and feminine nouns whose stem ends in a vowel take the definite determiner *-re*. In addition, and as one might expect, certain nouns are free to change their gender in accord with the biological gender of their referent, as in *saaxibke* ‘the (male) friend’ vs. *saaxibte* ‘the (female) friend.’ Examples of Marka masculine and feminine singular nouns in their indefinite and definite forms are in Table 2.

Table 2: Grammatical gender and definite determiners (Marka)

	Indefinite		Definite	
Masculine:	nin	‘man’	nin-ke	‘the man’
	saŋ	‘nose’	saŋ-ke	‘the nose’
	abti	‘maternal uncle’	abti-re	‘the maternal uncle’
	dabaal	‘fool’	dabaal-e	‘the fool’
	gasaŋ	‘can’	geseŋ-e	‘the can’
Feminine:	maaliŋ	‘day’	maalin-te	‘the day’
	kab	‘shoe’	kab-te	‘the shoe’
	irbad	‘needle’	irbad-de	‘the needle’
	saddex	‘three’	saddex-de	‘the three’
	iŋgo	‘mother’	iŋga-re	‘the mother’

Although there is no overt gender marking on Marka nouns, it appears at least preliminarily that the accentual gender distinction found in Somali is maintained in Marka. As discussed in detail in Hyman (1981) and Green & Morrison (2016), Somali nouns exhibit a tonal accent on either their final or penultimate mora; the mora is the tone and accent bearing unit in the language. It is typically the case that non-derived masculine singular nouns have a tonal accent on their penultimate mora while non-derived feminine singular nouns have a tonal accent on their final mora. Like Somali, Marka appears to exhibit this same phenomena, as seen for example in a comparison of masculine *kárfín-ke* ‘the tomb’ and feminine *mindí-re* ‘the knife.’ This accentual distinction is helpful in determining the grammatical gender of nouns with vowel-final stems. Compare, for example, the masculine noun *sánno* ‘year’ to the feminine noun *mindí* ‘knife,’ both of which take the same definite determiner *-re*. Their corresponding definite forms are *sánna-re* ‘the year’ and *mindí-re* ‘the knife.’

While Marka maintains a fairly clear distinction between masculine and feminine grammatical gender in singular nouns, whether segmental, accentual, or both, this distinction is lost upon pluralization. That is, all plural nouns require feminine gender agreement. This characteristic distinguishes Marka from both Somali and Maay. Somali has a complex grammatical gender system; following the noun classification adopted in Green et al. (forthcoming), nouns in Classes 1c and 2 maintain the same gender in both the singular and plural, while nouns in Classes 1a, 1b, 3, 4, and 5 exhibit so-called *gender polarity* (Meinhof 1912) where a noun’s gender changes from masculine to feminine (or vice versa) upon pluralization. Maay, on the other hand, also collapses its grammatical gender distinction in nouns upon pluralization, but unlike Marka which levels gender to feminine, all Maay plural nouns are masculine. A summarized comparison of these three systems is in Table 3.

In addition to the definite determiners described above, Marka has four additional determiner which can modify nouns. The initial consonant of each determiner alternates under the same conditions described above for definite determiners. There are two demonstrative determiners: *koy/toj* ‘this’ and *kaas/taas* ‘that.’ These have direct correspondents in both Somali and Maay, although Somali has an additional distal demonstrative to point out ‘that yonder.’ The Marka interrogative determiner is *kee/tee* ‘which?’, which, once again, has direct correspondents in both Somali and Maay. Like Somali, Marka exhibits so-called *remote* or *anaphoric* definite determiners, namely *kii/tii*. In Somali, these are described as being associated with past tense referents (Lecarme 2008; Tosco 1994). They appear to instead have a disambiguating function in Marka, which we gloss as ‘the/that (one) X.’ In addition, Marka has a determiner, *koo/too*, that speakers use

Table 3: Grammatical gender – singular vs. plural

Marka	Somali	Maay	Gloss
igaar	inan	dinaŋ	‘boy’
igaare (m)	inanka (m)	dinaŋki (m)	‘the boy’
igaarajno	inammo	dinamo/dinanyyal/dinamoyal	‘boys’
igaarajte (f)	inammada (f)	dinamoŋi/dinanyyalki/ dinanmoyalki (m)	‘the boys’
naag	naag	bilanŋ	‘woman’
naagte (f)	naagta (f)	bilanti (f)	‘the woman’
naagajno	naago	bilamo/bilanyyal/bilamoyal	‘women’
naagajte (f)	naagaha (m)	bilamoŋi/bilanyyalki/ bilamoyalki (m)	‘the women’

Table 4: Possessive determiners

	Marka	Somali	Maay
1SG	kee/tee	kay/tay	key/tey
2SG	kaa/taa	kaa/taa	ka/ta
3SG.M	kiis/tiis	kiis/tiis	y’e/tis
3SG.F	kiife/tiife	keed/teed	y’e/tie
1PL	kaŋ/taŋ	kayo/tayo (exc.) keen/teen (inc.)	kaynu/taynu
2PL	kiin/tiin	kiin/tiin	kiŋ/tiŋ
3PL	kiifoŋ/tiifoŋ	kood/tood	y’o/tio

to point out an item that the speaker knows about but the hearer does not. There is a great deal of similarity in the determiners discussed thus far when comparing Marka to both Somali and Maay; however, the possessive determiners in each are more divergent. Possessive determiners in the three varieties are shown in Table 4; they are presented in masculine/feminine pairs in their default forms. Note that Marka and Maay lack the exclusive vs. inclusive distinction encoded in Somali for first person plural. Also, third person masculine possessive determiners in both the singular and plural in Maay differ greatly from those found in both Somali and Marka.

Concerning the derivational morphology that can be added to nouns, there are several parallels between Marka and Somali; the following list should not be taken as exhaustive. Thus far, we find that there are two Marka suffixes, *-nimo* and *-ija*, that derive abstract nouns. Examples include: *ħurnimo* ‘freedom’ (cf. *ħur* ‘free’) and *insaanija* ‘humanity’ (cf. *insaan* ‘human’). These correspond to *-nimo* and *-iyad* in Somali. The Somali suffix *-tooyo*, which derives stative abstract nouns is absent in Marka, and we have not yet been able to find another morpheme that accomplishes this function. The Marka suffix *-dari* derives antonyms, as in *naħariisdari* ‘merciless’ (cf. *naħaris* ‘mercy’); this corresponds to *-darro* in Somali, which accomplishes the same function. The Marka suffix *-lo* corresponds to Somali *-le* and is used to derive agentive nouns, as in *dukaanlo* ‘store owner’ (cf. *dukaan* ‘store’). Finally, we have found that inchoative and experiencer verbs can be derived from nouns in Marka via the suffixes *-wow* and *-fow*, respectively, as in *duqowow* ‘to become old’ (cf. *duq* ‘elder’) and *rijořow* ‘to have a dream’ (cf. *rijo* ‘dream’).

### 3 Pronouns

Marka has a single series of subject pronouns which are inflected for person, number, and for biological gender with human referents; Marka does not encode an exclusive vs. inclusive distinction in its first person plural subject pronouns. Marka subject pronouns may be used independently whereupon they take on characteristics similar to other nouns. In addition, they may also cliticize to complementizers and negative markers under some conditions. A comparison between subject pronouns in Marka, Somali, and Maay is in Table 5. In addition to these subject pronouns, Marka (like Somali) has a non-specific subject pronoun, *la*.

Table 5 reveals that there are many similarities across the three language varieties under consideration regarding their subject pronouns. A comparison of their object pronouns in Table 6, however, shows far fewer similarities in this particular category. To begin, Somali has so-called *first series* (OP1) and *second series* (OP2) object pronouns, the latter of which appear only in those instances where two non-third person pronominal objects are required. Somali maintains an exclusive vs. inclusive distinction in both series of its object pronouns; neither Marka nor Maay encode such a distinction, and both have only a single series of object pronouns. Both series of Somali object pronouns have third person gaps in both the singular and plural. Marka and Maay differ in that each has third person object pronouns. While Marka’s third person object pronouns appear innovative



Table 5: Subject pronouns

	Marka	Somali	Maay
1SG	aan	aan	ani
2SG	at	aad	ađi
3SG.M	uus	uu	usu
3SG.F	ishe	ay	ii
1PL	annuŋ	aannu (exc.) aynu (inc.)	unu
2PL	asiin	aydin	isiŋ
3PL	ishoon	ay	iyo

in all instances, the situation with Maay is somewhat different. A comparison of Maay subject vs. object pronouns in Tables 5 and 6 shows that they are in many instances identical. The exception of the first and second person singular, and the second person plural to some degree. In addition to its other object pronouns, Marka has the reflexive/reciprocal pronoun *is*, similar to that found in Somali.

Table 6: Object pronouns

	Marka	Somali (OP1)	Somali (OP2)	Maay
1SG	iŋ	i	kay	i
2SG	ku	ku	kaa	ki
3SG.M	su	-	-	usu
3SG.F	sa	-	-	ii
1PL	nuŋ	na (exc.) ina (inc.)	kayo (exc.) keen (inc.)	unu
2PL	siin	idin	kiin	isiŋ-siŋ
3PL	soo	-	-	iyo

Marka object pronouns cliticize onto adpositional particles, of which there are three. Object pronouns also co-occur with a non-specific subject pronoun (NSP) meaning ‘one.’ We notice no prosodic difference between them, but according to our speaker’s intuition, sequences of NSP+object pronoun are divisible, while object pronoun+adposition are a single unit. Examples are in Table 7.

Table 7: Pronouns with adpositional particles (Marka)

	Object pronoun	NSP	ka ‘in/from’	u ‘to/for’	la ‘with’
1SG	ij	la ij	ijka	iiij	inla
2SG	ku	la ku	kuka (koo)	kuuj	kula
3SG.M	su	la su	suka	suuj	sula
3SG.F	sa	la sa	saka	saaj	sala
1PL	nuj	la nuj	nujka	nuuj	nunla
2PL	siin	la siin	siijka	siij	siinla
3PL	soo	la soo	sooka	sooj	soola

## 4 Verbal morphology

The simplest Marka verbs are formed by a single verbal base. These simple bases may contain just the verb root itself, but more complex bases can contain one or more derivational affixes, such as a Weak Causative, Middle, or even a combination of the two. Suffixes inflecting for person, number, and gender follow the stem. Marka has two verb contexts with a single verbal base, namely the Present Habitual and Past Simple. These contexts correspond to the Present Habitual and Simple Past in Somali (Green et al. forthcoming), and to the Simple Present A and Simple Past in Maay (Paster & Ranero 2015). Like both Somali and Maay, inflection in Marka for first person singular and third person masculine singular are identical. Likewise, inflection for second person singular and third person feminine singular are identical. The basic inflectional properties of Marka verbs for four stem types (Bare, Weak Causative, Weak Causative + Middle, and Middle) are given in Table 8, which shows inflection for the Present Habitual and Table 9, which shows inflection for the Past Simple.

Other contexts (e.g., Present Progressive, Past Progressive, Past Habitual, and Assumptive) are formed via auxiliary constructions containing two verbal bases; the first base is the infinitival form of the main verb which is, in turn, followed by an inflected form of an auxiliary verb. These are comparable to those found in Somali (Green et al. forthcoming), and also to the Present Progressive, Past Progressive, and Generic Future in Maay (Paster & Ranero 2015); exceptions, however, include the Near Future and Conditional in Maay, in which both the main verb and auxiliary are inflected.

In the Marka Present Progressive, the infinitival main verb is followed by an inflected Present Habitual form of *rebo* ‘to do.’ For the Past Habitual, the main

7 Notes on the morphology of Marka (Af-Ashraaf)

Table 8: Present Habitual (Marka)

	Bare 'see'	WeakCaus 'cook'	WeakCaus+Middle 'sell'	Middle 'sink'
1SG/3SG.M	deje	karife	iibsade	ɖubme
2SG/3SG.F	dejte	karise	iibsate	ɖubmate
1PL	dejne	karine	iibsane	ɖubmane
2PL	dejtiin	karisiin	iibsatiin	ɖubmatiin
3PL	dejaan	karifaan	iibsadaan	ɖubmadaan

Table 9: Past Simple (Marka)

	Bare 'see'	WeakCaus 'cook'	WeakCaus+Middle 'sell'	Middle 'sink'
1SG/3SG.M	deji	karifi	iibsadi	ɖubmi
2SG/3SG.F	dejti	karisi	iibsati	ɖubmati
1PL	dejni	karini	iibsani	ɖubmani
2PL	dejteen	kariseen	iibsateen	ɖubmateen
3PL	dejeen	karifeen	iibsadeen	ɖubmadeen

verb infinitive is followed by an inflected Past Simple form of *jiro* 'to be, exist.' The Past Progressive and Assumptive are similar in that they involve Present Habitual and Past Simple forms of *rejo*, respectively; the precise meaning of this verb is unclear. In the interest of space, we illustrate the formation of only one auxiliary construction, the Present Progressive of *sugo* 'to wait,' in Table 10.

Table 10: Auxiliary constructions – Present Progressive (Marka)

	Marka	Gloss
1SG/3SG.M	sugo rebe	'I am/he is waiting'
2SG/3SG.F	sugo rebte	'you are/she is waiting'
1PL	sugo rebne	'we are waiting'
2PL	sugo rebtiin	'you (PL) are waiting'
3PL	sugo rebaan	'they are waiting'

Marka creates stative verbs via an auxiliary construction composed of an adjective or adjectival participle followed by an inflected form of the irregular verb *ahaan* ‘to be.’ Such stative verbs are used in instances where one might find an attributive or predicate adjective in other languages. In our description of Marka, we follow others (e.g., Andrzejewski 1969; Ajello & Puglielli 1988) who have called such verbs in Somali *hybrid verbs*, although other names have also been used elsewhere in the literature. Paster & Ranero (2015) refer to such verbs as the Simple Present B in Maay. For the sake of comparison, one might encounter *Way adagtahay* ‘It is difficult’ in Somali, which is similar in form to *Ani farahsiny-ya* ‘I am happy’ in Maay. In Marka, the situation is similar, as in *Uus weynye* ‘It is big.’ In each of these examples, the adjectival portion of the auxiliary construction is italicized.

Like in Maay (and some southern dialects of Somali), all verbal inflection in Marka is accomplished via suffixation. Northern Somali, however, maintains a small class of four irregular verbs whose inflection is accomplished through prefixation in non-auxiliary contexts. These include *ool* ‘to be located,’ *odhan* ‘to say,’ *oqoon* ‘to know,’ and *imow* ‘to come.’ These four verbs correspond to *jaalo* ‘to be located,’ *qoho* ‘to say,’ *aqaano* ‘to know,’ and *imafo* ‘to come,’ in Marka. Table 11 compares inflection in Northern Somali vs. Marka in the Past Simple and the Past Progressive for the verb ‘to say.’ In the Past Simple, this irregular verb is inflected via prefixation in Somali, while in Marka, inflection is via suffixation. Both languages employ an auxiliary construction in the Present Progressive.

Table 11: Northern Somali vs. Marka – ‘to say’

	Past Simple		Past Progressive	
	Somali	Marka	Somali	Marka
1SG	idhi	q̄ihi	odhanayay	q̄oho reji
2SG/3SG.F	tidhi	q̄ahti	odhanaysay	q̄oho reti
3SG.M	yidhi	q̄ahji	odhanayay	q̄oho reji
1PL	nidhi	q̄ahni	odhanaynay	q̄oho reni
2PL	tidhaahdeen	q̄ahteen	odhanayseen	q̄oho reteen
3PL	yidhaahdeen	q̄ahjeen	odhanayeen	q̄oho rejeen

Inflection in Marka of the verb *ahaaf* ‘to be’ is irregular. Table 12 shows that ‘to be’ is conjugated as expected in auxiliary contexts like the Past Progressive, instances and differs somewhat in the Present Habitual compared to other verbs in maintaining a unique third person singular masculine form (see

Table 8). For the Past Simple, Marka has a single invariable form of 'to be' for all person/number/gender combinations.

Table 12: Inflection of 'to be' (Marka)

	Past Simple	Present Habitual	Past Progressive
1SG	ahaaj	ije	ahaadeje
2SG/3SG.F	ahaaj	ite	ahaadete
3SG.M	ahaaj	ije	ahaadeje
1PL	ahaaj	ine	ahaadene
2PL	ahaaj	itiin	ahaadetiin
3PL	ahaaj	ijaan	ahaadejaan

A last point pertaining to verbal morphology in Marka verbs concerns reduplication. Partial prefixing reduplication is used to indicate intensity or iteration of action in some verbs. When this occurs, the maximum size of the reduplicant appears to be CVV; for example, *dhadhaqaaqo* 'to move about restlessly, fidget.' In such instances of reduplication, Marka remains faithful to the underlying quality of the vowel in its reduplicants. We have found that Marka also employs total prefixing reduplication to derive an adjective from a noun, as in *buurbuur* 'mountainous' (cf. *buur* 'mountain').

## 5 Concluding thoughts

This paper offers a renewed look at the nominal, pronominal, and verbal morphology of the Marka variety of Af-Ashraaf. While we have not yet had the opportunity to conduct a systematic comparison of Marka and its closest relative, Shingani, we have taken the first steps to compare Marka directly to two of its better-known and better-documented relatives, Maay and Somali. Marka shares characteristics with both Somali and Maay, but conclusions concerning the extent to which Marka aligns more closely with one or the other must await further research. At present, we endeavor to highlight those properties of Marka that distinguish it from both Somali and Maay, such as its methods of encoding pluralization and gender. While there is most certainly a great deal more work to be done, we hope that this short description lays the foundation for further inquiries into Marka grammar and provides those with interest in the ongoing debate concerning the internal classification of East Cushitic languages new information upon which to justify their analyses.

## Abbreviations

CAUS	causative	NSP	non-specific subject pronoun
EXC	exclusive	OP	object pronoun
F	feminine	PL	plural
INC	inclusive	SG	singular
M	masculine		

## References

- Abdullahi, Mohamed Diriye. 2000. *Le somali, dialectes et histoire*. Université de Montréal. (PhD dissertation).
- Abo, Sharif Ahmed Omar. 2007. *Ilmaaytaan ha bartaan afaan Xamar (Let our children learn our dialect of Hamar)*. London: self-published.
- Ajello, Roberto. 1984. Il focus nell'idioma degli Ashraaf di Shingaani. In Annarita Puglielli (ed.), *Aspetti morfologici, lessicali e della focalizzazione*, 135–146. Rome: Ministero degli Affari Esteri-Dipartimento per lo Cooperazione allo Sviluppo.
- Ajello, Roberto. 1988. Theme constructions in Af Ashraaf and Standard Somali. In Annarita Puglielli (ed.), *Proceedings of the Third International Congress of Somali Studies*, 78–89. Rome: Il Pensiero Scientifico Editore.
- Ajello, Roberto & Annarita Puglielli. 1988. More on hybrid verbs and other grammatical categories in Somali. In Marianne Bechaus-Gerst & Fritz Serzisko (eds.), *Papers from the International Symposium on Cushitic and Omotic languages*, 537–554. Hamburg: Helmut Buske.
- Andrzejewski, Bogumił W. 1969. Some observations on hybrid verbs in Somali. *African Language Studies* 10. 47–89.
- Andrzejewski, Bogumił W. 1978. The development of a national orthography in Somalia and the modernization of the Somali language. *Horn of Africa* 1. 39–45.
- Banti, Giorgio. 2011. Somali. In Siegbert Uhlig (ed.), *Encyclopaedia Aethiopica*, vol. 4, 693–696. Wiesbaden, Germany: Harrassowitz.
- Bell, Christopher. 1953. *The Somali language*. Hants, UK: Gregg International.
- Ehret, Christopher & Mohamed Nuuh Ali. 1984. Soomaali classification. In Thomas Labahn (ed.), *Proceedings of the Second International Congress of Somali Studies*, 201–269. Hamburg: Helmut Buske.
- Green, Christopher R. & Michelle E. Morrison. 2016. Somali wordhood and its relationship to prosodic structure. *Morphology* 26. 3–32.
- Green, Christopher R., Michelle E. Morrison & Nikki B. Adams. Forthcoming. *A grammar of Common Somali*. Berlin: Mouton de Gruyter.

- Heine, Bernd. 1978. The Sam languages: A history of Rendille, Boni, and Somali. *Afroasiatic Linguistics* 6. 23–115.
- Hyman, Larry M. 1981. Tonal accent in Somali. *Studies in African Linguistics* 12. 169–203.
- Lamberti, Marcello. 1980. *Der Dialekt von Dinsor Af-Dabarro*. Köln: Institut für Afrikanistik, Ms.
- Lamberti, Marcello. 1984. The linguistic situation in the Somali Democratic Republic. In Thomas Labahn (ed.), *Proceedings of the Second International Congress of Somali Studies*, 155–200. Hamburg: Helmut Buske.
- Lecarme, Jacqueline. 2008. Tense and modality in nominals. In Jacqueline Guéron & Jacqueline Lecarme (eds.), *Time and modality*, 195–225. Amsterdam: Springer.
- Lewis, M. Paul, Gary F. Simon & Charles D. Fennig. 2016. *Ethnologue: Languages of the world, 19th edition*. Dallas, Texas: SIL International.
- Meinhof, Carl. 1912. *Die Sprachen der Hamiten*. Hamburg: L & R Friederichsen.
- Moreno, Marcelo M. 1953. Il dialetto di Ashraf di Mogadiscio. *Rassegna di Studi Etiopici* 10. 99–107.
- Moreno, Marcelo M. 1955. *Il somalo della Somalia, grammatica e testi del Benadir, Darod e Dighil*. Roma: Istituto Poligrafico dello Stato.
- Paster, Mary. 2007. Aspects of Maay phonology and morphology. *Studies in African Linguistics* 35. 73–120.
- Paster, Mary. 2010. Optional multiple plural marking in Maay. In Franz Rainer, Wolfgang U. Dressler, Dieter Kastovsky & Hans Christian Luschützky (eds.), *Current issues in linguistic theory 310: Variation and change in morphology*, 177–192. Amsterdam: John Benjamins.
- Paster, Mary. 2018. Gender instability in Maay. In Jason Kandybowicz & Harold Torrence (eds.), *Selected proceedings of the 45th Annual Conference on African Linguistics*, 205–218. Berlin: Language Science Press.
- Paster, Mary & Rodrigo Ranero. 2015. *CASL introductory structural sketches for African languages: Maay*. University of Maryland-CASL, Technical Report 2.9b, DO50.
- Saeed, John I. 1999. *Somali*. Amsterdam: John Benjamins.
- Tosco, Mauro. 1994. On case marking in the Ethiopian language area (with special reference to subject marking in East Cushitic). In Vermondo Brugnatelli (ed.), *Sem Cam Iafet*, 225–244. Milan: Centro Studi Camito-Semitici.





## Chapter 8

# Implosives in Bantu A80? The case of Gyeli

Nadine Grimm

University of Rochester

Implosive consonants in Bantu A80 languages are widely attested in the literature. The status that specific authors assign to them, however, differ significantly, ranging from mere phonetic contrasts to phonemic status or even absence in certain languages. Given this variety of language analyses, along with a controversy about necessary and sufficient features of implosive sounds, this paper aims at re-assessing the range of implosives and non-implosives within A80 and especially Gyeli (A801). I show that though implosives are expected in Gyeli from previous literature, these sounds are better described as pre-glottalized stops with a relatively long prevoicing time. That raises the question whether this analysis might be more appropriate for other A80 languages as well. While this paper cannot provide any conclusive answer on the latter question, it hopes to raise awareness of the methodological problems associated with the present description of A80 implosives, encouraging a systematic re-evaluation of the data. It also encourages a discussion on how the general fieldworker should go about describing implosive(-like) sounds.

## 1 Introduction

The occurrence of implosives is areally expected in northwestern Bantu, as Clements & Rialland (2008: 58) have shown. Implosives have also been reported for several Bantu A80 languages, including Mpiemo, Shiwa, Kola, and Bekwel. Most authors agree that implosives in A80 languages have phonetic rather than phonemic status, but differ in how they view the relation between implosives and voiced stops, e.g., whether /b/ is an allophone of /b/ or whether a language lacks /b/ altogether. There are also cases where different authors do not agree on the



presence or absence of implosive sounds in the same language, namely in Gyeli and Shiwa. This differing treatment of implosives in the A80 literature raises the question whether these consonants really are implosives in the first place in all of these languages.

Data from Gyeli, an endangered and understudied Bantu A80 language spoken by “Pygmy” hunter-gatherers in southern Cameroon, suggests that consonants which could be taken to be implosives are better described as phonemic voiced plosives that are phonetically realized with pre-glottalization and relatively long prevoicing, typically found in stem-initial position. During prevoicing, speakers expand their cheeks, increasing both the vocal tract size and amplitude before release of the voiced plosives /b, d/. The effects of this realization can easily be mistaken for an implosive, given that both implosives and pre-glottalized stops involve the manipulation of the larynx and the resulting waveform looks in many cases like that of a typical implosive. The cheek expansion clearly indicates, however, that the airstream mechanism in Gyeli is egressive. The case of pre-glottalized voiced stops in Gyeli may serve as a starting point to reconsider special voiced stops in A80 languages and clarify the status of implosives, at least in some languages.

In the remainder of the Introduction, I will critically review definitions of implosives provided by the literature and introduce the Gyeli language. In §2, I present the distribution of implosives and their phonetic/phonemic status in Bantu A80 languages. §3 provides a detailed discussion of voiced stops in Gyeli, while §4 concludes this paper and gives an outlook on future work that is needed.

### **1.1 Definitions of ‘Implosives’ in the literature**

The average linguist venturing out into the field to describe an under-studied language has to be knowledgeable in all parts of grammar they intend to describe. More often than not, they are not necessarily expert phoneticians, though, and describing phenomena such as implosives, which have long been a source of controversy, can be very challenging. This is due to i) an apparently different airstream mechanism that was hard to perceive by some early linguists and ii) the nature of phonetic variation ascribed to implosives. Xi (2009), who gives an excellent overview of the historical development of implosive studies, points out that many linguists have had difficulties in accurately describing implosives because they were perceptually used to a pulmonic airstream mechanism. According to her, prior to the recognition of a glottalic airstream, these sounds were often described as pre-glottalized, laryngealized, or pre-nasalized stops which had a long-lasting impact, especially on descriptive linguists.

In order to analyze and name encountered phenomena as best as they can, descriptivist fieldworkers try to have a good understanding of at least the essential literature on specific topics. Textbook definitions often seem to come in handy, especially in terms of terminological issues and definitions. Textbook definitions typically summarize core features that are widely agreed upon in defining implosive sounds. Generally speaking, implosives seem to be plosives which are produced with an ingressive airstream due to larynx lowering. This view is represented, for instance, by Crystal (2008: 228), who states in his *Dictionary of Linguistics and Phonetics* that, “[the term implosives] refers to the series of PLOSIVE sounds it is possible to make using an airstream mechanism involving an inwards movement of air in the mouth (an INGRESSIVE AIRSTREAM).” Also general introductions to linguistics emphasize the ingressive airstream as a defining feature of implosives, for example by McGregor (2015: 41): “Implosives are produced by pulling the larynx downwards during oral closure, and releasing the oral closure, resulting in an audible inrush of air.” In earlier classic textbooks, another assumed property of implosives was included in the definition, namely a glottalic airstream mechanism, as in, for instance, Fromkin & Rodman (1998).

The realization of phonemic segments are variable, however, and not every sound that is classified as an implosive is realized the same way, which has been noted already by, for instance, Greenberg (1970). This becomes very clear when looking at the phonetics literature where each of the defining core criteria for implosives have been challenged. Especially for sounds that seem to be at the fringe of an abstract implosive category, authors tend to give much wider definitions or, at least, question the relevance of any seemingly defining feature. There is controversy about categorizing ‘unusual’ implosives, encompassing all core features, namely i) airflow mechanism, which could be ingressive vs. potentially egressive and glottalic vs. not necessarily glottalic, ii) manner of articulation, which has been described as plosive vs. sonorant vs. non-obstruent, and iii) larynx lowering, which does not seem to be sufficiently defining, but a matter of degree.

In the *World Atlas of Language Structures*, a reference for typology and cross-linguistic comparison, Maddieson (2013) describes implosives as stops produced with a downward movement of the larynx, including the possibility of an inward airflow. Thus, an ingressive airflow is not a necessary, but an optional feature. Also Ladefoged & Maddieson (1996: 82) stress that the presence or absence of negative intra-oral pressure is a variable phonetic feature, proposing “a gradient between one form of voiced plosive and what may be called a true implosive.” Lindau (1984) states that implosives may be non-glottalized, involving no glottal closure. Clements & Rialland (2008: 56) support this view, stating that “implosives

cannot be neatly distinguished from non-implosive sounds in terms of an alleged glottalic airstream mechanism.”

Even the manner of articulation in implosives has been challenged. Clements (2000) views implosives as sonorants rather than stops. Later on, Clements & Osu (2002) define implosives rather as non-obstruent (non-explosive) stops which lack a build-up of air pressure, resulting in a weak burst at release.

Finally, a lowering of the larynx appears in many definitions of implosives which might then seem to be the only criterion left in defining implosives. Ewan & Krones (1974), however, hold that larynx lowering is not unique to implosives, but also found in certain voiced stops of English or French. As such, larynx lowering is not a sufficient feature. As with all other proposed phonetic properties of implosives, larynx lowering is also subject to variation, involving more or less lowering which, in turn, may have different effects on the airstream and blur the lines between voiced stops and implosives. Thus, Xi (2009: 11) explains that, “if the degree of lowering the larynx is attenuated, implosives are likely to change to voiced stops. Alternatively, for voiced stops, if the pre-voicing is prolonged by enlarging the supra-glottal cavity, it would drive the voiced stops change to implosives.”

This controversy reflects a larger issue pertaining to the nature of categories: to what degree can the phonetic details of a category in one language be assumed to hold for the phonetic details of the same category in other languages? The short answer is that it can be assumed that there are likely to be differences. Even closely related languages such as Bantu A80 display different realization rules for the same segment, as is evident from the literature (see §2). What we do not know is the extent to which phonetic details of e.g., , plosives or implosives differ in terms of voicing details, energy of burst, or aspiration because the relevant literature does not give any information on this. Differences are, however, expected, as are similarities.

Knowing about the phonetic details of a segment in one language can serve as a starting point to investigate and/or re-evaluate categories and their extension across (related) languages, provided that their phonetic details become known as well. Ultimately, this will help answer questions on how we can establish categories for cross-linguistic comparison, given the wide range of phonetic variation, and how telling these categories are.

This brings us back to the practical issues of the descriptive fieldworker. How does one know, given all the within-category variation, that one is dealing with a realization of that category or something different? In this paper, I explore this question with a class of sounds in Gyeli that resemble implosives, but which I argue are pre-voiced stops, based on phonetic analysis rather than on perceptual

intuitions only. Assuming the generally agreed-upon core features of implosives—ingressive airstream, larynx lowering, and plosive manner of articulation—I will show that Gyeli prevoiced stops do not meet the criteria of ingressive airstream and larynx lowering, but that auditory effects similar to implosives are achieved through glottalization, prevoicing, and cheek expansion.

## 1.2 The Gyeli language and data

While I discuss implosive sounds across Bantu A80 languages in this paper, Gyeli is the main language of analysis and the only language for which I have first-hand data. In this section, I briefly provide some basic information on the language and my methodology.

Gyeli is a Bantu A80 language (A801, following Maho 2009) spoken in southern Cameroon by so-called “Pygmy” hunter-gatherers. The language is known under a variety of names, including Bakola, Bagyeli, and Bajele. There are about 4000–5000 speakers who currently still transmit the language to their children. Nevertheless, Gyeli is classified as an endangered language due to a rapidly changing environment that forces speakers to give up their traditional foraging subsistence strategy, adopting farming practices from neighboring agriculturalist Bantu groups. In total, Gyeli has eight contact languages, the most prominent of which are Kwasio (A80) as Gyeli’s closest relative, Bulu (A70), and Basaa (A40). Currently, several Gyeli dialects are emerging, depending on the main contact language of regional Gyeli group.

Previous literature on Gyeli comprises a few grammatical descriptions of different Gyeli varieties which also differ in terms of their degree of coverage. The most substantial work comes from Grimm (2015) who provides a complete grammar of the variety spoken in Ngolo, i.e., the Bulu contact region. An earlier description of ‘Bajele’ by Renaud (1976) investigates the phonology and nominal morphology of the Gyeli variety spoken around Bipindi, i.e., in the Kwasio area. There is also an unpublished manuscript on the dialect of Lebdom, i.e., the Basaa contact region, by Ngue Um (2012). Other linguistic work on Gyeli include an ethnobotanic study of tree names by Letouzey (1995) and a study of color category innovation in language contact by Grimm (2014). There are no previous phonetic studies of Gyeli other than Renaud’s (1976) observations in his phonological description.

Data on the Gyeli language stems from my own fieldwork conducted in Cameroon between 2010 and 2014. The analysis of the relevant sounds (voiced plosives which are potential candidates for implosives) was done including both tokens from carefully pronounced word list recordings and tokens from natural text.

## 2 Implosives in Bantu A80

When describing a language, related and neighboring languages can give valuable hints as to what one might expect to find. In the case of Gyeli, one might expect to find implosive sounds. Implosives are attested in Bantu A80 languages as well as more broadly in northwestern, eastern coastal, and southeastern Bantu languages. Maddieson (2003: 28) states that these languages often have at least one implosive, which is most frequently a bilabial. According to him, Bantu implosives have certain phonetic features in common. First, they are typically produced without glottal constriction. And second, lowering of the larynx is crucial in Bantu implosive production, having a double effect. On the one hand, the lowering increases the amplitude of vocal fold vibration during closure, resulting in a strong voicing at the release. On the other hand, the larynx lowering during production causes an ingressive airstream.

Taking these diagnostics into account, when analyzing implosive sounds in spectrograms and waveforms, there are a few things one would expect to find, and also a few that one would *not* expect to find. In terms of the absence of glottalization, there should be no indication of a glottal closure. A glottal closure might be visible through a higher amplitude in the waveform or signs of ‘noise’ in the spectrogram. A glottal closure can, however, also be indicated by the absence of a visible stop closure altogether when it accompanies another stop, since overlapping gestures of glottal and other stop closures might result in the “suppression of any audible burst or frication when it is released,” as Ladefoged & Maddieson (1996: 73) explain. Regarding the effects of larynx lowering, one would expect to see the increasing amplitude of vocal fold vibration in a typical cone shape that occurs in the waveform right before the release as well as an increase in F0. The release, in turn, should have a comparatively stronger voicing than potential voiced plosive counterparts. The diagnostic of an ingressive airstream that is attributed to Bantu implosives cannot be inferred from spectrogram or waveform analyses; instead, special techniques for airflow and air pressure need to be used (see, for instance, Demolin 2011 for a discussion on aerodynamic techniques for phonetic fieldwork.) There might be other cues to airflow though, for instance observing the movement of both the larynx and the cheeks. I will return to these diagnostics in §3.

While implosives have been widely reported for Bantu A80 languages, there is only one phonetic study of these sounds by Nagano-Madsen & Thornell (2012) on Mpiemo. Therefore, the following discussion cannot provide a comparison of phonetic features, but rather outlines differing phonemic status and possibly dis-

tribution of implosives in those A80 languages for which data on implosives (or their absence) is available. What becomes apparent in this comparison is that implosive sounds in A80 receive a very different treatment in terms of their phonemic vs. phonetic status. This differing treatment seems puzzling, especially when accounts differ substantially on even the same language. It first brings us back to the issue of deciding what sounds should be labelled as implosives. Beyond this, it also raises the questions of how much phonetic variation or similarity there really is in A80 ‘implosives’ and in how far this phonetic variation is played out on the phonological level.

Table 1 summarizes the status of potential implosives<sup>1</sup> within the phonemic plosive series in a representative sample of A80 languages.<sup>2</sup> Most authors agree that implosives in A80 languages, if present, have phonetic rather than phonemic status. Cheucle (2014: 461) even reconstructs voiced stops in Proto-A80 as implosives. Despite this tendency, there is still a lot of variation in the description of voiced plosives and/or implosives in several respects, including i) their general presence or absence, ii) the type of voiced plosive/implosive (e.g., bilabial, alveolar, palatal, velar), and iii) their phonemic status.<sup>3</sup>

There are three accounts of Gyeli (A801), describing different varieties of the language. Each account differs in its assessment of voiced plosives/implosives. In Grimm’s (2015) analysis, the Gyeli variety spoken in Ngolo (Bulu contact area) has no implosives at all. Voiced plosives /b/ and /d/ in stem-initial position are realized with preglottalization and relatively long prevoicing. This account is explained in detail in §3. In comparison, Renaud (1976: 49) suggests the presence of a bilabial implosive in the Gyeli variety spoken around Bipindi (Kwasio and Basaa contact area). The implosive is, however, only a phonetic variant of [b] occurring before the vowels /u, o, õ, ɔ, ã, a, ã/ in both C<sub>1</sub> and C<sub>2</sub> position. The implosive realization is, according to Renaud (1976), in free variation with an egressive glot-

---

<sup>1</sup>Square brackets indicate phonetic status while slashes / / indicate phonemic status.

<sup>2</sup>There are, of course, more A80 languages, as classified by Maho (2009). Also Cheucle (2014) gives an excellent overview of A80 languages and the existing literature. Sufficient description for comparison, however, is mainly restricted to the languages listed in Table 1 which almost cover the major languages, with the exceptions of A82 (So) and A87 (Bomwali) for which there is no data.

<sup>3</sup>Obviously, there are differences across languages pertaining to the phoneme inventory and realization rules. Bantu A80 languages differ most noticeably in the presence or absence of palatal stops and labio-velars. Some languages also lack the voiceless bilabial stop. There are also some commonalities though, including bilabial, alveolar, and velar places of stop articulation, and voicing contrast as a distinctive feature. For reasons of space, I refrain from discussing prenasalized plosives and affricates. Realization rules, if not involving implosive allophones, are not described here. It should only be noted that they may differ across languages and/or authors’ descriptions.

Table 1: Status of voiced stops/implosives in A80 languages

Language	Implosives	Restrictions	Plosive series	Source
Gyeli (A801)				
Gyeli (Ngolo)	no		/p, b, t, d, ʃ, k, g, ʔ/	Grimm (2015)
Bajele (Bipindi)	ɓ	free variation with [b]	/p, b, t, d, ʃ, k/	Renaud (1976)
Bakola (Lepdjom)	/ɓ, d, f/	stem-initial	/p, ɓ, t, d, f, k, kp/	Ngue Um (2012)
Shiwa (A803)				
	no		/p, b, t, d, k, g/	Ollomo Ella (2013)
	[ɓ, d, f]	none	/p, b, t, d, k, g/	Dougère (2007)
Kwasio (A81)	no		/p, b, t, d, c, ʃ, k/	Lemb (1974)
Makaa (A83)	no		/b, t, d, c, ʃ, k, g, kp/	Heath (2003)
Bekol (A832)	no		/(p), b, t, d, c, ʃ, k, g, kp/	Henson (2007)
Njem (A84)	no		/p, b, t, d, c, ʃ, k, g, kp, gb/	Beavon (2006)
Konzime (A842)	no		/p, b, t, d, c, ʃ, k, g, kp, gb/	Beavon (1983)
Bekwel (A85b)	[ɓ, d, f, ɡ]	in C <sub>1</sub>	/p, b, b, t, d, d, c, ʃ, j, k, ɡ, g, (kp), (gb)/	Cheucle (2014)
Mpiemo (A86c)				
	[ɓ, dʃ]	before low vowels in C <sub>1</sub>	/p, b, t, d, c, ʃ, k, g, kp, gb/	Thornell & Nagano-Madsen (2004)
	/ɓ, dʃ/	in C <sub>1</sub> , not before /i, u/	no information	Beavon (1978)

talized stop. Preceding the vowels /i, e, ε, ē/, /b/ is realized as a modal voiced stop with a particularly strong burst, including inflating the cheeks and a *battement* (beat) of the lips. The third account of Gyeli concerns the variety spoken in Lebdom (Basaa contact area). Ngue Um (2012: 3) assigns phonemic status to bilabial, alveolar, and palatal implosives whose occurrence is restricted to the stem-initial position. According to him, there are no voiced plosives, but only voiceless ones. This seems typologically unexpected.

Shiwa (A803),<sup>4</sup> represents another controversial case as to the presence or absence of implosives. According to Ollomo Ella (2013) and Puech (1989), Shiwa has

<sup>4</sup>Ollomo Ella (2013: 51) classifies Shiwa as A833 rather than A803, but I stick with Maho's (2009) classification.



no implosives, neither phonologically nor phonetically, but a plain plosive series of bilabial, alveolar, and velar plosives, all distinguished by a voicing contrast.<sup>5</sup> In contrast to their analysis, Dougère (2007: 56) asserts that all voiced stops in Shiwa are generally realized as implosives in all environments, i.e., word/stem initially and intervocalically.

For Kwasio (A81), Makaa (A83), Bekol (A832), Njem (A84), and Konzime (A842), no implosives are reported, neither phonemic nor phonetic. As to Kwasio, all principal authors – Lemb (1974), Dieu (1976), and Yemmene (2004) – describing the phonology agree that there is a voicing opposition between at least bilabial and alveolar plosives, but no indication of a phonetic realization of implosives for any of these obstruents. For Makaa, Heath (2003) does not report any implosives either, but states that the phoneme /b/ lacks a voiceless counterpart /p/. The same holds for Bekol as described by Henson (2007) who reports that instances of [p] are so rare and only found in loan words that it might not be a phoneme in the language. For Njem, Beavon (2006) outlines the phonetic realization of the entire stop series (bilabial, alveolar, palatal, and velar), but implosives are not among the variants. In Konzime, labial and alveolar stops are “released with oral cavity friction” before high vowels, according to Beavon (1983: 134), but do not exhibit implosive features.

Cheucle (2014: 147) describes all voiced stops – bilabial, alveolar, palatal, and velar – as having an implosive realization in C<sub>1</sub> position in Bekwel. She treats this feature as phonetic rather than phonemic and remarks that the degree of implosion varies across speakers.

Finally, Mpiemo receives a different treatment of implosives by different authors. Beavon (1978) views bilabial and alveolar implosives as having phonemic status which are opposed to their voiced stop counterparts. According to him, they are restricted to C<sub>1</sub> position and precede all vowels except for /i/ and /u/. In contrast to this, Thornell & Nagano-Madsen (2004) assign phonetic status to bilabial and alveolar implosives in Mpiemo, categorizing them as allophones of /b/ and /d/. They also observe the same distribution of voiced stops and implosives as Beavon: voiced stops occur before /i/ and /u/ and nasals, in all other stem-initial environments, they are realized as implosives. Figure 1 shows a bilabial implosive of Mpiemo as presented by Thornell & Nagano-Madsen (2004: 172).

The implosive exhibits a typical cone-shape amplitude increase during closure. In fact, Nagano-Madsen & Thornell (2012), in their detailed phonetic study of Mpiemo implosives, state that this amplitude increase during closure is a strong

---

<sup>5</sup>In addition to Ollomo Ella’s (2013) plosive series, Puech (1989) also posits a phonemic voiced palatal stop.

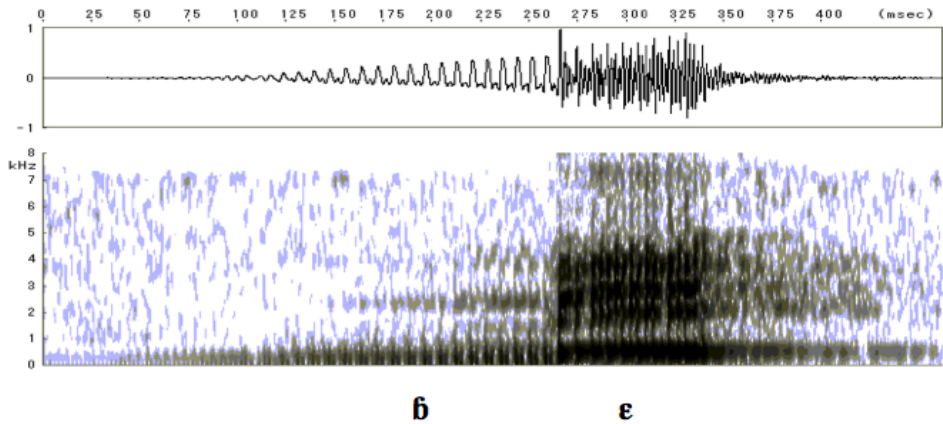

Figure 1: Bilabial implosive in Mpiemo

acoustic correlate of implosives in Mpiemo. In contrast, their egressive counterparts show a decreasing voicing amplitude. Other characteristics of Mpiemo implosives, according to the authors, include a glottalic ingressive airstream, full voicing (which also holds for egressive plosives), an increased F0 during occlusion (while F0 decreases in voiced plosives), and a closure duration for implosives which is generally longer than that for voiced stops. Implosion at release, however, is not a consistent phonetic feature. Keeping the phonetic Mpiemo implosive features in mind as well as Maddieson's (2003) general remarks about Bantu implosives, I now turn to describing the phonetic features of voiced stops in Gyeli.

### 3 Prevoiced stops in Gyeli

Despite expectations inherited from the literature on other Gyeli dialects and comparison to related languages, I argue that the Gyeli variety spoken in Ngolo (Bulu contact region) does not have implosives, neither on a phonemic nor on a phonetic level. According to Grimm's (2015) description, the phonemic distinction the language makes is between voiced and voiceless stops. Bilabial voiced plosives occur word- and stem-initially, and in medial position they are realized as [β]. Alveolar voiced stops are found in word-medial position, but I am concentrating my analysis on those in initial position since it is not to be assumed that

a medial position would host implosives if initial positions do not. Velar voiced stops are almost exclusively limited to word-medial positions, so they do not qualify as potential implosives.

Gyeli bilabial and alveolar voiced stops in word- and stem-initial position are realized with glottal constriction and prevoicing before the burst. At the same time, speakers inflate their cheeks to varying degrees before release. As such, these sounds have a few phonetic/acoustic features in common with what are typically taken as features of implosives, including glottalization, amplitude increase before release, and often a strong burst at release. Especially the cone-shape amplitude increase before release, as observed in the waveform in Figure 3, makes Gyeli prevoiced stops look like typical implosives so that one might be inclined to analyze them as implosives at least phonetically. There is, however, good evidence to assume that these sounds are produced with an egressive airstream. The key argument that also explains the cone-shape amplitude increase is the speaker's expansion of the cheeks which goes against assuming an ingressive airstream. At the same time, variation in the degree of cheek expansion within the same and across different speakers suggests that implosive-like phonetic features are not stable enough to label Gyeli voiced stops as implosives. In the following, I will compare Gyeli voiced stops to Bantu and Mpiemo implosives, showing that they are not the same class of sounds. I will also provide a more detailed analysis of Gyeli voiced stops along a variety of parameters, including voicing, amplitude, intensity, and closure duration. I am restricting my illustrations to bilabial voiced plosives due to space limitation. It should be noted though that the same features apply to stem-initial alveolar voiced stops.

### 3.1 Glottalization

What Maddieson (2003: 28) generally says about Bantu implosives, namely that they are produced without any glottal constriction, does not apply to Gyeli voiced stops. There is glottal constriction throughout, accompanying the entire bilabial or alveolar closure. This might be visible as 'noise' in the spectrogram in the circled area of Figure 2.<sup>6</sup> This could mean two things. On the one hand, one might want to say that Gyeli voiced stops could still be implosives which just exhibit different acoustic features than the majority of Bantu implosives. On the other hand, one could take this as a cue that Gyeli voiced stops are indeed different from implosives found in other Bantu languages. The criterion of glottalization alone is, as also discussed in §1.1, inconclusive. Data from Mpiemo also illustrates that

---

<sup>6</sup>Glottalization effects might not be as obvious in every token; in Figure 3, for instance, it is not.

the degree of vocal fold constriction might be subject to variation across speakers (Nagano-Madsen & Thornell 2012: 75).

### 3.2 Voicing

As can be seen in both Figure 2 and Figure 3, voiced stops in Gyeli are fully voiced, from the onset through the offset of the closure. This is a feature they have in common with voiced stops as well as implosives in Mpiemo (Nagano-Madsen & Thornell 2012: 74).

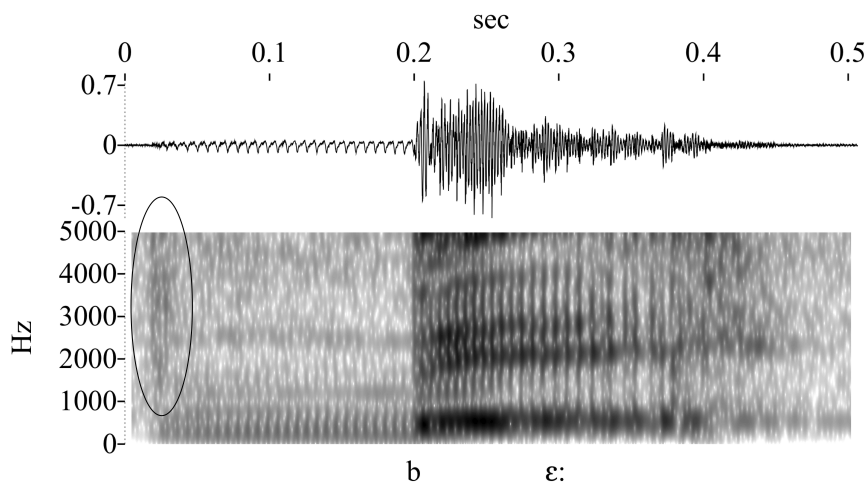

Figure 2: Production of [b] in *bɛ̀ɛ̀* ‘shoulder’, speaker 1

### 3.3 Voicing amplitude

While Nagano-Madsen & Thornell (2012) convincingly show for Mpiemo that implosives are correlated with an increasing voicing amplitude during closure and voiced stops with a decreasing one, this distribution does not map onto Gyeli stops in any way. Rather, what one finds is a high degree of amplitude variation both speaker-internally and across different speakers which correlates with the degree of cheek inflation. For instance, [b] in the lexeme *bɛ̀ɛ̀* ‘shoulder’ might differ significantly in its voicing amplitude. In Figure 2,<sup>7</sup> the voicing amplitude is neither increasing or decreasing, but remains level throughout the closure because cheek expansion is minimal in this token. In contrast, the same lexeme in

<sup>7</sup>Both Figure 2 and Figure 3 have been produced in Praat.

Figure 3<sup>8</sup> is produced with a steadily rising amplitude. Though this token looks suspiciously like an implosive, it is not. The amplitude increase is explained by an extreme case of cheek expansion. This distribution does not seem to depend on variability between speakers, but even the same speaker produces tokens with a voicing amplitude more on the level side of the spectrum and other tokens with amplitude increase.

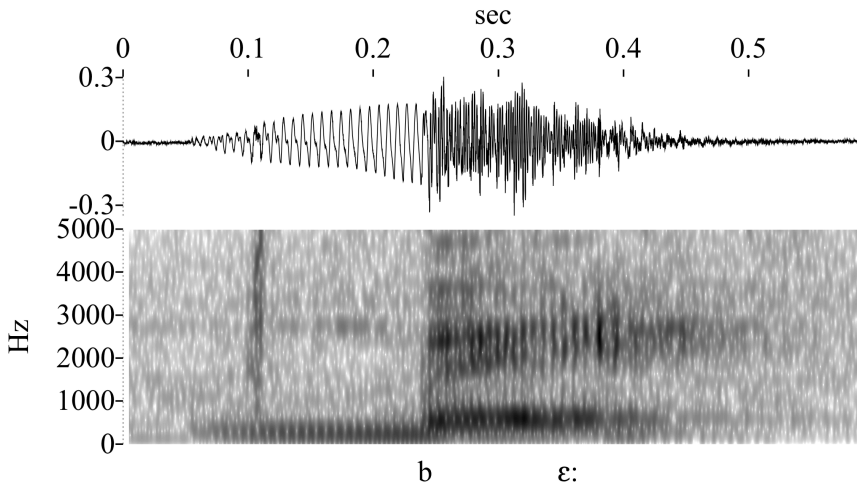

Figure 3: Production of [b] in *bɛɛ* ‘shoulder’, speaker 2

Cheek expansion during stop prevoicing, even if minimal, is a feature of every initial voiced stop in Gyeli and does not depend on the phonetic environment. Thus, in contrast to Renaud’s (1976) analysis of the Bipindi variety of Gyeli, either realization similar to Figure 2 or Figure 3, or even an amplitude increase in between these two extremes, is found before any of the seven vowels /i, u, e, o, ε, ɔ, a/.<sup>9</sup>

<sup>8</sup>The noisy part around 0.1sec into the recording seen both in the waveform and the spectrogram is some background noise and not part of the human speech production. Unfortunately, background noise cannot be completely avoided in fieldwork. I nevertheless choose to present this token since it has the sharpest amplitude increase while representing the same lexeme which makes it comparable.

<sup>9</sup>Video recordings of natural Gyeli text, that may show cheek expansion, are available in the DoBeS archive, found under the language name ‘Bakola’. In this paper, I rely on my long familiarity with the language and speakers. Systematic video recordings of voiced stop production are a future project.

### 3.4 Intensity

Nagano-Madsen & Thornell (2012: 75) state for Mpiemo that “Intensity showed a good correlation with voicing amplitude and F0 and it is higher/ increasing for implosives than for plosives.” In comparison, there does not seem to be a general difference in average F0 between those tokens of [b] which show a level or an increasing amplitude. Average F0 for the tokens in Figure 2 and Figure 3, for example, are both within the range of 135 to 145Hz. There is, however, a difference in the intensity curve which raises steadily in tokens with increasing voicing amplitude while the intensity in level amplitude tokens is first relatively low and then shows a sudden and sharp increase towards the offset of the closure.

### 3.5 Closure duration

Closure durations of voiced plosives vary a lot depending on speaking rate (careful vs. fast speech), the lexical vs. grammatical function of a morpheme or stem, and the environment (intonation phrase initial vs. medial). 200 tokens of [b]<sup>10</sup> have been measured for closure duration in different environments, covering accompaniment by different vowels and different functional environments (grammatical morpheme vs. lexical stem).

Generally, closure duration does not seem to depend on the quality of the following vowel, as shown for lexical and word-initial occurrences in Table 2.<sup>11</sup> Closure durations are rather similar and no distinction can be made between, for example, high and low vowels.

Occurrences of [b] in grammatical morphemes tend to be much shorter than those occurring in lexical stems. While the noun class prefix *be-* has an average duration of about 50ms (unless produced very carefully), [b] in *bénó* ‘buttock’ measures around 160ms. Both tokens are word-initial. Tokens that are lexical, but not word or phrase initial (e.g., preceded by a noun class prefix or a subject marker) tend to have a shorter duration than their word-initial counterparts. Thus, the second occurrence of [b] in *be-bénó* ‘buttock’ only has a closure length of around 80ms, which is still longer than [b] in the prefix which is 30ms in this instance. Closure durations are also longer in very careful speech or to emphasize a particular word. In these cases, the voicing amplitude is not necessarily higher,

---

<sup>10</sup>These measurements comprise tokens of various prevoicing amplitude patterns, i.e., those that are more similar to Figure 2 and those that are more similar to Figure 3. The reason for this is that there is no binary distinction, but rather a scale which, however, does not seem to affect closure duration. Thus, VOT is the same for low amplitude and amplitude increase tokens.

<sup>11</sup>Only a few tokens were available for [b] before /o/; this might have skewed the results.

Table 2: Closure durations of voiced bilabial plosives

v	Average duration	Lexical example	Duration
i	[b] = 108ms	b̀ijɔ ‘hit’	[b] = 130ms
u	[b] = 108ms	b̀ulɔ ‘fish (v.)’	[b] = 130ms
e	[b] = 105ms	bé ‘pit’	[b] = 81ms
o	[b] = 120ms	bógɛɛ ‘enlarge’	[b] = 157ms
ɛ	[b] = 115ms	bè ‘sow’	[b] = 145ms
ɔ	[b] = 103ms	b̀ɔndi ‘black colobus monkey’	[b] = 137ms
a	[b] = 100ms	báβè ‘disease’	[b] = 151ms

but closure duration is relatively longer. In any case, longer closure times might correlate with the percept of implosives while shorter closure times sound more like modally voiced stops.

### 3.6 Airstream mechanism

A final consideration in terms of phonetic features concerns the airstream mechanism involved in the production of plosives. While no aerodynamic data were collected for Gyeli so far (and also Nagano-Madsen & Thornell (2012) base their phonetic analysis of Mpiemo implosives on data that does not include airflow mechanisms or laryngographic measurements), statements about the airflow can be made with some certainty by observing speakers. Especially for voiced stop tokens that involve an increasing voicing amplitude, Gyeli speakers tend to achieve an increase of the vocal tract size by expanding the cheeks. This has already been noted by Renaud (1976) and confirmed by Grimm (2015). To expand the cheeks, the airflow has to be egressive. At the same time, this gesture excludes a significant lowering of the larynx. I take this as the key argument not to consider Gyeli voiced stops as implosive realizations.

## 4 Conclusion and outlook

The findings in Gyeli, as well as the treatment of implosives and their relation to voiced plosives in the A80 literature, have several implications. First, it seems that a fundamental issue in the description of A80 implosives is a terminological question. In the absence of any decisive criteria to clearly identify implosives,

scholars may categorize a range of sounds as implosives which, in fact, might be very different from one another.

This leads to methodological implications. On the one hand, it shows how important it is to provide (basic) phonetic information in grammatical descriptions. These are, however, often insufficient or absent altogether. On the other hand, the phonetic description of sounds in a language might seem daunting to fieldworkers whose expertise lies in other areas of grammar. It might be useful for expert phonetician fieldworkers to develop some general guidelines for descriptive linguists, comparable to the many questionnaires on, for instance, information structure or object marking.

Multiple theoretical implications are at stake. On a micro-areal level, a better understanding of implosive(-like) sounds in Gyeli and other A80 languages enables us to clarify whether these consonants indeed display a high degree of variation or whether they are more uniform than currently suggested by the literature. Since all languages in the area are closely related and in intense contact with one another, one might expect to find significant similarities also in the phonetic realization of sounds. This does not mean that the phonetic features of a particular phoneme in one language hold for other languages in the area as well. But given that authors have differing treatment of implosives vs. voiced stops in the same language in several cases of A80, it is possible that these languages share certain features which are interpreted in different ways. Thus, important questions still need to be answered: what phonetic features do these sounds in A80 have in common, if anything, and in which respects do they differ? A possible parameter of variation could be, for instance, an oropharyngeal expansion which, according to Ladefoged & Maddieson (1996: 55), may constitute “a continuum that links modally voiced stops to implosives.” Obviously, more phonetic analyses are needed to answer these questions, which then help to answer yet others, for instance about their phonemic or allophonic status and their alleged free variation. For future work it would also be desirable to include a more systematic data comparison of different A80 languages, using aerodynamic techniques as well as measuring larynx movement.

Implosive(-like) sounds in A80 may also provide an interesting window onto language contact phenomena. In this area of intense language contact and a high degree of multilingualism among speakers of all languages, it would be fascinating to investigate to what degree implosives or some acoustic features of them are borrowed. Gyeli speakers, for example, are known to imitate their linguistic neighbors deliberately in order to increase their prestige. While the closest related language, Kwasio, does not seem to have implosives, other neighboring



languages such as Basaa do. One could hypothesize that Gyeli voiced stops are a partial imitations of implosives found in other languages, just without borrowing larynx lowering and an ingressive airstream, which are acoustically replaced by glottalization and a voicing amplitude increasing through expanding the cheeks.

On a broader level, it is, of course, important for fields such as typology, historical linguistics, or language classification to know whether one is comparing conceptually the same or different sounds. Clarifying whether certain sounds in some Bantu sub-families are really implosives might change the extension of assumed linguistic areas and might better our understanding of language relations in respect to their genealogical classification.

## Acknowledgments

I would like to thank two anonymous reviewers and Joyce McDonough for their careful reading of this paper and their helpful and constructive comments they gave me. I also thank the ACAL participants, especially Bonny Sands, Didier Demolin, and Firmin Ahoua.

## References

- Beavon, Keith H. 1978. *Provisional description of the segmental phonemes and noun classes of the Mpyémó language (Bijugí dialect)*. SIL Cameroon.
- Beavon, Keith H. 1983. A phonology of Konzime. *Africana Linguistica* 9. 109/136.
- Beavon, Keith H. 2006. *A phonology of Njyem*. SIL Cameroon.
- Cheucle, Marion. 2014. *Étude comparative des langues makaa-njem (bantu A80): Phonologie, morphologie, lexique. Vers une reconstruction du proto-A80*. Lyon, France: Université Lumière Lyon 2. (Doctoral dissertation).
- Clements, George N. 2000. Phonology. In Bernd Heine & Derek Nurse (eds.), *African Languages: An Introduction*, 123–160. Cambridge: Cambridge University Press.
- Clements, George N. & Sylvester Osu. 2002. Explosives, implosives and nonexplosives: The linguistic function of air pressure differences in stops. In Carlos Gussenhoven & Natasha Warner (eds.), *Laboratory Phonology 7*, 299–350. Berlin, New York: Mouton de Gruyter.
- Clements, George N. & Annie Rialland. 2008. Africa as a phonological area. In Bernd Heine & Derek Nurse (eds.), *A Linguistic Geography of Africa*, 36–85. Cambridge: Cambridge University Press.

- Crystal, David. 2008. Implosives. In *A Dictionary of Linguistics and Phonetics*, 6th edn. Hoboken, NJ: Wiley.
- Demolin, Didier. 2011. Aerodynamic techniques for phonetic fieldwork. In *Proceedings of the 17th International Congress of Phonetic Sciences*, 84–87.
- Dieu, Michel. 1976. Les consonnes du ngumba: Recherche en phonologie générative. In *Bulletin de l'ALCAM*. Yaounde: ONAREST.
- Dougère, Lucie. 2007. *Première approche phonologique, morpho-syntaxique et diachronique du chiwa du Gabon (ogoué-ivindo)*. Université de Lyon 2. (MA thesis).
- Ewan, William G. & Robert Krones. 1974. Measuring larynx movement using the thyroumbrometer. *Journal of Phonetics* 2. 327–335.
- Fromkin, Victoria & Robert Rodman. 1998. *An introduction to language*. 6th edn. Orlando: Harcourt.
- Greenberg, Joseph H. 1970. Some generalizations concerning glottalic consonants, especially implosives. *International Journal of American Linguistics* 36(2). 123–145.
- Grimm, Nadine. 2014. Color categories in language contact: “Pygmy” hunter-gatherers and Bantu farmers. *Proceedings of the Berkeley Linguistics Society* 38. 31–46.
- Grimm, Nadine. 2015. *A grammar of Gyeli*. Berlin: Humboldt Universität zu Berlin. (Doctoral dissertation).
- Heath, Teresa. 2003. Makaa (A83). In Derek Nurse & Gérard Philippson (eds.), *The Bantu languages*, 335–348. London, New York: Routledge.
- Henson, Bonnie J. 2007. *The phonology and morphosyntax of Kol*. Berkeley: University of California. (Doctoral dissertation).
- Ladefoged, Peter & Ian Maddieson. 1996. *The sounds of the world's languages*. Oxford: Blackwell.
- Lemb, Pierre. 1974. *Esquisse phonologique du mvumbo*. DESS Thesis, Yaoundé.
- Letouzey, René. 1995. Noms d'abres des pygmées bagielli dans le sud-ouest du Cameroun. *Journal d'Agriculture Tropicale et de Botanique Appliquée* 22(1). 23–45.
- Lindau, Mona. 1984. Phonetic differences in glottalic consonants. *Journal of Phonetics* 12. 147–155.
- Maddieson, Ian. 2003. The sounds of the Bantu languages. In Derek Nurse & Gérard Philippson (eds.), *The Bantu languages*, 15–41. London, New York: Routledge.

- Maddieson, Ian. 2013. Glottalized consonants. In Matthew Dryer & Martin Haspelmath (eds.), *The World Atlas of Language Structures Online*. Leipzig: Max Planck Institute for Evolutionary Anthropology.
- Maho, Jouni F. 2009. *New updated Guthrie list*. <http://goto.glocalnet.net/mahopapers/nuglonline.pdf>.
- McGregor, William. 2015. *Linguistics: An introduction*. London: Bloomsbury Academic.
- Nagano-Madsen, Yasuko & Christina Thornell. 2012. Acoustic properties of implosives in Bantu Mpiemo. In *Proceedings of Fonetik 2012*, 73–76.
- Ngue Um, Emmanuel. 2012. Bakola sketch grammar.
- Ollomo Ella, Régis. 2013. *Description linguistique du shiwa, langue bantu du Gabon: Phonologie, morphologie, syntaxe, lexique*. Paris: Paris 3, Sorbonne Nouvelle. (Doctoral dissertation).
- Puech, Gilbert. 1989. Les constituants suprasyllabiques en chiwa (Bantu A.80). *Pholia* 4. 217–227.
- Renaud, Patrick. 1976. *Le bajeli. Phonologie, morphologie nominale*. Vol. 1 and 2. Yaounde: Les dossiers de l'ALCAM.
- Thornell, Christina & Yasuko Nagano-Madsen. 2004. Preliminaries to the phonetic structure of the Bantu language Mpiemo. *Africa & Asia* 4. 163–180.
- Xi, Cun. 2009. *A phonetic study on implosives in China*. University of Science & Technology, Hong Kong. (Doctoral dissertation).
- Yemmene, Patrice A. 2004. *Phonological sketch of Kwasio*. Yaounde: BASAL.



## Chapter 9

# Downstep and recursive phonological phrases in Bàsàá (Bantu A43)

Fatima Hamlaoui

ZAS, Berlin; University of Toronto

Emmanuel-Moselly Makasso

ZAS, Berlin

This paper identifies contexts in which a downstep is realized between consecutive H tones in absence of an intervening L tone in Bàsàá (Bantu A43, Cameroon). Based on evidence from simple sentences, we propose that this type of downstep is indicative of recursive prosodic phrasing. In particular, we propose that a downstep occurs between the phonological phrases that are immediately dominated by a maximal phonological phrase ( $\phi_{max}$ ).

## 1 Introduction

In their book on the relation between tone and intonation in African languages, Downing & Rialland (2016) describe the study of downtrends as almost being a field in itself in the field of prosody. In line with the considerable literature on the topic, they offer the following decomposition of downtrends:

1. Declination
2. Downtrend (or ‘automatic downstep’)
3. Downstep (or ‘non-automatic downstep’)
4. Final lowering
5. Register compression/expansion or register lowering/raising



In the present paper, which concentrates on Bàsàá, a Narrow Bantu language (A43 in Guthrie's classification) spoken in the Centre and Littoral regions of Cameroon by approx. 300,000 speakers (Lewis et al. 2015), we will first briefly define and discuss declination and downdrift, as the language displays both phenomena. We will then turn to the focus of this paper, that is ('non-automatic') downstep. The fact that, under the influence of floating Low tones, Bàsàá displays downstepped High tones, i.e. tones that are identified as phonologically High but display a register that is lower than an immediately preceding H, is well known (a.o. Dimmendaal 1988; Bitjaa Kody 1993; Hyman 2003; Hamlaoui et al. 2014). The originality of the present paper lies in the fact that downstep can also be found at certain word junctures where it cannot be traced to the presence of a lexical L tone. In line with Match Theory (Selkirk 2009; 2011) and the Theory of Prosodic Projection (a.o. Ito & Mester 2012), we propose that this type of downstep is indicative of recursive phonological phrasing. More specifically, we propose that in Bàsàá, a downstep occurs between the immediate daughters of a maximal phonological phrase ( $\phi_{max}$ ).

The paper is structured as follows. §2 introduces Bàsàá and its basic tone patterns. It also provides a brief overview of the types of downtrends found in this Bantu language. §3 concentrates on the distribution of the particular type of downstep that interests us, i.e. with no lexical L tone involved. §4 provides a possible analysis for this tonal phenomenon. §5 concludes the paper.

## 2 Basic patterns of tone in Bàsàá

### 2.1 Downdrift

Bàsàá is a tonal language with a three-way underlying opposition between H(igh), L(ow) and toneless ( $\emptyset$ ) tone-bearing units (TBUs) (Dimmendaal 1988; Hyman 2003; Makasso 2008 and in particular Bitjaa Kody 1993; Hamlaoui et al. 2014; Makasso et al. 2016 on toneless TBUs). As a result of a number of tonal processes, Bàsàá's surface realizations contrast H, L, LH (rising), HL (falling) and 'H ('downstepped' H) tones. Table 1 provides an illustration of Bàsàá's minimal tonal contrasts.<sup>1</sup>

As in many other African tone languages, in utterances presenting mixed sequences of tone, Bàsàá displays "automatic downstep" or downdrift: "a progres-

---

<sup>1</sup>The system of transcription used in this work is the IPA. For the readers familiar with previous literature on Bàsàá, we have the following correspondences: /p/ or /b/ → /β/; /t/ or /d/ → /r/; /k/ or /g/ → /ɣ/; /y/ → /j/; /ny/ → /ɲ/; /j/ → /ɕ/; /c/ → /ʃ/.

9 Downstep and recursive phonological phrases in Bàsàá (Bantu A43)

Table 1: Tonal minimal pairs in Bàsàá (Makasso & Lee 2015)

H tone	L tone	HL tone	LH tone
jáχ ‘to annoy’	jàχ ‘also’		
báj ‘to tolerate’	bàŋ ‘to make’		
bó: ‘to move out’	bò: ‘(smell) bad’	tú: ‘shoulder (CL7)’	bö ‘nine’
	tù: ‘to be unable to cut’		nɔ: ‘snake (CL9)’
	nɔ: ‘to copulate’	báŋgà ‘drug’ (CL7)	bàŋgá ‘great’

sive lowering of tone realisation” (Downing & Rialland 2016: 2). As seen in the pitch track in Figure 1, corresponding to the sentence in (1), each L tone sets “a new, lower, ‘ceiling’” for the following H tones (Connell 2011).

- (1) í-ḃ-ḃ̀ŋgḃ́ ḃ́áná ḃ́á-m-ḃ́árá m-áŋgòlò má ḃ-á<sup>+</sup>sáj.  
 í-ḃ-ḃ̀ŋgḃ́ ḃ́áná ḃ́á-m-ḃ́árá m-áŋgòlò má ḃ-àsáj  
 AUG-2-children 2.DEM 2.AGR-PST1-take 6-mangoes 6.CONN 2-fathers  
 ‘These children picked up the mangoes of the fathers.’  
 (Makasso et al. 2016)

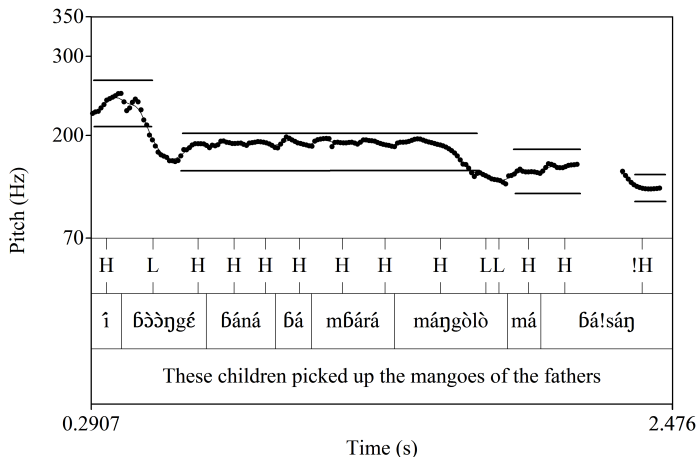

Figure 1: Downdrift in a Bàsàá sentence with a mixed tone sequence (Makasso et al. 2016)

In sentence (1), tones that are phonologically identified as H are realized on four different pitch registers. The first three of these correspond to the phenomenon known as ‘downdrift’. We will come back subsequently to the last change of register, a case of (non-automatic) downstep. Note in passing that H tones preceding a L tone display H-raising, a phenomenon also found in languages like Yoruba (a.o. Connell & Ladd 1990; Laniran 1992; Laniran & Clements 2003) or Dagara (Rialland & Somé 2000; Rialland 2001), and that the first H in (1) displays greater H-raising than the next H that also precedes a L (but that no such raising is observed when the initial H is followed by a H, as in Figure 2 and Figure 3).

## 2.2 Declination

In addition to having downdrift, Bàsàá also exhibits declination, that is, ‘a gradual modification (over the course of a phrase or utterance) of the phonetic backdrop against which the phonologically specified F0 targets are scaled’ (Connell & Ladd 1990; Connell 2011). Declination, which is considered a phonetic universal (Ladd 1984; Connell 2011), is found in both Bàsàá declarative sentences and *yes/no*-questions. This is illustrated in Figure 2 and Figure 3, for the sentence with only H tones in (2) (Makasso et al. 2016).

- (2) a. hín-dá í kóp í-ń-lámá jéŋ ɲwér.  
 7.black 7.CONN hen 7.AGR-PST1-may search 1.owner  
 ‘The black hen may look for its owner.’
- b. hín-dá í kóp í-ń-lámá jéŋ ɲwér-é.  
 7.black 7.CONN hen 7.AGR-PST1-may search owner-Q  
 ‘May the black hen look for its owner?’

Before we turn to the focus of this paper, that is the downstepping of adjacent H tones, let us briefly discuss (non-automatic) downstep under the influence of a lexical floating L tone.

## 2.3 Downstep under the influence of a floating L tone

Several tonal/segmental processes have been identified that result in the realization of a downstepped H tone. High Tone Spread (HTS), the major tonal process of present day Bàsàá according to Hyman (2003), can lead a L tone to disassociate and lower a following H. This is the case in example (1). The word for ‘fathers’ is underlyingly L-H. When following the H-toned class 2 connective, it acquires a



9 Downstep and recursive phonological phrases in Bàsàà (Bantu A43)

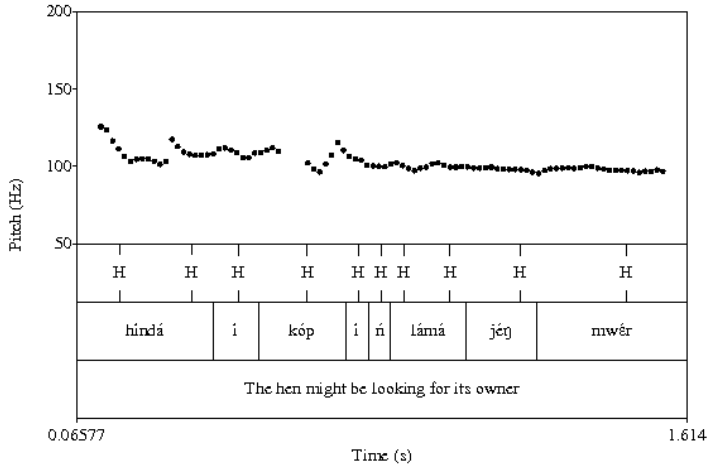

Figure 2: Assertion – High tones only (Makasso et al. 2016)

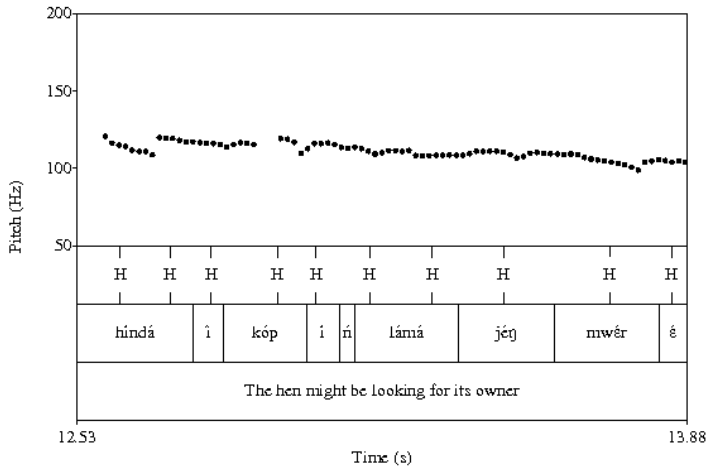

Figure 3: Yes-no question – High tones only (Makasso et al. 2016)

H on its first TBU through HTS. That has the effect of disassociating the initial L, which in turn creates a downstepped H (<sup>+</sup>H, see again Figure 1).

Floating L tones are also pretty common in Bàsàá, some of them clearly resulting from a historical loss of segments. The augment in (1) introduces a floating L, which systematically creates a downstep on a following H.<sup>2</sup> This is also the case of the present tense morpheme and the locative marker, for instance, illustrated respectively in (3) and (4).

- (3) à-ń-<sup>+</sup>ɕǝ́.  
 à-ń`-ɕǝ́  
 1.AGR-PRES-eat  
 ‘He/She is eating.’

- (4) í <sup>+</sup>ndáp  
 í` ndáp  
 LOC 9.house  
 ‘in the house’

The rightward association of floating L tones that creates <sup>+</sup>H tones is found within prosodic words ( $\omega$ ), i.e. prosodic units roughly corresponding to lexical heads, within phonological phrases ( $\phi$ ), i.e. prosodic units based on (lexical) syntactic phrases (XPs), and within intonational phrases ( $\iota$ ), i.e. prosodic units based on syntactic clauses, in a prosodic hierarchy where  $\iota > \phi > \omega$  (see for instance Selkirk (2011) and references therein for details on the prosodic hierarchy, and Hamlaoui & Szendrői (2015; 2017) for the definition of syntactic ‘clause’ assumed here).

### 3 Where adjacent Hs are distinguished

We have briefly illustrated in Figure 1, Figure 2 and Figure 3 that whenever two H tones are brought together in Bàsàá, within words and between words, they form a plateau. This is also what we have observed in all the repetitions of various sentences that we have recorded (see Makasso et al. (2016) for an overview). At least on the surface then, Bàsàá thus differs from a language like KiShambaa (Bantu G23, Tanzania), in which downstep applies between any two independent H tones (Odden 1982). We have however identified a few contexts in which

<sup>2</sup>See example (14) for a case where both the H and L tone of the augment are carried by the noun it modifies, suggesting that this type of downstep involves an underlying lexical L.

two adjacent H tones are realized on different registers, where the second one is perceived as downstepped. Let us look at them in turn.

### 3.1 In the phrasal domain

First, in the phrasal domain, [Dem N] and [Wh N] present a downstep at the juncture between the two words. They are so far the only noun phrases in which we have observed a downstep, and in that they contrast with [N Dem], [N Adj], [N CONN N], [POSS N] and [N POSS], where no such downstep is found.

- (5) ínì    ˀkwémbé  
       7.DEM 7.box  
       ‘this box’

- (6) ndžé    ˀsóyól  
       which 1.grandfather  
       ‘which grandfather’

According to Hyman (2003) and Hyman & Lionnet (2012), who assume a H vs. L underlying tonal distinction in both Abo (Bantu A42, Cameroon) and Bàsàá, all noun class prefixes are underlyingly L. In their approach, prefixless nouns thus start with a floating L tone which would be responsible for the downstep observed in examples (5), (6) and (7) to (17). Whenever the prefixless noun follows e.g. a verb or a connective, i.e. a context where HTS (or metatony) applies, this floating L tone could be overridden and thus not create a downstep. We provide sentences in the next subsection in which words that are not analysed by Hyman and Hyman & Lionnet as starting with a floating L tone also display a downstep when preceded by a word that ends with a H tone.

### 3.2 At the sentence level

Whenever the proper tonal configuration is met, a downstep distinguishes the two complements of a verb. This is illustrated in (7) to (11), with different types of complements. Sentence (8) is illustrated in Figure 4.

- (7) bá-ń-tí            sóyól            ˀkwémbé.  
       2.AGR-PST1-give 1.grandfather 7.box  
       ‘They gave the grandfather the box.’

- (8) mè ò-tí líwándá lí sóyól †ndáp.  
 I PST1-give 5-friend 5.CONN 1.grandfather 9.house  
 ‘I gave the friend of the grandfather the house.’

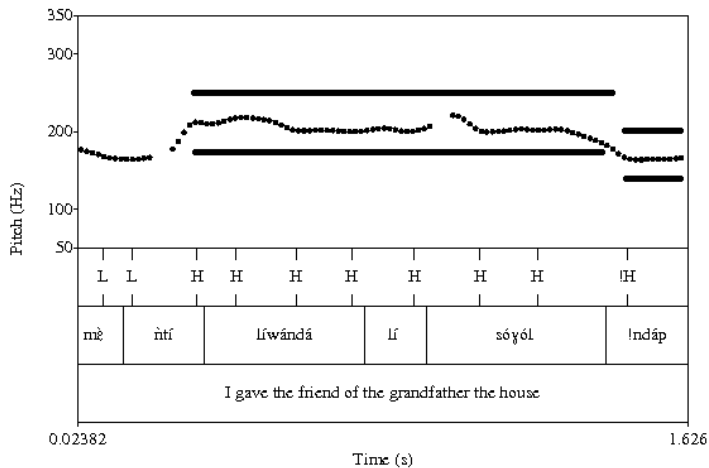

Figure 4: Downstep between two complements in sentence (8)

- (9) mè ò-tí í-†sóyól núnú †ndáp jòŋ.  
 I PST1-give AUG-1.grandfather 1.DEM 9.house 9.your  
 ‘I gave this grandfather your house.’
- (10) mè ò-tí ndžé mááŋgé †ndžé múràá?  
 I PST1-give which 1.child which 1.woman  
 ‘Which woman did I give to which child?’
- (11) mè ò-tí málêr òkénéjé †ndáp òkénéjé.  
 I PST1-give 1.teacher 1.big 9.house 9.big  
 ‘I gave the big teacher the big house.’

Example (12) is crucial in connection to Hyman and Hyman & Lionnet’s hypothesis, as demonstratives are not, to the best of our knowledge, among the words that they would posit have a floating L tone but still display a downstep when they are the second complement of a verb.

- (12) mè ò-tí sóyól Ìíní ˀkwémbé.  
 I PST1-give 1.grandfather 7.DEM 7.box  
 ‘I gave the grandfather this box.’

If an initial floating L tone were posited to be associated with demonstratives, it would remain to be explained why no downstep is found in [N Dem] phrases, as in (9) and (13) (Hyman 2003: 273), a context where HTS does not apply (Ham-laoui et al. 2014: 28). The absence of downstep before the second complement in example (27) in §5, which starts with a demonstrative, would also be unexpected if a lexical L tone is present in the underlying representation.

- (13) í-bòòṅgé b́aná  
 AUG-2.children 2.DEM  
 ‘these children’

- (14) líˀwándá líní  
 AUG.5-friend 5.DEM  
 ‘this friend’

A further context in which a downstep is inserted at the sentence level is between a complement and a verb modifier, as illustrated in (15).

- (15) à-ò-sómb móó ˀlóngê.  
 1.AGR-PST1-buy 6.oil 7.well.  
 ‘He did buy the oil.’

Whenever the verb is followed by a complement and a locative adjunct though, as in (16) and (17), no such downstep occurs between them (the downstep on the last word, ‘ndáp’ is due to the floating L introduced by the locative). Sentence (16) is illustrated in Figure 5, where the last H tone of the second complement forms a plateau with the first H tone of the locative phrase.

- (16) í-bòòṅgé b́aná b́á-m-b́ará kwémbé í sóyól  
 AUG-2.children 2.DEM 2.AGR-PST1-pick.up 7.box 7.CONN 1.grandfather  
 í ˀndáp.  
 LOC 9.house  
 ‘These children picked up the box of the grandfather at home.’

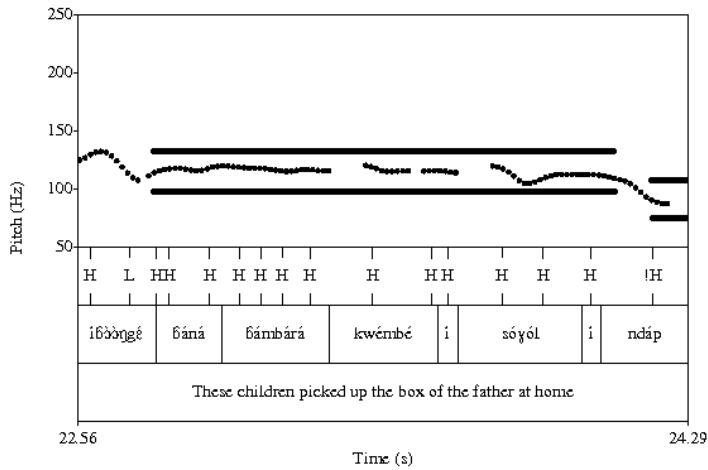

Figure 5: Absence of downstep between a complement and a locative phrase (16)

- (17) í-bòòngé      b́aná      b́á-n-tí      sóyól      <sup>+</sup>kwémbé í  
 AUG-2.children 2.DEM 2.AGR-PST1-give 1.grandfather 7.box      LOC  
<sup>+</sup>ndáp.  
 9.house  
 ‘These children gave the box to the grandfather at home.’

## 4 Why adjacent Hs are distinguished

### 4.1 Recursive prosodic phrasing

In Hamlaoui et al. (2014) and Hamlaoui & Szendrői (2015; 2017), we have discussed two tonal processes which, we have argued, allow us to diagnose certain prosodic edges. First, we have proposed that the contexts in which HTS is blocked from happening indicate the presence of a phonological phrase right edge (“a H tone is prohibited from spreading across the right edge of a Phonological Phrase”, Hamlaoui et al. 2014: 27). In the proper tonal configurations, we have thus established that a simple sentence displays the phonological phrasing indicated in (18).

- (18)  $(XP)_\phi \vee (XP)_\phi (XP)_\phi$ .

We have also examined various types of phrases, and concluded that the non-application of HTS indicates that the configurations in (19) contain two right phonological phrase edges, while those in (20) are monophrasal. The *wh*-phrase is the only context we have identified so far where both HTS and downstep apply.<sup>3</sup>

- (19) a. Dem)<sub>ϕ</sub> N)<sub>ϕ</sub>  
 b. N)<sub>ϕ</sub> Dem)<sub>ϕ</sub>  
 c. N)<sub>ϕ</sub> Adj)<sub>ϕ</sub>  
 d. Adj)<sub>ϕ</sub> N)<sub>ϕ</sub>  
 e. N)<sub>ϕ</sub> CONN N)<sub>ϕ</sub>
- (20) a. POSS N)<sub>ϕ</sub>  
 b. N POSS)<sub>ϕ</sub>  
 c. *wh* N)<sub>ϕ</sub>

Note that the groupings given in (19) and (20) are not affected when such phrases are embedded within a sentence. This is briefly illustrated in (21a) and (21b) with two types of NPs as complement of a verb.

- (21) a. XP)<sub>ϕ</sub> V N)<sub>ϕ</sub> A)<sub>ϕ</sub>  
 b. XP)<sub>ϕ</sub> V N)<sub>ϕ</sub> CONN N)<sub>ϕ</sub>

In other words, in both (21a) and (21b), the application of HTS indicates more prosodic cohesion between a verb and the word that immediately follows it than between words (like a noun and its modifier) which can reasonably be assumed to be part of the same lexical XP. This will become particularly relevant subsequently in the phrasing of sentences in Figure 7 and Figure 8. This appears to be a mismatch between syntax and phonology.

Second, we have proposed that Falling Tone Simplification (FTS), in its turn, provides evidence for the presence of intonational phrase left edges (see Hamlaoui & Szendrői (2017) for an extended discussion). In contrast with HTS, FTS

---

<sup>3</sup>A downstep in the *wh*-phrase is, at first sight, problematic for the proposal we make in this paper as, if we are on the right track regarding HTS, the latter process indicates that [Wh N] is monophrasal. Note however that *wh*-words seem to carry a floating H which, as we have shown in Hamlaoui & Makasso (2011), triggers the lengthening of the *wh*-word in certain contexts. The rightward association of a H tone at play in this type of phrases might thus differ from what goes on in the other types of phrases listed here and thus not be sensitive to (non-max) phonological phrase edges.

applies between all the phrases in a simple sentence like (18), which constitutes an intonational phrase. This is illustrated in (22).

(22) (XP V XP XP)<sub>t</sub>.

We have seen that the configurations in which we observed a downstep could not be traced to the presence of a lexical floating L tone. What then determines the presence of these downsteps? We propose that the contexts in which downstep occurs in Bàsàá correspond to the maximal phonological phrase of the prosodic hierarchy, where  $\phi$  and other prosodic categories are recursive (a.o. Ito & Mester 2012). More specifically, we propose that Bàsàá inserts a downstep between the phonological phrases that are the immediate daughters of a maximal phonological phrase. The distinction of adjacent H tones in absence of a lexical floating L is thus indicative of recursive phonological phrasing.

Let us spell out our reasoning. We focus on the sentence level, as this is where our hypotheses concerning the syntactic structure are the most restricted. First, we know from the data we have examined that downstep does not occur between two phrases that do not belong to a larger lexical XP, that is, between subject and verb, for instance, or a complement and (what can safely be assumed) a clause-level adjunct. These phrases form a plateau (a point we will come back to subsequently). Second, we know that downstep does not occur either between a verb and its complement, which do belong to a simple lexical XP (VP). Third, we know that downstep occurs between two complements of a verb, or a complement and a verb modifier. It thus seems that downstep occurs when more syntactic structure is involved within a lexical phrase (here VP), and thus intuitively indicates an ‘intermediate’ degree of cohesion between two phrases. In a canonical sentence with a verb with more than one complement, it is usually assumed that all the arguments of the verb are contained within a complex V(erb)P(hrase), which can be represented (among other ways) as shown in Figure 6 (Larson 1988).

In this syntactic representation, the VP is recursive. Although it was long assumed that the prosodic structure was flatter than the syntactic structure (Selkirk 1981; 1984; 1986; Nespór & Vogel 1986), a number of studies have provided evidence that prosody can be as recursive as syntax (Ladd 1986), and this view can now be considered standard (a.o. Selkirk 1995; 2009; 2011; Truckenbrodt 1999; Wagner 2005; Elfner 2012). If prosodic structure is by default based on syntactic structure, as is assumed here, it is expected that, at least in some languages, phonological evidence is found for recursive prosodic phrasing within VPs. Truckenbrodt (1999), for instance, argues that this is the case in Kimatuumbi (Bantu P13), a distant relative of Bàsàá (Odden 1987; 1990), where prosody suggests that the sequence [V NP NP] is phrased ((V NP) $\phi$  NP) $\phi$ .



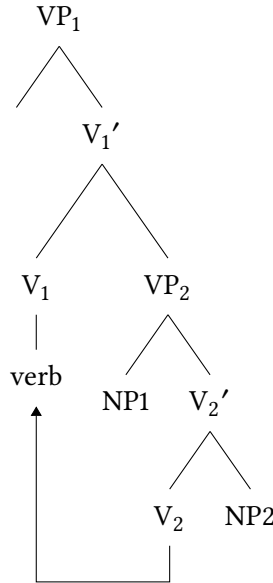

Figure 6: Representation of a Verb Phrase (adapted from Truckenbrodt (1999))

When it comes to Bàsàá sentences, the evidence provided by HTS and downstep is compatible with the phrasing suggested by Truckenbrodt for Kimatuumbi, and repeated in (23). It is also compatible, among others, with the phrasing in (24) (Selkirk 2009; 2011), which better reflects the amount of embedding found in the syntactic structure. Downstep could be a correlate of the phonological phrase that contains the entire VP.

$$(23) [V NP NP] \rightarrow ((V NP)_\phi NP)_\phi$$

$$(24) [V NP NP] \rightarrow ((V (NP)_\phi)_\phi (NP)_\phi)_\phi$$

The occurrence of downstep in sentences with “complex” complements as in sentences (10) and (11), however suggests that in Bàsàá, the second complement forms a phrase of its own, as in (24). What we can see indeed is that downstep does not occur just anywhere within a complex VP. The fact that the two complements are distinguished by a downstep suggests that there is more prosodic cohesion within each of the complements than suggested solely by the evidence provided by HTS. Indeed, the phrasing provided by HTS suggests a flat structure within a VP such as the one in example (11). This is shown in (25). In this structure

there does not seem to be a reason why downstep should not occur between any (or each) of the phonological phrases.

(25)  $(V N)_\phi (A)_\phi (N)_\phi (A)_\phi$

Downstep however only targets the juncture between the two complements, which suggests that there is an additional level of prosodic structure, shown in bold in (26) and reflecting the syntactic cohesion between each nominal head and its modifier.

(26)  $(V N)_\phi (A)_\phi )_\phi (N)_\phi (A)_\phi )_\phi$  [full bracketing:  $((V N)_\phi (A)_\phi )_\phi ((N)_\phi (A)_\phi )_\phi$ ]

What seems crucial here is that not all phonological phrases are distinguished. In (26), if noun and adjective are indeed contained within a single phonological phrase, how come they do not show downstep just like the two complements of a verb? After all, they seem to be in a comparable syntactic configuration (i.e. two lexical phrases contained in a larger lexical phrase).

We propose that this is due to the fact that downstep only targets the phonological phrases that are immediately dominated by a *maximal* phonological phrase. This is in line with Ito & Mester's (2012; 2013) Prosodic Projection Theory, in which domain-sensitive processes can target different projection levels (i.e. (non-)maximal, (non-)minimal projections). Downstep would here constitute evidence for a certain type of nesting of phonological phrases. Let us examine the prosodic structure that obtains in some of the sentences in which downstep is found, and contrast them with some in which it isn't.

Figure 7 constitutes the representation of a sentence like (7), with simple NPs (nouns) for subject and complements. What we see in Figure 7 is that downstep does not target a phonological phrase of a particular level. Rather, it targets the immediate daughters of a  $\phi_{max}$ , the maximal projection of a phonological phrase. As long as a  $\phi_{max}$  displays unary branching, as the one corresponding to the subject in Figure 7, no downstep happens. Note as well that more structure within each of the NPs constituting the complements (as in examples (10) to (11)) does not change the configuration found at the  $\phi_{max}$  level corresponding to VP1 in Figure 7, and downstep is still rightly predicted to distinguish the two complements (the same applies for a structure consisting of a complement and a verb modifier, as in (15)). Our proposal is also formulated so as not to distinguish daughters of a  $\phi_{max}$  that do not all correspond to  $\phi$ s (as in a simple VP).

Figure 8 corresponds to a transitive sentence with a simple subject, a complement consisting of a noun and an adjective, and a clause-level adjunct.

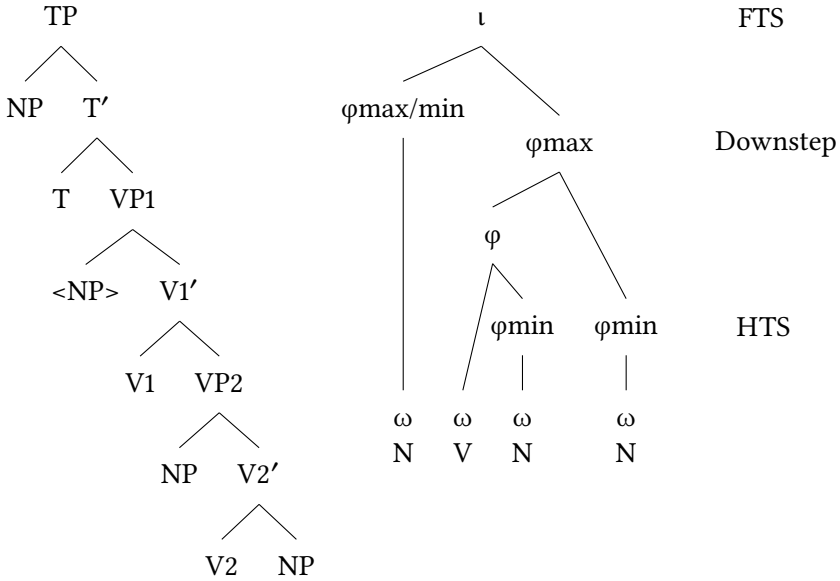

Figure 7: Simplified syntactic representation and corresponding recursive prosodic structure in a Bāsàá ditransitive sentence

As was mentioned above, whenever the first complement of a verb consists of a complex noun phrase, as for instance a noun and an adjective, HTS, which seems to be an indicator of  $\phi_{\min}$  right edges, only applies between the verb and the noun, and never between the noun and the adjective. We propose that this is due to the fact that the verb and noun form a  $\phi$  that violates the default syntax-phonology mapping (as it does not correspond to any syntactic lexical phrase). In Figure 7 this extra  $\phi$  is simply conflated with the one corresponding to VP2. As can be seen in Figure 8, the  $\phi_{\max}$  corresponding to the VP only has one immediate daughter, so no downstep can be inserted.

#### 4.2 How H tones are downstepped

As pointed out by one of our reviewers, the question arises whether Bāsàá has a rule of downstep insertion which specifies the contexts in which downstep takes place, or whether downstep is simply the “elsewhere case”. In the latter view, Bāsàá would be underlyingly similar to KiShambaa, in that adjacent independent H tones are systematically distinguished and that this distinction is phonetically implemented as a downstep. Under this view, a process of H-tone

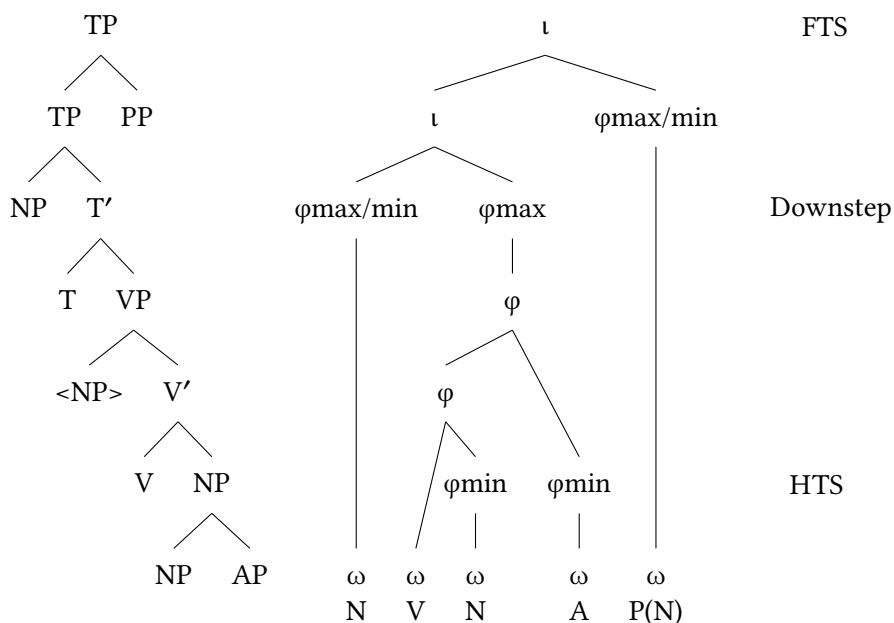

Figure 8: Simplified syntactic representation and corresponding recursive prosodic structure in a Bàsàá transitive sentence

fusion (Odden 1982; Bickmore 2000) would apply within multimorphemic words and non-maximal phonological phrases that would result in H tone plateaus within these prosodic domains. As for the plateaus between maximal phonological phrases, they could be the result of the application of an upstep process systematically taking place at the left edge of that domain (with the idea that downstep + upstep = plateau). Default downstepping of H tones would thus only be visible between the daughters of maximal phonological phrases as neither H-tone fusion nor upstepping applies. This seems like an interesting approach, which according to our reviewer would be more in line with what has been described in other Bantu languages. For the time being, it is however unclear to us whether this inflation in assumptions is generally more desirable to account for the grammar of Bàsàá than assuming that consecutive tones of the same category are realized on the same level (albeit with a slight declination) and that a rule (categorically) distinguishes H tones in one particular prosodic configuration (potentially via the insertion of a L tone at particular prosodic edges). It is also unclear to us whether the H-tone fusion hypothesis makes any empirical predictions that could be tested in Bàsàá.

If an upstep occurs at certain prosodic edges (e.g. the left-edge of  $\phi_{\max}$ ), it seems to us that this would be measurable at certain junctures (e.g. between the last downstepped H of a complement and the first H of a following clausal adjunct, for instance). It would also result in the absence (or reduction) of down-drift when H and L tones alternate. We know that this happens in left-dislocation contexts where FTS is prevented from applying which, according to Hamlaoui & Szendrői (2017), correspond to the left edge of the clause (the core  $\iota$ ). We have informally checked sequences where H and L tones alternate within an intonation phrase (in particular (H-L)<sub>subject</sub> (H-L-X)<sub>verb</sub> sequences) and we have identified 5 cases out of 13 (in repetitions of 4 sentences) where there was a reset, and thus no down-drift at the left edge of the verb. Although this result does not strongly support the idea that downstep is the elsewhere case, it suggests that more phonetic investigations are needed to decide between the two approaches.

## 5 Conclusion

In this paper, we have concentrated on the distinction of consecutive H tones in absence of an intervening (floating) L tone in Bàsàá, a Northwest Bantu language spoken in Cameroon. Based on evidence from simple sentences, we have proposed that this particular type of downstep is indicative of recursive prosodic phrasing. In particular, and in line with Ito & Mester's (2013) Prosodic Projection Theory, we have proposed that in the present language, a downstep is inserted between the phonological phrases that are the immediate daughters of a maximal phonological phrase. Too little information on the syntactic representation of noun phrases is available at the time of writing to check our proposal against this type of data. Before closing this paper, let us briefly mention that in sentences like (27) and (28), where a downstep is found within each of the complements, the complements themselves fail to be distinguished. Sentence (27) is shown in Figure 9.

(27) *mè ò-tí núnú †sòyól ínì †kwémbé.*  
 I PST1-give 1.DEM 1.grandfather 7.DEM 7.box  
 'I gave this grandfather this box.'

(28) *mè ò-tí ndžé †sòyól ndžé †sòyól?*  
 I PST1-give which 1.grandfather which 1.grandfather  
 'Which grandfather did I give to which grandfather?'

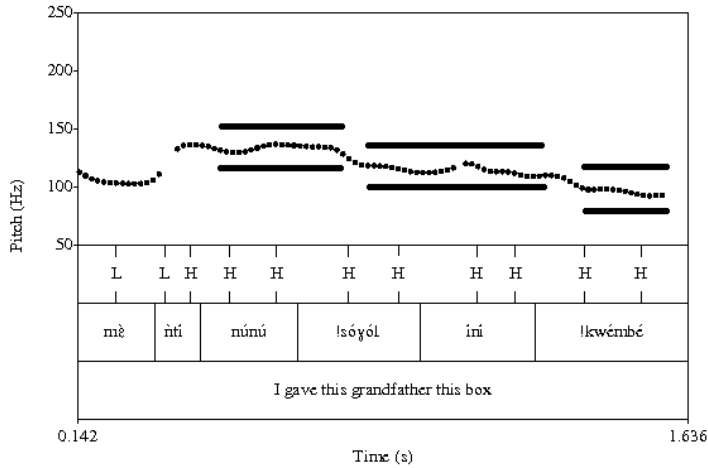

Figure 9: Downstep neutralization in sentence (27)

This might suggest that the number of possible downsteps is maybe not unlimited and that there are cases of neutralizations. We leave this issue open for future research.

## Acknowledgments

For fruitful discussions at various stages of elaboration of this work, we are very grateful to Laurent Roussarie, Caroline Féry, Beata Moskal, Gerrit Kentner, Michael Wagner and Lisa Selkirk. Many thanks also go to our speakers, Rodolphe Maah, Gwladys Makon and Carole Ngo Sohna, as well as to two anonymous reviewers for their valuable comments and suggestions. The usual disclaimers apply.

## Abbreviations

1...n	noun class	FTS	Falling Tone Simplification
AGR	agreement	H	high tone
AP	Adjective Phrase	HL	falling tone
AUG	augment	HTS	High Tone Spread
CONN	connective	L	low tone
DEM	demonstrative		

LH	rising tone	PRO	pronoun
LOC	locative	PST	past
NP	Noun Phrase	Q	question particle
POSS	possessive	TP	Tense Phrase
PRES	present	VP	Verb Phrase

## References

- Bickmore, Lee S. 2000. Downstep and fusion in Namwanga. *Phonology* 17. 297–331.
- Bitjaa Kody, Zachée Denis. 1993. Le système tonal du basaa. *Journal of West African Languages* 23(1). 65–72.
- Connell, Bruce. 2011. Downstep. In *Companion to Phonology*, 824–847. Oxford: Blackwell publishing.
- Connell, Bruce & Robert Ladd. 1990. Aspects of pitch realisation in Yoruba. *Phonology* 7. 1–30.
- Dimmendaal, Gerrit J. 1988. *Aspects du basaa*. Leuven: Peeters/SELAF. Translated by Luc Bouquiaux.
- Downing, Laura Jo & Annie Rialland (eds.). 2016. *Intonation in African tone languages*. Berlin: Mouton de Gruyter.
- Elfner, Emily. 2012. *Syntax-prosody interactions in Irish*. University of Massachusetts Amherst. (Doctoral dissertation).
- Guthrie, Malcolm. 1948. *The classification of the Bantu languages*. Oxford: Oxford University Press for the International African Institute.
- Hamlaoui, Fatima, Siri Gjersøe & Emmanuel-Moselly Makasso. 2014. High tone spreading and phonological phrases in Bàsàà. In *Proceedings of the 4th International Symposium on Tonal Aspects of Languages*. ISCA Archive.
- Hamlaoui, Fatima & Emmanuel-Moselly Makasso. 2011. Bàsàà wh-questions and prosodic structuring. In Laura Jo Downing (ed.), *Questions in Bantu languages: Prosodies and positions (ZASPiL 55)*, 47–63. Berlin: ZAS.
- Hamlaoui, Fatima & Kriszta Szendrői. 2015. A flexible approach to the mapping of intonational phrases. *Phonology* 32(1). 79–110.
- Hamlaoui, Fatima & Kriszta Szendrői. 2017. The syntax-phonology mapping of intonational phrases in complex sentences: A flexible approach. *Glossa* 2(1). <https://www.glossa-journal.org/articles/abstract/10.5334/gjgl.215>.
- Hyman, Larry. 2003. Bàsàà (A43). In *The Bantu languages*, 257–282. Routledge.
- Hyman, Larry & Florian Lionnet. 2012. Metatony in Abo (Bankon), A42. In Michael R. Marlo, Nikki B. Adams, Christopher R. Green, Michelle Morrison

- & Tristan M. Purvis (eds.), *Selected Proceedings of the 42nd annual conference on African Linguistics*, 1–14. Somerville: Cascadilla Proceedings Project.
- Ito, Junko & Armin Mester. 2012. Recursive prosodic phrasing in Japanese. In Toni Borowsky, Shigeto Kawahara, Mariko Sugahara & Takahito Shinya (eds.), *Prosody matters. Essays in honor of Elisabeth Selkirk* (Advances in Optimality Theory Series), 280–303. Sheffield & Bristol: Equinox.
- Ito, Junko & Armin Mester. 2013. Prosodic subcategories in Japanese. *Lingua* 124. 20–40.
- Ladd, Robert. 1984. Declination: A review and some hypotheses. *Phonology year-book* 1. 53–74.
- Ladd, Robert. 1986. Intonational phrasing: The case of recursive prosodic structure. *Phonology Yearbook* 3. 311–340.
- Laniran, Yetunde. 1992. *Intonation in tone languages: The phonetic implementation of tones in Yorùbá*. Cornell University. (Doctoral dissertation).
- Laniran, Yetunde & George N. Clements. 2003. Downstep and high tone raising: Interacting factors in Yoruba tone production. *Journal of Phonetics* 31(2). 203–250.
- Larson, Richard. 1988. On the double object construction. *Linguistic Inquiry* 19. 335–391.
- Lewis, M. Paul, Gary F. Simons & Charles D. Fennig (eds.). 2015. *Ethnologue: Languages of the world*. Eighteenth. Dallas, Texas: SIL International.
- Makasso, Emmanuel-Moselly. 2008. *Intonation et mélismes dans le discours oral spontané en bàsàà*. Université de Provence (Aix-Marseille 1). (Doctoral dissertation).
- Makasso, Emmanuel-Moselly, Fatima Hamlaoui & Seunghun Julio Lee. 2016. Aspects of the intonational phonology of Bàsàà. In *Intonation in African tone languages*, 167–194. Berlin: Mouton de Gruyter.
- Makasso, Emmanuel-Moselly & Seunghun Julio Lee. 2015. Basaá. *Journal of the International Phonetic Association* 45(1). 71–79.
- Nespor, Marina & Irene Vogel. 1986. *Prosodic phonology*. Dordrecht: Foris.
- Odden, David. 1982. Tonal phenomena in KiShambaa. *Studies in African Linguistics* 13(2). 177–208.
- Odden, David. 1987. Kimatuumbi phrasal phonology. *Phonology Yearbook* 4. 13–36.
- Odden, David. 1990. Syntax, lexical rules and postlexical rules in Kimatuumbi. In Sharon Inkelas & Draga Zec (eds.), *The phonology-syntax connection*, 259–277. Chicago: University of Chicago Press.



- Rialland, Annie. 2001. Anticipatory raising in downstep realization: Evidence for preplanning in tone production. In *Proceedings of the symposium "Crosslinguistic studies of tonal phenomena: Tonogenesis, Japanese accentology and other topics"*, 301–322.
- Rialland, Annie & Penu Achille Somé. 2000. Dagara downstep: How speakers get started. In Vicky Carstens & Frederick Parkinson (eds.), *Advances in African linguistics*, 251–264. Trenton: Africa World Press.
- Selkirk, Elisabeth. 1981. On the nature of phonological representation. In Terry Myers, John Laver & John Anderson (eds.), *The cognitive representation of speech*, 379–388. Amsterdam/New York: Elsevier.
- Selkirk, Elisabeth. 1984. *Phonology and syntax*. Cambridge, MA: MIT press.
- Selkirk, Elisabeth. 1986. On derived domains in sentence phonology. *Phonology Yearbook* 3. 371–405.
- Selkirk, Elisabeth. 1995. The prosodic structure of function words. In Jill N. Beckman, Laura W. Dickey & Suzanne Urbanczyk (eds.), *Papers in Optimality Theory*, 439–470. University of Massachusetts, Amherst: GLSA.
- Selkirk, Elisabeth. 2009. On clause and intonational phrase in Japanese: The syntactic grounding of prosodic constituent structure. *Gengo Kenkyu* 136. 35–73.
- Selkirk, Elisabeth. 2011. The syntax-phonology interface. In John Goldsmith, Jason Riggle & Alan Yu (eds.), *The Handbook of Phonological Theory*, 485–532. Oxford: Blackwell Publishing.
- Truckenbrodt, Hubert. 1999. On the relation between syntactic phrases and phonological phrases. *Linguistic Inquiry* 30(2). 219–282.
- Wagner, Michael. 2005. *Prosody and recursion*. Massachusetts Institute of Technology. (Doctoral dissertation).



## Chapter 10

# Reconsidering tone and melodies in Kikamba

Patrick Jones

University of South Florida

Jake Freyer

Brandeis University

The melodic tone system of Kikamba, as described by Roberts-Kohno (2000; 2014), stands out as particularly complex within the context of recent crosslinguistic work on melodic tone in Bantu (Odden & Bickmore 2014; Bickmore 2015). It is unique, for example, in possessing a melody that assigns four distinct tones to three stem-internal positions simultaneously. The apparent existence of such complex melodies raises doubts as to whether there are any substantive restrictions on the possible form of a tonal melody. We argue, however, that these doubts are premature. We propose a new analysis of Kikamba in which (a) melodies refer to no more than two target positions at a time and (b) melodies target only two possible stem-internal positions, each of which occurs commonly within Bantu melodic tone systems. This simplification is achieved by (a) rejecting the existence of a melodic L tone assigned to the penult, and attributing its putative effects to interactions among other, more basic tones, and (b) distinguishing between melodic tones assigned early in the phonological derivation and other suffixal tones added later. In general, we argue that since core properties of melodic tone are often obscured in surface forms due to interactions with language-particular rules, the crosslinguistic comparison of melodic tone should proceed on the basis of a (more) underlying level in which these rules are controlled for. Once this is done, the exceptional properties of Kikamba melodic tone largely disappear.



## 1 Melodic tone in Bantu and Kikamba

In all Bantu languages that make distinctive use of tone, tonal alternations within the verb stem help to signify various aspects of verbal inflection, including tense, aspect, mood, polarity, clause type, and focus (Odden & Bickmore 2014). In (1) below, we see a clear example of this from Kihunde (Mateene 1992).

(1) Melodic tone in Kihunde (Mateene 1992)<sup>1</sup>

- a. Infinitive (p. 17)  
i-[king-ul-aŋ-a]  
NC.5-[close-REV-RECP-FV]<sup>2</sup>  
'to open each other'
- b. Recent Past (p. 22)  
tw-a-[king-úl-aŋ-a-a]  
1PL.SBJ-PST-[close-REV-RECP-ASP-FV]  
'we opened each other (recently)'
- c. Negative Hypothetical (p. 38)  
tú-ta-[king-úl-aŋ-ir-é]  
1PL.SBJ-NEG-[close-REV-RECP-ASP-FV]  
'if we do not open each other'

In the infinitive form in (1a), the verbal stem is the straightforward sum of its parts: neither the root nor any suffix bears an underlying H tone, so the fact that the stem as a whole surfaces as toneless is unsurprising. However, when the same stem (modulo the inflectional suffixes ASP and FV) appears in the Recent Past form in (1b) or the Negative Hypothetical form in (1c), H tones appear on the stem's second and final vowels (V2 and FV). Logically, since the non-inflectional content of the stem is constant between these forms, the tonal differences between them must somehow arise from differences in inflection. Thus, the tones that appear within the stem in (1b) and (1c) are *grammatical* tones.

Two key questions that arise in the analysis of grammatical tones concern (a) where they come from and (b) how they come to be assigned to their surface positions. Here, for the sake of explicitness, we wish to lay out our own assumptions on these matters clearly at the outset. First, we assume that the stem tone

---

<sup>1</sup>The forms here differ from those cited by Mateene in that they contain the reciprocal suffix *-aŋ*; its presence obviates a process of local tone plateauing that would otherwise obscure the basic facts of melodic tone assignment in (1c).

<sup>2</sup>Square brackets in examples and glosses mark verb stem boundaries.

alternations in (1) arise primarily from differences in underlying representation: the URs of (1b) and (1c), but not (1a), contain tonal *melodies* that are exponents of inflection. These melodies consist of one or more *melodic tones*, each of which is labeled with a desired *target*, i.e. a stem-internal position to which it wishes to be assigned. Thus, the Recent Past form in (1b) contains the melody  $\{H_{V2}\}$ , consisting of a single melodic H tone whose target is V2. The Negative Hypothetical form in (1c) contains the melody  $\{H_{V2}+H_{FV}\}$ , containing one H that targets V2 and another that targets FV. Finally, we assume that melodic tones are matched with their targets in an early process of *Initial Mapping*, before other tone rules apply. This process may require a negotiation between tones targeting the same vowel (e.g.  $H_{V2}$  and  $L_{FV}$  in a disyllabic stem), so that perfect mapping of tones to targets is not guaranteed.<sup>3</sup>

In Kihunde, a language with no tone shift and only limited spreading, the target of a melodic tone is generally identical to its surface location. In other languages, operations like shift and spread, applying after initial mapping, can obscure a target's identity. Consider, for example, the Kinande form in (2). This corresponds exactly both in meaning and in segmental makeup with the Kihunde form in (1b), and, like it, its melody  $\{H_{V2}+L_{FV}\}$  contains a melodic H that targets V2 (Hyman & Valinande 1985; Jones 2014). However, due to general rules of leftward shift and leftward spread that apply after initial mapping (and which affect underlying tones as well as grammatically-assigned tones) this H surfaces not on V2 but on the first vowel of the stem (V1) and on the first vowel before it (V0).

- (2) Recent Past (Kinande)  
*tw-á-[kíng-ul-an-a-à]*  
 1PL.SBJ-PST-[close-REV-RECP-ASP-FV]  
 'we opened each other (recently)'

---

<sup>3</sup>These assumptions are broadly similar to those adopted, for example, by Bickmore (2007); Ebarb (2016), Marlo (2008; 2009), Marlo (2015), and Odden (2009). One important conceptual difference between our approach and that of the works just cited, however, is our avoidance of construction-specific tone assignment rules. In our view, the task of associating particular tones to particular stem-positions in a tense-dependent way belongs solely to morphology, which associates different tenses with different melodies. The task of the phonology is only to associate the component tones of these morphologically-assigned melodies with their desired targets. One consequence of this is that under our approach, the melody is a single coherent entity at the level of underlying representation, and not simply the sum of all tones assigned by melodic assignment rules.

There is thus a critical distinction between a melodic tone’s *surface location* and its *target*: while the former may be directly observed, the latter reveals itself only in the context of analysis.<sup>4</sup>

This issue bears directly on questions of typology. Recent work collected in Odden & Bickmore (2014), as well as antecedent work by Kisseberth & Odden (2003) and Marlo (2013), has considerably extended our knowledge of melodic tone patterns throughout Bantu, to the point that we can now begin to make informed generalizations about (a) what tones may appear in tonal melodies, (b) how many tones a single melody may contain, and (c) what stem-internal positions may serve as targets for melodic assignment. These generalizations, drawn from Odden & Bickmore (2014) and Bickmore (2015), are presented in Table 1.

Table 1: Typological generalizations for melodic tone in Bantu (Odden & Bickmore 2014; Bickmore 2015)

	Common	Exceptional
Melodic tones	H and L	H, L, SH, SL (Kikamba) H, L, HL, LH (Bakweri)
Max # of tones per melody	1 or 2	3 (Simakonde: Manus 2014) 4 (H-L-H-SL in Kikamba)
Targets for melodic tones	V1, V2 Pen, FV	V0 (i.e. pre-stem) V3, V4
# of targets per melody	1 or 2	3 (Kikamba)

In the context of the generalizations summarized in Table 1, the melodic tone system reported for Kikamba stands out as uniquely complex. Of all languages surveyed in Odden & Bickmore (2014), it ties with Bakweri (Marlo et al. 2014) in having the largest melodic tone inventory (H, L, SH, and SL), it has the largest number of tones per melody (four), and its melodies target the greatest number of stem positions at a time (three). In addition, it is one of just two languages that are reported to assign a melodic L tone to the penult.

<sup>4</sup>This point is clearly articulated by Odden & Bickmore (2014: 5): “Ultimately, stem tones will be shaped by the general rules of the language. An in-depth synchronic analysis is thus necessary to strip away these rules, revealing what the specific content of each pattern is, where these tones are associated, and what happens to tones once they are initially associated, not to mention saying when a particular pattern is found”.

What are we to make of this? One possibility is that melodic tone in Kikamba is simply an extreme instantiation of a phonological subsystem that has no principled bounds. It is possible, in other words, that any arbitrary combination of melodic tones associated with any arbitrary set of stem positions may constitute a legitimate tonal melody, so we should not be particularly surprised to find complex melodies that assign four distinct tones at once, and to three distinct positions. Indeed, the very existence of such apparently complex melodic patterns seems to suggest that there are few substantive constraints on what a tonal melody can look like.

On the other hand, it is also possible that the considerable (and typologically unusual) degree of complexity reported for Kikamba might give way to a simpler system upon reanalysis. This possibility is especially worth exploring due to the highly indirect relationship between surface tone patterns and underlying melodies discussed above, since this indirect relationship allows the same set of surface facts to submit to a wide range of analytical interpretations.

Here, we pursue this latter possibility and develop a reanalysis of the Kikamba melodic tone system. In this effort, we are relying entirely upon data previously reported by Roberts-Kohno (2000) and Roberts-Kohno (2014). As we will see, upon reanalysis, the melodic system of Kikamba actually deviates very little from the “standard” Bantu melodic tone systems described in Table 1. This finding offers hope that, contrary to what the surface facts of Kikamba might suggest at first, melodic tone is not a purely arbitrary system that can vary without limit. Instead, it is one whose variation is constrained by general principles that careful language-internal and crosslinguistic analysis can reveal.

## 2 The standard analysis of Kikamba melodies (Roberts-Kohno 2014)

The exceptional properties of the Kikamba tone system reported in §1 emerge from the analysis of Kikamba melodic tone developed by Roberts-Kohno (2000; 2014), briefly summarized in Table 2.<sup>5</sup> This analysis posits ten distinct patterns of

---

<sup>5</sup>In all examples from Kikamba, tone is transcribed as follows: high tone is indicated with a single acute accent (e.g. [á]), low tone is indicated with a single grave accent (e.g. [à]), super-high tone is indicated with a doubled acute accent (e.g. [â]), super-low tone is indicated with a doubled grave accent (e.g. [ã]), and falling tone (which always results from separate H and L tones assigned to the same vowel) is indicated with a circumflex (e.g. [â]). Vowels that are not marked with any diacritic are phonologically toneless, and are generally pronounced with L tone.

Table 2: Kikamba tone melodies posited by Roberts-Kohno (2000; 2014)

Melody	Example Form
{∅}	o-kaa-[kon-aang-a] '(person) who will hit'
{H <sub>V2</sub> }	tw-aa-[kon-ááng-í-é] 'we hit (long ago)'
{H <sub>FV</sub> }	to-í-kaa-[kon-aang-á] 'we will not hit'
{H <sub>V2</sub> +L <sub>FV</sub> }	to-[kon-ááng-í-é] 'we hit (earlier today)'
{H <sub>V2</sub> +L <sub>Pen</sub> }	o-[kon-ááng-éèt-ε] '(person) who's been hitting (today)'
{H <sub>V2</sub> +L <sub>Pen</sub> +H <sub>FV</sub> }	tó-[kon-ááng-í-é] '(person) whom we hit (today)'
{SL <sub>FV</sub> }	ko-[kon-aàng-à] 'to hit'
{H <sub>V2</sub> +H <sub>FV</sub> +SL <sub>FV</sub> }	to-í-[kon-ááng-á-â] 'we do not usually hit'
{H <sub>V2</sub> +L <sub>Pen</sub> +H <sub>FV</sub> +SL <sub>FV</sub> }	to-í-[kon-ááng-éèt-ê] 'we had not hit (long ago)'
{H <sub>V2</sub> +SH <sub>FV</sub> }	tw-áa-[kon-ááng-ǎ] 'if/when we hit'

melodic tone assignment, with melodies containing anywhere from zero to four melodic tones.<sup>6</sup>

<sup>6</sup>To facilitate comparison between stems, the iterative morpheme *-aang* (not consistently present in forms provided by Roberts-Kohno 2014) is included in all forms in Table 2. Here and elsewhere, its meaning of 'here and there/a little bit/randomly' is omitted from glosses to save space.



In this analysis, the relationship between underlying tone melodies and surface tone patterns is entirely straightforward: melodic tones surface on their specified targets, with the minimal complication that  $H_{V2}$  spreads rightwards onto all following toneless vowels. This straightforward relationship arises for a simple reason: the analysis posits a distinct underlying melodic tone for every tonal turning point within the stem.

In this paper, we develop a new analysis in which some turning points derive not from the presence of an underlying melodic tone, but rather from *interactions* between a more limited set of tones. Most importantly, we will reject  $L_{Pen}$  as a melodic tone, and re-analyze the melodic  $SL_{FV}$  tone proposed by Roberts-Kohno as a *non-melodic* floating tone. The end result is an analysis which is somewhat more abstract, but which (a) finds both crosslinguistic and language-internal support and (b) results in a underlying melodic system that is both more internally coherent and more in line with what we should expect in light of the crosslinguistic generalizations about Bantu melodies established in §1.

### 3 Primary melodies of Kikamba

#### 3.1 Overview

In this section, we consider the melodies described by Roberts-Kohno (2014) that do not involve SL or SH tones. (We discuss those that do involve SL and SH tones in §4.) We show that what Roberts-Kohno (2014) analyzes as 6 arbitrary melodies can be reduced to 5 melodies that form a logically coherent set: three single-tone melodies  $\{H_{V2}\}$ ,  $\{H_{FV}\}$  and  $\{L_{FV}\}$  and two two-tone melodies representing all the logically possible ways of combining them  $\{H_{V2}+H_{FV}\}$  and  $\{H_{V2}+L_{FV}\}$ . This simplification is made possible primarily by the elimination of  $L_{Pen}$  as a possible melodic tone, with its effects attributed instead to general rules and constraints of the language.

#### 3.2 $\{H_{FV}\}$ melody

The most straightforward melody of Kikamba causes a single H tone to surface on the stem's final vowel. This melody is present, for example, in Habitual forms in "Assertive" clauses (i.e. declarative main clauses without object focus). In (3) below, we see such a form in nonfinal position, where it is not affected by the presence of phrasal L tones to be discussed in §4.2. Following Roberts-Kohno (2014), we analyze this melody as  $\{H_{FV}\}$ .

- (3) {H<sub>FV</sub>} melody in Habitual (Assertive, nonfinal)  
 né-tó-[kon-aang-a-á] ...  
 ASSERT-1PL.SUBJ-[hit-ITER-ASP-FV]  
 ‘we always hit’

### 3.3 {H<sub>V2</sub>} melody

Another straightforward melody causes a H tone span from V2 to FV. This melody is present, for example, in Remote Perfective forms in Assertive clauses, as in (4) below. Again following Roberts-Kohno (2014), we analyze this melody as {H<sub>V2</sub>}, consisting of a single melodic H tone attracted to V2. This H is subsequently targeted by a rule of Rightward Spreading, which extends it until the end of the word. (This rule of unbounded spreading targets only grammatical tones; see Bickmore (1997; 1999) for discussion of a similar situation in Ekegusii, with accompanying theoretical analysis.)

- (4) {H<sub>V2</sub>} melody in Remote Perfective (Assertive, nonfinal)  
 né-tw-áa-[kon-ááng-í-é] ...  
 ASSERT-1PL.SUBJ-PST-[hit-ITER-ASP-FV]  
 ‘we hit long ago’

### 3.4 {H<sub>V2</sub>+H<sub>FV</sub>}

In some forms, such as the Assertive Hodiernal Perfective form in (5), H tones are assigned to both V2 and FV. In this case, H<sub>V2</sub> still spreads to the right, but it stops at the antepenultimate vowel, leaving one L-toned vowel in between it and H<sub>FV</sub>. Roberts-Kohno (2014) analyzes this L-toned vowel as the result of L<sub>Pen</sub>, a melodic L tone assigned to the penult. By contrast, we propose that it results from the Obligatory Contour Principle (OCP): the rightward spread of H<sub>V2</sub> is blocked just in case it would cause two distinct H tones to be associated to adjacent syllables.

- (5) {H<sub>V2</sub>+H<sub>FV</sub>} melody in Hodiernal Perfective (Assertive, nonfinal)  
 né-tó-[kon-ááng-i-é] ...  
 ASSERT-1PL.SUBJ-[hit-ITER-ASP-FV]  
 ‘we hit (earlier today)’

Considerations which favor the OCP-based analysis are (a) the well-documented role of the OCP in stopping tone spread in other Bantu languages (e.g. Myers

1997; Odden 2014) and (b) language-internal symmetry. Since Kikamba melodies independently allow for  $H_{V2}$  and  $H_{FV}$ , and since Kikamba melodies allow for multiple tones, it is natural to expect a melody that combines them.  $\{H_{V2}+H_{FV}\}$  is just this melody. On the other hand, a  $\{H_{V2}+L_{Pen}+H_{FV}\}$  is unexpected from the perspective of inventory symmetry and compositionality, since there is no melody in which putative  $\{L_{Pen}\}$  is assigned by itself.

### 3.5 $[H_{V2}+L_{FV}]$

As shown in (6), Kikamba imperatives surface with a H tone on V2 that spreads rightwards only up to the penult, leaving the ultima L-toned. Following Roberts-Kohno (2014), we assume that H cannot spread further onto the ultima because it is blocked by a final melodic L tone. The imperative's melody, therefore, is  $\{H_{V2}+L_{FV}\}$ .

- (6)  $\{H_{V2}+L_{FV}\}$  in Imperative forms  
 [kon-ááng-éǎ-í-à]      ...  
 [hit-ITER-CAUS-CAUS-FV]  
 'make (someone) hit!'

However, departing from Roberts-Kohno, we propose that not *all* surface forms that show a H span from V2 to the penult result from a  $\{H_{V2}+L_{FV}\}$  melody. In fact, most instances of this pattern have another origin: a  $\{H_{V2}+H_{FV}\}$  pattern that is subjected to a rule of *Final Lowering*. We see this, for example, in Hodiernal Perfective forms. When they appear in Assertive or Relative clauses and lack 3<sup>rd</sup> singular personal agreement morphology, their stems clearly show a  $\{H_{V2}+H_{FV}\}$  pattern, as we have already seen in (5) above. However, when the same stems appear in a clause with *object focus*, or with a 3<sup>rd</sup> singular personal subject marker, the final H tone is lowered to L. These facts are shown in Table 3, where melodies derived from Final Lowering are given in bold.

As an alternative to final lowering, we might instead propose that forms with 3<sup>rd</sup> singular personal agreement and forms with object focus are simply assigned a variant tone pattern by the morphology.<sup>7</sup> In our view, however, this solution is unsatisfactory because it fails to provide the semantically uniform class of "Hodiernal Perfective" forms with a uniform tone pattern, and also because it fails to explain why the two tone patterns shown by Hodiernal Perfective forms

<sup>7</sup>This is the solution adopted by Roberts-Kohno (2014), who posits a  $\{H_{V2}+L_{Pen}+H_{FV}\}$  pattern for most Hodiernal Perfective forms (as seen in §3.4), but posits a  $\{H_{V2}+L_{FV}\}$  pattern for Hodiernal Perfective forms with 3<sup>rd</sup> singular personal agreement.

Table 3: Final H Lowering in the Hodiernal Perfective

	Assertive (nonfinal)	Relative	Object-Focus
Hodiernal Pfv 'we hit (today)'	[H <sub>V2</sub> +H <sub>FV</sub> ] né-tó-[kon-ááng-i-é]	[H <sub>V2</sub> +H <sub>FV</sub> ] tó-[kon-ááng-i-é]	[H <sub>V2</sub> +L <sub>FV</sub> ] to-[kon-ááng-i-è]
... w/ 3SG subj. 'he hit (today)'	[H <sub>V2</sub> +L <sub>FV</sub> ] n-óo-[kon-ááng-i-è]	[H <sub>V2</sub> +L <sub>FV</sub> ] o-[kon-ááng-i-è]	[H <sub>V2</sub> +L <sub>FV</sub> ] á-[kon-ááng-i-è]

are so similar. Moreover, as we will shortly see, Final Lowering has effects that extend beyond the Hodiernal Perfective forms. We therefore posit the rule of Final Lowering in (7).

- (7) Final Lowering: H<sub>FV</sub> → L<sub>FV</sub>
- a. in object-focus clauses
  - b. in forms with 3rd singular personal subject agreement

This rule is admittedly stipulative at the moment. It is not presently clear whether lowering should be induced directly by reference to morphosyntactic features, or indirectly by interactions with tones that these features introduce. (It is tempting, for example, to relate the lowering of H<sub>FV</sub> in forms with 3<sup>rd</sup> singular personal subject agreement markers to the fact that these markers systematically differ from others in tone.) More study of this question is needed.

Closely related to the Hodiernal Perfective forms just analyzed are Hodiernal Stative forms that show a H tone span from V2 to the *antepenult*. Roberts-Kohno (2014) analyzes these forms as possessing a distinct {H<sub>V2</sub>+L<sub>Pen</sub>} melody, where the presence of a melodic L on the *penult* limits the rightward spread of H to the *antepenult*. However, there are two crucial observations to make of such forms. First, this tone pattern appears to result from Final Lowering, since it occurs in exactly the same contexts where the {H<sub>V2</sub>+L<sub>FV</sub>} pattern emerges in the Hodiernal Perfective forms in Table 3. Second, this pattern occurs only in forms with penultimate long vowels introduced by the final suffix sequence *-eet-ε*. Both of these points are illustrated in Table 4. (As in Table 3, melodies affected by Final Lowering are given in bold.)

We account for both of these facts by proposing that forms with H spans from V2 to the antepenult underlyingly possess a {H<sub>V2</sub>+H<sub>FV</sub>} melody, where (a) H<sub>FV</sub> is lowered to L<sub>FV</sub> via Final Lowering (7) and (b) derived L<sub>FV</sub> spreads to the second mora of a long penult due to a rule of *Long Retraction*, which applies before

Table 4: Tonal variation in Hodiernal Stative Forms

	Assertive (nonfinal)	Relative	Object-Focus
Hod. Stative	[H <sub>V2</sub> + H <sub>FV</sub> ]	[H <sub>V2</sub> + H <sub>FV</sub> ]	[H <sub>V2</sub> + L <sub>FV</sub> ]
‘we have hit’	né-tó-[kon-ááng-éét-é]	tó-[kon-ááng-éét-é]	to-[kon-ááng-éét-è]
... w/ 3SG subj.	[H <sub>V2</sub> + L <sub>FV</sub> ]	[H <sub>V2</sub> + L <sub>FV</sub> ]	[H <sub>V2</sub> + L <sub>FV</sub> ]
‘he has hit’	n-óo-[kon-ááng-éét-è]	o-[kon-ááng-éét-è]	á-[kon-ááng-éét-è]

Rightward Spreading extends H<sub>V2</sub> to the right. Long Retraction is formulated in Figure 1.

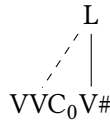

Figure 1: Long Retraction

Note that Long Retraction is independently motivated within Kikamba. Roberts-Kohno (2014) observes that final *super-low* (SL) tones spread onto the second mora of a long penult, exactly as predicted by Long Retraction. Thus, for example, in forms that have a final SL tone, such as infinitives, we see surface contrasts such as *ko*-[kon-ǎ] ‘to hit’ vs. *ko*-[kon-aǎng-ǎ] ‘to hit repeatedly.’ As discussed in §4, we view SL tones as L tones that are downstepped by a following floating L (cf. Clements & Ford 1981). This allows for a straightforward analysis of final “SL spreading”: a final L spreads to the penult via Long Retraction, and this spread L is then downstepped by a following floating L.<sup>8</sup>

Under this analysis, all Hodiernal Stative and Hodiernal Perfective stems share the same underlying melody – {H<sub>V2</sub>+H<sub>FV</sub>} – but surface with different tone patterns due the varying applicability of Final Lowering and Long Retraction. This analysis is illustrated in the derivations in Table 5. Note that in these derivations, only the stems of verbal forms are shown, so that all forms may be seen side by side.

<sup>8</sup>As a reviewer notes, a similar lowering happens in Kuria: phrase-final L becomes SL (i.e. downgliding L) after another L (Mwita 2008; Marlo et al. 2014: 10).

Table 5: Derivations of forms with underlying  $\{H_{V_2} + H_{FV}\}$  melodies

	Hod. Perf	Hod. Perf. 3SG	Hod. Stat.	Hod. Stat. 3SG
UR	$\{H_{V_2} + H_{FV}\}$ [kon-aang-i-ε]	$\{H_{V_2} + H_{FV}\}$ [kon-aang-i-ε]	$\{H_{V_2} + H_{FV}\}$ [kon-aang-eet-ε]	$\{H_{V_2} + H_{FV}\}$ [kon-aang-eet-ε]
Initial Map.	[kon-áang-i-é]	[kon-áang-i-é]	[kon-áang-eet-é]	[kon-áang-eet-é]
$H_{FV}$ Lowering	—	[kon-áang-i-è]	—	[kon-áang-eet-è]
Long V Retract	—	—	—	[kon-áang-eèt-è]
R. Spread	[kon-ááng-i-é]	[kon-ááng-i-è]	[kon-ááng-eet-é]	[kon-ááng-eèt-è]

### 3.6 $\{L_{FV}\}$

The final set of forms to consider in this section are those that realize no H tones at all within the stem. The central question here is whether the final vowels of these verbs should be analyzed as underlyingly toneless, as proposed by Roberts-Kohno (2014), or as bearing a final L tone. We opt for the latter analysis, by a chain of reasoning that is somewhat indirect.

First, some forms that surface without any H tones in the stem are clearly derived, via Final Lowering, from forms with an underlying  $\{H_{FV}\}$  melody. In Table 6, we see that these forms occupy the exact same positions within morphological paradigms as previous forms affected by Final Lowering: object-focus forms, and forms with 3<sup>rd</sup> singular personal subject agreement.

Table 6: Final Lowering in Habitual forms

	Assertive (nonfinal)	Relative	Object-Focus
Habitual	$[H_{FV}]$	$[H_{FV}]$	$[L_{FV}]$
‘we always hit’	né-tó-[kon-aang-a-á]	to-[kon-aang-a-á]	tó-[kon-aang-a-à]
... w/ 3SG subject	$[L_{FV}]$	$[L_{FV}]$	$[L_{FV}]$
‘he always hits’	n-óo-[kon-aang-a-à]	o-[kon-aang-a-à]	á-[kon-aang-a-à]

When Final Lowering occurs in forms with a preceding  $H_{V_2}$  tone, it is clear that the rule must produce a final L tone, rather than a final toneless vowel. This is crucial, for example, in explaining the extent of spreading in Hodiernal Perfective forms with third person personal subject agreement (cf. Table 3): the fact that lowering of  $H_{FV}$  produces  $L_{FV}$  is what ensures that  $H_{V_2}$  is able to spread to the penult, but no further. We can reasonably assume that Final Lowering produces the same results in Table 6, where no confirming evidence from tone spread is

available. Thus, at least some forms in the language without any Hs must be analyzed as having a final L. We assume that learners simply generalize this result, positing final L in forms with no H tones even when Final Lowering is not involved. One such form is the Hesternal Perfective, which shows a final L even in the absence of object focus or a 3<sup>rd</sup> singular personal subject marker (8).

- (8) Hesternal Perfective (Object Relative clause)  
 to-náa-[kon-aang-i-è]  
 '(thing that) we cut (yesterday)'

One final reason for positing final L rather than  $\emptyset$  has to do with the realization of forms like the Hesternal Perfective when they occur before pause in an Assertive phrase. In these contexts, as we will see in §4.2, these forms surface with a final SL tone. This is just what we expect if, as we will propose, the ends of Assertive phrases are marked by a final floating L tone. (Note that has been independently proposed for closely-related Kikuyu by Gjersøe 2016.) In this case, we can regard the final SL tone as simply a downstepped final L, derived from the general lowering of L to SL before floating L tones discussed in §3.5. On the other hand, this simple explanation is not available if we regard the final vowel of (8) as toneless. In that case, the final floating L tone at the end of the Assertive phrase will have no preceding L tone to downstep.

### 3.7 Summary

In this section, we have achieved a modest reduction (from six to five) in the number of tonal melodies needed to account for the forms which Roberts-Kohnno analyzes without any final SL or SH tones. A more impressive result has been a considerable increase in the internal coherence of the proposed melody set: while the melodies posited by Roberts-Kohnno (2014) constitute arbitrary combinations of  $H_{V2}$ ,  $L_{Pen}$ ,  $L_{FV}$  and  $H_{FV}$ , our proposed melodies are simply all combinations of  $\{H_{V2}\}$ ,  $\{H_{FV}\}$  and  $\{L_{FV}\}$  that assign no more than one tone to one vowel. Finally, we have identified two important synchronic processes, Final Lowering and Long Retraction, that are needed to account for intraparadigmatic alternations in stem tones, and well as the crucial role played by the OCP in blocking tone spread. In §4, we complete our analysis of verbal tone in Kikamba by analyzing forms in which additional tones are added beyond this basic melody set.

## 4 Floating L tones

### 4.1 Overview

So far, we have not yet considered any forms that Roberts-Kohno (2014) analyzes as possessing a final melodic super-low (SL) or super-high (SH) tone. In this section, we argue that these forms are best accounted for not by positing a new melodic tone, but by recognizing a distinct class of floating tones that are introduced into the derivation only after all melodic tones have been assigned. In §4.2, we begin with a discussion of phrasal tone, in which the facts concerning floating L tones are somewhat more clear. In §4.3, we then proceed to a discussion of verb-bound floating L tones which Roberts-Kohno analyzes as melodic. Finally, in §4.4, we briefly discuss a form that appears to warrant a final floating H.

### 4.2 Phrasal tones

So far, all verbs in Assertive clauses have been presented as they would appear in non-final position. The reason for this is that at the end of an Assertive clause, verbs systematically show the effects of a phrase-final boundary tone. These effects vary depending on whether the phrase-final verb ends in a H tone or a L tone. If the verb ends in a high tone in non-final position, then it appears with a final *falling* tone phrase-finally (cf. 9a,9b,9c). If the verb ends in a low tone in non-final position, then it ends with a *super-low* tone phrase-finally (cf. 9d).

(9) Position-based alternations in stem-final tone

- |   |                              |
|---|------------------------------|
| a. {H <sub>FV</sub> }: Habitual ‘we always hit’                               |                              |
| Non-final   | né-tó-[kon-aang-a-á] ...     |
| Final   | né-tó-[kon-aang-a-â]         |
| b. {H <sub>V2</sub> +H <sub>FV</sub> }: Hodiernal Perfective ‘we hit (today)’ |                              |
| Non-final   | né-tó-[kon-ááng-i-é] ...     |
| Final   | né-tó-[kon-ááng-i-ê]         |
| c. {H <sub>V2</sub> }: Remote Perfective ‘we hit (long ago)’                  |                              |
| Non-final   | né-tw-áa-[kon-ááng-i-é] ...  |
| Final   | né-tw-áa-[kon-ááng-i-ê]      |
| d. {L <sub>FV</sub> }: Hesternal Perfective ‘we hit (yesterday)’              |                              |
| Non-final   | né-tó-náa-[kon-aang-i-è] ... |
| Final   | né-tó-náa-[kon-aang-i-ë]     |

Roberts-Kohno (2000; 2014) proposes that these alternations are the result of a phrasal SL tone. In a similar spirit, we propose that these alternations are caused



by a floating  $L_\varphi$  tone which marks the right edge of an Assertive phrase. When  $L_\varphi$  follows a word-final L tone, it causes it to *downstep* and surface as SL. However, when  $L_\varphi$  follows a word-final H tone, it docks onto the word-final vowel to form a final fall. Crucially, this docking of  $L_\varphi$  must take place rather late in the derivation. The reason for this concerns the interaction of  $L_\varphi$  with  $H_{V2}$ . As shown in (9c), when a verb with a  $\{H_{V2}\}$  melody is assigned  $L_\varphi$  at the end of the assertive phrase, the result is simply a falling tone at the end of the H tone span from V2 to FV.  $L_\varphi$  thus interacts with  $H_{V2}$  very differently than  $L_{FV}$ , which occupies the FV by itself and limits the spread of  $H_{V2}$  to the penult (cf. 6). The reason for this, we propose, is ordering:  $L_{FV}$  is a *melodic* tone that is assigned at the same time as  $H_{FV}$ , and is thus present early in the derivation when  $H_{V2}$  spreads to the right. By contrast,  $L_\varphi$  is a *phrasal* tone introduced only after all word-level phonology is complete. It is therefore not able to block the rightward spreading of  $H_{V2}$  simply because it is not present when that spreading takes place.

Two additional notes on phrasal tone are in order. First, though we have focused above on the effects of phrasal tone on a phrase-final *verb*,  $L_\varphi$  is always assigned to the last word of an Assertive verb phrase. Thus, if an Assertive verb is followed by a L-final noun, that noun will surface with a final SL tone due to  $L_\varphi$ -induced downstep (cf. 10b). Similarly, if an Assertive verb is followed by a H-final noun, that noun will generally surface with a final fall (cf. 10d). (Note that in the examples to follow, parentheses are used to mark the edges of the *Assertive* phrase, i.e. the minimal phonological phrase in which an Assertive verb appears.)

- (10)  $L_\varphi$  manifests on the final vowel of the Assertive phrase
- a. e-i.ò  
'a banana'
  - b. (né-tó-[kon-aang-a-á] e-i.ò) $_\varphi$   
'we usually hit a banana'
  - c. n-da.á  
'a louse'
  - d. (né-tó-[kon-aang-a-á] n-da.â) $_\varphi$   
'we usually hit a louse'

The second point concerns the final fall observed in (10d). A pervasive generalization in Kikamba is that falling tones are only permitted before pause. Thus, if a H-toned noun like *n-da.á* 'louse' or *cháí* 'tea' stands at the end of an Assertive phrase but is not utterance-final, we do not see a phrase-final falling tone.

Nonetheless,  $L_\varphi$  does not simply disappear without a trace: instead, the vowel that *would* have realized a falling tone (had it been prepausal) surfaces as *super-high* (cf. 11c). In this way, the presence of  $L_\varphi$  can be detected even in the absence of any L-toned surface vowel. This will prove crucial to the discussion of putatively melodic super-low tones in §4.3.

(11)  $\widehat{HL}$  permitted only pre-pausally (Roberts-Kohno 2000: 252)

- a. kemiiná  
'Kemiina (a name)'
- b. ( né-né-ké-[nɛɛngiɛ] kemiinâ )<sub>φ</sub>  
'I gave it to Kemiina'
- c. ( né-né-[nɛɛngiɛ] kemiinǎ )<sub>φ</sub> cháí  
'I gave tea to Kemiina'

### 4.3 “Melodic” SL tones

A number of non-assertive verb forms show alternations very similar to those observed at the ends of assertive phrases. For instance, verbs that show final SL in phrase-final position surface with final L phrase-medially (cf. 12a,b), while verbs that surface with phrase-final falls surface with phrase-medial SH (cf. 12c,d).

(12) Contextual stem alternations of non-assertive verbs

- a. ko-[konǎ]  
'to hit'
- b. ko-[konǎ] ma-i.ò  
'to hit bananas'
- c. to-í-[kon-ááng-éet-ê]  
'we had not hit (long ago)'
- d. to-í-[kon-ááng-éet-ě] ma-i.ò  
'we had not hit bananas (long ago)'

Roberts-Kohno (2000; 2014), recognizing the clear similarities between these alternations and the phrasal alternations in (10) and (11) above, argues that both should be analyzed as the result of an assigned SL tone. Similarly, we propose that all the alternations in (10–12) derive from the variable presence of a floating L tone.

However, as Roberts-Kohno discusses at length, there is a crucial difference between the alternations observed in (12) and those involving Assertive clauses in (10) and (11). While the floating  $L_\varphi$  tone assigned in Assertive phrases surfaces on whatever element stands last within the Assertive phrase, the floating L responsible for downstep in (12a) and for the final falling tone in (12c) is closely bound to the verb. Thus, when it fails to downstep the final L of nonfinal *ko-konà* ‘to hit’ in (12b), it does not then instead cause a final downstep in final *ma-i.ò* ‘bananas’. Similarly, when the floating L tone is unable to form a final falling tone on the verb in (12d), it does not trigger downstep of following *ma-i.ò*, but is instead realized indirectly through in the verb’s SH tone. Unlike the phrasal  $L_\varphi$  tone, then, the floating L tone in (12) must be realized on the verb itself, or not at all. We propose that this is because the floating L tone in these forms is a tonal *suffix* to the verb, rather than a boundary tone to the entire phrase.

The ultimate fate of suffixal L depends both upon the final tone of its verb and on its phrasal context. If suffixal L is assigned to a verb with a final L tone, then it will manifest by downstepping that L so long as the verb appears in phrase-final position, as in (12a). In phrase-medial position, as in (12b), the floating L simply deletes, with no effect on the preceding tone. If the suffixal L belongs to a verb with a final H tone, then it will manifest as part of a final falling tone in utterance-final position, as in (12c), but as part of a final super-high tone utterance-medially, as in (12d). These options are summarized in Table 7.

Table 7: The fate of floating L tones in Kikamba (Ⓛ = floating L)

phrase-medial	phrase-final, utterance-medial	utterance-final
Ⓛ deletes	LⓁ → <sup>+</sup> L HⓁ → <sup>+</sup> H	LⓁ → <sup>+</sup> L HⓁ → <sup>+</sup> H̄L

The fact that suffixal L is found only in verb forms, and the fact that it is closely bound to individual verbs rather than phrases that contain them, makes it appear much like a melodic tone like  $H_{FV}$  or  $L_{FV}$ . However, just as with  $L_\varphi$ , the fact that suffixal L is *not* a melodic tone is shown through its interaction with  $H_{V2}$ : while melodic  $L_{FV}$  limits the spread of  $H_{V2}$  to the penult (cf. 6), suffixal L simply adds on to a long H tone span from V2 to FV. This may be seen clearly in the Negative Habitual forms in (13), where suffixal L added to a form with a  $\{H_{V2}\}$  melody creates either a falling tone in utterance-final position (cf. 13a) or a final super-high tone in phrase-medial position (cf. 13b). In both forms, rightward spreading of  $H_{V2}$  is totally unimpeded by the presence of the suffixal L on FV. This suggests

that suffixal L, like  $L_\phi$ , is added only after all other tones have associated and (in the case of  $H_{V_2}$ ) spread.

(13) Combination of suffixal L with a  $\{H_{V_2}\}$  melody

- a. to-í-[kon-ááng-á-â]  
‘we do not usually hit’
- b. to-í-[kon-ááng-á-ǎ] ma-i.ò  
‘we do not usually hit bananas’

The general conclusion, then, is that while suffixal Ls are more closely linked to the verb than  $L_\phi$ , they must nevertheless be distinguished from melodic tones originating from a single melody because they are assigned at different points in the phonological derivation. This limits the true melodies of Kikamba to those established in §3.

#### 4.4 Melodic SH

A final tone pattern described by Roberts-Kohno involves a H tone span from V2 to FV which is raised to SH on the final vowel (e.g. *tw-áá*-[kon-ááng-ǎ] ‘if/when we hit’). We tentatively propose that this form results from a suffixal floating H tone which *upsteps* the preceding word-final H. More investigation into these forms is required, however.

## 5 Conclusion

Under the reanalysis of Kikamba melodic tone proposed here, the melodic inventory of Kikamba can be reduced from the ten melodies in (14) to the five melodies in (15a–b), the latter of which may combine with the suffixal floating L tone (and, much more rarely, the suffixal floating H tone) in (15c).

(14) Melodic inventory of Roberts-Kohno (2014)

- a. 0 melodic tones  
{ $\emptyset$ }
- b. 1 melodic tone  

{ $H_{FV}$ }	{ $H_{V_2}$ }	{ $SL_{FV}$ }
--------------	---------------	---------------
- c. 2 melodic tones  

{ $H_{V_2}+L_{FV}$ }	{ $H_{V_2}+SL_{FV}$ }	{ $H_{V_2}+SH_{FV}$ }
----------------------	-----------------------	-----------------------

- d. 3 melodic tones  
 $\{H_{V2}+L_{Pen}+H_{FV}\}$                        $\{H_{V2}+H_{FV}+SL_{FV}\}$
- e. 4 melodic tones  
 $\{H_{V2}+L_{Pen}+H_{FV}+SL_{FV}\}$

(15) Our proposed melodic inventory

- a. 1 melodic tone  
 $\{H_{V2}\}$                                        $\{H_{FV}\}$                                        $\{L_{FV}\}$
- b. 2 melodic tones  
 $\{H_{V2}+H_{FV}\}$                                $\{H_{V2}+L_{FV}\}$
- c. Suffixal floating tones  
 $\{L_{Suf}\}$                                        $\{H_{Suf}\}$

This reanalysis produces a tonal inventory that is internally coherent, consisting of a few basic melodic tones whose logical combination yields the full range of attested melodies. More importantly, under this reanalysis, the melodic system of Kikamba is no longer a typological outlier whose relation to other Bantu systems is mysterious. On the contrary, the melodic system instantiates a near-canonical Bantu melody system (cf. Table 1): H and L melodic tones assigned to V2 and FV combine in melodies that target no more than 2 positions at a time. It is important to note, however, that the advantages of (15) are not only aesthetic or even only typological. Arriving at this inventory, and in the process eliminating aspects of (14) such as  $L_{Pen}$ , we have been able to provide unified tonal analyses of semantically coherent sub-paradigms (e.g. those of the Hodiernal Perfective and Stative) that were not possible using the less constrained melodic inventory. Thus, the current proposal is supported by both typological and language-internal considerations.

If this analysis is on the right track, it strongly confirms the crucial importance of synchronic analysis in the typological study of melodic tone. Because the relationship between surface tone patterns and underlying melodies is often highly indirect, we can only meaningfully compare the melodies of Bantu languages after detailed and, we would argue, theoretically consistent, analyses of them have been developed.

Finally, we end on what is to us, at least, an optimistic note. Looking at the incredible *surface* diversity of melodic tone patterns in Bantu, it can be tempting to conclude that melodic assignment is an inherently unconstrained system, where

essentially anything is possible, and where the melodic inventory of a given language is limited only by what its idiosyncratic history makes possible. In the course of our analysis of Kikamba, however, we hope to have shown that the considerable surface diversity observed in Bantu melodic tone patterns is often misleading. With synchronic analysis that carefully distinguishes surface stem tone patterns from underlying melodies, it is possible to find deep similarities between superficially distinct melodic systems. This opens up the possibility that perhaps melodic tone in Bantu is more constrained than it initially appears, so that it may ultimately be possible to state strong restrictions on what constitutes a possible melodic system.

## Abbreviations

Glosses are abbreviated as follows:

1PL	first person singular	NEG	negation
ASP	aspect	PFV	perfective
ASSERT	assertive	PST	past tense
CAUS	causative	RECP	reciprocal
FV	final vowel	REV	reversive
ITER	iterative	SBJ	subject marker
NC.5	class 5 nominal concord prefix	UR	Underlying representation

Tonal abbreviations are:

H	high	SH	super-high
L	low	SL	super-low

Stem position abbreviations are:

V1	stem-initial vowel	FV	stem-final vowel
V0	pre-stem vowel	Pen	penultimate vowel
V2	second stem vowel		

## References

- Bickmore, Lee. 1997. Problems in constraining high tone spread in Ekegusii. *Lingua* 102. 265–290.
- Bickmore, Lee. 1999. High tone spread in Ekegusii revisited: An optimality theoretic account. *Lingua* 109. 109–153.

- Bickmore, Lee. 2007. *Cilungu phonology*. Stanford, CA: CSLI Publications.
- Bickmore, Lee. 2015. *Tones gone crazy: The adventures of the melodic tone in Bantu*. Plenary lecture given at the 46th Annual Conference on African Linguistics, University of Oregon.
- Clements, George N. & Kevin C. Ford. 1981. On the phonological status of downstep in Kikuyu. In Didier L. Goyvaerts (ed.), *Phonology in the 1980's*, 309–357. Ghent: E. Story-Scientia.
- Ebarb, Kristopher J. 2016. An overview of Kabarasi verb tone. *Language* 92. e134–e191.
- Gjersøe, Siri. 2016. Phonological phrases in Kikuyu. In Kate Bellamy, Elena Karvovskaya, Martin Kohlberger & George Saad (eds.), *ConSOLE XXIII: Proceedings of the 23rd Conference of the Student Organization of Linguistics in Europe. 7-9 January 2015, Paris*, 449–471. Leiden: Leiden University Centre for Linguistics.
- Hyman, Larry & Nzama Valinande. 1985. Globality in the Kinande tone system. In Didier L. Goyvaerts (ed.), *African Linguistics* 6, 239–260. Amsterdam: John Benjamins.
- Jones, Patrick J. 2014. *Tonal interaction in Kinande: Cyclicity, opacity, and morphosyntactic structure*. Cambridge, MA: MIT dissertation.
- Kisseberth, Charles W. & David Odden. 2003. Tone. In Derek Nurse & Gérard Philippson (eds.), *The Bantu languages*, 59–70. London: Routledge.
- Manus, Sophie. 2014. Melodic patterns in simákonde. *Africana Linguistica* 20. 263–276.
- Marlo, Michael R. 2008. Tura verbal tonology. *Studies in African Linguistics* 37. 153–243.
- Marlo, Michael R. 2009. Khayo verbal tonology. *Africana Linguistica* 15. 77–129.
- Marlo, Michael R. 2013. Verb tone in Bantu languages: Micro-typological patterns and research methods. *Africana Linguistica* 19. 137–234.
- Marlo, Michael R. 2015. On the number of object markers in Bantu languages. *Journal of African Languages and Linguistics*. 36(1). 1–65.
- Marlo, Michael R., Leonard Chacha Mwita & Mary Paster. 2014. Kuria tone melodies. *Africana Linguistica* 20. 277–294.
- Mateene, Kahombo. 1992. *Essai de grammaire du Kihunde: Syntaxe, morphologie et phonologie mélangées*. Münster: Lit.
- Mwita, Leonard Chacha. 2008. *Verbal tone in Kuria*. Los Angeles, CA: UCLA dissertation.
- Myers, Scott. 1997. OCP effects in Optimality Theory. *Natural Language and Linguistic Theory* 15. 847–892.
- Odden, David. 2009. Tachoni verbal tonology. *Language Sciences* 31. 305–324.

- Odden, David. 2014. Melodic tones in Karanga Shona. *Africana Linguistica* 20. 331–348.
- Odden, David & Lee Bickmore. 2014. Melodic tone in Bantu: overview. *Africana Linguistica* 20. 3–13.
- Roberts-Kohn, Ruth. 2000. Columbus: Ohio State University. (Doctoral dissertation).
- Roberts-Kohn, Ruth. 2014. Melodic tones in Kikamba. *Africana Linguistica* 20. 368–384.



## Chapter 11

# Acoustic correlates of harmony classes in Somali

Wendell Kimper

University of Manchester

Wm. G. Bennett

University of Calgary and Rhodes University

Christopher R. Green

Syracuse University

Kristine Yu

University of Massachusetts at Amherst

In this paper, we present pilot data from a small number of native speakers of Somali, investigating the acoustic correlates of the tongue root and/or voice quality feature relevant to vowel harmony in that language. We find statistically detectable differences along the predicted acoustic dimensions (on the basis of previous articulatory descriptions), and use Linear Discriminant Analysis (LDA) to extend classifications to previously-uncategorized items. However, we find no clear evidence that these differences are categorical or phonological.

## 1 Introduction

The vowel inventory of Somali (East Cushitic) is commonly described as containing five major vowel categories {i,e,a,o,u}, each of which is contrastive for length and (purportedly) for an additional feature that has been variously described as FRONT/BACK (Andrzejewski 1955),  $\pm$ ATR (Saeed 1993), TENSE/LAX (Green et al. forthcoming), and (aryepiglottally) SPHINCTERED/EXPANDED (Edmondson et



al. 2004). This last feature is of particular interest, since it is implicated in a phonological process of vowel harmony that Andrzejewski (1955) describes as extending iteratively beyond word boundaries. If this description is accurate, Somali may constitute the sole putative case of truly iterative harmony beyond word boundaries.

However, investigating this harmony process in Somali presents a number of interesting analytical challenges. The relevant feature contrast is neither represented orthographically nor noted in dictionaries of the language, a relatively small number of lexical items have been described as belonging to one class or the other, and there are few minimal pairs. Furthermore, Andrzejewski (1955) describes inter-speaker and dialect variation with respect to lexical classification. Finally, the articulatory dimensions ascribed to the relevant feature contrast are acoustically diffuse, making clear identification of feature values difficult without articulatory data.

In this paper, we present acoustic data from four native speakers of Somali, with the aim of describing the acoustic correlates of harmony classes and developing a method for classifying tokens of vowels whose feature values have not been described. While we do find statistically significant differences between harmony classes along several acoustic dimensions relevant to tongue root and/or voice quality features, we find no clear evidence to support a categorical phonological feature contrast, and instead suggest the possibility of a near merger between previously-distinct vowel categories.

## **2 Background**

The first necessary step towards categorising vowels along the relevant feature dimension is to identify its likely articulatory and acoustic correlates. Andrzejewski describes the difference between harmony classes as fronting or tongue advancement:

The difference between vowels of Series A and B is that the vowels of Series B are more ‘front’, i.e. articulated with the mid part of the tongue more advanced towards the hard palate and teeth-ridge than the corresponding vowels of Series A. (Andrzejewski 1955)

Throughout this paper, we follow Andrzejewski in adopting Series A and Series B as labels for the two harmony classes; minimal pairs can be seen in Table 1.

There is overlap between the retracted or backed tongue position characteristic of the Series A vowels and the coarticulatory effects of uvular and pharyn-

Table 1: Minimal pairs (Andrzejewski 1955).

	Series A	Series B
<i>dhis</i>	‘build’ (Imper. Sg.)	‘he built’
<i>hel</i>	‘find’ (Imper. Sg.)	‘he found’
<i>kab</i>	‘a sandal’	‘he set’ (e.g. a fractured bone)
<i>qod</i>	‘dig’ (Imper. Sg.)	‘he dug’
<i>tus</i>	‘show’ (Imper. Sg.)	‘he showed’
<i>diiday</i>	‘I fainted’	‘I refused’
<i>hees</i>	‘song’	‘he sang’
<i>laab</i>	‘chest (thorax)’	‘he folded’
<i>duushay</i>	‘she flew’	‘she attacked’

geal consonants in the language (i.e. [q] and [χ]). Indeed, of the items for which Andrzejewski provides a classification, only Series A items contain uvulars or pharyngeals. For further discussion, see §4.4.

Edmondson et al. (2004) provide a careful articulatory description of the difference between Series A and Series B vowels, using laryngoscopic data from a single native speaker of Somali. They argue that the main difference between Series A and Series B vowels is constriction or expansion of aryepiglottic folds, describing the differences as in (1). They also provide some acoustic data suggesting differences in  $F_1$  and  $F_2$  consistent with advancement or retraction of the tongue root, and oral airflow data showing that articulation of Series A vowels exhibits substantially lower airflow than Series B vowels.

(1) *Properties of Harmony Sets (Edmondson et al. 2004)*

Set 1 (Series A)

1. Sphincteric compacting of the arytenoid-epiglottal aperture in the posterior-anterior dimension.
2. Vowel quality that is more retracted.
3. Voice quality that is tense.

Set 2 (Series B)

1. Expansion of the arytenoid-epiglottal aperture in the anterior-posterior dimension.
2. Vowel quality that is more fronted and/or raised.
3. Voice quality that is lax.

Edmondson et al. (2004) note that these findings and previous descriptions are consistent with *register* features, based primarily in voice quality rather than supra-laryngeal articulation. See e.g. Trigo (1991) for further discussion of the relationship between tongue root and register features.

Based on these previous descriptions, the acoustic dimensions under consideration in our study reflect the likely correlates of both register and tongue root features.

Duration and  $F_0$  have been found to be relevant for contrasts involving voice quality (Edmondson & Li 1994; Halle & Stevens 1969), as has spectral slope (Kingston et al. 1997), since lax voice quality results in a relative increase in the energy of the first harmonic. In addition, Edmondson et al. (2007) note that constriction in the aryepiglottic sphincter (as was found for Series A vowels) should result in a higher center of gravity.

$F_1$  and  $F_2$  are the most likely correlates of a process involving advancement or retraction of the tongue root (Starwalt 2008).  $F_1$  bandwidth has also been shown to be relevant to timbre differences in tongue root contrasts in Akan (Hess 1992) and other languages (Starwalt 2008). We have also included  $F_3$  in the set of measurements, as it is involved in tongue root retraction in Arabic pharyngealization Ghazeli (1977).

## 3 Methods

### 3.1 Subjects and elicitation

The present data come from four native speakers of Somali. Speaker 1 (male) and Speaker 2 (female) are originally from regions in Northern Somalia; Speaker 3 (female) is originally from Central/Southern Somalia, and Speaker 4 (female) is originally from Central Somalia. Speakers 1, 2, and 4 currently reside in US diaspora communities, while Speaker 3 resides in South Africa; all speak some English.

Elicitation sessions for Speakers 1–3 consisted primarily of establishing familiarity with lexical items (and grammaticality of sentences) from Andrzejewski (1955). Clear repetitions were elicited for familiar lexical items, and additional items that the speakers volunteered were included for analysis. Elicitation for Speaker 4 consisted of a list of monosyllabic words, with CVC structure and flat tones; all items were previously unclassified.

### 3.2 Data preparation

Measurements for  $F_1$  bandwidth, spectral slope (band energy difference) and center of gravity were taken at vowel midpoints using Praat (Boersma & Weenink 2008). Duration was measured from vowel onset to vowel offset, and mean measurements for  $F_{0-3}$  were taken across the middle 80% of the vowel’s duration.

Only monophthongs were included in the analysis. The number of tokens of Series A, Series B, and unclassified vowels for each vowel category for each speaker is given in Table 2. To reduce collinearity and improve comparability, data were centered within each vowel category for each speaker.

Table 2: Token counts for Series A, Series B, and unclassified vowels.

	Speaker 1			Speaker 2			Speaker 3			Speaker 4		
	A	B	U	A	B	U	A	B	U	A	B	U
[u]	24	12	89	23	9	43	0	0	0	0	0	70
[i]	50	72	116	32	37	61	30	88	172	0	0	30
[a]	80	86	239	89	52	90	86	78	246	0	0	104
[o]	41	44	88	38	18	23	62	36	82	0	0	22
[e]	30	55	36	18	33	13	46	30	54	0	0	0
	225	269	568	200	149	230	224	232	554	0	0	226

## 4 Results

### 4.1 Acoustic correlates

The first question to address is whether Series A and Series B vowels show significant differences along the predicted dimensions (and in the predicted directions). Speakers have been analysed separately, since there is reason to expect inter-speaker variation (Andrzejewski 1955).

Because the relevant acoustic dimensions are collinear, linear models<sup>1</sup> (with series and vowel category as predictors) were fitted separately for each acoustic dimension, excluding extreme outliers ( $|z| > 3$ ). Bonferroni correction was applied ( $\alpha/8$ ) to adjust for familywise error (corrected p-values are reported). For

<sup>1</sup>Linear mixed effects models with random intercepts for either “word” or “sentence” were attempted, but rarely converged.

those dimensions which showed a statistically significant difference between Series A and Series B, Hartigan's Dip Test for Unimodality was applied. Data from Speaker 4 was excluded from this stage of the analysis, as it contained only unclassified tokens.

Distributions and means for Speakers 1–3 can be seen in Figures 1–3. Series A and Series B vowels differed in  $F_1$  and  $F_1$  bandwidth for all speakers ( $p < 0.001$ ), as well as spectral slope ( $p < 0.05$  for Speaker 1;  $p < 0.001$  for Speakers 2–3).  $F_2$  showed significant differences for Speakers 1–2 ( $p < 0.001$ ) but not for Speaker 3,  $F_3$  was significant only for Speaker 2 ( $p < 0.01$ ), and center of gravity was significant only for Speaker 3 ( $p < 0.05$ ). Neither duration nor  $F_0$  showed significant differences for any speaker, however it is worth noting that Somali has tonal and prosodic processes (Green et al. forthcoming) that were not controlled for in elicitations, potentially resulting in noise that could obscure relevant differences.

Of the acoustic dimensions that showed significant differences, the only one to show any statistically detectable departure from unimodality was  $F_1$  bandwidth, and only for Speaker 3. Furthermore, the source of this multimodality may not be directly related to vowel series – as can be seen in Figure 3, while the lower mode appears to consist primarily of Series A observations, the higher mode shows substantial overlap between Series A and Series B.

## 4.2 Classification

Acoustic analysis of the previously-classified items shows that Series A and Series B items differ detectably along a number of the expected acoustic dimensions ( $F_1$ ,  $F_1$  bandwidth,  $F_2$ ,  $F_3$ , center of gravity, and spectral slope). But do these differences pattern in a way that might allow listeners (or learners) to map acoustic realizations onto discrete phonological categories? The small effect sizes and lack of detectable departure from unimodality found above provides cause for doubt. In this section, we submit both classified and unclassified forms to cluster analysis, to determine the extent to which observations pattern into discoverable categories.

For Speakers 1–3, data for both classified and unclassified tokens were subjected to k-means cluster analysis, using data from only those acoustic dimensions that had shown significant differences for any speaker in the previous stage of analysis. Series A and Series B means were used as initial centers for the clusters, and the analysis was done separately for each speaker.<sup>2</sup> The results of cluster analysis matched prior classifications somewhat poorly – 66% of tokens for

---

<sup>2</sup>For Speaker 2, it was necessary to remove outliers prior to cluster analysis.

# 11 Acoustic correlates of harmony classes in Somali

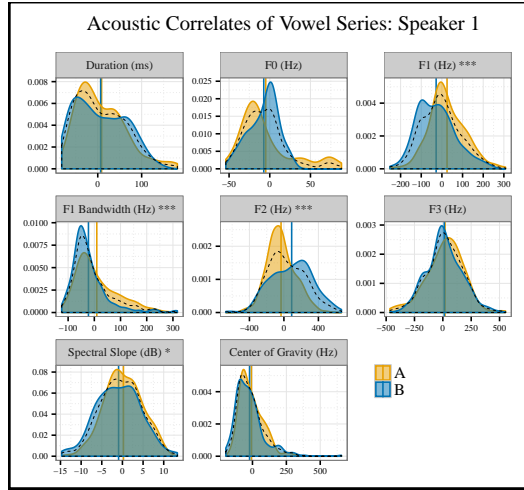

Figure 1: Density plots of Series A and Series B vowels for Speaker 1 (centered measurements, extreme outliers removed). Dashed lines represent combined distributions; vertical lines represent series means; asterisks indicate statistically significant differences (after Bonferroni correction).

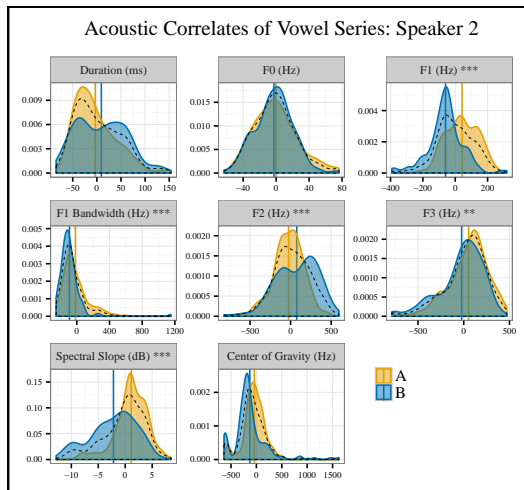

Figure 2: Density plots of Series A and Series B vowels for Speaker 2 (centered measurements, extreme outliers removed). Dashed lines represent combined distributions; vertical lines represent series means; asterisks indicate statistically significant differences (after Bonferroni correction).

Speaker 1, 62% for Speaker 2, and only 54% for Speaker 3.<sup>3</sup> The sets of matched tokens for each speaker (all acoustic dimensions) served as training data for a linear discriminant analysis (LDA), which was then used to predict classification values for the full set of tokens for that speaker.

For Speaker 4, Series A and Series B grand means from Speakers 1–3 served as the initial centers for k-means cluster analysis. Additionally, an initial LDA was trained on pooled classification-matched data from Speakers 1–3 and used to predict classification values for data from Speaker 4. Classifications from the cluster analysis and the initial LDA matched on 84% of tokens; the set of matched tokens served as training data for a second LDA, which was then used to predict classification values for the full set of tokens from Speaker 4.

The acoustic correlates of classes differed considerably between speakers – the only acoustic dimension whose correlation with the discriminant was consistently medium-sized or larger was spectral slope (medium for Speaker 1, large for Speakers 2–4). All other acoustic dimensions showed medium-sized or larger correlations for at least one speaker, and all except  $F_1$  bandwidth showed medium or larger correlations for three out of the four speakers. As with the individual acoustic dimensions, the linear discriminant itself does not appear to show a bimodal distribution – for all three speakers, Hartigan’s Dip Test on failed to detect any departure from unimodality.

### 4.3 Lexical status

The match between the cluster analysis and previous classifications, while fairly poor, was nevertheless above chance for Speakers 1 and 2 (and marginal for Speaker 3, from whom there were fewer observations). This suggests, as with the acoustic analysis, that there is some difference between Series A and Series B vowels that the cluster analysis is sensitive to. However, as before, the unimodality of the linear discriminant casts doubt on the presence of clear categories.

If the distinction between Series A and Series B vowels has *contrastive* status as a phonological feature, it should be lexically specified – we would therefore expect the realization of this feature to be consistent across tokens of an individual lexical item, and those tokens should be assigned to the same category in the classification procedure more often than expected by chance.

Classifications for individual segments were compared across multiple tokens of each lexical item, and all items which appeared more than once were categorized as either *invariant* or *variant* – for example, all 6 instances of the [i] in *biyo*

---

<sup>3</sup>95% Confidence Intervals: 62-70% for Speaker 1, 54-64% for Speaker 2, 49-58% for Speaker 3.



from Speaker 3 were classified as B, so this was categorized as invariant. On the other hand, the initial-syllable [a] in *dabqaad* from Speaker 2 was classified as A for 2 out of 4 tokens and B for the remainder, so it was categorized as variant. Baseline frequencies of A and B classes (combined with the number of tokens for each item) were used to calculate the chance probability of invariance. As can be seen in Figure 4a, segments were invariant considerably more frequently than would be expected by chance ( $p < 0.001$  for all speakers).

For each word with more than one monophthong, consistency was examined between the vowels in each token. For example, in one token of *aha* from Speaker 1, both vowels were assigned to class A, so it was categorized as invariant. On the other hand, in one token of *culus* from Speaker 2, the first [u] was classified as B while the second was classified as A, so it was categorized as variant. Figure 4b shows that vowels within the same word token were classified consistently more frequently than would be expected by chance ( $p < 0.001$  for Speakers 1 and 3,  $p < 0.01$  for Speaker 2).<sup>4</sup>

Turning to the purported minimal pairs, Figure 5 shows the high degree of acoustic variability of tokens belonging to each member (compared with the differences between members). There was also considerable variation in classification between tokens – none were consistent across all speakers, and no speaker produced any minimal pairs where both members were consistently classified distinctly.

#### 4.4 Uvular and pharyngeal consonants

Recall from Section 2 that, for lexical items given classifications in Andrzejewski (1955), only Series A words contain uvular or pharyngeal consonants. Could this be a possible source of the effects presented above? If vowels in these words undergo (gradient) coarticulation, we would expect their presence in Series A (but not series B) to result in the kind of small but detectable differences in the acoustic correlates examined. Additionally, because flanking consonants would be held constant among tokens of a single lexical item, we would expect this to result in increased consistency of classification.

The acoustic analysis from Section 4.1 was repeated for all subjects with items containing either uvular or pharyngeal segments removed. The results were by

---

<sup>4</sup>Calculations of chance probability were done under the assumption of independence, which does not entirely hold in this case – vowel-to-vowel coarticulation influences the acoustic dimensions on which classification was based, and would be expected to slightly increase the likelihood of vowels in the same word token sharing the same classification. As such, this result should be viewed with appropriate caution.

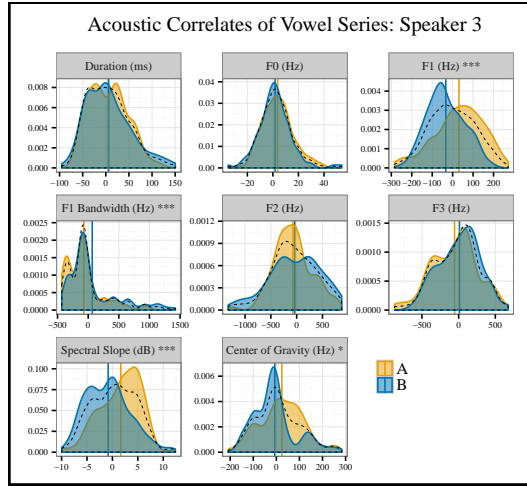

Figure 3: Density plots of Series A and Series B vowels for Speaker 3 (centered measurements, extreme outliers removed). Dashed lines represent combined distributions; vertical lines represent series means; asterisks indicate statistically significant differences (after Bonferroni correction).

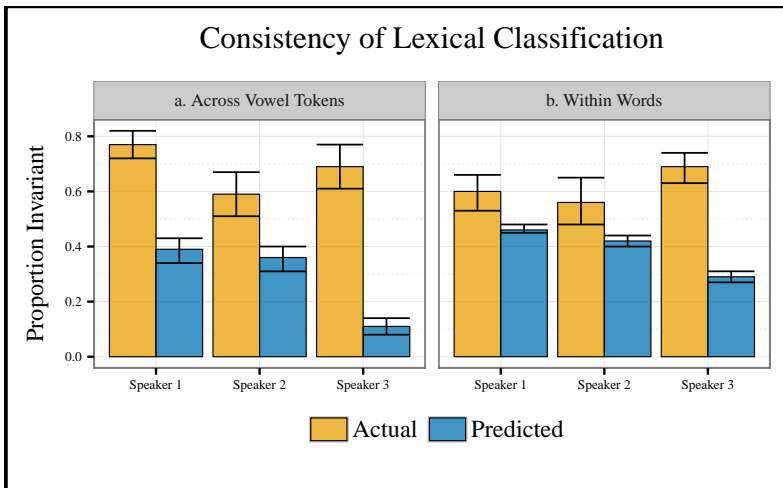

Figure 4: Invariance of classification (a) among vowel tokens for each position of each word, (b) within individual word tokens, and (c) consistency of invariance across tokens of the same word. Error bars represent 95% confidence intervals; predicted values represent means of the chance probabilities for each item.

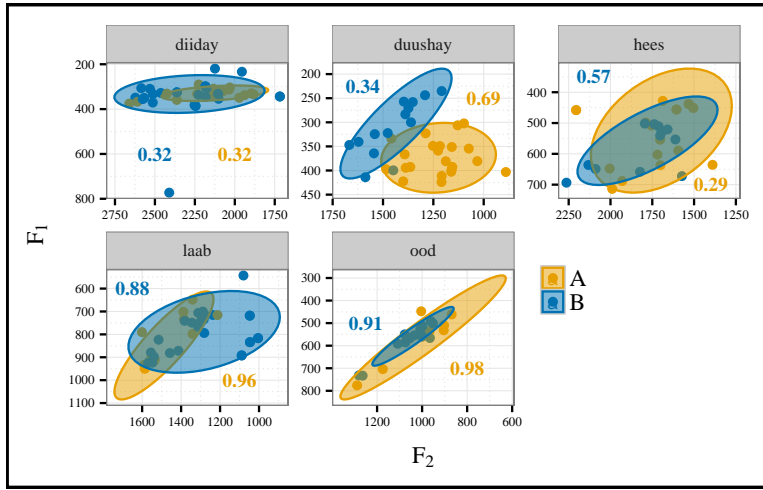

Figure 5: Formant plots for minimal pairs, pooled data for all speakers. Ellipses represent 90% confidence; overlaid numbers represent the proportion tokens for each member of the pair that were classified as A.

and large the same – the effects for spectral slope for Speaker 1 and center of gravity for Speaker 2 fell below the threshold for statistical significance, but the outcomes for all other measures for all three speakers were unchanged. Likewise, the lexical consistency analysis was also repeated with items containing uvular or pharyngeal consonants removed. For Speakers 1 and 2, the effect was retained – classification was invariant across tokens of a single lexical item more often than would be expected by chance. However, for Speaker 2, the lexical consistency effect was not found in the absence of uvulars and pharyngeals.

These results suggest that coarticulatory effects are unable to fully explain either the acoustic difference between Series A and Series B vowels or the consistency of classification across tokens of individual lexical items.

## 5 Discussion

The aim of this study was to provide a detailed acoustic description of the feature distinguishing harmony sets in Somali, to develop a method of classification that can be applied to vowels whose feature specification has not been described, and to begin to ascertain its phonological status in the language. The data presented in the previous section show that there is considerable gradience and variability, but some clear patterns do emerge; a summary of results is presented in Table 3.

Table 3: Summary of results of acoustic analysis and classification. Checkmarks represent statistically significant effects, and effect sizes of correlation coefficients from classification are listed alongside.

	F <sub>1</sub>		F <sub>1</sub> Band.		F <sub>2</sub>		F <sub>3</sub>		Sp. Slope		C. Grav.	
Sp. 1	✓	M	✓	S	✓	L	✗	XS	✓	M	✗	S
Sp. 2	✓	M	✓	S	✓	XS	✓	M	✓	L	✗	L
Sp. 3	✓	S	✓	M	✗	L	✗	L	✓	L	✓	L
Sp. 4	N/A	M	N/A	S	N/A	L	N/A	M	N/A	L	N/A	L

The most consistent acoustic correlates of harmony Series were F<sub>1</sub>, F<sub>1</sub> bandwidth, and spectral slope, which were statistically detectable for all subjects from whom previously classified items were available. This is consistent with Edmondson et al. (2004)'s articulatory findings – constriction of the aryepiglottic fold should result in a lowered position of the tongue root, resulting in higher F<sub>1</sub>, while the resulting effects on voice quality predict a steeper spectral slope. It is not clear at present whether differences in F<sub>1</sub> bandwidth are an independent measure of voice quality or simply a reflection of the effects on F<sub>1</sub>, since the two are highly correlated.

However, we find no clear evidence in this data for a categorical phonological distinction. First, there is no detectable departure from unimodality along the relevant acoustic dimensions<sup>5</sup>. Additionally, the mean differences between previously-classified Series A and Series B vowels, while statistically detectable, are fairly small; for F<sub>1</sub> they range from 27.93Hz for Speaker 1 – which is just barely above the just noticeable difference threshold for F<sub>1</sub> (Kewley-Port 1995) – to 57.89Hz for Speaker 2.

The purported minimal pairs fared even worse, with a mean difference of 6.32Hz for Speaker 1 and 14.98Hz for Speaker 2, both of which fall below the threshold of perceptibility.<sup>6</sup> There is therefore no evidence from this data that these actually are minimal pairs, at least for these speakers. We have found fewer than a dozen minimal pairs described in the literature; of these, many minimally-distinct roots take obligatory suffixing morphology, and others are uncommon words that were not known to all of our speakers. The remaining pairs show no differences that rise above the threshold of perceptibility.

<sup>5</sup>The one exception here is F<sub>1</sub> bandwidth for Speaker 3, but as mentioned above this might not be related to vowel series.

<sup>6</sup>Speaker 3 did not produce a sufficient number of minimal pair tokens.

One finding that does provide a suggestion that vowel series distinctions might possibly be phonologically relevant is the lexical consistency of classification – a given vowel exhibits similarities across different tokens of the lexical item it belongs to, resulting in consistent classification far higher than would be expected by chance. This suggests that there is some lexically-specified property which affects vowels along the relevant acoustic dimensions.

The distinction between Series A and Series B vowels in Somali seems, then, to have an intermediate status – neither fully contrastive nor entirely absent. This is consistent with a near merger (Labov et al. 1972), and suggests several avenues for further research. First, data from a larger number of speakers and representing a more carefully balanced sample of lexical items is needed to be certain that the lack of categoricity is not a symptom of noisy data. Additionally, perceptual data is needed to determine whether listeners are able to accurately distinguish minimal pairs.

## 6 Conclusion

In this paper, we have presented pilot data from a small number of native speakers of Somali, investigating the acoustic correlates of the tongue root and/or voice quality feature relevant to vowel harmony in that language. We have found statistically detectable differences along the predicted acoustic dimensions (on the basis of previous articulatory descriptions) but no clear evidence that these differences are categorical or phonological, suggesting the possibility of a near merger.

It is difficult to draw any broad conclusions with a small number of speakers, particular with respect to a phenomenon that has been described as subject to dialect and individual variation. However, it does seem likely from our data that the categorical distinction between Series A and Series B vowels is in the process of being lost in at least some varieties of Somali. Further research is warranted, with higher numbers of speakers from a broader variety of dialect regions, more controlled and balanced word lists, and a variety of elicitation tasks.

## References

- Andrzejewski, Bogumił W. 1955. The problem of vowel representation in the Isaaq dialect of Somali. *Journal of the School of Oriental and African Studies* 17. 567–580.

- Boersma, Paul & David Weenink. 2008. Praat: Doing phonetics by computer (Version 5.0.17) [Computer program]. <http://www.praat.org/>, accessed 2008-4-1. Developed at the Institute of Phonetic Sciences, University of Amsterdam.
- Edmondson, Jerold A., John H. Esling & Jimmy G. Harris. 2004. Supraglottal cavity shape, linguistic register, and other phonetic features of Somali. Ms, University of Texas at Arlington and University of Victoria.
- Edmondson, Jerold A. & Shaoni Li. 1994. Voice quality and voice quality change in the Bai language of Yunnan Province. *Linguistics of the Tibeto-Berman Area* 17(2). 49–68.
- Edmondson, Jerold A., Cécil M. Padayodi, Zeki Majeed Hassan & John H. Esling. 2007. The laryngeal articulator: Source and resonator. In *Proceedings of ICPHS XVI*, 2065–2068. Saarbrücken.
- Ghazeli, Salem. 1977. *Back consonants and backing coarticulation in Arabic*. University of Texas at Austin. (Doctoral dissertation).
- Green, Christopher R., Michelle E. Morrison & Nikki B. Adams. Forthcoming. *A grammar of Common Somali*. Berlin: Mouton de Gruyter.
- Halle, Morris & Kenneth N. Stevens. 1969. On the feature “Advanced Tongue Root”. *MIT Research Laboratory of Electronics Quarterly Progress Report* 94. 209–215.
- Hess, Susan. 1992. Assimilatory effects in a vowel harmony system: An acoustic analysis of advanced tongue root in Akan. *Journal of Phonetics* 20. 475–492.
- Kewley-Port, Diane. 1995. Thresholds for formant-frequency discrimination of vowels in consonantal context. *Journal of the Acoustical Society of America* 97(5 Pt. 1). 3139–46.
- Kingston, John, Neil A. Macmillan, Laura Walsh Dickey, Rachel Thorburn & Christine Bartels. 1997. Integrality in the perception of tongue root position and voice quality in vowels. *Journal of the Acoustical Society of America* 101(3). 1696–1709.
- Labov, William, Malcah Yaeger & Richard Steiner. 1972. *A quantitative study of sound change in progress*. Philadelphia: U.S. Regional Survey.
- Saeed, John. 1993. *Somali reference grammar*. Kensington: Dunwoody.
- Starwalt, Coleen. 2008. *The acoustic correlates of ATR harmony in seven- and nine-vowel African languages: A phonetic inquiry into phonological structure*. University of Texas at Arlington. (Doctoral dissertation).
- Trigo, Loren. 1991. On pharynx-larynx interactions. *Phonology* 8. 113–136.

## Chapter 12

# Prosody and the conjoint/disjoint alternation in Tshivenda

Leland Paul Kusmer

University of Massachusetts at Amherst

Tshivenda (Guthrie S21) shares with other Southern Bantu languages a distinctive alternation in the form of the verb, termed the conjoint/disjoint alternation. I will present data from original fieldwork showing that, in contrast to other related languages, the Tshivenda conjoint and disjoint forms are not in complementary distribution by syntactic context, and instead show a distinctive three-way split in acceptability. I will also show that the same three-way split obtains in the frequency of utterance-internal penultimate lengthening. I discuss two possible analyses of this correlation, one in which the disjoint is a purely prosodic phenomenon and one in which the correlation is due to the influence of some third factor such as information structure.

## 1 Introduction

Tshivenda<sup>1</sup> shares with other Southern Bantu languages a distinctive morphological alternation in the form of the present tense prefix, commonly termed the CONJOINT/DISJOINT ALTERNATION. As shown below, the simple present is expressed either by the prefix /a-/ (termed the disjoint form) or /ø-/ (termed the conjoint).

- (1) Tshivenda (Bantu)<sup>2</sup>
- a. ndi (a) ǀá ǀnemeǀeme  
1SG DSJ eat termite  
'I eat termite.'

---

<sup>1</sup>Guthrie S21; ~1.3m speakers in South Africa (Limpopo Province) & Zimbabwe.

<sup>2</sup>Unless otherwise noted, all examples are from my own fieldwork on Tshivenda.



- b. ndi \*(a) ǀá  
1SG DSJ eat  
'I eat.'

In this paper, I will present new data from original fieldwork on Tshivenda which shows that the distribution of the disjoint prefix in that language shows a three-way distribution: It's obligatory in some contexts, impossible in others, and optional elsewhere. This contrasts with other languages with this alternation, e.g. isiZulu (Halpert & Zeller 2015), where the conjoint and disjoint forms are typically in complementary distribution, i.e. no optionality is possible.

I will also present new data on the prosody of Tshivenda, which strikingly shows the same three-way distribution. The prosodic phenomenon in question, penultimate lengthening, is common to many Bantu languages and applies to some large prosodic unit (typically taken to be the intonational phrase). In Tshivenda, the penultimate syllable of the utterance is always lengthened, but some utterance-internal penults may also be lengthened. I will demonstrate that the same contexts conditioning the three-way split in the disjoint prefix condition a similar split in penultimate lengthening: In those contexts in which the disjoint prefix is required, penultimate lengthening is frequent; in those contexts in which the prefix is impossible, penultimate lengthening is vanishingly rare; and in those contexts in which the prefix is optional seem to allow an intermediate frequency of lengthening.

I will argue that any analysis of these phenomena must capture the close relation between the conjoint/disjoint alternation and prosody. I will then present two possible analyses. In one, the disjoint prefix is a purely prosodic phenomenon in the sense that it is conditioned solely by the location of the verb within an intonational phrase.<sup>3</sup> In the other analysis, information structure plays the role of a "third factor" conditioning both the disjoint prefix and the prosodic structure. I will discuss the consequences of each of these analyses and propose further research to help decide between these two options.

The structure of this paper is as follows. In §2, I will discuss the disjoint alternation in Tshivenda, comparing and contrasting it with other Southern Bantu languages. I will then present in §3 the results of a survey on the acceptability of conjoint and disjoint verb forms in different syntactic contexts, showing that

---

<sup>3</sup>This first proposal closely mirrors one made in Cheng & Downing (2009) for isiZulu. However, Halpert & Zeller (2015) has convincingly argued that the isiZulu case cannot be prosodic in nature and must have a deeply syntactic origin. The present study cannot currently decide between these two possibilities; it may be the case that a similar argument may be made for Tshivenda.



there is a three-way split in the acceptability of this prefix by syntactic context. In §4, I'll go on to discuss the results of a study on sentence-internal penultimate lengthening across a variety of syntactic contexts, showing that the same three-way split in the distribution emerges. In §5 I will present two possible models of the relationship between disjoint marking and prosody which can account for this data. Finally, in §6 I will discuss the advantages and disadvantages of these models and propose possible future work.

## 2 The conjoint/disjoint alternation

Southern Bantu languages frequently show an alternation in the form of the verb under certain tenses. For instance, in isiZulu, the simple present takes a prefix /ya-/ in some contexts, but is / $\emptyset$ -/ elsewhere:

- (2) isiZulu (Halpert & Zeller 2015)
- a. uMlungisi u- pheka iqanda  
M.           3s- cook egg  
          'Mlungisi is cooking an egg.'
  - b. \*uMlungisi u- ya- pheka iqanda  
M.           3s- yA- cook egg
- (3) a. \*uMlungisi u- pheka  
M.           3s- cook
- b. uMlungisi u- ya- pheka  
M.           3s- yA- cook  
          'Mlungisi is cooking.'

The short form of the verb (/ $\emptyset$ -/) is traditionally termed the “conjoint” form; the long form (/ya-/) is called the “disjoint”. Halpert & Zeller (2015) gives the following generalization for the distribution of these forms:

- (4) Conjoint-disjoint generalization (isiZulu):
- a. Conjoint ( $\emptyset$ ): appears when vP contains material (after A movement)
  - b. Disjoint (ya): appears when vP does not contain material (after A movement)

Note two key properties of this generalization:

1. The forms of the verb are in complementary distribution.
2. The distribution is predictable based on syntactic context.

This seems to be the norm across Southern Bantu: The disjoint alternation is a deeply (morpho-)syntactic fact. In fact, in isiZulu and other languages the alternation appears in several different tense/aspect/polarity combinations with different morphological realizations, but with the same structural generalization governing which form is realized. In Tshivenda, by contrast, the disjoint alternation appears only in the simple present tense – all other tense/aspect/polarity combinations do not alternate.<sup>4</sup> Poulos (1990) gives the following generalization about the distribution of the disjoint prefix:

- (5) Conjoint-disjoint generalization (Tshivenda, after Poulos):
- a. The disjoint is available everywhere.
  - b. The conjoint is ungrammatical when the matrix verb is last in the sentence.<sup>5</sup>

In contrast to isiZulu, this generalization does not place the conjoint & disjoint forms in complementary distribution – rather, it seems to suggest that the disjoint is the default form, with a specialized conjoint form required only in certain contexts. It also makes no reference to anything deeply syntactic in nature, but instead refers to the linear order of constituents. I will show that while the details of this generalization are inadequate – the disjoint is not in fact available everywhere, and the conjoint is ungrammatical in some cases where the verb is not last in the sentence – the underlying nature of this generalization is correct: The Tshivenda conjoint & disjoint forms are not in complementary distribution, and their distribution seems to be based on post-syntactic conditions.

---

<sup>4</sup>Creissels (1996) shows that Setswana, a closely-related language, shows tonal reflexes of the conjoint/disjoint alternation in some tenses. While I can confirm that no such alternation occurs in the present tense, I currently lack detailed tonal data on other tenses. However, Cassimjee (1992) does not note any anomalous tonal alternations, though she does note the present tense conjoint/disjoint distinction; while this is not conclusive, it supports the hypothesis that Tshivenda only shows this alternation in the present tense.

<sup>5</sup>Poulos' original generalization ignores the distinction between matrix and embedded verbs; in other Southern Bantu languages, the verb in a relative clause may take conjoint even when sentence-final. I lack detailed data on Tshivenda relative clauses; however, see §6 for further discussion.

### 3 Survey design and results

I conducted a pilot study on the conjoint/disjoint alternation at the University of Venda in Thohoyandou, Limpopo Province, South Africa. The study consisted of a short questionnaire asking for grammaticality ratings on a variety of sentences. The design of the survey was as follows:

- 8 conditions, varying what kind of material followed the verb.
- Each sentence was presented twice: once in the conjoint, once in the disjoint.
- A total of 56 test items were presented, plus 44 fillers (grammatical) / controls (ungrammatical) = 100 questions
- 12 native speakers of Tshivenda were asked to rate items from 1 (“mistaken or incomplete”) to 5 (“natural and complete”).

The conditions varied based on what material followed the verb:

1. **final** the verb was sentence final.
2. **temporal** the verb was followed by a temporal adverb (‘today’, ‘now’).
3. **locative** followed by a locative adverb (‘at home’, ‘in the forest’).
4. **manner** followed by a manner adverb (‘well’, ‘badly’).
5. **fhedzi** followed by the focus-sensitive operator *fhedzi* (‘only’).
6. **secondary** followed by a secondary predicate (‘go to the tree’).
7. **object** transitive verb + in situ object.
8. **dislocated** transitive verb + right-dislocated object.

A few of these conditions merit some further explanation. First, the **DISLOCATED** condition included sentences in which the direct object was coreferenced by an object marker on the verb. In many Bantu languages, including Tshivenda, objects coreferenced in this manner are generally not in their base position inside the vP (Buell 2005). For instance, as shown in (6), it is possible to separate a coreferenced object from the verb with an adverb; this is not possible with a non-coreferenced object.

- (6) a. Tshiṅoni tshi a dzhia (\*zwíno) thanga  
7.bird s.7 DSJ take now 9.seed  
'The bird takes (\*now) a seed.'
- b. Tshiṅoni tshi a í dzhi zwíno thanga  
7.bird s.7 DSJ 9.OBJ take now 9.seed  
'The bird takes it now, the seed.'

The SECONDARY block included sentences in which the verb was followed by a clausal adjunct marked with the dependent prefix *tshi-* (Van Warmelo 1989):

- (7) ndou í (a) gidima í tshi ya daka -ni  
9.elephant 9.SUBJ (DSJ) run 9.SUBJ DEP go forest LOC  
'The elephant runs into the forest.'

Finally, in the FHEDZI condition the verb was followed by the focus-sensitive operator *fhedzi*, which may be roughly glossed as 'only'. The intention was for this to narrowly scope over the VP. However, the results show that speakers mostly rejected these sentences (regardless of which form the verb took), indicating that perhaps this narrow scope is difficult to arrive at pragmatically. This condition will be discarded in the analysis here.

### 3.1 Results and analysis

Figure 1 shows the mean ratings per speaker for each condition, including controls and fillers.<sup>6</sup> The dashed lines separate out conditions into groups with similar behavior.

Within each condition, I calculated a by-speaker mean difference score between ratings given to the disjoint and to the conjoint sentences. In the resulting score, a positive value indicates that the speaker preferred the disjoint form of the verb, and a negative score that they preferred the conjoint. If the score is not significantly different from zero, then no preference can be assessed. In Figure 2, error bars indicate 95% confidence intervals.

---

<sup>6</sup>This box-and-whisker plot should be read as follows: The dark horizontal mark indicates the median overall rating. The box extends out on either side to the edges of the 1<sup>st</sup> and 3<sup>rd</sup> quartiles, while the "whiskers" extend out to 1.5 times the interquartile range; if no box or whisker is drawn, this indicates that the quartiles are at the median itself, i.e. that most responses are at the median. Speakers whose average response in that condition fell outside of the extent of the whiskers are regarded as outliers and plotted as individual points.

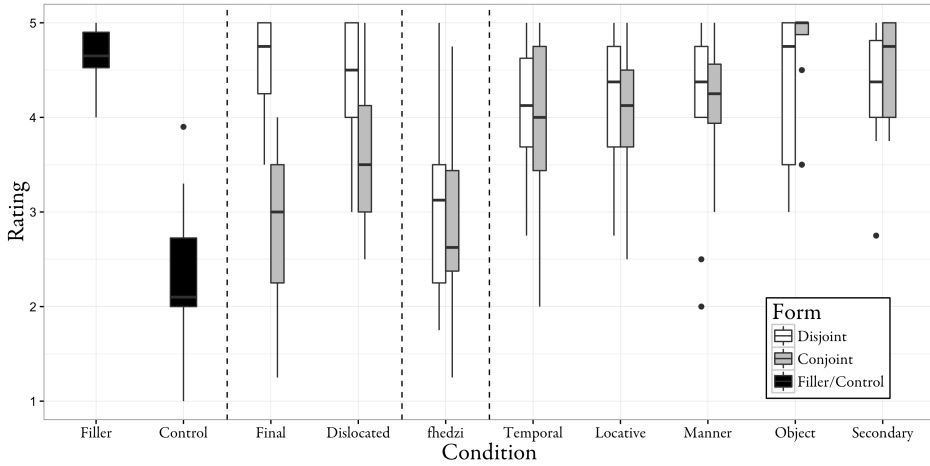

Figure 1: Raw ratings of conjoint/disjoint forms, by condition

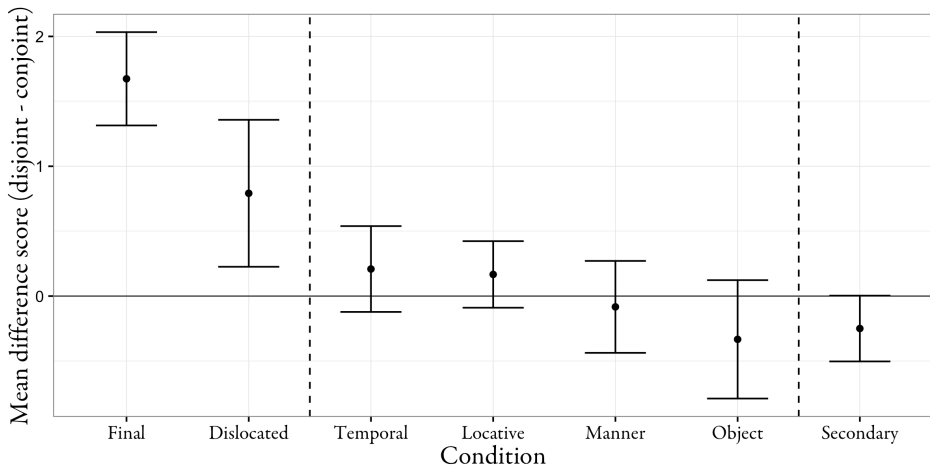

Figure 2: Conjoint / disjoint preferences, by condition

From Figure 2, it can be seen that the FINAL and DISLOCATED conditions show a significant<sup>7</sup> preference for the disjoint; the ADVERB and OBJECT conditions show no significant difference from zero; and only the SECONDARY condition shows a significant preference for the conjoint. Together with the fact that the ADVERB and OBJECT conditions generally received ratings at ceiling, these results show clearly that there is a three-way split in the grammaticality of the conjoint and disjoint forms of the verb, summarized in Table 1.

Table 1: Conjoint/disjoint availability by context

FINAL	Disjoint
DISLOCATED OBJECT	Disjoint
ADVERB	Either
IN SITU OBJECT	Either
SECONDARY PREDICATE	Conjoint

Compare this distribution with the generalization stated in Poulos (1990). This generalization is proven false on two counts: First, the disjoint form is not in fact available everywhere – in particular, when a secondary predicate follows the verb, the disjoint is ungrammatical. Second, the conjoint is ungrammatical in some situations where the verb is not last in the sentence. However, in at least some contexts, it is true that the conjoint and disjoint forms are equally acceptable. This contrasts with the situation in most other southern Bantu languages, particularly isiZulu, where the availability of the two forms is strictly determined by the syntactic context. I take this as evidence that the disjoint alternation in Tshivenda is a different class of phenomenon from the other Bantu languages. In particular, in the sections that follow, I will present evidence that the alternation is prosodically conditioned in Tshivenda, and that the optionality of the disjoint prefix corresponds precisely to optionality in the prosodic phrasing.

## 4 Penultimate lengthening

The same syntactic contexts which condition the availability of the conjoint and disjoint forms also differ systematically in their prosodic properties, specifically

<sup>7</sup>Significance was assessed at the 0.05 level using the Holm-Bonferroni correction for multiple comparisons.

in the distribution of penultimate lengthening. Tshivenda does not have lexically contrastive vowel length, but lengthens the penultimate syllable of intonational phrases:

- (8) a. ndó mbíndímédza **ludambwa:na**  
 1sg.PST destroy 11.dam  
 ‘I destroyed the dam.’
- b. ndó mbíndímédza ludambwana **namú:si**  
 1sg.PST destroy 11.dam today  
 ‘I destroyed the dam today.’

Penultimate lengthening is common across the Bantu family (Hyman 2013). It is typically regarded as a phonological (rather than phonetic) lengthening on the grounds that it may have other effects on the suprasegmental phonology of the utterance, in particular on tone. Tshivenda shares with many other Bantu languages the property that contour tones may only occur on lengthened penults, which is typically taken to indicate that the lengthening adds a tone-bearing unit (e.g. a mora) to the target syllable.

The penult of the entire (declarative) utterance is always lengthened. However, there may be utterance-internal lengthening, as well. For example, in (9) *ludambwa:na* shows penultimate lengthening despite not being utterance-final.

- (9) ndó mbíndímédza **ludambwa:na namú:si**  
 1sg.PST destroy 11.dam today  
 ‘I destroyed the dam today.’

Comparing (9) and (8b), it can be seen that internal lengthening in this syntactic context is apparently variable. However, there is room for uncertainty about the source of this variability: If penultimate lengthening is associated with the intonational phrase level of prosodic structure, then the contrast between (9) and (8b) may indicate a contrast in intonational phrasing. Alternatively, one might propose that (8) still has an intonational phrase boundary after the verb, and what is variable is not the structure but the lengthening itself. If the variability lies in the prosodic structure formation, then one might expect to find some syntactic contexts in which the prosodic structure is not variable and internal lengthening happens 100% of the time. By contrast, if variability lies in the structure-sensitive phonological lengthening only, then even in syntactic contexts where the prosodic structure was fixed, one might expect lengthening to be variable.

In fact, I will show below that the distribution of utterance-internal lengthening shows a complicated three-way distribution that indicates variability in both structure-sensitive phonology and prosodic structure formation.

I conducted a production study to determine the distribution of sentence-internal penultimate lengthening. The study comprised four syntactic contexts which varied in what material followed the verb: *IN SITU* DIRECT OBJECTS, **dislocated direct objects**, intransitive verbs followed by ADVERBS (balanced across temporal, manner, and locative adverbials), and SECONDARY PREDICATE clauses. Several other syntactic contexts were also included and acted as controls for this study. Within each syntactic condition, sentences were balanced for other prosodic factors such as the length and lexical tone on the verb. 12 native speakers of Tshivenda were recorded with 3 repetitions per sentence; I'm reporting here on a subset of the data including only 5 speakers and 1 repetition.

After hand-coding all the syllables as long or short, I tabulated the percentage of tokens displaying utterance-internal penultimate lengthening on the verb within each syntactic condition. The results are shown in Table 2.

Table 2: Percentage of tokens with internal penultimate lengthening

(SENTENCE-FINAL)	(100%)
DISLOCATED OBJECT	60%
ADVERB	25%
IN SITU OBJECT	15%
SECONDARY PREDICATE	5%

Strikingly, the distributions also show a three-way split: Utterance-internal lengthening is common when only a dislocated object follows the verb; when an in situ object or an adverb follows the verb, lengthening is less common; and when only a secondary predicate follows the verb, lengthening is vanishingly rare.<sup>8</sup> Notably, the syntactic conditions on this distribution are the same as for the conjoint/disjoint alternation: That is, verbs followed by dislocated objects pattern the same as sentence-final verbs; in situ objects and adverbs pattern together, and secondary predicates pattern a third way.<sup>9</sup> This overlap suggests a common

<sup>8</sup>All but one of the secondary predicate cases showing internal lengthening come from the same speaker, who shows many signs of list intonation in general.

<sup>9</sup>Such a correlation between prosody and disjoint marking has been noted before; see, for instance: van der Spuy (1993); Buell (2005); Cheng & Downing (2012) on Zulu; Devos (2008) on Makwe. I'm grateful to an anonymous reviewer for bringing these references to my attention.



origin for both phenomena; in the next section, I will outline a model of Tshivenda prosody that explains the commonalities.

## 5 Analysis

We have seen that both the conjoint/disjoint alternation and sentence-internal penultimate lengthening show a three-way split in their distributions, and that the syntactic conditions underlying this split pattern alike between the two phenomena. I will first develop a model that can account for the three-way split in penultimate lengthening. I will then discuss two possible ways that the correlation between the prosody and the disjoint prefix can be explained. In one, the disjoint prefix is directly conditioned by the prosodic structure; in the other, a “third factor” is introduced which accounts for the variability in both prosodic phrasing and disjoint marking.

### 5.1 Penultimate lengthening and prosodic variability

This distribution is challenging to explain under a model of prosody in which the structure-sensitive phonological marking is in one-to-one correspondence with the prosodic structure. There are two challenging aspects to this distribution: The first is that the internal marking is sometimes categorically *absent* (the secondary predicate case), but is never categorically *present*. The second is that some contexts seem to show an intermediate frequency of lengthening. This first property can be captured by proposing that intonational phrase is *variably* marked by penultimate lengthening, so that, even in contexts where the verb is always final in an intonational phrase, the lengthening will not always be present. This second property can be captured by specifying that these contexts are not actually uniform, but that differences in the interpretation of in situ objects and adverbs changes whether they are prosodically grouped with the verb or not. Information structure (e.g. focus or givenness) is the most likely factor at play; since the present study did not control information structure, these differences might appear as apparently random variation depending on what implicit context subjects assign to the sentence.

To spell out this proposal in more detail:

- I will assume an indirect reference theory of prosody (Selkirk 2011), in which prosody is split into two pieces: prosodic structure building and structure-sensitive phonology.

- In particular, I will assume that each utterance has an abstract prosodic structure which may or may not be marked in the phonology by e.g. penultimate lengthening. That is, it is the likelihood of marking, not the presence or absence, that indicates a boundary. (Elfner 2016)
- I will further assume that recursive prosodic structures are possible and that structure-sensitive phonology can make reference to maximal and non-maximal recursive phrases (Ito & Mester 2012).

I propose that penultimate lengthening is controlled by two rules:

- (10) Penultimate lengthening rules:
- a. Always lengthen the penultimate syllable of a maximal  $\iota$  P.
  - b. Variably lengthen the penultimate syllable of a non-maximal  $\iota$  P.

Consider the dislocated object case. I propose that these sentences have a prosodic structure like the following:<sup>10</sup>

- (11)  $(_{\iota\text{-Max}} (_{\iota}$  ndó lú mbíndímé(:)dza  $)_{\iota}$  ludambwa:na  $)_{\iota\text{-Max}}$   
1sg.PST 1l.OBJ destroy 1l.dam  
'I destroyed the dam.'

- The object *ludambwana* is final in a maximal  $\iota$  P and so is always lengthened.
- The verb *mbíndímédza* is final in a non-maximal  $\iota$  P and so is variably lengthened.

→ In my data: The verb is lengthened >50% of the time.

Consider next the secondary predicate case. I propose that these sentences have a prosodic structure like the following:

- (12)  $(_{\iota\text{-Max}}$  ndi gidima  $(_{\iota}$  ndi tshi ya háyá:ni  $)_{\iota}$   $)_{\iota\text{-Max}}$   
1sg run 1sg DEP go home.LOC  
'I run home.'

- The goal *hayani* is final in a maximal  $\iota$  P and so is always lengthened.

---

<sup>10</sup>Space does not permit me to include a full analysis of how the prosodic structures here are generated, but I assume a constraint-based analysis along the lines of "Match Theory" (Selkirk 2011).

- The main verb *gidima* isn't final in any  $\iota$  P, and so is never lengthened.

→ In my data: The verb is lengthened <5% of the time.

Finally, consider the other cases – adverbs and in situ objects. Here, I will propose that these sentences may be assigned on of two possible structures. While I will remain neutral on what conditions each of these structures, information structural factors such as focus or givenness seems likely; the experiment presented here did not control for these factors, and so I will treat the choice between the two structures as essentially variable.

- (13) a.  $(_{\iota\text{-Max}} (\iota \text{ndo} \quad \text{ṅamai(:)la})_{\iota} \text{ṅamu:si})_{\iota\text{-Max}}$   
 b.  $(_{\iota\text{-Max}} \text{ndó} \quad \text{ṅámáila} \quad \text{ṅamú:si})_{\iota\text{-Max}}$   
           1sg.PST stagger           today

‘I staggered today.’

- Under both prosodic structures, the adverb *ṅamusi* is final in a maximal  $\iota$  P and is lengthened.
- Under (13a) there is no non-maximal  $\iota$  P and so no variable lengthening.
- Under (13b) the verb is final in a non-maximal  $\iota$  P and is variably lengthened.
- One thus expects sentence-internal lengthening to occur less frequently than with dislocated objects, but more frequently than with secondary predicates.

→ In my data: The verb is lengthened ~20% of the time.

Thus, one can understand the three-way split in penultimate lengthening as arising from the combination of variation in prosodic structure (probably conditioned by information structural factors) with a variable structure-sensitive phonology rule.<sup>11</sup>

## 5.2 Explaining the conjoint/disjoint alternation

If the prosodic structures proposed above are correct, then the following relationship between intonational phrases, lengthening, and disjoint marking obtains:

<sup>11</sup>If this analysis is correct, we should see corresponding tonal effects; space constraints will not permit a discussion of Tshivenda tone-spreading phenomena here.

Table 3: Summary of prosody and verb form relationship

CONDITION	LAST IN $\iota$ P?	LENGTHENED?	FORM?
Dislocated obj	Always	Frequently	Disjoint
Adverb, in situ obj	Sometimes	Sometimes	Variable
Secondary predicate	Never	Rarely	Conjoint

It seems desirable to explain why disjoint marking should track the prosodic structure so closely. There are at least two possible analyses compatible with the data presented here. The first is what I will term the PROSODIC DISJOINT analysis, in which disjoint marking is taken to be a direct consequence of the prosodic structure. More specifically, Tshivenḡa disjoint marking would obey the following generalization:

- (14) Conjoint / disjoint generalization (Tshivenḡa):
- a. Disjoint (/a-): appears when the verb is last in an  $\iota$  P.<sup>12</sup>
  - b. Conjoint (/ø-): appears elsewhere.

The prosodic disjoint analysis represents a significant break from previous scholarship on Southern Bantu languages (see, for instance, Buell 2005; Cheng & Downing 2009), which have typically analyzed disjoint marking as resulting from a combination of syntactic- and information-structural factors. The STRUCTURAL DISJOINT analysis, then, would propose that the correlations reported in Table 3 are the result of a “third factor”: Insofar as syntax and information structure are capable of influencing both the prosody and the verb form, we should expect these factors to be correlated with each other. In this analysis, there is no direct link between disjoint marking and prosodic structure at all.

The present study is not capable of distinguishing between these options. In the next section, I will discuss some of the predictions of each of these analyses.

## 6 Conclusions

I have shown using experimental methods that the conjoint/disjoint in Tshivenḡa behaves differently from the reported generalizations given for the parallel alter-

<sup>12</sup>I remain agnostic as to how this distribution is achieved. The most likely option seems to be deletion of the /a-/ prefix in the elsewhere case, which is somehow bled by the prosody. The alternative, that the prefix is actually inserted by the prosody, seems highly unusual based on previously-studied prosodic phenomena.

nation in other Southern Bantu languages. In particular, while other Southern Bantu languages typically show the disjoint and conjoint forms in complementary distribution, in Tshivenda there is a class of syntactic contexts in which the disjoint prefix is apparently optional. Furthermore, I've shown that the three-way split one sees in the conjoint/disjoint alternation precisely mirrors a similar three-way split in the distribution of penultimate lengthening. I've proposed two possible analyses that can capture this parallel: One in which disjoint marking is directly determined by the prosody, and one in which it is indirectly linked to prosody by way of some other common factor which influences both.

Both analyses presented here make at least one strong language-internal predictions which I do not yet have the data to test. First, it predicts that conjoint-form verbs should never be lengthened, regardless of syntactic context. This prediction remains to be tested.

The prosodic disjoint analysis allows for a parsimonious description of the Tshivenda conjoint/disjoint facts: Instead of a three-way split based on the syntax, we can state the generalization in terms of a two-way split based on the prosody. This analysis seems particularly appropriate for Tshivenda, in comparison to the other Southern Bantu languages, in that the disjoint prefix is much more limited in distribution in Tshivenda than elsewhere: The alternation occurs only in the simple present (/ habitual) tense, and is only ever between /a-/ and /ø-/, rather than between two contentful morphemes. One might imagine, then, that the Tshivenda /a-/ prefix is really just the present tense morpheme, and that this morpheme undergoes a deletion process in some contexts. This would help us understand why no /a-/ prefix appears when any other overt tense morphology is present. More work will be required to determine if this specific analysis is the correct one.

The structural disjoint analysis, by contrast, requires that we understand dislocated objects, some *in situ* objects, and some adverbs to form a natural class, in opposition to secondary predicates. As noted above, the most likely factor at play here is information structure; furthermore, in order to explain the prosodic facts, we need this factor regardless of which analysis of the disjoint we pursue. If the determining factor is indeed related to information structure, then we predict that dislocated objects will pattern uniformly in this respect; this is perhaps unsurprising, given that dislocation itself is an information-structural process related to backgrounding the object (see Buell 2005, among others). We would then predict that *in situ* objects and adverbs pattern variably with respect to this factor – that is, Tshivenda apparently allows for such elements to be backgrounded without overt syntactic dislocation, or at least with a short-

distance string-vacuous movement. Finally, we predict that secondary predicates will all pattern uniformly differently from dislocated objects in this respect – presumably meaning that they can never be backgrounded or otherwise marked as “given”. This is perhaps the most surprising prediction of this analysis, and yet still seems well within the range of possibility.

Deciding between these two analyses, then, will require considerable further work. In particular, the studies presented here did not treat information structure as a factor in any way; it will be essential to control for this in future studies. Optimally, this would involve both a judgment task and a production task, each of which carefully controlled the discourse context for each test item. I leave such a study for future research.

## Abbreviations

DEP	dependent predicate marker	PST	past
DSJ	disjoint prefix	SG	singular
LOC	locative suffix	SUBJ	subject
OBJ	object		

## Acknowledgements

I’d like to thank Professor N. C. Netshisaulu at the University of Venda, along with his students Abednico Nyoni, Tshivhase N., and Maduwa Besley, and the entire UniVen Linguistics department, for all their gracious help with my Tshivenda research. Further thanks go to Ramafamba Lindelani, Ratshimbvumo Perseverance, Munzhedzi Fhatuwani, Mukwevho Robert, Mahandana Mashudu, Netshiavha Fulufhelo, Mudau Precious, and Ndiambani P.T. for their patience with reading silly sentences over and over again while wearing an uncomfortable microphone. Seunghun J. Lee introduced me to everyone at UniVen and made this project possible in the first place; Professor M. Crous Hlungwani was a great friend to me during my stay there.

This material is based upon work supported by the National Science Foundation Graduate Research Fellowship under Grant No. 1451512. Any opinion, findings, and conclusions or recommendations expressed in this material are those of the author and do not necessarily reflect the views of the National Science Foundation.

## References

- Buell, Leston. 2005. *Issues in Zulu verbal morphosyntax*. University of California Los Angeles. (Doctoral dissertation).
- Cassimjee, Farida. 1992. *An autosegmental analysis of Venda tonology*. New York, London: Garland.
- Cheng, Lisa & Laura J. Downing. 2009. Where's the topic in Zulu? *The Linguistic Review* 26(2–3). 207–238.
- Cheng, Lisa & Laura J. Downing. 2012. Against FocusP: Arguments from Zulu. In Ivona Kucerova & Ad Neeleman (eds.), *Information structure*, 247–266. Cambridge: Cambridge University Press.
- Creissels, Denis. 1996. Conjunctive and disjunctive verb forms in Setswana. *South African Journal of African Languages* 16(4). 109–115.
- Devos, Maud. 2008. *A grammar of Makwe: (Palma; Mozambique)* (LINCOM Studies in African Linguistics 71). Munich: Lincom Europa.
- Elfner, Emily. 2016. Subject/object complexity and prosodic boundary strength in Irish. In Jon Barnes, Alejna Brugos, Stefanie Shattuck-Hufnagel & Nanette Veilleux (eds.), *Proceedings of Speech Prosody 2016*, 178–182. Baixas: International Speech Communication Association.
- Halpert, Claire & Jochen Zeller. 2015. Right dislocation and raising-to-object in Zulu. *The Linguistic Review* 32(3). 475–513.
- Hyman, Larry M. 2013. Penultimate lengthening in Bantu: Analysis and spread. In Balthasar Bickel, Lenore Grenoble, David A. Peterson & Alan Timberlake (eds.), *Language typology and historical contingency: In honor of Johanna Nichols*, 309–330. Amsterdam: John Benjamins.
- Ito, Junko & Armin Mester. 2012. Recursive prosodic phrasing in Japanese. In Toni Borowsky, Shigeto Kawahara, Mariko Sugahara & Takahito Shinya (eds.), *Prosody matters. Essays in honor of Elisabeth Selkirk* (Advances in Optimality Theory Series), 280–303. Sheffield & Bristol: Equinox.
- Poulos, George. 1990. *A linguistic analysis of Venda*. Cape Town: Via Afrika Limited.
- Selkirk, Elisabeth. 2011. The syntax-phonology interface. In John Goldsmith, Jason Riggle & Alan Yu (eds.), *The Handbook of Phonological Theory*, 485–532. Oxford: Blackwell Publishing.
- van der Spuy, Andrew. 1993. Dislocated noun phrases in Nguni. *Lingua* 90. 335–355.
- Van Warmelo, Nicolaas Jacobus. 1989. *Venda dictionary: Tshivenda-English*. Pretoria, ZA: J. L. van Schaik.





## Chapter 13

# Obstacles for gradual place assimilation

Andrew Lamont

University of Massachusetts Amherst

In Harmonic Serialism, place assimilation can be modeled as taking one derivational step or two. These options correspond to whether a basic place assimilation operation is available to GEN or not. This paper compares these two possibilities against attested place assimilation patterns, focusing on progressive place assimilation. While the one-step analysis is successful, the two-step analysis is shown not to handle certain assimilation patterns.

## 1 Introduction

Harmonic Serialism (HS) is a serial version of Optimality Theory (OT) (Prince & Smolensky 2004; McCarthy 2000).<sup>1</sup> HS shares the basic framework of OT: a function GEN takes an input and produces a set of candidates. The set of candidates is fed into a function EVAL, which returns the optimal candidate with respect to the ranked set of constraints, CON.

The main difference between HS and Parallel OT is the function GEN. In Parallel OT, GEN is unrestricted, producing an infinite set of candidates that can differ from the input in unlimited ways. In HS, GEN is restricted to producing a set of candidates that differ only minimally from the input. Given a finite set of operations, the candidate set includes the fully faithful candidate and every candidate that can be derived from the input via the application of a single operation. This property of GEN is called *gradualness*.

Gradualness means that derivations involving the application of more than one operation take multiple steps in HS. This is modeled by looping between GEN and EVAL. An initial input  $in_0$  is fed into GEN, and EVAL selects the optimal

---

<sup>1</sup>See McCarthy (2016) for a recent overview.



candidate  $out_0$ . If candidate  $out_0$  differs from its input  $in_0$ , it serves as the input to the next step,  $in_1 = out_0$ , and the process repeats. The derivation converges once the optimal candidate does not differ from the most recent input:  $out_n = in_n$ . That final optimal candidate is the output.

The effects of gradualness are clearly seen in iterative processes like feature spreading (McCarthy 2009). For example, in Copperbelt Bemba (Bantu), if a word does not end in a high toned mora, the rightmost high tone will spread to the end of the word (Kula & Bickmore 2015), e.g. /bá-ka-fík-a/ > [bá-ká-fík-á] ‘they will arrive’. In Parallel OT, the output [bá-ká-fík-á] is a member of the candidate set produced from the input /bá-ka-fík-a/ by GEN. In HS, GEN is limited to spreading the high tone once, and this derivation takes three steps: /bá-ka-fík-a/ > bá-ká-fík-a > bá-ká-fík-a > [bá-ká-fík-á].

This example also speaks to the trade-off between GEN and CON in HS. Both the Parallel OT and HS analyses require a motivating markedness constraint against final toneless moras (Kula & Bickmore 2015). A simple constraint against final toneless moras is sufficient for a Parallel OT analysis; candidates like [bá-ká-fík-a] are not optimal because they contain final toneless moras. In an HS analysis, forms like [bá-ká-fík-a] are optimal candidates at intermediate steps and this markedness constraint cannot motivate gradual spreading. Instead, an alignment constraint is necessary (McCarthy & Prince 1993a), assigning violations in proportion to the number of intervening moras between the rightmost high tone and the end of the word. The optimal candidate at each step of the derivation improves on this constraint by spreading the high tone further until the derivation converges.

Derivational steps in HS exhibit *harmonic improvement*, and can be modeled in a harmonic improvement tableau (Tableau 1). Tableau 1 shows that the output at each step of the derivation better satisfies the constraint ranking than the input at that step. Successive optima improve gradually on the gradient alignment constraint, ALIGN-R(WORD, H), which penalizes the distance between the right edge of the word and the rightmost high tone. Violations of the faithfulness con-

Tableau 1: Harmonic improvement in Copperbelt Bemba

/bá-ka-fík-a/	ALIGN-R(WORD, H)	NO SPREAD
a. bá-ka-fík-a	3	
b. bá-ká-fík-a	2	1
c. bá-ká-fík-a	1	1
d. [bá-ká-fík-á]		1

straint against spreading a high tone, *NOSPREAD*, are determined relative to the input of the current step, not the input to the entire derivation. Hence, each successive output only violates *NOSPREAD* once. Every step of the derivation must show harmonic improvement.

In Parallel OT, the constraint set *CON* defines the predicted typology. In HS, the predicted typology results from the interaction between *CON* and *GEN*. Imposing limits on *GEN* restricts the typological predictions. Determining the operations available to *GEN* is an important research question in HS (see the papers in McCarthy & Pater (2016) for perspectives on a broad range of topics).

This paper compares two approaches to place assimilation in HS, focusing on progressive place assimilation: a two-step derivation with delinking and then spreading (McCarthy 2007; 2008), and a one-step derivation where place features are directly changed, ultimately arguing that the one-step derivation better fits the attested typology. These two approaches to place assimilation are laid out in §2. §3 tests the predictions of these approaches against cases of progressive place assimilation cross-linguistically. §4 concludes.

## 2 Place assimilation in Harmonic Serialism

Place assimilation is a common process cross-linguistically wherein a consonant takes on the place features of an adjacent consonant. Assimilation is overwhelmingly regressive, i.e. in a cluster  $C_1C_2$ ,  $C_1$  is much more likely to assimilate to  $C_2$  than  $C_2$  is to assimilate to  $C_1$  (Webb 1982; Jun 1995). A robust example of regressive assimilation is found in Diola-Fogny (Niger-Congo) (Sapir 1965). Table 1 gives examples of the four phonemic nasals in the language taking on the place features of a following consonant in coda-onset clusters, e.g. /ni-gam-gam/ > [ni.gaŋ.gam] ‘I judge’ (1a).<sup>2</sup>

Table 1: Regressive place assimilation in Diola Fogny

	Underlying	Surface	Gloss
a.	/ni-gam-gam/	[ni.gaŋ.gam]	‘I judge’
b.	/paŋ-ji-maŋʃ/	[paŋ.ji.maŋʃ]	‘you (plural) will know’
c.	/ku-bɔŋ-bɔŋ/	[ku.bɔm.bɔŋ]	‘they sent’
d.	/na-ti:ŋ-ti:ŋ/	[na.ti:n.ti:ŋ]	‘he cut (it) through’

<sup>2</sup>Tones are omitted from data throughout this paper.

Progressive place assimilation, i.e. where  $C_2$  assimilates to  $C_1$  in a  $C_1C_2$  cluster, is often restricted to certain environments such as root-enclitic junctures (Lamont 2015). An example is found in Masa (Chadic) (Antonino 1999; Shryock 1997). Table 2 gives examples of the masculine enclitic /-na/ and the feminine enclitic /-da/. Attached to roots ending with vowels, the enclitics surface faithfully with coronal place, e.g. /tuu-na/ > [tuu.na] ‘body-MASC’ (2a). Attached to roots ending with obstruents or nasals, the enclitics surface with the place features of the root-final consonant, e.g. /vok-na/ > [vok.ŋa] ‘front-MASC’ (2g).

Table 2: Progressive place assimilation in Masa

	Underlying	Surface	Gloss
a.	/tuu-na/	[tuu.na]	‘body-MASC’
b.	/gam-na/	[gam.ma]	‘fish species-MASC’
c.	/vun-na/	[vun.na]	‘mouth-MASC’
d.	/zeŋ-na/	[zeŋ.ŋa]	‘warthog-MASC’
e.	/cop-na/	[cop.ma]	‘gremer lid-MASC’
f.	/vet-na/	[vet.na]	‘hare-MASC’
g.	/vok-na/	[vok.ŋa]	‘front-MASC’
h.	/naga-da/	[naga.da]	‘earth-FEM’
i.	/lum-da/	[lum.ba]	‘canoe-FEM’
j.	/binen-da/	[bi.nen.da]	‘fish species-FEM’
k.	/haran-da/	[ha.ran.ga]	‘light-FEM’
l.	/rip-da/	[rip.pa]	‘termite species-FEM’
m.	/fat-da/	[fat.ta]	‘sun-FEM’
n.	/benek-da/	[be.nek.ka]	‘herb species-FEM’

## 2.1 Place assimilation as a two-step process

McCarthy (2007; 2008) proposes an HS analysis of place assimilation in which the targeted consonant first loses its place features and then place from an adjacent consonant spreads onto the target. Because only one operation can apply at a time in HS, this gives two derivational steps: debuccalization and spreading. This two-step process is referred to as *gradual place assimilation* in this paper exactly because it takes multiple steps in the derivation.

In regressive assimilation, debuccalization, the first step, satisfies the Coda Condition (CODACOND), which is violated by place features that are not associ-

Tableau 2: Regressive place assimilation: Step 1

/ni-gam-gam/	CODACOND	MAX(PL)
a. ni.gam.gam	W	L
b. ni.gam.Ham	W	1
☞ c. ni.gaN.gam		1

Tableau 3: Regressive place assimilation: Step 2

ni.gaN.gam	HAVEPLACE	NOLINK(PL)
a. ni.gaN.gam	W	L
☞ b. ni.gaŋ.gam		1

ated with an onset. This constraint motivates deleting the place features from the coda consonant, which violates MAX(PLACE). Tableau 2 shows the first step of /ni-gam-gam/ > [ni.gaŋ.gam] ‘I judge’ (1a). Candidates (2a) and (2b) violate CODACOND because the labial place associated with the medial nasal is not associated with an onset; the final-consonant is taken to be exceptional. A place node deletes in (2b) and (2c), as indicated with the capital letters *H* and *N*, for debuccalized oral and nasal consonants, respectively. (2c) is optimal because it does not violate CODACOND. This tableau demonstrates that only the coda can be targeted for debuccalization; deleting the place features from the onset does not improve on CODACOND.

The second step satisfies a markedness constraint against placeless segments, HAVEPLACE. This constraint motivates spreading the place features from an adjacent consonant onto the placeless segment, which violates NOLINK(PLACE). Tableau 3 shows this step, continuing the derivation from Tableau 2; the input to this step is the output of the previous step [ni.gaN.gam]. Candidate (3a), the output of Tableau 2, contains a placeless nasal and violates HAVEPLACE. Candidate (3b) is optimal because it does not contain any placeless segments. This candidate will be the input to a third step, where the derivation converges (not shown here).

The output of each step of the derivation is shown in the harmonic improvement Tableau 4 along with the full constraint ranking. As this tableau makes clear, each subsequent optimum increases in harmony until the convergent optimum is reached (4c). This candidate does not violate either markedness constraint and therefore does not motivate further derivational steps. As the square brackets indicate, it is the ultimate output.

Progressive place assimilation, like that in Masa, cannot be motivated by CODACOND, as this constraint is only satisfied by debuccalizing a coda consonant.

Tableau 4: Harmonic improvement in Diola Fogy

/ni-gam-gam/	CODACOND	HAVEPLACE	MAX(PL)	NO LINK(PL)
a. ni.gam.gam	1			
b. ni.gaN.gam		1	1	
c. [ni.gaŋ.gam]				1

Instead, McCarthy (2008: 297) analyzes the first step as satisfying a constraint against place features belonging to affixes, \*PLACE<sub>AFFIX</sub>. The derivation is otherwise identical to Diola Fogy's: the targeted consonant debuccalizes before place features spread from an adjacent consonant.

Tableaux 5 and 6 show the derivation of /vok-na/ > [vok.ŋa] 'front-MASC' (2g). In Tableau 5, the faithful candidate (5a) and a candidate in which the root-final coda has debuccalized (5b) both violate \*PLACE<sub>AFFIX</sub>, and lose to the optimal candidate (5c), in which the affix nasal has lost its place features. This candidate serves as the input to Tableau 6, where it loses to candidate (6b), in which the place features of the adjacent dorsal stop spread onto the nasal.

Tableau 5: Progressive place assimilation: Step 1

/vok-na/	*PLACE <sub>AFFIX</sub>	MAX(PL)
a. vok.na	W	L
b. voH.na	W	1
☞ c. vok.Na		1

Tableau 6: Progressive place assimilation: Step 2

vok.Na	HAVEPLACE	NO LINK(PL)
a. vok.Na	W	L
☞ b. vok.ŋa		1

A harmonic improvement tableau for progressive place assimilation in Masa is given in (Tableau 7). This exactly parallels the derivation in Diola Fogy (Tableau 4), except for the highest-ranked markedness constraint: CODACOND motivates regressive place assimilation and \*PLACE<sub>AFFIX</sub> motivates progressive place assimilation.

This ranking motivates a similar derivation with vowel-final roots like /tuu-na/ > [tuu.na] 'body-MASC' (2a). The markedness constraint \*PLACE<sub>AFFIX</sub> is violated

Tableau 7: Harmonic improvement in Masa

/vok-na/	*PLACE <sub>AFFIX</sub>	HAVEPLACE	MAX(PL)	NO LINK(PL)
a. vok.na	1			
b. vok.Na		1	1	
c. [vok.ŋa]				1

by the enclitic nasal regardless of the shape of the root. Debuccalization therefore occurs with vowel-final roots just as it does with nasal- and obstruent-final roots.

The enclitics surface with coronal place regardless of the adjacent vowel's quality, e.g. compare [tuu.na] 'body-MASC' with [ma.dii.na] 'dew-MASC' and [ci.ta.na] 'job-MASC'. The violation of HAVEPLACE introduced in the first step of the derivation is therefore not repaired by spreading place features from the adjacent root vowel. Instead, coronal place features are inserted as a default (Lombardi 2002; de Lacy 2006), which violates DEP(PLACE).

The derivation of /tuu-na/ > [tuu.na] 'body-MASC' (2a) is shown in Tableaux 8 and 9. In the first step, the affix nasal debuccalizes to satisfy \*PLACE<sub>AFFIX</sub>. In the second step, default place features are inserted to satisfy HAVEPLACE. Because spreading place is preferred to inserting place with nasal- and obstruent-final roots, DEP(PLACE) dominates NO LINK(PLACE).

Tableau 8: Default place epenthesis: Step 1

/tuu-na/	*PLACE <sub>AFFIX</sub>	MAX(PL)
a. tuu.na	W	L
☞ b. tuu.Na		1

Tableau 9: Default place epenthesis: Step 2

tuu.Na	HAVEPLACE	DEP(PL)
a. tuu.Na	W	L
☞ b. tuu.na		1

This analysis treats the enclitics as underlyingly having coronal place features: /-na/ and /-da/. The facts of the language are also consistent with their being underspecified for place: the masculine enclitic underlyingly being /-Na/ and the feminine enclitic being /-Ha/, their place and voice features predictable from context. As McCarthy (2008: 286) argues, underlyingly placeless consonants do not

Tableau 10: Progressive place assimilation as underspecification

/vok-Na/	CODACOND	MAX(PL)	NO LINK(PL)
a. vok.Na	W		L
b. voH.Na		W	L
☞ c. vok.ŋa			1

have to pass through a debuccalization step, as CODACOND can motivate place assimilation directly.

Such a derivation is shown for [vok.ŋa] ‘front-MASC’ (2g) in Tableau 10, with the underlying form of the affix containing a nasal underspecified for place. Because CODACOND is satisfied by place features linked to an onset, directly spreading place onto the nasal in (10c) is optimal. Debuccalizing the root-final stop (10b) is dispreferred by the relative ranking of MAX(PLACE) and NO LINK(PLACE). Assuming underspecification, with vowel-final roots, default place features are inserted without the enclitics first passing through a debuccalization step.

Gradual place assimilation predicts that targets of progressive place assimilation surface with default place features in contexts that do not license place spreading. The two analyses given for the Masa enclitics here explain their surfacing with coronal place intervocally as a result of their derivation, not their underlying form. Underlying place features first pass through a debuccalization step. Because derivations in HS cannot look ahead to later steps, this process applies whenever an enclitic attaches to a root. This debuccalized segment then surfaces with default place features that are inserted to satisfy HAVEPLACE. Likewise, in the underspecification analysis, the enclitics enter the derivation placeless and surface with default place features intervocally to satisfy HAVEPLACE. The co-occurrence of progressive place assimilation and the realization of default place features is predicted by gradual place assimilation. In general, gradual place assimilation is always compatible with an underspecification analysis.

## 2.2 Place assimilation as a one-step process

The two-step process outlined above can be compared to a one-step process, which grants GEN a place-changing operation. The trade-off between GEN and CON mirrors the distinction between positional markedness and positional faithfulness in Parallel OT (Zoll 2004). The two-step process uses positional markedness constraints, CODACOND and \*PLACE<sub>AFFIX</sub>, and a general faithfulness con-



straint, MAX(PLACE) in the first step of the derivation. The one-step process uses a general markedness constraint and positional faithfulness constraints.

In the one-step process, both regressive place assimilation and progressive place assimilation are motivated by a markedness constraint against heterorganic clusters, AGREE(PLACE) (Yip 1991; Lombardi 1999; Baković 2000; 2007). This constraint is satisfied by changing the place features of one of the consonants, violating IDENT(PLACE). Which consonant is targeted follows from the relative ranking of positional faithfulness constraints. For the purposes of this paper, the two relevant constraints are IDENT(PLACE)<sub>ONSET</sub> (Beckman 1998), which is violated by changing the place features of a consonant in onset position, and IDENT(PLACE)<sub>ROOT</sub> (McCarthy & Prince 1995), which is violated by changing the place features of a consonant in the morphological root.<sup>3</sup>

In coda-onset clusters, IDENT(PLACE)<sub>ONSET</sub> prefers regressive place assimilation. Tableau 11 shows the one-step derivation of /ni-gam-gam/ > [ni.gam.gam] ‘I judge’ (1a). The faithful candidate (11a) contains a heterorganic cluster and violates the constraint AGREE(PLACE). It is dispreferred to the unfaithful candidates in which the place assimilation operation has applied (11b–c). An onset is targeted in (11b), which is dispreferred to (11c), in which a coda is targeted. Under this analysis, the word-final consonant does not enjoy any special status; it is not a member of a cluster, and does not violate the markedness constraint.

Tableau 11: Regressive place assimilation as one step

/ni-gam-gam/	AGREE(PL)	IDENT(PL)	IDENT(PL) <sub>ONSET</sub>
a. ni.gam.gam	W	L	
b. ni.gam.bam		1	W
13 c. ni.gam.gam		1	

The conflict between the two positional faithfulness constraints is seen at root-enclitic junctures; without a morpheme boundary or another relevant asymmetry (Lamont 2015), IDENT(PLACE)<sub>ONSET</sub> guarantees that regressive assimilation is the default repair. In Masa, the enclitic consonant in onset position is targeted for assimilation, so IDENT(PLACE)<sub>ROOT</sub> dominates IDENT(PLACE)<sub>ONSET</sub>. This is shown

<sup>3</sup>Positional faithfulness constraints have been shown to produce pathological effects unless the relevant position is defined over the input (Jesney 2011). This paper assumes that syllabification co-occurs with other operations at each step, following McCarthy (2008), which makes IDENT(PLACE)<sub>ONSET</sub> meaningless in the first step as the input is not syllabified. This problem can be avoided by assuming syllabification applies at an earlier derivational step (Elfner 2009). IDENT(PLACE)<sub>ROOT</sub> does not have this problem because Consistency of Exponence ensures that morphological affiliation is invariant throughout the derivation (McCarthy & Prince 1993b).

Tableau 12: Progressive place assimilation as one step

/vok-na/	AGREE(PL)	IDENT(PL)	IDENT(PL) <sub>ROOT</sub>	IDENT(PL) <sub>ONSET</sub>
a. vok.na	W	L		L
b. vot.na		1	W	L
☞ c. vok.ŋa		1		1

in Tableau 12 with /vok-na/ > [vok.ŋa] ‘front-MASC’ (2g). If the relative ranking of the positional faithfulness constraints were switched, regressive place assimilation would be preferred, and (12b) would be the optimal candidate.

Because AGREE(PLACE) is only violated by consonant clusters, it does not motivate any operations in intervocalic contexts. Assuming underlying coronal place, the derivation of /tuu-na/ > [tuu.na] ‘body-MASC’ (2a) converges in one step because there is no reason to change the enclitic nasal. Under the one-step derivation, underlying place features surface in intervocalic contexts. If the enclitic nasal is underlyingly underspecified for place, it will pass through a derivational step in which default place is inserted just as in the two-step process.

The intervocalic context is where the two analyses make different predictions. Under the two-step process, affix consonants debuccalize and then surface with default place features. Under the one-step process, affix consonants surface faithfully. The following section presents a modest survey of progressive place assimilation and argues that predictions of the one-step process are borne out.

### 3 Progressive place assimilation cross-linguistically

Progressive place assimilation often only targets a single suffix in a language, motivating an analysis that relies on morpheme-specific constraints (Pater 2009). When that suffix surfaces with default place features, it is consistent with an underspecification account and therefore consistent with a two- or one-step derivation. For example, the progressive suffix in Noni (Niger-Congo) is analyzed underlyingly as /-te/ (Hyman 1981). Attached to roots with final vowels, it surfaces with a lateral. Roots with final labial nasals take [-te], roots with final coronal nasals take [-e], and roots with final dorsal nasals take [-ke]. Examples are shown in Table 3. Like the gender enclitics in Masa, the Noni progressive is amenable to having an initial stop underspecified for place: /-He/.

Languages where the targeted suffix surfaces with marked place features cannot be analyzed this way. For example, the qualitative suffix in Kukú (Nilotic)

Table 3: Progressive place assimilation in Noni

	Underlying	Surface	Gloss
a.	/cii-te/	[cii.le]	‘drag-PROG’
b.	/cim-te/	[cim.te]	‘dig-PROG’
c.	/bin-te/	[bi.ne]	‘dance-PROG’
d.	/ciŋ-te/	[ciŋ.ke]	‘tremble-PROG’

assimilates to root-final nasals and obstruents and surfaces as a palatal stop intervocally (Cohen 2000). Examples are given in Table 4. Similar allomorphy is found in the related languages Bari (Yokwe 1987) and Mundari (Stritz 2014). In Kukú, palatal place features are neutralized in coda position: compare [gɲa] ‘be snapped’ and [gɪn] ‘snap’. This indicates that palatals are more marked than plain coronals. From the perspective of default place insertion, the word [ʃu.ʃɪ] ‘sharpen-QUAL’ (4a) is surprising; an unmarked stop is expected, e.g. \*ʃu.dɪ.

Table 4: Progressive place assimilation in Kukú

	Underlying	Surface	Gloss
a.	/ʃu-ʃa/	[ʃu.ʃɪ]	‘sharpen-QUAL’
b.	/ʔjɛm-ʃa/	[ʔjɛm.ba]	‘cast the evil eye-QUAL’
c.	/ŋaŋ-ʃa/	[ŋan.da]	‘dismantle-QUAL’
d.	/dɛŋ-ʃa/	[dɛŋ.ga]	‘perform surgery-QUAL’
e.	/dɪp-ʃa/	[dɪb.bi]	‘sound-QUAL’
f.	/ʔjɔt-ʃa/	[ʔjɔd.dɔ]	‘plant-QUAL’
g.	/dʊk-ʃa/	[dʊg.gɪ]	‘build-QUAL’

Another suffix incompatible with underspecification is the Afrikaans (Germanic) diminutive /-ʲki/ (Lamont 2017). Examples are given in Table 5. The diminutive surfaces with dorsal place intervocally (5a), which is unattested as a default (de Lacy 2006). Furthermore, the diminutive triggers bidirectional place assimilation: it surfaces with labial place after labial-final roots, e.g. /rɑ:m-ʲki/ > [rɑ:m.pi] ‘frame-DIM’ (5b), but triggers root-final coronals to undergo regressive assimilation, e.g. /mɑ:n-ʲki/ > [mɑ:ŋ.ki] ‘moon-DIM’ (5c). Without positing

underlying dorsal place features, the regressive assimilation seen with coronal-final stems is inexplicable.<sup>4</sup>

Table 5: Bidirectional place assimilation in Afrikaans

	Underlying	Surface	Gloss
a.	/pɑ:-ʝki/	[pɑ:.ki]	‘father-DIM’
b.	/rɑ:m-ʝki/	[rɑ:m.pi]	‘frame-DIM’
c.	/mɑ:n-ʝki/	[mɑ:ɲ.ki]	‘moon-DIM’
d.	/kuənəŋ-ʝki/	[kuənəŋ.ki]	‘king-DIM’

Not all languages target a single affix for progressive place assimilation. Some, such as Masa, have multiple affixes that undergo progressive place assimilation. A richer inventory of targeted affixes can be found in the closely related language Musey (Chadic) (Shryock 1996). Musey has cognates of the Masa gender enclitics /-na/ and /-da/ as well as a host of other enclitics that undergo progressive place assimilation. Table 6 gives examples with the negative enclitic /-di/ and the intensifier enclitic /-kijo/. Dassidi (2015) also reports similar allomorphy with the infinitive marker /-da/ and the causative marker /-gi/.

Table 6: Progressive place assimilation in Musey

	Underlying	Surface	Gloss
a.	/ka-di/	[ka.di]	‘exist-NEG’
b.	/kulum-di/	[ku.lum.bi]	‘horse-NEG’
c.	/sun-di/	[sun.da]	‘work-NEG’
d.	/ʔeŋ-di/	[ʔeŋ.gi]	‘strength-NEG’
e.	/too-kijo/	[too.gɪ.jo]	‘sweep-INTENSE’
f.	/hum-kijo/	[hum.bi.jo]	‘hear-INTENSE’
g.	/fen-kijo/	[fen.dɪ.jo]	‘blow one’s nose-INTENSE’
h.	/galaŋ-kijo/	[ga.laŋ.gɪ.jo]	‘shake-INTENSE’

<sup>4</sup>An anonymous reviewer points out that an interesting comparison can be made between HS and Stratal OT (Kiparsky 2000). The work of root-faithfulness in HS parallels spelling out root features before affixation or cliticization. The analysis of Afrikaans in Lamont (2017) requires violable root-faithfulness, which seems difficult to reconcile with cyclic spell out.

As in Kukú and Afrikaans, the dorsal-initial morphemes /-kijo/ and /-gi/ make an underspecification analysis implausible, as dorsal place would have to be inserted as a default. Furthermore, since Musey also has coronal-initial morphemes that undergo progressive place assimilation, default place insertion would have to be lexically-specified so that some morphemes receive coronal place by default and others dorsal place by default.

Under the one-step process, these data are not problematic. Each affix/enclitic enters the derivation with underlying place features that surface faithfully unless an obstruent- or nasal-final root triggers assimilation; Jun (1995) gives an analysis in Parallel OT along these lines. Tableaux 13 and 14 give the derivations for /ka-dĩ/ > [ka.dĩ] ‘exist-NEG’ (6a) and /kulum-dĩ/ > [ku.lum.bi] ‘horse-NEG’ (6b) as one-step derivations. As Tableau 13 shows, with vowel-final roots, the enclitic surfaces faithfully and the derivation converges. As Tableau 14 shows, with obstruent- and nasal-final roots, the enclitic surfaces homorganic to the root-final consonant. The optimal candidate of Tableau 14 will be the input to a second step, where the derivation converges (not shown here).

Tableau 13: Faithful realization intervocalically

/ka-dĩ/	AGREE(PL)	IDENT(PL)	IDENT(PL) <sub>ROOT</sub>	IDENT(PL) <sub>ONSET</sub>
☞ a. ka.dĩ				
b. ka.bi		W		W

Tableau 14: Progressive place assimilation as one step

/kulum-dĩ/	AGREE(PL)	IDENT(PL)	IDENT(PL) <sub>ROOT</sub>	IDENT(PL) <sub>ONSET</sub>
a. ku.lum.dĩ	W	L		L
b. ku.lun.dĩ		1	W	L
☞ c. ku.lum.bi		1		1

The intervocalic context poses a challenge to the two-step process. Following the derivation given for Masa above, we expect the intensifier enclitic in Musey to surface with default place when the context for spreading is unavailable. This is shown in Tableaux 15 and 16 with /too-kijo/ > [too.gi.jo] ‘sweep-INTENSE’ (6e). Even if dorsal place were somehow the default in Musey, it would not explain why other enclitics surface with coronal place after this step.

McCarthy (2008: 298) suggests that the general phonotactics of the language can account for this. Musey only allows the placeless consonants [h] and [ɦ]

Tableau 15: Problematic default place epenthesis: Step 1

/too-kɪjo/	*PLACE <sub>AFFIX</sub>	MAX(Pl)
a. too.kɪ.jo	W	L
☞ b. too.Hɪ.jo		1

Tableau 16: Problematic default place epenthesis: Step 2

too.Hɪ.jo	HAVEPLACE	DEP(Pl)
a. too.Hɪ.jo	W	L
☞ b. too.tɪ.jo		1

word-initially (Shryock 1996), suggesting a markedness constraint against word-internal placeless consonants, such as ALIGN-L(h, WORD).<sup>5</sup> This constraint is violated when the segments [h] and [ɦ] do not occur word-initially. It is also violated by debuccalized segments, because, by definition, these are placeless.

Introducing this constraint into the two-step analysis results in a ranking paradox. This is shown in Tableau 17 with the first steps of /too-kɪjo/ > [too.gɪ.jo] ‘sweep-INTENSE’ (6e) and /hum-kɪjo/ > [hum.bɪ.jo] ‘hear-INTENSE’ (6f). The left hand column gives the desired winner and a competing candidate in the first step separated by a tilde. In the intervocalic context (17a), debuccalization should not occur. In the consonant cluster context (17b), debuccalization should occur to feed place spreading. The markedness constraints \*PLACE<sub>AFFIX</sub> and ALIGN-L(h, WORD) are given with their evaluations of the winner ~ loser pairs.

Tableau 17: Ranking paradox in Musey

	*PLACE <sub>AFFIX</sub>	ALIGN-L(h, WORD)
a. too.kɪ.jo ~ too.Hɪ.jo	L	W
b. hum.Hɪ.jo ~ hum.kɪ.jo	W	L

There is a stark ranking paradox in Tableau 17. Including ALIGN-L(h, WORD) in the constraint set does not have the desired effect of blocking debuccalization only in intervocalic contexts. If it is ranked above \*PLACE<sub>AFFIX</sub>, it blocks debuccalization in all contexts, preventing any place assimilation from occurring. Whereas the one-step process adequately models the Musey allomorphy, the two-step process cannot. This result holds for Kúkú, Afrikaans, and any lan-

<sup>5</sup>A lowercase *h* is used to represent placeless consonants instead of an uppercase *H* to avoid confusion with the high tone alignment constraint used in §1.

guage that targets a consonant with marked place features for progressive place assimilation.

## 4 Conclusion

Research in Harmonic Serialism (HS) is concerned not just with the content of CON, but also with what operations are available to GEN. This paper examined the predictions made by removing place assimilation as a basic operation in HS and replacing its functionality with a delinking and then spreading derivation, as proposed by McCarthy (2007; 2008). This restricted GEN was argued not to be able to model attested progressive place assimilation systems found in Kukú, Afrikaans, and Musey. It was shown that allowing GEN a basic place assimilation operation results in a better fit of the attested data.

As noted earlier, place assimilation is overwhelmingly regressive. Up until very recently, all cases of progressive place assimilation known in the theoretical literature targeted consonants with unmarked place features except for the Musey intensifier enclitic /-kɪjo/. McCarthy (2007) even calls Musey a “unique challenge” to the two-step derivation, emphasizing that no other affix was known that shared these properties.

Relying on the Coda Condition to motivate place assimilation predicts progressive place assimilation like that in Musey is phonologically impossible, fulfilling the typological observation. In light of a survey of Musey-like languages (Lamont 2015), this strong typological prediction has to be weakened. There are more languages like Musey cross-linguistically that are well-behaved phonologically, which any phonological theory needs to be able to account for.

The one-step process that relies on AGREE(PLACE) is able to adequately model the attested place assimilation typology. However, it predicts that Musey-like languages should be much more common than they are. Whenever a conflicting faithfulness constraint dominates IDENT(PLACE)<sub>ONSET</sub>, progressive or bidirectional assimilation is predicted. Given the very limited distribution of these systems, the factorial typology vastly overpredicts their occurrence. This strongly suggests an external influence on the typology such as articulatory or perceptual pressures (Jun 1995; Steriade 2001), but such a discussion is beyond the scope of this paper.

## Acknowledgments

I am grateful to Kelly Berkson, Gosia Cavar, Stuart Davis, Gaja Jarosz, Samson Lotven, John McCarthy, Joe Pater, Katie Tetzloff, audiences at ACAL 47 and the 2016 IULC Spring Conference, and two anonymous reviewers for their helpful feedback and discussion. For sharing data with me, I am indebted to Pius Akumbu, Andries Coetzee, and Aaron Shryock. All remaining errors are mine.

## Abbreviations

DIM	diminutive	NEG	negative
FEM	feminine	PROG	progressive
INTENSE	intensifier	QUAL	qualitative
MASC	masculine		

## References

- Antonino, Melis. 1999. *Description du Masa (Tschad): Phonologie, syntaxe et dictionnaire encyclopedique*. Université François Rabelais Tours. (Doctoral dissertation).
- Baković, Eric. 2007. Local assimilation and constraint interaction. In Paul de Lacy (ed.), *The Cambridge handbook of phonology*, 333–352. Cambridge: Cambridge University Press.
- Baković, Eric. 2000. *Harmony, dominance and control*. Rutgers, The State University of New Jersey. (Doctoral dissertation).
- Beckman, Jill. 1998. *Positional faithfulness*. University of Massachusetts. (Doctoral dissertation).
- Cohen, Kevin. 2000. *Aspects of the grammar of Kukú*. München: Lincom Europa.
- Dassidi, Ezéchiél. 2015. *The morpho-phonological structure of Musej verb: A Chadic language of Chad*. University of Yaoundé 1. (MA thesis).
- de Lacy, Paul. 2006. *Markedness*. Cambridge: Cambridge University Press.
- Elfner, Emily. 2009. Syllabification and stress-epenthesis interactions in Harmonic Serialism. University of Massachusetts, Amherst manuscript.
- Hyman, Larry M. 1981. *Noni grammatical structure with special reference to verb morphology* (Southern California Occasional Papers in Linguistics 9). Los Angeles, CA: University of Southern California.



- Jesney, Karen. 2011. Positional faithfulness, non-locality, and the Harmonic Serialism solution. In Suzi Lima, Kevin Mullin & Brian Smith (eds.), *Proceedings of the 39th Meeting of the North East Linguistics Society*, 403–416.
- Jun, Jongho. 1995. *Perceptual and articulatory factors in place assimilation: An Optimality Theoretic approach*. University of California, Los Angeles. (Doctoral dissertation).
- Kiparsky, Paul. 2000. Opacity and cyclicity. *The Linguistic Review* 17. 351–365.
- Kula, Nancy C. & Lee S. Bickmore. 2015. Phrasal phonology in Copperbelt Bemba. *Phonology* 32. 147–176.
- Lamont, Andrew. 2015. *Progressive place assimilation in Optimality Theory*. Eastern Michigan University. (MA thesis).
- Lamont, Andrew. 2017. The small matter of the Afrikaans diminutive. In *Proceedings of the Linguistic Society of America*, vol. 2, 1–15.
- Lombardi, Linda. 1999. Positional faithfulness and voicing assimilation in Optimality Theory. *Language and Linguistic Theory* 17. 267–302.
- Lombardi, Linda. 2002. Coronal epenthesis and markedness. *Phonology* 19. 219–251.
- McCarthy, John J. 2000. Harmonic serialism and parallelism. In Masako Hirotsu, Andries Coetzee, Nancy Hall & Ji-yung Kim (eds.), *Proceedings of the North East Linguistics Society* 30, 501–524. Amherst, MA: GLSA.
- McCarthy, John J. 2007. Slouching towards optimality: Coda reduction in OT-CC. In Phonological Society of Japan (ed.), *Phonological studies* 10, 89–104. Tokyo: Kaitakusha.
- McCarthy, John J. 2008. The gradual path to cluster simplification. *Phonology* 25. 271–319.
- McCarthy, John J. 2009. Harmony in Harmonic Serialism. University of Massachusetts, Amherst manuscript.
- McCarthy, John J. 2016. The theory and practice of Harmonic Serialism. In John J. McCarthy & Joe Pater (eds.), *Harmonic Grammar and Harmonic Serialism*, 47–87. London: Equinox Publishing.
- McCarthy, John J. & Joe Pater. 2016. *Harmonic Grammar and Harmonic Serialism*. London: Equinox Publishing.
- McCarthy, John J. & Alan Prince. 1993a. Generalized alignment. In Geert Booij & Jaap van Marle (eds.), *Yearbook of Morphology*, 79–153. Dordrecht: Kluwer.
- McCarthy, John J. & Alan Prince. 1993b. Prosodic morphology I: Constraint interaction and satisfaction.
- McCarthy, John J. & Alan Prince. 1995. Faithfulness and reduplicative identity. In Jill Beckman, Suzanne Urbanczyk & Laura Walsh Dickey (eds.), *Papers in Op-*

- timality Theory* (University of Massachusetts occasional papers in linguistics 18), 249–384. Amherst, MA: GSLA.
- Pater, Joe. 2009. Morpheme-specific phonology: Constraint indexation and inconsistency resolution. In Steve Parker (ed.), *Phonological argumentation: Essays on evidence and motivation*, 123–154. London: Equinox.
- Prince, Alan & Paul Smolensky. 2004. *Optimality Theory: Constraint interaction in Generative Grammar*. Malden, MA: Blackwell Publishing.
- Sapir, J. David. 1965. *A grammar of Diola-Fogny*. Cambridge: Cambridge University Press.
- Shryock, Aaron. 1996. The representation of stricture: Evidence from Musey. In Chai-Shune Hsu (ed.), *UCLA Working Papers in Phonology 1*, 162–182. Los Angeles, CA: UCLA Linguistics Department.
- Shryock, Aaron. 1997. The classification of the Masa group of languages. *Studies in African Linguistics* 26. 29–62.
- Steriade, Donca. 2001. Directional asymmetries in place assimilation: A perceptual account. In Elizabeth Hume & Keith Johnson (eds.), *The role of speech perception in phonology*, 219–250. San Diego, CA: Academic Press.
- Stritz, Timothy. 2014. *Mundari phonology*. Dallas: SIL.
- Webb, Charlotte. 1982. A constraint on progressive consonantal assimilation. *Linguistics* 20. 309–321.
- Yip, Moira. 1991. Coronals, consonant clusters, and the coda condition. In Carole Paradis & Jean-François Prunet (eds.), *The special status of coronals: Internal and external evidence*, 61–78. San Diego, CA: Academic Press.
- Yokwe, Eluzai. 1987. *The tonal grammar of Bari*. University of Illinois at Urbana-Champaign. (Doctoral dissertation).
- Zoll, Cheryl. 2004. Positional asymmetries and licensing. In John J. McCarthy (ed.), *Optimality Theory in phonology*, 365–378. Malden, MA: Blackwell Publishing.

## Chapter 14

# The phonetics and phonology of depressor consonants in Gengbe

Samson Lotven

Indiana University Bloomington

Kelly Berkson

Indiana University Bloomington

The interaction between initial voiced obstruents and lower f<sub>0</sub> has been noted for a variety of languages (Chistovich 1969; Stevens & Klatt 1973; Bradshaw 1999; Tang 2008, to name a few). In some languages, phonetic consonant-f<sub>0</sub> interactions that alter f<sub>0</sub> register and/or contour can be phonologized as consonant-tone interactions (Maran 1973; Matisoff 1973). In Gengbe, a Gbe language spoken in Southern Togo and Benin, obstruent voicing displays several interactions with f<sub>0</sub> register and contour. The goal of this study is to present the synchronic system of Gengbe consonant-f<sub>0</sub> interactions with an eye toward the larger question of phonologization. This paper presents both phonetic and phonological data for discussion. Preliminary acoustic data suggest initial voiced obstruents lower the register f<sub>0</sub> of following Low and High tone vowels. Phonological data suggest that tonal contour effects, which change underlying High tone to Rising tone in some environments, vary based on syntactic category – voiced obstruents trigger Rising tone in nouns, while voiced obstruents and sonorants trigger Rising tone in verbs. This paper offers a snapshot of a system where at least some consonant-f<sub>0</sub> interactions have been phonologized, adding to the broader understanding of tonogenetic processes.

## 1 Introduction

It is often the case that a binary phonological contrast, for example [+/-voice] in onset consonants, is realized via differences in multiple phonetic correlates (Wright 2004). Cues related to the voicing of onset consonants, for instance, may



include (but are not limited to) Voice Onset Time (Lisker & Abramson 1964), formant transitions (Stevens & Klatt 1973),  $f_0$  contour of the following vowel (Chistovich 1969), and fundamental frequency ( $f_0$ ) register of the following vowel (Shimizu 1989). In the present work, we probe the connection between the feature [+voice] in onset consonants and lowered  $f_0$  in subsequent vowels, a relationship observed in many unrelated languages (Bradshaw 1999; Tang 2008). Though voicing- $f_0$  interactions can occur with coda consonants—as in Vietnamese and some Tibeto-Burman languages (Maran 1973; Matisoff 1973), for instance—we focus on the interaction between onset consonants and  $f_0$  in Gengbe, a Gbe language spoken in southern Togo and Benin.

Consonants that trigger  $f_0$  lowering are generally called “depressor consonants”, and have been studied in a variety of other languages but not systematically in Gengbe. Two effects are discussed here. First, depressor consonants in Gengbe trigger  $f_0$  register lowering of Low (L) tone, meaning that L is lower across the entire vowel after a depressor consonant than after other consonants. This register effect is seen in some High (H) tone contexts as well. Second, depressor consonants in Gengbe can allow initial  $f_0$  lowering of H tone in some phonological, morphophonological, and syntactic contexts. This initial  $f_0$  lowering results in a contour effect, where  $f_0$  is low at the onset of the vowel and rises across the time-course of the vowel. This contour effect differs across morphological domains in that different sets of consonants act as depressors in nouns and in verbs (where different environments produce the contour effect). While only voiced obstruents act as depressors in nouns, voiced obstruents and sonorants act as depressors in verbs. Similar observations have been made about other languages: differential treatment of onset types as depressors is attested in Ewe (Bradshaw 1999) and in Zina Kotoko (Odden 2007), for instance.

As no prior discussion of these effects in Gengbe exists, this paper presents a thorough description of the depressor effects that have been observed in Gengbe thus far. The data were collected during 18 months of fieldwork with a native speaker consultant. Acoustic analysis is included where possible, in order to illustrate the phonetic effect of depressor consonants on  $f_0$  in following vowels.

Our ultimate goal is to produce a thorough description and analysis of depressor effects in Gengbe, and doing so will necessitate taking into account phonetic, phonological, morphophonological, and syntactic factors, at a minimum. Here, however, our focus is on the phonetics and phonology of Gengbe depressor consonants, and so it is important to be clear about what we mean when we refer to phonetics and phonology. The distinction we aim to highlight is this: a phonetic depressor effect is one wherein  $f_0$  is lowered but a new tonal category is not cre-

ated, such that L after a depressor consonant has a lower fundamental frequency but is still L; a phonologization of that effect yields a new tonal category. This hinges on the distinction between  $f_0$  and tone, which is described by Yip (2002: 5) as follows: “ $f_0$  is an acoustic term referring to the signal itself... Tone...is a linguistic term. It refers to a phonological category that distinguishes two words or utterances.” The distinction between those effects that are phonetic and those that have been phonologized is not always straightforward, and our understanding of depressor effects in Gengbe is under development. To understand whether phonologization of depressor effects in Gengbe is in progress, however, we must first develop an understanding of the depressor effects that exist in the language at present. That is the goal here, and doing so helps suggest important types of data to elicit in future.

The remainder of the paper reads as follows. §2 provides relevant background on depressor consonants and tone in Gbe languages. §3 discusses the research aims and methodology employed in the current study. §4 discusses  $f_0$  effects in nouns (§4.1) and verbs (§4.2). §5 concludes the paper.

## 2 Background on depressor consonants

Previous research indicates that voiced obstruents—and sonorants, albeit less commonly—can act as depressor consonants (Ohala 1973; Bradshaw 1999; Tang 2008), meaning that they can trigger lowering (or depression) of  $f_0$  in adjacent vowels. Relevant for this discussion is the vowel immediately following a depressor consonant onset. Depressor effects fall into two broad categories.  $F_0$  register effects—schematized below in Figure 1a—are those that persevere across the entire vowel, as in Japanese (Oglesbee 2008).  $F_0$  contour effects, schematized in Figure 1b, are localized to the left edge of the vowel, following the consonant constriction release. This results in a rising pitch pattern, as in English (Lea 1973; Oglesbee 2008).

Evidence for a link between [+voice] in consonants and  $f_0$  lowering in subsequent vowels has been found in many languages (Bradshaw 1999; Tang 2008), and a relation between voiced obstruents and tone may also exist (Yip 2002: 5). In a tone language where lowered  $f_0$  on a vowel already serves as a crucial cue for L tone, co-opting  $f_0$  lowering as a redundant cue for the feature [+voice] leads to complications in the phonological system. This conflict may lead to distributional restrictions: Thai, for instance, disallows voiced stops in the onsets of high tone syllables (Perkins 2011); in Kera, limitations on obstruent voicing and tone produce a situation where the full Low-Mid-High tonal contrast is only available

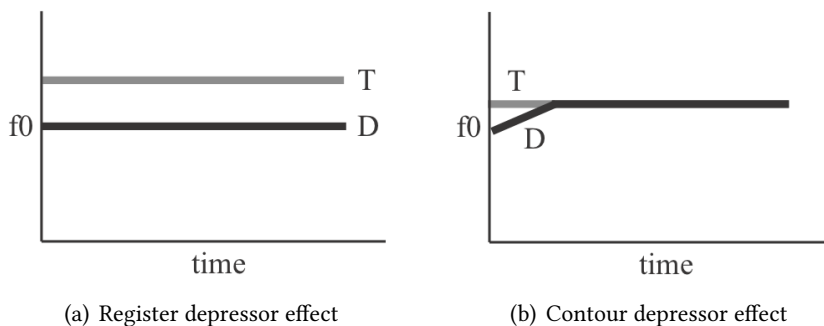

Figure 1: Schematized representations of  $f_0$  depressor effects. T represents a voiceless obstruent and D represents a voiced obstruent

in syllables with sonorant onsets (Pearce 2005); and in Ewe, a language closely related to Gengbe, Ansre (1961) analyzes the tonal system as having a “Non-High” toneme that is realized as L after a voiced obstruent and Mid (M) after a voiceless obstruent, a claim that we will revisit in §4.

These distributional restrictions hold true synchronically, but it is also worth considering their diachronic development. What might phonologization of a phonetic depressor effect look like? One process—dubbed “Tonal Bifurcation” in Hyman (2013)—is outlined in Figure 2. In the first stage of Tonal Bifurcation (Figure 2a), an  $f_0$  contour effect (as discussed earlier for English) is present in a language with two register tones (H and L). The next stage of the process (Figure 2b) involves innovation of a contrasting Rising (LH) tone due to realization of H tone syllables as LH following voiced onsets. This occurs in languages like Ewe and Gengbe (Ansre 1961; Bole-Richard 1983). In the final stages of this process—seen in languages like Nguni and Shona (Downing 2009), and illustrated in Figure 2c—the voicing distinction has been lost in favor of a tonal distinction.

- a. tá vs. dá      [+voice] manifests phonetically as a redundant  $f_0$  cue on the left edge of the vowel
- b. tá vs. dǎ      Voiced obstruents phonologically trigger Rising rather than level High tone
- c. tá vs. tǎ      Voicing contrast is lost, contrasting lexical tone remains

Figure 2: Illustration of tonal bifurcation (adapted from Hyman 2013).

Gengbe exhibits the pattern illustrated in Figure 2b: it retains a voicing contrast that results in the realization of underlying H tone with a rising pitch pattern in some contexts. We are not the first to note such an interaction in the Gbe languages. Westermann (1928) illustrated the presence of a non-lexical distinction between Low and Mid tone in Ewe, and—as noted previously—Ansre’s (1961) study of Ewe tone concludes that the language has two tonemes, High and Non-High, with the latter realized as Low after a voiced obstruent and Mid after a voiceless obstruent. Smith (1968) and Stahlke (1971) both take on the task of formalizing this interaction, focusing on the various morphophonological processes that interact with the realization of Low and Mid tone as well as some differences found across Ewe dialects. But Stahlke rejects the analysis of Mid tone as non-underlying, arguing instead for instances of predictable, lexically specified, and floating Mid tones in Ewe. Bole-Richard (1983) notes that the link between rising pitch patterns and voiced obstruents also holds for Gengbe.

Ewe is known for its typologically irregular treatment of sonorants as depressor consonants in some phonological and morphophonological contexts, earning it a slot in Bradshaw’s (1999) study of depressor effects under the section detailing “problem cases”. Bradshaw analyzes the depressor effect as an interaction between L tone and the privative feature [L/voice]. For Bradshaw, this feature is generally a property of voiced obstruents and is underspecified for sonorants, but she suggests that languages like Ewe reveal the [L/voice] feature specification in sonorants may vary from language to language (Bradshaw 1999: 169-170). As discussed in §4, Gengbe does exhibit interactions between sonorants and a rising pitch pattern, like Ewe. Although the details of the pattern differ from Ewe, under Bradshaw’s analysis this would suggest that sonorants in Gengbe, as in Ewe, are specified for [L/voice]. Note that another element of Bradshaw’s analysis is that the feature [L/voice] can render an onset transparent to L tone spreading and may also serve as the source for the L tone that spreads onto neighboring vowels. This is not investigated here but, given the other similarities between Ewe and Gengbe, it should prove valuable to investigate in the future.

In this paper we use the term “depressor consonant” as a cover term for the onsets that participate in the various pitch-lowering processes found in Gengbe—that is, for both voiced obstruents and for sonorants, in instances where they cause either register or contour effects. Some of the effects outlined may be indicative of a phonologization process—in particular, those contexts where an underlying /H/ tone mandatorily surfaces as [LH]. These should prove valuable in future discussion of how phonetic effects may become phonologized, but the goal here is to present a clear overview of the depressor effects found in nominal and verbal domains. We turn now to a review of methods and aims.

### 3 Methods and aims

The present study surveys phonetic and phonological aspects of Gengbe depressor consonants with a focus on probing the differences between nouns and verbs in realizing such effects. The data here are from a single native speaker of Gengbe who is in his fifties and is from Batonou, Togo. They were gathered in elicitation sessions conducted weekly from August 2014 to June 2016.

Those items which were subjected to acoustic analysis were recorded in randomized order. All items were embedded in carrier sentences: nouns appeared in the frame *Kòfi bé* \_\_ *kèà* ‘Kofi said \_\_ again,’ and verbs appeared in the frame *úsùà* \_\_ *vò* ‘The man \_\_ ed.’ Recordings were made in a sound-attenuated booth (WhisperRoom Model #6084), annotated using Praat (Boersma & Weenink 2016), and measured using Prosody Pro (Xu 2013), a script which automates the taking of acoustic measurements. A random sub-sample of the data was hand-checked to ensure validity.

Measures reported here are for time-normalized  $f_0$ : each vowel was divided into ten equal portions and a mean  $f_0$  measure was calculated for each portion. This method facilitates cross-token comparison. Note that vowel length in Gengbe is not lexically contrastive, although we will see that allophonic lengthening does occur in some environments. That said, in the data that follow we have indicated Rising tone as a series of L and H on identical adjacent vowels rather than on a single vowel (i.e. *àá* rather than *ǎ*). This is a stylistic choice. It does not indicate a phonemically long vowel.

### 4 F0 contour effects

As noted, an underlying H tone in Gengbe is mandatorily realized as LH in some contexts. In §4.1 and §4.2 below, we present an overview of the onset types and environments that produce LH tone in nouns and verbs respectively. The most notable difference between the two is that sonorants do not act as depressor consonants in nouns, but do so in verbs.

#### 4.1 LH tone in nouns

Most nouns in Gengbe are monosyllabic, with a lexically determined L tone nominal prefix *è-* or *à-*. In this environment, when H tone is preceded by a syllable with L tone, the surface realization of H is determined by the consonant that precedes it. Depressor consonants in this environment are followed by LH, while



other consonants are followed by H. That H and LH are both realizations of the H toneme is evinced by the numerous tonal minimal pairs included in Table 1. In these minimal pairs, L contrasts with H following voiceless obstruents (Table 1 a–c) and sonorants (Table 1 d–f). Following voiced obstruents, however—as in (Table 1 g–i)—L contrasts with LH. Recall that there is no phonemic vowel length contrast in these minimal pairs: what distinguishes them is the tone of the final syllable.

Table 1: Tonal minimal pairs

	L	Gloss	H	Gloss	LH	Gloss
a)	èkᵑᵑᵑ	‘whistle’	èkᵑᵑᵑ	‘cough’		
b)	èkò	‘neck’	èkó	‘sand’		
c)	àtᵑ	‘nest’	àtᵑ	‘apple’		
d)	èpᵑ	‘cow’	èpᵑ	‘bee’		
e)	èmᵑ	‘corn mill’	èmᵑ	‘way’		
f)	àlᵑ	‘stupidity’	àlᵑ	‘sheep’		
g)	ègà	‘metal’			ègàá	‘chief’
h)	èdᵑ	‘sickness’			èdᵑᵑ	‘work’
i)	àdᵑ	‘squirrel’			àdᵑᵑ	‘beak’

Since H and LH tone are in complementary distribution here, we consider H and LH tone allotones of the same H toneme. The data in Table 1 conform to the process Bradshaw (1999) describes as L tone spreading from the initial L tone realized on the nominal prefix over the voiced obstruent (with [L/voice]) and onto the following vowel, a process that does not occur in nouns with voiceless obstruent and sonorant onsets lacking this feature.

There are several things to note about the phonetic realization of H and LH as illustrated by the above data. First, LH tone is associated with vowel lengthening. Average duration of vowels after voiced and voiceless obstruents—calculated over 66 items in each category, for a total of 264 tokens—is shown in Figure 3. Duration is of course affected by factors such as speaker and speaking rate, but in these data vowels with LH tone (shown in the bottom bar on the chart) are longer than other vowels by approximately 60ms.

We can also look at the time-normalized  $f_0$  tracks of these vowels, shown in Figure 4. Here, gray lines represent vowels after voiceless obstruents (referred to as “T” in the key) and black lines represent vowels after voiced obstruents (referred to as “D” in the key). Solid lines represent L tone, and dotted lines rep-

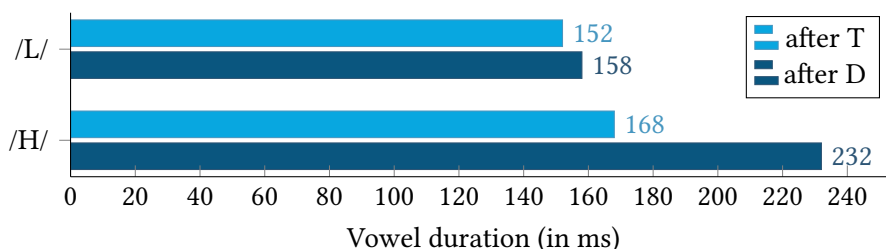

Figure 3: Average duration of vowels after voiced (dark) and voiceless (light) obstruents in nouns. Underlying H is longer after voiced than after voiceless obstruents. “T” represents a voiceless obstruent and “D” represents a voiced obstruent.

resent H (after voiceless obstruents) and LH (after voiced obstruents). Note the presence of what looks like an  $f_0$  register effect in Low tone: L after voiced obstruents is approximately 20Hz lower than after voiceless obstruents, and this difference perseverates across the entirety of the subsequent vowel. The dashed lines, meanwhile, illustrate the robust  $f_0$  differences between H and LH, realized as a contour effect.

Means and standard deviations are included in Table 2; commentary follows. The L tone difference illustrated in Figure 4 conforms to Ansre’s (1961) analysis of Ewe, which claims that there are two realizations of the Non-High toneme: Low after a voiced obstruent and Mid after a voiceless obstruent. But is this a phonetic effect as discussed above for Japanese (Oglesbee 2008) or is this a phonological effect as Ansre proposes for Ewe? Unlike Ewe, neither previous Gengbe literature nor our elicitation has provided evidence for Mid tones that are not phonologically conditioned, nor have we discovered lexical Mid tones or floating morphological Mid tones in Gengbe. The appearance of the phonetically lower Low after a voiced obstruent, in other words, is regular and predictable in Gengbe, whereas that is not always the case in Ewe. For the time being, then, we analyze this register lowering as a purely phonetic effect.

As a side note,  $f_0$  register lowering is not limited to L tone contexts. As discussed more thoroughly in §4.2, there are contexts in Gengbe where High tone is realized as H rather than as LH after voiced obstruents. In these instances, shown in Figure 5, we again see what looks like register lowering of  $f_0$ . High tone is realized with higher  $f_0$  after voiceless obstruents than after voiced obstruents. Note here that the pitch range for H tone in Figure 5 is comparable to the pitch range for L tone in Figure 4 above, but this is most likely a result of final lowering—a topic to be investigated in future work.

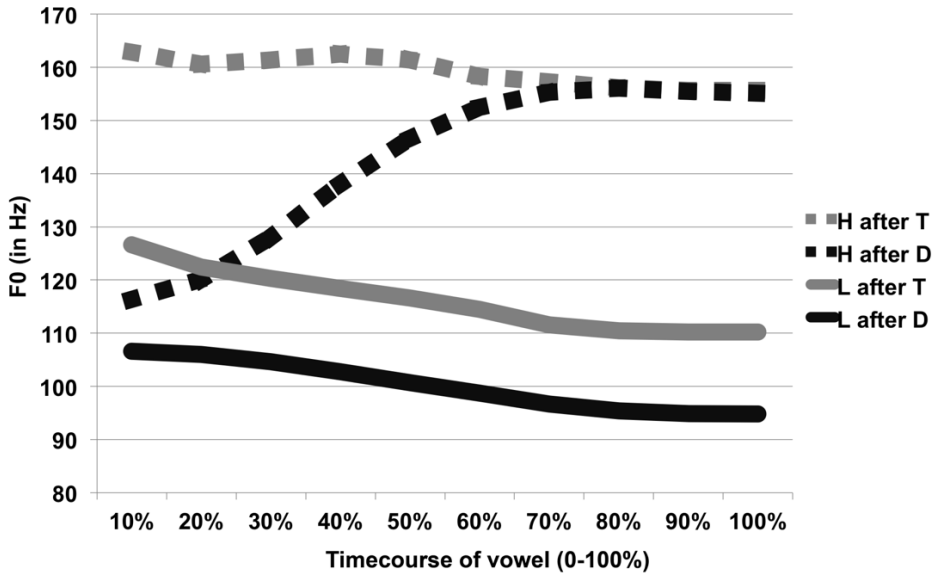

Figure 4: Time-normalized f0 tracks of High (dotted lines) and Low (solid lines) tones after voiced (black lines) and voiceless (gray lines) obstruents in nouns. H follows voiceless obstruents and LH follows voiced obstruents.

Table 2: Means and standard deviations (in Hz) for the ten timepoints included in time-normalized f0 tracks shown in Figure 4.

		10%	20%	30%	40%	50%	60%	70%	80%	90%	100%
H after T	M	170	167	167	167	166	163	161	160	160	160
	SD	10	11	14	18	19	18	17	17	17	17
H after D	M	118	121	128	137	145	151	153	154	154	154
	SD	20	19	19	19	18	16	16	17	18	18
L after T	M	131	127	125	123	121	119	115	114	114	114
	SD	27	32	37	41	44	42	34	33	33	33
L after D	M	108	108	106	104	102	100	99	98	97	97
	SD	6	7	8	8	8	8	9	10	11	11

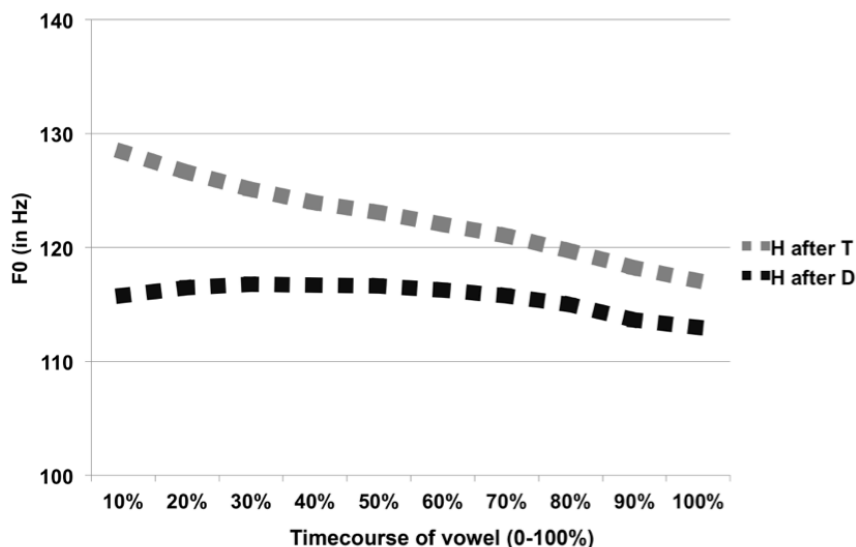

Figure 5: Time-normalized f0 tracks of level High tones after voiced (black) and voiceless (gray) obstruents in verbs. H is lower following voiced obstruents.

At this time we do not have a firm answer on whether register f0 lowering is a phonetic or phonological effect in Gengbe. The data may support an analysis in Gengbe that parallels that adopted for the L toneme in Ewe—that is, an analysis that posits two allotones for the L toneme (in Figure 4) and two allotones for the H toneme (in Figure 5)—but this is a question we can not answer yet.

For now, we leave the topic of f0 register effects and turn back to the LH tone in Gengbe. The f0 contour effect in nouns—which manifests as a Rising pitch pattern in Table 1 (g–i), is shown to have longer duration than H in Figure 3, and displays a >50 Hz f0 difference localized to the left edge of the vowel in Figure 4—is tied to the tone of the preceding syllable, not just preceding L tone nominal prefixes. In nominal compounds, for instance, word-medial nominal prefixes are deleted. If this means that the target H tone syllable is preceded by a surface H, as in (1), or a surface LH, as in §2, no f0 contour effect occurs. Rather, underlying H surfaces as H even after voiced obstruents.

- (1) àníǵbá + èdòó → àníǵbádó  
 ‘earth’ ‘work’ ‘earth work’

- (2) èǵbèé + àvùú → èǵbèévú  
 ‘bush’ ‘dog’ ‘bush dog’

This interaction is relevant, for it helps to define the phenomenon as morphophonological in the sense that depressor consonants are not the source of the L tone (as is argued for in Bradshaw 1999 for some depressor effects). Rather, depressor consonants allow L tone to spread over them from the preceding vowel. Using preceding L tone nominal prefixes as an illustrative environment, we present the list of Gengbe onsets that nouns treat as depressors in Table 3. This includes all voiced obstruents—stops in (a–d), affricates in (e), fricatives in (f–i), and the retroflex [d] in (j).

Table 3: List of Gengbe depressor consonants in nouns

	Onset	Noun	Gloss		Onset	Noun	Gloss
a)	[b]	àbòó	‘arm’	g)	[z]	èzàá	‘night’
b)	[d]	édòó	‘work’	h)	[β]	èβàá	‘spear’
c)	[g]	èǵàá	‘bigness’	i)	[f]	èfàá	‘group’
d)	[ǵb]	èǵbíí	‘buttocks’	j)	[d]	èdǵí	‘dirt’
e)	[ǵʒ]	èǵʒàá	‘bow’	k)	[gl]	àǵlòó	‘joy’
f)	[v]	àvòó	‘cloth’	l)	[hǵ]	èhǵèé	‘poverty’

Table 4, meanwhile, presents the consonants that do not act as depressors in Gengbe nouns. These include voiceless obstruents, as in (a–f), and sonorants, as in (g–l). By contrasting Table 3 items (k–l) with Table 4 items (m–o), we can also see that the second member of an onset cluster is disregarded when calculating depressor effects in nouns. In other words, it is C<sub>1</sub> in a C<sub>1</sub>C<sub>2</sub> onset cluster that determines how an underlying H is realized in Gengbe nouns—clusters that begin with a depressor, as in Table 3 items (k–l), pattern with other onset depressors. Clusters that do not, as in Table 4 items (m–o), pattern with the other non-depressor onsets. Note that only liquids and glides may appear as C<sub>2</sub> in consonant clusters in Gengbe. Bradshaw’s (1999) analysis of sonorants as unspecified for [L/voice] may prove useful here. While it is beyond the scope of the present work, investigation of this possibility will prove valuable in future work.

While the pattern seen in verbs—shown next, in §4.2—differs, depressor consonants in nouns are limited to voiced obstruents. Sonorants do not act as depressors in nouns, and they are disregarded in C<sub>1</sub>C<sub>2</sub> clusters, indicating that it is the featural specification of C<sub>1</sub> that is relevant for this process. Furthermore,

Table 4: Non-depressor consonants in Gengbe nouns

	Onset	Noun	Gloss
a)	[t]	àtí	'tree'
b)	[k]	èkú	'death'
c)	[kp̄]	èkpá	'fence'
d)	[ɸ]/[p]	àɸá/ápá	'shout'
e)	[f]	àfí	'here'
f)	[s]	èsó	'horse'
g)	[m]	èmú	'mosquito'
h)	[n]	àná	'bridge'
i)	[ɲ]	èɲí	'bee'
j)	[l]	èló	'crocodile'
k)	[w]	èwó	'corn flour'
l)	[j]	àjá	'air'
m)	[kl]	àkló	'flat boat'
n)	[fj]	èfjó	'monkey'
o)	[wl]	èwlí	'shout'

LH tone in nouns is triggered by L tone in a preceding syllable. When preceded by H or LH tone, as in nominal compounds, underlying H surfaces as H even after voiced obstruents, so this phenomena requires an external L tone to trigger spreading. This contrasts with the verbal pattern, which is outlined in the next section, where we will see that the occurrence of depressor effects is based on syntactic position.

#### 4.2 LH tone in verbs

Verbs differ phonologically from nouns in several ways. First, more onset types (sonorants and voiceless obstruent-liquid sequences) act as depressors in verbs. In addition, LH tone surfaces not after a preceding L tone vowel, but after a preceding phrase boundary. We begin by presenting data motivating the claim that verbs are sensitive to initial phrase-boundaries, then use the structural positions in which LH tone manifests to illustrate the onset types that act as depressors in the verbal domain. Data are drawn from three contrasting syntactic situations: predication vs. citation, plural imperative vs. singular imperative, and reduplication with vs. without a pre-posed logical object.

In predication, as shown in (3), even when the preceding vowel has L tone and even following voiced obstruents, as in (3b), the H tone verb is not realized as LH. In citation forms, however—shown in the examples in (4)—there is no overt subject present. Here we see that what surfaced as H in the examples in (3) is still realized as H after voiceless obstruents (4a) but as LH after voiced obstruents (4b) and sonorants (4c).

(3) Predication (overt subject)

- a. mǔ̀ kɔ́ ò̀ ntí̀sì  
1SG see lime  
'I saw a lime.'
- b. mǔ̀ bú ò̀ ntí̀sì  
1SG lose lime  
'I lost a lime.'
- c. mǔ̀ ɲá gǔ̀mè̀d͡ʒè̀d͡ʒéé-á  
1SG know beginning-DEF  
'I know the beginning.'

(4) Citation (no overt subject)

- a. kɔ́  
see  
'to see'
- b. bú  
lose  
'to lose'
- c. ɲá  
know  
'to know'

The examples in (4) illustrate that the verbal domain differs from the nominal domain in both the context and onset types that are required for the realization of LH. As we saw in §4.1, the context that produces LH tone in nouns is morphophonological, in the sense that it results when an underlying H surfaces after a depressor consonant preceded by a Low-toned syllable. The context that gives us LH in verbs is syntactic, however. In addition, both the voicing and obstruency of an onset is relevant in the nominal domain where only voiced obstruents act

as depressors. In the verbal domain, however, it appears that only voicing matters: here, as shown in (4b) and (4c), both voiced obstruents and sonorants act as depressors.

The same observations made in (3–4) hold for overt and non-overt subjects in imperatives. Plural imperatives, which require the overt L tone subject *mí*, as in (5), exhibit no depressor effect. Singular imperatives, on the other hand, lack overt subjects, as in (6), and we see the same depressor effect shown in (4) in citation form.

(5) Plural imperative (overt subject)

- a. *mí tú èhǎ̀trú*  
2PL close door  
'Close the door, you all!'
- b. *mí vá*  
2PL come  
'Come, you all!'
- c. *mí lé ú̀sù-à*  
2PL arrest man-DEF  
'You all arrest the man!'

(6) Singular imperative (no overt subject)

- a. *tú èhǎ̀trú*  
close door  
'Close the door!'
- b. *vàá*  
come  
'Come!'
- c. *lèé ú̀sù-à*  
arrest man-DEF  
'Arrest the man!'

Bradshaw (1999) analyzes the singular imperative in Ewe as formed by a prefixed L tone morpheme that docks with the vowel only when the onset is voiced. Since our data suggests the trigger of LH is present in citation form as well as the singular imperative, we describe the phenomenon in terms of an initial syntactic boundary (possibly an initial L boundary tone) rather than a morphological affix. It is possible still that the L tone is a morphological affix, although with the



two situations described (as well as reduplication data below), we posit a single positional explanation rather than three independent L tone morphemes.

When a verb is reduplicated, the logical object, normally following the bare verb, is moved to precede the reduplicated verb. Where there is such pre-verbal information, there is no depressor effect, as in (7), and where there is no preverbal material, we again see the depressor effect, as in (8). Note that sonorants are still considered depressors here despite the fact that in (7–8) we are deriving nouns from verbal roots. If we are to assume that category-changing derivation processes are done in the lexicon, this introduces an as-yet unsolved mystery as to the nature of the relevant property that determines which set of onsets counts as depressors. For now we can tentatively define the distinction as derivation from underlying nominal or verbal roots.

(7) Reduplication (pre-posed object)

- a. èlǎ fá~fá  
meat cool~NOM  
'cooling meat'
- b. èlǎ vó~vó  
meat decay~NOM  
'decaying meat'
- c. ɲǎ̀nǎ̀ jǎ~jǎ  
woman call~NOM  
'calling a woman'

(8) Reduplication (no pre-posed object)

- a. fá~fá  
cool~NOM  
'cooling'
- b. vòó~vó  
decay~NOM  
'decaying'
- c. jǎó~jǎ  
call~NOM  
'calling'

We analyze this process in terms of syntax rather than morphology or phonology for the following reasons. As noted before, we do not posit tonal morphology that affects these three processes independently, although we leave open the possibility. We also do not see a clear path to a phonological explanation in terms of (prosodic) word-initial position. If we were to explore this possibility, we would need to describe the verbs in (3), (5), and (7) as non-initial. Pronouns in (3) and (5) can – and have in the case of Ewe (Duthie 1996) – been analyzed as clitics, however, full NP subjects also fail to trigger LH tone in following predicates, for example *ènǎǎ bé* ‘mother said,’ suggesting that the right environment for LH tone in verbs has to do with phrase position (possibly utterance-initial position) rather than word position. As of yet, we leave the term ‘phrase-initial position’ purposefully vague. The importance of syntactic position in tone rules is well established (Snider 2014), but we leave the definition of such positioning to future syntactic work.

The data in (3–8) indicate that depressor consonants in the verbal domain include voiced obstruents and sonorants and that the phrase-initial position, rather than a preceding L tone vowel, is the trigger for LH tone. The data in (9–10) present verbs with initial consonant clusters, using the citation form as illustration, though reduplication and imperative data were also investigated. (9) reveals that consonant-liquid clusters act as depressors, regardless of the identity of  $C_1$ ; (10) reveals that consonant-glide clusters do not. It is again valuable to note that liquids and glides are the only consonants that can serve as  $C_2$  in a consonant cluster in Gengbe. The crucial data points here are (9a) where a voiceless onset-liquid cluster shows a depressor effect and (10a) where a voiceless onset-glide cluster does not. We resist the urge here to speculate about syllable structure based on these verbal data since the difference between  $C_2$  liquids and glides in the verbal domain does not hold in the nominal domain, as illustrated previously in Table 4 (m–n).

(9) Consonant-liquid clusters in Gengbe Verbs

- a. klòó  
‘to fade’
- b. ɲlǎǎ  
‘to fold’
- c. glòó  
‘to boast’

(10) Consonant-glide clusters in Gengbe Verbs

- a. fɲɔ  
‘to teach’
- b. ljàá  
‘to climb’
- c. fɲjèé  
‘to need’

Taking all of these data together, then, verbs differ from nouns (or more specifically verbal roots differ from nominal roots) in that single onset sonorants act as depressors for the former, but not the latter. Furthermore, C<sub>1</sub> determines whether or not a depressor effect emerges in nouns and consonant-liquid sequences fail to act as depressors if C<sub>1</sub> is not a voiced obstruent. Yet in verbs, regardless of the identity of C<sub>1</sub>, consonant-liquid but not consonant-glide clusters act as depressors. Finally, LH tone in verbs is triggered in phrase-initial position rather than by preceding L tone vowels. A breakdown of the onset types that pattern as depressors in the nominal and verbal domains is given in Figure 5, where a shaded box indicates that a depressor effect obtains in that environment: in other words, depressor effects occur after voiced obstruents—still represented with a capital D—in both nominal and verbal domains. Note that a noun consisting of a H tone syllable with Nasal-Glide (NG) onset has yet to be elicited and is marked “n/a.”

Table 5: Summary of onsets considered depressors by nouns and verbs (T=Voiceless Obstruent, D=Voiced Obstruent, N=Sonorant, L=Liquid, G=Glide)

	T	TL	TG	D	DL	DG	N	NL	NG
Nouns				•	•	•			n/a
Verbs		•		•	•	•	•	•	•

In this survey, we have presented a brief overview of the phonetic, phonological, morphological, and syntactic contexts in which we can, on the surface, observe f<sub>0</sub> register and f<sub>0</sub> contour lowering. This overview is preliminary, and is intended to inform future investigation.

## 5 Summary

Our preliminary research on Gengbe has highlighted relevant observable phenomena as well as mysteries in need of further investigation. We have shown two types of observable effect. An  $f_0$  contour effect occurs when an underlying H follows specific depressor onsets (a category which differs based on whether a root is nominal or verbal) and is realized with a Rising pitch pattern. It is realized phonetically through both lengthening (by about 60ms) and  $f_0$  lowering (by about 50Hz at the left edge of the vowel). There is also an  $f_0$  register effect, wherein an underlying L is realized as lower following a voiced obstruent (by about 20 Hz across the duration of the vowel). We have shown that register  $f_0$  lowering is also present in some verbal contexts when an underlying H surfaces as H (rather than LH) after a voiced obstruent.

In the contexts investigated in this study, we find that nominal and verbal roots differ both in the onset types that are followed by LH and in the contexts that trigger this Rising pitch pattern. Nominal roots in Gengbe treat voiced obstruents in  $C_1$  position as depressors, revealed as such when preceded morphologically by a L tone syllable.  $C_2$  consonants do not alter this effect in nouns. Verbal roots, on the other hand, treat both voiced obstruents and sonorants as depressors, revealed as such when placed in phrase-initial position. Unlike nouns,  $C_2$  liquids—but not glides—are also followed by LH in these verbal contexts.

Although this study is preliminary and there is much work to be done on Gengbe, it is our expectation that further investigation of the behavior and identity of depressor consonants in the many Gbe languages will provide a rich ground for the study of tonal bifurcation and the phonologization of tone.

## Abbreviations

1SG	1st Person Singular Subject	DEF	Definite Determiner
2PL	2nd Person Plural Subject	NOM	Nominalizer

## References

- Ansre, Gilbert. 1961. *The tonal structure of Ewe*. The Kennedy School of Missions of the Hartford Seminary Foundation: Hartford, Connecticut. (Masters Thesis.)
- Boersma, Paul & David Weenink. 2016. *Praat: Doing phonetics by computer*. Amsterdam: University of Amsterdam. Version 6.0.14.

- Bole-Richard, Rémy. 1983. *Systématique phonologique et grammaticale d'un parler ewe: Le Gen-mina du Sud-Togo et Sud-Bénin*. Paris: Editions L'Harmattan.
- Bradshaw, Mary M. 1999. *A crosslinguistic study of consonant-tone interaction*. Ohio State University, Columbus. (Doctoral dissertation).
- Chistovich, L. A. 1969. Variations of the fundamental voice pitch as a discriminatory cue for consonants. *Soviet Physics-Acoustics* 14. 372–378.
- Downing, Laura J. 2009. On pitch lowering not linked to voicing: Nguni and Shona group depressors. *Language Sciences* 31(2). 179–198.
- Duthie, Alan S. 1996. *Introducing Ewe linguistic patterns*. Accra: Ghana Universities Press.
- Hyman, Larry M. 2013. Enlarging the scope of phonologization. In Alan Yu (ed.), *Origins of sound change: Approaches to phonologization*, 3–28. Oxford: Oxford University Press.
- Lea, Wayne A. 1973. Segmental and suprasegmental influences on fundamental frequency contours. *Consonant types and tone* 1. 15–70.
- Lisker, Leigh & Arthur Abramson. 1964. A cross-language study of voicing initial stops: Acoustical measurements. *Word* 20(3). 384–422.
- Maran, La Raw. 1973. On becoming a tone language: A Tibeto-Burman model of tonogenesis. *Consonant types and tone* 1. 97–114.
- Matisoff, James A. 1973. Tonogenesis in southeast Asia. *Consonant types and tone* 1. 71–95.
- Odden, David. 2007. The unnatural tonology of Zina Kotoko. *Tones and Tunes* 1. 63–89.
- Oglesbee, Eric N. 2008. *Multidimensional stop categorization in English, Spanish, Korean, Japanese, and Canadian French*.
- Ohala, John J. 1973. The physiology of tone. *Consonant Types and Tone* 1. 1–14.
- Pearce, Mary. 2005. Kera tone and voicing. *UCL Working Papers in Linguistics* 17. 61–82.
- Perkins, Jeremy. 2011. *Consonant-tone interaction and laryngealization in Thai*. Paper presented at 21st Annual Conference of the Southeast Asian Linguistics Society.
- Shimizu, Katsumasa. 1989. A cross-language study of voicing contrasts of stops. *Studia Phonologica* 23. 1–12.
- Smith, Neil. 1968. Tone in Ewe. *MIT Research Laboratory in Electronics Quarterly Progress Report* 88. 293–305.
- Snider, Keith. 2014. On establishing an underlying tonal contrast. *Language Documentation and Conservation* 8. 707–737.

- Stahlke, Herbert F. W. 1971. *Topics in ewe phonology*. University of California, Los Angeles. (Doctoral dissertation).
- Stevens, Kenneth N. & Dennis Klatt. 1973. Role of formant transitions in the voiced-voiceless distinction for stops. *The Journal of the Acoustical Society of America* 55(3). 653–659.
- Tang, Katrina E. 2008. *The phonology and phonetics of consonant-tone interaction*. University of California, Los Angeles. (Doctoral dissertation).
- Westermann, Diedrich. 1928. *Evefiala or Ewe-English dictionary*. Berlin: Deitrich Reimer (Ernst Vohsen). Reprint 1973.
- Wright, Richard. 2004. A review of perceptual cues and cue robustness. In Bruce Hayes, Robert Kirchner & Donca Steriade (eds.), *Phonetically based phonology*, 34–57. Cambridge: Cambridge Press.
- Xu, Yi. 2013. Prosodypro—a tool for large-scale systematic prosody analysis. In *Proceedings of tools and resources for the analysis of speech prosody (trasp 2013), aix-en-provence, france*. 7-10.
- Yip, Moira. 2002. *Tone*. Cambridge: Cambridge University Press.

## Chapter 15

# Factors in the affrication of the ejective alveolar fricative in Tigrinya

Emily Moeng

University of North Carolina, Chapel Hill

William Carter

University of North Carolina, Chapel Hill

Ejective fricatives are typologically rare sounds, attributable to the fact that they present an articulatory dilemma with contrasting demands for their fricative and ejective components. Several articulatory coping mechanisms have been observed across languages (Maddieson 1997; 1998). In the case of Tigrinya, Shosted & Rose (2011) find that the ejective alveolar fricative, /s'/, is affricated more often than not (/s'/ produced as [ts']), proposing affrication to be another possible coping mechanism. This study assesses two possible factors affecting the rate or degree of affrication in Tigrinya: 1) the vowel environment surrounding /s'/ and 2) the lexical frequency of words containing /s'/. While we find no effect of lexical frequency, we find a significant effect of vowel context, with the lowest rate of affrication occurring following [i] and preceding [u]. We propose that this finding suggests that this environment, naturally aids the production of ejective fricatives due to vowel coarticulation, as the decreasing supralaryngeal volume over the duration of the fricative counteracts the loss of air due to frication.

## 1 Introduction

The goal of this paper is to identify possible factors in the affrication of a typologically rare sound, the ejective alveolar fricative /s'/, in the language Tigrinya. Although described as an alveolar ejective fricative in the literature (for example, Tewelde 2002), /s'/ in Tigrinya is often produced as [ts']), only being produced



as [s'] about 20% of the time (Shosted & Rose 2011). (Despite this, we will be following this convention of treating this phoneme as /s'/.) We will be analyzing a phonetic factor (vowel context) and a lexical factor (lexical frequency).

## 2 Background

### 2.1 Tigrinya

Tigrinya (also, *Tigrigna*) is an Ethiopic-Semitic language spoken primarily in Eritrea and the northern Tigray region of Ethiopia by approximately 8 million people as a first language (Lewis et al. 2016). Like its relatives Amharic and Tigre, Tigrinya features a three-way contrast in its stops and affricates (see Table 1).

Table 1: The obstruent phonemes of Tigrinya.

		Labial	Dental	Palato- alveolar/ palatal	Velar	Pharyngeal	Glottal
Stop/	voiceless	p	t	tʃ	k, k <sup>w</sup>		
Affricate	voiced	b	d	dʒ	g, g <sup>w</sup>		ʔ
	ejective	p'	t'	tʃ'	k', k' <sup>w</sup>		
Fricative	voiceless	f	s	ʃ		ħ	h
	voiced		z	ʒ		ʕ	
	ejective		s'				

While ejective stops and affricates are fairly well-represented cross-linguistically, ejective fricatives are typologically rare sounds, only being attested in 10 of the 451 languages (2.22%) in UPSID-PC (Maddieson & Precoda 1990). As Shosted & Rose (2011) observe, there seems to be an implicational hierarchy among ejective obstruents such that languages which feature ejective fricatives are a subset of those containing ejective stops and affricates.

### 2.2 Ejective fricatives: An articulatory paradox

The cross-linguistic rarity of ejective fricatives comes as little surprise when one considers the paradoxical nature of their articulatory requirements. Ejectives require the complete closure of the vocal folds. This, followed by the raising of the larynx, causes an increase in air pressure in the space bounded by the larynx and the place of articulation of the phone being produced (Ladefoged 1993:



130). Fricatives, however, require continuous turbulent airflow through a narrow channel, meaning that no airtight supralaryngeal space is ever formed. As a result, a dilemma emerges in which either frication must be sacrificed in favor of ejectiveization or vice versa unless a speaker introduces a coping mechanism. Three proposals for such coping mechanisms which have been considered in the literature are as follows:

1. **Narrow Oral Constriction:** Increase the narrowness of the oral constriction such that the pressure from the supralaryngeal cavity is able to maintain frication (Maddieson 1997; 1998).
2. **Separate Constrictions:** Separate the frication and glottal constriction into the sequence of a pulmonic fricative followed by a glottal constriction (Maddieson 1997; 1998).
3. **Affrication:** Add a preceding oral closure to create a sealed supralaryngeal cavity with enough pressure to supply both the fricative and ejective components (Shosted & Rose 2011).

Both Mechanisms 1 and 2 have been observed in natural languages (Tlingit and Yapese, respectively) Maddieson et al. 2001; Maddieson 1998). Shosted & Rose (2011) show that Tigrinya speakers employ Mechanism 3.

An additional mechanism has been suggested by Demolin (2002). Through electropalatograms, Demolin shows that Amharic alveolar ejective fricatives are realized with increased alveopalatal contact compared with their pulmonic counterparts. He concludes that this serves to decrease the size of the supralaryngeal cavity and increase pressure. Thus, a fourth proposed coping mechanism would be:

4. **Back the Place of Articulation:** Push back the place of constriction to decrease the volume of the supralaryngeal cavity (Demolin 2002).

### 3 Research questions

Given that ejective fricatives are so often produced as affricates in Tigrinya (about 80% of the time according to Shosted & Rose 2011), this study seeks to identify factors which may contribute to a greater degree of affrication of /s'/ in Tigrinya. Specifically, this study seeks to answer the following questions: (1) Are surrounding vowels a factor in the affrication of /s'/, and (2) Is lexical frequency a factor

in the affrication of /s'/? Question 1 will be examined with Experiment 1, and Question 2 will be examined with Experiment 2. Because there is no sizeable corpus for Tigrinya, lexical frequency will be estimated with a reaction time task, discussed in §6.

## 4 Shared methodology

This section describes the methodology shared in both experiments.

### 4.1 Participants

Five native speakers of Tigrinya participated (3 female, 2 male), ranging from 20 to 60 years of age. 4 participants had immigrated to North Carolina from Asmara, Eritrea, and 1 from Ethiopia. All participants were literate in the Ethiopic script and in English. All participants reported that they currently speak Tigrinya on a daily or semi-daily basis, with the exception of one participant, who reported that he currently speaks Tigrinya only rarely.

### 4.2 Equipment

Recordings were made in a quiet room or in a soundproof booth when possible on a Lenovo X1 Carbon laptop computer at 44100Hz with a Microsoft LifeChat LX-3000 microphone, using Praat speech analysis software (Boersma & Weenink 2013). Psychopy v1.83.01 (Peirce 2007) was utilized to present stimuli to participants in Experiment 2. Statistical analyses were carried out in SAS.

## 5 Experiment 1: Vowel context

### 5.1 Methodology

#### 5.1.1 Stimuli

Stimuli consisted of 3-character, 3-syllable nonce words of the form C1-V1-C2-V2-C3-V3. C1 and C3 were stops, liquids, or nasals, the identities of which were randomly generated. V1, V2, and V3 each consisted of one member of [i a u]. C2 was one of the following phones: [s s' tʃ tʃ' t' ʃ]. For example, one nonce word was ገሱጎጎ [gus'ipa]. Words were shown to a native speaker who agreed that the words were not real words in Tigrinya, but that they could be. Stimuli

consisted of 10 items each for all possible combinations of C2 ([s s' tʃ tʃ' t t' ʃ]) and V2 ([i a u]), resulting in 210 words. Due to space constraints, only the 30 of those words in which C2 was [s'] will be discussed here. V1 was not controlled for equal representation of [i a u].

### 5.1.2 Procedure

Stimuli were embedded in the frame shown in 1. Due to the use of nonce words, all frames contained two repetitions of the test item *WORD*, so that participants were less likely to pause before the unfamiliar word. Only the test item embedded within the sentence (bolded in 1) was included in the analysis. Stimuli were randomized for each participant, and each participant was given a printed copy of the list of sentences from which to read. Participants were told they could take as much time as needed, and could repeat the sentence if they felt they had misspoken. If this happened, only the last repetition was included in the analysis.

- (1) (*WORD*):# ጸቲ ወዲ (*WORD*) በለ:#  
 XXX ?iti wedi XXX bele  
**WORD** the boy **WORD** say  
 'WORD. The boy says **WORD**.'

## 5.2 Analysis

Following Shosted & Rose (2011), up to 5 landmarks for each /s'/ phoneme were marked for each recording. The same criteria used by Shosted and Rose were used, abbreviated below:

1. **Vowel 1 (V1)**: Measured from the initiation of regular vibration in the waveform to the beginning of high-amplitude aperiodic variation or a period marked by virtually no noise.
2. **Closure (C)**: Period of virtually no noise from the point at which voicing is extinguished to the initiation of high amplitude aperiodic noise (frication) or the first transient burst followed by frication.
3. **Release (s)**: High-amplitude aperiodic noise.
4. **Laryngealization (Q)**: Low-amplitude aperiodicity before the onset of voicing and initiation of regular vibration.

5. **Vowel 2 (V2)**: Measured from the initiation of regular vibration to the point at which high-amplitude periodic variation in the oscillogram discontinues.

All measurements were made by hand in Praat. Figure 1 (left) shows an example of an affricated /s'/ produced as [ts'], and Figure 1 (right) shows an example of an unaffricated /s'/ produced without a period of closure before the fricative.

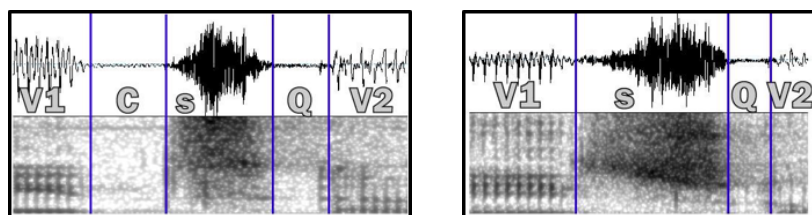

(a) Spectrogram of /s'/ produced as an affricate [ts']. Note the period of closure (marked as "C") between the preceding vowel ("V1") and the fricative ("s").

(b) Spectrogram of /s'/ produced as an unaffricated [s'] with no closure preceding the fricative. Note the lack of closure between "V1" and "s".

Figure 1: Spectrograms of /s'/

The authors transcribed the identity of V1 and V2. This was based on the authors' perception of each vowel produced, rather than the vowel that was actually written in the reading list given to participants. This was done in case participants had misidentified the characters on the page, as these were all nonce words, and also since some distinctions between graphemes differing only in vowel quality can be quite subtle (e.g.  $\mathfrak{h}$  /ʔe/ vs.  $\mathfrak{h}$  /ʔi /).<sup>1</sup> All productions containing vowels which were not perceived by the authors as clearly being [i], [a], or [u] were discarded. 16 test items were discarded on these conditions leaving 120 productions for analysis. For the 120 remaining items, speakers' combined rates of non-affricated /s'/ productions were calculated for each of the nine pairs of V1 and V2 environments. For each of these 9 vowel contexts, the rate of non-affrication was calculated as the proportion of ejective fricatives that were not affricated out of all ejective fricatives produced in that vowel context.

<sup>1</sup>As noted by an anonymous reviewer, interpreting the results of our study would be greatly complicated if the graphemic difference between /s/ and /s'/ were also subtle. However, these two are quite different from one another (e.g.  $\mathfrak{h}$  [se] vs.  $\mathfrak{h}$  [s'e]).

### 5.3 Results

Fisher's exact test<sup>2</sup> was used to compare the proportion of /s'/ produced with no closure in each of the 9 possible vowel contexts to the proportion of the rest of the vowel contexts. It was found that the proportion of those with no closure is significantly greater for /s'/ in the "i-u environment" (i.e. following [i] and preceding [u]) than for any other environment ( $p = 0.0011$ ). Table 1 (left) shows the proportion of /s'/ for which there was no closure in each vowel context out of the total number of /s'/ produced in that same vowel context.

In a post-hoc analysis, we also measured the closure duration of those tokens of /s'/ which were affricated. The averages of these for each environment are shown in Table 1 (right). Numerically, average closure duration in an "i-u environment" is lower than that in other environments (45.1ms), with the exception of the "a-i" and "a-a" environments, which have even lower average closure durations (41.3 ms and 42.4 ms, respectively). In a post-hoc analysis, a t-test reveals no significant contrast between the value of the "i-u" cell and the collection of all other cells ( $p = 0.43$ ).

Table 2: (Left) Proportion of non-affricated ejective fricatives by environment. (Right) Average closure duration (in milliseconds) when /s'/ was affricated (/s'/ produced as [ts']), also by environment.

\*\* Significantly different from the mean of all other environments at  $p = 0.00556$ .

		V2					V2		
		i	a	u			i	a	u
V1	i	12.5%	15.4%	36.4%**	V1	i	50.3	47.0	
	a	5.9%	11.8%	0%	a		41.3	42.4	
	u	0%	10.0%	0%	u		54.1	50.1	

For each of the 9 environments, we compared the percent of /s'/ produced with no closure to the average duration of closure for those /s'/s which were produced with closure. This was done to see whether environments with reduced affrication rates also affected the duration of closure for affricated segments. To do this, the values from Table 1 (Left) and Table 1 (Right) were plotted for each environment (see Figure 2), and a test for correlation was conducted.

<sup>2</sup>With a Bonferroni adjusted alpha level of 0.0056 (0.05/9).

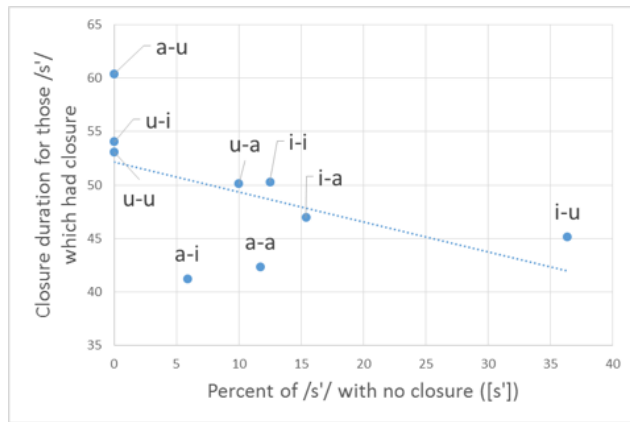

Figure 2: Average closure duration of those ejectives which have been affricated ([ts']) decreases as the percent of ejective fricatives with no closure ([s']) increases ( $r = -0.54$ ,  $p = 0.13$ ).

A Pearson Correlation Coefficient of  $r = -0.54$  was calculated for the set of points. However, this correlation cannot be said to be significant with a nondirectional  $p$ -value of 0.13. This is due to the maximum sample size of  $N = 9$  that can be derived from a  $3 \times 3$  environment matrix, not necessarily the robustness of the trend. Performing this same analysis with a larger environment matrix would be the next step in testing the significance of the trend suggested here.

## 5.4 Discussion

In order to produce an ejective without complete closure as in the case of ejective fricatives, the loss in air pressure caused by escaping air must be no greater than the rate at which additional pressure is created by compression of the supralaryngeal cavity. If this is not attained, then the pressure differential necessary for the production of the ejective burst will be lost. One way to accomplish this would be to “push back” the place of constriction, shrinking the size of the supralaryngeal cavity over the course of the segment’s production. Coarticulation with surrounding vowel environments might naturally facilitate or hinder the movement of the fricative constriction.

We thus predict less affrication in vowel contexts where coarticulation causes a backing of the constriction.<sup>3</sup> We found that the proportion of un-affricated ejective fricatives was significantly greater following a front vowel [i] and preceding

<sup>3</sup>As noted by an anonymous reviewer, we may also expect to see ejectivity preserved more often in “i-i” contexts, due to the narrowness of the palatal constriction. Although this study did not

a back vowel [u] (the “i-u” environment) compared to all other vowel environments tested, perhaps due to the supralaryngeal cavity being compressed as the fricative articulation transitions out of a front vowel and into a back vowel, counteracting the loss of supralaryngeal pressure from vented air for the fricative.

This proposal would also predict that when /s'/ is produced with closure, the needed duration of that closure in order to create the necessary supralaryngeal pressure would be shorter in an “i-u” environment. Non-significant trends found in Experiment 1 may suggest that this is the case. When there was closure, the average duration of that closure was numerically shortest in the “i-u”, “a-i”, and “a-a” environments. It is possible the “a-i” and “a-a” environments had even shorter average closure durations than that found in the “i-u” environment due to the low vowel [a] forcing the tongue to start from a position vertically distant from the position needed to make the following fricative constriction and thus perhaps causing a shorter duration overall. If this is the case, we perhaps did not also see greater rates of non-affrication in these “a” environments because the greater vertical distance needed to be covered perhaps causes a non-zero (but shorter) closure once the tongue does reach its target destination.

To summarize, although affrication still occurs in the majority of segments in all environments, vowel contexts where coarticulation effects aid regression of the fricative constriction reduce the duration of closure required to create the necessary supralaryngeal pressure. We believe this indicates a dynamic version of Mechanism 4 mentioned earlier, which states that speakers decrease the supralaryngeal volume to produce ejective fricatives (see §2.2 and Demolin 2002).

Articulation data with high time resolution in a wider variety of vowel contexts would be required to confirm these results. A preliminary ultrasound analysis from one of our participants seems to corroborate Demolin’s findings. Figure 3 shows average tongue trace contours for the midpoint of an alveolar fricative in Tigrinya. Pulmonic /s/ and /z/ are produced with almost identical tongue shapes whereas /s'/ is produced with a backed tongue root, retracting the place of constriction and decreasing the size of the supralaryngeal cavity. We should note that these are preliminary findings derived from one speaker with a small stimulus set, and are only taken at the midpoint of the fricative. Therefore, we do not have time-sensitive information regarding the movement of the tongue over the course of the fricative in various vowel contexts.

---

find evidence for this, it would be interesting to further test this idea.

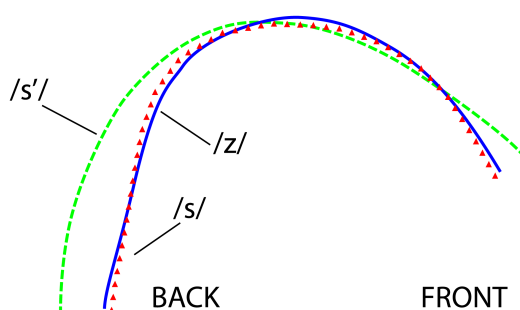

Figure 3: Tongue traces for three alveolar fricatives. Note that the ejective /s'/ (green dashed line) is produced further back than /s/ (red triangles) and /z/ (blue solid).

## 6 Experiment 2: Lexical frequency

The purpose of Experiment 2 is to explore whether lexical frequency plays a role in the rate at which /s'/ is produced as an affricate. Various studies have made different claims regarding the role of frequency in variation. For example, Bybee (2002) finds that the rate of English coronal stop deletion increases with more frequent words, whereas Labov (2011) finds that frequency does not play a role in so-called “g”-dropping (e.g. pronouncing *running* as *runnin'*). Hay et al. (2015) even finds that low frequency words lead a New Zealand vowel shift. The goal of Experiment 2 is to determine which of these three cases the affrication of /s'/ falls into: (1) no correlation between lexical frequency and the affrication of /s'/ (as in “g”-dropping); (2) a positive correlation (as in coronal stop deletion); or (3) a negative correlation (as in the New Zealand vowel shift).

This question is further complicated for an under-resourced language like Tigrinya, since there is no traditional corpus from which to obtain lexical frequencies. This experiment will pull from various available sources to attempt to answer this question, but it should be noted that each of these sources has its drawbacks.

The resource most similar to a traditional corpus that is available for Tigrinya is An Crúbadán (Scannell 2007). An Crúbadán is a web-crawler based corpus which aims to provide text corpora for under-resourced languages such as Tigrinya. Although a valuable source given the lack of resources available for most of the world's languages, it is also a small corpus as far as corpora go, with the Tigrinya database only containing 1.79 million words from 1291 documents (as



compared to 17.9 million words in Celex (Baayen et al. 1993)). In addition, it is primarily based on web documents (e.g. Tigrinya Wikipedia, Tweets in Tigrinya) which often lack a review process and can thus contain numerous errors. This is in comparison to SUBTLEX which is based on American film subtitles, and to Celex, which draws from a variety of sources (newspapers, books, taped phone conversations, etc). Both of these corpora are also edited and therefore more reliable sources of information compared to the unedited An Crúbadán.

Even with An Crúbadán, there were no entries for the majority of test items, and therefore no information regarding the lexical frequency for these items (an indication that the Tigrinya corpus from An Crúbadán is too small for our purposes). Therefore, the possibility of using lexical recognition time as a predictor of lexical frequency was considered for this study. This is in light of previous studies which have shown that the time it takes to decide whether a string of letters is an actual word or a nonce word is correlated with lexical frequency in German (Brysbaert et al. 2011) and in English (Baayen et al. 2006). In fact, Murray & Forster (2004) go so far as to say “[o]f all the possible stimulus variables that might control the time required to recognize a word pattern, it appears that by far the most potent is the frequency of occurrence of the pattern.”

Words whose frequencies were known from An Crúbadán were included among test stimuli and served as “quality control” items to determine whether the collected reaction times for Experiment 2 were at all indicative of lexical frequency. If a strong correlation between recognition time of these items and their frequencies in An Crúbadán were found, this would indicate that recognition time could be used as a rough measure of frequency for those studying under-resourced languages. This would be a valuable tool for linguists working with languages where only small corpora (if any) are available.

Before detailing the methodology of Experiment 2, the authors would like to note that there are a number of complications that greatly affect the interpretability of the results of this experiment, which have been noted by reviewers and other readers of this paper. These will be discussed in §6.4 Despite these weaknesses, we felt it was important to still include this experiment here; less for its difficult-to-interpret results, but more to add to the methodological discussion of how linguists might study under-resourced languages, for which the particular piece of information needed to test some theory may not be available. We hope that this experiment will aid future researchers who may also be considering what options may be available to them when certain information is simply not available for a given language.

## 6.1 Methodology

Experiment 2 consisted of 2 parts. Part 1 was a Go/No-go word recognition task to determine lexical frequency indirectly through reaction times. Part 2 followed Part 1 and consisted of a reading task identical in procedure to that used in Experiment 1.

### 6.1.1 Stimuli

Stimuli for the Go/No-go task consisted of a mixture of 83 real Tigrinya words and 30 viable nonce words, totaling 113 test items. All stimuli words were orthographically represented with three characters in the Ethiopic script, making them either two or three syllables.

1. **Target Words, word-initial /s'/** ( $N=15$ , e.g. ጸሃየ /s'ehaje/): Actual words in Tigrinya which begin with /s'/.
2. **Target Words, word-medial /s'/** ( $N=14$ , e.g. ሃጸይ /has'ejɪ/): Actual words in Tigrinya which have /s'/ word-medially.
3. **/tʃ'/ Words** ( $N=24$ ): Actual words with /tʃ'/ word-initially or word-finally. Due to space constraints, these words will not be discussed in the current paper.
4. **Frequency Check Words** ( $N=30$ ): Actual words in Tigrinya for which we have rough frequency estimates for from the small web-crawler corpus, An Crúbadán.
5. **Nonce Words** ( $N=30$ , e.g. ራሲካ /rasika/): Nonwords that are phonotactically-legal in Tigrinya.

### 6.1.2 Procedure

#### 6.1.3 Go/No-go task

The goal of Part 1 of Experiment 1 was to obtain indirect lexical frequencies via reaction time with a Go/No-go lexical decision task. Stimuli were presented to participants with Psychopy (Peirce 2007). Participants were asked to press the space bar (“go”) only if the string was a real word as quickly as possible. For each trial, the orthographic representation of the stimuli was shown on the screen for a maximum of 3 seconds. If the participant pressed the spacebar on the keyboard or 3 seconds had passed with no response (“no-go”), a black rectangle appeared

on the screen for 3 seconds, and the next word would appear. If the spacebar was pressed, the time since the beginning of the trial was recorded. The participants' view is displayed in Figure 4.

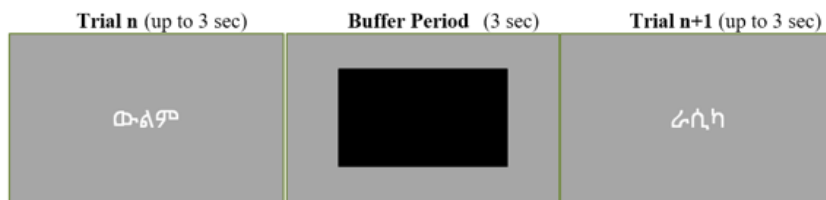

Figure 4: Presentation of stimuli in the Go/No-go task

Participants were first given a demo and instructions in English. They were shown actual English words (e.g. *find*), as well as nonce words (e.g. *skeep*, *glarp*). Some of the actual words were borrowed words (e.g. *pasta*). For all real words, participants were asked to press the spacebar as quickly as possible, and were told this even applied to words which were borrowed (e.g. *pasta*), but to not press the spacebar if the word was not an actual English word. Following the English demo, participants were directed to Part 1 of Experiment 2, which was identical in procedure to the English demo except words were Tigrinya words written in the Ethiopic script. For this portion, participants were given 6 warm-up words which were not included in the analysis, followed immediately by 113 test words, with no break between the warm-up and test trials.

#### 6.1.4 Production task

Part 1 was followed by Part 2, in which experimenters recorded participants producing the 29 Target Words. All of these words consisted of the 29 actual words containing /s'/ in Part 1. For the sake of consistency, the procedure in Part 2 was identical to the procedure used in Experiment 1.

## 6.2 Analysis

The analysis for Experiment 2 used the same criteria for marking the five landmarks introduced in Experiment 1 (§5.2). As was the case in Experiment 1, if a participant repeated a frame sentence, only the latest repetition was used in the analysis. Word-initial [s'] items were excluded from the analysis if there was a pause before the word, as we would be unable to determine whether there had been a period of closure following the pause.

### 6.3 Results

To determine whether any relationship exists between lexical frequency and affrication, lexical recognition time and closure duration were plotted (Figure 5). No correlation was found between reaction time and closure duration ( $r = 0.06$ ). This suggests that no relationship exists between affrication and lexical frequency as predicted by reaction time.

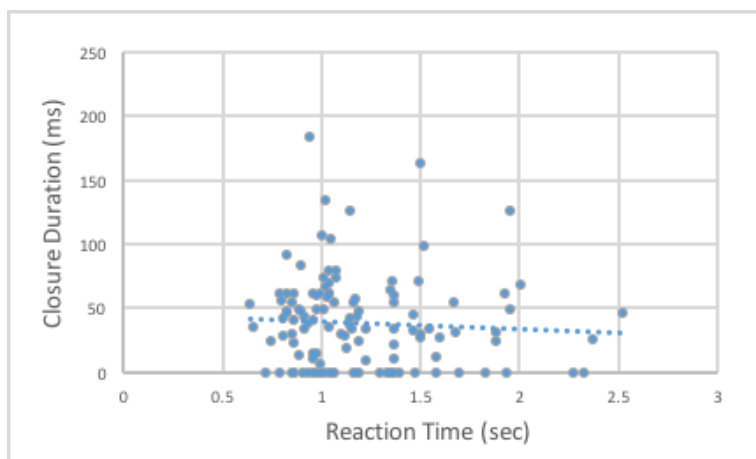

Figure 5: No or very slight negative correlation was found between closure duration and reaction time ( $r = -0.061$ ).

One goal of this study was also to determine whether lexical recognition time could reliably be used as a predictor of lexical frequency, by analyzing the words for which we had a rough measure of frequency from An Crúbadán. The natural logarithm of the frequencies of the Frequency Check words is plotted against participant reaction times in Figure 6. A weak but significant correlation ( $r = -0.187$ ,  $p = 0.002$ ) was found between these two variables. For comparison, previous word recognition studies have found correlations between  $r = -0.2$  and  $r = -0.4$  (Brybaert et al. 2011), suggesting that our results fell towards the lower bound of correlation values found between lexical frequency and reaction times.

### 6.4 Discussion

While results of Experiment 2 suggest that there is no correlation between reaction time and closure duration, unfortunately due to limitations in language resources, this result could indicate several things. Some weaknesses of Experiment 2 will be discussed here.

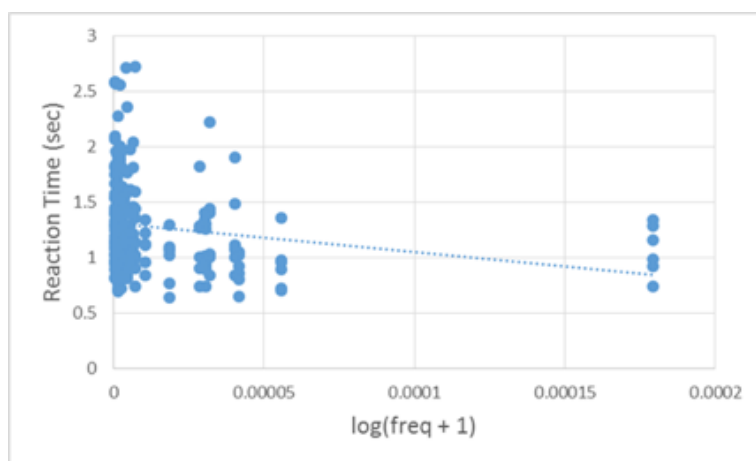

Figure 6: Results of the Frequency Check words. Reaction time and lexical frequency are weakly negatively correlated with one another.

Results could simply show that lexical frequency, as measured indirectly through a Go/No-go task, is not correlated with closure duration. This would place the closure duration of an affricated /s'/ with “g”-dropping in English, which was also found to have no effect of lexical frequency (Labov 2011).

Frequency Check words had been included to determine whether we were indeed indirectly measuring lexical frequency. The frequencies of Frequency Check words showed a very weak correlation with reaction times. With a Pearson’s  $r$  of only  $-0.187$ , any possible correlation might just not be strong enough to use reaction time as an indirect measure of frequency.

It is also possible that this study did not accurately capture reaction times, either due to flaws in methodology, or due to the small number of participants. For example, the average reaction time among our participants was 1380 ms in contrast to average reaction times between 618–985 ms in other reaction time studies (Brysbaert et al. 2011). It is possible that a difference in the average age of participants played a role here. Whereas past studies with results averaging between 618–985 ms were performed with undergraduate participants presumably between the ages of 18–22, our participants ranged from 20–60 years in age with an average age of 42. Human reaction times have been shown to steadily decrease beginning at the age of 20 (Pierson & Montoye 1958), possibly accounting for the difference in reaction time compared with previous studies.

Then again, as noted earlier, An Crúbadán is a small corpus and is only based on words written online. Therefore, An Crúbadán may not even accurately reflect true lexical frequencies in speech, which may be the reason for the low  $r$  value.

## 7 Conclusion

In Experiment 1, we found that a greater proportion of /s'/ is produced as [s'] when it follows [i] and precedes [u]. We believe this environment naturally facilitates ejective fricatives due to decreasing volume of the supralaryngeal cavity. If true, this would further predict that an “i-u” context also aids other ejectives or voiceless phones, and perhaps that the opposite environment “u-i” aids voiced and implosive sounds.

It was hoped for Experiment 2 that indirectly measuring lexical frequency with reaction times would give linguists studying under-resourced languages another tool for calculating lexical frequency, but multiple weaknesses of Experiment 2 do not allow us to draw any firm conclusions regarding the nature of a possible relationship between affrication and lexical frequency, or even regarding the usefulness of using reaction time as an indirect measure of lexical frequency.

## Acknowledgements

We would like to thank the native speaker consultants for participating in our study and the Eritrean Community Association in Raleigh, NC, as well as David Mora-Marin, Elliott Moreton, Jennifer Smith, and two anonymous reviewers for their helpful comments and suggestions. All errors are of course our own. We would also like to thank Jeff Mielke and the North Carolina State University Phonology Lab for helping us use and allowing us to borrow their ultrasound machine. Special thanks to Ruth Tesfalidet and Tsegga Medhin for helping us choose and create stimuli, and for helping us recruit participants.

## References

- Baayen, R. Harald, Laurie Feldman & Robert Schreuder. 2006. Morphological influences on the recognition of monosyllabic monomorphemic words. *Journal of Memory and Language* 55(2). 290–313.
- Baayen, R. Harald, Richard Piepenbrock & H. van Rijn. 1993. *The CELEX lexical data base on CD-ROM*.
- Boersma, Paul & David Weenink. 2013. *Praat: Doing phonetics by computer (version 5.3.41)*.
- Brysbaert, Marc, Matthias Buchmeier, Markus Conrad, Arthur Jacobs, Jens Bölte & Andrea Böhl. 2011. The word frequency effect: A review of recent developments and implications for the choice of frequency estimates in German. *Experimental Psychology* 58(5). 412.

- Bybee, Joan. 2002. Word frequency and context of use in the lexical diffusion of phonetically conditioned sound change. *Language Variation and Change* 14(03). 261–290.
- Demolin, Didier. 2002. The search for primitives in phonology and the explanation of sound patterns: The contribution of fieldwork studies. *Laboratory Phonology* 7 4(1). 455.
- Hay, Jennifer, Janet Pierrehumbert, Abby Walker & Patrick LaShell. 2015. Tracking word frequency effects through 130years of sound change. *Cognition* 139. 83–91.
- Labov, William. 2011. *Principles of linguistic change, cognitive and cultural factors*. Vol. 3. Hoboken: John Wiley & Sons.
- Ladefoged, Peter. 1993. *A course in phonetics*. Boston, MA: Thomson Wadsworth.
- Lewis, M. Paul, Gary F. Simons & Charles D. Fennig. 2016. *Ethnologue: Languages of the world*. 19th edn. Dallas, Texas: SIL International.
- Maddieson, Ian. 1997. Combining frication and glottal constriction: two solutions to a dilemma. *Journal of the Acoustical Society of America* 102(5). 3135.
- Maddieson, Ian. 1998. Why make life hard? Resolutions to problems of rare and difficult sound types. In *Annual Meeting of the Berkeley Linguistics Society*, vol. 24, 367–380.
- Maddieson, Ian & Kristin Precoda. 1990. Updating UPSID. *UCLA working papers in Phonetics* 74. 104–111.
- Maddieson, Ian, Caroline L. Smith & Nicola Bessell. 2001. Aspects of the phonetics of Tlingit. *Anthropological Linguistics* 43(2). 135–176.
- Murray, Wayne & Kenneth Forster. 2004. Serial mechanisms in lexical access: The rank hypothesis. *Psychological Review* 111(3). 721.
- Peirce, Jonathan. 2007. PsychoPy—Psychophysics software in Python. *Journal of Neuroscience Methods* 162(1). 8–13.
- Pierson, William & Henry Montoye. 1958. Movement time, reaction time, and age. *Journal of Gerontology* 13. 418–421.
- Scannell, Kevin. 2007. The Crúbadán project: Corpus building for under-resourced languages. In *Building and Exploring Web Corpora: Proceedings of the 3rd Web as Corpus Workshop*, vol. 4, 5–15.
- Shosted, Ryan & Sharon Rose. 2011. Affricating ejective fricatives: The case of Tigrinya. *Journal of the International Phonetic Association* 41(1). 41–65.
- Tewelde, Yohannes Tesfay. 2002. *A modern grammar of Tigrinya*. Rome: U. Detti.





## Chapter 16

# Between tone and stress in Hamar

Sara Petrollino

Laboratoire Dynamique Du Langage, Lyon and Leiden University

This paper provides a preliminary description of the word-prosodic system of Hamar, a South Omotic language spoken in South West Ethiopia. The prosodic system of Hamar shows properties of both stress accent and tone: accent is lexically contrastive in nouns, but not in verbs, where it has a grammatical function. Post-lexical tonal oppositions arise when lexical accent and grammatical accent interact in both nouns and verbs. The prosodic behaviour of Hamar nouns and verbs is in line with the pattern proposed by Smith (2011), whereby nouns are higher than verbs in a hierarchy of phonological privilege.

### 1 Introduction

Hamar is spoken in South-West Ethiopia by approximately 47,500 people (Simons & Fennig 2017) and it is commonly classified within the South Omotic branch of the Omotic family. The internal and external classification of Omotic is still unsettled and the affiliation of South Omotic languages to either the Afro-Asiatic or the Nilo-Saharan phylum is debated, see Zaborski (2004), Blažek (2008), Bender (2000; 2003), Hayward (2003), Fleming (1974), and Azeb (2012). The Hamar live in the lower Omo valley, in the Ethiopian administrative zone referred to as Southern Nations, Nationalities, and People's region (SNNPR). The neighbours of the Hamar are the Aari people to the north (Aari is a South Omotic language), the Arbore (Lowland East Cushitic) to the east, the Dhaasanac (Lowland East Cushitic) to the south, the Nyangatom (Eastern Sudanic, Nilotic) and the Kara (South Omotic) to the west. Hamar, together with Banna and Bashadfa, forms a linguistic unit which is usually referred to as the Hamar-Banna cluster. The three languages are mutually intelligible and show only minor variations in the lexicon and in the phonology. This paper presents a preliminary description of the



word-level prosodic system of the Hamar variety, and it is based on the analysis of circa 200 Hamar words uttered in isolation and in context. These have been extracted from a larger corpus of first-hand data collected in Hamar territories between 2013 and 2014 for the compilation of the Hamar grammar, see Petrollino (2016).<sup>1</sup> An overview of the main phonological features of Hamar is given in §2; the word-prosodic system is illustrated in §3, followed by concluding remarks in §4.

## 2 Phonological preliminaries

Hamar displays phonological features which are typical of the “Ethiopian Linguistic Area”, such as the implosive /d/, the ejective consonants and the replacement of /p/ with /f/ (or vice versa) (Ferguson 1970; 1976; Crass & Meyer 2008). Various assimilatory processes attested in neighbouring Omotic and Cushitic languages, such as translaryngeal harmony and sibilant harmony (Hayward 1988) occur also in Hamar. Sibilant harmony in Hamar is a root-structure condition but it extends also across morpheme boundaries; the sibilant consonants in a word do not need to be identical but must agree in place of articulation. The word-prosodic system of Hamar is not uncommon among Omotic and Cushitic languages, even though these language families show great variation in terms of prosodic systems (see Mous 2012 and Azeb 2012 for a Cushitic and Omotic overview). According to Azeb (2012: 438) the languages located in the southern and eastern parts of the Omotic area are characterised by “pitch-accent” systems, while highly tonal systems are usually found in the northern and western parts (Bench, for instance, is an Omotic language with five level tones and a rising tone, see Rapold 2006).

This section offers an overview of the phonemic inventories, including vowel realization §2.1, and the syllable structure §2.2 of Hamar. Hamar examples are written in a surface-phonemic transcription. The following modifications to the International Phonetic Alphabet have been adopted: /j/ for the palato-alveolar affricate [tʃ]; /c/ for the voiceless palato-alveolar [tʃ̥]; /c'/ for the palato-alveolar ejective affricate [tʃ̥']; /y/ for the glide [j]; /h/ for the breathy-voiced glottal approximant [ɦ]; /sh/ for the palato-alveolar [ʃ]. Long vowels and geminated consonants are indicated by doubling the vowel or the consonant symbol. Word initial

---

<sup>1</sup>For the phonological analysis, speakers were asked to repeat three tokens of each word in isolation and in carrier phrases. Some of the speakers were used to utter words in sequence as if they were individual, separate utterances, and words in isolation were always compared to words uttered in carrier phrases in order to exclude list intonation.

glottal stop is not written in surface-phonemic transcription. An asterisk \* is used for ungrammatical forms and unattested stages, whereas the diacritics *´* and *ˆ* indicate high and falling pitch, respectively. The absence of a diacritic on vowels indicate accent-less vowels and syllables, which are usually realized with a low pitch. On consecutive (long) vowels, however, the high pitch is written only on the first vowel, i.e. /*´v*/ is realized as [*´v´*] and not as [*´vˆ*].

## 2.1 Phonemic inventories

The phonemic inventory of Hamar has 26 consonant phonemes (Table 1), seven vowel qualities (Table 2) and five diphthongs (/ai/, /au/, /ei/, /oi/, /ia/). The voiceless bilabial, alveolar and velar stops are aspirated in word initial position, but aspiration is not phonemic. The velar implosive /*g*/ is marginal as it occurs only in the lexeme *gíá* ‘hit’ where it contrasts with the velar stop /*g*/ in the lexeme *giá* ‘tell’. Ejective consonants cannot be geminated. The glides /w/, /y/, /ʔ/, /h/ form a natural class in that they undergo the same morpho-phonological rule and get deleted in specific contexts. Consonant gemination is distinctive (1) and it can arise grammatically (2):

- (1) a. *kumá*           ‘drink milk’  
       b. *kummá*       ‘eat’
- (2) a. *raatá*           ‘sleep’  
       b. *rattá*           ‘make sb. sleep’ (causative derived form)<sup>2</sup>  
       c. *afála*         ‘blanket’  
       d. *afállá*        ‘blankets’ (blanket:PL)

Vowel quantity is also distinctive as illustrated in (3). Vowel length is further discussed in §3.1.

- (3) a. *éna*            ‘past’  
       b. *éena*         ‘people’  
       c. *gobá*         ‘run’  
       d. *goobá*        ‘decorate’

Vowel realization can be affected by accent. Word-final unaccented vowels can be devoiced or partially devoiced depending on the rate of speech and on whether they occur in utterance-final position:

<sup>2</sup>The vowel shortening in *rattá* occurs to avoid CVVC.CV word structure, see section §2.2

Table 1: Consonant phonemes

	Bilabial	Alveolar	Palato-alveolar	Velar	Uvular	Glottal
Stops	p <sup>a</sup> b	t d	c j	k g	q	
Implosives	ɓ	ɗ		(ɠ)		
Ejectives		t'	c'			
Fricatives		s z	ʃ	x		
Nasals	m	n	ɲ			
Liquids		l, r				
Glides	w		y			h,ʔ

<sup>a</sup>The bilabial stop /p/ can be realized as [p] or [ɸ] (a common feature found in the languages of Ethiopia): a word like /payá/ 'good' can be realized as [payá] or [ɸayá], thus both p and f will be used in surface-phonemic transcriptions.

Table 2: Vowel phonemes

	Front	Central	Back
high	i ii		u uu
mid-high	e ee		o oo
mid-low	ɛ εε		ɔ ɔɔ
low		a	

(4) *róqo* 'tamardind tree' [róqo] or [róqo]

Word-final accented vowels can be phonetically breathy:

(5) *meté* 'head' [meté] or [meté<sup>h</sup>]

The mid-low vowels are phonemic as illustrated in the minimal pair below:

(6) a. *edá* 'luck'  
 b. *edá* 'separate'

Mid-low vowels, however, can also be in complementary distribution with the mid-high vowels /e/ and /o/: except for some idiosyncratic exceptions illustrated in (10) and (11), accented mid vowels followed by the low vowel /a/ are usually realized as mid-low, see (7a) and (8a); unaccented mid vowels are not affected by

the following low vowel /a/ and they are realized as mid-high, see (7b) and (8b) below:

- (7) a. *dóya* 'bone marrow'  
 b. *doyá* 'show'

- (8) a. *yéla* 'roof'  
 b. *yedá* 'hold'

The relationship between mid vowels and accent cannot always be used as a cue to determine the location of stress in a given word since there are several exceptions to the pattern illustrated in the examples above. First of all, the realization of mid vowels can vary across speakers and within the same speaker's speech: in (9a) and (9b) below, for instance, there is free variation and none of the two realizations is preferred over the other.

A few words (less than ten items) have an idiosyncratic pronunciation and allow accented mid-high vowels followed by the low vowel /a/ (10), or vice versa, unaccented mid-low vowels (11):

- (9) a. *kéda* 'then' [kéda], [kéda]  
 b. *oshála* 'after two days' [ʔofála], [ʔɔfála]

- (10) a. *cóobar* 'down there' [tʃó:bar]  
 b. *zéega* 'bird of prey sp.' [zé:ga]

- (11) *edá* 'luck' [ʔedá]

Mid-low vowels have a high functional load since they arise grammatically. The realization of masculine gender, for instance, can be signalled by the presence of mid-low vowels:

- (12) a. *segeré* 'dik-dik' (non inflected form)<sup>3</sup>  
 b. *segerê* 'male dik-dik' (dik-dik:M)

<sup>3</sup>Hamar nouns can be marked for gender depending on the syntactic context and on the semantic functions. This means that nouns can be marked for gender, as in (12b) and (13b) but they can also be used in the uninflected form, which is non-specific for gender. This is called "general form" and it corresponds to the citation form of nouns, see Petrollino (2016) for further details.

- (13) a. *zóbo* 'lion' (non inflected form)  
 b. *zɔbô* 'male lion' (lion:M)

In the examples above, the masculine suffix *-â* merges with the final vowel of the noun and triggers lowering of root-internal mid-high vowels. More examples of nouns marked for masculine gender can be found in section §3.2.

## 2.2 Syllable structure

Hamar nouns and verbs are mainly disyllabic. Trisyllabic words are more rare. There are four possible syllable types: CV, CVV<sup>4</sup>, CVC and CVVC. The latter is found only in monosyllabic nouns, and in order to avoid CVVC.CV word types, the long vowel of CVVC nouns is shortened when inflectional and derivational suffixes are attached, see example (2b) above and (14) and (15) below.

- (14) *áan* 'arm' \*aan-ta > *antâ* 'arm:M'  
 (15) *yíir* 'upper arm' \*yiir-na > *yírna* 'upper arm:PL'

Onsetless syllables and consonant clusters in onset or in coda position are not permitted. Recall that glottal stop in word-initial position is not written, thus the noun for 'arm' in (14) has a CVVC structure. Geminate consonants are ambisyllabic segments filling the coda of a syllable and the onset of the following syllable:

- (16) *qul.lá* 'goats' (goat:PL)

Closed syllables tend to end in a sonorant consonant. Obstruent segments in coda position are rare and are found in monosyllabic words or in word final syllables. If consonant clusters arise where an obstruent occurs as the first segment of the cluster, metathesis and assimilation rules apply, see the examples below in which the plural marker *-na* is suffixed to consonant-final nouns:

- (17) *atáb* 'tongue' \*atáb-na > *atám̩ba* 'tongue:PL'  
 (18) *c'agáj* 'green' \*c'agáj-na > *c'agáɲa* 'green:PL'

---

<sup>4</sup>Long vowels are restricted to the first syllable of a word, but the behaviour of accent (discussed in the next section) does not allow a trochaic analysis. Further investigation into vowel distribution is needed in order to better understand foot structure.

### 3 Word prosody

This section outlines the prosodic properties of Hamar nouns and verbs. Accented syllables in both nouns and verbs are obligatory and culminative (19). These properties, together with the fact that the syllable, rather than the mora, is the TBU (20), correspond to the definitional characteristics of stress accent (Hyman 2006: 231). However, the Hamar word-prosodic type can be analysed also as a tone system after Hyman's broad definition (2001), whereby "an indication of pitch enters into the lexical realisation of at least some morphemes" (Hyman 2001: 1367). Accent in Hamar has both lexical and grammatical functions; grammatical functions are observable in particular in some verbal inflections and in masculine nouns. The interaction between lexical and grammatical accent is discussed in §3.3.

#### 3.1 Prosodic properties of nouns and verbs

There is only one prominent syllable per word in Hamar (19a, 19b), and accentless words are not attested (19c):

- (19) a.  $\acute{\sigma}.\sigma$  ,  $\sigma.\acute{\sigma}$   
 b.  $*\acute{\sigma}.\acute{\sigma}$   
 c.  $*\sigma.\sigma$

Prominent syllables are perceptually louder, longer and with a higher pitch than neighbouring syllables; instrumental measurements show increased values for F0, duration and intensity on accented syllables. Long vowels, which can be distinctive as shown in example (3) above, carry one and the same pitch: rising or falling pitches are not attested on long vowels (20).

- (20) a. *háada* [háádà] 'rope'      \*[háàda] \*[háàda]  
 b. *zíini* [zíini] 'mosquito'  
 c. *déer* [déér] 'red'  
 d. *doobí* [dòòbí] 'rain'

The measurements given in Table 3 below show that phonemically long vowels are phonetically long, and long vowels are phonetically longer than short vowels in accented syllables. VL1 in Table 3 refers to the vowel length of the first syllable measured in seconds. The unaccented long vowel in *goobá* 'decorate' is longer than the short accented vowel in *góro* 'Colobus monkey'.<sup>5</sup>

<sup>5</sup>The words were elicited in isolation and the speakers were asked to repeat three tokens of each word. The examples in Table 3 report the measurements of the first tokens.

Table 3: Vowel length measurements

Word	Meaning	VL1
<i>góro</i>	Colobus monkey	0.091
<i>gobá</i>	run	0.070
<i>góodo</i>	termite eater	0.151
<i>goobá</i>	decorate	0.130

The position of the accent is not sensitive to syllable weight: the heavy syllables CVV and CVC in the bisyllabic words in (21) do not always attract accent.

- (21) a. *shaa.lá* 'ceiling'  
 b. *zí.ga* 'spinal cord'  
 c. *síl.qa* 'knuckle'  
 d. *gur.dá* 'village'

In trisyllabic nouns accent is found on the antepenultimate, penultimate and final syllable:

- (22) a. *gé.da.qa* 'plant sp.'  
 b. *gu.gá.na* 'lightning'  
 c. *gi.gi.rí* 'molar teeth'

Accent in nouns is thus unpredictable and lexically distinctive:

- (23) a. *átti* 'bird'      *attí* 'fermented sorghum'  
 b. *hámmo* 'field:F'      *hammó* 'which:F'  
 c. *ásho* 'slope'      *ashó* 'plant sp.'
- (24) a. *ánqasi* 'bee'      *anqási* 'lamb'  
 b. *shékini* 'quartz'      *shekíni* 'beads'  
 c. *bagáde* 'loin'      *bagadé* 'cooked blood'

Suffixation of nominal markers, such as the plural marker *-na* or the feminine gender marker *-no*, does not affect accent placement even when suffixation results in longer words:



- (25) a. *meté* 'head'    *meté-na* 'head-PL'  
 b. *kárc'a* 'cheek'    *kárc'a-na* 'cheek-PL'  
 c. *góro* 'monkey'    *góro-no* 'monkey-F'  
 d. *qulí* 'goat'    *qullá* 'goat:PL'

In the plural noun *qullá* in example (25d), the plural marker *-na* does not attach to the terminal vowel of the noun *qulí*, but it is suffixed directly to the root, assimilating to the preceding liquid segment (\**qul-na*).<sup>6</sup> The position of the accent thus does not change in the case of assimilation, metathesis, or other phonological processes.

Different from nouns, accent is not lexical in verbs. Hamar verb roots are accent-less but they always occur with verbal suffixes which bear the culminative accent on the verbal word. This means that the accent is always found on the verbal suffix and never on the verb root. The singular addressee of the imperative mood for instance is formed by suffixing *-á* to the verb root. This form is also used as the citation form of the verb. Prominence is therefore found on the right-most edge of the citation form of any verb:

- (26) a. CV.CV́    *pug-á*    'blow!' (blow-IMP.2SG)  
 b. CVC.CV́    *ashk-á*    'do!' (do-IMP.2SG)  
 c. CV.CVC.CV́    *ukuns-á*    'rest!' (rest-IMP.2SG)

The final accented *-á* of the citation form of the verb can be substituted with other verbal suffixes of different syllabic structure:

- (27) a. *pug-é*    'blow!' (blow-IMP.2PL)  
 b. *ashk-íma*    'without doing' (do-NEG.SUB)  
 c. *ukuns-énka*    'while resting' (rest-CNV)  
 d. *bul-idí*    'opened' (open-PF)  
 e. *gob-áise*    'running' (run-SUB)

Verbal suffixes cannot be combined: a single verb word cannot contain more than one verbal suffix. Adding pronominal subject clitics to the verb word does not affect accent placement, cf. (27a) with (28a) and (27c) with (28b):

<sup>6</sup>This phonological rule occurs when the terminal vowels of nouns are not stable. Terminal vowels in Hamar (and in other Omotic languages) can be "unstable" in the sense that they can be dropped and ignored with the suffixation of some morphemes. Stable and unstable terminal vowels determine different types of nominal declensions in Hamar (see Petrollino 2016: 73-77; Hayward 1987 and Azeb 2012 for terminal vowels in Omotic languages).

- (28) a. *ko=pug-é* 'let her blow!' (3F=blow-JUSS)  
 b. *kon=ukuns-énka* 'while she rested' (3F=rest-CNV)

Some verbal tenses are distinguished only by accent placement: cf. the negative past in (29) with the negative present in (30).

- (29) a. *qan-átine* 'I did not hit' (hit-PAST.NEG.1SG)  
 b. *qan-átane* 'You did not hit' (hit-PAST.NEG.2SG)

- (30) a. *qan-atíne* 'I do not hit' (hit-PRES.NEG.1SG)  
 b. *qan-atáne* 'You do not hit' (hit-PRES.NEG.2SG)

The inflectional verb suffix used in the third person of the negative present is realized with a final falling pitch *-ê*: this contrasts with the final accent of the imperative mood which is realized with a high pitch:

- (31) a. *pug-é* 'blow!' (blow-IMP.2PL)  
 b. *pug-ê* 'he/she does not blow' (blow-PRES.NEG.3)
- (32) a. *qan-é* 'hit!' (hit-IMP.2PL)  
 b. *qan-ê* 'he/she does not hit' (hit-PRES.NEG.3)
- (33) a. *ukuns-é* 'rest!' (rest-IMP.2PL)  
 b. *ukuns-ê* 'he/she does not rest' (rest-PRES.NEG.3)

The negative suffix *-ê* is found also in the negative copula which contrasts with the locative case (34); a similar opposition is found in the negative existential predicator which contrasts with its interrogative counterpart (35):

- (34) a. *tê* 'is not'  
 b. *te* 'inside'
- (35) a. *qolê* 'there is not'  
 b. *qóle* 'where is?'

There are a few verb-noun pairs which can be distinguished only prosodically. This contrast is illustrated in (36) and (37): the citation form of the verb has always final accent, whereas in the segmentally identical noun accent falls on the first syllable. These examples are important to understand the interaction between grammatical and lexical accent in Hamar, and will be re-proposed later on in §3.3:

- (36) a. *qaná* 'hit!'  
 b. *búlá* 'jump!'

- (37) a. *qána* 'stream'  
 b. *búla* 'egg'

The examples illustrated so far show that accent is unpredictable and lexical in nouns as shown in (21), (23), (24). The accentual system of Hamar verbs, on the other hand, is more predictable as accent is found always on function morphemes. The examples in (27), (29) and (30) show the functional load of accent on verbs. Imperative and negative verbs, moreover, display an opposition between high and falling pitch on the last syllable (31).

### 3.2 Masculine nouns

It was illustrated earlier that feminine gender and plural number suffixes do not affect the position of the accent, see examples under (25) above. Different from the feminine and the plural suffixes, the masculine suffix *-â* affects the prosody of the word as well as the realization of the vowels: nouns marked by masculine gender are realized with a falling pitch on the final vowel as shown in (38); the masculine gender marker *-â*, moreover, triggers height harmony, lowering the mid-high vowels /e/ and /o/ (39). The lowering of the mid-high vowels in (39) is the same morpho-phonological rule which was introduced in §2.1 for examples (12b) and (13b).

- (38) a. *bankár* 'arrow'      *bankarâ* 'arrow:M'  
 b. *jagá* 'sparrow'      *jagâ* 'sparrow:M'      [dʒa'gâ]  
 c. *qása* ['qása] 'louse'      *qasâ* 'louse:M'      [qa'sâ]  
 d. *hápa* ['hápa] 'sheep'      *hapâ* 'sheep:M'      [ha'pâ]

- (39) a. *ási* 'tooth'      *asê* 'tooth:M'  
 b. *ooní* 'house'      *ɔonê* 'house:M'  
 c. *meté* 'head'      *metê* 'head:M'

The final falling pitch of masculine nouns is clearly audible when nouns are uttered in isolation or before a pause. The difference can however be lost in connected and allegro speech, so the falling pitch of masculine nouns is sometimes

realized as a final high pitch. Tokens of the same masculine noun in connected speech can be uttered with both a final falling pitch or a final high pitch, so the final falling pitch on masculine nouns cannot be analysed as a final high tone followed by a low boundary tone before a pause.

On the prosodic level there are two possible outcomes for nouns marked by masculine gender. If the uninflected noun has lexical accent on the final syllable, the derived masculine noun is realized with a final falling tone as in (38a, 38b), (39b, 39c). In nouns with lexical accent on the first syllable, prominence shifts to the final syllable, and a falling tone is realized on the final vowel of nouns such as those in (38c, 38d) and (39a) above. This outcome is summarized below:

- (40) a. CV:CŨ > CV:CŨ̂  
 b. 'CŨ.CV > CV:CŨ̂

Example (40a) shows a high vs. falling opposition on the last syllable, whereas (40b) shows a low vs. falling opposition on the last syllable. In masculine nouns which follow the pattern in (40), grammatical accent is culminative and obligatory; however, not all nouns follow this pattern, and exceptions to culminativity can be attested when the grammatical accent interacts with the lexical accent of nouns. These interactions are described in the following section.

### 3.3 Interaction between lexical and grammatical accent

Nouns with lexical accent on the first syllable, like those schematised in (40b) can show variation in the prosodic realization of the masculine form. When inflected, nouns like *qása* in (38c) or *hápa* in (38d) can retain their lexical accent on the first syllable together with the grammatical accent of the masculine suffix. In other words, the outcome for CŨ.CV nouns can be CV:CŨ̂ or CŨ̂.CŨ̂ after suffixation of the masculine gender marker. The variation is highly irregular and it is attested across speakers and within the same speaker's speech. Nouns like those in (41) do not constitute a special class of nouns; they rather belong to the most common nominal declension which represents the majority of Hamar nouns, see Petrollino (2016: 74).

- (41) a. *qasâ*                    'louse:M'            [qà'sâ] or [qá'sâ]  
 b. *hapâ*                    'sheep:M'           [hà'nâ] or [há'nâ]  
 c. *bulâ*                    'egg:M'             [bù'lâ] or [bú'lâ]

The realization of the lexical accent on the first syllable of masculine nouns can be fundamental to distinguish nominal stems from nominalized stems. The

masculine suffix *-â*, in fact, can be suffixed also to verb roots to form relativized nouns with masculine agreement. Since verb roots are always accent-less, masculine relativized verbs always result as CV.C $\hat{V}$  words:

- (42) a. *qaná* 'hit!'      *qaná* 'the one (M) who hits'      [qà'nâ]  
 b. *bulá* 'jump!'      *bulâ* 'the one (M) who jumps'      [bù'lâ]

Nominalized verbs with masculine agreement pattern like nouns with lexical accent on the final syllable, see Table 4 below: uninflected nouns in the first column are paired with the respective masculine form in the second column; verbs are paired with their masculine nominalized form. Both nouns and verbs display a H vs. HL opposition on the final syllable:

Table 4: Tonal opposition 1

	C $\hat{V}$ .'C $\acute{V}$	C $\hat{V}$ .'C $\hat{V}$
nouns	<i>jagá</i> 'sparrow' <i>mirjá</i> 'kudu'	<i>jagâ</i> 'sparrow:M' <i>mirjâ</i> 'kudu:M'
verbs	<i>pugá</i> 'blow!' <i>qaná</i> 'hit!'	<i>pugâ</i> 'the one (M) who blows' <i>qaná</i> 'the one (M) who hits'

When the masculine marker *-â* is suffixed to nouns and verbs which are segmentally identical, such as those in (36) and (37) above, a H or a L tone on the first syllable of the noun/verb root plays a crucial distinctive role: the nominalized verb always has a L.HL melody, whereas the segmentally identical masculine noun is realized as H.HL. Contrast is maintained between segmentally identical nouns and verbs through the accent (tone) system, so these noun/verb pairs show a H vs L tonal opposition on the first syllable as illustrated in Table 5.

Table 5: Tonal opposition 2

C $\acute{V}$ .'C $\hat{V}$	C $\hat{V}$ .'C $\hat{V}$
<i>qaná</i> 'stream:M' [qánâ] <i>bulá</i> 'egg:M' [búlâ]	<i>qaná</i> 'the one (M) who hits' [qànâ] <i>bulâ</i> 'the one (M) who jumps' [bùlâ]

## 4 Conclusions

The Hamar prosodic system represents an “intermediate” type in Hyman’s word-prosodic typology (Hyman 2006; 2009), in the sense that it displays properties of both stress and tone. On nouns and verbs accent is culminative and obligatory, showing stress-like properties. Accent is lexically contrastive in any word position in nouns, whereas it is grammatical in verbs. Tone-like properties can be observed in the verbal domain, where a H vs. HL opposition is found on the last syllable of the imperative and negative form of the verb (31), but also when the grammatical accent of the masculine gender marker interacts with the lexical accent of verb roots and nouns. In this case, paradigmatic tonal contrasts arise on the first syllable (Table 5) and the last syllable (Table 4) of both nouns and verbs. This preliminary analysis shows also the category-specific phonological effects which distinguish Hamar nouns from verbs: as illustrated in §3.1, Hamar nouns allow more contrastive prosodic choices than verbs; this phenomenon is described by Smith (2011) in terms of greater “phonological privilege” of nominal categories over verbs. Phonological processes can be sensitive to parts of speech, and according to Smith’s typological study parts of speech tend to conform to the following hierarchy of phonological privilege: nouns > adjectives > verbs; the majority of category-specific phonological effects involves mainly suprasegmental and prosodic phenomena, rather than segmental phenomena (Smith 2011: 2448). Nouns’ phonological privilege in Hamar is also supported by the fact that vowel harmony, which gives rise to mid-low vowels, takes place only in nouns and not in verbs.

## Abbreviations

1	first person	IMP	imperative
2	second person	NEG	negative
3	third person	SUB	subordinative
M	masculine	CNV	converb
F	feminine	PF	perfective
PL	plural	JUSS	jussive
SG	singular	PAST	past tense
		PRES	present tense

## Acknowledgments

I am grateful to the LABEX ASLAN (ANR-10-LABX-0081), Université de Lyon, for the financial support (ANR-11-IDEX-0007, “Investissements d’Avenir” program operated by the French National Research Agency). I wish to thank the anonymous reviewers for the thoughtful comments on the original paper.

## References

- Azeb, Amha. 2012. Omotic. In Zygmunt Frajzyngier & Erin Shay (eds.), *The Afro-Asiatic Languages*, 423–504. Cambridge: Cambridge University Press.
- Bender, Lionel M. 2000. *Comparative morphology of the Omotic languages*. Munich: Lincom Europa.
- Bender, Lionel M. 2003. *Omotic lexicon and phonology*. Carbondale: Southern Illinois University.
- Blažek, Václav. 2008. A lexicostatistical comparison of Omotic languages. In John D. Bengtson (ed.), *In hot pursuit of language in prehistory. Essays in the four fields of anthropology. In honor of Harold Fleming*, 57–148. Amsterdam: John Benjamins.
- Crass, Joachim & Ronny Meyer. 2008. Ethiopia. In Bernd Heine & Derek Nurse (eds.), *A linguistic geography of Africa*, 228–250. Cambridge: Cambridge University Press.
- Ferguson, Charles A. 1970. The Ethiopian language area. *Journal of Ethiopian Studies* 8:2. 67–80.
- Ferguson, Charles A. 1976. The Ethiopian language area. In M. Lionel Bender (ed.), *The Non-Semitic languages of Ethiopia*. African Studies Center, Michigan State University: East Lansing.
- Fleming, Harold C. 1974. Omotic as an Afroasiatic family. In William R. Leben (ed.), *Proceedings of the 5th annual conference on African linguistics*. University of California (UCLA): African Studies Center & Department of Linguistics.
- Hayward, Richard J. 1987. Terminal vowels in Omoto nominals. In Herrmann Jungraithmayr & Walter W. Müller (eds.), *Proceedings of the Fourth International Hamito-Semitic Congress*. Amsterdam: John Benjamins.
- Hayward, Richard J. 1988. Remarks on Omotic Sibilants. In Bechhaus-Gerst Marianne & Fritz Serzisko (eds.), *Cushitic-Omotic. Papers from the International Symposium on Cushitic and Omotic Languages, Cologne, January 6-9, 1986*. Hamburg: Helmut Buske.

- Hayward, Richard J. 2003. Omotic: The “empty quarter” of Afroasiatic linguistics. In Jacqueline Lecarme (ed.), *Research in Afroasiatic Grammar II: Selected papers from the fifth conference on Afroasiatic languages, Paris, 2000*, 241–263. Amsterdam: John Benjamins.
- Hyman, Larry M. 2006. Word-prosodic typology. *Phonology* 23. 225–257.
- Hyman, Larry M. 2009. How (not) to do phonological typology: The case of pitch-accent. *Language Sciences* 31. 213–38.
- Hyman, Larry M. 2001. Tone systems. In Martin Haspelmath, Ekkehard König, Wulf Oesterreicher & Wolfgang Raible (eds.), *Language typology and language universals: An international handbook*, 1367–1380. Berlin & New York: de Gruyter.
- Mous, Maarten. 2012. Cushitic. In Zygmunt Frajzyngier & Erin Shay (eds.), *The Afroasiatic languages*, 342–422. Cambridge: Cambridge University Press.
- Petrollino, Sara. 2016. *A grammar of Hamar, a South Omotic language of Ethiopia*. Köln: Köppe Rüdiger Verlag.
- Rapold, Christian J. 2006. *Towards a grammar of Benchnon (PhD thesis)*. Leiden University. (Doctoral dissertation).
- Simons, Gary F. & Charles D. Fennig. 2017. *Ethnologue: Languages of the world*. 20th edn. Dallas: SIL International. <http://www.ethnologue.com>.
- Smith, Jennifer L. 2011. Category-specific effects. In Marc van Oostendorp, Colin J. Ewen, Elizabeth Hume & Keren Rice (eds.), *The Blackwell companion to phonology*, 2439–2463. Malden, MA: Wiley-Blackwell.
- Zaborski, Andrej. 2004. West Cushitic. A genetic reality. *Lingua Posnaniensis* 46. 173–186.



## Chapter 17

# Verbal gestures in Cameroon

Betsy Pillion

University of Chicago

Lenore A. Grenoble

University of Chicago

Emmanuel Ngué Um

University of Yaoundé

Sarah Kopper

Michigan State University

This paper details the nature of a set of extra-grammatical units that we call *verbal gestures*, found in several communities in the Central, Littoral, and Southern regions of Cameroon. We lay out the verbal gestures found in these communities, explain their usage and distribution within the context of the community and the language of the user, and situate the system of verbal gestures found in Cameroon in the larger linguistic context of Cameroonian multilingualism. Furthermore, we make preliminary proposals for a system of sounds that exists outside of that of the primary phonemic system, which interacts with the system of verbal gestures.

## 1 Introduction

We use the term *verbal gestures* to refer to a set of linguistic elements that are extra-grammatical, in the sense that they are not used in a morphosyntactic frame, and thus are not lexical words per se, but may serve the same functional purpose. Verbal gestures often include sounds or segments that stand outside a language's phonemic inventory; in many of the documented instances of verbal gestures that we illustrate here, they consist only of non-phonemic segments.



Nonetheless, verbal gestures are a core part of the communicative system of the language. Verbal gestures are readily recognized by speakers as having semantic and pragmatic meaning, but are not words. Examples in English include the use of the glottal stop in some pronunciations of *uh-oh* or in the dental click in *tsk-tsk*. These sounds, despite not being used in recombinable units within the phonemic system, are consistent in their articulatory execution and acoustic result. We propose that these systematic articulations are governed by a secondary sound system. The level of interaction that this system seems to have with the primary phonemic system, and the extent to which these sounds can differ in their articulation, are still open questions. We present a preliminary analysis in §5. The present contribution is a part of a larger project investigating the category of verbal gestures cross-linguistically; here we present one small subset resulting from a pilot study conducted by the authors in Cameroon in 2015.

This work builds on previous research on verbal gestures in Senegal Grenoble et al. (2015), focusing instead on verbal gestures in Cameroon, and expands the theoretical groundwork of the earlier work. Verbal gestures have much in common with what (Gil 2013) has identified as *paralinguistic clicks*, but the category of verbal gestures is larger and includes sounds that are not clicks, and includes items that are not paralinguistic but linguistic.<sup>1</sup> Gil notes that “paralinguistic clicks resemble other linguistic signs in that they are arbitrary and conventionalized.” Since they are vocal, it is unclear what distinguishes them from other linguistic items, such as interjections, except that they contain non-phonemic clicks. It has long been recognized that certain categories – exclamations, interjections, animal calls, baby talk, foreign words – often contain sounds not found elsewhere in the sound system, as noted by (Harris 1951: 71); see also (Fries & Pike 1949).

The phenomena under investigation here are not discourse markers, defined as “sequentially dependent elements which bracket units of talk” (Schiffrin 1987: 31) or as signaling a relationship between the upcoming message and prior discourse (Fraser 1990; 1996; 1999) and have a “core meaning that is procedural, not conceptual” (Fraser 1999: 950). With reference to manual gestures, these have been called

---

<sup>1</sup>The term *paralinguistic* has been used to refer to a host of categories over the years. While Gil’s use of *paralinguistic* selects these clicks as being objects in some way alongside language but not within it, many researchers use *paralinguistic* to refer to aspects of speech that are not strictly contrastive or linguistic but indicate other aspects of a person’s voice such as confidence (Scherer et al. 1973), or suprasegmental attributes of the speech signal that signal emotion (Fujisaki & Hirose 1993). It is for this reason that we avoid the term in categorizing verbal gestures. See also Ameka (1992: 112) who discusses the characterization of interjections as paralinguistic and thus peripheral.

*discourse unit markers*, “labels for segments or units within a discourse, thereby indicating the part these units play within the discourse structure” (Kendon 1995: 248). We add to a growing body of research on phenomena that have been historically considered to be on the margins of language, but have increasingly been analyzed as integral to the overall communicative situation. Examples include phenomena with unusual sounds, such as whistle speech (Meyer 2015; Sicoli 2016), hesitation markers (Dingemanse et al. 2013; Schegloff 1982), ideophones (Childs 1994), and theticals (Kaltenböck et al. 2011), which are prosodically distinct and syntactically independent.

Verbal gestures are perhaps best viewed as a subset of the larger category of interjections, a class generally defined as including both word types and an utterance type (Ameka 1992: 102). The word types constitute a special subset because of their particular phonetic and morphosyntactic properties: they are often phonologically distinctive, and may contain sounds not in the phonemic inventory, a characteristic of the category of interjections as a whole (Schachter 1985). This category has been referred to as *non-words*. These are primary interjections and “do not normally enter into construction with other word classes” (Ameka 1992: 105); they are phonologically and morphologically anomalous. The class of verbal gestures as we define it is sufficiently broad to include phenomena that are similar to *quotable gestures* or *emblems* which include *lexical gestures* that can be translated into lexical words (Brookes 2004; Poggi 1983; Poggi & Zomparelli 1987). In these respects verbal gestures are very much like quotable gestures, but they are vocal, not manual or facial. They differ from lexical words in each of the languages examined in our fieldwork in that they not only do not take morphology, but also cannot be embedded. (For more detailed discussion, see Grenoble et al. 2015.)

Verbal gestures do not enter into a morphosyntactic frame: they do not combine with the grammar, or inflectional or derivational morphology. They have conventional content and form: they are readily understood and used by multiple speakers across the speech community. They can constitute an utterance. Like other utterances, they may overlap with another speaker’s utterance, or they may stand alone, for example as a second-pair part of an adjacency pair. Verbal gestures are readily borrowable cross-linguistically, precisely because they do not enter into a morphosyntactic frame and are attractive because they make use of sounds that are highly salient to outside speakers.

The verbal gestures we have documented in Cameroon are very similar across different languages, with some differences in production. For example, the gesture for negative affect is similar in all tested regions of Cameroon and across

speakers of different mother tongues, but varies in terms of the duration of the gesture and head movement.

In contrast to verbal gestures in Cameroon, Wolof speakers in Senegal use a *highly* conventionalized system of verbal gestures, whose meanings and articulations vary minimally. Included in this system are verbal gestures that have the same function as the words ‘no’ and ‘yes’ (Grenoble et al. 2015). The systems of verbal gestures we have observed in certain areas of Cameroon differ from those of Senegalese Wolof in their level of conventionalization, and there are major differences in the delineation of these systems with respect to how the phonemic system and the verbal gestural system interact.

Conventionalization involves diachronic patterns of change and is “typically in a state of flux” (Ferguson 1994: 27); note that Ameka (1992: 106) defines interjections as “relatively conventionalized vocal gestures,” suggesting a continuum. Conventionalization is thus an ongoing process, and we take level of conventionalization as a rough reflection of both the consistency of the gesture’s pragmatic use within the linguistic system and the consistency of articulatory production. Verbal gestures that are unconventionalized, or lowest on the scale of conventionalization, include nonce gestures, that are uttered once and may have clear contextual meaning, but are not reproduced by other speakers. More conventionalized verbal gestures have propagated and are found in the wider speech community, but are very contextually dependent for pragmatic interpretation, or do not have a consistent meaning across the speech community but are more widely used than one-off verbal gestures. Finally, conventionalized verbal gestures are consistent in pragmatic interpretation across the speech community, and although each verbal gesture may serve multiple functions, its interpretation within a given context is predictable and transparent to interlocutors.

Our work is similar in spirit to Eastman & Omar (1985), which identifies a special category of co-speech gestures in Swahili, placing it on a continuum of verbal–non-verbal communication. Their work focuses on manual co-speech (or, in their terms, verbally-dependent) gestures, while we are concerned with gestures that are vocalizations, although they may be accompanied by some physical body movement (manual gesture, facial expression, head movement, or body movement). The inventory of Swahili interjections includes at least one “non-linguistic vocalization,” *hngʷngʷ*, described as a bisyllabic item, consisting of “breathy syllabic velar nasal followed by a glottal catch and another syllabic velar nasal” (Eastman 1992: 281; Eastman & Omar 1985: 328); this sound is accompanied by a distinctive manual gesture to indicate a bad smell. Eastman’s study of Swahili interjections provides a list of 28 items, many of which are clearly words

by any definition, such as *harambee!* ‘let’s all pull/work together’. The gesture *hngʔngʔ* is distinct in this regard: it is not a word form, but a verbal gesture as defined here.

It should also be noted that in our discussion of verbal gestural systems, we are only able to offer a snapshot of what is assuredly a varied and multifaceted group of verbal gestures, as of yet undocumented. The scales given here are intended only to serve as a reference for the possibilities of groupings that may exist throughout languages,<sup>2</sup> and reflect only the gestures that we have documented and are well attested in our field recordings.

Wolof verbal gestures are highly conventionalized. The sounds that these gestures are composed of vary minimally, with the exception of the *waaw* ‘yes’ gesture, which can be produced as an alveolar, palatal, or lateral click, apparently in free variation. Many Wolof verbal gestures use a secondary set of sounds, while also making some use of the primary phonemic system. This is illustrated in Figure 1.

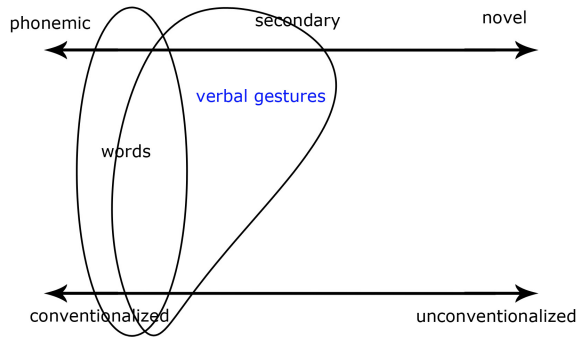

Figure 1: Senegalese Wolof

Figure 1 illustrates the relationship of verbal gestures to words along the two continua of the sound system and conventionalization. The lines in the figure indicate that these items exist over a wider range of levels of conventionalization

<sup>2</sup>While it is theoretically possible that a language does not use any primary phonemes in its verbal gestures, that seems highly unlikely and we know of no such system.

and phonemic statuses and not the total inventory. That is, the figure should not be interpreted as claiming that the inventory of verbal gestures is larger than that of lexical words, but simply that there is more variety with respect to these parameters within that category.

Wolof also has a rich system of ideophones, which function like conventional words in that they take morphology and syntax, and use only phonemic sounds. They do not use clicks, unlike many Wolof verbal gestures. In contrast, in the Cameroonian languages studied here, verbal gestures are less conventionalized than words, as illustrated in Figure 2.

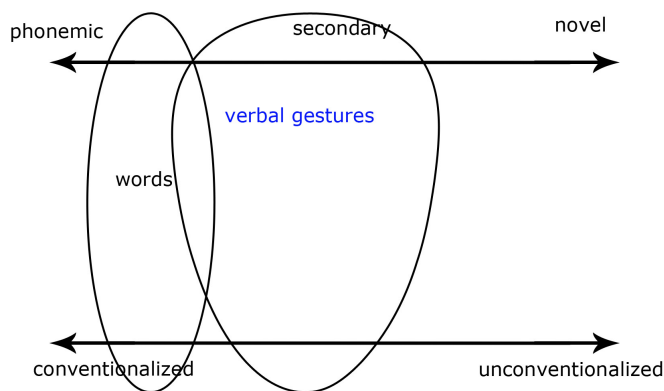

Figure 2: Cameroonian verbal gestures

Cameroonian verbal gestures are varied across languages and areas, but across these systems, we note that even within languages and communities there is less conventionalization of the meaning of these gestures in Cameroon. They are not as readily recognized as they are in Wolof communities by speakers, and they have a wider range of possible interpretations (although there are some verbal gestures that are extremely similar between Senegal and Cameroon, see §4.1 and §4.3). The extent to which this lesser level of conventionalization might be related to the multilingualism of the communities in question is not known. This level of conventionalization also may vary from community to community, but in our

glimpse of these systems, we note that these gestures do not seem to take the place of words such as in the system in Senegal.

Despite the differences in the levels of conventionalization between Wolof and Cameroonian verbal gestures, there are striking similarities between them in meaning and articulation, as illustrated in §4.

## 2 Methodology

Our analysis is based on fieldwork conducted in Cameroon in 2015 in three urban centers (Buea, Edéa, Yaoundé), and on the palm oil plantation Apouh A Ngok (Littoral region, to the south of Edéa), and casual observations in Douala. Several methods were employed to elicit and understand verbal gestures: focused elicitation sessions, participant observation, and casual observations while walking around town, including some recordings in the marketplace. Elicitations were conducted in Basaá, English, and French. Since Ngué Um is a native speaker of Basaá, we were able to document approximately 90 minutes of spontaneous, unplanned conversation in Basaá, in two different settings, once with the authors, and once without any of the authors present. In addition, we conducted language surveys in Apouh A Ngok to judge levels of multilingualism. Similar to Brookes (2004: 191), we identify conventional gestures by one of the following criteria: (1) the gesture was attested on more than one occasion in spontaneous speech, signaling a similar meaning; (2) the gesture was observed in spontaneous speech and its usage and meaning were confirmed by a native speaker other than the interlocutor who originally produced it; and (3) it was elicited from multiple native speakers of the same language. Gestures which were claimed to be used by only one native speaker and not otherwise attested in spontaneous speech are given in Table 4, §4.6.

Previous work on Wolof verbal gestures in Senegal showed them to be very easy to elicit: Wolof speakers quickly recognize the phenomenon and readily produce gestures from a description of the semantic/pragmatic content once they understand the question. For example, if asked how to say ‘yes’ (or *oui*) using a sound on the lips, they produce one of three possible click variants for this gesture, and easily offer additional verbal gestures. This was not the case in Cameroon, where speakers responded with *mhmm* or *mmm*, starting out with a mid-level pitch and rising at the end, but critically not a click (reflecting in part the absence of YES/NO gestures in the Cameroonian languages under investigation). The exception is the production of the negative affect click, which is readily elicitable and is referred to in Basaá as *tʃámlà*.

### **3 Linguistic situation in Cameroon**

Cameroon is notable for high levels of multilingualism, both in terms of the overall numbers of languages spoken as well as on an individual basis: Cameroonians are likely to have at least some functional knowledge of multiple codes, with varying levels of proficiency. 273 languages are spoken throughout the country, and many Cameroonians are speakers of several indigenous languages in addition to the official government and educational languages French and English. Interviews at the palm oil plantation in Apouh A Ngok give some sense of what we mean by claiming high levels of multilingualism. A total of 24 languages were spoken by 14 respondents; one respondent, who claimed to speak 17 different language, is excluded from this count.

Despite the multilingualism of these speakers, none of the languages found in these communities makes use of click consonants in its phonological system. The speakers who participated in our study are all multilingual, and are privy to multiple linguistic communities. In addition, all speakers interviewed have spent significant time in cities other than those where their mother tongue is spoken. We briefly outline the position of each language represented in this study, and the phonologies of these languages. Speaker data here is taken from Lewis et al. (2016) and should be taken as only an estimate of approximate speaker population size.

#### **3.1 Basaá**

Basaá (A43) is a language spoken in the Littoral region of Cameroon by approximately 300,000 people. Its speakers are located in the Francophone region of Cameroon. Basaá is a tonal language, which makes use of phonemic high, low, and mid tones. Importantly, its phonology and phonotactics do not make use of click consonants. Our Basaá consultants come from the Sanaga-Maritime Department of the Littoral region, near Édéa. Additionally, Ngué Um, the third author of this paper, is a native speaker of Basaá. We have considerably more data for Basaá than any other Cameroonian language, with multiple speakers.

#### **3.2 Bakoko**

Bakoko (A43) is spoken in the Littoral region of Cameroon by approximately 50,000 people. It is closely related to Basaá and is considered to be mutually intelligible with Basaá by some speakers of the languages. The Bakoko consultants who we worked with during this study were from Édéa and the nearby palm oil



plantation Apouh A Ngok, in the Littoral region. It is also a tonal language, much like Basaá. Importantly, the phonemic system of the language does not make use of clicks.

### 3.3 Bulu

Bulu (A74) is spoken in the Southern region of Cameroon by approximately 858,000 people as an L1, and an additional 800,000 as an L2. It is also a tonal language with three phonemic tones. Its phonemic inventory does not make use of click consonants either. The language is spoken in both urban and rural areas over a large part of the country, and thus further research is required to determine the range of verbal gestures used by Bulu speakers.

### 3.4 Ngoshie

Ngoshie is a Grassfields Bantu language spoken in Momo Division, Cameroon, by approximately 9,200 people, although this number comes from an SIL survey from 2001 (Lewis et al. 2016) so it is unclear how many speakers exist now. Our consultant DM was raised in a Ngoshie-speaking household, but also speaks French and English with her parents and family. Additionally, she was not raised in Momo Division, which limits our ability to use her verbal gestures as a reflection of Ngoshie speakers in general.

### 3.5 CPE, official languages

Cameroonian Pidgin English (CPE) is spoken in many areas of Cameroon, particularly in Anglophone areas. We did not speak to anyone who was a native speaker of CPE, and there are some questions as to the status of those who might be “native” CPE speakers. However, we did speak to some Cameroonians who were competent in CPE or had passive knowledge of the language. Multiple interviewees in Apouh A Ngok stated that the lingua franca in the community was CPE and some parents claim to raise their children in CPE.

Besides CPE, English and French were used widely in the areas we visited. French and English are the only official languages of Cameroon, and the country is officially “bilingual” in both languages in its education and government. However, in practice, areas of the country tend towards association with French or English exclusively. The capital and areas of economic power are located in French-speaking regions, leading to a linguistic power dynamic that tends to favor French speakers. French is the prestige language of the country in many

circles. Most people we encountered had knowledge of either French or English. In at least one Basaá household we visited, the majority of young speakers used a variety of French to speak amongst each other.

With respect to verbal gestures, it is important to note that these languages may serve as a means of transference for verbal gestures across linguistic boundaries that might have otherwise impeded their adoption. The extent to which these gestures are used in rural settings is not fully known. Speakers of Bulu and Basaá indicate that certain gestures are more associated with urban settings, and that village-dwelling speakers or older speakers might be unfamiliar with the attention-getting gesture specifically. Clearly, considerably more fieldwork is required to understand the full range and distribution of verbal gestures in Cameroon. That said, the multilingual nature of the country's urban centers presents a contact situation where speakers may rely on verbal gestures that can be understood across multiple languages to achieve communicative goals.

## 4 Verbal gestures in Cameroon

The verbal gestures analyzed are conventionalized, as determined by their widespread and regular (predictable) usage. They were mentioned by speakers of these languages in elicitation sessions, and were also observed in marketplace interactions on the street.

Table 1: Verbal gestures in Cameroon

Function	Form	Manner	Used by speakers of
Attention get	(stop-)sibilant	elongated	BKH, BAS, BUM, NSH
Distance call	whistle	LHLH contour	BKH, BAS
Negative affect	bilabial click	elongated	BKH, BAS, BUM, NSH
Back channel	velar click	repeated	BAS, NSH
Cat-calling	bilabial click	repeated	BKH, BAS, BUM, NSH
Yes	mm	LH melody	BKH, BAS, BUM
No	m?m?	HL melody	BKH, BAS, BUM

Language names given in ISO 639-3 codes: Bakoko = BKH; Basaá = BAS; Bulu = BUM; and Ngoshie = NSH

In the next sections we discuss the acoustic and articulatory parameters of these gestures, follow with examples of their usage, and give details of their pragmatic usages and cultural connotations. Several of these gestures vary slightly

among different users; each example is thus attributed to a specific speaker and should be associated with that speaker's particular linguistic community. Note that although we identify the mother tongue, or first language, of the speakers, all people interviewed are multilingual and live in highly multilingual communities, where different languages are heard on the street on a daily basis. Thus it is impossible to identify a single linguistic source for any particular gesture. Rather, it may be more accurate to posit regional (and possibly language-independent) variation than variation from language to language. This question requires further research but suggests that there may be a category of speech elements used cross-linguistically, in a multilingual community, without being tied to a specific language.

#### 4.1 Attention-getting

This gesture is used to attract the attention of another party, and has several attested phonetic forms. This variation cannot yet be attributed to a particular aspect of a speaker's background;<sup>3</sup> however, all attested forms of this gesture involve a sibilant consonant.

Table 2: Attention-getting gesture variants

Variant	Speaker of
ps:p	Bulu
s:	Ngoshie
ks:	Basaá
si, psi, ds:	Bakoko

This verbal gesture is realized through the articulation of a sibilant consonant, similar to a very elongated [s]. Preceding or following the sibilant may be a voiceless stop of some kind. Speakers across languages vary in the place of articulation of the consonant, but from our preliminary questioning all forms are recognized as versions of the gesture achieving the same pragmatic goal.

PM, a speaker of Bulu, states that there is a generational difference between speakers, and those who have lived in urban environments. When asked about the usage of this gesture to get the attention of a woman, he states, "For the young generation...she will understand that I'm calling her. Because she has ever been

<sup>3</sup>It is unknown whether or not speakers of the same linguistic community use the same stop-sibilant sequence, or whether speakers have idiosyncrasies even within language communities.

in the town and she knows what is happening when we say *pssp* when we do it, yes. But if she is an old woman she will never turn.”

The attention-getting gesture has been noted by our Bulu consultant to be associated with younger speakers and urban environments. However, we have noticed this gesture throughout smaller cities as well. There are indications that this gesture may be gendered, in that its usage by men towards women is considered by several of our speakers to be marked and rude. At the same time, little mention is made of the rudeness of using the gesture between men, and both genders have been observed using it with members of the same sex who are familiar to one another. Additionally, this gesture has been observed to be in use outside in marketplaces in Yaoundé and Édéa to attract the attention of potential customers, by both men and women vendors. There are doubtless restrictions and nuances to its use that are not captured here, but there is no doubt that this gesture is widespread among all urban communities we encountered.

## 4.2 Distance call

This whistling gesture is used to call to a listener at a significant distance. There are distinct call and response whistling contours used. The call contour involves a low-high-low-high sequence, whereas the response contour is strictly a low to high rise. These whistles appear to be employed in both Basaá speaking and Bakoko speaking areas. These contours can also be employed with an elongated *uuu* vowel instead of a whistle. If the speaker has successfully gotten the attention of the other interlocutor, a response to this gesture is another whistle. The response whistle is an LH contour that can be elongated after reaching the high level tone at the end of the whistle.

Table 3: Whistle gesture variants

Variant	Function
LHLH Contour Whistle	Calling distant speaker
LHLH Elongated <i>u</i> Vowel	Calling distant speaker
LH Contour Whistle	Responding to distant speaker

During an interview, the head of the village of Apouh A Ngok noted that in order to call to someone who is a kilometer away, you can whistle to call them, and thus avoid calling them by their name. This is a simple form of whistle speech,

with a two-part pair of call and response. The whistle carries over a greater distance than speech might. The whistle gesture is highly salient and audible.

As this gesture is not found widely in Cameroon – although its existence in other linguistic communities has not been ruled out – its range of pragmatic uses is not fully known. It overlaps in its usage with the attention-getting gesture, as it also shares the function of getting the attention of another speaker. However, this whistle appears to be used more often when speakers are out of sight of one another, at a further distance. Bakoko speakers report that these whistles are used when hunting, to call to another person in your party. The vowel counterpart which uses the same prosodic contour might be similarly limited to shorter distances as the attention-getting gesture.

### 4.3 Negative affect

The negative affect gesture is by far the most ubiquitous of all the verbal gestures listed here. It was recognized and repeated by speakers from every community we interacted with, and is analogous to verbal gestures found in Wolof communities in Senegal (Grenoble et al. 2015), and potentially to the “suck-teeth” gesture found in AAVE communities in the United States (Rickford & Rickford 1976). It is articulated through the release of suction in between the teeth and lips through the opening of the lips. Certain instances of the gesture have included a slow release of the lips across the mouth, elongating the sound and by extension enhancing and reinforcing the strength of the gesture’s meaning. The articulatory mechanisms that implement this sound are complex and currently under investigation, but it is likely that the movement and position of the tongue is also crucial to the creation of a patch of rarefied air behind the teeth. The gesture is similar to the cat-calling gesture described below, but instead of short, repeated instances of a bilabial click, this gesture is associated with oftentimes a slow release across the mouth. Bulu consultant PM notes that the sentence *maa ji gik* means literally ‘I don’t want,’ but can also be interpreted as ‘I don’t like.’ However, he notes that he can say: [ELONGATED BILABIAL CLICK] to express ‘I don’t like’.

The negative affect gesture was used commonly in everyday life by speakers of all languages we encountered. The label here is purposefully intended to evoke a wide range of possible pragmatic functions. Speakers use it during their own speech turns to indicate a negative attitude toward the referent or the propositional content of their own utterances (such as distaste and displeasure with events, people, or things being described). It can be used when another interlocutor is speaking to convey disagreement with that speaker, or to agree with their negative assessment of the situation. It has even been noted to be sympa-

thetic in particular instances, and to reinforce another speaker's assessment of a bad situation.

#### **4.4 Back channel**

The back channel gesture is made with a post-alveolar release in the oral cavity, typically with a closed mouth. The two points of closure in the click are still not positively identified, but in at least one speaker the anterior release is velar, making this click highly unusual. This back channel is articulated as a click that is repeated a minimum of two times, but can be repeated for an unspecified amount of time to emphasize the speaker's point of view.

This is one of the less common and less attested verbal gestures in Cameroon (although frequent in Senegalese Wolof), with confirmation of usage only from Basaá and Ngoshie speakers, and attested in our recordings of spontaneous Basaá conversation. Its use as a backchannel – where the hearer signals agreement, reinforces the sentiment of another speaker, or simply indicates that he or she is listening – was recorded in spontaneous Basaá speech and also described for Ngoshie.

This verbal gesture can serve several functions depending on the accompanying facial expressions. Ngoshie speaker DM states that the click can signal incredulity when accompanied by raised eyebrows and opened eyes. Additionally, this click can serve the function of providing sympathy to another interlocutor when accompanied by a side-to-side head shake. These types of alternations show the extent to which these verbal gestures interact with the non-verbal gestural system.

#### **4.5 Cat-calling**

This verbal gesture is used as a type of gendered calling, prototypically done by men on the street to passing women. It is articulated through a short bilabial click, and can be likened to a “kissing noise.” In most instances of its use, this bilabial click is articulated several times in quick succession, but it does appear to be able to be used once to signify a similar meaning. This gesture is also widely used to call dogs or other animals. Women speakers, when asked about its use, were adamant that it was extremely rude and confirmed that it was used for animals.

#### 4.6 Less widespread verbal gestures

While there are many consistently used verbal gestures found throughout these diverse communities, within each of our interactions with consultants we found that speakers had unique verbal gestures that may or may not be propagated throughout their entire speech communities. Many of them are difficult to attribute to a particular pragmatic function, and could have multiple meanings depending on their context.

Table 4: Less widespread verbal gestures

Function(s)	Form	Manner	Language
Positive affect	alveolar click	repeated	Ngoshie
Summoning, amusement	palatal click	repeated	Ngoshie
Shooing animal	ʃ:	elongated	Ngoshie
Reprimand	àhááá	elongated	Bakoko

This is just a small sample of the examples volunteered during elicitation sessions, and are each attested by only one speaker. Nonetheless, they were readily volunteered and we consider it likely that more verbal gestures exist in other languages of Cameroon, and that the inventory for each of the languages discussed here could be increased. DM (Ngoshie) offered the positive affect click as a means of indicating pleasure or surprise at a passing man who is very attractive; the palatal click to call to her child, and when paired with pointing at the face and smiling, is used to encourage the child to smile. The reprimand volunteered by the head of the village of Apouh A Ngok (Bakoko) is used to reprimand a child, and is similar to a verbal gesture given by our Bulu consultant PM of *ha:* for ‘no’ and may have a similar origin.

The conventionalization of these verbal gestures across speakers of several languages suggests that they are not language dependent; however, the extent to which there exists inter- and intra-linguistic variation in their execution is still an open question. Notes on variation herein are based on a very small sample size, and as a result cannot necessarily be attributed to differing language background, or to idiosyncratic pronunciation on the part of the speaker.

## 5 Discussion

Fries & Pike (1949) propose the notion of a coexistent, or secondary, sound system that comprises sounds frequently used in a language that are not part of its phonemic inventory (see also Harris 1951). These verbal gestures are heavily reliant on a system of secondary sounds. This system of secondary sounds has been identified by numerous researchers in some capacity, particularly with reference to verbal gestures. This system, by definition, is accessible only by verbal gestures and other marginal lexical groups like ideophones, mimetic, or sound symbolic words. The accessibility of this system may vary somewhat from language to language, as we might expect considering the wide array of different ways that languages deal with sound symbolism. Ideophones provide a clear case of the use of sound symbolism and are known to have unusual phonologies; some have segments or different phonemic inventories (Childs 1994: 181-185). Thus we predict that ideophones and verbal gestures alike make use of secondary sounds. The Bantu language Yeyi has two click consonants in the primary phonemic system but an additional click that only appears in an interjection, which we might classify as belonging to the subclass of verbal gestures (Bostoen & Sands 2012: 130).

A noteworthy aspect of the verbal gestures found in Cameroon is that although they make use of both the primary and secondary sound system, there are no instances of them appearing adjacently within a gesture. The attention-getting gesture, composed of an optional stop and an obligatory sibilant, is completely made up of items found in the phonemic systems of these languages. The negative affect gesture, which is simply a bilabial click, makes use only of the secondary sound system. Languages that have click consonants as part of their phonemic systems do not make use of singular clicks as phonotactically licit syllables or words. These consonants combine with vowels: they behave like consonants in other languages. However, the clicks associated with the verbal gestural system are not attested in adjacent positions to other segments. Although only a small number of languages have been surveyed with respect to this phenomenon, this does not appear to be idiosyncratic but systematic. While click consonants occur in a very small percentage of the world's languages (only 9 out of a sample of 567, see Maddieson 2013), there is evidence that clicks with pragmatic interpretation such as verbal gestures exist in a wide array of languages (Gil 2013).

The secondary sound system described here is *systematic*, can be accessed by marginal elements of the language, and accepts new sounds more easily than the primary phonemic system of a language. Support for this claim also comes from



Nuckolls et al. (2016), which document systematic differences between the sound inventories of Pastaza Quichua ideophones and the regular lexicon. It is systematic in that it has a limited range of phonetic and articulatory representations that correspond to a singular abstract mental representation for these sounds. These relations between acoustic realization and mental unit are not claimed to be identical to those that occur within the primary phonemic system. They differ in that the range of acceptable realizations for these units is claimed to be wider, but is nonetheless confined.<sup>4</sup> Secondary sounds can be repeated, lengthened or shortened, but other than these processes related to duration and repetition, they are limited in their behavior. They do not combine with sounds in the primary phonemic inventory, or with one another. One notable exception is the use of the glottal stop in American English [ʔmʔm] and in some pronunciations of *uh-oh*.

We do not claim to understand the means by which these new sounds are incorporated into the secondary system. The sound symbolic nature of certain vocabulary has been pointed out by Bostoen & Sands (2012) to be an anchor for the infusion of click consonants into Bantu languages. Similarly, Bostoen & Donzo (2013) propose that labial-velar stops diffused into Lingombe by means of association through sound symbolic categories. These marginal phonemes with low functional load likely existed somewhere on the spectrum between secondary and primary phonemes before being incorporated into more vocabulary and moving closer to primary. In the cases presented here, novel sounds encountered in the speech environment are likely associated with pragmatic meaning and then systematically repeated and reinforced to the point that their articulation and acoustic realization is made consistent. Whatever the means of adoption, there is no doubt that these sounds exist, and that they must be governed by some kind of a system with respect to their perception, as they are found in numerous linguistic systems and recognized as having designated pragmatic and semantic meanings. In the multilingual speech communities of Cameroon, verbal gestures are widely used and available to speakers of different mother tongues. They serve as a form of ready cross-linguistic communicative devices, and it is difficult to trace their initial source. Considerable further research is needed into their distribution and uses.

---

<sup>4</sup>There is a potential confound, in that these sounds are difficult to separate from the pragmatic and semantic role that they are assigned. As such, claims about their range of acceptable pronunciations might be better suited to those comparable to the acceptable range of pronunciation of a word rather than of a phoneme.

## Acknowledgements

Research on this project was sponsored by the Centre International de Recherche et de Documentation sur les Traditions et les langues Africaines (CERDOTOLA) and the Visiting Committee of the Division of the Humanities at the University of Chicago. We are very grateful for their support, and for the support and hospitality of the University of Buea, University of Yaoundé, and at Apouh A Ngok. Special thanks to Jacky Mireille Ngo Nsang and her family for all their help, and all the many speakers of Cameroonian languages who worked with us. We are also grateful to the anonymous referees whose comments greatly improved the paper. Any remaining errors are our own.

## References

- Ameka, Felix. 1992. Interjections: The universal yet neglected part of speech. *Journal of Pragmatics* 18. 101–118.
- Bostoen, Koen & Jean-Pierre Donzo. 2013. Bantu-Ubangi language contact and the origin of labial-velar stops in Lingombe. *Diachronica* 30(4). 435–468.
- Bostoen, Koen & Bonny Sands. 2012. Clicks in south-western Bantu languages: Contact-induced vs. language-internal lexical change. In Matthias Brenzinger & Anne-Maria Fehn (eds.), *Proceedings of the 6th World Congress of African Linguistics, Cologne, 17–21 August 2009*, 121–132. Rüdiger Köppe.
- Brookes, Heather. 2004. A repertoire of South African quotable gestures. *Journal of Linguistic Anthropology* 14(2). 186–224.
- Childs, Tucker C. 1994. African ideophones. In Leanne Hinton, Johanna Nichols & John J. Ohala (eds.), *Sound symbolism*, 178–204. Cambridge: Cambridge University Press.
- Dingemanse, Mark, Frances Torreira & N.J. Enfield. 2013. Is “huh?” a universal word? Conversational infrastructure and the convergent evolution of linguistic items. *PLOS ONE*. DOI:10.1371/journal.pone.0078273
- Eastman, Carol M. 1992. Swahili interjections: Blurring language-use/gesture-use boundaries. *Journal of Pragmatics* 18. 273–287.
- Eastman, Carol M. & Sh Yahya Ali Omar. 1985. Swahili gestures: Comments (*vielezi*) and exclamations (*viingizi*). *Bulletin of the School of Oriental and African Studies* 48(2). 321–332.
- Ferguson, Charles A. 1994. Dialect, register and genre: Working assumptions about conventionalization. In Douglas Biber & Edward Finegan (eds.), *Soci-*

- linguistic perspectives on register* (Oxford Studies in Sociolinguistics). Oxford: Oxford University Press.
- Fraser, Bruce. 1990. An approach to discourse markers. *Journal of Pragmatics* 14. 383–395.
- Fraser, Bruce. 1996. Pragmatic markers. *Pragmatics* 6(2). 167–190.
- Fraser, Bruce. 1999. What are discourse markers? *Journal of Pragmatics* 31(7). 931–52.
- Fries, Charles C. & Kenneth L. Pike. 1949. Coexistent phonemic systems. *Language* 25. 29–50.
- Fujisaki, Hiroya & Keikichi Hirose. 1993. Analysis and perception of intonation expressing paralinguistic information in spoken Japanese. In *ESCA Workshop on Prosody*.
- Gil, David. 2013. *Para-linguistic usages of clicks*. Matthew S. Dryer & Martin Haspelmath (eds.). Leipzig. <http://wals.info/chapter/142>.
- Grenoble, Lenore A., Martina Martinović & Rebekah Baglini. 2015. Verbal gestures in Wolof. In Ruth Kramer, Elizabeth C. Zsiga & One Tlale Boyer (eds.), *Selected proceedings of the 44th Annual Conference on African Linguistics*, 110–121. Cascadilla Proceedings Project.
- Harris, Zellig. 1951. *Methods in structural linguistics*. Chicago: University of Chicago Press.
- Kaltenböck, Gunther, Bernd Heine & Tania Kuteva. 2011. On thetical grammar. *Studies in Language* 35(4). 852–897.
- Kendon, Adam. 1995. Gestures as illocutionary and discourse structure markers in Southern Italian conversation. *Journal of Pragmatics* 23. 247–279.
- Lewis, M. Paul, Gary F. Simons & Charles D. Fennig. 2016. *Ethnologue: Languages of the world*. 19th edn. Dallas, Texas: SIL International.
- Maddieson, Ian. 2013. *Presence of uncommon consonants*. Matthew S. Dryer & Martin Haspelmath (eds.). Leipzig. <http://wals.info/chapter/19>.
- Meyer, Julien. 2015. *Whistled languages: A worldwide inquiry on human whistled speech*. New York: Springer.
- Nuckolls, Janis B., Joseph A. Stanley, Elizabeth Nielsen & Roseanna Hopper. 2016. The systematic stretching and contracting of ideophonic phonology in Pastaza Quichua. *International Journal of American Linguistics* 82(1). 95–116.
- Poggi, Isabella. 1983. Le analogie tra gesti e interiezioni: Alcune osservazioni preliminari (analogies between gestures and interjections: Some preliminary observations). In Franca Orletti (ed.), *Communicare nella Vita quotidiana (Communicating in daily life)*, 117–133. Bologna: Il Mulino.

- Poggi, Isabella & Marina Zomparelli. 1987. Lessico e grammatica nei gesti e nelle parole (Lexicon and grammar in gestures and words). In Isabella Poggi (ed.), *Le parole nella testa: Guida a un'educazione linguistica cognitivista (Words in the head: Guide to cognitive linguistic training)*, 291–328. Bologna: Il Mulino.
- Rickford, John R. & Angela E. Rickford. 1976. Cut-eye and suck-teeth: African words and gestures in New World guise. *The Journal of American Folklore* 89(353). 294–309.
- Schachter, Paul. 1985. Parts-of-speech systems. In Timothy Shopen (ed.), *Language typology and syntactic description*, 1st, 3–61. Cambridge: Cambridge University Press.
- Schegloff, Emmanuel. 1982. Discourse as interactional achievement: Some uses of 'uh huh' and other things that come between sentences. In Deborah Tannen (ed.), *Analyzing discourse: Text and talk*, 71–93. Georgetown: Georgetown University Press.
- Scherer, Klaus R, Harvey London & Jared J Wolf. 1973. The voice of confidence: Paralinguistic cues and audience evaluation. *Journal of Research in Personality* 7(1). 31–44. DOI:[https://doi.org/10.1016/0092-6566\(73\)90030-5](https://doi.org/10.1016/0092-6566(73)90030-5)
- Schiffrin, Deborah. 1987. *Discourse markers*. Vol. 5 (Studies in Interactional Sociolinguistics). Cambridge: Cambridge University Press.
- Sicoli, Mark. 2016. Repair organization in Chinantec whistled speech. *Language* 92(2). 411–32.

## **Part II**

# **Syntax and semantics**



## Chapter 18

# Contrastive focus particles in Kusaal

Hasiyatu Abubakari

University of Vienna, Austria

This paper presents and discusses the particles used in expressing contrastive focus<sup>1</sup> in Kusaal, a Gur language spoken in Ghana, Burkina Faso and Togo. Contrary to the earlier claim made by Abubakari (2011) that focus is morphologically null in the language, the particles *kà*, *ń* and *né* are identified as contrastive focus markers in Kusaal. The particle *kà* is limited to fronted focused items, whilst *ń* and *né* are limited to in-situ focused constituents. Ex-situ focus always bears contrastive interpretation, hence the obligatory use of *kà*. In-situ focus is marked prosodically. However, the in-situ use of *ń* and *né* correlates with a contrastive and exhaustive focus interpretation. To determine the validity of *ń*, *né* and *kà* as contrastive focus particles, I subject them to various tests of exhaustivity from which I conclude that these are contrastive focus particles in the language.

## 1 Introduction

The concept of contrastive focus, marked with different strategies in most languages, has received a lot of attention in the literature. É. Kiss (1998) looks at the concept with data from Hungarian and English, Horn (1981) with data from English, Szabolcsi (1981) with Hungarian, Hartmann & Zimmermann (2007) with Hausa, and Duah (2015) with Akan. Additionally, Hudu (2012) discusses contrastive focus constructions in Dagbani, Hiraiwa (2005) and Hiraiwa & Adams (2008) also mention focus constructions in Buli and Dagaare respectively. Abubakari (2011) analyses focus as morphologically null in Kusaal. This paper seeks to clarify that notion by showing that *information* focus is not overtly marked

---

<sup>1</sup>The use of the term contrastive focus is aligned with what É. Kiss (1998) refers to as exhaustive focus or identificational focus. With this background, the terminological use of identificational focus, contrastive focus and exhaustive focus are meant to refer to the same notion that is expressed by the particles *kà*, *ń*, *né* in Kusaal.



since Kusaal does not have a grammatical focus marker (1b); but *contrastive* focus is marked using the particles *kà*, *n̄*, *né* (2a–b).

Context: Meals are not to be repeated; the questioner in (1a) knows that the children ate something yesterday but does not know what exactly they ate. Focus is therefore on what was eaten.<sup>2</sup>

- (1) a. Q: B́íís lá sà dī b́ó?  
children DEF PRT eat.PERF what  
‘What did the children eat yesterday?’  
b. Ans: B́íís lá sà dī **m̀ù**.  
children DEF PRT eat.PERF rice  
‘The children eat *rice* yesterday.’

Context: The hearer thought the children ate something other than rice, for example beans. The sentences in (2a–b) are corrections to the perceived notion of what was eaten yesterday.

- (2) a. **M̀ù** kà bà sá dī.  
rice FOC 3PL. PRT eat.PERF  
‘It is *rice* (and nothing else) that they ate yesterday’  
b. Bà sà dī né **m̀ù**.  
3PL. PRT eat.PERF FOC rice  
‘It is *rice* (and nothing else) that they ate yesterday’

In these examples, (1b) is an instance of information or presentational focus, where the focused constituent does not carry any contrastive interpretation. The utterances in (2a–b) on the other hand convey exhaustive interpretation, where what is eaten is not only emphasized but also exhaustive (in the sense that *only rice* is eaten) and contrastive (in the sense that *what is eaten is rice and nothing else*).

Extensive research on discourse-related information widely differentiates between two different forms of focus (Halliday 1967; Chafe 1976; Szabolcsi 1981; Michael 1986; É. Kiss 1998; Vallduví & Vilkkuna 1998; Molnár 2002). É. Kiss (1998) refers to the two forms as: “information focus” and “identificational focus”. Alongside É. Kiss (1998), Vallduví & Vilkkuna (1998) and Selkirk (2008), where it is

---

<sup>2</sup>Verbs do not inflect for tense in Kusaal. The remoteness of an activity is expressed using particles. The particle *sà* means the event is a day old, *dàà* means the event is two days old but less than a year and *dà* means the event is a year and beyond.



assumed that the evocation of alternative is restricted to contrastive or identificational focus, another widely acknowledged semantic definition of focus is Rooth's (1985; 1992; 1996) "alternative semantics" where the argument is made that "focus indicates the presence of alternatives that are relevant for the interpretation of linguistic expression" (cf Krifka 2007:6). By consequence, any kind of focus is assumed to set an alternative against which focused constituents are evaluated. This line of argumentation is followed by Zimmermann, who further adds that:

...the alternatives that play a role with contrastive focus are not just calculated relative to the semantic denotation of the focus constituent (the semantic alternative). Instead, they are calculated relative to the focus denotation together with the speaker's suppositions as to which of these alternatives the hearer is likely to expect (discourse-semantic alternative). (Zimmermann 2008: 3).

This work is not intended to go through the merits or demerits of these arguments. The fundamental goal is to provide empirical evidence in support of the claim that Kusaal does not have an overt grammatical focus particle and that the particles *kà*, *ń* and *né* are used in marking contrastive focus. I will therefore align this work with the definition of É. Kiss (1998), which provides the platform for differentiating information focus, which is morphologically null, from identificational focus, which uses the particles *kà*, *ń* and *né* in Kusaal. The following serve as the working definitions for (I) information focus and (II) identificational focus respectively.

- (I) "If a sentence part conveys new, nonpresupposed information marked by one or more pitch accents – without expressing exhaustive identification performed on a set of contextually or situationally given entities, it is a mere information focus." (É. Kiss 1998: 246)
- (II) "An identificational focus represents a subset of the set of contextually or situationally given elements for which the predicate phrase can potentially hold; it is identified as the exhaustive subset of this set for which the predicate phrase actually holds." (É. Kiss 1998: 249)

In this paper I discuss the syntax and semantics of the particles *kà*, *ń*, and *né* in Kusaal and argue that these particles are used in expressing exhaustive/contrastive focus every time they occur in a construction with focus interpretation. Whereas the particle *kà* is limited to fronted focused items only and is

obligatory whenever fronting occurs, *ń* and *né* are limited to in-situ focused constituents any time a contrastive/exhaustive focus interpretation is desired. Ex-situ focus always bears a contrastive interpretation and as such requires the obligatory use of *kà*. Kusaal marks in-situ focus using focal stress. The use of *ń* and *né* correlates with a contrastive/exhaustive focus interpretation. The grounds for these assertions are born out of the observed syntactic and semantic properties exhibited by these particles in Kusaal. Even though they perform similar functions compared to grammatical focus markers by triggering focus related interpretations, they differ significantly from default grammatical focus markers on the following grounds: First, the particles *kà*, *ń* and *né* are not default grammatical focus elements like *lá* and its variants in Dagaare, where the default focus marker must obligatorily occur in all declarative constructions (Bodomo 1997), even when no contrastive/exhaustive focus interpretations are encoded. Second, the presence of these particles has a direct semantic impact on the interpretation of the focused constituent. Either they cause an exhaustive/contrastive interpretation of the focused item, or the focused status of the constituent could be said to cause the appearance of these particles. They are excluded in non-exhaustive environments such as ‘mention-some’ contexts or contexts where a property is known to hold more than the focused entity (Hartmann & Zimmermann 2007: 242).

Some of the major questions this paper seeks to answer are:

1. How is discourse-related information packaged using the particles *kà*, *ń* and *né* in Kusaal?
2. How can one determine whether indeed the identified particles are contrastive/exhaustive focus particles in Kusaal?

The paper is organized into five sections. The second section looks at information packaging strategies in Kusaal and analyses the various types of focus constructions. In the third and fourth sections, I apply various standard tests for exhaustivity on the identified focus particles to verify whether they are indeed contrastive/exhaustive focus particles. The conclusion forms the final section.

## **2 Focus constructions in Kusaal**

As indicated earlier, this work uses the definition of É. Kiss (1998) as a background in analyzing and setting apart the two types of focus in Kusaal. Information or presentational focus is expressed prosodically where the focused item

receives extra stress in its pronunciation. No grammaticalized focus particle is used in such instances. Information focus is therefore argued to be overtly null in Kusaal. Contrastive focus on the other hand uses the particles *kà*, *ńí*, and *né*. In the following subsections, I present various contexts that naturally elucidate the use of information focus (§2.1) and contrastive focus (§2.2).

## 2.1 Information focus constructions in Kusaal

Following the definition in (I) by É. Kiss (1998: 246), the notions expressed using information focus are not expected to be exhaustive in nature. They serve to dissuade one's ignorance about an event, action or situation. The answers to the *wh*-questions in the examples below represent instances of information focus in Kusaal.

Context 1: Several things need to be done. The questioner does not know the activity carried out by a partner and underrates the relevance of what was done. The question in (3a) is used and the response in (3b) provides new information with focus on the activity that was carried out. It could be that several other activities were carried out but the most salient is the *buying of the items*.

- (3) a. Q: Ò sà kēŋŋē mǎāl bós?  
           3SG PRT go.PERF do.PERF what  
           ‘What at all did s/she go to do yesterday.’  
   b. Ans: Ò sà kēŋŋē *dā'*      *lá'ád lá.*  
           3SG PRT go.PERF buy.PERF items DEF  
           ‘S/he went and *bought the items* yesterday.’

Context 2: A group of children are playing. The youngest one is hit and he starts crying. The mother in (4a) wants to know who hit the child. One of the children who saw *Aduku* hitting the child responds as in (4b). It could also be the case that there are other children who hit the child although they are not mentioned.

- (4) a. Q: Ànó'ɔn bŭ'            bííg lá?  
           who beat-PERF child DEF.  
           ‘Who beat the child?’  
   b. Ans: *Àdúkú* bŭ'            bííg lá.  
           Aduku beat-PERF child DEF.  
           ‘*Aduku* beat the child.’

*Aduku's* mother also hears that her child has beaten someone, and asks to know who her child has beaten (5a). Again it could be that there are other victims of *Aduku* but only *Asibi* is mentioned (5b).

(5) a. Q: Àdúkú bú' àn'óné?  
Aduku beat-PERF who

'Who did Aduku beat?'

b. Ans: Àdúkú bŭ' Àsíbí.  
Aduku beat-PERF Asibi.

'Aduku beat *Asibi*.

In all the answers to questions (3a–5i) above, the sentences convey new, non-presupposed information, since the questioner has no knowledge of the information or the response the respondent is going to offer. The focused items do not have any form of contrastive/exhaustive interpretation and no overt morphological focus particles are used.

## 2.2 Contrastive focus constructions in Kusaal

Again following the working definition for identificational focus in (II), it will be seen that unlike information focus, contrastive focus constructions are largely inherently exhaustive or exhaustive by implicature. I illustrate the various distributions of the particles *kà*, *ń*, *né* in packaging this notion.

### 2.2.1 Ex-situ focus marking with *kà*

The particle *kà* occurs immediately after any item fronted to the left periphery of any construction. *Wh*-focus phrases are assumed to have moved to a designated focus position and they co-occur with the ex-situ focus particle *kà* (see Aboh 2007). Answers to questions involving *wh*-focus-phrases must have the particle *kà* after the focused constituent. It is ungrammatical to substitute *kà* with either *ń* or *né* in ex-situ focus constructions in the language.

(6) a. Q: Bó kà fù dá dā': búúg béε p'égó?  
what FOC 2SG PRT buy.PERF: goat or sheep

'What did you buy: a goat or a sheep?'

b. Q: \*Bó né fù dá dā': búúg béε p'égó?  
what FOC 2SG PRT buy.PERF: goat or sheep

'What did you buy: a goat or a sheep?'

- c. Q: \*Bó ní fù dá dā': búúg béε pé'úgǝ?  
 what FOC 2SG PRT buy.PERF: goat or sheep  
 'What did you buy: a goat or a sheep?'
- d. Ans: Búúg kà m̀ dá dā'.  
 goat FOC 1SG PRT buy.PERF  
 'It is *a goat* that I bought' (not a sheep)
- e. Ans: \*Búúg né m̀ dá dā'.  
 goat FOC 1SG PRT buy.PERF  
 'It is *a goat* that I bought' (not a sheep)
- f. Ans: \*Búúg ní m̀ dá dā'.  
 goat FOC 1SG PRT buy.PERF  
 'It is *a goat* that I bought' (not a sheep)
- (7) a. Q: Ànó'ón bííg kà f̀ ìēdá: Àsíbí béε Àdúkǝ?  
 who child FOC 2SG search Asibi or Aduko  
 'Whose child are you after: Asibi or Aduko?'
- b. Ans: Àsíbí bííg kà m̀ ìēd.  
 Asibi child FOC 1SG search  
 'It is *Asibi's child* I am after.'

The question in (6a) is an example of a contrastive *wh*-focus construction with a set of alternatives. The response equally conveys a strong contrastive focus interpretation by excluding other alternatives from what is bought to 'a goat' and not, for instance, 'a sheep'. The use of *kà* in *wh*-questions as well as in fronted focused items causes a contrastive focus interpretation of the focused constituent. It is implied that the particle *kà* serves as a contrastive focus particle in Kusaal in ways similar to the particle *ka* in Dagbani (Hudu 2012).

### 2.2.2 In-situ focus marking with *né*

The particle *né* can be used with the object NP, the VP as well as the entire IP. Whenever focus is expressed on the entire IP, *né* occurs at the end of the entire clause and has its scope spread across the whole construction. However, when focus is expressed on an object NP or an adverbial, the particle occurs before the object NP, thus after the verb (8b), and before the locative adverbial adjunct or complement (9b). The particle *kà* cannot be used in-situ, nor can the particle *ní* substitute *né*. This explains the ungrammaticality of the examples in (8c-d).

- (8) a. Q: Bó kà pú'á lá sà dā' dá'á-n lá?  
 what FOC woman DEF. PRT buy.PERF market-LOC DEF.  
 'What did the woman buy at the market?'
- b. Ans: Pú'á lá [<sub>VP</sub> sà dā' né núá ] [<sub>PP</sub> dá'á-n lá.]  
 woman DEF PRT buy.PERF FOC fowl marke-LOC DEF.  
 'The woman bought a *fowl* at the market'
- c. Ans: \*Pú'á lá sà dā' kà núá dá'á-n lá.  
 woman DEF PRT buy.PERF FOC fowl marke-LOC DEF.  
 'The woman bought a *fowl* at the market'
- d. Ans: \*Pú'á lá sà dā' n' núá dá'á-n lá.  
 woman DEF PRT buy.PERF FOC fowl marke-LOC DEF.  
 'The woman bought a *fowl* at the market'
- (9) a. Q: Yà kà pú'á lá sà dā' núá lá?  
 where FOC woman DEF. PRT buy.PERF fowl DEF  
 'Where did the woman buy the fowl?'
- b. Ans: Pú'á lá sà dā' [<sub>NP</sub> núá lá] né [<sub>PP</sub> dá'á-n lá].  
 woman DEF PRT buy.PERF fowl DEF FOC market-LOC DEF  
 'The woman bought the fowl *at the market*'
- (10) a. Q: Bó kà Àdólúbà sà mǎǎle?  
 what FOC Adoluba PRT do.PERF  
 'What did Adoluba do?'
- b. Ans: Àdólúbà [<sub>VP</sub> sà kūl né.]  
 Adoluba PRT go-home.PERF FOC  
 'Adoluba went-home.'
- (11) a. Q: Bó mǎǎle?  
 what make/do.PERF  
 'What happened?'
- b. Ans: [<sub>IP</sub> Bís lá dī dīb lá né.]  
 child DEF. eat.PERF food DEF FOC  
 'The children ate the food.'(an unexpected occurrence)

In (10b–11b) the particle *né* assumes an IP internal right position with a scope that extends to cover the entire construction. It is equally possible to have *né* focusing the object DP in instances such as below.

- (12) a. Q: Bó kà Àdólúbá dā'ā?  
           what FOC Adoluba buy.PERF  
           ‘What did Adoluba buy?’  
       b. Ans 1: Àdólúbá dā' né núá.  
               Adoluba buy.PERF FOC fowl  
               ‘Adoluba bought *a fowl*’  
       c. Ans 2: Àdólúbá dā' núá né.  
               Adoluba buy.PERF fowl FOC  
               ‘Adoluba bought *a fowl*’

The example in (12b) serves as the expected response to the question in (12a). The particle *né* occurs before the focused item and causes an exhaustive/contrastive interpretation of the item bought. On the other hand, the example in (12c), where the particle occurs after the focused object DP, can be used in a context where *Adoluba* is known for not buying anything when he is visiting. This time around he surprises everybody by buying ‘*a fowl*’.

To account for the word order variation, it is assumed that *né* behaves as an adnominal selected by the NP/DP or PP it modifies (see Renans 2016:§3). It behaves as an adverbial when it modifies VPs and IPs, in which case it merges with the entire IP or VP as illustrated below.

- a. *né* [NP/DP].....Adnominal *né*  
 b. [VP ] *né* ..... Adverbial *né*  
 c. [IP ] *né* ..... Adverbial *né*

### 2.3 In-situ focus marking with *ń*

The particle *ń* is restricted to subject focus. It is expected to occur after all subject NPs or DPs deemed to have an exhaustive/contrastive focus interpretations.

It is infelicitous to use the particles *né* and *kà* in focusing subject constituents, as shown in (13b-c).<sup>3</sup>

<sup>3</sup>A reviewer raised a question as to whether subject focus involves any form of movement in Kusaal. The situation is not immediately clear for the following reasons:

(1) Assuming that subject focus has the structure: [<sub>FocP</sub> n [<sub>TP</sub> Subj [VP OBJ]]], the hypothesis is that the subject moves from Spec TP to Spec FocP, triggered by both Agree and EPP features on FocP.

(2) A problem arises when the subject is substituted by other elements such as the *wh*-phrases *ànw'ən(ε)* 'who' and *bɔɔ* 'what'. It is ungrammatical to focus the *wh*-phrase as subject with the subject focus particle *ń*, as in (ii) and (vi), though the constituent that corresponds to the *wh*-phrase in the answer to the question can be focused with *ń* as in (iii) or it can be left bare as in (iv).

- |  |  |
|--|--|
| <p>(i) Ànɔ́'ónè dī dííb lá?<br/>         who eat.PERF food DEF<br/>         'Who ate the food?'</p>                              | <p>(ii) *Ànɔ́'ónè ń dī dííb lá?<br/>         who FOC eat food DEF</p>                                      |
| <p>(iii) Ans: Pú'á lá ń dī dííb lá.<br/>         woman DEF FOC eat food DEF<br/>         'It is the woman who ate the food.'</p> | <p>(iv) Pú'á lá dī dííb lá.<br/>         woman DEF eat food DEF<br/>         'The woman ate the food.'</p> |
| <p>(v) Bɔ́ɔ ɔ́nb váánd lá?<br/>         what chew leaves DEF<br/>         'What chewed the leaves?'</p>                          | <p>(vi) *Bɔ́ɔ ń ɔ́nb váánd lá?<br/>         what FOC chew leaves DEF</p>                                   |

However, it is grammatical to focus *wh*-phrases, using the non-subject focus particle *né*, if they happen to be objects of the sentence.

- (vii) Àdúk bŭ né ànw'ənè?  
 Aduk beat.PERF FOC who  
 'Who (specifically) did Aduk beat?'
- (viii) Búóg lá ɔ́nb né bɔ́ɔ?  
 goat DEF chew FOC what  
 'What (specifically) did the goat chew?'

The situation is unclear in view of the fact that *wh*-phrases cannot co-occur with the focus particle *ń* in subject position, even though it is grammatical to have the non-subject focus particle *né* co-occurring with the same *wh*-phrases at object position. One cannot argue that *wh*-phrases in subject position have the structure in (1) even though the constituents in the answer which correspond to the *wh*-phrase can be focused using *ń*. I therefore assume the vacuous movement hypothesis and argue that subject focus in Kusaal is an instance of in-situ focus until further evidence is found to counter this assumption.



- (13) a. Dáú lá *ń* dā' bʋʋg lá.  
 man DEF FOC buy.PERF goat DEF  
 'The man bought the goat (not the woman)'
- b. \*Dáú lá *né* dā' bʋʋg lá.  
 man DEF FOC buy.PERF goat DEF  
 'The man bought the goat (not the woman)'
- c. \*Dáú lá *kà* dā' bʋʋg lá.  
 man DEF FOC buy.PERF goat DEF  
 'The man bought the goat (not the woman)'

- (14) Dáú *ń* bēē dǔǔgin lá.  
 man FOC COP.be room-LOC DEF  
 'A man is in the room (not a woman)'  
 'A brave man is in the room (not a coward).'

The particle *ń* also cliticizes on subject pronouns to form strong or emphatic forms.<sup>4</sup>

- (15) Ón sá dā' núá lá  
 3SG-EMPH PRT buy.PERF fowl DEF  
 'S/he bought the fowl'

In (15), the focus particle is attached to the subject pronoun to create the emphatic form *on/ɔn* '3SG.EMPH'. The emphatic pronoun is not exclusive in its interpretation. In fronting, it occurs with *kà* and in in-situ focus it co-occurs with the adverbials *má'áá* 'alone, only, just' and *kun-kun* 'just' for an exclusive interpretation as illustrated in (16–17). This will be further discussed in §4.1.

- (16) Ón *kà* m̄ bǔǔd.  
 3SG-EMPH FOC 1SG like  
 'It is *him/her* that I like (not any other person).'
- (17) Ón *má'áá* dá dā' núá lá  
 3SG-EMPH alone PRT buy.PERF fowl DEF  
 'S/he alone bought the fowl.'

<sup>4</sup>Subject pronouns and their corresponding emphatic forms: m/man '1SG/1SG.EMPH' fu/fun '2SG/2SG.EMPH' ɔ/ɔn '3SG/3SG.EMPH' ti/tinam '1PL/1PL.EMPH', ya/yanam '2PL/PL.EMPH', ba-ban/banam '3PL./3PL.EMPH'

In this section, the various ways of packaging both information and contrastive focus in Kusaal have been demonstrated. It has been shown that Kusaal does not have an overt grammatical focus particle and whereas information focus is morphologically null, contrastive focus is marked using the particles *kà*, *ń* and *né*. The particles *kà*, *ń* and *né* are purposely used to convey contrastive/exhaustive focus any time they occur in a construction with focus interpretation. Whereas *kà* is used for fronted DPs and NPs, *ń* and *né* are used in-situ: *ń* for subject NPs, and *né* for object NPs, VPs as well as IPs. In the following section, the particles *kà*, *ń* and *né* are subjected to several tests for exhaustivity to ascertain their true statuses as contrastive/exhaustive focus particle in Kusaal.

### 3 Tests for exhaustivity

Several standard tests are used in the literature in testing exhaustive focus. In this section, I demonstrate how some of these tests are used to justify the claim that the particles *kà*, *ń* and *né* are indeed contrastive/exhaustive focus particles in Kusaal. In all focus constructions with the aforementioned particles in the language, there is a conversational implicature that the answer to the question/subject under discussion is the strongest true answer (Beaver & Clark 2008; Roberts 2012). The following are accounts of some tests on the particles: *kà*, *ń* and *né* in Kusaal.

#### 3.1 Natural context/Spontaneous speech context

This test is in line with what van der Wal (2014) refers to as “Heuristic: Context conjuring”. It is considered as one of the simplest tests for focus diagnostics in languages. This test involves the creation of contexts or scenarios where speakers are presented with situations that will naturally incite/ elicit responses with contrastive focus interpretations. Another angle is to present speakers with utterances with a (contrastive) focus interpretation and ask their intuitions about when these utterances could be used felicitously or more naturally (van der Wal 2014: 5). The following contexts, (18) and (19), generate the responses in examples (18a–b) and (19a) respectively.

- (18) Context i: There are two animals, a goat and a sheep, and you ask which one the man bought (contrast).  
Context ii: You expect the man to buy a sheep. (The responses could be used as corrections because the hearer believes something different. It could also be used to show surprise in unexpected situations).

- a. Dáú lá sà dā' né búúg.  
 man DEF PRT buy.PERF FOC goat  
 'It is a goat the man bought.'
- b. Búúg kà dāú lá sá dā'.  
 goat FOC man DEF PRT buy.PERF  
 'It is a goat the man bought.'

(19) Context i: There are two people, a man and a woman. Which one of them bought a goat? (contrast)

Context ii: You expect the woman to buy a goat (correction/unexpectedly)

- a. Dáú lá ní sá dā' búúg.  
 man DEF FOC PRT buy.PERF goat  
 'It is the man that bought a goat.'

The examples in (18–19) are naturally produced by speakers under the proposed contexts with the use of the particles *kà*, *ní* and *né*. These sentences convey both contrastive and exhaustive focus interpretations. It is infelicitous to respond to the questions under the supposed contexts without using these particles.

### 3.2 Coordination

Szabolcsi (1981) uses coordination in order to identify exhaustive focus in Hungarian. Duah (2015) applies this technique to data in Akan, a Kwa language, with similar results. In my own test, I use a pair of sentences: one with a focused coordinated DP (20b–c) and another one where one of the coordinated DPs is dropped (20d–e). With exhaustive focus, the second sentence without the coordination cannot be a logical consequence of the first one. In the answers to question (20a), I use both *ex-situ* and *in-situ* contrastive/exhaustive particles *kà* (20b) and *né* (20c) in comparison with *in-situ* focus without these particles (21a).

- (20) a. Q: Bó kà dāú lá dā'ā?  
 what FOC man DEF. buy-PERF  
 'What did the man buy?'
- b. Ans1: Búúg né nááf kà dāú lá dā'ā.  
 goat CONJ cow FOC man DEF. buy-PERF  
 'It is a goat and a cow that the man bought.'

- c. Ans2: Dáú lá dā' né búúg né nááf.  
 man DEF buy.PERF FOC goat CONJ cow  
 'It is *a goat* and *a cow* that the man bought.'
- d. Ans3: #Búúg kà dáu lá dā'.  
 goat FOC man DEF buy-PERF  
 'It is *a goat* that the man bought'
- e. Ans4: #Dáú lá dā' né búúg.  
 man DEF buy.PERF FOC goat  
 'It is *a goat* that the man bought'

- (21) a. Ans1: Dáú lá dā' búúg né nááf.  
 man DEF buy.PERF goat CONJ cow  
 'The man bought *a goat* and *a cow*.'
- b. Ans2: Dáú lá dā' búúg.  
 man DEF buy-PERF goat  
 'The man bought *a goat*.'

If the utterances in (20b-c), in which the coordinated NPs *a goat and a cow* are focused with the particles *kà* and *né* respectively, are given by a speaker, this speaker cannot give the responses in (20d-e) as partial descriptions of the former since this will amount to a contradiction. This arises due to the presence of the particles *kà* and *né* which contrastively/exhaustively express the number of items bought to be two: 'a goat and a cow'. However, if the speaker had used the construction in (21a) where 'a goat' and 'a sheep' are focused in-situ (suprasegmentally) without the use of *kà* or *né* then the answer in (21b) can also be given as a partial response to the question in (20a)<sup>5</sup>.

### 3.3 Numerals

Using a variation of the coordination test with focused numerals (see Szabolcsi 1981; É. Kiss 1998) where a numeral is added to the noun and focused in instances where focus is exhaustive, the focused entity must be equal to the original entity in number; if not there will be contradiction in the sentence. The scope of the quantifier interprets as 'exactly' in exhaustive focus environments whereas it interprets as 'at least' in non-exhaustive environments in Kusaal. (see Szabolcsi 1981: 155).

<sup>5</sup>See Duah (2015) for a similar analysis of data from Akan.

The sentence in (22b) suggests that the number of people who went to the market is five. But (22c) which follows from (22b) shows that if five people went to the market then at least three people went to the market.

- (22) a. Q. Nídíb àlà sà kēŋ dá'á lá?  
 people how.many PRT go.PERF market DEF  
 'How many people went to the market?'
- b. Ans1: **Nídíb ànú** sà kēŋ dá'á lá.  
 people five PRT go.PERF market DEF  
 'Five people went to the market'
- c. Ans2: **Nídíb àtán'** sà kēŋ dá'á lá.  
 people three PRT go.PERF market DEF  
 'Three people went to the market'

The logical conclusion from the interpretations of (22b-c) further reveals that the semantics of numerals is not always exact. It could be either the exact amount or a lower boundary (Horn 1972; Levinson 2000; cf van der Wal 2014: 15).

In contrast, the contrastive and exhaustive focus particles; *kà*, *ń* and *né*, make it impossible for numerals to maintain their upward entailing quality and as such they only refer to the exact quantity of the number (see van Kuppevelt 1996; van Rooij 2002; van Rooij & Schulz 2004).

- (23) a. Q. Nídíb àlà sà kēŋ dá'á lá?  
 people how.many PRT go.PERF market DEF  
 'How many people went to the market?'
- b. Ans1: **Nídíb ànú ń** sà kēŋ dá'á lá.  
 people five FOC PRT go.PERF market DEF  
 'It was *five people* who went to the market.'
- c. Ans2: Nídíb àtán' **ń** sà kēŋ dá'á lá.  
 people three FOC PRT go.PERF market DEF  
 'It was *three people* who went to the market.'

The answer in (23b) contradicts (23c) because (23b) implies that exactly five people went to the market, whilst (23c) implies that exactly three people went to the market.

The different interpretations of the answers to the same questions (22a) and (23a) are due to the types of focus expressed by the answers to these questions.

Whereas the answers to the question in (22a) express information focus, the answers to the question in (23a) express exhaustive/contrastive focus using the particle *ń* for subject focus. The answers in (23b-c) suggest the impossibility of using the exhaustive focus marker in identifying a single entity out of a plural group (Hartmann & Zimmermann 2007: 253). This suggests that the particles identified are contrastive and exhaustive focus particles in Kusaal.

### 3.4 Weak quantifiers

The indefinite quantifiers *sí'á/siéba* 'some' and *bí'él/bí'élá* 'a few' cause a narrow focus interpretation whenever they co-occur with the contrastive/exhaustive focus particles *kà*, *ń* and *né* in Kusaal. This, as also observed by Skopeteas & Gisbert (2010: 1387; cf van der Wal 2014), is because "the definite quantifiers 'some' and 'a few' are upward entailing, i.e. they imply that the denoted quantity reaches at least a minimum from a scale of potential quantities" (cf van der Wal 2014: 15).

- (24) Tì sà pāām lígídi lá síébá.  
3PL PRT get.PERF money DEF some  
'We got the/some of the money'  
(..., so we can solve the problem)  
#(..., so we cannot solve the problem)

The upward entailment quality of the quantifier in (24) makes it possible to interpret the sentence as 'receiving/getting all the required money or getting at least a substantial amount of the required money which can be used to address the situation at hand'.

On the other hand, when the contrastive or exhaustive focus particles *kà*, *ń* and *né* are used with the indefinite quantifiers, *si'a/sieba* 'some', the derived interpretation excludes the upward entailing quality of the quantifier, resulting in an interpretation with a narrow focus (25b).

- (25) a. Lígídi là síébá kà tì sá pāām.  
money DEF some FOC 3PL PRT get  
'It is some/part of the money we got.'
- b. Tì sà pāām né lígídi lá síébá.  
3PL PRT get FOC money DEF some  
'It is some/part of the money we got.'  
# (..., so we can solve the problem)  
(..., so we cannot solve the problem)

### 3.5 Part as a whole relationship

Unlike instances involving non-exhaustive focus when a part can be used in connection to a whole as illustrated in (26b), which is an answer to (26a), it is illogical and illicit to use the exhaustive particles *ní* and *né* after a focused entity, (26c), which captures part of a whole group (wider entity). Hartmann & Zimmermann (2007: 253) refer to this context as the “mention-some environment”. Consider the scenario below and the question and answer that follow it.

(26) Context: *Asibi* is looking for a child to send on an errand. There are a lot of children playing at the playground. For lack of time, she only wants to get the name of one of them and she finds out from *Akuda*:

- a. Q: Àsíbí: fù mí' báne díém yíŋ lá?  
2SG know those play-IMPERF outside LA  
'Do you know those playing outside?'
- b. Ans 1: Àkúdà: één, Àzúmà bēē bà sùgi-n.  
Yes, Azuma COP.be their middle-LOC  
'Azuma is among them'
- c. Ans 2: Àkúdà:? één, Àzúma m bēē bà sùgi-n.  
Yes, Azuma FOC COP.be their middle-LOC  
'It is Azuma who is among them.'

*Akuda* in (26b) mentions the name of a child who is among the children who are playing. In this context it would be contradictory as well as illogical to use the exhaustive in-situ subject particle *m* (=/*ní*/), as in (26c), since it would capture only part of the entire group of children playing outside. What this implies is that the stronger the effect of an exhaustive focus interpretation, whether by implicature or in the semantics, the less appropriate it will be as a response to a mention-some question (see van der Wal 2014: 10).

## 4 “Strongly exhaustive” and “Weakly exhaustive” particles

There appears to be a subtle difference in the statuses of the exhaustive particles *kà* on the one hand and *ní* and *né* on the other. Available data reveal a tendency for the particles *ní* and *né* to be inherently “strongly exhaustive” compared to the particle *kà*, which is only inherently contrastive and exhaustive by implicature, hence referred to as “weakly exhaustive”. The tests in sections §4.1 and §4.2

show that whereas *ń* and *né* are in complementary distribution with exhaustive adverbial particles as well as exhaustive additive particles, the particle *kà* freely co-occurs with both adverbial and additive particles.

#### 4.1 The omission of *ń*, *né* in the environment of adverbials

The adverbials *má'áa/má'áane* 'only, just, alone', *kun-kun* 'only/just', *zaŋ-zaŋ* 'only' correlate with an exhaustive focus interpretation such that all other alternative possibilities are excluded from the reading (see Rooth 1985; 1992; Krifka 2006; van der Wal 2014, among others). The particles *ń* and *né* are often in complementary distribution with the exhaustive adverbial particles on the grounds of redundancy. This trend is consistent with the observation made by Hartmann & Zimmermann (2007: 256), Jaggar (2001: 511) and Newman (2000: 190) that the exhaustive particles *nee/cee* in Hausa are often omitted in the environment of other adverbials.

- (27) *Bíís lá má'áá (ń) sà dī mùì lá.*  
children DEF only FOC PRT eat.PERF rice DEF.  
'Only the children ate the rice.'

- (28) *Bíís lá sà dī (né) mùì lá má'áá.*  
children DEF PRT eat.PERF FOC rice DEF only  
'The children ate only the rice.'

The particle *kà*, on the other hand, must obligatorily co-occur with the adverbial when the focused constituent is fronted.

- (29) *Mùì kà bíís lá dī.*  
rice FOC children DEF eat.PERF  
'It is rice that the children ate.' (not, say, beans)

- (30) *Mùì má'áa kà bíís lá dī.*  
rice only FOC children DEF eat.PERF  
'It is only rice that the children ate.' (and nothing else)  
\**Mùì má'áa bíís lá dī.*  
rice only children DEF eat.PERF



From the exhaustive interpretation derived from the use of the adverbials, it is obvious that these elements are used to introduce exhaustivity into the assertion as part of its truth conditions (Hartmann & Zimmermann 2007). The open option available to speakers to use or not to use *ń* and *nɛ* (whilst *kà* is obligatory) suggests that the particle *kà* is semantically weaker in expressing exhaustivity than the particle *nɛ*.

The lack of exhaustivity in the interpretation of the emphatic pronoun, as indicated elsewhere, explains the grammaticality of having the exhaustive adverbial marker *má'áá* 'only' co-occur with the third person emphatic pronoun *ón* as in (31).

- (31) Ón má'áá (\*ń) tǔm tǔmá lá.  
 3SG lone FOC work work-Nomimative DEF  
 'S/he alone did the work.'

#### 4.2 Restrictions on *ń*, *né* with exhaustive additive particles

The exhaustive focus particles *ń*, and *né* do not co-occur with the additive particles *mén/mé* 'also, too' or *yá'ási* 'else, again'. This is because the additive particles make the referent non-exhaustive in the sense that the action of the verb is assumed to have taken place with different/other referents.

- (32) a. Ànó'ón yá'ási (\*n) sá kārīm gbàùŋ lá?  
 who else FOC PRT read.PERF book DEF  
 'Who else read the book yesterday?'  
 b. Àsíbí mé (\*n) sá kārīm gbàùŋ lá.  
 Asibi also FOC PRT read.PERF book DEF  
 'Asibi also read the book yesterday.'

Unlike *ń* and *né*, which do not co-occur with the exhaustive focus additives, it is grammatical to have *kà* in fronted wh-focus questions as well as with fronted DPs co-occurring with the exhaustive focus additive *yá'ási* 'else' (34) and *mé* 'also' (35–36).

- (33) Bóbín yá'ási kà Asibi sá kārīm.  
 what else FOC Asibi PRT read.PERF  
 'What else did Asibi read yesterday?'

- (34) Àsíbí sá kārīm (\*nÉ) gbàùŋ lá mé.  
Asibi PRT read.PERF FOC book DEF also  
'Asibi read the book also yesterday/it was also the book that Asibi read yesterday.'
- (35) Gbàùŋ lá mé kà Àsíbí sá kārīm.  
book DEF also FOC Asibi PRT read.PERF  
'It is also the book that Asibi read yesterday.'
- (36) Gbàùŋ lá kà Àsíbí sá kārīm mé.  
book DEF FOC Asibi PRT read.PERF also  
'It is also the book that Asibi read yesterday/ it was also reading the book that Asibi did'

Since an item or a situation is either exhaustive or additive but not both, the grammaticality of *kà* co-occurring with the additive exhaustive particles *yá'ás* 'else' and *mÉ* 'also' further shows that the particle *kà* has a weaker exhaustive focus interpretation in Kusaal.

## 5 Conclusion

Returning to the questions raised at the beginning of this paper, it is now possible to state that Kusaal does not have a default grammatical focus marker and that the language employs two different strategies in the packaging of discourse related information. Whereas information focus is morphologically null, contrastive focus is marked using the particles *kà*, *ń* and *nÉ*. The particle *kà* is used for ex-situ contrastive/exhaustive focus marking and the particles *ń* and *nÉ* are also used for in-situ contrastive/exhaustive focus marking. The evidence from all the tests suggests that the particles *kà*, *ń* and *nÉ* encode strong contrastive focus, leading to the assumption that there are indeed contrastive focus particles in Kusaal. On exhaustivity, the study shows that whereas the particles *ń* and *nÉ* evoke a strong exhaustive focus interpretation, the particle *kà* evokes a weak exhaustive focus interpretation. The reason is that *ń* and *nÉ*, unlike *kà*, are in complementary distribution with the exhaustive adverbial particles and additive particles in Kusaal.

## Acknowledgements

I gratefully acknowledge funding support from: The Global African Research Platform, Research Services and Career Development Center, and the Department of African Studies all of the University of Vienna. I am equally grateful to Adams Bodomu, Malte Zimmermann, Mira Grubic as well as two anonymous reviewers and the team at ACAL 47 for their helpful comments and suggestions not forgetting John Rennison for proofreading as well as useful comments. My sincere gratitude also goes to Micheal Awimbila (GILLBT) for his relentless effort in making sure that data used in this work reflect both spoken and written Kusaal.

## Abbreviations

DEF	definite determiner	DEM	demonstrative
PRT	temporal adverbial particle	REL	relative
PL	plural	POSS	possessive
SG	singular	Q	question
FOC	focus particle	A	answer
CONJ	conjunction	LOC	locative,
PERF	perfective	EMPH	emphatic
FUT	future	FACT	factive marker

## References

- Aboh, Enoch. 2007. Focused versus non-focus wh-phrases. In Enoch Oladé Aboh, Katharina Hartmann & Malte Zimmermann (eds.), *Focus strategies in African languages: the interaction of focus and grammar in Niger-Congo and Afro-Asiatic*, vol. 191, 287–314. Berlin/New York: Mouton de Gruyter.
- Abubakari, Hasiyatu. 2011. *Object-sharing as symmetric sharing: Predicate clefting and serial verb constructions in Kusáàl*. Tromsø: University of Tromsø. (MPhil Dissertation).
- Beaver, David & Brady Clark. 2008. *Sense and sensitivity: How focus determines meaning*. Oxford: Wiley-Blackwell.
- Bodomu, Adams. 1997. *The structure of Dagaare* (Stanford Monographs in African Languages). Stanford, CA: CSLI Publications.

- Chafe, Wallace. 1976. Givenness, contrastiveness, definiteness, subjects, topics, and point of view. In Charles N. Li (ed.), *Subject and topic*, 25–55. London/New York: Academic Press.
- Duah, Reginald A. 2015. Exhaustive focus marking in Akan. In Felix Bildhauer & Mira Grubic (eds.), *Mood, exhaustivity and focus marking in non-European languages*, 1–28. Potsdam: Universitätsverlag Potsdam. Interdisciplinary Studies on Information Structure.
- É. Kiss, Katalin. 1998. Identificational focus versus information focus. *Language* 74(2). 245–273.
- Halliday, M. A. K. 1967. Notes on transitivity and theme in English. *Journal of Linguistics* 3(1 & 2). 37–81, 199–244. Split across two numbers of the journal.
- Hartmann, Katharina & Malte Zimmermann. 2007. Exhaustivity marking in Hausa: A reanalysis of the particle *nee/cee*. In Enoch Oladé Aboh, Katharina Hartmann & Malte Zimmermann (eds.), *Focus strategies in African languages: The interaction of focus and grammar in Niger-Congo and Afro-Asiatic*, 241–263. Berlin: Mouton de Gruyter.
- Hiraiwa, Ken. 2005. Predicate clefts in Bùlì: Phase and category. *Linguistic Analysis* 32(3/4). 544–583.
- Hiraiwa, Ken & Bodom Adams. 2008. Object-sharing as symmetric sharing: Predicate clefting and serial verbs in Dagaare. *Natural Language Linguistic Theory* 26. 795–832.
- Horn, Laurence R. 1972. *On the semantic properties of logical operators in English*. Los Angeles, CA: University of California. (Doctoral dissertation).
- Horn, Laurence R. 1981. Exhaustiveness and the semantics of clefts. In Victoria A. Burke & James Pustejovsky (eds.), *Proceedings of the North Eastern Linguistic Society*, 25–142. Amherst, MA: GLSA.
- Hudu, Fusheini. 2012. Dagbani focus particles: A descriptive study. *Journal of West African Languages* 39. 97–129.
- Jaggar, Philip J. 2001. *Hausa*. Amsterdam: John Benjamins.
- Krifka, Manfred. 2006. Association with focus phrases. In Valeria Molnár & Susanne Winkler (eds.), *The architecture of focus*, 105–136. Berlin: Mouton de Gruyter.
- Krifka, Manfred. 2007. Basic notions of information structure. In Caroline Féry, Gisbert Fanselow & Manfred Krifka (eds.), *Working papers of the SFB 632, interdisciplinary studies on information structure*, 13–55. Potsdam: Universitätsverlag Potsdam.
- Levinson, Stephen C. 2000. *Presumptive meanings*. Cambridge, MA: MIT Press.

- Michael, Rochemont. 1986. *Focus in generative grammar*. Amsterdam: John Benjamins.
- Molnár, Valeria. 2002. Contrast – from a contrastive perspective. In Hilde Haselgard, Stig Johansson, Bergljot Behrens & Cathrine Fabricius-Hansen (eds.), *Information structure in a cross-linguistic perspective*, 147–161. Amsterdam/New York: Rodopi.
- Newman, Paul. 2000. *The Hausa language*. New Haven/London: Yale University Press.
- Renans, Agata M. 2016. *Exhaustivity. On exclusive particles, clefts, and progressive aspect in Ga (Kwa)*. Postdam: Universität Postdam. (Doctoral dissertation).
- Roberts, Craig. 2012. Information structure: Towards an integrated formal theory of pragmatics. *Semantics and Pragmatics* 5(6). 1–69.
- Rooth, Mats. 1985. *Association with focus*. Amherst: University of Massachusetts. (Doctoral dissertation).
- Rooth, Mats. 1992. A theory of focus interpretations. *Natural Language Semantics* 1(1). 75–116.
- Rooth, Mats. 1996. Focus. In Shalom Leppin (ed.), *The handbook of contemporary semantic theory*, 271–297. Oxford: Blackwell.
- Selkirk, Elisabeth. 2008. Contrastive focus, givenness and the unmarked status of “discourse-new”. *Acta Linguistica Hungarica* 55(3). 1–16.
- Skopeteas, Stavros & Fanselow Gisbert. 2010. Focus in Georgian and the expression of contrast. *Lingua* 120(6). 1370–1391.
- Szabolcsi, Anna. 1981. Compositionality in focus. *Folia Linguistica* 15. 141–161.
- Vallduví, Enric & Maria Vilkuna. 1998. On rheme and kontrast. In Peter Culicover & Louise McNally (eds.), *The limits of syntax*, 79–106. New York: Academic Press.
- van der Wal, Jenneke. 2014. Tests for focus. In Dina El Zarka & Steffen Heidinger (eds.), *Methodological issues in the study of information structure*, 105–134. Graz: GLS 81.
- van Kuppevelt, Jan. 1996. Inferring from topics. Scalar implicatures as topic-dependent inferences. *Linguistics and Philosophy* 19. 393–443.
- van Rooij, Robert. 2002. Relevance only. In J. Bos, M. E. Foster & C. Matheson (eds.), *Proceedings of the sixth workshop on the semantics and pragmatics of dialogue, (EDIALOG 2002)*, 155–160.
- van Rooij, Robert & Katrin Schulz. 2004. Exhaustive interpretation of complex sentences. *Journal of Logic, Language and Information* 13. 491–519.
- Zimmermann, Malte. 2008. Contrastive focus and emphasis. *Acta Linguistica Hungarica* 55(3). 347–360.



## Chapter 19

# Non-canonical switch-reference in Serer

Viktoría Apel

Humboldt-Universität zu Berlin

This paper takes a closer look at third-person pronouns in the Atlantic language Serer. In canonical affirmative clauses, the language disposes of two sets of non-locative subject pronouns. Previous descriptions of the language relate their distribution to conjugation paradigms on the one hand and/or to construction types on the other. However, an analysis of corpus data clearly contradicts these claims. The data rather provide evidence for a functional account of these pronouns relating their distribution to non-canonical switch-reference – in the sense that it deviates from the definition of prototypical instances of the latter. This finding contributes to the description of variations of switch-reference systems in general as well as to a more accurate typological profile of Serer.

## 1 Introduction

Serer is a North-Atlantic language of the Niger-Congo phylum (Segeber 2016) and is spoken by about 1.4 million people in Senegal and North-Western Gambia (Simons & Fennig 2017). As summarised in Renaudier (2012: 4), five dialects of Serer can be distinguished: Serer-Sine, Serer A’ool, Serer Jegem, Serer of Fadiouth and Palmarin, and Serer Nyomiñka. Of these five varieties, Serer-Sine and Serer Nyomiñka (Saloum region) are the most thoroughly described ones.<sup>1</sup>

One of the most prominent features of Serer’s nominal morphosyntax is its noun class system, which shows slight variation between dialects (see Renaudier 2015). Nouns are marked by a class prefix which in turn can trigger consonant mutation on the noun root (Faye 2005; McLaughlin 1994; 2000; Merrill 2014; Pozdniakov & Segeber 2006).

---

<sup>1</sup>The data used in this paper are mostly taken from Faye (1979) (Sine) and Renaudier (2012) (Nyomiñka). In addition, examples were judged and provided with contexts by Papa Saliou Sarr who is a mother tongue speaker from the town Bambey (A’ool variety).



Noun class is indexed on a number of agreement targets such as determiner stems, adjectives, relative pronouns, and numerals up to five (Renaudier 2015: 493).

Turning to the verb system, there are five slots for the composition of verb stems (see Faye & Mous 2006: 90):

- (1) **root** – (derivational suffix(es)) – **conjugation suffix(es)** – (pronoun) – (relative perfective suffix *-(ii)na*)

Finite verbs consist minimally of a root and one or more conjugation suffixes. Roots can hereby exhibit consonant mutation in order to distinguish singular from plural grammatical subjects (McLaughlin 1994; 2000). Conjugation suffixes are commonly divided into perfective and imperfective paradigms. For the sake of convenience, only the suffixes of perfective *-a* (2a) and imperfective *-aa* (2b) are distinguished in this paper.<sup>2</sup>

- (2) a. Serer-Sine (Faye 1979: 193)  
I pir-a fil le.  
1PL hit-PFV 5.stone 5.DEF  
'We hit against the stone.'
- b. Serer-Sine (Faye 1979: 217)  
I mbad-aa  
1PL beat-IPFV  
'We beat [someone].'

In the examples in (2) above, all information related to the finite verb is expressed on the verb. I refer to such verbs as "simple" verb forms. These can be differentiated from "complex" verb forms which are defined by the presence of an additional preverbal marker (3a) or by a periphrastic construction involving a locative subject pronoun (3b).

- (3) a. Serer-Sine (Faye 1979: 217)  
**Ba** nu mbad.  
IMP.NEG 2PL beat  
'Do not beat [someone]!'

---

<sup>2</sup>All examples are unified in orthography and morpheme breaks. Regardless of the source language, glosses and translations are given uniquely in English. Information which is irrelevant for this discussion is removed from the glosses. Singular/plural noun and verb roots are not distinguished. The numbering of noun classes follows Faye (1979: 118). Note that verb stems without any conjugation suffix are used as narrative perfectives.



- b. Serer-Sine (Faye 1979: 248)

**Inwe** ngum-aa a-ndok.

1PL:LOC build-IPFV 3-hut

‘We are building a hut.’

Turning to the pronominal system, first and second person subject pronouns are either preverbal – as in examples (2) and (3) – or appear as enclitics on the verb stem. The enclitic vs. preverbal distribution depends on the person, number, and conjugation paradigm involved. The third-person subject pronouns are always preverbal. In combination with affirmative verb forms, Serer has three third-person subject pronouns: *a*, *ta/te* and *da/de*. *Ta* and *da* are the variants in the Sine dialect. In Nyomiñka they are realised as *te* and *de*. *A* is used in both varieties. Whilst *ta/te* and *da/de* uniquely correspond to a singular or plural nouns respectively, *a* is insensitive to number, as shown by (4) for the Sine variety:

- (4) a. Serer-Sine (Faye 1979: 283; Papa Saliou Sarr, p.c.)

a/ta/\*da                   ret

PRO/SG:PRO/PL:PRO go

‘he/she/it went’

- b. Serer-Sine (Faye 1979: 277, 291; Papa Saliou Sarr, p.c.)

a/\*ta/da                   ndet

PRO/SG:PRO/PL:PRO go

‘they went’

Many authors relate the distribution of these three pronominal forms to conjugation paradigms and/or to construction types. In affirmative clauses with a non-focal subject, the imperfective suffix *-aa* is said to appear with *ta/da* or *te/de* only (Faye 1979: 234; Renaudier 2012: 347), as illustrated by (5) for *ta*.

- (5) Serer-Sine (Faye 1979: 283)

**ta**      ñaam-aa

SG:PRO eat-IPFV

‘she ate’

However, this analysis is contradicted by data from the same text (a folktale), as shown in (6) which is the next clause following example (5). Here, it is even the same verb stem that is preceded by the pronoun *a*.

- (6) Serer-Sine (Faye 1979: 283)

a ñaam-aa

PRO eat-IPFV

‘she ate’

A similar pronominal distribution is asserted for the complex verb form involving the preverbal marker *kaa* (example (7) below) (Faye 1979: 234; Faye & Mous 2006: 91f; Renaudier 2012: 348). *Kaa* appears in contexts where either the verb or the entire verb phrase is pragmatically in focus. The interpretation of any type of term focus – such as subject, object, adjunct, etc. – is excluded.

- (7) Serer-Sine (Faye 1979: 196; context by Papa Saliou Sarr, p.c.)

{Yoro bought a pagne.}

**Kaa**      ta      riw      pay.

NON.T.FOC SG:PRO weave 6.pagne

‘He WOVE a pagne.’

However, natural discourse data, as in example (8), reveal that the pronoun *a* is grammatical in this construction type, too:

- (8) Serer-Sine (Faye 1979: 276)

{The habitants of a village have to hide from soldiers under a bush. One woman betrays their shelter by not entering into the bush fast enough.}

**Kaa**      a      moof.

NON.T.FOC PRO sit.down

‘She SAT DOWN.’

Examples (5) to (8) above show that conjugation paradigms and construction types are obviously not a decisive factor for the distribution of the non-locative preverbal third-person subject pronouns. In the remainder of this paper I take a closer look at this phenomenon and argue for a new analysis. The argumentation is based on corpus data provided in the appendices of Faye’s (2005) and Renaudier’s (2012) works. I start by examining the third-person pronouns in Serer in §2. In addition to the description of form and function (§2.1), I also present a hypothesis for the emergence of *ta/da* and *te/de* (§2.2). I then turn to the distribution of *a*, *ta/te*, and *da/de* in discourse (§2.3). §3 deals with the theoretical classification of the phenomenon (§3.1) as well as with the scope and limits thereof (§3.2). My findings are summarised in §4.

## 2 The third-person pronouns: A closer look

### 2.1 Form and function of pronouns

As aforementioned, Serer possesses three preverbal subject pronouns for the third-person in combination with affirmative verb forms: *a*, *ta/te* and *da/de*. Whilst the pronoun *a* is insensitive to number and substitutes nouns of all classes, *ta/te* and *da/de* differentiate between singular and plural referents. *Ta/te* and *da/de* share this property with other third-person pronouns such as locative, object, possessive, and emphatic pronouns (see Table 1).

Table 1: third-person subject, object, possessive, and emphatic pronouns in Serer (Faye 1979; Renaudier 2012) (S=Serer-Sine, N=Serer Nyomiñka).

Number	Subject		Object	Possessive	Emphatic
	Non-locative	Locative			
Sg.	<i>ta</i> (S)	<i>oxe</i>	<i>=(i)n/ne</i> (S)	<i>ten/um</i> (S)	<i>ten</i> (S)
	<i>te</i> (N)		<i>=in/ten</i> (N)	<i>ten/=um</i> (N)	<i>(o) ten</i> (N)
	<i>a</i>				
Pl.	<i>da</i> (S)	<i>owe</i>	<i>(a) den</i>	<i>den</i>	<i>den</i>
	<i>de</i> (N)				

Apart from the bipartite split in number that concerns all pronouns except *a*, Table 1 shows that the pronouns *ten* and *den* are polyfunctional and appear as emphatic, possessive, and – in the Nyomiñka variety – also as object pronouns. This degree of functional conflation reflects a general trend in Serer’s nominal system, especially when compared to its closest linguistic relative Fula. Not only does Serer have fewer noun classes than Proto-Fula-Serer and present-day Fula (Merrill 2014), its nouns display also less frequently an overt morphological affix for head noun marking than those in Fula. Furthermore, Fula has distinct pronouns in the third-person for each noun class. Hence, compared to its closest relative, Serer exhibits significant reductions in these domains.

Turning again to the pronouns in Table 1, their occurrence in the clause structure is of course well determined. Object pronouns appear either as enclitics to the finite verb or they are simply postverbal.<sup>3</sup> Possessive pronouns are part of the noun phrase and occur after their head.

<sup>3</sup>The plural object pronoun *den* seems only to be preceded by the object marker *a* when the pronoun refers to humans (Renaudier 2012: 112-116).

The subject and emphatic pronouns, on the other hand, can be differentiated with respect to the clausal field in which they occur. Within the field-based approach – which provides a useful cross-linguistic (abstract) template for syntactic fields that are relevant for information structure (see Good 2010; Güldemann in prep. Apel et al. 2015) – the central field is the clause, as schematised in (9). It hosts the finite verb.

(9) [Clause]

Clause-internal constructions (as presented in all examples above) can be defined as single clauses. On the information-structural level, the canonical single clause has a topic-comment pattern. The grammatical subject is interpreted as topic.<sup>4</sup> The verb phrase represents the comment and hosts the focus information.<sup>5</sup>

The clause can be preceded by a topic field (see scheme 10 below). The topic field might host topical entities in contexts in which the topic shall be emphasised, i.e. for contrast or for signalling topic shift (see Givón 1976: 153).

(10) [Topic] [Clause]

One way of exploiting the topic field consists in placing a pragmatic argument therein via left-dislocation. Dislocation involves a resumptive pronoun in the thematic clause-internal position; this pronoun is cross-referential with the dislocated entity (Gregory & Michaelis 2001; Lambrecht 2001). An example for left-dislocation in Serer is given in (11) below. The emphatic pronoun *ten* is resumed by the preverbal subject pronoun *a*.<sup>6</sup>

(11) Serer Nyomiñka (Renaudier 2012: 53)

[Ten]<sub>Topic</sub> a-ñaam-a maalo.

SG:EMPH PRO-eat-PFV 7.rice

‘[As for] him, he ate rice.’

In the next section I argue that this construction is the grammatical source of the pronouns *ta/da* and *te/de*.

---

<sup>4</sup>In this paper TOPIC is defined as that entity in a sentence about which something is predicated (following Strawson 1964; Hornby 1971; Dik 1997; Reinhart 1982; Lambrecht 1994).

<sup>5</sup>Applying the functional framework, FOCUS is defined as “that information which is relatively the most important or salient in the given communicative setting” (Dik 1997: 326).

<sup>6</sup>Note that Renaudier (2012) analyses *a* as an affix (see §2.2).

## 2.2 Emergence of *ta/da* and *te/de*

Before turning to pronominal subject topics, it might be useful to review nominal subject topics in Serer first. Within the single clause, nominal grammatical subject topics appear in a preverbal position. When the verb is conjugated in an affirmative paradigm, nominal subjects of all noun classes are obligatorily followed by the pronoun *a*, as illustrated by the two examples in (12) below.<sup>7</sup>

- (12) Serer-Sine (Faye 1979: 289)  
 {The Tukulors, the Serer, and the Juula are related.}
- a. Dukloor we a ndef siriif.  
 2.Tukulor 2.DEF PRO be 2.Muslim  
 ‘The Tukulors are Muslims.’
- b. Sereer ke a yer-aa.  
 9.Serer 9.DEF PRO drink-IPFV  
 ‘The Serer are animists [i.e. not Muslims].’, lit. ‘The Serer drink [alcohol].’

I assume that this canonical marking of clause-internal nominal subject topics in Serer is the result of the grammaticalisation of a left-dislocation construction. The respective grammaticalisation path is schematised in (13) below. In the left-dislocation construction, the dislocated noun phrase in the preclausal topic field – which might also be set off prosodically by a pause (indicated by #) – is resumed clause-internally by an anaphoric subject pronoun. After grammaticalisation the nominal topic is reinterpreted as a clause-internal grammatical subject. Now the former subject pronoun no longer functions as a pronoun but expresses rather some sort of agreement with the (true) grammatical subject.<sup>8</sup>

- (13) Grammaticalisation path for nominal subject topics (adapted from Givón 1976: 155)  
 [the man]<sub>Topic</sub> # [he came]<sub>Clause</sub> > [the man he(-)came]<sub>Clause</sub>

<sup>7</sup>There is an asymmetry between affirmative and negative paradigms: with negative paradigms nominal grammatical subjects are not followed by *a*. Note that focal pragmatic subject noun phrases do not trigger the presence of *a* either. The same is true forthetic statements in Sasse’s (1987) sense in which *a* is ungrammatical, too.

<sup>8</sup>This grammaticalisation path is cross-linguistically well attested; a similar development has been described for the subject markers in Bantu languages (Benue-Congo) (see, e.g., Morimoto 2008).

Taking the grammaticalisation path in (13) above as a basis, the question arises as to the status of Serer's preverbal *a* after grammaticalisation.<sup>9</sup> It is plausible to assume that in the presence of a nominal subject, *a* is a bound morpheme being part of the verb stem. Accordingly, the free pronoun *a* underwent grammaticalisation resulting in a bound (agreement) prefix. This analysis is adopted, i.a., by Renaudier (2012), Neely (2013), and Heath (2014) who describe the Nyomiñka variety. Interestingly, Faye (1979) who provides a morpho-syntactic study of the Sine dialect treats *a* as a free weak pronoun (also Faye & Mous 2006). The different analysis of *a* seems to reflect in fact its different stage of grammaticalisation in the dialects. Nevertheless, historically, it has most likely been a free morpheme in both language varieties.

Departing from the presumption as sketched in (13) above, the emergence of the subject pronouns *ta/da* and *te/de*, respectively, proceed along similar lines. In Serer-Sine *ta* is probably the contracted form of the singular emphatic pronoun *ten* and the clause-internal pronoun *a* within the left-dislocation construction; *da* is the contracted form of the plural emphatic pronoun *den* and *a*.<sup>10</sup> This path is illustrated in (14) for *ta*.

- (14) Emergence of *ta* in Serer-Sine  
 [Ten]<sub>Topic</sub> [a ñaam-a maalo.]<sub>Clause</sub> > [Ta ñaam-a maalo.]<sub>Clause</sub>  
 SG:EMPH PRO eat-PFV 7.rice SG:PRO eat-PFV 7.rice  
 '[As for] him, he ate rice.' > 'He ate rice.'

This hypothesis is supported by the observation that *ta* and *da* do not co-occur with *a* in the Sine dialect.

In Serer Nyomiñka the grammaticalisation seems to have led to the (probably optional) drop of the preverbal *a* in conjunction with a phonological reduction of the emphatic pronoun, resulting in *te* and *de* respectively. This development is sketched for *te* in the next scheme.

- (15) Emergence of *te* in Serer Nyomiñka  
 [Ten]<sub>Topic</sub> [a ñaam-a maalo.]<sub>Clause</sub> > [Te (a-)ñaam-a maalo.]<sub>Clause</sub>  
 SG:EMPH PRO eat-PFV 7.rice SG:PRO PRO-eat-PFV 7.rice  
 '[As for] him, he ate rice.' > 'He ate rice.'

<sup>9</sup>Thanks to the two anonymous reviewers for pointing out this question. The problem of distinguishing free from bound pronominal morphemes in African languages in general is discussed by Creissels (2005).

<sup>10</sup>Special thanks to Lee Pratchett for this observation.

The co-occurrence of *te* and *a* in this variety is recorded by Renaudier (2012) and John Merrill (p.c.) and illustrates the further grammaticalisation of *a* as a bound morpheme that functions as pure agreement marker.<sup>11</sup> Nevertheless, the historical account for the emergence of *ta/da*, *te/de*, and *a* as sketched in (14) and (15) above is supported by their functional role which is subject of the next section.

### 2.3 Distribution of non-locative third-person subject pronouns in discourse

This section investigates two examples from the corpora of Faye (1979) and Renaudier (2012) in order to exemplify the distribution of the pronouns *a* and *ta/da* or *a* and *te/de*, respectively. Starting with (16) below from Faye (1979) for Serer-Sine, this example consists of eleven clauses. It is taken from a folk tale in which a woman tries to kill her co-wife's daughter by burying her alive. Luckily an eagle observes the woman's actions. It digs out the child and raises her as its own.

(16) Serer-Sine (Faye 1979: 283)

{After she buried the child, she walked away and}

a. a-qawooc ale a gar.  
3-eagle 3.DEF PRO come  
'the eagle came.'

b. A ut=in.  
PRO dig.out=SG.PRO  
'It [=the eagle] dug her [=the child] out.'

c. A ret no mbuday ne no nqel ne.  
PRO go PREP 6.tree 6.DEF PREP 6.public.place 6.DEF  
'It went to the tree [species] at the public place.'

d. A rang m-aaga.  
PRO build.nest LOC-there  
'It built a nest there.'

e. A geek m-aaga o-ɸiy onqa.  
PRO keep LOC-there 12-child 12.DEF  
'It kept the child there.'

<sup>11</sup>At the same time, the co-occurrence provides evidence for the analysis of *ta/te* and *da/de* as free morphemes which are unlikely additionally bound to the verb stem. In fact, the large majority of authors analyse *ta/te* and *da/de* as free pronouns.

- f. A coox-a=n.  
 PRO give-PFV=SG.PRO  
 ‘It gave her [food].’
- g. Ta ñaam-aa.  
 SG:PRO eat-IPFV  
 ‘She [=the girl] ate.’
- h. A ñaam-aa.  
 PRO eat-IPFV  
 ‘She ate.’
- i. A ñaam-aa  
 PRO eat-IPFV  
 ‘She ate.’
- j. bo a maak.  
 until PRO grow  
 ‘until she was big.’
- k. Ta waaf-aa wurus iin (...)  
 SG:PRO search.for-IPFV 7.gold 1PL.POSS  
 ‘It [=the eagle] looked for our gold (and our silver, everything that increases us).’

The first clause in (16a) is a single main clause with the nominal grammatical subject topic *aqawooɕ ale* ‘the eagle’. *The eagle* has been introduced as a referent a couple of clauses before and is therefore definite. In clauses (16b-16f), *the eagle* is substituted by the pronoun *a*. In clause (16g) the singular subject pronoun *ta* appears. Pragmatically it refers to *the girl* which is the topic of this clause. In (16h-16j) the subject pronoun is again *a* (still replacing *the girl*). Finally, in (16k) the pronoun *ta* is used which again substitutes *the eagle*.

Before interpreting the example from Sere-Sine above, it might be useful to also take a look at the Nyomiñka variety. The six clauses of (17) are part of a narrative on the relationship between the Nyomiñka people and fishing.

(17) Serer Nyomiñka (Renaudier 2012: 356)

- a. Na jamaano paap ke in a-mbaal-eeg-a mbaal.  
 PREP 7.epoch 9.father 9.DEF 1PL.POSS PRO-fish-PRET-IPFV fish  
 ‘At this epoch, our fathers were fishing.’



- b. A-njeg suk.  
 PRO-have 9.boat  
 ‘They had boats.’
- c. A-ngaad-oox-a.  
 PRO-leave-MIDD-PFV  
 ‘They were nomads.’
- d. Gi-ndiig a-joot-ang-a,  
 6-rainy.season PRO-cross-HYP-PFV  
 ‘When the rainy season passed,’
- e. **de** iid-ik.  
 PL:PRO leave.at.dry.season-DIR  
 ‘they went during the dry season.’
- f. A-njeg laalaf.  
 PRO-have ambition  
 ‘They had ambition.’

In the first clause in (17a), the noun phrase *paap ke in* ‘our fathers’ is the grammatical subject of the verb *mbaaleega mbaal* ‘were fishing’.<sup>12</sup> The presence of the prefixed pronoun *a* signals the topical status of that noun phrase (see §2.2). In the next two clauses in (17b) and (17c), the pronoun *a* both times substitutes *our fathers*. In the subsequent subordinate clause in (17d), the noun *gindiig* ‘rainy season’ represents the topical subject. Then in (17e) the plural subject pronoun *de* occurs which again substitutes *our fathers*. The same noun phrase is referred to by *a* in the final clause in (17f).

The examples (16) and (17) above suggest that the distribution of the subject pronouns *a* and *ta/da* or *te/de*, respectively, is linked to the nominal referent that the pronoun substitutes. *A* is used whenever it is coreferential with the subject of the preceding clause, i.e. when there is topic continuity on the information-structural level. If the two subjects have disjoint referents – i.e. in case of topic change – in the second clause *ta* or *te* in the singular or *da* or *de* in the plural are used.<sup>13</sup> In the next section I relate these findings on the pragmatic and information-structural level to the grammatical device switch-reference which is used for reference tracking.

<sup>12</sup>Reduplication in Serer is discussed by Heath (2014).

<sup>13</sup>This distribution demonstrates that topic and subject are overlapping concepts. Whilst topics operate on the information-structural level, subjects operate on the syntactic level. In an unmarked sentence, the grammatical subject is by default the sentence topic.

### 3 Non-canonical switch-reference

#### 3.1 Theoretical classification of the phenomenon in Serer

In the past, canonical SWITCH-REFERENCE has been described mainly in American, Australian, and Papuan languages (Haiman & Munro 1983). Recent research, however, shows that switch-reference is also found on the African continent.<sup>14</sup> Prototypically, it defines constructions in which “a marker on the verb of one clause is used to indicate whether its subject has the same or different reference from the subject of an adjacent, syntactically related clause” (Stirling 1993: 1). On the functional level, it is “a device for referential tracking” in order to avoid ambiguity (Haiman & Munro 1983: xi). An often-cited example from Mojave, a Cochimí-Yuman language spoken in the South West of the United States is given in (18) below. In (18a) the subjects in the main and subordinate clause have both the same referent (same subject, SS). This is signalled by the suffix *-k* which replaces the tense marking on the first verb. In (18b) the referents of the two subjects differ (different subject, DS). This is indicated by the suffix *-m* on the first verb.

- (18) Mojave (Munro 1980: 145, in Stirling 1993: 3)
- a. Nya-isvar-**k**, iima-k.  
when-sing-ss dance-TNS  
‘When he<sub>i</sub> sang, he<sub>i</sub> danced.’
  - b. Nya-isvar-**m**, iima-k.  
when-sing-ds dance-TNS  
‘When he<sub>i</sub> sang, he<sub>j</sub> danced.’

Cross-linguistically, switch-reference marking is more likely to be found with third-person subjects than with first or second persons; in some languages switch-reference is even limited to the third-person (Haiman & Munro 1983: xi). As the data in §2.3 suggest, Serer can be aligned with such languages.

However, Serer does not have a canonical switch-reference system because switch between referents is not marked by verb morphology but by free pronouns. In the literature, pronominal marking in relation to switch-reference is discussed under the term LOGOPHORICITY.<sup>15</sup> It is defined by Stirling (1993: 1) as

<sup>14</sup>Prototypical switch-reference is for instance described by Treis (2012) for Omotic and Cushitic languages (Afro-Asiatic) in South-Western Ethiopia.

<sup>15</sup>A full discussion of the differences between the two reference tracking devices switch-reference and logophoricity is provided by Stirling (1993: 50-56).

follows: “in central cases of logophoricity, a special pronoun form is used within a reported speech context, to indicate coreference with the source of the reported speech”. In contrast to canonical switch-reference, logophoric systems have been described for various West-African languages, e.g. Ewe (Gbe) in Ghana and Togo, Kera (Chadic) in Chad and Cameroon, or Igbo (Benue-Congo) in Nigeria (*ibid.*: 311). Logophoricity in Igbo is illustrated in (19) below. The third-person pronoun in the complement clause is *yá* when it has the same referent as the pronoun in the main clause. When it has a different referent, the pronoun in the complement clause is *ọ*.

(19) Igbo (Hyman & Comrie 1981: 19)

- a. Ọ sịrì nà yá byàrà.  
he said that he.ss came  
'He<sub>i</sub> said that he<sub>i</sub> came.'
- b. Ọ sịrì nà ọ byàrà.  
he said that he.DS came  
'He<sub>i</sub> said that he<sub>j</sub> came.'

Thus two main characteristics distinguish prototypical switch-reference from prototypical logophoricity:

1. the location of marking, i.e. verb vs. pronoun, and
2. the syntactic and semantic context of marking, i.e. unspecified adjacent clause vs. embedded clause in a reported speech context.

Applying the two definitions above to the non-locative third-person subject pronouns in Serer, it becomes evident that these pronouns are in between the two. On the one hand, they resemble logophoric pronouns because they are pronominal. On the other hand, their occurrence is open to different types of adjacent clauses and is not restricted to contexts of reported speech. Because of the non-restriction of syntactic and semantic context, I relate these pronouns to NON-CANONICAL SWITCH-REFERENCE – in the sense that the system under discussion deviates from the definition of archetypal switch-reference.<sup>16</sup>

<sup>16</sup>The term SWITCH-REFERENCE in relation to the pronouns *te/de* has been firstly mentioned by Neely (2013): “Kaa shares this paradigm [=incl. the third-person pronouns *te* and *de*, VA] with certain types of subordinate clauses (particularly relative clauses), and clauses where switch-reference is indicated.”

Non-canonical systems are also found in languages that mark switch-reference by clausal coordinators, such as in Fon (Gbe) from Benin and Nigeria (Lefebvre & Brousseau 2002: 113f) or Supyire (Senufo) from Mali (Carlson 1994: 602ff). On the other hand, there are also languages that mark logophoricity by affixes on the verb, e.g. Gokana (Benue-Congo) from Nigeria (Hyman & Comrie 1981). As a consequence, cross-linguistically there might be a lot of variation that operates in between these two reference tracking categories.

However, to my knowledge, switch-reference pronouns are cross-linguistically uncommon and have only been described for a few languages, amongst which are Bafut (Grassfields) from Cameroon (Wiesemann 1982: 53), Kaulong (Oceanic) from Papua New Guinea (Crowley et al. 2011: 391), and Yiddish (Germanic) (Prince 2006: 311). Whilst in Bafut the switch-reference marking of subjects is restricted to consecutive clauses, in Kaulong it is restricted to the marking of the possessive pronoun. The data from Yiddish show a situation somewhat comparable to the one in Serer because switch-reference operates across main clause boundaries. As the two examples in (20) below reveal, “Yiddish has a pronominal form for switch-reference, *yener* ‘that [one]’ which is used to refer to something other than the Cp [preferred centre; here: topic of the preceding clause, VA] of the previous utterance” (Prince 2006: 311). Thus, in (20a), the subject pronoun is *er* when it is coreferential with the subject of the preceding clause. When the two subjects have a disjoint referent, the pronoun *yener* is used in the second clause (20b).

(20) Yiddish (Prince 2006: 311)

- a. {A guy<sub>i</sub> had to meet a certain Rubinstein<sub>j</sub> on the train.}  
Iz *er* arumgegangen oyfn peron. “[...]”.  
is he.ss went.around on:the platform  
‘So he<sub>j</sub> walked around on the platform “[...]”’
- b. {A guy<sub>i</sub> once asked a friend<sub>j</sub> of his: “[...]”}  
Makht *yener* “[...]”.  
makes that.one.DS  
‘That one<sub>j</sub> says: “[...]”’, lit. ‘That one<sub>j</sub> makes: “[...]”’

At a first glance, *er* and *yener* in Yiddish have a similar distribution as *a* and *ta/te/da/de* and in Serer. However, the Yiddish pronouns differ in (at least) two aspects. Firstly, it is unclear whether *yener* consistently marks switch-reference over a longer string of text as is the case for *ta/te/da/de*. Secondly, *yener* has a deictic semantic content. Naturally, pronouns expressing special deixis ‘this one, that

one’ or ‘the other’ are associated with referent switch (or topic change) because of their potential contrastive implicature. Although the respective pronouns in Serer do not have such a specific semantic content, they are also related to contrast. This is demonstrated in §2.2 where I suggest that these pronouns arose from emphatic pronouns in a left-dislocation construction which is inherently associated with contrast (Givón 1976: 153).

In the next section, I define the scope of the non-canonical switch-reference system in Serer and present some puzzling cases, before summarising the results in §4.

### 3.2 Scope and limits

The analysis of the available corpus data reveals the following:

- switch-reference in Serer is restricted to non-locative third-person subject pronouns and affirmative clauses;
- these pronouns are the grammatical subject and represent the pragmatic topic of the clause;
- switch-reference operates across sequential clause boundaries – such as in a sequence of pragmatic dependent clauses in narratives.

“Same subject” is expressed pronominally by the pronoun *a*.<sup>17</sup> “Different subject” is either expressed by the use of the lexical noun or by the pronoun *ta/te* in the singular and *da/de* in the plural.

In Serer-Sine, switch-reference marking is also extended to the third-person markers *tee* (sg.) and *dee* (pl.). *Tee* and *dee* are contracted forms of the pronouns *ta* and *da* and the complementiser *ee*. One of the functions of this complementiser is to introduce direct speech. An example for the use of *tee* is given in (21) where *tee* signals switch-reference with respect to the subject of the preceding affirmative clause.

- (21) Serer-Sine (Faye 1979: 285)  
 {He<sub>i</sub> said: “Is this one your mother?”}  
**Tee**            “ha?a”.  
 SG:COMP.DS no  
 ‘She<sub>j</sub> said: “No.”’

---

<sup>17</sup>Rarely a zero pronoun is recorded, too.

When direct speech is announced without referent switch, the expected pronoun *a* is used, as illustrated in (22).

- (22) Serer-Sine (Faye 1979: 284)  
{He<sub>i</sub> shaved her skull.}  
A lay=in ee: “Gayk-i kellem ke fa xa-paam axe!”  
PRO.SS say=SG.PRO COMP herd-SG.IMP 9.camel 9.DEF and 11-donkey 11.DEF  
‘He<sub>i</sub> said to her: “Herd the camels and donkeys!”’

Nevertheless, there are some puzzling exceptional instances of unexpected “same subject” or “different subject” marking in the corpus. An example of the latter is given in (23) below. Although there is no referent switch across the clause boundary, the “different subject” pronoun *ta* occurs instead of the expected “same subject” pronoun *a*.

- (23) Serer-Sine (Faye 1979: 284)  
{He<sub>i</sub> spent the day at the public place.}  
Ta lay=in: “[...]”.  
SG:PRO say=SG.PRO  
‘He<sub>i</sub> said to her: “[...]”’

Stirling (1993: 98-114) discusses such striking cases in different languages and argues that different subject marking might also express discontinuity on a pragmatic or semantic discourse level. Despite this appealing explanation, this does not seem to hold in example (23) above because this clause is both syntactically and pragmatically dependent within the narrative. Thus, there is no interruption or discontinuity from a pragmatic perspective here. For this and other reasons, further research is necessary to shed light on these exceptional cases.

Another domain which would benefit from deeper analysis is impersonal constructions. Here, the data provide no clear picture with respect to the use of the subject pronouns.

Last but not least, more investigation is needed on clausal co- and subordination. This applies to complement and adverbial clauses in particular as the present corpus was insufficient to draw meaningful conclusions on switch-reference in such contexts. Relative clauses are an exception because they show a clear restriction. Here, only the “different subject” pronouns *ta/te* and *da/de* are grammatical, as illustrated in (24) below for the singular in combination with the perfective relative *-na*. The referential status of the subject pronoun is disregarded.

- (24) Serer Nyomiñka (Renaudier 2012: 350)  
 {The same antelope<sub>i</sub> fell into the ocean. She<sub>i</sub> landed here.}  
 Ye te jees-iid-na m-eeke it, “(...)”.  
 when SG:PRO.DS arrive-DIR-REL LOC-there also  
 ‘When she<sub>i</sub> arrived here, (they waited until the next day).’

## 4 Summary

In this paper, I have presented and discussed evidence of a non-canonical switch-reference system in the domain of non-locative third-person subject pronouns in two varieties of the Atlantic language Serer. When such a grammatical subject pronoun represents the topic of an affirmative clause, it indicates whether or not it has the same referent as the subject of the immediately preceding clause.

Amongst the Atlantic languages, Serer is thus the first language for which switch-reference has been attested. Furthermore, to my knowledge, its specific type of non-canonical switch-reference has not been described for other languages as yet, neither on the African continent – where switch-reference is already a rare phenomenon (Treis 2012: 3) – nor elsewhere.

## Acknowledgments

Prior to ACAL 47, parts of this paper were presented at the African Linguistics Research Colloquium at Humboldt-Universität zu Berlin (27 October, 2015). I would like to thank my doctoral supervisor Tom Güldemann, my colleagues Ines Fiedler and Lee Pratchett, Nicholas Baier, John Merrill, as well as the audience members and two anonymous reviewers and for their useful comments and suggestions on earlier versions of this paper. In particular my thanks go to Papa Saliou Sarr for his enduring patience in judging and commenting examples of his mother tongue.

## Abbreviations

COMP	complementiser	EMPH	emphatic pronoun
DEF	definite article	FOC	focus
DIR	directional	HYP	hypothetical
DS	different subject	IMP	imperative

IPFV	imperfective	PREP	preposition
LOC	locative	PRET	preterite
MIDD	middle voice	PRO	pronoun
NEG	negative	REL	relative
NON	non	SG	singular
PL	plural	SS	same subject
PFV	perfective	T	term
POSS	possessive pronoun	TNS	tense

## References

- Apel, Viktoria, Peggy Jacob & Henok Wondimu Tadesse. 2015. A discourse-based approach to focus constructions in three African languages (Pular, Kenga, and Gamo). Paper presented at the Final Conference of the SFB 632, Humboldt-Universität zu Berlin, 9 May 2015.
- Carlson, Robert. 1994. *A grammar of Supyire*. Berlin/New York: Mouton de Gruyter.
- Creissels, Denis. 2005. A typology of subject and object markers in African languages. In F. K. Erhard Voeltz (ed.), *Studies in African typology*, 43–70. Amsterdam/Philadelphia: John Benjamins.
- Crowley, Terry, John Lynch & Malcom Ross. 2011. *The Oceanic languages*. London/New York: Routledge.
- Dik, Simon C. 1997. *The Theory of Functional Grammar. Part 1: The structure of the clause*. Berlin/New York: Mouton de Gruyter.
- Faye, Souleymane & Maarten Mous. 2006. Verbal system and diathesis derivations in Seereer. *Africana Linguistica* 12. 89–112.
- Faye, Waly. 1979. *Etude morphosyntaxique du sereer singandum (région de Jaxaw - Ñaaxar)*. Grenoble: Université des Langues et Lettres des Grenoble thesis.
- Faye, Waly Coly. 2005. La classification nominale en Sereer Singandum. *Sudlangues* 4. 82–105.
- Givón, Talmy. 1976. Topic, pronoun and grammatical agreement. In Charles N. Lee (ed.), *Subject and topic*, 151–187. New York: Academic Press.
- Good, Jeff. 2010. Topic and focus fields in Naki. In Ines Fiedler & Anne Schwarz (eds.), *The expression of information structure: A documentation of its diversity across Africa*, 35–67. Amsterdam/Philadelphia: John Benjamins.
- Gregory, Michelle L. & Laura A. Michaelis. 2001. Topicalization and left-dislocation: A functional opposition revisited. *Journal of Pragmatics* 33. 1665–1706.



- Güldemann, Tom. in prep. Dissecting predicates for focus: Towards a typology of predicate clefting, verb doubling, and co.
- Haiman, John & Pamela Munro (eds.). 1983. *Switch reference and universal grammar* (Typological Studies in Language). Amsterdam/Philadelphia: John Benjamins.
- Heath, Jevon. 2014. *Reduplication or repetition? Assertive verb doubling in Sereer* (RUC Berkeley Phonology Lab Annual Report). [http://linguistics.berkeley.edu/phonlab/documents/2014/Heath\\_Sereer.pdf](http://linguistics.berkeley.edu/phonlab/documents/2014/Heath_Sereer.pdf), accessed 2017-4-30.
- Hornby, Peter A. 1971. Surface structure and the topic-comment distinction: A developmental study. *Child Development* 42(6). 1975–1988.
- Hyman, Larry M. & Bernard Comrie. 1981. Logophoric reference in Gokana. *Journal of African Languages and Linguistics* 3(1). 19–37.
- Lambrecht, Knud. 1994. *Information structure and sentence form: Topic, focus and the mental representations of discourse referents* (Cambridge Studies in Linguistics 72). Cambridge: Cambridge University Press.
- Lambrecht, Knud. 2001. Dislocation. In Martin Haspelmath, Ekkehard König, Wulf Oesterreicher & Wolfgang Raible (eds.), *Language typology and language universals: An international handbook*, vol. 2, 1050–1078. Berlin/New York: Walter de Gruyter.
- Lefebvre, Claire & Anne-Marie Brousseau. 2002. *A grammar of Fongbe*. Berlin/New York: Mouton de Gruyter.
- McLaughlin, Fiona. 1994. Consonant mutation in Seereer-Siin. *Studies in African Linguistics* 23(3). 279–313.
- McLaughlin, Fiona. 2000. Consonant mutation and reduplication in Seereer-Siin. *Phonology* 17. 333–363.
- Merrill, John. 2014. *A historical account of the Fula and Sereer consonant mutation and noun class system*. Tech. rep. [http://linguistics.berkeley.edu/~merrill/files/Merrill\\_Fula\\_Sereer\\_Mutation.pdf](http://linguistics.berkeley.edu/~merrill/files/Merrill_Fula_Sereer_Mutation.pdf).
- Morimoto, Yukiko. 2008. From topic to subject marking: Implications for a typology of subject marking. In Helen de Hoop & Peter de Swart (eds.), *Differential subject marking*, 199–221. Dordrecht: Springer.
- Munro, Pamela. 1980. On the syntactic status of switch-reference clauses: The special case of Mojave comitatives. In Pamela Munro (ed.), *Studies of switch-reference*, 144–159. UCLA Papers in Syntax 8. Los Angeles: UCLA.
- Neely, Kelsey. 2013. *Verum focus in Sereer-Saloum*. ms.
- Pozdniakov, Konstantin & Guillaume Segerer. 2006. Les alternances consonantiques du sereer: Entre classification nominale et dérivation. *Africana Linguistica* 12. 137–162.

- Prince, Ellen F. 2006. Impersonal pronouns in French and Yiddish. In Betty J. Birner & Gregory Ward (eds.), *Drawing the boundaries of meaning: Neo-Gricean studies in pragmatics and semantics in honor of Laurence R. Horn*, 295–315. Amsterdam/Philadelphia: John Benjamins.
- Reinhart, Tanya. 1982. *Pragmatics and linguistics: An analysis of sentence topics*. Bloomington, Indiana: Indiana University Linguistics Club (IULC).
- Renaudier, Marie. 2012. *Dérivation et valence en sereer: Variété de Mar Lodj (Sénégal)*. Lyon: Université Lumière Lyon 2 dissertation.
- Renaudier, Marie. 2015. Les classes nominales en sereer. In Denis Creissels & Konstantin Pozdniakov (eds.), *Les classes nominales dans les langues atlantiques*, 469–500. Köln: Rüdiger Köppe.
- Sasse, Hans-Jürgen. 1987. The thematic/categorical distinction revisited. *Linguistics* 25. 511–580.
- Segeer, Guillaume. 2016. *A new, innovation-based classification of Atlantic languages*. Paper presented at the 47th Annual Conference on African Linguistics (ACAL), University of California, Berkeley, 25 March 2016.
- Simons, Gary F. & Charles D. Fennig. 2017. *Ethnologue: Languages of the world*. 20th edn. Dallas: SIL International. <http://www.ethnologue.com>.
- Stirling, Lesley. 1993. *Switch-reference and discourse representation* (Cambridge Studies in Linguistics 63). Cambridge: Cambridge University Press.
- Strawson, Peter F. 1964. Identifying reference and truth-values. *Theoria* 30(2). 96–118.
- Treis, Yvonne. 2012. Switch-reference and Omotic-Cushitic language contact in Southwest Ethiopia. *Journal of Language Contact* 5(1). 80–116.
- Wiesemann, Ursula. 1982. Switch reference in Bantu languages. *Journal in West African Languages* XII(2). 42–57.

## Chapter 20

# Upward-oriented complementizer agreement with subjects and objects in Kipsigis

Michael Diercks

Pomona College

Meghana Rao

Pomona College

In Kipsigis (Nilotic, Kenya), declarative-embedding complementizers can agree with both main-clause subjects (Subj-CA) and main-clause objects (Obj-CA). Subj-CA agrees with the closest super-ordinate subject (even in the context of intervening objects), cannot agree with non-subjects or embedded subjects, and yields an interpretation where the embedded clause is the main point of the utterance. Obj-CA can only target main-clause objects and can only occur on a complementizer already bearing Subj-CA; Obj-CA contributes a verum focus reading to the clause. The paper briefly considers the analytical implications of these patterns.

## 1 Introduction

While complementizer agreement (CA) is relatively rare (Baker 2008), the construction provides interesting testing grounds for the properties of the Agree relation crosslinguistically (Chomsky 2000; 2001). Perhaps the most familiar form of complementizer agreement comes from West Germanic, where the declarative-embedding complementizer agrees with the embedded subject.<sup>1</sup>

---

<sup>1</sup>See Carstens (2003) and Van Koppen (2005) for West Germanic, and see Deal (2015) for a similar downward-oriented agreement pattern on complementizers in Nez Perce (though with very different valuation patterns, resulting in Deal's proposals about *Interaction* and *Satisfaction*).



(1) West Flemish (Carstens 2003)

- a. Kpeinzen (dan-k) (ik) morgen goan.  
I-think that-I (I) tomorrow go  
'I think that I'll go tomorrow.'
- b. Kpeinzen (da-j) (gie) morgen goat.  
I-think that-you (you) tomorrow go  
'I think that you'll go tomorrow.'

Following the standard mechanisms, Carstens (2003) shows that these examples can be readily accounted for in a Probe-Goal Agree operation where the structurally higher probe (on C) searches for matching features on a c-commanded goal, after which an Agree relation values the features on the Probe (Chomsky 2001).

Kipsigis is a Nilotic language of the Kalenjin subgroup, spoken in western Kenya by roughly 2 million people (Lewis et al. 2016).<sup>2</sup> Kipsigis is verb initial, with quite flexible word order after the verb.<sup>3</sup> In contrast to West Germanic, Kipsigis shows an upward-oriented pattern of agreement where complementizers agree with the subject of the main clause.<sup>4</sup>

(2) Kipsigis (fieldnotes)

- ko-**a**-mwaa **a**-le ko-Ø-ruuja tuyā amut  
PST-1SG-say 1SG-C PST-3-sleep cows yesterday  
'I said that the cows slept yesterday.'

This pattern of CA has been described for relatively few languages, and a major contribution of this paper is to document its presence in a new language and language family. This upward-oriented CA has been most systematically investigated in Lubukusu (Bantu, Kenya), though it has also been documented in Ki-

---

<sup>2</sup>The data presented in this paper were provided by Sammy Bor and Robert Langat, collected at Pomona College by the authors from April 2015 to June 2016, and in the Fall 2015 Field Methods class.

<sup>3</sup>Bossi et al. (2018) analyze Kipsigis word order as consisting of head movement of the verb to the highest inflectional position; scrambling of discourse-prominent constituents to Spec,TP explains most of the flexibility in word order. We refer the reader to that work for data and analysis of Kipsigis core word order patterns.

<sup>4</sup>All Kipsigis data in this paper come from original fieldwork. Due to a lack of existing analyses of the clause-level tone patterns in Kipsigis, we do not transcribe tone here. To our knowledge the main grammatical role of tone is to case-mark nominative subjects (grouping Kipsigis among the marked-nominative Nilotic languages). Transcriptions are provided in IPA.

nande, Chokwe, Luchazi, Lunda, and Luvale (central Bantu languages), Ikalanga (southern Bantu), Ibibio, and some Mande languages (Baker 2008; Diercks 2013; Kawasha 2007; Idiatov 2010; Torrence 2016; Letsholo & Safir 2017). While these upward-oriented complementizer patterns pose significant theoretical questions, this paper focuses on the description and empirical analysis of the syntactic and interpretive properties of Kipsigis CA.

Kipsigis also demonstrates a distinct upward-oriented complementizer agreement relation triggered by the matrix object, rather than the matrix subject.

- (3) ko- $\alpha$ -mwaa-**un**     $\alpha$ -le-**ndʒin**    ko- $\emptyset$ -it    tuya amut  
 PST-1SG-tell-2SG.OBJ 1SG-C-2SG.OBJ PST-3-arrive cows yesterday  
 ‘I DID tell you (sg) that the cows arrived yesterday.’

In contrast to the subject-oriented CA pattern (Subj-CA), this object-oriented agreement form (Obj-CA) is realized as a suffix on the complementizer rather than a prefix. This pattern is a novel contribution to the literature; to our knowledge there is no previous discussion of an upward-oriented, object-oriented agreement relation (on a complementizer or otherwise).

As stated above, our focus in this paper is the description and empirical analysis of Kipsigis complementizer agreement patterns. We describe the morphosyntactic properties of the upward-oriented subject complementizer agreement relation (Subj-CA) in §2, demonstrating broad similarity between the Kipsigis pattern and previously-documented patterns (§2.7 explores some of the interpretive differences between the subject-agreeing complementizer and the non-agreeing complementizer). In §3, we describe the novel agreement pattern of upward-oriented object agreement on complementizers (Obj-CA) and examine the interpretive contribution that it makes (distinct from Subj-CA). §4 briefly discusses some broader implications for these patterns for the analysis of complementizer agreement, and concludes.

## 2 Prefixed complementizer agreement (Subj-CA)

### 2.1 Partial complementizer inventory

Table 1 gives a partial inventory of complementizers in Kipsigis.

To our knowledge overt complementizers are obligatory for embedded declarative clauses.

Table 1: Partial Kipsigis complementizer inventory

COMP	GLOSS
AGR-lɛ	that (agreeing)
kɔɛ	that (non-agreeing)
kɛɛ	that (default agreement)
amuŋ	because
koti	if
ne	focus head/relativizer
ko	topic head

- (4) α-ŋgen \* (α-lɛ/kɔɛ) ko-Ø-ruuja tuyɑ amut  
 1SG-know 1SG-C/that PST-3-sleep cows yesterday  
 ‘I know (that) the cows slept yesterday.’

Only the *AGR-lɛ* declarative-embedding complementizer shows agreement (either for subjects or for objects, as will become clear in §3). Evidence that *kɛɛ* is a default agreeing form is found in impersonal constructions and noun complement clauses (§2.4 and §2.5.2).

## 2.2 Prefixed complementizer agreement forms

The agreeing forms of the upward-oriented prefixed complementizer agreement pattern are listed in Table 2 with illustrative examples in (5).

Table 2: Prefixed complementizer agreement forms (Subj-CA)

	SG	PL
<b>1st</b>	α-lɛ	kɛ-lɛ
<b>2nd</b>	i-lɛ	o-lɛ
<b>3rd</b>	kɔ-lɛ	kɔ-lɛ

- (5) a. ko-α-mwaa (α-lɛ) ko-Ø-ruuja tuyɑ amut  
 PST-1SG-say 1SG-C PST-3-sleep cows yesterday  
 ‘I said that the cows slept yesterday.’

- b. ko-Ø-mwaa (kɔ-lɛ) ko-Ø-ruuja tuya amut  
 PST-3-say 3-C PST-3-sleep cows yesterday  
 ‘He/She/They said that the cows slept yesterday.’
- c. ko-o-mwaa (o-lɛ) ko-Ø-ruuja tuya amut  
 PST-2PL-say 2PL-C PST-3-sleep cows yesterday  
 ‘You (pl) said that the cows slept yesterday.’

There is no number distinction between third person forms, as is common in the language (see Jake & Odden 1979; Toweett 1979). The third person form of the complementizer (*kɔlɛ*) can also be used as a non-agreeing complementizer, appearing with any subject, illustrated with a first person subject in (6).

- (6) ko-a-mwaa (kɔlɛ) ko-Ø-ruuja tuya amut  
 PST-1SG-say that PST-3-sleep cows yesterday  
 ‘I said that the cows slept yesterday.’

Though the translation in (6) is the same as those for the agreeing complementizer examples, there is an interpretive difference between the two with respect to which contexts they appropriately occur in; see §2.7.

### 2.3 Prefixed CA agrees with the most local matrix subject

Kipsigis prefixed CA has a strict superordinate subject orientation. The Germanic CA pattern –in which the complementizer displays agreement with the embedded subject –is ungrammatical in Kipsigis.

- (7) a-ŋgen kɔlɛ/a-lɛ/(\*i-lɛ) ko-(i) -amifje amut  
 1SG-know that/1SG-C/\*2SG-C PST-2SG-eat yesterday  
 ‘I know that you ate yesterday.’

The prefixed agreement pattern is also strictly subject-oriented, unable to target objects in the main clause.

- (8) ko-a-mwaa-(wuun) kɔlɛ/a-lɛ/(\*i-lɛ) ko-Ø-ruuja tuya amut  
 PST-1SG-tell-2SG.OBJ that/1SG-C/\*2SG-C PST-3-sleep cows yesterday  
 ‘I told you (sg) (that) the cows slept yesterday.’

Prefixed CA is also local—only the most local superordinate subject may trigger agreement; in (9) the matrix subject cannot trigger Subj-CA in the lowest clause.

- (9) ko-(a) -mwaa a-lɛ ko-i-bwɔt i-lɛ/\*(a-lɛ) ko-Ø-ruuja tuya amut  
 PST-1SG-say 1SG-C PST-2SG-think 2SG-C/1SG-C PST-3-sleep cows yesterday  
 ‘I said that you thought that the cows slept yesterday.’

The pattern in (7-9) is the same as what is reported for Lubukusu (Diercks 2013), Ikalanga (Letsholo & Safir 2017), Ibibio (Torrence 2016), Chokwe, Luchazi, Lunda, and Luvale (Kawasha 2007). Given the subject-oriented nature of the phenomenon, we refer to it throughout as Subj-CA.

## 2.4 Subj-CA in impersonal constructions

A feature of the Lubukusu CA construction is that many speakers readily accept the agreement pattern with a derived subject in a passive construction (Diercks 2010; 2013). To our knowledge, there is no passive construction in Kipsigis; a similar discourse function is achieved either via a VOS construction or by the impersonal construction (cf. Payne 2011). The impersonal construction is formed by adding a *ye-* prefix to the verb, replacing the subject agreement marker.<sup>5</sup>

Despite its passive-like interpretation, the impersonal construction does not allow for prefixed agreement with the remaining main-clause argument.

- (10) ko-ye-mwaa-(an) kɔlɛ/\*(a-lɛ) ko-Ø-ruuja tuya amut  
 PST-IMP-tell-1SG.OBJ that/1SG-C PST-3-sleep cows yesterday  
 ‘I was told that the cows slept yesterday.’ (or, ‘it was told to me ...’)

This is not altogether surprising, as the object in these instances has not been promoted to subject (instead being marked as an object clitic on the matrix verb). Rather than a commentary on the possibility of agreeing with derived subjects, then, this serves as another illustration of non-subjects being unable to trigger prefixed complementizer agreement.

Instead, a default agreement morpheme (*ke-*) is available on complementizers in impersonal constructions, occurring with matrix objects of any *φ*-feature set.

- (11) a. ko-ye-mwaa-an (kɛ-lɛ) yo-Ø-ruuja tuya amut  
 PST-IMP-tell-1SG.OBJ DEF-C PST-3-sleep cows yesterday  
 ‘I was told that the cows slept yesterday.’

<sup>5</sup>Impersonal constructions appear segmentally identical to an active sentence with a first person plural subject, but the constructions are distinguishable by different tone patterns on the verb.



- b. ko-ye-mwaa-wɔɔy kɛ-lɛ ɣo-∅-ruuja tuɣa amut  
 PST-IMP-tell-2PL.OBJ DEF-C PST-3-sleep cows yesterday  
 ‘You (pl) were told that the cows slept yesterday.’

We conclude that *kɛlɛ* is an agreeing form with default agreement (rather than a non-agreeing form); the reasoning and evidence for this is explored in §2.7.

## 2.5 (Non-)locality effects for Subj-CA

A standard feature of the Agree operation (and agreement phenomena crosslinguistically) is that it is subject to locality effects: a head must agree with the structurally closest accessible DP (Chomsky 2000; 2001). In this section we describe the ways in which Kipsigis Subj-CA does not accord with a straightforward Agree operation, as well as showing other patterns relating to the (non-)locality of Subj-CA.

### 2.5.1 Subj-CA possible over an intervening object

In Lubukusu CA, non-subjects in the matrix clause do not intervene in CA (Diercks 2013). Similarly in Kipsigis, the Subj-CA pattern is not disrupted by overt objects in the matrix clause.

- (12) ko-i-mwɔɔ-tʃi laakwet i-lɛ ko-∅-ruuja tuɣa amut  
 PST-2SG-tell-3.OBJ child 2SG-C PST-3-sleep cows yesterday  
 ‘You (sg) told the child that the cows slept yesterday.’

This object non-intervention pattern, shared by Kipsigis and Lubukusu CA, has also been documented in Ibibio (Torrence 2016) and Ikalanga (Letsholo & Safir 2017).

### 2.5.2 Subj-CA out of noun complement clauses

In Lubukusu, a complementizer inside a noun complement clause (NCC) can agree with the main-clause subject. This is constrained by the presence of an intervening possessor of that noun phrase, which cannot itself trigger CA but prevents CA with the main clause subject (Diercks 2013: 378).

The same pattern occurs in Kipsigis, though our consultants differed in their judgments on the acceptability of agreeing forms of the complementizer in NCCs. One did not find these constructions acceptable, while the other provided them

readily and robustly.<sup>6</sup> For our consultant who accepts it, a complementizer in a NCC may agree with the main clause subject in appropriate contexts.

- (13) a. ko-**a**-ibut loyujuwεk (**%a-lε**) ko-∅-ruuja tuyā amut  
 PST-1SG-bring news %1SG-C PST-3-sleep cows yesterday  
 ‘I brought news that cows slept yesterday.’
- b. **a**-tɪŋε kajɛnet (**%a-lε**) /kɔlε/\*kε-lε ko-∅-it layok  
 1SG-have belief/faith 1SG-C/that/\*DEF-C PST-3-arrive children  
 ‘I have belief/faith that the children arrived.’
- c. ko-**a**-mwaa atindoniot (**%a-lε**) /kɔlε/\*kε-lε ko-∅-it layok  
 PST-1SG-tell story %1SG-C/that/\*DEF-C PST-3-arrive children  
 ‘I told the story that the children arrived.’

As in Lubukusu, the presence of a possessor inside the noun phrase degrades Subj-CA in Kipsigis. Example (14) is the equivalent of (13c), with the difference that a possessor is added to the noun phrase in (14), resulting in unacceptability of the agreeing complementizer (for both consultants).

- (14) ko-**a**-mwaa atindoniot ap Kiproono kɔlε/**%a-lε** ko-∅-it layok  
 PST-1SG-tell story of Kiproono that/\*1SG-C PST-3-arrive children  
 ‘I told Kiproono’s story that the children arrived.’

In the words of one of our consultants regarding (14), “there is something very confusing about the sentence with *alε* ... it feels like saying I am the one who’s saying that children arrived, but it’s Kiproono’s story, so there’s a disconnection. So *alε* is not the best word to put there.” This replicates the Lubukusu NCC pattern, for one, but it also seems to suggest an interpretive link between the source of the information in the embedded clause and the agreement trigger on CA. These interpretation considerations of the Subj-CA pattern will be explored in §2.7.

## 2.6 Intermediate conclusions: Prefixed (Subj-) CA

The list in (15) summarizes the properties of Kipsigis Subj-CA, which largely replicate the Lubukusu patterns of complementizer agreement (Diercks 2013) and are consistent with the other languages with similar constructions (to the extent that parallel facts have been reported).

<sup>6</sup>We annotate this interspeaker variation on the examples with a % symbol.

- (15) Properties of Kipsigis Prefixed (Subj-) CA
- a. Prefixed (Subj-) CA targets the most local superordinate subject.
  - b. Objects in the matrix clause cannot trigger Subj-CA, nor do they intervene in Subj-CA.
  - c. Impersonal constructions only allow a default agreeing form.
  - d. Subj-CA can occur within a noun complement clause (NCC) for some speakers.

The next section looks more closely at the distinction between the agreeing and non-agreeing forms and describes the contexts in which these interpretive differences arise.

## 2.7 Interpretation of Subj-CA

There are clear interpretive differences between Kipsigis sentences containing an agreeing complementizer and those with a non-agreeing complementizer. Subtle interpretive effects are in fact well-established for upward-oriented agreeing complementizers; Lubukusu agreeing complementizers serve as an indicator of confidence in the source of the speaker's asserted information (Diercks 2013). However, the interpretation of the Kipsigis agreeing pattern is non-identical to the reported Lubukusu pattern.

- (16) Interpretive Properties of Kipsigis Subj-CA
- a. Subj-CA is most appropriate when the agreement trigger is the source of the information communicated in the embedded clause.
  - b. Subj-CA is most appropriate when it heads a CP whose propositional content is being added to the Common Ground.

### 2.7.1 Information source effect on Subj-CA

The source of the information reported in the embedded clause plays an important role in the acceptability of Subj-CA. As demonstrated in the previous section, sentences such as the one in (17) are perfectly acceptable to speakers with both non-agreeing and agreeing complementizer forms.

- (17) ko-a-mwaa a-lɛ/kɔlɛ ko-Ø-ruuja tuya amut  
 PST-1SG-say 1SG-C/that PST-3-sleep cows yesterday  
 'I said that the cows slept yesterday.'

Our consultants' judgments vary with respect to the acceptability of Subj-CA in the complement of a verb of hearing.

- (18) ko-a-γas    %a-lɛ /kɔlɛ ko-Ø-it    layok  
 PST-1SG-hear %1SG-C/that PST-3-arrive children  
 'I heard that the children arrived.'

One consultant suggests that using Subj-CA in this context sounds more quotative, and the other that it sounds better if you are intending to inform your listeners of the information in the embedded clause. One speaker claimed that using the agreeing complementizer seemed to imply in some way that "the information is coming from you". Throughout our interviews our two main consultants regularly accepted Subj-CA in constructions like this, but both somewhat frequently hesitated over them as well.

The judgments for verbs of hearing become more clear if an explicit source of the reported information is added to the sentence. In these cases, Subj-CA is consistently ruled unacceptable.

- (19) ko-a-γas    kobun    Kiproono kɔlɛ/\*a-lɛ ko-Ø-ruuja tuya amut  
 PST-1SG-hear through Kiproono that/\*1SG-C PST-3-sleep cows yesterday  
 'I heard through Kiproono that the cows slept yesterday.'

Additional evidence comes from noun complement clauses (NCCs). As we saw above in §2.5.2, a complementizer heading a CP inside a NCC can agree with the main clause subject (the % again marking inter-speaker variation).

- (20) ko-a-ɪbu    loɣojɔt    kɔlɛ/%a-lɛ ko-Ø-it    layok  
 PST-1SG-bring news(SG) that/%1SG-C PST-3-arrive children  
 'I brought the piece of news that the children arrived.'

Note, however, that changing the verb to one in which the subject is definitively not the source of the information in the NCC makes Subj-CA comparatively unnatural for both speakers.

- (21) ko-a-γas    loɣojɔt    kɔlɛ/??a-lɛ ko-Ø-it    layok  
 PST-1SG-hear news(SG) that/??1.SG-C PST-3-arrive children  
 'I heard the news (sg) that the children arrived.'

We conclude that a condition for Subj-CA is that the referent of the agreement trigger be contextually interpretable as a source of the information communicated in the embedded clause.

2.7.2 **Common ground distinguishes Subj-CA**

An additional interpretive effect of Subj-CA is that the agreeing complementizer is most naturally used when information reported in the embedded CP is being added to the Common Ground. In contrast, when information is already in the Common Ground (or is being treated as already in the Common Ground), the non-agreeing complementizer is most natural. Consider (22a) and (22b), distinguished only by the agreeing vs. non-agreeing complementizer.

- (22) a. ko-α-mwɔɔ-tʃi Kibeet (α-lɛ) ko-∅-it tuya amut  
 PST-1SG-tell-3.OBJ Kibeet 1SG-C PST-3-arrive cows yesterday  
 ‘I told Kibeet that the cows arrived yesterday.’
- b. ko-α-mwɔɔ-tʃi Kibeet (kɔlɛ) ko-∅-it tuya amut  
 PST-1SG-tell-3.OBJ Kibeet that PST-3-arrive cows yesterday  
 ‘I told Kibeet that the cows arrived yesterday.’

Though the truth conditions of both sentences are identical, specific discourse contexts determine when each is felicitous.

- (23) Context 1: You (the addressee) and I (the speaker) were together yesterday, and when we were together we saw the cows arrive. Then today I see you, and I want to tell you that I told Kibeet this fact.

In Context 1 where the embedded clause’s proposition is in the common ground, the non-agreeing complementizer in (22b) is very natural, but the agreeing complementizer in (22a) is infelicitous. Now consider a different context.

- (24) Context 2: You were not aware that the cows arrived yesterday and I am using this opportunity to inform you not only that I told Kibeet about the cows, but also that the cows arrived.

In contrast, in Context 2 where the arrival of the cows is not in the common ground, the agreeing complementizer (22a) becomes much more natural, and the non-agreeing complementizer (22b) is now relatively infelicitous. This distinction is also evident with a verb of understanding, as in (25).

- (25) ki-yuitosi kɔlɛ/kɛ-lɛ ko-∅-ruuja tuya amut  
 1PL-understand that/1PL-C PST-3-sleep cows yesterday  
 ‘We understand that the cows slept yesterday.’

For this type of sentence, the non-agreeing complementizer (*kɔlɛ*) is natural in a context where the information in the embedded clause is inconsequential, i.e. when everyone is aware that the cows slept. On the other hand, the agreeing complementizer (*kɛlɛ*) would be used in (25) given a different context in which the information in the embedded clause is introduced into the common ground, such as this one: You and your friend's cows slept on another person's plants and you are both now in a lawsuit with them. In that situation someone might assert for the record, "We understand that the cows slept yesterday." We conclude that the agreeing complementizer is most natural in contexts where information is being (intentionally) added to the common ground, whereas the non-agreeing complementizer treats information as previously established in the common ground.

One possible avenue of analysis given this conclusion is that the agreeing complementizer is somehow associated with assertion, and the embedded clauses using such a complementizer are embedded assertions (by "assertion" we mean something that overtly adds a proposition to the common ground). However, agreeing complementizers can readily occur in a variety of non-asserted contexts, suggesting that assertion alone is not the proper explanatory category of what contexts allow the agreeing complementizer. For space concerns we cannot include this evidence here, but the data are available in Rao 2016.

### 2.7.3 CP as the main point of the utterance (MPU)

We posit that the most appropriate description of the interpretive effect of Kipsigis CA is that the agreeing complementizer is possible when the embedded clause is the main point of the utterance (MPU) of the clause. According to Simons (2007) "the main point of an utterance U of a declarative sentence S is the proposition p, communicated by U, which renders U relevant," where relevance is assumed to be essentially Gricean relevance (Grice 1975).

#### (26) Proposed Analysis for Interpretive Effect of Kipsigis CA

The agreeing complementizer is possible when the embedded CP is the main point of the utterance (MPU).

A diagnostic for MPU is offered by (Simons 2007: 1036), in which a yes/no question is answered by information that is presented in an embedded clause, thus ensuring that the content of the embedded clause is the MPU. The hypothesis in (26) makes clear predictions in relation to this diagnostic: the agreeing

complementizer should be felicitous –and *kɔlɛ* infelicitous –in those cases where the embedded clause contains the MPU; this is confirmed in (27):<sup>7</sup>

- (27) a. Q: ko-Ø-ε      ηoo βiiy?  
           PST-3-drink who water  
           ‘Who drank the water?’  
       A: ki-bwɔɔti kɛ-lɛ/#kɔlɛ ko-Ø-ε      βiiy tuya  
           1PL-think 1PL-C/that PST-3-drink water cows  
           ‘We think that the cows drank the water.’
- b. Q: ko-Ø-jaj nɛ      laakwet?  
           PST-3-do what child  
           ‘What did the child do?’  
       A: ko-α-mwaa α-lɛ/#kɔlɛ ko-Ø-ɔɔn      laakwet ɲdaaret  
           PST-1SG-say 1SG-C/that PST-3-chase child      snake  
           ‘I said that the child chased a snake.’

MPU may well also capture the ‘source’ intuitions that we reported previously. If something is the main point of an utterance by the definition above, it emanates from the speaker of an utterance, as it is their contribution to the discourse. Overtly designating an alternative source of the information in the embedded CP may simply be incompatible with a speaker treating that CP as the MPU.

### 3 Suffixed complementizer agreement (Obj-CA)

In addition to the prefixed Subj-CA pattern discussed above, Kipsigis declarative-embedding complementizers can also agree with the matrix object, with suffixed agreement morphemes (Obj-CA): we give the agreement paradigm in Table 3.

Table 3: Suffixed Complementizer Agreement Forms (Obj-CA)

	SG	PL
1st	-lɛ-ndʒ- <b>an</b>	-lɛ-ndʒ- <b>ɛtʃ</b>
2nd	-lɛ-ndʒ- <b>in</b>	-lɛ-ndʒ- <b>ɔɔɿ</b>
3rd	-lɛ-ndʒ- <b>i</b>	-lɛ-ndʒ- <b>i</b>

<sup>7</sup>In each of these cases consultants could find contexts in which the non-agreeing complementizer was allowed, usually requiring that the information in the embedded clause was being recalled from an earlier interaction. These, of course, are the exceptions that prove the rule.

To our knowledge, this is an agreement pattern that is novel to the linguistic literature.<sup>8</sup> Given its novelty, we present a full paradigm of Obj-CA forms in (28). These are translated with verum focus, a translation which is explained in §3.5.

- (28) a. ko-i-mwaa-(an) i-lɛ-(ndʒan) ko-Ø-it layok  
 PST-2SG-tell-1SG.OBJ 2SG-C-1SG PST-3-arrive children  
 ‘You (sg) DID tell me that the children arrived.’
- b. ko-i-mwaa-(un) a-lɛ-(ndʒin) ko-Ø-it layok  
 PST-1SG-tell-2SG.OBJ 1SG-C-2SG PST-3-arrive children  
 ‘I DID tell you (sg) that the children arrived.’
- c. ko-i-mwaa-(tʃi) a-lɛ-(ndʒi) ko-Ø-it layok  
 PST-1SG-tell-3.OBJ 1SG-C-3 PST-3-arrive children  
 ‘I DID tell him/her/them that the children arrived.’
- d. ko-i-mwaa-(weetʃ) i-lɛ-(ndʒeetʃ) ko-Ø-it layok  
 PST-2SG-tell-1PL.OBJ 2SG-C-1PL PST-3-arrive children  
 ‘You (sg) DID tell us that the children arrived.’
- e. ko-i-mwaa-(wɔɔy) a-lɛ-(ndʒɔɔy) ko-Ø-it layok  
 PST-1SG-tell-2PL.OBJ 1SG-C-2PL PST-3-arrive children  
 ‘I DID tell you (pl) that the children arrived.’

To our knowledge, suffixed Obj-CA is possible with any verb that embeds a CP and takes an additional object (mainly verbs of speech).<sup>9</sup>

- (29) ko-a-tʃɔɔm-dʒi Kiproono a-lɛ/(a-lɛ-ndʒi) ko-Ø-it tuyə amut  
 PST-1SG-whisper-3.OBJ Kiproono 1SG-C/1-C-3 PST-3-arrive cows yest.  
 ‘I whispered to Kiproono that the cows arrived yesterday.’

In general, the Obj-CA appears to be syntactically optional, though we note below that it is licit only in very specific discourse contexts.

<sup>8</sup>Deal (2015) describes a complementizer agreement relation in Nez Perce that agrees with both subjects and objects, but that pattern targets embedded arguments, not main-clause arguments, and the agreement triggers are unambiguously determined structurally, rather than by grammatical function, as seems to be the case (on the surface) for Kipsigis.

<sup>9</sup>Sentences with multiple complementizers (and therefore multiple interpretations) are translated without verum focus.



### 3.1 Suffixed CA targets the most local matrix object

In contrast to the prefixed agreement pattern (Subj-CA), Obj-CA targets the matrix clause object. It cannot agree with the matrix subject.

- (30) ko-a-mwaa-un    a-lɛ-ndzin/\*a-lɛ-ndzan    ko-Ø-ruuja tuyɑ  
 PST-1SG-tell-2SG.OBJ 1SG-C-2SG.OBJ/\*1SG-C-1.OBJ PST-3-sleep cows  
 ‘I told you (sg) that the cows slept.’

Obj-CA can also only agree with the most local object, similar to Subj-CA:

- (31) ko-Ø-mwɔɔ-tʃi tʃɛpkɔɛtʃ    Kiproono kɔlɛ ko-a-mwaa-un  
 PST-3-tell-3.OBJ Chepkoech Kiproono that PST-1SG-tell-2SG.OBJ  
 a-lɛ-ndzin/\*a-lɛ-ndzi    ko-Ø-ruuja tuyɑ  
 1SG-C-2SG.OBJ/\*1SG-C-3.OBJ PST-3-sleep cows  
 ‘Chepkoech told Kiproono that I told you that the cows slept (recently).’

In multiple embeddings, it is possible to have multiple complementizers that display the suffixed CA pattern.

- (32) ko-Ø-mwɔɔ-tʃi tʃɛpkɔɛtʃ    Kiproono kɔ-lɛ-ndzi ko-a-mwaa-un  
 PST-3-tell-3.OBJ Chepkoech Kiproono 3-C-3.OBJ    PST-1SG-tell-2SG.OBJ  
a-lɛ-ndzin    ko-Ø-ruuja tuyɑ  
 1SG-C-2SG.OBJ PST-3-sleep cows  
 ‘Chepkoech told Kiproono that I told you that the cows slept.’

In these ways, Obj-CA is very similar to the Subj-CA –showing similar locality constraints –with the significant differences of targeting of objects and appearing as a suffix on the complementizer.

### 3.2 Obj-CA only occurs on the agreeing complementizer

Notably, Kipsigis Obj-CA can only occur on the complementizer if it already demonstrates Subj-CA. The non-agreeing complementizer (i.e. *kɔlɛ* with a 1st or 2nd person subject) cannot bear object agreement.

- (33) ko-a-mwaa-un    a-lɛ/a-lɛ-ndzin /kɔlɛ/\*kɔlɛ-ndzin    ko-Ø-ɪt  
 PST-1SG-tell-2SG.OBJ 1SG-C/1SG-C-2SG.OBJ/that/\*C-2SG.OBJ PST-3-arrive  
 tuyɑ amut  
 cows yesterday  
 ‘I told you that the cows arrived yesterday.’

The *kələndzin* form of the complementizer is acceptable only when it is in fact the agreeing complementizer, i.e. agreeing with a third person subject.

- (34) ko-Ø-mwaa-un Kiproono kɔ-lɛ-ndʒin ko-Ø-it tuya amut  
 PST-3-tell-2SG.OBJ Kiproono 3-C-2SG.OBJ PST-3-arrive cows yesterday  
 ‘Kiproono told you (sg) that the cows arrived yesterday.’

It appears then, that Obj-CA is parasitic on Subj-CA (we briefly discuss the significance of this fact in §4).

### 3.3 Obj-CA in NCCs

Obj-CA can occur in a noun complement clause (NCC) for our consultant who also accepts Subj-CA in NCCs.<sup>10</sup>

- (35) a. ko-a-mwaa-un atindoniot kɔlɛ/%a-lɛ/%a-lɛ-ndʒin  
 PST-1SG-tell-2SG.OBJ story that/%1SG-C/%1SG-C-2SG.OBJ  
 ko-Ø-it layok  
 PST-3-arrive children  
 ‘I told you (sg) the story that the children arrived.’
- b. ko-i-mwaa-an atindoniot kɔlɛ/%i-lɛ/%i-lɛ-ndʒan  
 PST-2SG-tell-1SG.OBJ story that/%2SG-C/%2SG-C-1SG.OBJ  
 ko-Ø-it layok  
 PST-3-arrive children  
 ‘You (sg) told me the story that the children arrived.’

### 3.4 Suffixed (Obj-) CA in impersonal constructions

We demonstrated in §2.4 above that Subj-CA cannot agree with the remaining DP argument in an impersonal construction, which is appropriate given that this argument is not promoted to subject in a Kipsigis impersonal. Accordingly, the Obj-CA forms may appear on the complementizer in an impersonal construction.

- (36) a. ko-ye-mwaa-an kɛ-lɛ/kɔlɛ/\*a-lɛ/\*kɔlɛ-ndʒan /kɛ-lɛ-ndʒan  
 PST-IMP-tell-1SG.OBJ DEF-C/that/\*1SG-C/\*C-1SG.OBJ/DEF-C-1SG.OBJ  
 ko-Ø-it layok  
 PST-3-arrive children  
 ‘I was told that the children arrived.’

<sup>10</sup>Inter-speaker variation is again marked with a %.

- b. ko-ye-mwaa-un    kɛ-lɛ/kɔlɛ/\*i-lɛ/ \*kɔlɛ-ndʒan / kɛ-lɛ-ndʒin  
 PST-IMP-tell-2SG.OBJ DEF-C/that/\*2SG-C/\*C-2SG.OBJ/DEF-C-2SG.OBJ  
 ko-Ø-it    layok  
 PST-3-arrive children  
 ‘You were told that the children arrived.’

Crucially here the *kɛlɛ* form of the agreeing complementizer must be used. Recall from above that Obj-CA is not possible on the non-agreeing *kɔlɛ* complementizer. Taken together with these facts, this evidence supports the conclusion that *kɛlɛ* is in fact a default form of the agreeing complementizer (rather than a non-agreeing complementizer), as it may bear object agreement in impersonal constructions where there is no discernible subject to trigger Subj-CA. These facts have some analytical significance, as discussed in §4.

### 3.5 Interpretation of Obj-CA

The main function of Obj-CA seems to be to add emphasis to an utterance, particularly in the manner of *verum focus*. Verum focus is defined by Höhle (1992) as placing “emphasis on the truth of the proposition it takes scopes over.” It therefore has no effect on the truth conditions of the statement. Verum focus is achieved in English by inserting *do* into a declarative sentence.

- (37) Q: What did Mike eat?  
 A1: He ate a cookie.  
 A2: #He DID eat a cookie. [Verum Focus]

Here, the proposition that Mike ate the cookie is not yet in the common ground and so the verum focus construction in (A2) is infelicitous. If the question was “Did Mike eat a cookie”, (A2) would be felicitous. Now instead, consider a context in which the addressee does not believe that Mike ate a cookie.

- (38) Challenge: Mike didn’t eat a cookie!  
 Response 1: #He ate a cookie.  
 Response 2: He DID eat a cookie. [Verum Focus]

The proposition that Mike ate a cookie is already in the common ground, so Response #2 is acceptable. It does not necessarily assert that Mike ate the cookie, but rather reinforces the speaker’s confidence that Mike ate the cookie.

Now consider the following sentences in Kipsigis, differing only in the presence/absence of Obj-CA marking.

- (39) a. ko- $\alpha$ -mwaa-un  $\alpha$ -l $\epsilon$  ko- $\emptyset$ -ruuja tuy $\alpha$  No Obj-CA  
 PST-1SG-tell-2SG.OBJ 1SG-C PST-3-sleep cows  
 ‘I told you that the cows slept.’
- b. ko- $\alpha$ -mwaa-un  $\alpha$ -l $\epsilon$ -nd $\zeta$ in ko- $\emptyset$ -ruuja tuy $\alpha$  Obj-CA  
 PST-1SG-tell-2SG.OBJ 1SG-C-2SG.OBJ PST-3-sleep cows  
 ‘I told you that the cows slept.’

Note that the truth conditions for both sentences are the same (i.e. I gave you the information that the cows slept). However, the acceptability of the object-agreeing complementizer varies in different discourse contexts.

- (40) Context 1: You and I were talking about the cows yesterday and I told you that the cows slept. Today, I talk with you again and you say “I didn’t know that the cows slept yesterday. You never told me!” I counter this with one of the responses in (39).

Given this context, the object-agreeing complementizer (*al $\epsilon$ nd $\zeta$ in*) in (39b) is perfectly acceptable. One consultant had an intuition that the object-agreeing complementizer was best when the speaker was “being challenged somehow”; in this case the listener doubts that the speaker told them about the cows. This is similar to the earlier provided example of verum focus in (38), but here the content in question is in the embedded clause. Let us consider another context.

- (41) Context 2: You and I talked about the cows and I told you that the cows slept. The next day, I talk with you and you say “Someone told me that the cows slept, but I don’t remember who it was.”

In Context 2, in contrast, the Obj-CA construction in (39b) is dispreferred. Like above, our consultant’s reaction to this context was to point out that Obj-CA “is better for when someone is challenging you”. Like the example in (37), the addressee is asking for information rather than asserting a proposition that requires the speaker to confirm the truth of a statement. Obj-CA therefore appears to be licit in contexts where verum focus is licit.

### 3.6 Intermediate conclusions: Suffixed (Obj-) CA

Object agreement on complementizers is possible in Kipsigis and has a number of properties similar to that of Subj-CA.

- (42) Properties of Suffixed (Obj-) CA in Kipsigis Similar to Subj-CA
- a. The target of Obj-CA is constrained to the most local main clause.
  - b. The pattern is acceptable within a noun complement clause (NCC) for some speakers.
  - c. The agreement pattern has the appearance of targeting a constituent of a particular grammatical function (Obj-CA targets objects, Subj-CA targets subjects).

On the other hand, there are also some properties that make this agreement pattern distinct from Subj-CA.

- (43) Properties of Suffixed (Obj-) CA in Kipsigis Distinct from Subj-CA
- a. Obj-CA agrees with the main-clause object, not the subject.
  - b. Obj-CA can only occur on a Subj-CA complementizer, but Subj-CA can appear without Obj-CA.
  - c. There is no default Obj-CA (in contrast to Subj-CA in impersonals).
  - d. Obj-CA triggers a *verum-focus* reading of the sentence.

## 4 Conclusions

### 4.1 Brief analytical comments

Given space constraints we cannot fully discuss the theoretical consequences of these empirical patterns, but we offer a few thoughts here on the direction of analysis where we believe this work ought to lead. The most salient theoretical question that arises centers on the question of the directionality of Agree, which has been the subject of some discussion in the last decade (e.g. Chomsky 2001; Preminger 2013; Zeijlstra 2012; Wurmbrand 2011; Bjorkman & Zeijlstra to appear; Béjar & Rezac 2009; Baker 2008; Putnam & van Koppen 2011; Carstens 2016; Diercks et al. 2018). While the Subj-CA facts here (for the most part) simply re-affirm the urgency of establishing a theory of agreement that can accommodate this sort of upward-oriented agreement pattern, the Obj-CA facts enter a new pattern into the theoretical discussion.

Reflecting on Obj-CA for a moment, we are faced with a critical question: if agreement patterns are determined structurally, rather than linked directly with notions like grammatical functions (as a long history of generative theorizing has claimed), it is not clear how to explain how two agreement relations on the same head systematically target DPs with distinct grammatical functions (subjects vs.

objects). On verbal forms this is usually accomplished by positing different structural positions for the object-related morphology and the subject-related morphology. But in this instance the head (C) is structurally lower than *both* the matrix subject and object, and even if decomposed into more abstract components, both of those components would be subject to the same structural obstacles to an Agree relation. And while Diercks (2013) proposed that Lubukusu Subj-CA could be analyzed essentially as a self-anaphor, to our knowledge there are no strictly *object-oriented* anaphors, leaving the Kipsigis Obj-CA relation unexplained.

A first step toward an analysis is based on the fact that the subject agreement morpheme seems to be obligatory when the agreeing complementizer is used (hence, default agreement in impersonal constructions). Obj-CA has no default form, therefore appearing “optionally” on the Subj-CA complementizer. Facts like these have long been taken as indicative of a morphosyntactic difference: perhaps Subj-CA is an agreement morpheme, but Obj-CA is a clitic (in a clitic-doubling configuration with the matrix object). This doesn’t answer every question about how Subj-CA and Obj-CA successfully target their respective agreement triggers, but at least reframes the question in largely familiar terms (subject agreement and object clitic doubling).

That raises an even more critical question, however: how can a matrix object be clitic-doubled on a functional head that (by widely accepted assumptions) is *always* structurally lower than the base position of the object (heading a complement clause)? Most analyses of clitic doubling (see Roberts 2010; Kramer 2014; Harizanov 2014 for recent versions) rely rather critically on a c-command configuration between the clitic site and the DP object. To maintain these (otherwise quite successful) approaches to clitic doubling, we would be forced to claim that the agreeing complementizer with Subj-CA and Obj-CA in fact c-commands the DP object. On the face of it, such a proposal seems implausible: why/how would a complementizer be in the middlefield of the matrix clause?

However, this kind of analysis is precisely what has been proposed by Carstens (2016) and Bossi & Diercks (to appear) to explain Lubukusu CA. Carstens claims this is a consequence of the Agree relation proper, whereas Diercks et al. propose a derivative feature valuation operation called anaphoric agreement composed of movement + Agree (based on Rooryck & Vanden Wyngaerd 2011). Setting those differences aside, both accounts propose that a Subj-CA construction consists of the complementizer moving covertly into the matrix clause (to the edge of *vP*, from which position agreement is possible via a standard downward-probing Agree relation). The Kipsigis Obj-CA facts yield an interesting new perspective on these otherwise quite abstract proposals; for Obj-CA to be the clitic-doubling

operation it appears to be, the complementizer would in fact need to be represented in the main clause at some point in the derivation.

Initial evidence from Kipsigis suggests that this is in fact a promising approach: it is possible for a complementizer to *overtly* raise into the main clause, preceding overt arguments in the main clause (and essentially substituting for an otherwise null main verb of speech):<sup>11</sup>

- (44) kɔ-lɛ-ndʒin Kiproono ko-Ø-ruuja tuyɑ amut  
 3-C-2SG.OBJ Kiproono PST-3-sleep cows yesterday  
 ‘Kiproono told you that the cows slept yesterday.’

This line of analysis has promise to inform us not only about nature of agreement itself, but also about the structural nature of complementation. Therefore, while these analyses require a large amount of detailed work and additional evidence, we can begin to see the sorts of theoretical significance than can emerge in relation to the kinds of facts reported here.

## 4.2 Summary

This paper describes an upward-oriented complementizer agreement relation in Kipsigis. Many of these properties are also shared by the CA patterns in a variety of languages, demonstrating a growing empirical consensus about the nature of upward-oriented complementizer agreement.<sup>12</sup> While subject-oriented CA constructions (Subj-CA) are becoming more well-known, we have also documented an object-oriented CA construction (Obj-CA), which is a novel contribution to the linguistic literature (to our knowledge). In addition to describing the morphosyntactic properties of both Subj-CA and Obj-CA, we discussed the interpretive consequences of each (both related to their felicitous use in different discourse contexts, rather than truth-conditional semantic differences). While this final section includes some commentary on broader analytical questions, due to space concerns we cannot tackle the deeper theoretical questions that are

<sup>11</sup>Similar constructions where a complementizer substitutes for a verb of speech have been reported by Kawasha (2007) for a variety of central Bantu languages, and have also been encountered by Diercks for some Lubukusu speakers (fieldnotes). This is therefore not peculiar to the Kipsigis pattern (though, notably, the SVO word order of the other languages does not clarify the position of the complementizer in the same way that Kipsigis’ verb-initial word order allows for). Note that for examples like (44), an inflectional difference between complementizers and main verbs makes clear that the clause-initial element is in fact a complementizer.

<sup>12</sup>Though, of course, individual languages continue to add new wrinkles, for example Ikalanga’s influence of tense/voice on CA (Letsholo & Safir 2017).

raised by upward-oriented complementizer agreement (both Subj-CA and Obj-CA); these include the nature of feature valuation/Agree, phases, and counter-cyclic operations in syntax (among others). We refer the reader to the work cited throughout the paper for more depth with these issues, and specifically to Diercks et al. (2018) for an account that can accommodate the facts presented here.

## Acknowledgements

First and foremost we would like to thank Robert Langat and Sammy Kiprono Bor for their hard work on this project, and for sharing their language with us. We hope we have done it justice. The authors would like to thank Masha Polinsky, Jessica Coon, and especially Lauren Eby Clemens for their guidance in learning about V1 languages over the years. Rodrigo Ranero and Claire Halpert were very helpful sounding boards at various points, and the audience at the ACAL poster session was exceedingly generous in offering their questions and critiques, which resulted in a much more thorough description of the constructions we have examined here. All remaining errors are our own. Both authors collected data for the project and worked on the empirical and theoretical questions together. The first complete written version of this work was the second author's undergraduate thesis at Pomona College, which was revised for publication by the first author.

## Abbreviations

1,2,3	person features	NCC	Noun Complement Clause
AGR	Agreeing	OBJ	Object
C	Complementizer	Obj-CA	Object-Oriented (Suffixed)
CA	Complementizer Agreement		Complementizer Agreement
		PL	plural
DEF	Default	PST	past tense
IMP	Impersonal	SG	singular
MPU	Main Point of the Utterance	SUBJ	Subject
		Subj-CA	Subject-Oriented (Prefixed) Complementizer Agreement



## References

- Baker, Mark. 2008. *The syntax of agreement and concord*. Cambridge: Cambridge University Press.
- Béjar, Susana & Milan Rezac. 2009. Cyclic Agree. *Linguistic Inquiry* 40(1). 35–73.
- Bjorkman, Bronwyn & Hedde Zeijlstra. to appear. Checking up on ( $\phi$ )-agree. *Linguistic Inquiry*.
- Bossi, Madeline & Michael Diercks. to appear. V1 in Kipsigis: Head movement and discourse-based scrambling. *Glossa*.
- Bossi, Madeline, Michael Diercks, Peter Staub & Jordan Wong. 2018. V1 in Kipsigis: Head movement and scrambling. Ms, Pomona College.
- Carstens, Vicki. 2003. Rethinking complementizer agreement: Agree with a Case-checked goal. *Linguistic Inquiry* 34(3). 393–412.
- Carstens, Vicki. 2016. Delayed valuation: A reanalysis of “upwards” complementizer agreement, and the mechanics of Case. *Syntax* 19(1). 1–42.
- Chomsky, Noam. 2000. Minimalist inquiries: the framework. In Roger Martin, David Michaels & Juan Uriagereka (eds.), *Step by step: essays on Minimalist syntax in honor of Howard Lasnik*, 89–156. Cambridge: MIT Press.
- Chomsky, Noam. 2001. Derivation by phase. In Michael Kenstowicz (ed.), *Ken Hale: a life in linguistics*, 1–52. Cambridge: MIT Press.
- Deal, Amy Rose. 2015. Interaction and satisfaction in  $\phi$ -agreement. In Thuy Bui & Deniz Ozyildiz (eds.), *The Proceedings of NELS 45*, 1–14.
- Diercks, Michael. 2010. *Agreement with subjects in Lubukusu*. Georgetown University. (Doctoral dissertation).
- Diercks, Michael. 2013. Indirect agree in Lubukusu complementizer agreement. *Natural Language and Linguistic Theory* 31(2). 357–407.
- Diercks, Michael, Marjo van Koppen & Michael Putnam. 2018. Agree probes down: anaphoric feature valuation and phase reference. To appear in an edited volume with Language Science Press.
- Grice, H. Paul. 1975. Syntax and Semantics III: Speech Acts. In Peter Cole & Jerry Morgan (eds.), *Syntax and Semantics III: Speech Acts*, chap. Logic and Conversation, 41–58. Academic Press.
- Harizanov, Boris. 2014. Clitic doubling at the syntax-morphophonology interface: A-movement and morphological merger in Bulgarian. *Natural Language and Linguistic Theory* 32(4). 1033–1088.
- Höhle, Tilman. 1992. Über Verum-Fokus im Deutschen. In Joachim Jacobs (ed.), *Informationsstruktur und Grammatik*, vol. 4 (Linguistische Berichte Sonderhefte), 112–141. Wiesbaden: VS Verlag für Sozialwissenschaften.

- Idiatov, Dmitry. 2010. Person-number agreement on clause linking markers in Mande. *Studies in Language* 34(4). 832–868.
- Jake, Janice & David Odden. 1979. Raising in Kipsigis. *Studies in the Linguistic Sciences* 9(2). 131–155.
- Kawasha, Boniface. 2007. Subject-agreeing complementizers and their functions in Chokwe, Luchazi, Lunda, and Luvale. In Doris Payne & Jaime Peña (eds.), *Selected Proceedings of the 37th Annual Conference on African Linguistics*, 180–190. Somerville, MA: Cascadilla Proceedings Project.
- Kramer, Ruth. 2014. Clitic doubling or object agreement: The view from Amharic. *Natural Language and Linguistic Theory* 32. 593–634.
- Letsholo, Rose & Ken Safir. 2017. Complement clause C-agreement beyond subject phi-agreement in Ikalanga. Talk given at the ACAL 48 at Indiana University.
- Lewis, M. Paul, Gary F. Simons & Charles D. Fennig (eds.). 2016. *Ethnologue: Languages of the world*. 19th edn. Dallas: SIL International. <http://www.ethnologue.com>.
- Payne, Doris L. 2011. The Maa (Eastern Nilotic) Impersonal construction. In Andrej L. Malchukov & Anna Siewierska (eds.), *Impersonal Cconstructions: A cross-linguistic perspective*, 257–284. Amsterdam: John Benjamins.
- Preminger, Omer. 2013. That's not how you agree: A reply to Zeijlstra. *The Linguistic Review* 30(3). 491–500.
- Putnam, Michael & Marjo van Koppen. 2011. All there is to know about the all-construction. *Journal of Comparative Germanic Linguistics* 14(2). 81–109.
- Rao, Meghana. 2016. Complementizer agreement in Kipsigis. Unpublished undergraduate thesis, Pomona College.
- Roberts, Ian. 2010. *Agreement and head movement: Clitics, incorporation, and defective goals*. Cambridge: MIT Press.
- Rooryck, Johan & Guido Vanden Wyngaerd. 2011. *Dissolving binding theory*. Oxford: Oxford University Press.
- Simons, Mandy. 2007. Observations on embedding verbs, evidentiality, and presupposition. *Lingua* 117. 1034–1056.
- Torrence, Harold. 2016. Subject oriented complementizer agreement in Ibibio. Talk given at the 47th Annual Conference on African Linguistics at the University of California, Berkeley.
- Toweett, Taaita. 1979. *A study of Kalenjin linguistics*. Nairobi: Kenya Literature Bureau.
- Van Koppen, Marjo. 2005. *One probe – two goals: Aspects of agreement in Dutch dialects*. University of Leiden. (LOT-publications 105).

20 *Upward-oriented complementizer agreement with subjects and objects in Kipsigis*

- Wurmbrand, Susi. 2011. Reverse Agree. Unpublished Ms., University of Connecticut.
- Zeijlstra, Hedde. 2012. There is only one way to agree. *The Linguistic Review* 29(3). 491–539.



## Chapter 21

# Serial verb nominalization in Akan: The question of intervening elements

Ọbádélé Bakari Kambon

University of Ghana, Legon

Reginald Akuoko Duah

University of Ghana, Legon

Clement Kwamina Insaideo Appah

University of Ghana, Legon

In this paper, we hope to disambiguate the nature of look-alike intervening elements that appear between verbs in Serial Verb Constructions (SVCs) and Serial Verb Construction Nominalizations (SVCNs). To do so, we will first show that these intervening elements share the same phonological form. We will then show that although the intervening elements look the same on the surface, they can be differentiated by appealing to semantics and the construction from which the SVCN is derived. In doing so, we find that some of the intervening elements should, indeed, be regarded as TAMP markers, while others are nominalizers (NMLZ). In conclusion, we identify abstract schemata/templates that account for, and predict the positioning of, intervening elements found in Akan SVCNs.

## 1 Background

In this paper, we address the question of intervening elements in nominalized Serial Verb Constructions (SVCs).<sup>1</sup> Tense, aspect, mood and polarity (TAMP) markers

---

<sup>1</sup>This project originated from a question from Clement Appah at the PhD defense of Ọbádélé Bakari Kambon in which it was asked how do we know that the intervening elements between nominalized verbs from Serial Verb Constructions (SVCs) are actually tense, aspect, mood, polarity (TAMP) markers and not simply nominal markers. The video of the PhD defense can be viewed here: <https://youtu.be/QXDFwLV0Atc>.



surface with the same phonological form as nominalizing affixes (NMLZ) in Akan. We hope to show, with evidence, times in which such intervening elements are grammatical elements derived from the original serial verb construction – such as TAMP markers, etc. – and when they are actually nominal elements (NMLZ). To do so, we will first substantiate that nominalized verbs in Akan are made with /a-/ and /-N-/, which are the same affixes that can be found as TAMP markers in SVCs. While this identity of form could potentially lead to ambiguity in terms of analysis, there are some clear cues in terms of form, function and semantics that can help us to disambiguate and clearly identify intervening elements. What makes the investigation special with regard to SVCs relates to the intervening element available, depending on what type of SVC instantiated. In SVCs, the intervening elements may be either NMLZ or TAMP. We do not, however, find TAMP markers on single verbs; only nominalizers. The observation that TAMP can occur in the case of SVCs makes this investigation intriguing and it brings out a phenomenon that could not be observed if we were dealing with single verbs alone.

Pioneering work on SVC nominalization has been done in the last few decades (Bodomo & van Oostendorp 1994; Bodomo 2004; 2006; Hiraiwa & Adams 2008; Aboh & Dyakonova 2009; Kambon 2012). Following Bodomo & van Oostendorp (1994), much of this literature has followed the terminology of “Serial Verb Nominalization.” However, given that other constituents, when they appear in the SVC, also must surface in the nominal form, we prefer the term Serial Verb Construction Nominalization (SVCN). We feel that this terminology better accounts for all constituents of the construction and its nominalized form, whether or not these elements happen to be verbs or not.<sup>2</sup>

There are several potential ways of categorizing or typologizing SVCs. Such ways include on the basis of transitivity of included verbs, whether or not argument sharing exists, and/or based on the degree of idiomaticity, semantic integration and lexicalization. Following Osam (1994) categorization of SVCs based on degree of semantic integration (and associated degrees of lexicalization) Kambon (2012) showed that there are progressively greater degrees of integration ranging from the non-integrated Chaining Serial Constructions (CSCs) to Partial Lexicalized-Integrated Serial Verb Constructions (PL-ISVCs) to the most integrated Full Lexicalized-Integrated Serial Verb Constructions (FL-ISVCs).

The relationship between Semantic Integration and Lexicalization can be captured in Figure 1, which shows that as there is less conceptual distance between events, this is manifested in terms of progressively more lexicalization as expressed in the language.

---

<sup>2</sup>See Kambon (2012) and Kambon et al. (2015) for a discussion on revising some criteria and definitions of SVCs.

Separate sentences → Coordination → CSC → PL-ISVC → FL-ISVC → Single  
Verb

Figure 1: Scale of lessening conceptual distance (Kambon 2012: 95)

Using Semantic Integration and Lexicalization as a means of categorization, Kambon (2012) showed that 98.63% (144 out of 146) of all FL-ISVCs identified have nominal counterparts while only 2.46% (17 out of 690) of all PL-ISVCs identified have nominal counterparts. CSCs, on the other hand seem to nominalize haphazardly as designata and denotata in the form of apparently random frozen proverbs, idioms/figures of speech and sentences.

While it is not our intention to rehash the entire means for identifying the FL-ISVCs to distinguish them from PL-ISVCs, it was decided that an independent means (other than nominalization itself, which would lead to circular argumentation) should be employed in order to categorize each one. Part of this came from Osam's (1994) initial discussion of FL-ISVCs, in which he writes, "Ranking high on the scale of integration are those verbal combinations that have become fully lexicalised into verb compounds and which are used as *lexicalised idioms*." (Osam 1994: 238, emphasis added). In recognizing that there was a link between semantic integration and idiomaticity, we employed Barkema's (1996) schema, which deals with defining characteristics of idioms on the basis of collocability, familiarity, flexibility and compositionality to test the idiomaticity and/or semantic integration of different types of SVCs identified for Akan. **Flexibility** deals with the degree to which a given idiom may take on various grammatical forms (i.e. number, specification, other types of morphological marking) without "breaking" the idiom and forcing a literal interpretation. **COMPOSITIONALITY** can be understood as the "degree to which the sum total meaning of the entire construction is readily derived from the parts contained therein" Kambon (2012: 47). **COLLOCABILITY** may be thought of as the "degree to which synonym or antonym alternatives can be freely switched in and out" Kambon (2012: 46). **FAMILIARITY** involves the currency of the idiom whereby it has become institutionalized to the point that the idiom, rather than the literal counterfeit form, is assumed by native speakers (Kambon 2012).

Using Barkema's (1996) schema, FL-ISVCs were identified on the basis of the following characteristics:

- Usually non-compositional
- Usually collocationally closed

- Usually inflexible
- Usually familiar (institutionalized)

In §3, we will argue that a key to understanding the nature of intervening elements in SVCNs is identifying the type of SVC source construction from which the SVCN is derived. Below, we illustrate with examples the various types of SVCs and their nominalized counterparts. We begin with examples of FL-ISVCs and nominalized counterparts.<sup>3</sup>

- (1) a. Yè-à-ká      yèn      hó      á-bò      mú.  
 1PL-PRF-touch 1PL.POSS body PRF-strike inside  
 ‘We have united ourselves.’
- b. Ñ-ká-bó-m(ú)  
 ?NMLZ/?NEG-touch-strike-inside  
 ‘Unity’
- c. Ñkábóm hiá yéń.  
 unity need 1PL  
 ‘Unity is important to us.’
- (2) a. Ì-ń-tú                      nè              hó      ñ-kyé.  
 3SG.SBJ-NEG-uproot 3SG.POSS body NEG-give.as.gift  
 ‘He doesn’t volunteer.’
- b. Ā-tù-hó-á-kyé  
 ?NMLZ/?PRF-uproot-body-?NMLZ/?PRF-give.as.gift  
 ‘Volunteerism’
- c. Ì-wò                      àhùmóbóró né      àtùhóákyé.  
 3SG.SBJ-possess mercy      and volunteerism  
 ‘He is merciful and has a volunteering spirit.’ (lit. he has mercy and volunteerism)

Examples of FL-ISVCs with nominalized counterparts that have potentially ambiguous intervening elements:

- (3) a. Mè-ń-gyé                      áséím nó      ń-tò              mú.  
 1SG.SBJ-NEG-receive word DET NEG-throw inside  
 ‘I don’t accept the story.’

---

<sup>3</sup>For consistency of presentation, examples come from Asante Twi unless otherwise indicated.



- b. Ñ-gyé-ń-tó-ń(ú)  
 ?NMLZ/?NEG-receive-?NMLZ/?NEG-throw-inside  
 ‘Acceptance’
- c. Ñnyéntóm(ú) á-ń-mà só wò hó.  
 acceptance PST-NEG-come top at there  
 ‘There was no acceptance there (between two or more people).’
- (4) a. Ǿ-à-twá àséń á-tò mè só.  
 3SG.SBJ-PRF-cut matter PRF-throw 1SG.POSS top  
 ‘He has falsely accused me.’
- b. Ñ-twá-ń-tó-só  
 ?NMLZ/?NEG-cut-?NMLZ/?NEG-throw-top  
 ‘False accusation’
- c. Dèè wó-á-ká yí nyínáá yè ñtwáńtósó.  
 thing 2SG.SBJ-PRF-speak DEM all be false accusation  
 ‘All that you are saying is a false accusation.’

A point that will be returned to later that should be noted here is that the prefix /a-/ in (1a) and (4a) is functioning as a perfect marker (PRF). Meanwhile /a-/ occurs in the nominalized SVC in (2b) and can be analyzed as functioning as a nominalizing prefix (NMLZ). Likewise, the prefix /N-/ in (1b), (3b) and (4b) seems to serve as a nominalizing prefix (NMLZ), while /N-/ in (2a) and (3a), a superficially similar /N-/, is NEG. Thus, the same phonological forms are serving different functions in the language. The disambiguation of these surface similarities of form is the basis of the primary research agenda of this paper.

PL-ISVCs were also identified as being generally on the other end of the scale as they are:

- Usually fully compositional
- Usually collocationally limited
- Usually semi-flexible (productive)
- Usually partially familiar (somewhat institutionalized)

- (5) a.  $\dot{\text{O}}\text{-à-tó}$  àdùàné á-dì.  
 3SG.SBJ-PRF-buy food PRF-eat  
 ‘He has bought food to eat.’
- b.  $\tilde{\text{N}}\text{-tó-dí-(é)}$   
 NMLZ-buy-eat-NMLZ  
 ‘Things bought and eaten.’
- c.  $\dot{\text{O}}\text{-tàá}$  dí òtódíé.  
 3SG.SBJ-often eat buying-and-eating  
 ‘He often buys what he eats.’
- (6) a.  $\text{Mógyá nà}$  nàánóm hwìè gù-ì.  
 blood PRT ancestors pour spill-PST  
 ‘It is blood that our ancestors shed.’
- b.  $\text{Hwìè}$  -gù-(ó)  
 pour-spill-NMLZ  
 ‘Pouring away’
- c.  $\text{Hwìègúó}$  kwà níé.  
 Pouring-away worthless be.this  
 ‘It is worthless pouring away.’

The examples in (7–8) show nominalized PL-ISVCs with potentially ambiguous intervening elements. Again, as noted in the case of FL-ISVCs (3–4), nominalizing affixes (NMLZ) may appear on the noun, e.g. (7b) and (8b), in which case they mimic the appearance of the perfect (PRF) /a-/ and negative (NEG) /N-/ prefixes, but without the semantic connotations that these carry once they appear as part of the nominal form.

- (7) a.  $\text{Yè-à-fúá}$  nó á-hwè nò.  
 1pl.SBJ-PRF-hold 3SG.OBJ PRF-beat 3SG.OBJ  
 ‘We have held and beat him.’
- b.  $\tilde{\text{M}}\text{-fùà-}\tilde{\text{n}}\text{-hwé}$   
 ?NMLZ/?NEG-hold-?NMLZ/?NEG-beat  
 ‘Holding and beating’
- c.  $\text{Sédèè}$  wò-dí-ì nò m̀fùà̀nhwé nó ñ-yé  
 manner 3PL-eat-PST 3SG.OBJ holding-and-beating CD NEG-be  
 ‘The manner in which they held him and beat him up is not good.’

- (8) a. Mé wòfà á-wú á-gyà mè àdéé.  
 1SG.SBJ maternal-uncle PRF-die PRF-leave 1SG.OBJ thing  
 ‘My uncle has died and bequeathed me with something.’
- b. À-wú-ń-gyá-dé(é)  
 ?NMLZ/?PRF-die-?NMLZ/?NEG-leave-thing  
 ‘Inheritance’
- c. N’awúńnyádéé ñ-kò-sí àhé ípó.  
 3SG.POSS.inheritance NEG-EGR-stand how-much even  
 ‘His/her inheritance did not even amount to much.’

Finally, CSCs were identified as having the following characteristics:

- Fully compositional or wholly non-compositional
- Flexible or inflexible
- Collocationally open or closed
- Familiar or non-familiar

- (9) a. Kà hyéń kó-dú è-m-má èsúm í-tó  
 drive car EGR-arrive 3SG.SBJ-NEG.imp-let darkness NEG-encounter  
 wò kwáń mú.  
 2SG.OBJ road inside.  
 ‘May darkness not catch up with you!’<sup>4</sup> (Obeng 2001: 61)
- b. Kà-hyéń-kó-dú(rú)  
 drive-vehicle-EGR-arrive  
 ‘May darkness not catch up with you!’ (Obeng 2001: 61)
- c. Yè-à-tò nò dín Kàhyéńkòdu  
 1pl.SBJ-PRF-throw 3SG.OBJ name Kahyenkòdu.  
 ‘He/she was given the name Kahyenkòdu.’

- (10) a. Ǿ-kó fòrò bóó.  
 3SG.SBJ-fight climb rock  
 ‘He/she fights then climbs a stone.’

<sup>4</sup>With the connotation of ‘May a bad omen befall my enemy for his action towards me’.

- b. Ǿ-kó-fórò-bóó  
 NMLZ-fight-climb-rock  
 ‘One who fights on rocky terrain’ (Obeng 2001: 79)
- c. Ǿkófóròbóó yè òhéne bí díí.  
 Ǿkófóròbóó be king INDF name  
 ‘Ǿkoforoboo is the name of a king.’

Now, in (11–12), we see examples of CSCs that also have potentially ambiguous intervening elements.

- (11) a. Wó-á-tò àbáń nó á-pè̀m.  
 2SG-PRF-encounter fortress DET PRF-knock.against  
 ‘You have encountered the fortress and knocked against it.’
- b. Ǿ-tó-à-pè̀m  
 ?NMLZ/?PRF-encounter-?NMLZ/?PRF-knock.against  
 ‘The unsurpassable one’
- c. Nè m̀mrané nè Ǿtóapè̀m.  
 3SG.POSS praise.name be Atoapem  
 ‘His praise name is Atoapem.’
- (12) a. Ǿ-té m’ámánèhúnú nyínáá ò-sèré mé.  
 NEG-hear 1SG.POSS.catastrophe all NEG-laugh 1SG.OBJ  
 ‘Don’t laugh when you hear of all my misfortunes.’
- b. Ǿ-té-ò-sèré.  
 ?NMLZ/?NEG-hear-?NMLZ/?NEG-laugh  
 ‘Do not hear and laugh’ (personal name).
- c. Yè-fré nò Ǿtènsèré.  
 1pl.SBJ-call 3SG.OBJ Ntensere  
 ‘We call him Ntensere.’

It is worth noting that while /a-/ and /N-/ may function as TAMP markers in clauses, they occur throughout the language as nominalizers (NMLZ), and not exclusively in the context of SVCNs.<sup>5</sup> The following examples demonstrate this:

<sup>5</sup>For more discussion on nominal derivation in Akan, see Appah (2003).

(13) /a-/ as nominalizer (NMLZ)

- a. *dwo* ‘to be cool’ ⇒ *adwo* ‘coolness’ (i.e. *Mema wo adwo*. ‘I give you coolness/good evening.’)
- b. *dwene* ‘to think’ ⇒ *adwene* ‘thought/brain’ (i.e. *M’adwene ne se menkɔ*. ‘My thought is that I should go.’)
- c. *didi* ‘to eat’ ⇒ *adidi(e)* ‘eating’ (i.e. *M’adidie asesa*. ‘My (manner of) eating has changed.’)
- d. *dom* ‘to show grace towards’ ⇒ *adom* ‘grace’ (i.e. *Adom bi nti, εβεye yie*. ‘Because of a certain (show of) grace, it will be well.’)

(14) /N-/ as nominalizer (NMLZ)

- a. *da* ‘to sleep’ ⇒ *nna* ‘sleep’ (i.e. *Nnansa yi nna koraa abɔ me*. ‘Recently sleep has been difficult for me.’)
- b. *kyea* ‘to greet’ ⇒ *nkyea* ‘greetings’ (i.e. *Nkyea kyere ɔdɔ*. ‘Greetings show love.’)
- c. *kra* ‘to bid farewell’ ⇒ *nkra* ‘message’ (i.e. *Nkra a ɔde maa me nie*. ‘This is the message he/she left for me.’)
- d. *kae* ‘remember’ ⇒ *nkae(ε)* ‘remembrance’ (i.e. *Nkaeε da m’akoma soɔ*. ‘Remembrance lays on my heart.’)

In this section, we have provided a discussion of SVCs, including definitions, descriptions and illustrations of various types. In exemplifying SVCs, we have given an overview of characteristics prototypically associated with different categories into which SVCs may be grouped. We have also shown that SVCs can be nominalized and that similar looking elements, specifically /a-/ and /N-/, may appear in SVCs and SVCNs and in general as nominalizers in the language. When they appear in SVCNs, intervening elements /-a-/ and /-N-/ may potentially serve the same or different roles in the language including functioning as nominalization markers (NMLZ) as well as serving the grammatical function of TAMP marking. While this identity of form seems to present a level of difficulty in terms of disambiguation, in this paper, we intend to account for these intervening elements that appear between verbs in Serial Verb Construction Nominalization (SVCN). As such, we will show that for certain SVCs, upon nominalization, various finite characteristics such as tense, aspect, mood and polarity (TAMP) may be carried over into the noun form but they may perform other functions than TAMP. In §2, we will outline the methodology followed in this study. In §3, we will examine different types of SVCNs and show how intervening elements which are

carried over from the SVC into the SVCN may be analyzed. In §4, we will propose two broad schemata or templates to account for Akan SVCNs. We argue these base template forms are the basic morphological schemas that native speakers know and utilize to develop new forms. Significantly, these schemata can be used to predict the nature of the intervening elements in an SVCN. §5 will present our conclusion.

## 2 Methodology

Examples of SVCNs were extracted from Osam (1994) and Agyeman (2002) as these were the two major works on semantic integration of SVCs in Akan. Using semantic integration as the basis of categorizing SVCs, each of these seminal works provided examples of FL-ISVCs, PL-ISVCs and CSCs. Given that each of these authors provided some of the most unambiguous and exemplary cases of each type of SVC, questionnaires were then developed based on such cases to get native speaker judgments on whether or not these SVCs could be nominalized. Additionally, using the aforementioned idiomaticity criteria, similar SVCs were identified from *The Dictionary of the Asante and Fante Language called Tshi* (Twi) (Christaller 1933), *Twi Nsem Nkorenkore Kyerewbea* wordlist (Department of Education 1971) Boadi (2005), *Twi Kasa Mmara ne Kaseso* and *Mfantse Nkasafua na Kasambirenyi Nkyerease: Dictionary of Mfantse Words and Idioms* (Bannerman et al. 2011). These texts were chosen due to their comprehensiveness, representativeness of various literary dialects of Akan and for the diachronic range of the language represented by them as a whole.

The study used purposeful sampling (Patton 2002: 230), primarily based on dialect of spoken Akan. In the first phase (P1), questionnaires were primarily administered at Accra (University of Ghana-Legon 48.1%), Cape Coast (University of Cape Coast 37.3%), and Winneba (University of Education-Winneba 17.9%). For P1, 75 participants mainly ranging from ages 21-40 were consulted, with most of them being literate speakers. For the second phase (P2), the bulk of participants were over 60 years old and were mostly non-literate. Taking advantage of the fact that most of the P1 participants were literate, questionnaires were distributed individually and respondents returned the forms filled out. Because P2 comprised mostly non-literate speakers, a different method of focus groups was employed wherein explanations of the nature of the study were provided and speakers gave their intuitions about nominalization and decomposition processes. For each phase, speakers of the main literary dialects of Akan, namely Asante Twi, Fante and Akuapem were consulted. For each SVC, speakers

were asked to provide the corresponding nominal when one existed. Conversely, speakers were also given SVCNs and were asked to provide the SVC from which the nominalized form was derived so that both composition and decomposition processes would be adequately represented. Data was analyzed in order to ascertain whether or not there were similarities or differences in the kinds of SVCs (i.e. on the basis of transitivity, on the basis of argument sharing or on the basis of semantic integration/lexicalization) that could be nominalized. While there were no significant behaviors on the basis of other aspects of SVC typology, it was found that lexicalization represented a salient feature effectively predicting nominalization behavior or lack thereof.

### 3 Analysis of intervening elements

In this section, we will exemplify SVCs and examine those for which derived SVCNs have intervening elements. As we showed in the background section, there are two major affixes: /a-/ and /N-/, which may serve as nominalizers. When /N-/ occurs within a nominalized verb, the first inclination might be to simply analyze it as a nominalizer, however one should be circumspect due to the fact that, in terms of function, the nasal affix in the language may serve as a (i) negation marker, e.g. (2a), (3a), (9a) and (12a); (ii) (singular or plural) nominal marker/nominalizer, e.g. (13a–d) or (iii) mood marker, e.g. (9a). It must be noted that /a-/ also has distinct manifestations as (i) past/perfect marker, e.g. (1a), (3a), (4a), (4c), (5a), (7a) and (8a); (ii) (singular or plural) nominal marker or a nominalizer, e.g. (13a–d); (iii) as a conditional marker (with a falling tone). In the following, we examine the status of intervening elements in different types of Serial Verb Construction Nominalization (SVCNs).

#### 3.1 CSC Nominalization with Intervening elements

In this section, we consider the status of intervening elements in Chaining Serial Construction Nominalization (CSCNs). CSCs in Akan appear to retain TAMP markers when they are nominalized. This is not out of the ordinary as it has been attested by Koptjevskaja-Tamm (1993: 18) that cross-linguistically, “nominalizations may contain tenses, auxiliaries and adverbs.” This phenomenon can be seen in other instances of nominalization which are even more clear-cut, in which the intervening element is not phonologically (or semantically) ambiguous as it may be in the case of /-a-/ and /-N-/. In such cases, we are clearly dealing with aspectual markers. For example, in (15a–b), we find cases of the egressive (EGR) and

ingressive (INGR) aspects in a nominal, which can only be interpreted as such as there are no phonologically similar phenomena that could occur in such positions in Akan. Thus, we find a language-internal justification of the notion that nominals may contain aspectual elements more prototypically associated with verbs.

- (15) a. Kò-tó-bé-tóní  
 EGR-buy-INGR-sell  
 ‘Retail selling’ (lit. go (and) buy (and) sell)
- b. Kò-dwàré-bé-dí-wó-dèé  
 EGR-bath-INGR-eat-2SG.POSS-thing  
 ‘Leprosy’ (lit. go bathe (and) come (and) eat yours)

Table 1 shows more examples nominalized CSCs that have intervening elements.

Thus, in the case of *ntensere* (12, replicated here as 16), for example, because the source construction has negation and the resulting nominalized form also maintains the same semantic sense of negation, we argue that /-N-/ should be understood as negation (NEG) that has been transferred from the CSC to the CSCN.

- (16) a. Ñ-té m’ámánèhúnú ñ-sèré mé.  
 NEG-hear 1SG.POSS.catastrophe NEG-laugh 1SG.OBJ  
 ‘Don’t laugh when you hear of all my misfortunes.’
- b. Ñ-té-ń-sèré.  
 NEG-hear-NEG-laugh  
 ‘Do not hear and laugh’ (personal name)
- c. Yè-fré nò Ñtènsèré.  
 1pl.SBJ-call 3SG.OBJ Ntensere  
 ‘We call him Ntensere.’

Another clear example is *Amfaamfiri* (17a–c), which has TAMP markers indicating PST and NEG, again in both the source CSC and the resulting CSCN.

- (17) a. Ô-à-m-fá nè bóné á-m-firí nó.  
 3SG.SBJ-PST-NEG-take 3SG.POSS badness PST-NEG-lend 3SG.OBJ  
 ‘He/she didn’t forgive him/her for his/her badness.’
- b. À-m-fá-á-m-firí  
 PST-NEG-take-PST-NEG-lend  
 ‘Unforgiving one.’



21 Serial verb nominalization in Akan: The question of intervening elements

Table 1: CSC Nominalizations with intervening elements

SVN	Christaller (1933)	EDG (1971)	Obeng (2001)	Boadi (2005)	Bannerman et al. (2011)
1. a-bisa-nsu-a-ma-nsa COND-ask-water-COND-give-alcohol 'liberal, generous'	✓	✓	✗	✓	✗
2. a-di-a-boro-wo-kora PRF-eat-PRF-surpass-2SG-calabash 'fungus'	✓	✗	✗	✗	✗
3. a-hu-a-bɔ̃-birim PRF-see-PRF-strike-tremble 'one who inspires fear'	✗	✗	✓	✗	✗
4. a-ko-a-ma PRF-fight-PRF-give 'doubling'	✓	✗	✗	✗	✗
5. pɛ-wo-a-yɛ-dɛn look-2SG-PRF-do-what 'why should I look for you? (name)'	✗	✗	✓	✗	✗
6. n-te-n-sere NEG-hear-NEG-laugh 'do not hear and laugh (name)'	✗	✗	✓	✗	✗
7. a-to-a-pem PRF-encounter-PRF-collide 'unsurmountable point'	✗	✗	✓	✗	✓
8. a-wu-a-kyɛ PRF-hear-PRF-laugh 'one who dies for others'	✗	✗	✓	✗	✗
9. a-hunu-ani-a-n-ka-nsa PRF-see-eye-PRF-NEG-touch-hand 'lattice window'	✓	✓	✗	✗	✗

- c. Àmfiámfirí bà-à há.  
unforgiving one come-PST here  
'The Unforgiving One came here.'

It is also worth noting that in each of the above constructions, in a manner consistent with how SVCs operate in the language, the same TAMP is found on each verb of the SVC as well as on each verb in the SVCN that is derived from it. Thus in (17a–b), the only logical choice for the identity of the affixes on V1 and the V2 is the past tense (PST). The primary factor that leads to this analysis is the marking of negation on both verbs as retained in the nominal. In Akan, the negation of the past tense calls for /a-/ on each verb before the negative prefix. Again, this is understood as compelling evidence that, particularly for CSCs, elements from the finite construction are carried over into the nominal form showing that some nominals are more verb-like.

It can be noted that because nominalized CSCs are primarily used as *designata* and *denotata* or names of persons, places, things, etc., this is typically the sentential context in which such nouns can be found. While Table 1 shows examples of nominalized CSCs with intervening elements, it should be kept in mind that there are innumerable sentences that have the potential to be frozen and applied as *designata* and *denotata* to any person, place or thing either as a proper name or nickname. We have shown above that there are some SVCNs whose intervening elements may be ambiguous, yet when we examine the SVC source construction, we find that for Akan CSCs, it is possible to transfer the TAMP marker from the SVC to the SVCN. Given that this is possible, it then follows that intervening forms should be manifested by the same phonological form that they had in the CSC in the CSCN.

### **3.2 PL-ISVC nominalization with intervening elements**

As shown in Figure 1 above, we see that the micro-events expressed in the verb series in PL-ISVCs are closer together than CSCs in terms of conceptual distance. In other words, CSCs are closer to being like clauses separated by coordination or even more like separate sentences than PL-ISVCs (see Osam 2004). Another way of looking at it from the complementary side of the continuum is to say that PL-ISVCs are closer to being like Single Verbs than CSCs. Thus, in this section, we will look at how PL-ISVCs behave with regard to nominalization. The first thing that becomes imminently clear is that there are comparatively less attested PL-ISVC nominals with intervening elements than CSC nominals (see Table 2). Although this appears to be the case, it should be noted that PL-ISVC

nominalization is still a productive process as in the last few years, a very prominent case of *dumsɔ* (*dumsɔ*) ‘intermittent blackouts’ has been coined by Akan speakers in Ghana to describe the situation of the erratic power supply issues that plagued the country at the time. Thus, while we see that the main function of CSC nominalization is to designate and denote persons, places or things, PL-ISVCs can also be created on the fly, so to speak, to refer to a situation. Below, we will turn our attention to those PL-ISVCs with intervening elements.

Table 2: PL-ISVNs with intervening elements

SVN	Christaller (1933)	EDG (1971)	Boadi (2005)	Bannerman et al. (2011)
1. m-fua-n-hwe NMLZ-hold-NMLZ-beat ‘holding and beating’	✓	✗	✗	✗
2. tɔ-nko-a-da fall-nod-NMLZ-sleep ‘nodding off to sleep’	✗	✗	✓	✗
3. a-wu-n-nya-de(ɛ) NMLZ-die-NMLZ-leave-thing ‘inheritance’	✓	✓	✓	✓

- (18) a. Yê-à-fúá            nó            á-hwè    nò.  
1pl.SBJ-PRF-hold 3sg.OBJ PRF-beat 3sg.OBJ  
‘We have held and beat him.’
- b. M̂-fùà-ñ-hwé  
NMLZ-hold-NMLZ-beat  
‘Holding and beating’
- c. Sédèè wò-dí-ì    nò            m̂fùàñhwé            nó ñ-yé.  
manner 3pl-eat-PST 3sg.OBJ holding-and-beating CD NEG-be  
‘The manner in which they held him and beat him up is not good.’

According to Barkema (1996), we find that compositionality (or lack thereof) is one of several criteria used to identify an SVC. In the case of *mfuanhwe* (18a–b), we see that the fully compositional meaning is transferred directly from the SVC (18a) to the SVCN (18b). In other words, *fua* means ‘to hold’ and *hwe* means ‘to beat’ in both the SVC and SVCN. While this may not seem remarkable, it is a salient feature in terms of differentiating PL-ISVCs from FL-ISVCs, each of which nominalizes to vastly different degrees, with PL-ISVCs rarely nominalizing while FL-ISVCs almost always have nominal counterparts recognizable by native speakers.

In (18a), note that while the source SVC has the perfect (PRF) /a-/, this TAMP marking is not carried over to the SVCN (18b). Rather, what we find is /-N-/ on both verbal elements. It may be recalled that in the Akan language /N-/ can function as a marker of negation, plurality, nominalization or mood. In the case of (18b), we see clearly that the nominal has not retained any type of TAMP marking from the SVC form as there is no semantic connotation of negation as we saw in the instance of nominalized CSC *ntensere*, for example (see 16a–b). Further, there is no indication of plurality or mood marking in the SVCN form (18b). This leaves the only possible option for /-N-/ as being the marker of nominalization. Thus, again, by way of a method for identifying intervening elements, we can look to the source SVC construction for guidance in understanding which, if any, intervening elements have been retained and transferred over to the derived SVCN. It is worth noting here that in our analysis of SVCNs, both verbs are marked with the same phonological form of /-N-/ at  $\alpha$ -place of articulation. These types appear to follow a concordance marking type of system of finite SVCs similar to what is seen in Bantu and other noun class languages (Aikhenvald & Dixon 2006).<sup>6</sup>

---

<sup>6</sup>When there are two markers of nominalization in the same SVN, typically they have the same phonological form. Although presented as unlikely, Kambon (2012: 211) entertained the remote possibility that /-N-/ comes from an elided conjunction *na*, which in Akan joins two clauses or sentences, as shown below:

- (i) Fua na hwe → fua n’hwe  
hold conj beat  
‘hold and beat’

In such an analysis, the initial /N/ would then still be interpreted as a nominalization marker. What makes this analysis unappealing is the fact that cross-dialectally, the intervening /-N-/ is not obligatory. Interestingly enough, Boadi (2005) has *mfuahwee* without the intervening /-N-/. Boadi’s version of the PL-ISVC patterns after the base template form typical of FL-ISVCs, which typically do not include any intervening elements.

Example (19) is also compositional as expected for a PL-ISVC<sup>7</sup> both in terms of the SVC form and the SVCN form as *wu* ‘to die’ and *gya* ‘leave’ still essentially retain their meanings upon nominalization. Unlike in the case of nominalized CSCs, wherein TAMP marking was retained, for (19), we see clearly that there is no semantic connotation of negation in the SVCN. Nor is there any mood marking or plurality evident in the SVCN. Thus, out of the options possible for /-N-/, the only likely one left is that of a nominalization marker. This is to be expected due to the fact that PL-ISVCs are less sentential than CSCs, thus, those intervening elements when they do appear are less likely to be TAMP markers and more likely to be nominalization markers.

- (19) a. Mé wòfà á-wú á-gyà mè àdéé.  
 1SG.SBJ maternal-uncle PRF-die PRF-leave 1SG.OBJ thing  
 ‘My uncle has died and bequeathed me with something.’
- b. À-wú-ń-gyá-dé(é)  
 ?NMLZ/?PRF-die-?NMLZ/?NEG-leave-thing  
 ‘Inheritance’
- c. N’àwúńnyádeé ñ-kò-sí àhé ípó.  
 3SG.POSS.inheritance NEG-EGR-stand how-much even  
 ‘His/her inheritance did not even amount to much.’

### 3.3 FL-ISVC nominalization with intervening elements

We now turn our attention to FL-ISVNs that have intervening elements as attested in dictionaries/wordlists or as produced by native speakers during the course of our research. Table 3 exemplifies those that were identified.

- (20) a. Ì-ń-tú nè hó ñ-kyé kóráá.  
 3SG.SBJ-NEG-uproot 3SG.POSS body NEG-give.as.gift at all  
 ‘He doesn’t volunteer at all.’
- b. À-tù-hó-á-kyé  
 NMLZ-uproot-body-NMLZ-give.as.gift  
 ‘Volunteerism’

<sup>7</sup>A case could be made for this form being an FL-ISVC due to the idea of inheritance being different from the sum total of its parts. We are of the opinion, however, that the concept is transparent enough for the compositional meanings of the individual verbs from which the SVCN is derived to shine through. In any case, it is typical for FL-ISVCs as lexicalized idioms to retain “literal counterfeit forms” just as in English, for example, “having cold feet” could either mean to be afraid or simply for one’s feet to be cold temperature-wise.

Table 3: FL-ISVNs with intervening elements

SVN	Christaller (1933)	EDG (1971)	Boadi (2005)	Bannerman et al. (2011)
1. m-bɔ-n-to-hɔ NMLZ-hit-NMLZ-throw-there 'procrastination'	✓	✓	✓	✓
2. m-fa-(n)-to-ho NMLZ-take-NMLZ-throw-body 'comparison, example'	✓	✓	✓	✓
3. a-firi-n-hyia NMLZ-leave-NMLZ-meet 'meeting of an annual date'	✓	✓	✗	✓
4. n-nye-n-to-m(u) NMLZ-receive-NMLZ-put-inside 'acceptance, admission'	✓	✗	✓	✓
5. m-mɔ-to-so NMLZ-hit-throw-top 'accusation'	✓	✗	✗	✓
6. a-tu-ho-a-kye NMLZ-uproot-body-NMLZ-give	✓	✓	✗	✓
7. a-kɔ-a-ba NMLZ-go-NMLZ-come 'welcome' (greeting)	✓	✓	✓	✗

c. Ǿ-bé-kyèrɛ àhùmmóbórɔ́ né àtùhóákyé.  
 3.sg.SBJ-fut-show mercy and volunteerism  
 'He/she will show mercy and volunteerism.' (lit. he will exhibit  
 (characteristics of) mercy and volunteerism)

As shown in (20), FL-ISVCNs do not retain TAMP markers from their source constructions. For instance, the negation in (20a) is not carried over into the noun in (20b). While we find /-a-/ as intervening element in (20b), we are reminded that there are three potential instantiations of /-a-/ whereby it can occur as a perfective marker, a singular or plural nominal marker or a marker of nominalization. However, in (20b), there is no active sense of the perfective in use here that would relegate the noun volunteerism to the perfect. This can be seen in (20c) in which the future tense is used with the TAMP-neutral *atuhoakye*. Thus, the intervening element /-a-/ in *a-tu-ho-a-kye* is properly analyzed as a nominalizer (NMLZ) (20b). Again, while it is evident that the same phonological form of /-a-/ can be used for different purposes in the language, it is also clear that by assessing TAMP marking in the source SVC and determining if any of these TAMP markers are/can be realized in the SVCN, we are able to disambiguate and see which /-a-/ we are dealing with in a given construction. Because FL-ISVCs as lexicalized idioms are consistently expected to express abstract concepts, we expect that TAMP marking will not occur regardless of whether the intervening elements are /-a-/ or /-N-/. As mentioned in §1, FL-ISVCs are prototypically expected to be non-compositional, collocationally closed, inflexible, and highly familiar due to their high degree of idiomaticity and concomitant lexicalization. Thus, similarly in (21a–b), we find that even when there is negation in a given SVC, TAMP marking is not carried over into the SVCN as we found with CSC ntensere.

- (21) a. Mè-ń-gyé                      w'ásém                      nó ń-tò                      mú.  
 1SG.SBJ-NEG-accept 2SG.POSS.word DET NEG-throw inside  
 'I don't accept your word.'
- b. Ñ-gyé-ń-tó-m(ú)  
 NMLZ-accept-NMLZ-throw-inside  
 'Acceptance'
- c. Ñnyéntóm(ú) bíará á-m-mà                      só wò yè̀n                      ñtám(ú).  
 acceptance any PST-NEG-come top at 1pl.POSS between  
 'No acceptance came about between us.'

In light of the above discussion, for all intents and purposes, we seem to have a continuum where, as posited by Vendler (1967), with regard to verbs in general, SVCNs derived from CSCs retain more verb-like features upon nominalization while others derived from ISVCs are more prototypically nominal with such verbal elements such as TAMP marking stripped away. According to Vendler (1967: 131) there are imperfect nominals and perfect nominals, “one in which the verb

is still alive as a verb, and the other in which the verb is dead as a verb, having become a noun.” It is important to note that rather than a sharp dividing line that would come with a “necessary and sufficient conditions” type of approach, here, we appear to be dealing with a continuum among nouns where some may be more on the noun-like side of the continuum (eg. ISVCs) while others may be more verb-like (eg. CSCs).

What we learn from the different SVCNs is that although there is potentially an instance of surface ambiguity with regard to the nature of intervening elements, once the source construction and resulting SVCN are examined, it becomes clear in each case that only one of the potential options is viable in any given case. For instance, we observe that *ntwantoso* ‘false accusation’ and other FL-ISVCNs with intervening elements are more “noun-like” i.e. stripped of TAMP morphology. Additionally, its meaning is non-compositional, it is highly idiomatic and highly lexicalized. It is also highly familiar, as is expected for a more prototypical FL-ISVC. In his 2012 study, Kambon reports that when given the individual elements of the FL-ISVC *twa...to...so*, 100% of his respondents produced the SVCN and 93% of respondents gave ‘false accusation’ as the meaning of the noun. Thus, Kambon (2012) concludes that *ntwantoso* is probably one of the most recognizable, current and institutionalized cases of FL-ISVC nominalization. It then becomes increasingly clear that once we are able to identify the source construction in terms of semantic integration, lexicalization and idiomaticity, we may reasonably come to expect certain patterned behavior (or lack thereof) with regard to whether or not TAMP marking will be actualized upon nominalization.

Here, it is also worth noting that intervening elements in SVCNs in general and ISVCNs in particular are the exception rather than the rule with less than ten identified out of just short of 150 attested cases of FL-ISVC nominalization. Further, for the SVCNs with intervening elements, not all speakers produced forms with intervening elements. In fact, it was oftentimes more likely that speakers of Asante and Akuapem (dialects of Akan spoken in different regions of Ghana) would produce forms without intervening elements than that they would produce variants containing them. This begs the question of the motivation for the intervening elements when they do appear. One explanation could be wholly phonological, where the nasal /-N-/ may actually be phonologically conditioned and semantically null. This pattern was typical of Fante speakers interviewed in Phase Two study groups, in which they regularly produced forms such as *ngyentom* from *gye...to...mu*, *ntwantodo* from *twa...to...so*, *mbɔntohɔ* from *bɔ...to...hɔ* etc. Supplementing this analysis is the idea that, originally, FL-ISVCs were derived from CSCs and ultimately from separate clauses and/or sentences. This progression is illustrated in Figure 2 below.



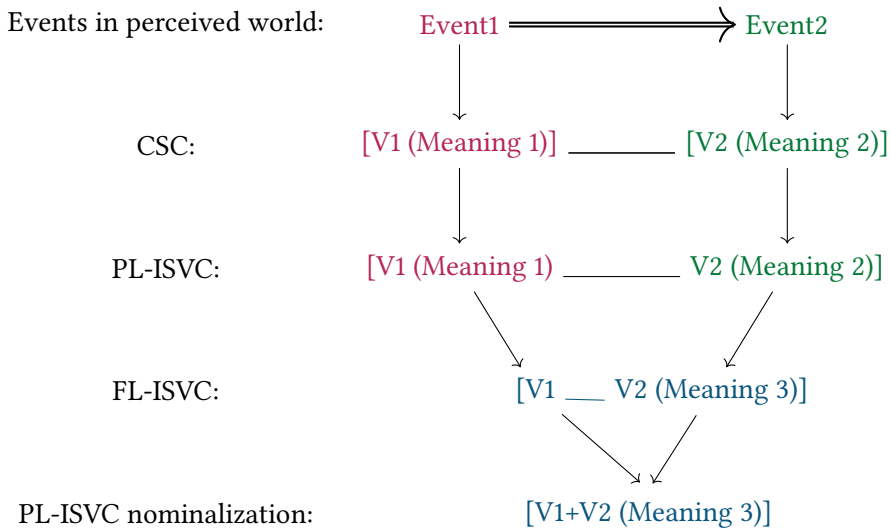

Figure 2: Iconicity from perceived world to nominalization (Kambon 2012: 41)

It should be noted that although this is given as the putative route by which FL-ISVCs came to exist in the language, it is not thought that each and every FL-ISVC currently in the language had to necessarily take this same route. Rather, we argue that once these SVCs with different levels of semantic integration and concomitant lexicalization, appeared as classes of ISVCs, they provided a base template by which other similar SVCs could be created and nominalized on analogy with prototypical instantiations. We will look at these base template forms in §4 below.

#### 4 SVCN schemata and the nature of intervening elements

In this paper, we have illustrated that Akan SVCs have been shown to be of two main types, namely Integrated Serial Verb Constructions (ISVCs) and Chaining Serial Constructions (CSCs) (Osam 1994; Agyeman 2002; Kambon 2012; Kambon et al. 2015). We have also shown that tracing the SVCN back to its SVC source is indispensable as a method of determining the precise nature of intervening elements. We have argued that because CSCs are more verb-like, they retain more verbal elements like TAMP marking, while ISVCs are more noun-like and therefore, they are more likely to strip off this marking. In this section, we derive abstract schemata from the forms of the distinct types of nominals found in Akan

and discussed in this study. We suggest that these schemata provide a way to predictably account for the internal structure of the various types of SVCNs found in Akan, paying particular attention to intervening elements (or lack thereof) between the erstwhile verb series in the SVCN complex. These schemata should enable us to reliably determine what type(s) of elements will occur in specific positions within SVCNs that are derived from different types of SVCs. To this end, we posit two (2) broad categorizations for all Akan SVCNs based on the level of semantic integration and lexicalization of the SVC from which the SVCN is ultimately derived.

The schemata proposed for SVCNs are based on the classification of SVCs based on semantic integration and lexicalization. Schema 1 (22) involves SVCNs (4) derived from ISVCs and Schema 2 (23) involves SVCNs that are derived from the CSC type.

(22) Schema 1: [ ([NMLZ]) V<sub>1</sub> ([NMLZ]) V<sub>2</sub> ([NMLZ]) ([OBJ])/([RELN]) ]<sub>ISVCN</sub>

- likely FL-ISVC or PL-ISVC (formally)
- meaning derived non-compositionally (FL-ISVCs) or compositionally (PL-ISVCs)
- likely not to retain verbal inflection

(21') Ñ-twá-ń-tó-só  
 NMLZ-cut-NMLZ-throw-top  
 'false accusation'

- (23)
- likely CSC
  - meaning derived haphazardly and functioning as denotata and designata
  - likely to retain verbal inflections

(22') Ñ-té-ń-sèré  
 NEG-hear-NEG-laugh  
 'Do not hear and laugh' (personal name).

Thus, even though the SVCN in (4) and (4) appear to have the same intervening element /-N-/, with the same phonological form and tone, the intervening element /-N-/ does not have the same status, meaning or function in the two nominals. /-N-/ in the nominalized FL-ISVC (4) should be understood as a nominalization marker (NMLZ) while /-N-/ in the nominalized CSC (4), it should be

understood as a negation marker that is retained in the SVCN as is evident in the semantics of the nominal. In other words, because *ntensere* is a Chaining Serial Construction Nominal (CSCN) it retains TAMP markers upon nominalization and its meaning is also compositional. Thus, unlike in FL-ISVC nominalization, in the CSC, each verb is still active and, therefore, TAMP is still in play all the way through to the point of nominalization. These two possibilities of nominalization and schemata for disambiguating the two are helpful in terms of providing a featural approach to predict what type of intervening elements should be expected to occur, when they do appear within the SVCN. Thus, when we have a CSCN, we can anticipate that TAMP markers will appear in specific positions vis-à-vis the verb-derived elements in the SVCN. In ISVCNs, we are more likely, on the other hand, to be dealing with nominalization markers where such elements appear.

Further, in the case of Schema 1, we posit that NMLZ markers may be viewed as instantiations of recycled morphology (Booij 2007). In other words, it may be argued that preexisting morphological markers have been reanalyzed and re-deployed with a different function over the course of time. Such an analysis would be consistent with a redeployment of markers of the defunct noun class system proposed by Osam (1993) as singular and/or plural nominal markers synchronically. In other words, the affixes found on nouns from the vestigial noun class system have also been reanalyzed as nominalizing markers for the primary function of consolidating two erstwhile disparate verbs into a single unit.

With specific reference to intervening elements, we argue that degree of lexicalization (and attendant semantic integration) may have a predictive power with regard to whether TAMP information will be retained or it will be stripped. Thus we can begin to form certain expectations with regard to nominalization behavior and the types of affixes that will be found in SVCNs based on the degree of lexicalization of the SVC source.

#### 4.1 Counterfeit

In §1, we briefly alluded to the fact that /a/ can also serve as a conditional marker in the language, although when it is found as a conditional marker, it rules out the source construction as an SVC. Also, although orthographically the conditional marker /a/ is written the same as the other types outlined in §3, there is also a difference tonally where /a/ cliticizes on the preceding word (particularly when that word ends with an open syllable) and it also tends to be pronounced with a falling tone in careful speech, unlike other surface look-alikes. All the same, because conditionals can be nominalized, it is worth briefly outlining a third schema to account for what we term “counterfeit SVCNs.” Again, in order to dif-

ferentiate this nominalized conditional construction from other superficially similar constructions, it is imperative that we take a look at the source construction from which it is derived. In pursuing this line of thinking, we find that in Akan, there are some nominals that may have the appearance of an SVCN but that may involve a more complex structure than that which we find in an SVCN. These counterfeit SVCNs that masquerade as proper SVCNs can actually be traced back to conditional constructions marked with an inter-sentential conditional marker /a/. Consider the structure of the nominals in (24) and (25).

- (24) a. Wó-tàñ mé á, wú!  
2SG.SBJ-hate 1SG.OBJ cond, die.imp  
'If you hate me, die.'
- b. Tàñ-mé-á-wù  
Hate-1.sg-cond-die  
'If you hate me, you can (go ahead and) die.' (a personal name)
- c. Òkrámañ nó dín dè Tàñ-mé-á-wú.  
dog DET name take Tanmeawu  
'The dog's name is If-you-hate-me-then-die.'
- (25) a. Wó-dò mé á, brà!  
2SG.SBJ-love 1SG.OBJ cond, come.imp  
'If you love me, come!'
- b. Dò-mé-á-brà  
love-1.sg-cond-come  
'A distant place' (lit. if you love me, come)
- c. Mè-firi Dòmeabra  
1SG.SBJ-come-from Dòmeabra.  
'I come from Dòmeabra.' (name of a town)

In examples (24) and (25), although we can see /-a-/ as an intervening element, it should be noted that this is an entirely different phenomenon from that which we have been addressing throughout this paper with regard to SVCNs. First, the source construction is not an SVC in the first place as each sentence in (24a) and (25a) has a matrix clause and an embedded clause. It is also important to note that clauses in Akan must have a subject whether overt or not (Osam 1994: 262; Saah 1994: 120, see Duah 2013: 164-168 for an exceptional case). In the examples

above, the covert subject of the subordinate clause is you and the clause is understood as being expressed in the imperative. With regard to the embedded clause, the imperative reading negates other readings. In (25a) no reading other than the conditional reading is available as the very morphological form is one that only surfaces in the imperative *bra* ‘come’ specific to a 2SG addressee and is in complementary distribution with *ba* ‘come’ in all other contexts. Thus, although the intervening /-a-/ makes these nominals appear similar to true SVCNs on the surface, a close analysis of the underlying morphosyntactic and semantic features reveal them to be reflective of entirely different linguistic phenomena.

Thus, we propose that multi-clausal nominalization (MCN) is formulated based on an entirely different schema from those delineated in (22–23) as shown below:

(26) Schema 3:

[s1 ([SBJ]) ([TAMP]) [V<sub>1</sub>] ([cond]) [s2([SBJ]) ([TAMP]) [V<sub>2</sub>.] ([TAMP]) ([OBJ])] ]<sub>MCN</sub>

- two separate clauses (either of which may or may not happen to include a SVC)
- compositional in finite form
- usually traceable back to source utterance in nominalized form

The discussion so far has revealed that SVCNs which are derived from FL-ISVCs tend to pattern more on the side of pure nominal with less finite verbal features/characteristics carried over. SVCNs with a PL-ISVC source seem to be in-between often structurally patterning after FL-ISVCs, while semantically patterning after CSCs in terms of retention of individual verbal semantics. Chaining Serial Constructions (CSC) tend to have most of their verbal features carried over into the nominal as exemplified in the retention of TAMP markers. Meanwhile, on the far-left end of the spectrum are the counterfeit SVCNs, which are more sentence-like and retain their semantic and morphosyntactic features, even upon nominalization. Thus, while all of these possibilities may look the same on the surface, in truth they are not. Figure 3 illustrates these possibilities via a tripartite continuum.

## 5 Conclusion

In conclusion, we find that in each case, whether CSC, ISVC or conditional sentence, using the source construction as a litmus test, we are consistently able to disambiguate superficially similar intervening elements in the nominalized construction. Further, it has been demonstrated that there is a continuum whereby there are more verb-like SVCNs that co-exist in the language with more nounlike

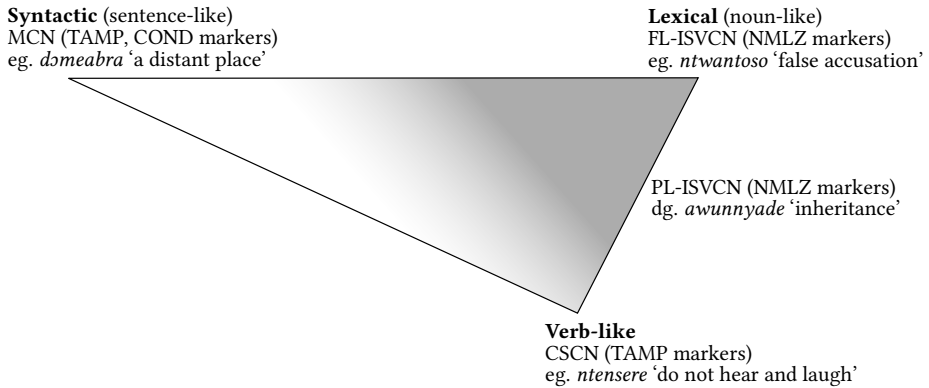

Figure 3: Nominalization tripartite continuum

SVCNs. The more verb-like SVCNs are those which are derived from Chaining Serial Constructions (CSCs), which retain TAMP markers when they are present in the source SVC. The more noun-like SVCNs are those which are derived from PL-ISVCs and FL-ISVCs. In the case of SVCNs, their recycled morphosyntactic elements point to preexisting morphological and/or syntactic items redeployed in a different (typically more or less grammatical) function over the course of time (Booij 2007).

## Abbreviations

1/2/3	first/second/third person	NEG	negative
CD	clausal determiner	NMLZ	nominalizer
COND	conditional marker	OBJ	object
CONJ	conjunction	PL	plural
DEM	demonstrative	POSS	possessive
DET	determiner	PRF	perfect
EGR	egressive	PRT	particle
INGR	ingressive	PST	past tense
INDF	indefinite	RELN	relator noun
N	any nasal at $\alpha$ place of articulation	SBJ	subject
		SG	singular

## Acknowledgements

We would like to thank the organizers of ACAL47, University of California, Berkeley, for providing financial support for Reginald Akuoko Duah to attend ACAL47. We are grateful especially to Larry Hyman, Peter Jenks and Hannah Sande for their warm reception and help before and during ACAL47 Berkeley. We are grateful to two anonymous reviewers whose comments helped us in revising our paper.

## References

- Aboh, Enoch O. & Maria Dyakonova. 2009. Predicate doubling and parallel chains. *Lingua* 119(7). 1035–1065.
- Agyeman, Nana Ama. 2002. *Serial verb constructions in Akan*. Norwegian University of Science & Technology. (MA thesis).
- Aikhenvald, Alexandra Y. & R. M. W. Dixon. 2006. *Serial verb constructions: A cross-linguistic typology*. New York: Oxford University Press.
- Appah, Clement K. I. 2003. *Nominal derivation in Akan: A descriptive analysis*. Norwegian University of Science & Technology. (MPhil Thesis).
- Bannerman, J. Yedu, D. E. K. Krampah, G. F. Kojo Arthur & Kwesi A. Dickson. 2011. *Mfantse nkasafua na kasambirenyi nkyerease: Dictionary of Mfantse words and idioms*. Tema: Center for Indigenous Knowledge Systems.
- Barkema, Henk. 1996. Idiomaticity and terminology: A multi-dimensional descriptive model. *Studia Linguistica* 50(2). 125–160.
- Boadi, Lawrence A. 2005. *Twi kasa mmara ne kaseso*. Kumasi: Katawuri.
- Bodomo, Adams. 2004. The syntax of nominalized complex verbal predicates in Dagaare. *Studia Linguistica* 58(1). 1–22.
- Bodomo, Adams. 2006. On nominalizing the verbal complex in Dagaare and English. In *11th biennial symposium on linguistics: Inter-theoretical approaches to complex verb constructions*, 1–17. Houston: Rice University.
- Bodomo, Adams & Marc van Oostendorp. 1994. *Serial verb nominalisations in Dagaare*. Washington, DC: ERIC Clearinghouse.
- Booij, Geert. 2007. Construction morphology and the lexicon. In *Selected proceedings of the 5th Decembrettes: Morphology in Toulouse*. University of Toulouse - le Mirail: Cascadilla Proceedings Project.
- Christaller, Johannes Gottlieb. 1933. *A dictionary of the Asante and Fante language called Tshi (Twi)*. Basel: Basel Evangelical Missionary Society.

- Department of Education, Ghana. 1971. *Twi Nsem Nkorenkore Kyerewbea*. Accra: Waterville Publishing House.
- Duah, Reginald A. 2013. *Force dynamics and causation in Akan*. Legon: University of Ghana. (Doctoral dissertation).
- Hiraiwa, Ken & Bodomo Adams. 2008. Object-sharing as symmetric sharing: Predicate clefting and serial verbs in Dagaare. *Natural Language Linguistic Theory* 26. 795–832.
- Kambon, Obadele. 2012. *Serial verb nominalization in Akan*. Legon: University of Ghana. (Doctoral dissertation).
- Kambon, Obadele, E. Kweku Osam & Nana A. Amfo. 2015. A case for revisiting definitions of serial verb constructions – evidence from Akan serial verb nominalization. *Studies in African Linguistics* 44(2). 75–99.
- Koptjevskaja-Tamm, Maria. 1993. *Nominalizations*. Oxford: Routledge.
- Obeng, Samuel Gyasi. 2001. *African anthroponymy: An ethnopragmatic and morphophonological study of personal names in Akan and some African societies*. München: Lincom Europa.
- Osam, E. Kweku. 1993. The loss of the noun class system in Akan. *Acta Linguistica Hafniensia* 26. 81–106.
- Osam, E. Kweku. 1994. *Aspects of Akan grammar: A functional perspective*. Eugene, OR: University of Oregon. (Doctoral dissertation).
- Osam, E. Kweku. 2004. *The Trondheim lectures, an introduction to the structure of Akan: Its verbal and multiverbal systems*. Legon: Department of Linguistics.
- Patton, Michael Quinn. 2002. *Qualitative research and evaluation methods*. New Delhi: SAGE Publications.
- Saah, Kofi K. 1994. *Studies in Akan syntax, acquisition, and sentence processing*. University of Ottawa. (Doctoral dissertation).
- Vendler, Zeno. 1967. *Linguistics in philosophy*. New York: Cornell University Press.



## Chapter 22

# Verb and predicate coordination in Ibibio

Philip T. Duncan

University of Kansas

Travis Major

University of California, Los Angeles

Mfon Udoinyang

University of Kansas

This paper reports on the ‘and’-word *nyáŋ* in Ibibio verbal coordination. Like English *and*, Ibibio possesses morphologically invariant coordinators linking NPs, PPs, and CPs. However, these cannot coordinate verbs and predicates, unlike *and* in English. Many African languages distinguish between nominal and verbal coordinators (Welmers 1973: 305), but Ibibio showcases this distinction in a unique way. Subject agreement and inflection for tense and negation suggest that *nyáŋ* is a verb, resembling “‘and’-verbs” in Walman (Brown & Dryer 2008). Closer inspection reveals that *nyáŋ* patterns more like an adverb or functional head, expanding our understanding of what constitutes ‘and’ cross-linguistically.

## 1 Introduction

Across African and Niger-Congo languages, juxtaposition serves as a general strategy for coordinating clausal units (Zeller 2015; Creissels 2000; Watters 2000). African languages also commonly feature a distinction in coordinators triggered by categorial features of the conjuncts. Such distinction can be seen, for example, in Dagbani, where *mini* exclusively conjoins nominal expressions, and *ka* is obligatory for coordinating verbal predicates and clauses.



- (1) Dagbani (Gur; Niger-Congo)
- a. doo η ɔ **mini** m ba cheni daa  
 man this and my father go.IPFV market  
 ‘This man and my father go to the market.’ (Olawsky 1999: 44)
- b. o bici **ka** kɔ̃sisi **ka** dãi  
 he be.bad and be.thin and be.dirty  
 ‘He is bad and thin and dirty.’ (Olawsky 1999: 44)
- c. m ba wumdi dagbanli **ka** tuzɔhi wumdi silimiinsili  
 my father hear.IPFV Dagbani and brothers hear.IPFV English  
 ‘My father knows Dagbani and my brothers know English.’  
 (Olawsky 1999: 51)

Ibibio, a Lower Cross Niger-Congo language spoken in Akwa Ibom State, Nigeria likewise showcases this division, but with an unexpected twist: the language recruits an unlikely candidate for verb and predicate coordination, one that we show has verb- and adverb-like properties.

Ibibio uses an array of equivalent coordinators for NP/DP coordination.<sup>1,2</sup>

- (2) Ékpè **yè/̀nd̀d̀/̀m̀m̀** Àkpán è-mà é-η wóη úkótínsλη.  
 Ekpe and Akpan 3PL-PST 3PL-drink palmwine  
 ‘Ekpe and Akpan drank palmwine.’

These are, however, illicit when coordinating verbs and larger verbal constructions. Instead, *nyáη* is used, which surfaces to the left of the main verb in the second conjunct.

- (3) a. À-mà à-díá àdésì **à-nyáη**/\*yè/\*̀nd̀d̀/\*̀m̀m̀ à-η wóη  
 2SG-PST 2SG-eat rice 2SG-and 2SG-drink palmwine  
 úkótínsλη.  
 ‘You ate rice and drank palmwine.’
- b. Ìmá á-kpón **á-nyáη**/\*yè/\*̀nd̀d̀/\*̀m̀m̀ á-yáíyá.  
 Ima 3SG-become.big 3SG-and 3SG-be.beautiful  
 ‘Ima grew up and became beautiful.’

<sup>1</sup>Essien (1990: 147) treats these three coordinators as “dialectal variants.”

<sup>2</sup>Unless otherwise noted, our Ibibio data are from Mfon Udoinyang and reflect his judgments.

Cross-linguistically, ‘and’-words are typically not verbs, though they can be in some languages (e.g., Walman; see Brown & Dryer 2008). One puzzling aspect of Ibibio verb and predicate coordination, then, is the fact that the overt element that signals coordinate status bears person and number agreement, which is a property of verbs and other elements that comprise the clausal spine across the verbal and inflectional domains (Baker & Willie 2010).

Our aim in this paper is to investigate distributional evidence for *nyáŋ* in order to approach an understanding of its status in Ibibio, and provide a foundation for further investigation of the structure(s) of *nyáŋ* clauses. To clarify what *nyáŋ* might be—and what it is not—we compare it with similar constructions involving verbs (e.g., serial verbs) and low adverbs. Traditionally in Ibibio literature (Essien 1985; 1990), as well as in closely-related Efik (Goldie 1857; Welmers 1968; 1973),<sup>3</sup> *nyáŋ* has been analyzed as a coordinator itself (a conjunction) that is “verbal grammatically and conjunctive in function” (Essien 1990: 148). Our work shows, though, that it is not entirely verbal. Moreover, it may not actually be the coordinator, but some third thing that surfaces in verbal coordination. The data we present suggests that *nyáŋ* inhabits a liminal space somewhere at or near the border of the inflectional and verbal layers. Current evidence seems to tip the balance toward an adverb-style analysis.

## 2 Is *nyáŋ* a serial verb?

The verbal coordinator *nyáŋ* bears person and number features. Other possible inflectional marking on *nyáŋ* includes tense and negation (Essien 1985; 1990). Moreover, *nyáŋ* in many cases appears flanked by verbs, making it look (on the surface) like one verb in a series.

- (4) *Ínêṃ á-mă-kòp á-nyáŋ á-dí.*  
 Inem 3SG-PST-hear 3SG-and 3SG-come  
 ‘Inem heard it and came.’ (Essien 1985: 86)

Because of these properties, Essien (1985: 86) (and Essien 1990: 142) treats *nyáŋ* as a V in a  $V_1 V_n$  sequence, calling it a “serial construction.”

However, Ibibio *nyáŋ* clauses do not exhibit features that have shown to be characteristically associated with seriality in the language (Major 2015; Duncan 2016). In what follows, we consider *nyáŋ* in light of the following properties of

<sup>3</sup>While *nyáŋ* in Ibibio and Efik resemble each other morphosyntactically, there are important differences. For example, Efik *nyáŋ* cannot take the negative suffix, unlike Ibibio (see §2.3).

serial verbs in Ibibio, which we take as tests of seriality: (a) single tense marking, (b) obligatory subject sharing, (c) availability of contrastive verb focus, (d) single negation, and (e) object sharing.

## 2.1 Single tense test

Collins (1997) and Hiraiwa & Bodomomo (2008) argue that serial verb constructions (SVCs) maximally contain a single tense marker. This property obtains for true SVCs in Ibibio (Major 2015).

- (5) a. Ékpè á-mà á-dí (\*á-mà) í-sé úfòk òmmì.  
 Ekpe 3SG-PST 3SG-come 3SG-PST I-see house 1SG-POSS  
 ‘Ekpe came and saw my house.’
- b. Ínèm á-mà á-kòp á-mà á-nyáŋ á-dí.  
 Inem 3SG-PST 3SG-hear 3SG-PST 3SG-and 3SG-come  
 ‘Inem heard it and came.’

The SVC in (5a) is thus ungrammatical if the second tense marker is added. *Nyáŋ* clauses, though, may contain more than one tense marker, depending on the number of conjuncts involved. In (5b), the past tense marker *mà* appears twice, once in the first conjunct and once in the second.

Related to this, verbs in Ibibio SVCs obligatorily share a single subject. Again, though, we find that this is not the case for *nyáŋ* clauses.

- (6) a. \* Òkòn á-mà á-dùwó Àkpán á-dák àdùbè.  
 Okon 3SG-PST 3SG-fall Akpan 3SG-enter pit  
 (Intended: ‘Okon fell (and) Akpan entered a pit.’)
- b. Ènò á-mà á-ká store á-nyáŋ Ímá á-mà á-dép òwèt.  
 Eno 3SG-PST 3SG-go store 3SG-and Ima 3SG-PST 3SG-buy book  
 ‘Eno went to the store and Ima bought a book.’

Subject restrictions in Ibibio SVCs follow from the existence of a single TP layer in such constructions. The absence of this restriction in *nyáŋ* clauses corresponds to the presence of a TP in each clausal conjunct.

## 2.2 Contrastive focus test

A second difference between SVCs and *nyáŋ* clauses in Ibibio pertains to the (un)availability of contrastive verb focus. In Ibibio, any (or all) verbs in an SVC can potentially undergo contrastive verb focus.

- (7) a. Òkôn á-mà á-tèm ndídíyá á-nyàm.  
Okon 3SG-PST 3SG-cook food 3SG-sell  
'Okon cooked food and sold it.'
- b. Òkôn á-mà á-tèé-tèm ndídíyá á-nyàm...  
Okon 3SG-PST 3SG-cook-cook food 3SG-sell  
'Okon COOKED food and sold it...'
- c. Òkôn á-mà á-tèm ndídíyá á-nyàá-nyàm...  
Okon 3SG-PST 3SG-cook food 3SG-sell-sell  
'Okon cooked food and SOLD it...'
- d. Òkôn á-mà á-tèé-tèm ndídíyá á-nyàá-nyàm...  
Okon 3SG-PST 3SG-cook-cook food 3SG-sell-sell  
'Okon COOKED food and SOLD it...'

Given the existence of a low focus phrase near the verbal domain in Ibibio (Duncan et al. 2018), Duncan (2016) proposes that the fact that any V in a  $V_1V_n$  sequence can be contrastively focused follows from the  $\nu$ P-internal nature of low FocP. Since SVCs contain at minimum two  $\nu$ Ps, iterated FocPs are an outcome of iterated  $\nu$ Ps (Duncan 2016: 98-100).

Interestingly, the verbal coordinator  $ny\acute{\lambda}\eta$  cannot participate in contrastive verb focus.<sup>4,5</sup>

- (8) \*Ímá á-kpón á-nyòó-ny\acute{\lambda}\eta á-yàiyá.  
Ima 3SG-become.big 3SG-and-and 3SG-be.beautiful  
(Intended: 'Ima became big AND beautiful.')

Again, this suggests that  $ny\acute{\lambda}\eta$  clauses are not exactly SVCs. What makes contrastively focusing  $ny\acute{\lambda}\eta$  impossible is not, however, due to the number of  $\nu$ Ps present. Presumably, there are two  $\nu$ Ps in (8), as there are two  $\nu$ Ps in each on the sentences in (7). Instead, we posit that the site of attachment for  $ny\acute{\lambda}\eta$  drives its inability to participate in contrastive verb focus. That is, the attachment site of  $ny\acute{\lambda}\eta$  is  $\nu$ P-external.

<sup>4</sup>An audience member at ACAL 45 raised the question as to the intended meaning of contrastively focused  $ny\acute{\lambda}\eta$  in the first place. We acknowledge that the meaning could be complicated, but presented the form as a diagnostic in the event that it were possible. (If, for example,  $ny\acute{\lambda}\eta$  were a verb with a meaning like 'do in addition to' then, potentially, a contrastive focus reading might emphasize the nature of the event in relation to another.) Regardless, we are unaware of any semantic constraints on verbs that bar them from participation in contrastive verb focus.

<sup>5</sup>For an overview of the formal features of Ibibio contrastive verb focus and its effects on vowel quality, see Akinlabi & Urua (2003) and Duncan et al. (2018).

### 2.3 Single negation test

Cross-linguistically, SVCs commonly allow for only one instance of negation (Hiraiwa & Bodomo 2008), and this holds for Ibibio, as well. In Ibibio, negation scopes over  $V_1$  and  $V_2$ , but only  $V_1$  gets negated (Major 2015).<sup>6</sup>

- (9) a. Ènò í-ké      í-dàkà-ké í-dá.  
 Eno I-PST.FOC I-rise-NEG I-stand  
 ‘Eno didn’t arise.’
- b. \*Ènò á-mà/í-ké      á-/í-dàkà í-dá-há.  
 Eno 3SG-PST/I-PST.FOC 3SG/I-rise I-stand-NEG  
 (Intended: ‘Eno didn’t arise.’)
- c. \*Ènò í-ké      í-dàkà-ké í-dá-há.  
 Eno I-PST.FOC I-rise-NEG I-stand-NEG  
 (Intended: ‘Eno didn’t arise.’)

The SVC meaning ‘arise’ is comprised of the verbs ‘rise’ and ‘stand’. As seen in (9a), when this construction is negated, only  $V_1$  bears the negative suffix, meaning that only the highest verb in the sequence raises to  $Neg^0$  (Duncan et al. 2018), possibly as it travels en route to  $T^0$ .<sup>7</sup> Thus, neither the lower verb can be negated, nor can both verbs be negated simultaneously.

From this, one straightforward prediction is that, if *nyáŋ* clauses are true SVCs, *nyáŋ* should be non-negatable, given that on the surface it follows  $V_1$  in the matrix clause. However, this is not the case.

- (10) Ínèm í-kí-kòp-pó      í-nyáŋ-ŋ ó í-dí.  
 Inem I-PST.FOC.I-hear-NEG I-and-NEG I-come  
 ‘Inem did not hear it and did not come.’ (Essien 1985: 86)

Like the serial verbs above, *nyáŋ* follows a higher, negated verb. Unlike SVCs, though, *nyáŋ* itself can be negated. This suggests that there is a  $NegP$  associated with the matrix verb, and there is a second  $NegP$  associated with the clause that houses *nyáŋ*. In other words, *nyáŋ* clauses have biclausal properties, whereas SVCs are monoclausal.

<sup>6</sup>The negative suffix in Ibibio has several allomorphs. See Akinlabi & Urua (2003: 124-127) and Duncan (2016: 89) for discussion.

<sup>7</sup>Baker & Willie (2010: 120) claim that “the verb moves to T in Ibibio and thus surfaces to the left of negation.” While we remain agnostic as to whether raising-to-T is a regular feature of Ibibio grammar, for our purposes, either analysis successfully accounts for the distributional facts in (9).

## 2.4 Object sharing test

The final property that we consider when comparing *nyáŋ* with SVCs is object sharing (Baker 1989), shown in the following examples.

- (11) a. Ékpê á-mà á-tóp ítíyát á-ń-tó.  
 Ekpe 3SG-PST 3SG-throw stone 3SG-1SG-hit  
 ‘Ekpe threw a stone and it hit me.’
- b. Ékpê á-mà á-tóp ítíyát á-nyáŋ á-ń-tó.  
 Ekpe 3SG-PST 3SG-throw stone 3SG-and 3SG-1SG-hit  
 ‘Ekpe threw a stone (somewhere) and (something else) hit me.’

In (11a), the overt object of  $V_1$ , *ítíyát* ‘stone’, is “shared” by  $V_2$ . This sentence thus has the interpretation that Ekpe threw a stone, and that same stone is what Ekpe hit me with. *Nyáŋ* disrupts this pattern; as seen in (11b), object sharing is blocked when the verbal coordinator is present.

## 2.5 Interim summary

Although *nyáŋ* clauses bear surface affinity to SVCs, the preceding discussion shows that these construction types fail to show key morphosyntactic attributes that are characteristic of SVCs. Table 1 summarizes these properties and how they do (or do not) map onto each clause type.

Table 1: Properties of Ibibio SVCs and *nyáŋ* clauses.

	Single tense	Obligatory S sharing	Contrastive focus	Single negation	O sharing
SVCs	Y	Y	Y	Y	Y
<i>Nyáŋ</i> clauses	N	N	N	N	N

While this does not amount to a positive account for what *nyáŋ* is, we take the above data as evidence for what *nyáŋ* is not: Ibibio *nyáŋ* clauses are not SVCs. Instead, *nyáŋ* clauses exhibit parataxis. Moreover, *nyáŋ* is verb-like in that it bears agreement and can be negated, but it also bears non-verb-like properties, such as the inability to undergo contrastive verb focus.

### 3 Structural observations

Structurally, it would appear that *nyáŋ* attaches below NegP, which is dominated by TP, and above *v*P. This yields the following hierarchy for the constituent containing *nyáŋ*.

- (12) TP » NegP » *nyáŋ* » *v*P

The location of *nyáŋ*—what we have been calling a coordinator—presents a bit of a puzzle. In a language like English, ‘and’ introduces (and precedes all overt material in) the second conjunct, allowing for a structure as follows with conjoined TPs.<sup>8</sup>

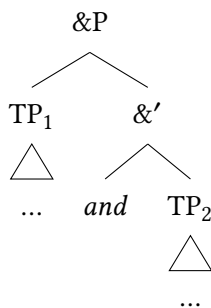

Figure 1: TP coordination in English.

This is quite common cross-linguistically: ‘and’-words typically intervene between conjuncts.

In Ibibio verb and predicate coordination, though, the ‘and’-word *nyáŋ* is embedded deeply inside the second conjunct. Thus, it is not that the presence of a second T<sup>0</sup> is problematic, and the possibility of a different subject for the lower clause containing *nyáŋ* is similarly unproblematic. How, then, might we account for the location of *nyáŋ*, and what might this indicate about its status?

We tentatively pose the structure in Figure 2 to account to account for the unique distribution of *nyáŋ*. If this line of thought is on the right track then, given its place in the structure, *nyáŋ* is not actually (or is very unlikely to be) a coordinator. Instead, it appears to be an associate of coordination that is restricted

<sup>8</sup>We adopt the asymmetric structures in Figure 1 and Figure 2 following, e.g., Munn (1987; 1993; 1999), Kayne (1994), and Johanessen (1998), a.o. Our point here is not to commit to a particular analysis of coordination for either English or Ibibio. Instead, we schematize coordination in each language to illustrate the uniqueness of *nyáŋ*’s place in the syntax, both in terms of word order and structurally in relation to the coordinator.



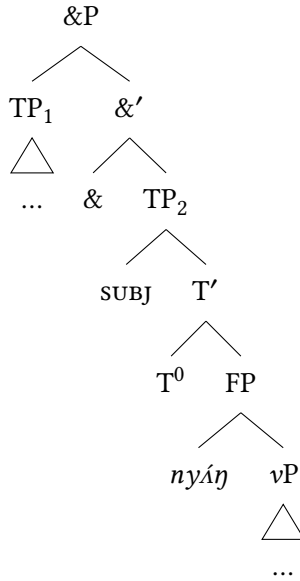

Figure 2: TP coordination in Ibibio.

to verbal coordination. We leave the precise structure of verb and predicate coordination to future investigation; for now, treating a structure like the one in Figure 2 as a live option opens up other avenues to consider, such as whether *nyáη* clauses really are coordinate structures.

#### 4 Are *nyáη* clauses really coordinate structures?

If Ibibio *nyáη* clauses involve parataxis, they should be sensitive to the Coordinate Structure Constraint (CSC) (Ross 1967), wherein:

- Extraction from a single conjunct is impossible; and
- Extraction from both conjuncts is grammatical (= across-the-board (ATB) extraction).

Ibibio verbal coordination is indeed island-inducing and sensitive to the CSC. When *vP*s are coordinated, object extraction becomes impossible. This supports the notion that *nyáη* clauses do involve coordination (whether or not *nyáη* is the coordinator or an associate of such).

Evidence for this comes from *wh*-movement. Neither the object in the first conjunct nor the object in the second conjunct can be extracted in *nyáŋ* clauses.

- (13) a. *Á-mà á-díá àdési á-nyáŋ á-ŋ wóŋ úkótísàŋ.*  
 3SG-PST 3SG-eat rice 3SG-and 3SG-drink palmwine  
 ‘She ate rice and drank palmwine.’
- b. \**Ñsǒ ké á-ké-díá á-nyáŋ á-ŋ wóŋ úkótísàŋ?*  
 what FOC 3SG-PST.FOC-eat 3SG-and 3SG-drink palmwine  
 (Intended: ‘What<sub>i</sub> did she eat *t<sub>i</sub>* and drink palmwine?’)
- c. \**Ñsǒ ké á-ké-díá àdési á-nyáŋ á-ŋ wóŋ?*  
 what FOC 3SG-PST.FOC-eat rice 3SG-and 3SG-drink  
 (Intended: ‘What<sub>i</sub> did she eat rice and drink *t<sub>i</sub>*?’)

ATB extraction is, however, permitted.

- (14) *Ñsǒ ké á-ké-díá á-nyáŋ á-ŋ wóŋ?*  
 what FOC 3SG-PST.FOC-eat 3SG-and 3SG-drink  
 ‘What<sub>i</sub> did she eat *t<sub>i</sub>* and drink *t<sub>i</sub>*?’

This result is expected if, in fact, *nyáŋ* clauses are coordinate structures.

Ibibio has both overt *wh*-movement (15a) and *wh-in-situ* questions (15b), the latter of which may involve covert movement.

- (15) a. *Ñsǒ ké á-ké/\*mà á-nám?*  
 what FOC 3SG-PST.FOC/\*PST 3SG-do  
 ‘What did she do?’
- b. *Á-ké á-nám ñsǒ?*  
 3SG-PST.FOC 3SG-do what  
 ‘What did she do?’
- c. *Á-mà á-nám ñsǒ?*  
 3SG-PST 3SG-do what  
 ‘She did what?’

Whether overt or covert,  $\bar{A}$ -extraction is signaled by the use of special focus tense morphology. In (15a-b), for example, the tense marker *ké-* is obligatory for past tense; use of the unmarked past tense marker *mà* produces ungrammaticality when extraction is overt, or else it signals an echo question, as in (15c).

These facts help us further diagnose the presence of coordination in *nyáŋ* clauses. Interestingly, with verbal coordination the object *wh*-question can remain in situ in the second conjunct with no overt object in the first conjunct (16a), but the reverse does not hold (16b).<sup>9</sup>

- (16) a. À-ké            à-díá    à-nyáŋ à-ŋ            wóŋ òsǒ?  
 2SG-PST.FOC 2SG-eat 2SG-and 2SG-drink what  
 ‘What<sub>i</sub> did you eat *t<sub>i</sub>* and drink *t<sub>i</sub>*?’
- b. \* À-ké            à-díá    òsǒ à-nyáŋ à-ŋ            wóŋ?  
 2SG-PST.FOC 2SG-eat what 2SG-and 2SG-drink  
 (Intended: ‘What did you eat and drink?’)

Combining these two strategies yields a positive result: two in situ questions can be coordinated by *nyáŋ*.<sup>10</sup>

- (17) À-ké            à-díá    òsǒ à-nyáŋ à-ŋ            wóŋ òsǒ?  
 2SG-PST.FOC 2SG-eat what 2SG-and 2SG-drink what  
 ‘What did you eat and drink?’

These facts suggest that both overt and covert ATB extraction are possible in Ibibio.

Thus, even though *nyáŋ* itself may not be a coordinator, predicate coordination behaves as if coordination is present. Clauses coordinated with *nyáŋ* behave like syntactic islands and obey CSC constraints. This makes a coordination analysis of *nyáŋ* clauses a viable option, even though the question of what *nyáŋ* is remains unresolved.

<sup>9</sup>It is also possible to leave an ordinary NP object in the first conjunct and have an object *wh*-element in the second.

- (i) À-ké            à-díá    ádésí à-nyáŋ à-ŋ            wóŋ òsǒ?  
 2SG-PST.FOC 2SG-eat rice 2SG-and 2SG-drink what  
 ‘You ate rice and drank what?’

However, this blocks the wide scope interpretation and forces an echo reading. It appears that the presence of the object ‘rice’ in (i) blocks covert ATB movement.

<sup>10</sup>We do not attempt here a syntactic analysis of *wh*-questions in Ibibio, but the ungrammaticality of (16b) is interesting in light of the availability of partial *wh*-movement in the language. The impossibility of the object *wh*-element stopping and being pronounced in object position of the first conjunct as it transits upwards is most likely an artifact of the type of conjuncts being coordinated (i.e., TPs or vPs, but not CPs).

## 5 Is *nyáŋ* a verb, or something else?

In §2 we argued against analyzing *nyáŋ* as part of an SVC, but this by itself does not preclude *nyáŋ* from being a verb of some kind. Even though *nyáŋ* possesses verb-like qualities, in this section we show that it actually behaves more akin to a low preverbal adverb.

Ibibio adverbs that attach low on the clausal spine commonly appear postverbally in reduplicant form (18a). Some of these adverbs, such as the one translated ‘quickly’ below, alternate between postverbal and preverbal position.

- (18) a. *Ímá á-mà á-fèhé ítòk ù-sóp ù-sóp.*  
 Ima 3SG-PST 3SG-run race NMLZ-do.quickly NMLZ-do.quickly  
 ‘Ima ran the race quickly.’
- b. *Ímá á-mà á-sóp á-fèhé ítòk.*  
 Ima 3SG-PST 3SG-do.quickly 3SG-run race  
 ‘Ima ran the race quickly.’

Postverbal reduplicant adverbs are nominalized, but do not bear subject agreement. When these adverbs appear preverbally, the reverse is true. This is significant for the purposes of the present paper because it potentially identifies intermediate space between  $T^0$  and  $v^0$  where subject agreeing elements can reside.

Also like *nyáŋ*, main verbs, and  $V_1$ s in SVCs, low preverbal adverbs can bear negation.

- (19) *Ímá í-kí-sóp-pó í-fèhé ítòk.*  
 Ima I-PST.FOC.I-do.quickly-NEG I-run race  
 ‘Ima didn’t run the race quickly.’

Given the proposed site of low adverbs like ‘quickly’, presumably they can be the goal of a higher probe that triggers raising-to-Neg, just as a main verb can, and just as *nyáŋ* can.

Unlike main verbs and  $V_1$ s in SVCs—but like *nyáŋ*—low preverbal adverbs cannot be contrastively focused.

- (20) \* *Ímá á-ké á-sòó-sóp á-fèhé ítòk.*  
 Ima 3SG-PST.FOC 3SG-do.quickly-do.quickly 3SG-run race  
 (Intended: ‘Ima QUICKLY ran the race.’)

This restriction comports well with our understanding of where *nyáŋ* is located. Distributionally, then, low adverbs may be significant for two reasons. On the one hand, they offer insight into the nature of *nyáŋ* in terms of category. Second, they provide supporting evidence into the placement of *nyáŋ* structurally. Elements that attach above *vP* are not accessible to low *Foc*<sup>0</sup>. However, *nyáŋ* and low adverbs do display relevant differences. Specifically, *nyáŋ* does not have an alternative postverbal reduplicative form.

- (21) \*...m-fɔp ùnàm ñ-nyáŋ ñ-nyáŋ.  
 1SG-roast meat NMLZ-and NMLZ-and  
 (Intended: ‘...and I roasted meat.’)

*Nyáŋ* therefore successfully negates and *unsuccessfully* undergoes contrastive verb focus, just like a low adverb. But, simply identifying *nyáŋ* as an adverb is potentially suspect, given that it cannot surface postverbally.<sup>11</sup>

*Nyáŋ* and ‘quickly’ can also co-occur preverbally in the same clause, and stack like adverbs do elsewhere.

- (22) a. M-mà á-kót úyò m̀fò ñ-nyáŋ ñ-sóp ñ-dí.  
 1SG-PST 3SG-hear voice your 1SG-and 1SG-do.quickly 1SG-come  
 ‘I heard your voice and came quickly.’  
 b. \* M-mà á-kót úyò m̀fò ñ-sóp ñ-nyáŋ ñ-dí.  
 1SG-PST 3SG-hear voice your 1SG-do.quickly 1SG-and 1SG-come  
 (Intended: ‘I heard your voice and came quickly.’)

Importantly, a rigid ordering ensues when *nyáŋ* and ‘quickly’ appear together: the former must precede the latter, at least linearly.

As suggested previously, we take it that *nyáŋ* attaches low in the clause (below *NegP* and above *vP*), but the differential outcomes of (22a) and (22b) necessitate a bit more precision. One possible way to approach a more specific attachment site is to explore additionally available projections in the inflectional layer, which in Ibibio is rather rich. Baker & Willie (2010) motivate the following expanded architecture.

- (23) MoodP » TP » AspP » *vP* » VP

<sup>11</sup>An anonymous reviewer rightfully notes that the attempt to put *nyáŋ* postverbally may simply be disallowed for independent reasons, such as iconicity. If this is the case, then evidence for the adverb-like nature of *nyáŋ* is even stronger.

Additional layers might prove helpful for syntactic signposting, and, given the location of AspP, it stands out as a likely candidate for helping determine a more precise location for *nyáŋ*.

Though the ordering of *nyáŋ* is fairly predictable on account of its fixed order with respect to low adverbs, it appears to have a bit more flexibility with respect to Asp<sup>0</sup>.

- (24) a. ...ń-mà ń-sé ń-nyáŋ ń-tímmé ń-kèné ń-fóp ùnàm.  
 1SG-PST 1SG-HAB 1SG-and 1SG-repeat 1SG-emulate 1SG-roast meat  
 ‘...and I also again with other folks had been roasting meat.’
- b. ń-kpá ń-ké ń-sé ń-kóót ñwèt (ń-kpá  
 1SG-COND 1SG-PST.FOC 1SG-HAB 1SG-read.PL book 1SG-COND  
 ń-ké) ń-nyáŋ ń-sé ń-brě ñ-brě...  
 1SG-PST.FOC 1SG-and 1SG-HAB 1SG-play NMLZ-play  
 ‘I would have read books and I would have played ...’

Thus, *nyáŋ* can potentially attach above or below AspP, but it must always be below MoodP, TP, and NegP, and above *vP*.

- (25) ...ń-kpé ń-ké í-nyáŋ-ŋ ń-ń-sé ń-brě ñ-brě.  
 1SG-COND 1SG-PST.FOC í-and-NEG 1SG-HAB 1SG-play NMLZ-play  
 ‘...and I wouldn’t have played.’

Taken together, the data from this section shows that *nyáŋ* is both verb-like and adverb-like. Table 2 compares properties of verbs with that of low adverbs and *nyáŋ*.

Table 2: Properties of verbs, low adverbs, and *nyáŋ*.

	S-agreeing	Negatable	Focusable contrastively	Postverbal
Main verbs & V <sub>1</sub> s in SVCs	Y	Y	Y	n/a
Low preverbal adverbs	Y	Y	N	Y
<i>Nyáŋ</i>	Y	Y	N	N

Although the differences are not major, comparing *nyáŋ* with similar elements reveals that it is both verb-like and adverb-like, but bears a stronger affinity to the latter, making it a special type of adverb.

## 6 Conclusion

Reminiscent of Walman “and’-verbs” (Brown & Dryer 2008), *nyáŋ* in Ibibio displays several verb-like characteristics, such as subject agreement, ability to bear negation, and (potentially) being inflected for tense. Recognition of these properties has led to the standard assumption that *nyáŋ* is part of a serial verb construction. In light of recent developments regarding properties of Ibibio serial verbs, though, we find that *nyáŋ* effectively fails to meet all criteria for seriality. Distributional evidence similarly showed an affinity between *nyáŋ* and low adverbs. Nevertheless, just as *nyáŋ* is verb-like in degrees, we likewise find only partial correspondences with adverbs.

In our approach to *nyáŋ* we largely focused on delineating what *nyáŋ* is not, refraining from strong positive statements about what *nyáŋ* actually is. Still, current evidence weighs in favor of *nyáŋ* being an adverb of a special type. Moreover, the data reveal some promising directions that may shed light on the precise nature of *nyáŋ* and *nyáŋ* clauses. First, these clauses are island-inducing, which supports the claim that *nyáŋ* truly participates in coordination. Perhaps most surprisingly, though, our presentation casts doubt on the notion that *nyáŋ* is itself a coordinator. Together, we take these observations as possible evidence for covert coordination in the language. If this is on the right track then *nyáŋ* operates as an associate of covert conjunction.

## Abbreviations

Abbreviations follow the 2015 Leipzig Glossing Rules, with one addendum: ɪ = default agreement marker /i/, following Baker & Willie (2010).

## Acknowledgements

Many people have offered great help and insightful comments throughout our work on this project. We would like to thank Harold Torrence, Jason Kandybowicz, Ibrahima Ba, Longcan Huang, Lydia Newkirk, Zhuo Chen, Masashi Harada, audience members of ACAL 47, and two anonymous reviewers. All remaining errors are our own.

## References

- Akinlabi, Akinbiyi & Eno E. Urua. 2003. Foot structure in the Ibibio verb. *Journal of African Languages and Linguistics* 24(2). 119–160.
- Baker, Mark C. 1989. Object sharing and projection in serial verb constructions. *Linguistic inquiry* 20(4). 513–553.
- Baker, Mark & Willie Udo Willie. 2010. Agreement in Ibibio: From every head to every head. *Syntax* 13(2). 99–132.
- Brown, Lea & Matthew S. Dryer. 2008. The verbs for ‘and’ in Walman, a Torricelli language of Papua New Guinea. *Language* 84(3). 528–565.
- Collins, Chris. 1997. Argument sharing in serial verb constructions. *Linguistic inquiry* 28. 461–497.
- Creissels, Denis. 2000. Typology. In Bernd Heine & Derek Nurse (eds.), *African languages: An introduction*, 231–58. Cambridge: Cambridge University Press.
- Duncan, Philip T. 2016. Parallel chain formation in Ibibio contrastive verb focus. In Emily Clem, Virginia Dawson, Alice Shen, Amalia Horan Skilton, Geoff Bacon, Andrew Cheng & Erik Hans Meier (eds.), *Proceedings of the 42nd Annual Meeting of the Berkeley Linguistics Society*, 87–106. Berkeley, CA: Berkeley Linguistics Society.
- Duncan, Philip T., Travis Major & Mfon Udoinyang. 2018. Searching high and low for focus in Ibibio. In *African Linguistics on the Prairie: Selected Papers from the 45th Annual Conference on African Linguistics*, 269–288.
- Essien, Okon E. 1985. Negation in Ibibio: A syntactic-phonological process. *Journal of West African Languages* 15(1). 73–92.
- Essien, Okon E. 1990. *A grammar of the Ibibio language*. Ibadan: University Press Limited.
- Goldie, Hugh. 1857. *Principles of Efik grammar*. Old Calabar: Mission Press.
- Hiraiwa, Ken & Adams Bodomo. 2008. Object-sharing as symmetric sharing: Evidence from Dàgáárè. In *Proceedings of the 26th West Coast Conference on Formal Linguistics*, 243–251.
- Johanessen, Janne Bondi. 1998. *Coordination*. Oxford: Oxford University Press.
- Kayne, Richard. 1994. *The antisymmetry of syntax*. Cambridge: MIT Press.
- Major, Travis. 2015. Serial verbs in Ibibio. *Kansas Working Papers in Linguistics* 35. 129–148.
- Munn, Alan. 1987. Coordinate structure and X-bar theory. *McGill Working Papers in Linguistics* 4. 121–140.



- Munn, Alan. 1993. *Topics in the syntax and semantics of coordinate structures*. University of Maryland. (Doctoral dissertation).
- Munn, Alan. 1999. First conjunct agreement: Against a clausal analysis. *Linguistic Inquiry* 30(4). 643–668.
- Olawsky, Knut J. 1999. *Aspects of Dagbani grammar: With special emphasis on phonology and morphology*. Munich: Lincom Europa.
- Ross, John Robert. 1967. *Constraints on Variables in Syntax*. Massachusetts Institute of Technology. (Doctoral dissertation).
- Watters, John R. 2000. Syntax. In Bernd Heine & Derek Nurse (eds.), *African languages: An introduction*, 194–230. Cambridge: Cambridge University Press.
- Welmers, William Everett. 1968. *Efik*. Vol. 11. Ibadan: Institute of African Studies, University of Ibadan.
- Welmers, William Everett. 1973. *African language structures*. Berkeley: University of California Press.
- Zeller, Jochen. 2015. The syntax of African languages. <http://www.jzeller.de/manus.html>, accessed 2015-5-8.



## Chapter 23

# On the derivation of Swahili *amba* relative clauses: Evidence for movement

Isaac Gould

Ewha Womans University

Tessa Scott

University of California, Berkeley

This paper brings together two disparate strands of research in the literature on relative clauses (RCs) in Swahili. Our focus is to provide a unified analysis of various data involving a particular kind of head-external RC, namely *amba*-RCs. Our interest is in whether these RCs involve movement of the head from inside the RC to its external position (i.e. head raising). To investigate this, we look at scope interactions between a quantified RC-head and some other quantifier. We propose a diagnostic test using constraints on long-distance QR (LDQR) from Fox (2000) to provide evidence for the following claims: *amba*-RCs involve head raising, and *amba*-RCs are not islands for overt syntactic movement.

## 1 Introduction

In this paper we discuss a previously undiscussed puzzle that emerges from the literature on the derivation of relative clauses (RCs) in Swahili. Two conflicting analyses have been proposed: one that involves syntactic movement of the RC-head (i.e. head raising) and one that does not. On the one hand, there is Nkonyani's (2001; 2006) movement analysis, which is largely based on inverse scope data involving pronoun binding or multiple quantifiers. On the other hand, there is Barrett-Keach's (1985) and Keach's (2004) non-movement analysis, which is based primarily on data related to relative clause islands. The apparent incompatibility of these two arguments necessitates a more detailed view of the data



with the aim of developing a uniform analysis of all the data. Our focus in this paper is to do so with a particular kind of relative clause in Swahili, namely *amba* relative clauses, which are RCs that contain the relativizing morpheme *amba*.

In this paper, we propose such a uniform analysis of *amba*-RCs that relies on syntactic movement. In addition to confirming grammaticality judgments for some of the data from the literature, we conducted a more careful investigation of the inverse scope interpretation of quantifiers in multiply-embedded *amba*-RCs, which are putatively islands for movement. As we discuss, the kind of inverse scope we consider in *amba*-RCs could be tied to either movement of a quantificational RC-head or to long-distance Quantifier Raising (QR) of some other quantifier out of an RC, in which case the RC-head need not move. We then consider when general constraints on QR would and would not allow for long-distance QR out of an RC to be licensed. In part by controlling for when QR should not be possible, we are led to expect that the relevant inverse scope interpretation will be possible if there is movement of the relative's head, but impossible if relativization does not involve movement of the head. As the data we present indicate that inverse scope is indeed possible, we conclude (a) that *amba*-RCs involve movement of the relative's head, and (b) that *amba*-RCs are not islands for overt movement. Possible supporting evidence, which we discuss, comes from looking at another long-distance dependency that is also possible across *amba* relative clause boundaries.

In using constraints on QR to establish an argument as to whether a movement dependency exists elsewhere in the syntactic structure, we are inspired by Fox (2000) with regard to both the constraints themselves, and how they are used to establish an argument for or against movement. Our focus is somewhat different from Fox's, though, in that we use constraints on long-distance QR out of an RC to test for whether that RC's head has undergone movement for relativization purposes. As far as we know, this is a novel attempt at (a) considering when long-distance QR out of an RC would be licensed, as well as (b) using such QR as part of a test for whether the RC-head undergoes movement.

On a more general level, this paper can be seen as an experiment in rigorously investigating one particular kind of evidence with an eye toward reconciling other, potentially disparate strands of evidence. To the extent that this experiment succeeds, our hope is that it can serve as a kind of blueprint for investigating additional phenomena involving displacement that at first glance suggest multiple contrasting analyses.

The judgments we report in this paper (some of which confirm earlier judgments from the literature) represent a unified, speaker-internal set of data from a

Kenyan speaker of the standard Kenya-Tanzania variety of Swahili. Our hope is that these judgments can be replicated in future work with further speakers. The data were gathered via elicitation sessions using constructed examples. The set of examples provided in §2 and §3 is based on existing examples from the literature, whereas the set of examples in §4 and §5 was constructed for the purpose of this paper. As indicated above, data involving quantifier scope are of particular importance for the argument being developed in this paper. For each quantifier scope relation between two quantifiers that we tested, the following procedure was used. The speaker was presented with some illustration and was instructed on what was being depicted in that illustration. The illustration depicted a scenario that would be true under one scope relation between two quantifiers for some Swahili sentence (which had not been presented to the speaker), but false under the other scope relation. The speaker was then presented with the relevant Swahili example and asked to evaluate the well-formedness of such an example given the scenario depicted in the illustration. These evaluations are what we report with scope judgments in the relevant examples.

The structure of this paper is as follows. In §2 we introduce the form of *amba*-RCs. §3 briefly reviews two existing analyses of *amba*-RCs and some of the core data that have been discussed in support of these analyses. We then propose a test in §4.1 that can help us adjudicate between these analyses, and §4.2 provides an illustration of this test and some discussion of its implications. §5 contains an additional data point from a further long-distance dependency that is consistent with our proposal, and §6 concludes the paper.

## 2 The form of *amba* relatives

Swahili has a number of different types of relative clause constructions (cf. Ngonyani 2001), but in this paper we restrict our attention to what we call *amba* relatives. These are relative clauses that contain the relativizing morpheme *amba*, as illustrated in (1).

- (1) Ni-li-nunu-a      vi-tabu amba-vyo Juma a-li-vi-som-a.  
 1<sup>ST</sup>.SG-PST-buy-FV 8-book amba-8AGR Juma 1S-PST-8O-read-FV  
 ‘I bought the books that Juma read.’

(1) shows that these are head-external RCs, with the head (here *vi-tabu* ‘books’) preceding first *amba*, then an agreement marker ending in *-o* or *-e* (which we gloss as AGR), and then the relative clause proper. We use the term agreement

marker here descriptively, simply to indicate that its morphology corresponds with the noun class of the head of the relative.<sup>1</sup> In examples throughout, we will indicate the head of an *amba*-RC in boldface.

Other relative clause constructions in Swahili have different forms and do not contain the morpheme *amba*. In some research, such as Ngonyani (2001; 2006), both *amba*-RCs and non-*amba*-RCs are used interchangeably in constructing a theoretical analysis and are given the same analytical treatment. However, we believe this approach introduces a potential confound, as it has been proposed (e.g. Barrett-Keach 1985) that the different types of Swahili relatives involve different syntactic structures. To avoid this potential confound, each type of RC can be investigated systematically and independently of the other RC types. This is the approach we take here by focusing on *amba*-RCs; future research can look at extending this approach to the other RC types in Swahili.

### 3 The puzzle of previous approaches

In this section we review two competing analyses of *amba*-RCs, one with and one without syntactic movement of the RC-head. The disparity of these analyses leaves us with a puzzle as to how to analytically approach these relatives. It should be noted, though, that the different analyses are not based on the same core set of data. In this paper, we address this shortcoming by investigating a more comprehensive data set, which we then use as the foundation for our analysis of *amba*-RCs.

We begin with Barrett-Keach's (1985) and Keach's (2004) non-movement analysis. As regards an implementation of such a non-movement approach, we will follow Keach (2004) in our discussion here, but the approach in Barrett-Keach (1985) is highly parallel. A schematic structure for the head-external relative in (1) is given in (2), which is based on Keach (2004: 126). Keach treats the agreement marker suffixed to *amba* as a relative pronoun, which we represent here as AGR. For Keach, this relative pronoun is co-indexed with a null pronoun (*pro*) in the gap position and also, presumably, the external head (e.g. 'books' in (1)):

---

<sup>1</sup>There are various analytical possibilities for what this agreement marker might be. For instance, it could be the reflex of agreement between some syntactic head (perhaps C) and the head of the relative, or it could be, as Henderson (2006) suggests, a resumptive pronoun. As far as we can tell, either of these analyses is in principle a viable one, and both are compatible with the overall discussion in this paper (see also note 4). Yet another possibility, which we do not consider any further is Keach's (2004) own claim, which we discuss in the following section, that it is a relative pronoun.

- (2) Non-movement analysis of *amba*-RCs (cf. Keach 2004)  
 Head<sub>i</sub> [ *amba*-AGR<sub>i</sub> [ ... *pro*<sub>i</sub> ... ] ]

Note that the long-distance dependency in (2) is established via co-indexation and by binding of *pro* by the relative pronoun. Whether the agreement marker should be treated as a relative pronoun or as simply being the realization of phi-feature agreement is not crucial to our concerns here (which have to do with the presence or absence of movement), and we will thus abstract away from this point. However, we believe that a more semantically transparent representation of (2) involves something along the lines of inserting an appropriately co-indexed null operator at the edge of the embedded clause. In line with this, we will not treat the agreement marker as denoting an individual, and in fact will treat the entire *amba*+AGR complex as a formative of RCs that is semantically vacuous (cf. the treatment found in Heim & Kratzer (1998) for the complementizer *that* of English relative clauses).<sup>2</sup>

Crucially, according to the analysis in (2) or any such similar analysis (including Barrett-Keach 1985), the external head 'books' is not extracted via movement from the gap position within the relative; instead, this analysis proposes that the head is base-generated in its external position outside of the relative. Indeed, relativization according to this kind of analysis does not involve any movement at all (such as, for example, null operator movement).

Barrett-Keach/Keach's primary evidence to support (2) comes from the absence of relative clause island effects.<sup>3</sup> We can see this, for instance, with grammatical examples that involve relativizing two elements from an *amba*-RC. We will call these constructions doubly-embedded RCs, as they involve embedding one *amba*-RC inside of another. Further, in examples of what we call doubly-embedded RCs, the sites of the gaps for the two relativized elements occur within the most deeply embedded *amba*-RC. We will use the notation *e* and co-indexation as a neutral way of representing the site of the gaps and the relationship

<sup>2</sup>And should AGR turn out to be a resumptive pronoun (which is interpreted as a variable ranging over individuals) under the movement analysis that we consider later in this section, this will not affect the discussion in §4 of Quantifier Raising with regard to violations of scope economy.

<sup>3</sup>Keach (2004) offers, in passing, another type of data as evidence against movement, but given Keach's limited discussion it is not currently clear to us that the data indeed provide a strong argument against movement. Keach observes that parasitic gaps do not appear to be licensed by *amba*-RCs. We have not been able to thoroughly investigate this construction, but we note that the conditions on parasitic gaps (e.g. the structural position of the parasitic gap and the non-parasitic gap with respect to each other) might independently not be met in *amba*-RCs even if they do involve movement.

between these gaps and the relativized elements. We were able to confirm Barrett-Keach's basic observations by constructing the doubly-embedded *amba*-RCs in (3) and (4); these examples were judged grammatical. (3) illustrates this with nested filler-gap dependencies, whereas (4) does so with crossing ones. In (3) and (4) we can call *ki-tabu* 'book' and *m-tu* 'person' the highest RC head, as they are the heads of the superordinate *amba*-RCs.

- (3) Doubly-embedded *amba*-RC: nested dependency

Nick a-li-ki-nunu-a **ki-tabu<sub>j</sub>** amba-cho ni-li-wa-on-a **wa-toto<sub>i</sub>**  
 Nick 1s-PST-7O-buy-FV 7-book<sub>j</sub> amba-7AGR 1<sup>ST</sup>.SG-PST-2O-see-FV 2-child<sub>i</sub>  
 amba-o [ e<sub>i</sub> wa-li-ki-som-a e<sub>j</sub> ].  
 amba-2AGR [ e<sub>i</sub> 2s-PST-7O-read-FV e<sub>j</sub> ]

'Nick bought the book that I saw the children who read (it).'

- (4) Doubly-embedded *amba*-RC: crossing dependency

Ni-li-mw-it-a **m-tu<sub>i</sub>** amba-ye u-li-wa-on-a **wa-toto<sub>j</sub>**  
 1<sup>ST</sup>.SG-PST-1O-call-FV 1-person<sub>i</sub> amba-1AGR 2<sup>ND</sup>.SG-PST-2O-see-FV 2-child<sub>j</sub>  
 amba-o [ e<sub>i</sub> a-na-wa-pend-a e<sub>j</sub> ].  
 amba-2AGR [ e<sub>i</sub> 1s-PRS-2O-like-FV e<sub>j</sub> ]

'I called the person who you saw the children who (he) likes (them).'

Barrett-Keach/Keach's argument is that if examples like (3) and (4) involved syntactic movement, then they should be ungrammatical, as they would incur a subjacency violation. As no island effect occurs, Barrett-Keach/Keach's conclusion is that these RCs must be derived without movement. As already mentioned, the non-movement derivation Keach proposes is given in (2) above. Note that Barrett-Keach/Keach's argument crucially hinges on the assumption that doubly-embedded RCs should be islands to movement. RCs can indeed be islands in languages such as English, however in §4 we dispute the claim that *amba*-RCs are necessarily islands in Swahili.

Next, we consider the movement analysis of Ngonyani (2001; 2006). In contrast to Barrett-Keach/Keach, Ngonyani proposes a head raising analysis (cf. Kayne 1994). According to this analysis, the head of the relative (again, 'books' in (1)) moves from the gap position to its relative clause-external position. This is shown schematically in (5), where we assume movement dependencies are instantiated by copies in a copy-chain (Chomsky 1995); we use a strikethrough to indicate the positions of unpronounced copies. (5) illustrates this dependency by representing



simply two (of a potentially larger number of) copies of the dependency: the pronounced external head and the lowest copy of the head in the gap position.<sup>4</sup>

- (5) Movement analysis of *amba*-RCs (cf. Ngonyani 2006)

Head<sub>i</sub> [ *amba*-AGR<sub>i</sub> [ ... Head<sub>i</sub> ... ] ]

Ngonyani's core evidence for movement comes from the possibility of inverse scope involving (a) scope relations between multiple quantifiers and (b) binding data. First, the example in (6) is based on Ngonyani (2001: 66) – but note that Ngonyani's actual example involves a type of RC that is not an *amba*-RC – and supports Ngonyani's basic finding regarding inverse scope of quantifiers. In (6), the external head contains the numeral *-wili* 'two', and the relative contains the universal quantifier *kila* 'each'. Nevertheless, inverse scope is possible: the embedded universal can take scope over the numeral, resulting in a distributed reading.

- (6) Inverse scope with two quantifiers possible: ✓  $\forall > 2$

Ni-li-wa-it-a [ wa-le wa-gonjwa wa-wili ]<sub>i</sub> amba-o [ kila  
1<sup>ST</sup>.SG-PST-2O-call-FV [ 2-DEM 2-patient 2-two ]<sub>i</sub> amba-2AGR [ each  
daktari a-ta-wa-pim-a e<sub>i</sub> ].  
doctor 1S-FUT-2O-examine-FV e<sub>i</sub> ]

'I called those two patients that each doctor will treat.'

Second, (7) repeats Ngonyani's (2001: 65) example and replicates Ngonyani's judgment that the possessive pronoun *-ake* in the external head can be bound by the universal *kila* 'each' in the relative, again resulting in a distributed reading.

- (7) Inverse binding of pronouns possible

[ Ki-tabu ch-ake<sub>i</sub> ch-a kwanza ]<sub>j</sub> amba-cho [ [ kila mw-andishi ]<sub>i</sub>  
[ 7-book 7-3<sup>RD</sup>.SG.POSS<sub>i</sub> 7-of first ]<sub>j</sub> amba-7AGR [ [ every 1-writer ]<sub>i</sub>  
hu-ji-vun-i-a e<sub>j</sub> ] hu-w-a ki-zuri sana.  
HAB-REFL-be.proud-APPL-FV e<sub>j</sub> ] HAB-be-FV 7-good very

'His first book that every writer is proud of is very good.'

<sup>4</sup>We note that the possibility of analyzing *amba*-RCs as involving resumptive pronouns, which was mentioned in note 1, does not preclude the possibility of their being derived via raising of the RC-head. Support for this view comes from work such as Aoun & Li (2003), which illustrates that movement of a particular constituent is still possible with a resumptive pronoun corresponding to that constituent.

The thrust of Ngonyani's argument is as follows. In order for the readings in (6) and (7) to be possible, we assume that the position where the universal quantifier is interpreted must be in a structurally higher position than the position where the RC-head is interpreted (cf. Heim & Kratzer 1998). Assuming that the universal is interpreted in the RC (but see §4 for an alternative view), then it follows that the head is also interpreted in a lower position internal to the RC. A movement dependency with multiple copies of the head can capture this: in (6) and (7) the higher copy of the head is *pronounced* external to the relative, whereas the quantificational/pronominal material of the head is *interpreted* in a lower copy internal to the relative (and structurally lower than the embedded universal). Note that under a non-movement approach, these interpretive facts are not accounted for with the analysis in (2) by itself (cf. §4 for further discussion of this point). Given (2) alone, the quantificational force of relative's head in (6) would be interpreted outside the RC in a position that is structurally higher than the embedded universal. Further, the pronominal variable of the relative's head in (7) would also be interpreted outside the RC in the same high structural position.<sup>5</sup>

Given the contrasting analyses by Barrett-Keach/Keach and Ngonyani, we are now faced with the following puzzle. How can we make sense of the interpretive facts in (6) and (7), which suggest that the head originates within the RC, while at the same time allowing for relativization of heads from doubly-embedded RCs? The interpretations put forward in the literature of the kinds of data presented above have so far pulled us in two different directions. On the one hand, it has been assumed that *amba*-RCs are syntactic islands, which pushes us away from a movement analysis. On the other hand, the interpretive facts have pushed us toward a movement dependency between the external head and the gap position.

In this paper, we attempt to resolve this tension by investigating a more comprehensive set of data, as well as a more refined set of analytical hypotheses.

---

<sup>5</sup>Ngonyani (2001) considers two other phenomena as evidence for a head raising analysis. The first involves connectivity effects with idioms: certain phrasal idioms in Swahili allow for an idiomatic interpretation when part of the idiom is relativized as the RC-head, with the remainder of the idiom occurring inside the relative. However, we are not aware of any theory of semantics that would preclude an idiomatic interpretation given the non-movement analysis in (2). Second, Ngonyani observes that the agreement marker following *amba* must agree with the head of the relative. Again, it is not clear to us that a theory of agreement a priori prevents such agreement from occurring given the analysis in (2). Consequently, we do not think these phenomena present compelling arguments for or against movement, and we will not consider them further.

Crucially, neither Barrett-Keach/Keach nor Ngonyani considers the same set of core data. Thus Barrett-Keach/Keach does not consider the interpretative facts in (6) and (7), and Ngonyani does not look at doubly-embedded RCs. So far, we have gone beyond the existing literature by presenting a speaker-internal set of judgments involving both types of data. But we will go further. A natural next step would be to consider the interpretive possibilities of doubly-embedded RCs, i.e. a synthesis of the phenomena in (3–4 and (6–7)). This is essentially how in §4 we approach the tension mentioned above, although the discussion will be limited to considering inverse scope involving multiple quantifiers (and not pronominal binding), and as mentioned in the following section, our general approach is not specific to doubly-embedded RCs. By presenting novel data, we will show that the balance of evidence is in favor of a movement approach to *amba*-RCs. We will give a uniform analysis that accounts for all the data we have seen so far. A consequence of this analysis is that it will force us to reject the assumption that *amba*-RCs are islands for overt movement in Swahili. This is perhaps a desirable outcome, as it dovetails with a further long-distance dependency fact in the language, as we show in §5.

## 4 A closer look at inverse scope

### 4.1 Introducing the hypotheses

As a way of better understanding *amba*-RCs, in §4 we take a closer look at inverse scope data such as (6) and their relation to doubly-embedded constructions such as in (3) and (4). In particular, we investigate whether inverse scope is possible with doubly-embedded RCs. That is, we test to see whether, when there are doubly-embedded RCs, a quantifier pronounced inside one of the RCs can take inverse scope over the highest RC head. The initial motivation behind looking more carefully at doubly-embedded RCs is to see whether this inverse scope, which we associated with a movement analysis of the RC-head in previous section, is also found with doubly-embedded RCs, which are putatively islands for movement. If such inverse scope is possible, then we might conclude that there is always movement in *amba*-RCs, and that these RCs are not in fact islands for movement. However, as we discuss, we will need to be careful in constructing examples of this sort, in order to control for another potential way in which inverse scope could be derived (i.e. one with Quantifier Raising, but without movement of the RC-head). Ultimately, the test that we end up with is not specific to doubly-embedded RCs, although we find that the relevant examples with these RCs pro-

vide an especially clear way of seeing both (a) that inverse scope is possible, and (b) an argument in favor of *amba*-RCs involving movement of the head.<sup>6</sup> Consequently, we will focus on these examples of doubly-embedded RCs, and will frame the discussion below around them. To understand this argument and thus the significance of these novel data, we first present a set of hypotheses regarding *amba*-RCs in §4.1, before presenting our core data and testing these hypotheses in §4.2.

Our discussion and the hypotheses we introduce here hinge on the question of whether *amba*-RCs are in fact islands for overt movement. As we discuss below, this question bears directly on the issue of analyzing *amba*-RCs as involving raising of the head. Our goal is not to strictly falsify one of these hypotheses, but to use these hypotheses as a jumping off point for (a) the question of a movement/non-movement analysis of the derivation of *amba*-RCs, and (b) an account of all the data we have seen so far. The hypotheses we introduce refer to overt movement, by which we mean movement that must occur before Spell-Out (and thus not at LF) and that feeds PF in that a higher copy of the movement dependency is pronounced (cf. Chomsky 1995). Ngonyani's analysis of RCs would thus be an example of overt movement, as the highest copy of the head is pronounced at PF. We contrast this with Quantifier Raising, or QR, (cf. May 1977; 1985), which may be covert in that it occurs only at LF and has no detectable effects on PF.

The two core hypotheses we investigate are given in (8).<sup>7</sup> Note that in the discussion below we will follow the null hypothesis in assuming that all *amba*-RCs are derived uniformly, i.e. either uniformly via non-movement, as in (2), or uniformly via movement, as in (5).

- (8) a. Hypothesis 1 (H1): *amba*-RCs are not islands for overt movement.  
b. Hypothesis 2 (H2): *amba*-RCs are islands for overt movement.

We now consider the implications of these two hypotheses, starting with H2. To begin with, we can observe that doubly-embedded RCs play an important role in helping to see the relation between the hypotheses in (8) and whether there is head raising in the relatives. According to H2, doubly-embedded RCs as in ((3)-(4)) can only be possible by base-generating the highest RC-head outside its RC

---

<sup>6</sup>Strictly speaking, then, the test we consider and the argument we propose could be reconstructed using examples of non-doubly-embedded *amba*-RCs, similar to the one in (6). However, we find that the doubly-embedded RCs provide a straightforward and clear way of illustrating both the test and argument.

<sup>7</sup>To be precise, within the context of the hypotheses in (8), by “*amba*-RC” we mean the constituent formed by the RC-head and the RC (including *amba*+AGR).

as in the non-movement analysis in (2). As the embedded *amba*-RC, once built, would constitute an island, it would not be possible to overtly extract another RC-head from within it via head raising. Thus, if we follow H2, then the movement analysis cannot be adopted for *amba*-RCs.

A further consequence of following H2 regards interpretation. As the highest RC-head must be generated outside its RC, this highest RC head cannot be interpreted inside an *amba*-RC for purposes of inverse scope. This does not mean, however, that H2 predicts that there cannot be inverse scope. Inverse scope could be possible on the assumption that covert movement is possible out of the relative. In doubly-embedded RCs, for example, it could be the case that QR of a universal quantifier from an *amba*-RC is possible, thereby allowing the universal to take scope over the highest RC head. This kind of QR is also in principle possible to derive inverse scope in (6–7).<sup>8</sup> This analysis is along the lines of what Hulsey & Sauerland (2006) propose for QR out of RCs in English. We go beyond Hulsey and Sauerland, though, by embedding this proposal in some more general theory, namely Fox's (2000) theory of QR. In §4.2 we adopt Fox's approach in investigating what conditions might allow this kind of non-clause-bounded, or long-distance, QR to be possible. Fox suggests that QR can sometimes be possible out of embedded clauses (although he does not consider relative clauses) if these conditions are met.

Crucially, when we conduct the test for inverse scope mentioned at the beginning of this section, we will do so in doubly-embedded RCs in which these conditions on long-distance QR are *not* met. Under the assumption that these conditions are operational in Swahili, if inverse scope is still possible when these conditions are not met, then everything else being equal, we have evidence against H2. In other words, if we find that inverse scope is possible in an environment where under a non-movement analysis we would not expect it to be possible (because by hypothesis the relevant QR is not possible), then we have evidence against H2 and a non-movement analysis. (This raises the question of how such inverse scope might be possible, a question that we take up below in considering a movement analysis of the relatives under H1.) But if it turns out that such inverse scope is impossible, then we have evidence in support of H2 and a non-movement analysis. This is because such inverse scope is expected to be impossible under a non-movement approach, as the relevant conditions on QR are not met.

---

<sup>8</sup>This QR analysis assumes that Weak Crossover Effects would not obtain for pronoun binding in (7). Further research can investigate whether such effects exist more broadly in Swahili.

We now consider H1. Under H1, with everything else being equal, a movement analysis as in (5) should be in principle possible for all *amba*-RCs, and such an analysis can account for all our data. First, multiple cases of relativization as in the doubly-embedded RCs in (3–4) are expected to be grammatical because *amba*-RCs, not being islands for overt movement, will not block this kind of overt extraction. Second, the inverse scope facts of (6–7) can also be accounted for with a full lower copy of the RC-head being interpreted inside the RC. Third, we also expect inverse scope to be possible in cases of doubly-embedded RCs because a full lower copy of an extracted head can in principle be interpreted in the most deeply embedded RC. (In <sup>9</sup>, we mention a slight qualification of the expectation that a full lower copy in a copy-chain can be interpreted, but for the discussion at hand, the general expectation that a full lower copy can be interpreted is sufficient.) As mentioned above, in the following section we will test for inverse scope with doubly-embedded RCs. Recall we proposed that under H2, QR is necessary to account for inverse scope, and that there must be a non-movement analysis of *amba*-RCs under H2. Similarly, for a non-movement analysis under H1, QR is necessary to account for inverse scope. As the RCs we test will be doubly-embedded RCs that are not expected to allow inverse scope via QR, we do not expect inverse scope with a non-movement analysis under H1. In contrast we expect such inverse scope to be generally possible with doubly-embedded RCs given H1 and the possibility of interpreting full lower copies under a movement analysis. Thus if we find that such inverse scope is indeed possible, then we have support for H1 and a movement analysis of *amba*-RCs. But if such inverse scope turns out to not be possible with doubly-embedded RCs, then everything else being equal, we (a) have a reason to reject a movement analysis under H1, and (b) have evidence in support of a non-movement analysis under H1.

In sum, we want to construct examples of doubly-embedded *amba*-RCs in which we expect long-distance QR to be impossible given the conditions in Fox (2000). If inverse scope is possible, then we have support *for* H1 and a movement analysis (because QR is not relevant, with inverse scope being possible via interpreting a full lower copy of the moved RC-head), and *against* H2 and a non-movement analysis, which relies on QR being possible. In contrast, if inverse scope is impossible, then we have support *for* a non-movement analysis under either H1 or H2, and *against* H1 and a movement analysis. Thus, testing for inverse scope becomes a way of testing for raising or base-generating the head in *amba*-RCs. Again, our goal is ultimately not to decide between H1 and H2, but

to use these hypotheses as a tool for identifying head raising and accounting for our data set. Anticipating the discussion below, though, we will see evidence for head raising, and thus evidence for H1 and against H2.

Methodologically, our approach here builds on that in Fox (2000), which also uses the absence/presence of some QR dependencies as part of a test for diagnosing other QR dependencies. We broaden the empirical focus of this approach with the aim of implicating the potential of QR out of an RC in a test for whether the RC-head has itself moved out of the RC. Again, we are not aware of any previous literature that has applied this treatment to long-distance QR out of RCs.

In §4.2, we review the conditions on QR given the discussion in Fox (2000), and then test our hypotheses with the relevant examples of doubly-embedded RCs.

## 4.2 Testing the hypotheses

In this section we consider novel data from Swahili in order to implement the test mentioned in the previous section, which involves inverse scope in doubly-embedded RCs. Recall that the test involves seeing whether inverse scope is possible in a structure where we do not expect long-distance QR (LDQR) to be possible as per Fox (2000). Such a test can be used to argue for or against a movement analysis of *amba*-RCs, and we will see in this section that our test pushes us toward adopting the analysis in (5), namely that there is head raising in all *amba*-RCs. Before presenting the test results, we begin with a review of the conditions in Fox (2000) under which LDQR is possible. Again, we are interested in testing examples in which LDQR should not be possible, as the non-movement analysis of inverse scope would crucially rely on this kind of QR. Reviewing these conditions is thus crucial for laying the groundwork for and understanding the test itself. Then after discussing the test results, we consider and reject an alternative analysis of the results, according to which Swahili simply does not follow all the constraints on LDQR.

A second constraint on QR is a locality constraint. Fox (2000: 23, 63) suggests that each iteration of QR of a quantified expression Q must adjoin Q to the closest clause-denoting constituent that dominates Q before QR. We understand a clause-denoting constituent to be a closed proposition that is a maximal projection (i.e. a projection that is maximal in all regards other than the adjunction involved in QR). An example of such a clause-denoting constituent that could be

adjoined to would be the maximal projection of TP, which is a saturated predicate before adjunction.<sup>9</sup>

Let us now consider schematically in (9) what QR from a relative clause would look like and how it could satisfy these constraints. In (9), the RC-head is  $Q_1$ , which corresponds to the gap in the object position of the relative. Next,  $Q_2$  in (9) is the subject inside the RC.  $Q_2$  then undergoes QR (indicated by a strikethrough) to adjoin to a clause-denoting constituent outside the relative that is structurally higher than the RC-head  $Q_1$ .

- (9) Proposal for Quantifier Raising from an *amba*-RC: ✓  $Q_2 > Q_1$   
 $Q_2\text{-Subj}$  [  $Q_1\text{-Obj}$  *amba*-AGR [  ~~$Q_2\text{-Subj}$~~  ...  $e_{\text{Obj}}$  ] ]

This QR will be licensed as follows. First, the new scope relation  $Q_2 > Q_1$  must establish a new meaning (scope economy). Second, there must be no clause-denoting maximal projection between the position  $Q_2$  undergoes QR from and the position of the RC-head (locality). This locality constraint can be satisfied if we assume subjects in Swahili occupy a high structural position within the clause, say at the TP level (cf. Ngonyani 2006), such that no clause-denoting intervening maximal projection of this sort occurs between the embedded subject and the RC-head. We will indeed assume that a configuration such as (9) licenses LDQR in Swahili as per the discussion in Fox (2000).<sup>10</sup>

Note that the configuration in (9) is precisely the sort of analysis that would allow for inverse scope in (6), which involves a single *amba*-RC.

In our test related to our hypotheses in (8), though, we will consider the possibility of inverse scope in examples that involve two manipulations to the schema in (9). First, we will have  $Q_1$  in (9) be the highest RC-head of a doubly-embedded RC construction. As discussed in §4.1, under a non-movement analysis, turning (9) into a doubly-embedded RC construction would force  $Q_2$  in (9), if it is merged in the most deeply embedded RC, to undergo QR in order to take scope over

<sup>9</sup>A related point is whether scope economy and the locality constraint apply to interpreting a full lower copy of movement. Based on Fox (2000: p. 23; n. 6, p. 23), we can say that scope economy does apply, but that the locality constraint does not. Thus semantic equivalence must not hold between the relevant scope relations with regard to interpreting a higher copy in a copy-chain or a full lower copy in that copy-chain. This lack of semantic equivalence is found in all the examples in this paper where we propose a full lower copy is interpreted. So long as scope economy holds, though, a full lower copy can be interpreted without regard to what kinds of projections intervene between the higher and lower copies of a copy-chain.

<sup>10</sup>Recall that we assume *amba*+AGR is semantically vacuous, in which case the CP of the RC is simply an open proposition (cf. Heim & Kratzer 1998). Consequently, the CP level of the RC is not an intervening clause-denoting constituent.



Q<sub>1</sub>. Second, we will manipulate (9) such that QR of Q<sub>2</sub> would be possible only by violating the locality constraint. This manipulation is an attempt to eliminate base generation of the RC-head as a possible analysis. If inverse scope is still possible, but if locality is violated, then we have reason to think that LDQR is not taking place. Our conclusion, then, would be in favor of H1 and a movement analysis, according to which inverse scope is possible by raising the RC-head and interpreting a full lower copy of that head.

The crucial data are given in (10), which contain doubly-embedded *amba*-RCs (but see note 12 below for a potential complication with (10b)). We see that the embedded universal can take scope over the numeral in the RC-head, resulting in a distributed reading.

(10) Inverse scope possible in doubly-embedded *amba*-RC: ✓  $\forall > 2$

- a. Ni-li-wa-it-a [ wa-gonjwa wa-wili ]<sub>j</sub> amba-o duka la  
 1<sup>ST</sup>.SG-PST-2O-call-FV [ 2-patient 2-two ]<sub>j</sub> amba-2AGR store of  
 dawa hi-li li-li-m-p-a vi-donge [ kila daktari ]<sub>i</sub>  
 medicine DEM-5 5-PST-1IO-give-FV 8-pill [ every doctor ]<sub>i</sub>  
 amba-ye [ e<sub>i</sub> a-li-wa-pim-a e<sub>j</sub> ].  
 amba-1AGR [ e<sub>i</sub> 1S-PST-2O-examine-FV e<sub>j</sub> ]

‘I called the two patients that this pharmacy gave pills to every doctor that treated (them).’

- b. Ni-li-wa-it-a [ wa-gonjwa wa-wili ]<sub>j</sub> amba-o  
 1<sup>ST</sup>.SG-PST-2O-call-FV [ 2-patient 2-two ]<sub>j</sub> amba-2AGR  
 ni-na-m-fahamu [ kila daktari ]<sub>i</sub> amba-ye [ e<sub>i</sub>  
 1<sup>ST</sup>.SG-PRS-1O-know [ every doctor ]<sub>i</sub> amba-1AGR [ e<sub>i</sub>  
 a-li-wa-pim-a e<sub>j</sub> ].  
 1S-PST-2O-examine-FV e<sub>j</sub> ]

‘I called the two patients that I know every doctor who treated (them).’

Importantly, we claim that for QR to result in inverse scope in (10), the QR would necessarily involve violating a constraint on QR. To see this, first note that the universal quantifier is now the indirect object of the verb ‘give’ in the higher *amba*-RC in (10a), and the direct object of the verb ‘know’ in the higher *amba*-RC in (10b). This contrasts with (6–9), where the universal is in an embedded subject position. Crucially, the subject of ‘give’ is a definite description, and the subject of ‘know’ is an indexical. We assume that the subject of ‘know’ in (10b) is represented in the syntax with a *pro* that occupies the same structural

position as the overt DP subject of ‘give’ in (10a), making these two examples highly parallel. We further assume that in the Swahili data here, QR over a definite description or a pronoun does not establish a new meaning and that QR over such an element would not by itself satisfy scope economy. Now, in order for the various iterations of QR to proceed locally in (10), QR of the universal would have to first move from an interpretable position (by hypothesis, the  $vP$  edge) and adjoin above the subject ‘this pharmacy’ or *pro* at the TP layer (a clause-denoting constituent) of the ‘give’-clause or ‘know’-clause, before subsequently adjoining to a position higher than the RC-head with the numeral. This is shown schematically in (11), where adjunction positions for QR are underlined and indexed. However, adjoining in this lower position (i.e. adjunction in position  $\alpha$ ), as required by locality, would not establish a new meaning, and thus would violate scope economy.<sup>11</sup> Conversely, if QR skipped over position  $\alpha$  (thereby satisfying scope economy with the new scope relation established at position  $\beta$ ), locality would be violated.

(11) Local QR violating scope economy:

- a.  $\underline{\beta}$  ... [ two patients [ *amba*-AGR [TP  $\underline{\alpha}$  this pharmacy [ ... every doctor ... ] ] ] ] (cf. (10a))
- b.  $\underline{\beta}$  ... [ two patients [ *amba*-AGR [TP  $\underline{\alpha}$  *pro* [ ... every doctor ... ] ] ] ] (cf. (10b))

Consequently, the data in (10) constitute evidence against LDQR from *amba*-RCs: inverse scope appears to be possible even when the constraints on QR are violated. Accordingly, (10) is evidence against H2 in (8b) and the non-movement analysis (under either H1 or H2) in (2). According to (8b) and (2), we predict inverse scope to be impossible, contrary to (10).

---

<sup>11</sup>There is a potential complication in (10b) involving the position of the verb ‘know’. As Fox (2000: 65) discusses, QR over a verb such as ‘know’ can satisfy scope economy by establishing a new scopal relation with the intensional verb. For our purposes, this is only relevant if the verb in Swahili raises to a relatively high position. For example, if the verb ‘know’ in (10b–11b) raises to T, then scope economy via QR and adjunction to TP would be satisfied because even though the universal quantifier would not establish a new meaning with respect to *pro*, it could do so with respect to ‘know’. However, if the verb in Swahili raises only to some lower position, such as *v* or some aspectual head (cf. Ngonyani 2006), then the discussion in the main text remains unaffected. Regardless of the height of verb movement in Swahili, though, the argument presented here based on (10a), which involves the non-intensional verb ‘give’, still stands.

In contrast, (10) is possible under H1 in (8a) and the movement analysis in (5). Recall that for inverse scope to be possible under a head raising account we simply need to interpret a full lower copy of the RC-head with the numeral in the lower *amba*-RC, which is in a position below the universal in the higher *amba*-RC. This analysis follows if movement is possible out of doubly-embedded *amba*-RCs. If this line of reasoning is on the track, and it is indeed supported by the empirical finding in (10), then we are forced to conclude in favor of H1, namely that *amba*-RCs are not islands for overt movement.

Before concluding this section, we discuss one final alternative to the movement analysis under H1. For this final alternative we consider relaxing the constraints on QR. Suppose that there is cross-linguistic variation such that in some languages (e.g. English, as per Fox 2000) the locality constraint is operative for QR, whereas in other languages, such as possibly Swahili, the locality constraint on QR is *not* operative. What this would mean is that scope economy would not be violated as in (11), because no intermediate step of QR is forced by locality: this putative grammar for Swahili would allow for QR to adjoin directly to the higher QR position  $\beta$  in (11), without first adjoining to QR position  $\alpha$ .

However, we reject this parametric view of locality for the following reason. Under the null hypothesis, we would expect locality to not be operative in other embedding constructions in Swahili.<sup>12</sup> We can test for this with regular sentential complements to see whether a universal quantifier can QR from the embedded to

---

<sup>12</sup>A reviewer asks whether it might be the case that there is also variation across syntactic constructions with regard to the locality constraint. This view would hold that the null hypothesis mentioned in the main text is false because according to this view, the locality constraint could be inoperative for QR out of, say RCs, but might be operative for QR out of other kinds of embedded clauses. As a way of countering this view, the reviewer suggests providing some independent evidence that QR out of RCs is sensitive to the locality constraint. We believe that such independent evidence can be found, in part, by looking at RCs in English. Consider the example in (i) below.

- (i) I called the two journalists that described the award that Obama gave every soldier.  
(\* $\forall > 2$ )

Inverse scope of the universal over the numeral appears to be impossible. This is unexpected if the locality constraint did not apply to RCs. Indeed, the only kind of embedded clause that the universal would have to QR out of is an RC. If the locality constraint did not apply, the universal quantifier could QR to a position higher than the numeral, where it could take scope over the numeral and satisfy scope economy. However, the lack of inverse scope is expected given a locality constraint on QR. With such a constraint, the universal quantifier would have to adjoin to the TP that immediately dominates *Obama*. Such a step of QR, though, would violate scope economy, as no new meaning results from the universal taking scope over a name. Consequently any further QR in (i) is ruled out, and inverse scope becomes impossible.

the matrix clause.<sup>13</sup> As a baseline, we first give a simple matrix transitive example in (12) to show that an object can indeed take scope over a subject in Swahili independent of RC constructions. We assume that inverse scope is possible in (12) via QR. This QR respects scope economy and is local (from, say, the *vP* to the TP level).

- (12) Inverse scope of quantifiers possible in simple transitives: ✓  $\forall > 2$   
 Wa-vulana wa-wili wa-na-m-pend-a kila m-sichana.  
 2-boy 2-two 2S-PRS-1O-like-FV every 1-girl  
 ‘Two boys like every girl.’

The crucial data point is (13). There the universal is embedded as an applied object inside a sentential complement.<sup>14</sup> Importantly, the universal cannot take scope over the numeral subject in the matrix clause (which is base generated there, as there is no embedded gap), and a distributed reading is not possible.

- (13) Inverse scope of quantifiers not possible from complement clause: \* $\forall > 2$   
 Wana-funzi wa-wili wa-li-dai kwamba Juma a-li-m-fok-e-a  
 2-student 2-two 2S-PST-claim that Juma 1S-PST-1O-scold-APPL-FV  
 kila mw-alimu.  
 every 1-teacher  
 ‘Two students claimed that Juma scolded every teacher.’

Note that such a distributed reading would be possible if there were no locality constraint on QR: this unconstrained QR would obey scope economy (giving rise to the distributed reading) but would not have to proceed cyclically in a local manner by adjoining at the TP level (above the subject) in the ‘scold’-clause.

The fact that inverse scope is not possible in (13) supports the conclusion that locality is an operative constraint on QR in Swahili. Locality forces local QR above *Juma* within the embedded clause, but as *Juma* is simply a name, no new meaning is established and scope economy is violated. Consequently, it is not possible to have further QR of the universal above the matrix subject.

<sup>13</sup>We test this by looking at whether QR is possible with a universally quantified direct object in (12), and with a universally quantified applied object in (13). In applying this test, and in drawing conclusions from the test data, we assume that there is no relevant difference involving the possibility of QR with respect to these two types of objects. Further research can look more carefully at whether there are any relevant differences between the object types with regard to QR that might act as a potential confound in our application of the test here.

<sup>14</sup>In a manuscript version of this paper, we had transcribed the embedded verb without an applicative suffix, but we suspect that this was a typo. We thank a reviewer for pointing this out.

In sum, what (13) suggests with regard to this final alternative analysis is that what this alternative would call LDQR in (10) is not really QR at all. Accordingly, QR in Swahili (as in English) would be constrained by scope economy and locality. Further, the inverse scope relation in (10) is established by interpreting a full lower copy of the RC-head within the relative. This interpretive option is possible because movement of the RC-head involves leaving a copy of the head that can be interpreted within the relative. Thus on the basis of the detailed scope data considered in this section we conclude that *amba*-RCs involve head raising and are consequently not islands for overt movement (cf. Sichel 2014 for a similar claim regarding certain relative clause constructions beyond Swahili). In the following section we provide an additional data point involving another long-distance dependency that provides potential support for the claim that *amba*-RCs are not islands for overt movement.

## 5 Another long-distance dependency

In the previous section we provided an argument in favor of a movement analysis of *amba*-RCs along the lines of (5). We also claimed that *amba*-RCs are not islands for overt movement. Consequently, it is possible to relativize another RC-head by moving it past an RC-head+*amba* boundary, as in the case of doubly-embedded *amba*-RCs. The null hypothesis is that all instances of overt movement can move past this boundary (i.e. not just in cases of relativization). To the extent that we find such evidence, it supports our analysis of *amba*-RCs and their status as non-islands. In this brief section, we present preliminary data suggesting this null hypothesis is on the right track. What we see here is that another type of long-distance dependency that involves displacement is also possible across an *amba*-RC boundary. Our example of this involves the case of long-distance topicalization in (14), where we see topicalization of an argument past the RC-head+*amba* boundary.

- (14) Topicalization out of an *amba*-RC is possible  
 [ Ki-tabu hi-ki ]<sub>j</sub>, ni-na-m-fahamu m-tu<sub>i</sub> amba-ye [ e<sub>i</sub>  
 [ 7-book DEM-7 ]<sub>j</sub> 1<sup>ST</sup>.SG-PRS-1O-know 1-person<sub>i</sub> amba-1AGR [ e<sub>j</sub>  
 a-li-ki-andik-a e<sub>j</sub> ].  
 1S-PST-7O-write-FV e<sub>j</sub> ].  
 ‘This book, I know the person who wrote (it).’

It remains to be shown that topicalization in Swahili does in fact involve movement. This could involve, for example, repeating the argument of inverse scope

from the previous section with appropriately modified versions of (14). At this point we have no further data that would shed light on this issue, but given that the dependency in (14) involves displacement, it is a likely candidate for overt movement. Thus (14) is consistent with our claim that *amba*-RCs are not islands, and this would be a welcome finding should topicalization indeed involve movement in Swahili. Given our current data limitations, though, we will leave this as a topic for future research.

## 6 Final remarks

The literature on Swahili has offered contrasting accounts of relative clauses with *amba* that are based on separate types of evidence. In this paper, we took seriously the challenge of attempting to integrate these different sources of evidence into a unified analysis of these RCs. Our investigation hinged on a detailed look at novel data involving inverse scope relationships between quantifiers. Based on these data, we concluded that *amba*-RCs involve moving the RC-head from a position inside the relative to a position outside it, and that *amba*-RCs are not islands for overt movement.

To be sure, the discussion here should be seen as just an initial step of much broader and more far-reaching potential investigations of RCs in Swahili. For instance, as regards *amba*-RCs, the binding fact we illustrated in (7) can be explored in the same rigorous way as was done in §4.2. A more analytical question that we have not considered concerns the internal structure of *amba*-RCs. In particular, can the absence of island effects in Swahili versus the presence of island effects in English RCs be tied to some structural difference of the RC itself? More generally, we have not looked at the other types of RC constructions in Swahili (i.e. non-*amba*-RCs; cf. Ngonyani 2001), and it remains to be seen to what extent they can be assimilated to our overall analysis presented here. Our hope is that the systematic, empirical and analytical tack we have followed here can be used fruitfully for the future study of Swahili RCs, as well as those found in other languages.

## Acknowledgements

We would like to thank audiences at The University of Kansas and ACAL 47 for their feedback, Michael Yoshitaka Erlewine for his help, two anonymous reviewers, and the editors of this volume. Above all we thank David Mburu for being a

patient teacher and sharing his knowledge of his language with us. This paper is dedicated to his memory.

## Abbreviations

1-8	noun classes	HAB	habitual
1 <sup>st</sup>	first person	IO	indirect object
2 <sup>nd</sup>	second person	O	object
3 <sup>rd</sup>	third person	PRS	present
AGR	agreement	PST	past
APPL	applicative	REFL	reflexive
DEM	demonstrative	S	subject
FUT	future	SG	singular
FV	final vowel		

## References

- Aoun, Joseph & Audrey Li. 2003. *Essays on the representational and derivational nature of grammar*. Cambridge, MA: MIT Press.
- Barrett-Keach, Camillia. 1985. *The syntax and interpretation of the relative clause construction in Swahili*. New York: Garland.
- Chomsky, Noam. 1995. *The minimalist program*. Cambridge: MIT Press.
- Fox, Danny. 2000. *Economy and semantic interpretation*. Cambridge, MA: MIT Press.
- Heim, Irene & Angelika Kratzer. 1998. *Semantics in generative grammar*. Malden, MA: Blackwell.
- Henderson, Brent. 2006. *The syntax and typology of Bantu relative clauses*. The University of Illinois at Urbana-Champaign. (Doctoral dissertation).
- Hulsey, Sarah & Uli Sauerland. 2006. Sorting out relative clauses. *Natural Language Semantics* 14. 111–137.
- Kayne, Richard. 1994. *The antisymmetry of syntax*. Cambridge: MIT Press.
- Keach, Camillia N. 2004. On the obligatory presence of object marking in Swahili relative clauses. In Chege Githiora, Heather Littlefield & Victor Manfredi (eds.), *Kinyira njira! Step firmly on the pathway!*, 125–34. Trenton, NJ: Africa World Press.
- May, Robert. 1977. *The grammar of quantification*. Cambridge, MA: Massachusetts Institute of Technology dissertation.

- May, Robert. 1985. *Logical form: Its structure and derivation*. Cambridge, MA: MIT Press.
- Ngonyani, Deo. 2001. Evidence for head raising in Kiswahili relative clauses. *Studies in African Linguistics* 30. 59–73.
- Ngonyani, Deo. 2006. Attract F and verbal morphology in Kiswahili. *The Linguistic Review* 23. 35–66.
- Sichel, Ivy. 2014. Resumptive pronouns and competition. *Linguistic Inquiry* 45. 655–693.



## Chapter 24

# The Aorist and the Perfect in Mano

Maria Khachaturyan

University of Helsinki

The foci of this paper are the semantic differences between two perfective constructions in the Mano language, the Aorist and the Perfect. The paper is based on Östen Dahl's classic questionnaire, as well as various sources of natural speech data, including narratives, routine conversations, and ritual speech, Christian and traditional. The core semantic property of the Mano Perfect is event relevance, which is confirmed by the annulled result test. The core function of the Aorist is being the narrative tense. The paper also includes discussion of two secondary functions of the Perfect and the Aorist, namely, anticipation of future events and transposition to the past. The secondary functions confirm the basic distinction between the Aorist and the Perfect, the latter maintaining a closer connection with the reference point.

## 1 Introduction

The purpose of this paper is to investigate the functions fulfilled by the Aorist and the Perfect<sup>1</sup> constructions in Mano (< Mande). Mano is a Mande language spoken in Guinea and Liberia by approximately 400,000 speakers. The data for this paper comes from Östen Dahl's questionnaire on perfect (Dahl 2000), as well as from spontaneous texts of various genres: routine exchanges; narratives; oral Bible translations; traditional ritual speech. The examples are marked according to the speech genre: *el.* for elicitation, *conv.* for routine exchanges, *narr.* for narratives and *rit.* for ritual speech. The excerpts from the oral Bible translations<sup>2</sup> and the excerpts from the Dahl's questionnaire are made recognizable by an explicit

---

<sup>1</sup>Following Haspelmath (2010), grammatical labels with an initial capital refer to language-specific categories (the Mano Aorist and Perfect), while lower-case spelling is used for comparative concepts of aorist and perfect.

<sup>2</sup>Bible verses in English are taken from the *NIV* 2017 with few exceptions.



reference to the source. All elicitation and speech data were collected during fieldwork among the Mano in 2009–2016.

A note on terminology will be helpful at the outset. I divide TAMP constructions in Mano into perfective, imperfective and aspectually unspecified. The term “perfective” is thus used here not to label a specific construction, but as a general classificatory term bringing together several aspectual constructions, including the Aorist and the Perfect, which are the focus of the present paper. Although descriptive and typological works often classify perfect as a category apart, it is useful to consider the Mano Perfect a type of perfective construction in contrast with the Aorist. The two constructions clearly belong to the same family of constructions: as we will see in §2.3, negative Perfect is formed on the basis of the negative Aorist construction with addition of specific adverbs. Similarly, the term “Aorist” is rare in the literature and was clearly dispreferred by Comrie (1976) (in contrast with the European tradition represented by Plungian (2016) or Maïsak (2016)). However, it seemed useful to use the term “Aorist” as a label of a specific construction characterized by the perfective aspect, to avoid confusion with perfective as a generic term.

This paper is organized as follows. I begin by presenting a summary of Mano tense, aspect, modality and polarity system in §2 giving special attention to the constructions with perfective meaning. §3 is dedicated to the aorist construction. §4 focuses on the functions of the perfect construction. §5 and §6 explore two secondary functions of the Perfect and the Aorist, namely, anticipation and transposition. Finally, §7 is a discussion of the Aorist–Perfect opposition in a typological perspective.

## **2 Perfective constructions in Mano**

### **2.1 Structure of Mano TAMP system**

TAMP distinctions in Mano do not show up at the level of any one specific marker, but rather at the level of a construction which includes an auxiliary or a copula, a verb in a specific form, and, in certain cases, some other elements, such as adverbs or auxiliary verbs.

There are two types of TAMP constructions in Mano: constructions featuring a copula and constructions featuring an auxiliary marker (AUX). The auxiliary markers (AUX) index the subject’s person and number; these markers are organized in series expressing tense, aspect, modality and polarity. Mano counts eleven series of auxiliaries: perfect, past, existential, imperfective, conjoint, nega-

tive, conjunctive, prohibitive, subjunctive, prospective, and dubitative. The word order in constructions with auxiliaries is: S – AUX – (O) – V. The word order in copula constructions is: S – (O) – COP. For a full description of the Mano aspectual system, see Khachaturyan (2015).

Table 1 presents the perfect and the past auxiliaries.

Table 1: Past and perfect auxiliary series in Mano

	1SG	2SG	3SG	1PL	2PL	3PL
past	$\bar{\eta}$ ( <i>mā</i> )	$\bar{i}$ ( <i>bā</i> )	$\bar{e}$ ( <i>ā</i> )	<i>kō</i> ( <i>kṣā</i> )	<i>kā</i>	$\bar{o}$ ( <i>wā</i> )
perfect	<i>māà</i>	<i>bāà</i>	<i>āà</i>	<i>kṣāà</i>	<i>kāà</i>	<i>wāà</i>

The direct object of transitive verbs is obligatorily expressed by a noun phrase or a pronoun of the basic (non-subject) series. Past auxiliaries distinguish between a simple and a portemanteau form. The latter is used if the direct object is a 3<sup>rd</sup> person SG pronoun; such markers are put in brackets in Table 1. For perfect auxiliaries there is no distinction between a simple and a portemanteau form. Compare the following two examples: in the first example, a simple and a portemanteau form are contrasted. Note the absence of this contrast in a similar context in the second example.

- (1) a.  $\bar{e}$             *ló*.  
           3SG.PST go  
           ‘(S)he left.’ (narr.)  
 b.  $\bar{a}$                     *zē*.  
           3SG.PST>3SG kill  
           ‘S/he killed him.’ (narr.)

- (2) a.  $\bar{a}à$             *ló*.  
           3SG.PRF go  
           ‘(S)he has left.’ (narr.)  
 b.  $\bar{a}à$                     *zē*.  
           3SG.PRF>3SG kill  
           ‘(S)he has killed him.’ (narr.)

The verb can bear segmental and/or tonal morphemes. Note the example below with the imperfective construction, where the verb *ló* ‘go’ is used in the imperfective form, *lō* ‘go:IPFV’.

- (3) lɛ̀ɛ̃      lɔ̃.  
3SG.IPFV go:IPFV  
'(S)he leaves.' (narr.)

## 2.2 Affirmative perfective constructions

The aorist construction is formed with the auxiliary of the past series (PST) and a verb in its lexical form, see (1)<sup>3</sup>

The perfect construction is formed with the auxiliary of the perfect series (PRF) and a verb in its lexical form, see (2).

The experiential value is expressed by the perfect construction with the adverb *dō* 'at least) once; never':

- (4) kɔ̃ɔ̃      mā dō.  
1PL.PRF>3SG hear once  
'We have heard (about) it.' (conv.)

Other perfective constructions in Mano include: resultative construction and recent past construction.

Like many African languages (Carlson 1992), Mano has a consecutive construction. It is formed with an auxiliary of the conjoint series (JNT) and a verb in the conjoint form. As its central function is to convey events on the main narrative event line, it functions like a perfective construction (and can often be replaced by the aorist construction).

- (5) ē      lè      ā      vòlò,      áà      yíli vò.  
3SG.PST place DEM stub.out 3SG.JNT tree fell:JNT  
'He cleared the field and felled the trees.' (narr.)

## 2.3 Negative perfective constructions

The negative aorist construction is formed with the negative auxiliary (NEG) and the negative particle *gbā* preceding the direct object; the verb is in the lexical form.

---

<sup>3</sup>The past auxiliary series is aspectually neutral, because the series is used not only in the aorist construction, but also in the past imperfective construction which is not formed parallel to the imperfective construction, but rather parallel to the durative construction, see Khachaturyan (2015: 195-196).

- (6) lèé gbāā gè.  
 3SG.NEG NEG>3SG see  
 ‘He didn’t see her.’ (narr.)

The negative perfect construction is formed with the negative auxiliary and the particle *néj* ‘yet’, following the verb in the lexical form.

- (7) ñ sō dò lèé kòò néj.  
 1SG.POSS cloth INDEF 3SG.NEG dry yet  
 ‘Some of my clothes have not dried yet.’ (el.)

The negative experiential construction is formed like the perfect construction; the difference is that the particle *néj* is replaced by the particle *dō* ‘once, never’.

- (8) kòó mī dò gè zèē dō.  
 1PL.NEG person INDEF see here once  
 ‘We have never seen anyone here.’ (el.)

Mano also has negative resultative construction.

The present paper will be limited to the constructions of the Aorist and the Perfect, although a full analysis should include all affirmative and negative perfective constructions, including the resultative constructions, the analytic construction of recent past, and the consecutive construction. For some details on the distribution between the Aorist and the consecutive construction in the narrative, see §3.1.

### 3 Aorist

#### 3.1 Narrative

The Aorist is the default tense in the narrative. The consecutive construction has a limited distribution, usually occurring when the subject is coreferential to the subject of the previous clause, or with the speech verbs. Moreover, the consecutive construction does not occur if the reported events occurred in the recent past. As for the perfect construction, when used within the narrative, it is usually limited to the direct speech or to the coda of the narrative (see §4).

- (9) ṅ táá lūú, ṅ bálá mènē là, ē ṅ sǔǔ dǔ,  
 3SG.PST walk bushes 1SG.PST step snake on 3SG.PST 1SG tooth stop  
 ṅ gèlè sí, mā pá á ká, ē gā.  
 1SG.PST stone take 1SG.SG>3SG strike 3SG with 3SG.PST die  
 ‘I walked in the bushes, I stepped on a snake, it bit me, I took a stone, I hit  
 it with it, it died.’ (adapted from Dahl 2000: 801, ex. 8)

### 3.2 Temporal adverbs

The Aorist, as opposed to the Perfect, freely combines with temporal adverbs (see also (15a)).

- (10) ī yī zē pég sè?  
 3SG.PST sleep kill yesterday.night well  
 ‘(Question asked in the early morning) Did you sleep well last night?’  
 (conv.)

### 3.3 Annulled result

The Aorist is the only perfective form that can be used in the contexts with annulled result.

- (11) kǎā dà yéíwò yí, mais yéíwò wáá ká.  
 1PL.PST>3SG fall joke in but joke NEG.COP>3SG with  
 ‘We considered it a joke (lit.: we fell in a joke), but it isn’t a joke.’ (conv.)

Only the Aorist is possible in combination with the verb *pē* ‘fail to do something’ (be engaged, voluntarily or involuntarily, in an action that was interrupted before its natural termination):

- (12) à gǔǔ ē pē é ló yí wì kpàá gbínī yāā ká.  
 REF boat 3SG.PST fail 3SG.CONJ go water under fish heavy DEM with  
 ‘The boats did not sink (lit.: failed to sink), loaded with fish (lit.: with the heavy fish).’ (and they filled both boats so that they began to sink, NIV, Lc 5:7).

Note the aorist construction followed by the perfect construction, the latter expressing an event which annulled the result of the former:

- (13) ò kálémò ē nī ò ká, mǎà gè.  
 1SG.POSS house 3SG.PST forget 1SG with 1SG.PRF>3SG see  
 ‘I lost my house, but (now) I have seen it’. (conv.)

## 4 Perfect

### 4.1 Recent past

The perfect construction is extremely frequent in the everyday ROUTINE EXCHANGES:

- (14) bǎà bū bèle?  
 2SG.PRF rice eat  
 ‘Have you eaten (rice, typical food)?’ (conv.)

The Perfect combines with a very restricted set of temporal adverbs, which even excludes some adverbs denoting recent past. Thus, the adverb *pénēē* ‘today’ can combine with both the Aorist and the Perfect, while only the Aorist can combine with the adverb *dēēká* ‘recently, now’.

- (15) a. ò/\*mǎà nū dēēká.  
 1SG.PST/1SG.PRF come recently  
 ‘I have just arrived.’ (conv.)  
 b. ò/mǎà nū pénēē.  
 1SG.PST/1SG.PRF come today  
 ‘I have arrived today.’ (conv.)

When the perfect construction appears in the narratives, it is most frequently used in *direct* (16) and *indirect speech* (17).

- (16) áà gèè: ”mǎà mā, òjò ló gbǎà à gbēē  
 3SG.JNT>3SG say:JNT 1SG.PRF>3SG hear 1SG.NEG go now 3SG another  
 kē-è.”  
 do-GER  
 ‘He says: I understand (lit.: I’ve understood), I won’t do it anymore.’ (narr.)

- (17) tó ké mā bō dàá nó wē,  
 stay like.this 1SG.PST>3SG implement fall.GER.with only DEM  
 láà gèè kélè māà gā.  
 3SG.IPFV>3SG say that 1SG.PRF die

‘(A person relating his accident when he was hit by a motorbike and fainted). As I<sub>i</sub> stayed like this, fallen down, she<sub>j</sub> said that I<sub>i</sub> had died (lit.: have died).’ (narr.)

Quotation and indirect speech fall apart from the narrative line; it may be suggested that quotes and indirect speech imitate the routine conversation, which would explain the usage of the Perfect.

A piece of evidence supporting this explanation is that the Perfect is frequent in the direct speech in oral Bible translations performed during the Sunday service. Again, it may be seen as an imitation of the routine conversation practice, where the Perfect is common. (Note that Östen Dahl (2014) chose to study direct speech in the Bible separately to get an idea of the routinely spoken language, as opposed to its usage in the narrative.) The influence of French can be minimized: in the French source the *passé composé* form was used, which in modern French does not have the perfect function anymore. Moreover, Mano, including Mano translators, are not fluent in French and it is unlikely that French exercises grammatical interference. Note the usage of the pronoun of the 2<sup>nd</sup> person *ī* ‘your’, through which it can be seen that the speech is indeed addressed – in this case, to the city of Jerusalem:

- (18) kō ηwūméfōmī āā ī yókò kē āā lò gbèkènī ī ká.  
 2SG savior 3SG.PRF 2SG enemy do 3SG.JNT go:JNT far 2SG with  
 ‘Our savior has made your enemies go far from you.’ (he has turned back your enemy, NIV, Ze 3:15)

#### 4.2 Relevant past

The perfect construction can be used to relate a past event regardless of the time when it happened, provided it is still relevant (specifically, if there has not been any intervening event that annulled the effect of the event in question, in which case the Aorist is used, see §3.3).

- (19) māà mīnīḡḡ pèèlē kpó ḡ sónó.  
 1SG.PRF million two put 1SG near

[Question: I was told you are collecting money for your new motorbike.



How much money have you collected so far?] ‘I have collected two million (Guinean francs).’ (adapted from Dahl 2000: 803, ex. 42)

The Aorist is somewhat acceptable in these contexts. It becomes unacceptable when the event is in focus, which happens when the assertion of the event is made as a response to a yes/no question or in contrast to what has been said before.

- (20) gbāō, āā/\*ē                      gā.  
 no    3SG.PRF/3SG.PST die  
 ‘[Question: Is the chief still alive?] No, he has died.’ (adapted from Dahl 2000:801, ex. 3)

The contrast between the Perfect and the Aorist can be seen when the description of some past events serves to explain the current situation. The following example is an adopted example 46 from Dahl’s questionnaire (Dahl 2000: 803). The stimulus question was [A is setting out on a long journey on an old motorbike. B asks: What if something goes wrong with your motorbike on the way? A responds:]

- (21) māā/\*ī                      pàà ló, māā/\*ī                      séènè ló.  
 1SG.PRF/1SG.PST piece buy 1SG.PRF/1SG.PST chain buy  
 ‘I’ve bought (spare) parts, I have bought a chain.’ (I can replace them if needed.)

Here the response is configured as a little narrative. However, it is intended to answer B’s question and serves as an explanation of how A got prepared for his trip, and not just to relate past events. Had the Aorist been the construction used in this context, it would not have had any relation to the question asked, and the answer would have sounded odd. The key semantic contribution of the marking with the Perfect, then, is that it underlines the relevance of the actions A undertook for the current (and future) situation.

The perfect construction may combine with adverbs like *pélè* ‘1. early, 2. a while ago’, meaning that the action took place in the relatively remote past, but assuming it is still relevant:

- (22) āā                      gbè à    mò pélé    ηwó yīè    kē-è    ká.  
 3SG.PRF put 3SG on early thing good do-GER with  
 ‘He started doing good things a long time ago.’ (narr.)

The prophecies, especially those of the Old Testament, are often translated with the perfect construction, which conveys their eternal relevance.

- (23) kò nē dēē wāà nō kō lēē.  
1PL.POSS child new 3PL.PRF>3SG give 1PL to  
'A new child of ours, they have given him to us.' (For to us a child is born, NIV, Is 9:6).

### 4.3 Coda of a narrative

The Perfect often marks the concluding sentence in a narrative or other type of text describing a sequence of events. Thus, the descriptions of procedures are often concluded by the perfect construction, as in the following description of how to make an aluminum kettle:

- (24) ...wā nēsésélé bēē bō yī, kē wāà gbōō  
3PL.PST>3SG sand too take.off there at.that.moment 3PL.PRF kettle  
bēi.  
make  
'...you also took away the sand, so you've made a kettle.' (narr.)

In narratives proper, the perfect construction often marks concluding events, as in the following three propositions closing a fairy tale:

- (25) a. sī lé āà pā.  
spider mouth 3SG.PRF fill  
'Spider was surprised.'
- b. yé wāà gáá fēē ē sī gí āà fū.  
when 3PL.PRF>3SG drag long TOP spider stomach 3SG.PRF pierce  
'After they dragged him for a long time, Spider's stomach pierced.'
- c. sī āà gā, là nōò wāà ŋwèŋ léé là.  
spider 3SG.PRF die 3SG.POSS child.PL 3PL.PRF disperse leave on  
'Spider died and its children dispersed on the leaves.' (narr.)

When I asked my language assistant to explain this sequence of perfect constructions, he said that the narrator took his time finishing the story, otherwise one perfect construction as in (25c) would be enough.

Similarly, the Perfect can be used (although rarely) to mark an intermediate coda ending a subepisode in the narrative.

- (26) *tó ē néfú bē mē, ē ē léyí sùò à là. à*  
 then 3SG.PST child DEM beat 3SG.PST 3SG.REFL saliva spit 3SG on 3SG  
*mé āà bā.*  
 surface 3SG.PRF cover.with.wounds  
 ‘Then she drew him down, then she beat the child and spit on him. He became all covered with wounds.’ (narr.)

Typical situations expressed by the Aorist are either 1. atemporal, as in the case of narratives, 2. embedded in the time frame indicated by the temporal adverbs and detached from the moment of enunciation, or 3. irrelevant for the present situation, as in the case of the contexts with annulled result. The Perfect, on the contrary, is typically used when the described situation is closely related to the moment of enunciation: by bearing relevant consequences, including (in some cases) by being recent.

In what follows, I will describe two secondary functions of the Perfect and the Aorist, namely, anticipation and transposition, in which their basic aspectual characteristics will be supported.

## 5 Anticipation

Both the Perfect and the Aorist can be used with an anticipatory function, when a future event is expressed as if it has already happened (cf. Hanks 1990: 224). The Perfect is usually used when the event is expected to occur in the nearest future:

- (27) *māà nū!*  
 1SG.PRF come  
 ‘I’ll be right back! (lit.: I have come!)’ (conv.)

The Aorist can also be used with an anticipatory function. Firstly, it can replace the imperfective or the future construction in a sequence of events in the Imperfective/Future:

- (28) *î lô, ī nā ē lô, bā nòò yààkā ō lô.*  
 2SG.IPFV go:IPFV 2SG wife 2SG.PST go 2SG.POSS child three 3PL.PST go  
 ‘You will go, your wife will go, three of your children will go.’ (conv.)

Secondly, it is used in ritual formulas of benediction (29). Importantly, the action is not necessarily supposed to be realized immediately (although it may).

- (29) *kṣā*            *lè*    *gè* *zòkpólà àpènézè kó*            *ḡṣ*    *yī!*  
 1PL.PST>3SG place see peace    for.that 1PL.CONJ arrive there  
 ‘(Ritual formula framing a benediction) We will see it in peace, in order  
 for it to obtain, let us arrive there.’ (rit.)

## 6 Transposition

By TRANSPOSITION (Hanks 1990: 217-223) I understand the function in which the reference point does not coincide with the moment of enunciation, but is transposed on the time scale: in the case of Mano, the reference point is usually transposed to the past. A term most often used for the forms fulfilling this function is “anterior” (Bybee et al. 1994) or “pluperfect” (Sichinava 2013). This function is typically associated with perfect forms (Klein 1992; 1994) to the point that perfects themselves are sometimes called “anterior”. However, as I will make clear below, in Mano both the Aorist and the Perfect can function as “anterior”.

The following two examples are taken from narratives; the events of the main narrative line are expressed by the aorist construction. The background events which occurred immediately prior to the events of the main story line are expressed by the perfect construction:

- (30) *būwélé nì, báá*    *nì, dìì*    *nì né wāà*            *zē* *tèkétèké*    *ē*    *ē*  
 rice    PL sheep PL cow PL REL 3PL.PRF>3SG kill completely TOP 3SG.PST  
*tó*    *gbāā tíé.*  
 stay now fire  
 ‘The rice, the sheep, the cows that they had killed completely, they were  
 cooking now (lit.: they stayed on the fire now).’ (narr.)

If, however, the background event happened long before the reference point, the aorist construction is used.

- (31) *wā*            *gèè à*    *lèè é*            *nū*    *Moise là*            *tóḡ sèbè*    *yā*  
 3PL.PST>3SG say 3SG to 3SG.CONJ come Moses 3SG.POSS law book:CS DEM  
*ká*    *té kō* *ḡwūmébōmì ē*            *à*    *dòkē* *Israēl mià*            *móḡwò*  
 with REL 1PL savior            3SG.PST 3SG give Israel person.PL:CS because.of  
*yā.*  
 TOP

‘They told him to come with the book of the Law of Moses that our savior gave because of the people of Israel’ (They told Ezra the teacher of the

Law to bring out the Book of the Law of Moses, which the Lord had commanded for Israel, NIV, Ne 8:1).

The Perfect can also be used in temporal clauses with habitual meaning, or with reference to the future, as well as in the real protasis of conditional clauses. The construction is the same in both cases.<sup>4</sup> The protasis is closely tied to the apodosis by the causal relation, so the Aorist can never be used in this position.

- (32) yé āà ɓɓ nɔ yíli gbùò yā bí m̀ò ɓ, léè  
 when 3SG.PRF arrive only tree big DEM shadow on TOP 3SG.IPFV  
 wàà gbāā yíli gbùò ɓē gáná yí.  
 enter:IPFV now tree big DEM root in  
 ‘When she enters under the shadow of this big tree, she gets inside its root.’ (narr.)

## 7 Discussion

As suggested in the foundational works by Comrie (1976), McCoard (1978) and Dahl (1985), the general positive definition of perfect is the continuing relevance of a previous situation (Comrie 1976: 56). This definition seems to match the Perfect in Mano quite closely.

The resultative meaning is often considered the core meaning of perfect for semantic reasons (because the result is viewed as the clearest manifestation of the relevance of the situation), but also for diachronic reasons (as perfect is often a grammaticalized resultative construction, Plungian 2016). In contrast, the Mano Perfect, formed with an auxiliary and a verbal root, is no more analytical than any other TAMP construction in Mano and it is unlikely that it grammaticalized from a resultative construction.

Östen Dahl’s cross-linguistic study of parallel corpora (Bible translations into several European languages, Dahl 2014) confirms that the prototypical contexts for the perfect involve event relevance (cf.: “Take heart, daughter,” he said, “your faith has healed you.”, NIV, Ma 9:22). In these contexts, the target Bible verse was systematically translated with the use of a perfect construction. Note, however, that a different parallel corpus study focusing on a smaller corpus, consisting of translations of *Alice in Wonderland* and *Winnie the Pooh*, but on a larger linguistic sample, including the languages of the Balkans (Greek, Bulgarian, Macedonian),

<sup>4</sup>In the French spoken by Mano, especially by children, *quand* ‘when’ and *si* ‘if’ are often confused: *Tantie, si tu finis de travailler, on va lire?* ‘Aunty, if you finish working, we will read?’.

came to a different conclusion: that the semantic core of the European perfect is not current relevance, but experiential meaning (Sichinava 2016).<sup>5</sup>

Whether or not current relevance is at the core of the semantics of the European perfect, it seems to be the main parameter defining the Perfect and distinguishing it from the Aorist in Mano. The context of annulled result (§3.3) is a good test for this parameter as it yields strict complementarity: if the result of some action was overruled by some consequent action, the perfect construction cannot be used.<sup>6</sup> On the contrary, when a certain past event is explicitly presented as a justification of a current or a future situation, as in example (21), the perfect construction is clearly preferred to the Aorist.

A relevant event expressed by the Perfect in Mano does not have to be recent. In routine conversation many relevant events are recent: moreover, when a pair of examples with the Aorist and the Perfect are evaluated by native speakers, they tend to analyze the latter as being more recent. Cross-linguistically, however, recency seems to be more of an implicature rather than part of the semantics. Non-recent perfects are very common: experiential perfect is typically not recent. In general, Dahl and Hedin (Dahl & Hedin 2000) analyze the “hot news” value as a late semantic development of perfects.

Perfects cross-linguistically often show important restrictions in combinations with temporal adverbs, as temporal specification “somehow detracts from the focusing on the result ... perhaps by transferring the attention to the time of the past event” (Dahl & Hedin 2000: 395). This is also the case for Mano (see §3.2). Compatibility with temporal adverbs, however, is also very idiosyncratic: some perfects combine freely with temporal adverbs of any kind (Maïsak 2016).

Another function of the Perfect in Mano is marking the coda of a narrative (§4.3). For William Labov (2001: 65), the function of the coda is indicating the “termination of the narrative by returning the time frame to the present”. The narrative can be put back into relationship with the present by dissociating the narrative time and the present time. This is the strategy used in Totela, a Bantu language (Crane 2015), where the narrative coda is marked by a prehodiernal affix which signals that the situation is excluded from (and is prior to) the temporal

---

<sup>5</sup>Note also that Dahl’s study which included several translations into the same language identified significant intralinguistic variation: the variation between translations into one language is often comparable in extent to that between languages.

<sup>6</sup>This test, however, is not universally applicable across languages. Events that have been overruled by some other event can still be relevant, as in the ex. 37 of Dahl’s questionnaire (Dahl 2000: 803): “[It is cold in the room. The window is closed.] Question: You OPEN the window (and closed it again)?”. Thus, while Mano prohibits the usage of the Perfect in this context, in the Nij dialect of Udi the Perfect is grammatical (Maïsak 2016).

domain of “now”. The Mano strategy is different: it uses the perfect construction which shifts the coda sentence from the domain of narrative past and associates it with the present. This is also the strategy used in the Nij dialect of Udi (Nakh-Dagestanian, Maïsak 2016).

The strongest cross-linguistically valid definition of perfect, surprisingly, is a negative one, namely, the property of *not* being a narrative tense (Lindstedt 2000). Narrative function is the “anti-prototype” of perfect, that is, “a set of uses that are left untouched until the final end of the grammaticalization process by which perfects expand into general pasts”, as occurred in spoken French (Dahl 2014: 280). Narrative forms are not always perfective in a language (cf. narrative present), but when they are, their usage in this context can serve as a distinction between a narrative perfective tense (which is often called aorist) and a perfect tense (cf. Maïsak 2016). This distinction is strongly supported in Mano.

Let us now turn to the transposition and anticipation functions of the Aorist and the Perfect. In the function of anticipation, the basic semantic opposition between the Aorist and the Perfect as constructions expressing “remote” and “recent” events is preserved: as the Aorist typically expresses more remote past events, the predictions framed in it are also expected to occur in the non-immediate future; meanwhile, since the Perfect expresses recent past events, the anticipated event described by the Perfect is seen as close at hand. As for the transposition function, when the reference point is transposed from the moment of enunciation to a certain moment (typically) in the past, again, the choice between the Aorist and the Perfect conforms to exactly the same tendencies as in regular occurrences: whether the focus event happened long or not so long before the reference point, whether it was still relevant at the reference point, etc.

## 8 Conclusion

This paper investigates the semantic differences between two perfective constructions in the Mano language, the Aorist and the Perfect. The paper uses various sources of data, including Östen Dahl’s classic questionnaire, but also spontaneous speech: narratives, routine conversations, and ritual speech, Christian and traditional. The Mano Perfect shares with the (much disputed) cross-linguistic prototype the function of expressing event relevance. At the same time, it shares the property of not being a narrative tense, which is a cross-linguistic “anti-prototype” of perfect and is in Mano reserved to the aorist construction, as well as the consecutive construction, which remained out of the scope of this paper. More interestingly, Mano Aorist and Perfect have two secondary functions,

namely, anticipation of future events and transposition to the past. It turns out that the secondary functions confirm the basic distinction between the Aorist and the Perfect, the latter maintaining a closer connection with the reference point.

## Acknowledgements

I am grateful to the speakers of the Mano language and inhabitants of the city of Nzérékoré, as well as the villages of Godi, Yei and Bheleton, Guinea. I am especially indebted to Pé Mamy, Cé Simmy, Émile Loua, Aimé Simmy, † Alfred Sandy and † Éli Sandy, for teaching me the language and for being always available and always welcoming. I am grateful to William F. Hanks and to Valentin Vydrin for the comments on various aspects of this paper. I am thankful to the anonymous reviewer for helpful revisions and suggestions. The research, including the fieldwork, was supported by the Fyssen Foundation and by the LLACAN, CNRS, France.

## Abbreviations

1	1st person	NEG	negative
2	2nd person	PL	plural
3	3rd person	POSS	possessive
CONJ	conjunctive	PRF	perfect
COP	copula	PST	past
CS	construct state	REF	referential
DEM	demonstrative	REFL	reflexive
GER	gerund	REL	relative
INDEF	indefinite	SG	singular
IPFV	imperfect	TOP	topic
JNT	conjoint		

## References

- Bybee, Joan, Revere Perkins & William Pagliuca. 1994. *The evolution of grammar: Tense, aspect, and modality in the languages of the world*. Chicago, London: University of Chicago Press.
- Carlson, Robert. 1992. Narrative, subjunctive, and finiteness. *Journal of African Languages and Linguistics* 13(1). 59–85.



- Comrie, Bernard. 1976. *Aspect: An introduction to the study of verbal aspect and related problems*. Cambridge: Cambridge University Press.
- Crane, Thera Marie. 2015. The role of dissociative and (non-)completive morphology in structuring Totela (Bantu) narrative. In Doris L. Payne & Shahar Shirtz (eds.), *Beyond aspect: The expression of discourse functions in African languages*, vol. 109 (Typological studies in language), 145–176. Amsterdam: John Benjamins.
- Dahl, Östen. 1985. *Tense and aspect systems*. Oxford: Basil Blackwell.
- Dahl, Östen (ed.). 2000. *Tense and aspect in the languages of Europe*. Berlin: Mouton de Gruyter.
- Dahl, Östen. 2014. The perfect map: Investigating the cross-linguistic distribution of TAME categories in a parallel corpus. In Benedikt Szmrecsanyi & Bernhard Walchli (eds.), *Aggregating dialectology, typology, and register analysis. Linguistic variation in text and speech*, vol. 28 (Linguae & litterae), 268–289. Berlin: Walter de Gruyter.
- Dahl, Östen & Eva Hedin. 2000. Current relevance and event relevance. In Östen Dahl (ed.), *Tense and aspect in the languages of Europe*, 384–401. Berlin: Mouton de Gruyter.
- Hanks, William F. 1990. *Referential practice: Language and lived space among the Maya*. Chicago: University of Chicago Press.
- Haspelmath, Martin. 2010. Comparative concepts and descriptive categories in cross-linguistic studies. *Language* 86(3). 663–687.
- Khachatryan, Maria. 2015. Grammaire du mano. *Mandenkan* 54. 1–252.
- Klein, Wolfgang. 1992. The present perfect puzzle. *Language* 68(3). 525–552.
- Klein, Wolfgang. 1994. *Time in language*. London: Routledge.
- Labov, William. 2001. Uncovering the event structure of narrative. In Deborah Tannen & James T. Alatis (eds.), *Georgetown University roundtable on languages and linguistics 2001: Linguistics, language, and the real world: Discourse and beyond*, 67–83. Washington: Georgetown University Press.
- Lindstedt, Jouko. 2000. The perfect – aspectual, temporal and evidential. In Östen Dahl (ed.), *Tense and aspect in the languages of Europe*, 365–384. Berlin: Mouton de Gruyter.
- Maïsak, Timur. 2016. Perfekt i aorist v nidzhinskom dialekte udinskogo jazyka. In Timur A. Maïsak, Vladimir A. Plungian & Ksenia P. Semenova (eds.), *Tipologija perfekta* (Acta Linguistica Petropolitana XII(2)), 315–378. Saint-Petersburg: Nauka.
- McCoard, Robert W. 1978. *The English perfect: Tense-choice and pragmatic inferences*. Amsterdam: North-Holland.

- NIV. 2017. *New international version*. Colorado Springs: Biblica. <https://www.biblegateway.com/versions/New-International-Version-NIV-Bible/>, accessed 2017-10-1.
- Plungian, Vladimir. 2016. K tipologii perfekta v jazyka mira: predisloviye. In Timur A. Maisak, Vladimir A. Plungian & Ksenia P. Semenova (eds.), *Tipologija perfekta* (Acta Linguistica Petropolitana XII(2)), 7–38. Saint-Petersburg: Nauka.
- Sichinava, Dmitriy. 2013. *Tipologija pluskvamperfekta. Slavjanskij pluskvamperfekt*. Moscow: AST-Press.
- Sichinava, Dmitriy. 2016. Jevropejskij perfekt skvoz' prizmu paraparalelnogo korpusa. In Timur A. Maisak, Vladimir A. Plungian & Ksenia P. Semenova (eds.), *Tipologija perfekta* (Acta Linguistica Petropolitana XII(2)), 85–114. Saint-Petersburg: Nauka.

## Chapter 25

# Nominal quantification in Kipsigis

Meredith Landman

Pomona College

In this paper, I examine the syntax and semantics of nominal quantification in Kipsigis, a Nilotic language spoken in western Kenya. I present a compositional analysis of quantificational nominals and discuss how the Kipsigis patterns relate to previous crosslinguistic work on quantification.

## 1 Introduction

In this paper, I examine the syntax and semantics of nominal quantification in Kipsigis, a Nilotic language spoken by roughly 2 million people in western Kenya. I focus on nominals that contain the universal quantifier *tugul*, as in (1):<sup>1</sup>

- (1) ru-e lagok tugul  
sleep-PRS child.PL all  
'All the children are sleeping.'

Such nominals pose a compositional puzzle, as although *tugul* may combine with a plural noun, as in (1), *tugul* may not combine with a singular noun unless the morpheme *age* is also present, in which case the resulting interpretation is 'every, any', as in (2a); *age* on its own translates as 'some, (an)other', as in (2b).<sup>2</sup>

- (2) a. ru-e lakwet \*(age) tugul  
sleep-PRS child.SG \*(some.SG) all  
'Every child is sleeping.'

---

<sup>1</sup>All data are from my own field notes collected through elicitation interviews with Robert Kipkemoi Langat, a native Kipsigis speaker in his early 20s.

<sup>2</sup>For brevity, I gloss *age* as 'some' throughout.



- b. ru-e lakwet age  
 sleep-PRS child.SG some.SG  
 ‘Some/another child is sleeping.’

This pattern raises two analytical questions. First, what semantic (and syntactic) contribution does *age* make, to allow *tugul* to attach to a singular nominal? Second, how is the resulting universal interpretation compositionally derived, given that *age* on its own means ‘some, (an)other’?

I will motivate an account of this pattern according to which the quantifier *tugul* heads a QP and is sister to an individual-denoting DP, i.e., a DP of type *e* (as Matthewson 2001 argues for quantificational nominals in Lillooet Salish):

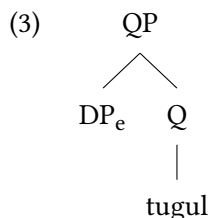

Further, *age* is an indefinite determiner that denotes a variable over Skolemized choice functions (as in Kratzer 1998; see also Reinhart 1997; Winter 1997; Matthewson 1999; 2001; among many others); *age* thus attaches to an NP of type  $\langle e, t \rangle$  and yields a DP of type *e*, in effect creating a suitable argument for *tugul* and restricting its domain (as in Matthewson’s (2001) analysis of Salish):<sup>3</sup>

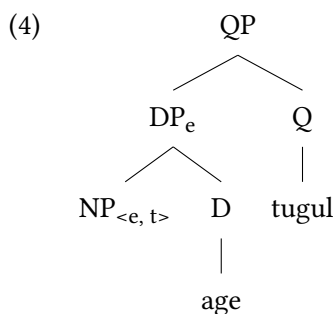

<sup>3</sup>I thank the anonymous reviewers for suggesting an analysis of *age* along these lines.

Singular nouns on their own are of the basic predicative type <e, t> and so cannot serve as arguments to *tugul*.<sup>4</sup>

This paper thus contributes to the growing body of work on quantification in African languages, as well as across languages more generally, by (a) providing a description of the structure and interpretation of nominal quantification in Kipsigis, which to my knowledge has not previously been published; (b) presenting a compositional analysis of those structures; and (c) discussing how the Kipsigis patterns relate to previous crosslinguistic work on quantification.

The remainder of this paper is organized as follows. In §2, I provide relevant background on the structure of Kipsigis. In §3, I discuss the syntax and semantics of bare nouns, and in §4, I present a compositional account of quantificational nominals. Finally, §5 concludes the paper.

## 2 Background on Kipsigis

The basic word order of Kipsigis is verb initial, with both VSO and VOS occurring as possible variants:<sup>5,6</sup>

- (5) a. ko-e      Kiprono peek      (VSO)  
       pst-drink Kiprono water  
       ‘Kiprono drank water.’
- b. ko-e      peek Kiprono      (VOS)  
       pst-drink water Kiprono  
       ‘Kiprono drank water.’

Within nominals, the head noun appears first. Nouns are inflected for number, and demonstratives (6a) and possessives (6b) appear as suffixes on the head noun:

- (6) a. ko-ibut lakwa-ni      (demonstrative)  
       pst-fall child.sg-this  
       ‘This child fell.’

<sup>4</sup>As I will show in §3, bare singular nouns appear in argument positions, where they permit definite interpretations; because definite singulars are standardly taken to denote individuals, they may incorrectly be expected to occur with *tugul*. I address this point in §4.

<sup>5</sup>Kipsigis nominals are case-marked by tone, where subjects bear a lower tone than their non-subject counterparts (Jake & Odden 1979; see also Creider & Creider 1989; Creider 2003 for the closely related dialect Nandi). I leave out tone in my transcriptions here.

<sup>6</sup>See Bossi & Diercks to appear for a description and analysis of Kipsigis word order.

- b. ko-ibut lakwe-nyin (possessive)  
PST-fall child.SG-her  
'Her child fell.'

Adnominal modifiers must follow the head noun, as (7) shows for various types of modifiers (*viz.*, a quantifier, numeral, possessive phrase, and relative clause):

- (7) ru-e lagok somog-u ap Kiprono tugul ne-mingen  
sleep-PRS child.PL three-NOM of Kiprono all REL-small  
'All three of Kiprono's children that are small are sleeping.'

Postnominal word order is highly flexible, so that the modifiers in (7), for example, may occur in any order with respect to one another.

### 3 Bare nouns

This section discusses the syntax and semantics of bare nouns in Kipsigis; this is a necessary step in understanding the composition of quantificational nominals, because bare nouns serve as building blocks for them. I look at the various interpretations of bare nouns in §3.1 and discuss the semantic contribution of number in §3.2.

#### 3.1 Indefinite, definite, and generic interpretations

Bare nouns (both singular and plural) appear in argument positions, where they permit indefinite, definite, and generic interpretations.

There is a long-standing debate regarding how to semantically characterize definiteness (see, among many others, Frege 1997[1892], Russell 1998[1905], Heim 1982, and Schwarz 2009). I will assume here that definites have two characteristic properties: (a) they are felicitous only in contexts in which their referents are both familiar and unique, and (b) they are scopeless with respect to quantifiers (such as negation). Indefinites, in contrast, are felicitous in novel, nonunique contexts, and can interact scopally with other quantifiers.

With respect to these properties, bare nouns in Kipsigis allow both definite and indefinite interpretations.<sup>7</sup> Bare nouns are felicitous in both novel and familiar contexts:<sup>8</sup>

<sup>7</sup>For reasons of space, I omit examples with bare plurals in (8) though (14); however, the patterns observed for bare singulars in these examples also hold for bare plurals.

<sup>8</sup>The examples in (8) and (9) are modeled after the tests for bare nouns in Gillon (2015).

- (8) a. enkeny-ko ki-mi kirowgindet (novel)  
 long-ago there-was chief.SG  
 ‘Long ago there was a chief.’  
 b. ki-chamat kirwogindet piik (familiar)  
 PASS-like chief.SG person.PL  
 ‘The chief was liked by the people.’

Bare nouns are also felicitous in both nonunique and unique contexts:

- (9) a. [Context: There are two identical cups in the cupboard.]  
 konon kikombet (nonunique)  
 give.IMP cup.SG  
 ‘Give me a cup!’  
 b. [Context: There is just one cat and one dog, and they are fighting.]  
 ko-suger ngokta ak paget agoi ko-labat paget (unique)  
 PST-fight dog.SG and cat.SG until PST-run.away cat.SG  
 ‘The dog and the cat fought until the cat ran away.’

Bare nouns also appear in sluicing constructions, again indicating that they permit (existential) indefinite interpretations (see Chung et al. 1995 and Reinhart 1997):

- (10) ko-ger lakwet, kobaten mongen ale ainon  
 PST-see child.SG but NEG-know.1SG COMP which  
 ‘She saw a child, but I don’t know which.’

Bare nouns also permit both narrow-scope and scopeless interpretations with respect to negation. For example, given the context set by (11), the continuation in (12) is ambiguous (examples modeled after Matthewson 2001). On one reading, (12a), *kitabut* ‘book.SG’ is scopeless; in this case, *kitabut* corefers with the previously mentioned book (i.e., it is interpreted as a definite). On a second reading, (12b), *kitabut* scopes below negation (i.e., it is interpreted as a narrow-scope existential indefinite).

- (11) ko-tach Kipto kitabut ak chaik  
 PST-receive Kipto book.SG and tea  
 ‘Kipto received a book and tea.’

- (12) mo-cham kitabut  
NEG-like book.SG  
a. 'She doesn't like the book.' (scopeless)  
b. 'She doesn't like books.' (Neg > ∃)

In fact, Kipsigis, like many other languages, has no nominal expression corresponding to the English determiner *no*; instead, nominal negation can be expressed using a bare noun in combination with verbal negation, further illustrating that bare nouns permit narrow-scope existential interpretations:

- (13) ma-ibut chita  
NEG-fall person.SG  
'No one fell.'

Kipsigis bare nouns do not, however, permit wide-scope existential interpretations (i.e., they are nonspecific indefinites). For example, (14) can only be interpreted as in (14a), where the second instance of *chita* 'person' scopes below negation (my consultant reported (14a) as "contradictory", but as the only interpretation available); in contrast, (14b), in which the second instance of *chita* 'person' scopes above negation, is not an available interpretation.

- (14) ko-ibut chita      ako ma-ibut chita  
PST-fall person.SG and PST-fall person.SG  
a. 'Someone fell and no one fell.' (Neg > ∃)  
b. \*'Someone fell and someone (else) did not fall.' (\*∃ > Neg)

Finally, in addition to definite and nonspecific indefinite interpretations, singular and plural bare nouns can also be interpreted generically:

- (15) a. tinye paget saroriet  
have cat.SG tail.SG  
'A cat has a tail.'  
b. tinye pagok sarurek  
have cat.PL tail.PL  
'Cats have tails.'

To account for the various (i.e., definite, nonspecific indefinite, and generic) interpretations of bare nouns, I will assume – as is standard – that bare nouns have the basic predicative type <e, t>. Different semantic mechanisms (i.e., type



shifting rules or modes of composition) then derive their different interpretations. Specifically, to derive nonspecific indefinite interpretations, bare nouns may combine with a transitive verb via predicate restriction (Chung & Ladusaw 2004; see also Carlson 1977). To derive definite interpretations, bare nouns may be type-shifted via iota-shift (Partee 1987). Finally, to yield generic interpretations, bare nouns may be bound by a covert generic operator (Krifka 1995).

### 3.2 The interpretation of number

This section provides background on the number interpretation of bare nouns. Plural nouns in Kipsigis appear to be number-neutral (i.e., compatible with a singular or plural interpretation; see Link 1983 and Corbett 2000), as the question in (16a) can be answered with either a singular or plural (16b) (diagnostic from Link 1983):

- (16) a. ko-ger tuga i  
       PST-see COW.PL Q  
       Q: ‘Did he see cows?’  
       b. ee, ko-ger {teta agenge / tuga somog}  
           yes, PST-see {COW.SG one / COW.PL three}  
       A: ‘Yes, he saw {one cow/three cows}.’

In contrast, singular nouns are not number-neutral, but rather necessarily semantically singular. For example, singular nouns are ungrammatical in combination with numerals greater than one:

- (17) \*rue lakwet somog-u  
       sleep child.SG three-NOM

Given these observations, I will adopt a semantic analysis of number in Kipsigis as in Link 1983, whereby a singular noun denotes a set of atomic individuals (atoms), and a plural noun denotes a set of both atomic and plural individuals.

## 4 Quantificational nominals

### 4.1 The universal quantifier *tugul*

Returning now to the patterns observed for universally quantified nominals observed in §1, recall that the quantifier *tugul* expresses universal quantification:

- (1) ru-e lagok tugul  
sleep-PRS child.PL all  
'All the children are sleeping.'

In the following two subsections, I present a syntax (§4.1.1) and semantics (§4.1.2) for *tugul*.

#### 4.1.1 The syntax of *tugul*

I adopt the following syntax for *tugul*, in which it heads a QP and is sister to DP:

- (18) [QP DP [Q *tugul*]]

Evidence that *tugul* is sister to DP comes from (19), which shows that *tugul* may combine directly with a pronoun; pronouns are standardly taken to be DPs, as they appear on their own in argument positions.

- (19) ko-gitiense echek tugul  
PST-sing[1PL] we all  
'All of us sang.'

In addition, *tugul* may appear on its own, as long as the reference of the head noun is clear from the context:

- (20) ko-ger tugul  
PST-see all  
'He saw all.'

These facts suggest that *tugul* licenses DP ellipsis (in contrast, NP ellipsis appears to be ungrammatical in Kipsigis, as I show in §4.2.2).

#### 4.1.2 The semantics of *tugul*

Descriptively, *tugul* is a nondistributive universal quantifier (i.e., it permits both distributive and collective interpretations). Consider (21), for example, which is ambiguous between a distributive and collective reading:

- (21) ko-yot bokisinik somok lagok tugul  
 PST-lift box.PL three child.PL all
- a. ‘The children each lifted three boxes.’ (*distributive*)  
 b. ‘The children collectively lifted three boxes.’ (*collective*)

The semantics of *tugul* can accordingly be modeled as a function that maps an individual (the denotation of DP) to a generalized quantifier (the denotation of QP; as in Matthewson 2001):<sup>9</sup>

$$(22) \llbracket \textit{tugul} \rrbracket = \lambda x_e . \lambda f_{\langle e, t \rangle} . \forall y [y \leq x \rightarrow f(y)]$$

This semantics for *tugul* allows for both distributive and collective interpretations, as the subpart relation ( $\leq$ ) holds for atoms as well as collections. A distributive interpretation results when *tugul* quantifies over atomic subparts of the individual denoted by DP, and a collective interpretation results when there is only one subpart (i.e.,  $x = y$ ).

The proposed syntax and semantics for *tugul* explains why *tugul* cannot combine directly with a singular noun, as observed in §1:

- (23) \* ru-e lakwet tugul  
 sleep-PRS child.SG all  
 ‘Every child is sleeping.’

At the NP level, a singular noun has neither the right syntax (it is not a DP) nor semantics (it is not of type *e*) to combine with *tugul*.<sup>10</sup>

## 4.2 The morpheme *age*

As also observed in §1, *tugul* can combine with a singular nominal just in case the morpheme *age* is also present:

- (24) ru-e lakwet \*(age) tugul  
 sleep-PRS child.SG \*(some.SG) all  
 ‘Every child is sleeping.’

<sup>9</sup>This formalism comes directly from Zimmermann (2014), which is based on Matthewson (2001).

<sup>10</sup>However, as shown in §3, bare singulars permit definite interpretations, and so the analysis may incorrectly predict that a bare singular that is type-shifted to a definite could serve as an argument to *tugul*. I will assume that the combination of a definite singular with *tugul* is ruled out on pragmatic grounds: Attaching *tugul* to a definite singular would result in universal quantification over a single individual, which is equivalent to the denotation of the definite.

The plural form of *age*, namely, *alak*, may also occur with *tugul*, in which case quantification is over groups (or kinds):

- (25) ru-e lagok alak tugul  
sleep-PRS child.PL some.PL all  
'All (or any groups of) children are sleeping.'

Both *age* and *alak* translate as 'some, (an)other' when used on their own:<sup>11</sup>

- (26) a. ko-bua lakwet age  
PST-come.by child.SG some.SG  
'Some/another child came by.'  
b. ko-bua lagok alak  
PST-come.by child.PL some.PL  
'Some/other children came by.'

This raises the question of what the semantic and syntactic contribution of *age* is, to allow *tugul* to combine with a singular DP and yield a universal (and in some cases free-choice) interpretation. In the following two subsections, I will present evidence that *age* is semantically an indefinite (§4.2.1) and syntactically a determiner (§4.2.2).

#### 4.2.1 The semantics of *age*

There are several ways in which *age* behaves semantically like an indefinite (tests for indefiniteness are from Matthewson 1999). First, *age* permits sluicing:

- (27) ko-ger lakwet age, kobaten mo-ngen ale ainon  
PST-see child.SG some.SG, but NEG-know[1.SG] COMP which  
'She saw another child, but I do not know which.'

Second, *age* may introduce new discourse referents:

- (28) ko-bua chita age  
PST-come.by person.SG some.SG  
'Some/another person came by.'

---

<sup>11</sup>Because *alak* is simply the plural form of *age*, I will henceforth use *age* to refer to both *age* and *alak*, unless otherwise noted.

Third, *age* interacts scopally with other quantifiers, such as modals and negation. Unlike bare nouns, *age* permits both narrow- and wide-scope existential interpretations with respect to negation.<sup>12</sup>

- (29) ko-bua piik alak ako ma-bua piik alak  
 PST-come.by person.PL some.PL and NEG-come.by person.PL some.PL  
 a. ‘Some people came by and no other people came by.’ (Neg >  $\exists$ )  
 b. ‘Some people came by and other people did not come by.’ ( $\exists$  > Neg)

Interestingly, *age* only permits narrow-scope interpretations with respect to modals; for example, (30) only permits the narrow-scope interpretation in (30a) (cf. the wide-scope interpretation in (30b)).

- (30) [Context: Kipto wants to marry Kiprono.]  
 moch-e ko-tun chepkeleliot age  
 want-PRS INF-marry girl.SG some.SG  
 a. ‘He wants to marry another girl (it doesn’t matter who).’  
 b. \*‘He wants to marry another girl in particular (say Chepto).’

Summarizing, these examples suggest that *age* is an indefinite that permits both narrow-scope (i.e. nonspecific) interpretations and, unlike bare nouns, wide-scope existential interpretations (at least with respect to negation). It should be noted, however, that there are some uses of *age* that appear to be definite, as the referent of an *age*-DP may be familiar:

- (31) [Context: Two children came by.]  
 angen lakwet agenge, ako m-angen lakwet age  
 know[1.SG] child.SG one, and NEG-know[1.SG] child.SG some.SG  
 ‘I knew one child but I did not know the other child.’

Such examples may indicate that *age* is not an indefinite determiner, but rather an adnominal modifier positioned within a bare plural that, like other bare plurals, permits indefinite or definite interpretations. What, then, would be the semantic contribution of *age*? As already noted, *age* is associated with free-choice interpretations, as my consultant often offered ‘any’ as a translation for *age* in

<sup>12</sup>It is possible that the wide-scope interpretation here is actually a definite interpretation; see the discussion of definite interpretations for *age* below.

combination with *tugul*.<sup>13</sup> If free-choice interpretations are derived via domain widening (as in Kadmon & Landman 1993 and Kratzer & Shimoyama 2002, among others), then *age* may be widening the domain of the NP it modifies; *tugul* then quantifies over the widened domain. However, an analysis that treats *age* as a modifier within a bare plural would fail to account for the apparent wide-scope existential interpretations available to *age*, as in (29b), which bare plurals do not permit.<sup>14</sup> I conclude that *age* encodes indefiniteness (and allows wide-scope existential interpretations) and set aside its definite and free-choice interpretations as issues for future research.

As an indefinite, *age* can be analyzed semantically as introducing a variable over Skolemized choice functions (as in Kratzer 1998). A choice function is a function that maps a nonempty set of individuals to a unique individual in that set (Reinhart 1997). A Skolemized choice function has an additional implicit argument. Thus, *age* (henceforth represented as  $age_i$ , where the subscript  $i$  represents its implicit argument) maps an individual (its implicit argument) to a function from a nonempty set (the denotation of NP) to an individual (the denotation of DP). More specifically (i.e., taking into account the contribution of number), *age* maps a singular NP to an atom, whereas *alak* maps a plural NP to an atomic or plural individual.

---

<sup>13</sup>The free-choice interpretation of *age* in combination with *tugul* is made clear in *yes-no* questions. Consider, e.g., (i), which is ambiguous: This question can ask whether all of the children sang (a universal interpretation) or whether any of the children sang (a free-choice interpretation). In contrast, *tugul* on its own can only be interpreted as a non-free-choice universal, as in (ii).

- (i) ko-tien lakwet age tugul i?  
PST-sing child.SG some.SG all Q  
'Did {every/any} child sing?'
- (ii) ko-tien lagok tugul i?  
PST-sing child.PL all Q  
'Did all the children sing?'

<sup>14</sup>In addition, an anonymous reviewer points out that the 'other' interpretation is a pervasive feature of indefinites across West Chadic (see Zimmermann 2008 for Hausa, and Grubic 2015 for Ngamo).

4.2.2 The syntax of *age*

I adopt the syntax in (32) for *age*, in which it heads a DP and is sister to NP:

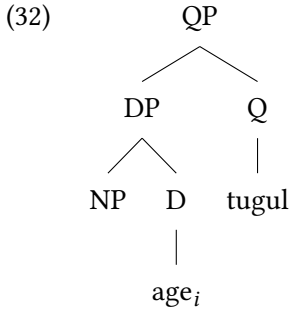

Evidence that *age* forms a subconstituent with NP within QP (to the exclusion of *tugul*) comes from (33a), which shows that *age* must precede *tugul*; other modifiers, such as numerals, may precede or follow *tugul*, (33b).<sup>15</sup>

- (33) a. \* ru-e lakwet tugul age  
           PST-come.by child.SG all some.SG
- b. ko-bua lagok {somog-u tugul / tugul somog-u}  
       PST-come.by child.PL {three-NOM all / all three-NOM}  
       ‘All three children came by.’

There is also some evidence that *age*, at least when combined with *tugul*, occupies a determiner position. Unlike *tugul*, *age* may not attach to a pronoun:<sup>16</sup>

- (34) \* ko-gitiense ecek {age/alak} tugul  
       PST-sing[1PL] we {some.SG/some.PL} all

<sup>15</sup>Note also that no modifiers may intervene between *age* and *tugul* (e.g., \**lagok alak somogu tugul* lit. ‘child.PL some.PL three all’).

<sup>16</sup>However, in the absence of *tugul*, *alak*, but not *age*, may attach to a pronoun:

- (i) ko-gitiense ecek alak  
       PST-sing[1PL] we some.PL  
       ‘Some of us sang.’

Because this is a partitive, *alak* may in this case be in a different, higher syntactic position than it is when it appears with *tugul*, permitting it to combine with a pronoun.

Furthermore, in combination with *tugul*, *age* may not appear on its own, without the head noun:<sup>17</sup>

- (35) \* ko-ger {age/alak} tugul  
 PST-see {some.SG/some.PL} all

These facts (i.e., that *age* must precede *tugul* and cannot combine with a pronoun or occur on its own when combined with *tugul*) are explained if *age* is (a) in a lower position syntactically than *tugul* and (b) a determiner, on the grounds that like the English determiners *a* and *the*, *age* cannot license NP ellipsis.

### 4.3 The semantic composition of nominals containing *age* and *tugul*

Having established a syntax and semantics for both *age* and *tugul*, consider again a nominal that contains both:

- (36) a. lakwet age<sub>i</sub> tugul  
 child.SG some.SG all  
 ‘every child’

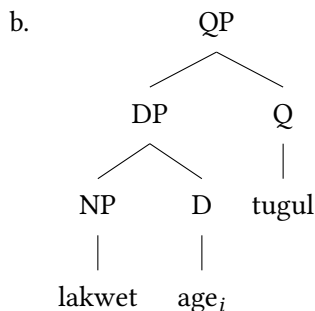

The semantic composition of such nominals would be computed as follows: The quantifier *tugul* binds the implicit argument of the choice function denoted by *age*. In effect, for any value for the implicit argument, the choice function output

<sup>17</sup>However, here too, in the absence of *tugul*, *age* may occur on its own (as long as the reference of the head noun is clear from the context):

- (i) ko-ger {age/alak}  
 PST-see {some.SG/some.PL}  
 ‘He saw {another/others}.’



for that argument satisfies the NP predicate. This derives universal quantification over atoms in the case that *tugul* attaches to a (singular) *age*-DP, and quantification over atomic or plural individuals (i.e., groups) in the case that *tugul* attaches to a (plural) *alak*-DP.

This semantics thus predicts that when *tugul* combines with an *age*-DP, only a distributive interpretation is possible (because quantification occurs over atoms), and, indeed, only distributive interpretations are possible in this case:

- (37) ko-yot bokisinik somok lakwet age tugul  
 PST-lift box.PL three child.SG some.SG all
- a. ‘Each child lifted three boxes.’ (*distributive*)
- b. \*‘All the children collectively lifted three boxes.’ (*collective*)

In contrast, when *tugul* combines with an *alak*-DP, quantification may occur over atomic or plural individuals, producing distributive or collective interpretations:

- (38) ko-yot bokisinik somok lagok alak tugul  
 PST-lift box.PL three child.PL some.PL all
- a. ‘Each child lifted three boxes.’ (*distributive*)
- b. ‘All (or any groups of) of the children collectively lifted three boxes.’  
 (*collective*)

#### 4.4 Summary of the analysis

Summarizing, *tugul* heads a QP and combines with a DP of type *e*. As a result, *tugul* may attach to a pronoun and appear on its own (i.e., it licenses DP ellipsis), and may not attach to a predicative singular noun nor, for pragmatic reasons, a singular definite. *Age* is an indefinite determiner that heads a DP and denotes a Skolemized choice function that, relative to an implicit argument, maps an NP of  $\langle e, t \rangle$  to a DP of type *e*. The resulting *age*-DP may then attach to *tugul*, which binds the implicit argument of *age*, resulting in universal quantification.

## 5 Conclusion

This paper has presented a compositional analysis of quantificational nominals in the Nilotic language Kipsigis. In short, *tugul* is a nondistributive universal quantifier that heads a QP and combines with a DP of type *e* to create a generalized quantifier (as in Matthewson’s (2001) analysis of Salish). The morpheme *age* is an

indefinite determiner that denotes a variable over Skolemized choice functions (as in Kratzer 1998; see also Matthewson 1999; 2001); *age* thus combines with a predicative NP to create a DP of type *e*, and this DP can combine with *tugul*. Future research may shed light on the free-choice and definite interpretations observed for *age*, which remain open questions here.

## Abbreviations

PST	past	SG	singular
PRS	present	PL	plural
NEG	negation	COMP	complementizer
NOM	nominative	Q	question marker

In the orthographic conventions used here, *ch* represents a voiceless palatal affricate [tʃ], *ny* a palatal nasal [ɲ], *ng* a velar nasal [ŋ], and *y* a palatal glide [j].

## Acknowledgments

I am very grateful to my Kipsigis consultant, Robert Kipkemoi Langat, for his diligent work on this project. Many thanks also to the two anonymous reviewers, who provided extensive feedback on a previous draft of this paper. Thanks also to Michael Diercks, Mary Paster, and the audience at *ACAL 47* at Berkeley for helpful questions and comments. All mistakes are my own.

## References

- Bossi, Madeline & Michael Diercks. to appear. V1 in Kipsigis: Head movement and discourse-based scrambling. *Glossa*.
- Carlson, Gregory N. 1977. *Reference to kinds in English*. University of Massachusetts, Amherst. (Doctoral dissertation).
- Chung, Sandra & William A. Ladusaw. 2004. *Restriction and saturation*. Cambridge: MIT Press.
- Chung, Sandra, William A. Ladusaw & James McCloskey. 1995. Sluicing and Logical Form. *Natural Language Semantics* 3(3). 239–282.
- Corbett, Greville G. 2000. *Number*. Cambridge: Cambridge University Press.
- Creider, Chet. 2003. The semantics of participant types in derived verbs in Nandi. *Revue quebecoise de linguistique* 31. 171–196.

- Creider, Chet & Jane Creider. 1989. *A grammar of Nandi*. Hamburg: Helmut Buske Verlag.
- Frege, Gottlob. 1997[1892]. On sense and reference. In *Readings in the philosophy of language*. Cambridge: MIT Press.
- Gillon, Carrie. 2015. Investigating D in languages with and without articles. In M. Ryan Bochnak & Lisa Matthewson (eds.), *Methodologies in semantic fieldwork*, 175–203. Oxford: Oxford University Press.
- Grubic, Mira. 2015. *Focus and alternative semantics in Ngamo (West Chadic)*. University of Postdam. (Doctoral dissertation).
- Heim, Irene. 1982. *The semantics of definite and indefinite noun phrases*. Amherst: University of Massachusetts, Amherst. (Doctoral dissertation).
- Jake, Janice & David Odden. 1979. Raising in Kipsigis. *Studies in the Linguistic Sciences* 9(2). 131–155.
- Kadmon, Nirit & Fred Landman. 1993. Any. *Linguistics and Philosophy* 16(4). 353–422.
- Kratzer, Angelika. 1998. Scope or pseudo-scope? Are there wide-scope indefinites? In Susan Rothstein (ed.), *Events in grammar*, 163–196. Dordrecht: Kluwer.
- Kratzer, Angelika & Junko Shimoyama. 2002. Indeterminate pronouns: The view from Japanese. In Yukio Otsu (ed.), *Proceedings of the Tokyo conference on psycholinguistics*, vol. 3, 1–25. Tokyo: Hituzi Syobo.
- Krifka, Manfred. 1995. Genericity: An introduction. In Gregory N. Carlson & Francis Jeffrey Pelletier (eds.), *The generic book*, 1–124. Chicago: University of Chicago Press.
- Link, Godehard. 1983. The logical analysis of plural and mass terms: A lattice theoretic approach. In Rainer Bäuerle, Christoph Schwarze & Arnim von Stechow (eds.), *Meaning, use, and interpretation of language*, 302–323. Berlin: de Gruyter.
- Matthewson, Lisa. 1999. On the interpretation of wide scope indefinites. *Natural Language Semantics* 7. 79–134.
- Matthewson, Lisa. 2001. Quantification and the nature of crosslinguistic variation. *Natural Language Semantics* 9. 145–189.
- Partee, Barbara H. 1987. Noun phrase interpretation and type-shifting principles. In Jeroen Groenendijk, Dick de Jong & Martin Stokhof (eds.), *Studies in discourse representation theory and the theory of generalized quantifiers*, 115–143. Dordrecht: Foris Publications.
- Reinhart, Tanya. 1997. Quantifier-scope: How labor is divided between QR and choice functions. *Linguistics and Philosophy* 20. 335–97.

- Russell, Bertrand. 1998[1905]. On denoting. In Gary Ostertag (ed.), *Definite descriptions: A reader*, 35–49. Cambridge: MIT Press.
- Schwarz, Florian. 2009. *Two types of definites in natural language*. University of Massachusetts Amherst. (Doctoral dissertation).
- Winter, Yoad. 1997. Choice functions and the scopal semantics of indefinites. *Linguistics and Philosophy* 20. 399–467.
- Zimmermann, Malte. 2008. Quantification in Hausa. In Lisa Matthewson (ed.), *Quantification: A cross-linguistic perspective*, 415–475. Bingley: Emerald Group Publishing.
- Zimmermann, Malte. 2014. *Universal and existential quantification in Chadic and beyond*. Plenary talk presented at the Annual Conference on African Languages 45, University of Kansas, April 2014.

## Chapter 26

# Stem modification in Nuer

Irina Monich

University of Surrey

Matthew Baerman

University of Surrey

Nuer is a Western Nilotic language remarkably rich in non-concatenative morphology. This article provides a comprehensive description of those morphological processes in Nuer that are responsible for variations in the form of the stem. Our data shows that all stem-modifying operations have one of the following four targets in the stem: stem vowel quality and quantity, tonal melody, and properties of the stem-final consonant. The vowel quality modification is comprised of two separate processes where either lowering and removal of breathiness is applied or raising and addition of breathiness. Thus, vowel quality modification yields two separate series of mutated vowels. We provide arguments for treating some vowels as basic, while others as derived. We also identify tonal patterns found in verbal morphology, and three types of morphologically triggered consonantal lenition. According to our findings, exactly the same processes apply in both the nominal and the verbal system.

## 1 Introduction

Nuer is a Western Nilotic language of the Nilo-Saharan language family with almost 900,000 speakers worldwide. It is part of Dinka-Nuer language cluster which also includes Thok Reel.

Nuer has attracted attention for the complexity of its nominal inflection, which employs a baffling variety of forms in a seemingly chaotic lexical and paradigmatic distribution (Frank 1999; Baerman 2012). Table 1 offers a taste of this, showing a small sample of the various schemes of affixation and stem modification



displayed by different nouns. (All examples in this paper come from our own fieldwork.)

Table 1: A sample set of nominal paradigms (Western variety, Bentiu)

NOM SG	GEN SG	LOC SG	NOM PL	GEN/LOC PL	Gloss
kèɛet	kèɛɛd-ḏ			kèɛɛd-ní	‘stick’
têṙ	têṙ-ḏ		tét	téet	‘hand’
kḵaaay	kḵah	kḵh	kḵah	kḵay-nì	‘hole’
kíir	kíɛɛr	kíiir	kíer	kíer-ì	‘big river’

An obvious requirement for understanding this system is to isolate the morphological devices involved, no mean feat given its high degree of lexical idiosyncrasy. In this paper we set out to do this, focusing on the system (or systems) of stem modification. The key to this lies in verbal morphology, which employs the same devices found in nominal inflection – manipulation of quality, quantity and tone of the stem vowel and manner of articulation of the stem-final consonant – but with a high degree of regularity and predictability. Further, by doing this we can show that there are two distinct kinds of vowel quality modifying processes. One is primarily a lowering process, and is associated with case-number inflection in nouns and person-number inflection in verbs. The other involves vowel raising, and is associated with number inflection in nouns and derivation in verbs.

Language consultants used for this study are all native speakers of Nuer. Of the ten consultants, four are representative of the Western variety of Nuer (Bentiu), and the other six are speakers of the Eastern dialect of Nuer (Jikany<sup>1</sup>). All currently reside outside of South Sudan (UK and USA) but use Nuer on a daily basis within their communities.

The major prior source on Nuer is Crazzolaro (1933). Other notable previous works include Vandevort (n.d.)’s draft pedagogical grammar, and Frank (1999) and Storch (2005) on noun morphology. The transcription of data in these sources is often inconsistent, especially in regards to the subtle contrasts of vowel quality

<sup>1</sup>One of our Jikany Nuer consultants spent his formative years in Akobo area of South Sudan; the other five originate from Nasir. The variety of Nuer spoken by the Akobo native does not appear to be different from that spoken by other Jikany Nuer consultants. By contrast, differences between the Eastern (Jikany) and Western (Bentiu) dialects are clearly defined in several areas of grammar. Therefore, we indicate throughout this article whether data comes from Eastern or Western variety of Nuer, without drawing further dialectal distinctions.

and tone. Since much of morphological contrasts in Nuer are signaled by manipulation of precisely these properties, errors in data transcription make it difficult to arrive at phonological operations that are at the heart of Nuer morphology. Before we can truly evaluate the complexity of Nuer verbal and nominal systems, it is essential to establish the basic phonological alternations that play such an important role in Nuer grammar.

More recent work on Nuer includes Gjersøe (2016; 2017) on tone, Reid (forthcoming) on verbal morphology, Faust (2017) on vowel alternations in adjectival reduplication, and Faust & Grossman (2015) which provides general overview of the grammar of a Jikany variety from Nasir. Some of the findings reported here contradict or overlap with the findings in these works. The vowel correspondences are generally aligned with the ones identified by Faust (2017) and Faust & Grossman (2015) but with some important differences mainly involving documentation of breathiness and diphthongization. The tonal inventory that we identify here is richer than the one proposed in Gjersøe (2016; 2017), and it allows for more precise classification of tonal patterns. Where applicable, significant divergences between these works and ours will be pointed out throughout this article.

## 2 Basics of Nuer phonology

Both varieties of Nuer discussed here distinguish (at least) fifteen vowel phonemes, shown in Figure 1a. Most of these constitute part of a modal/breathy pair (breathiness is indicated by two dots underneath the first grapheme of a vowel). Except for the high mid range, the breathy counterpart is typically somewhat higher in the vowel space. There are also four pairs of modal/breathy diphthongs (Figure 1b). Although we do not indicate it for typographical reasons, non-breathy vowels /i, u/ are [-ATR] while breathy vowels /i̥, u̥/ are [+ATR]

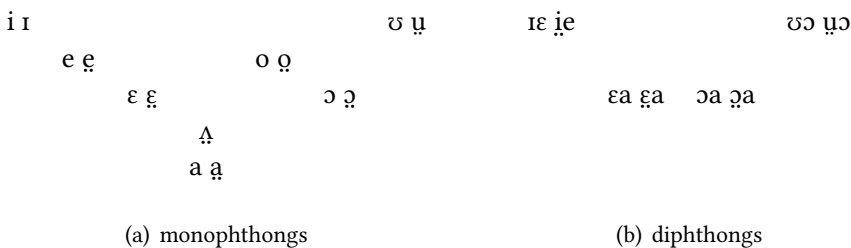

Figure 1: Nuer vowel inventory

Even though the vowels listed in Fig 1 are all contrastive in Nuer, we argue here that they do not all have equal status in Nuer grammar. Only vowels /a, ɔ, ɔ, ɛ, ɛ, ɔ, ɛ, i, i, u, u/ are found in the morphologically “basic” form of the root. All diphthongs, as well as monophthongs /a, e, o/, emerge as a result of morphological modification of the stem. These vowels are produced when affixes consisting of floating features superimpose on the vowel of the stem, modifying its properties. Consequently, they signal morphological rather than lexical contrasts.

Both diphthongs and monophthongs occur in three degrees of length: short, long, and overlong, represented here by three vowel graphemes, plus onglide in the case of diphthongs. Breathiness is indicated on the first grapheme alone. There are two lexically specified tones: H and L. Rising and falling tones also occur but their appearance is either phonologically conditioned or results from combination of H and L tones. Falling and high tones are neutralized depending on the phonation of the vowel: if the vowel is breathy, the falling and high tones are both realized as high, while over modal vowels the two tones are both realized as falling. Rising tones emerge as a result of fissure of spread H-tones into L and H (also applies to adjacent H-tones in the same word). In other words, there is a rule  $HH \rightarrow LH$  that takes place word-internally.<sup>2</sup> As with breathiness, tone is indicated on the first grapheme of a multi-graphemic vowel representation.

The consonantal inventory of Nuer is shown in Table 2. In intervocalic position the stem-final consonants tend to become voiced. The phonemes in parenthesis are only contrastive in stem-final position in some varieties of Western Nuer.

### 3 Verbal inflection

#### 3.1 Overview

We focus here on inflection for subject person-number, which occurs in the Present Imperfect Positive Tense when used with a preverbal subject. A sample paradigm is provided in Table 3, including other forms which we will discuss below only in passing.

---

<sup>2</sup>Full justification for positing this rule cannot be offered here due to space limitations. One supporting piece of evidence is that before high-toned suffixes, the tone over a short intransitive stem can only be low or rising. At the same time, before low-toned suffixes, the tone of the intransitive stem may be either high or low. This state of affairs can be accounted for assuming that short roots are lexically specified as L or H, and that these lexical tones appear as such before low-toned suffixes. However, before H-toned suffixes the H of the stem breaks into yielding a rising tone. Such analysis also allows for a better understanding of derivation of tonal melodies in transitive stems in §3.3.



Table 2: Consonantal phonemes

	Labial	Dental	Alveolar	Palatal	Velar
Voiceless stops	p	t̪	t	c	k
Voiced stops	b	d̪	d	ɟ	g
Fricative	(f)	(θ)	(r)	(ç)	(h)
Nasal	m	ɱ	n	ɲ	ŋ
Lateral			l		
Trill			r		
Glides	w			j	ɣ

Table 3: ‘beat (the drum).TR’

	Singular	Plural	Other forms
1	pɔ̌aaad-ɔ̌	pɔ̌aɾ-kɔ̌	NF1 pɔ̌ɾ
1+2(incl)		pɔ̌aɾ-nê	
2	pɔ̌ɔ̌ɔ̌d-ɔ̌	pɔ̌aɾ-ê	NF2 pɔ̌t
3	pɔ̌ɔ̌ɔ̌d-ê	pɔ̌aɾ-kê	NSF pɔ̌t

(Western Nuer). NF1 = non-finite form used with perfect auxiliaries; NF2 = non-finite form used with a present negative auxiliary; NSF = non-suffixed form used with a post-verbal suffix.

Besides bearing different inflectional suffixes, the individual forms are distinguished by various stem alternations<sup>3</sup>, involving length, vowel quality, tone, and the stem-final consonant. In the next several sections we review these processes in turn.

### 3.2 Vowel quality modification

The system of vowel quality modification involves a two-way contrast which we designate here as Grade 1 vs. 2/A vs. B (Table 4). The system of vowel grades adopted here is almost identical to the one presented by Reid & Baerman (2017).

<sup>3</sup>The term “stem” is used here to label the portion of the word with the exclusion of inflectional suffixes. Since there are no segmental derivational suffixes, the stem incorporates all derivational morphology.

Table 4: Morphological stem vowel grades in Nuer

Grade 1		Grade 2	
Grade A	Grade B	Grade A	Grade B
i	iɛ	ᵢ	ᵢɛ
ɛ	ɛa	ɛ̥	e
–	–	ɛ̥	ɛ̥a
a	a	ʌ̥	ʌ̥
ɔ	ɔa	ɔ̥	o
–	–	ɔ̥	ɔ̥a
u	uɔ	u̥	u̥ɔ

The grades correspond to phonological contrasts. Thus most Grade 1 vowels are modal, while Grade 2 vowels are breathy, and raised with respect to their Grade 1 counterparts. The Grade A~B alternation for most vowels involves lowering which, wherever possible, yields an opening diphthong; however, in case of the Grade A vowels /ɛ̥/ and /ɔ̥/ we see instead the removal of breathiness to yield Grade B.<sup>4</sup>

The two sets of alternations have a clear division of labor in the verbal system. Grade 1 vowels are found in underived verbs, while Grade 2 vowels are found with many derived verbal categories. The Grade A~B alternation takes place *within* the paradigms of individual verbal lexemes, e.g. between different subject person-number values. The distribution of Grade A and B differs depending on whether the verb is transitive or intransitive: Grade A is used in 2/3SG of all verbs, and additionally in 3PL of intransitive verbs, while Grade B is used elsewhere.<sup>5</sup> The basic template of the two vowel quality modification types is illustrated in Table 5 and exemplified in Table 6.

The motivation for treating the Grade 1A as the “basic” grade from which all others can be derived, will be given in §6, after the distribution of vowel grades in the nominal and verbal morphology of Nuer has been fully described.

<sup>4</sup>Faust (2017) offers a similar model of inflectional vowel mutation (i.e. derivation of set B from set A in our terms) based on the pattern observed in adjectives, but with two important differences. First, he does not transcribe the diphthong /ɛa/ (which may be valid for his consultant’s dialect), positing that the modified counterpart of /ɛ/ is /a/. Most importantly, Faust’s does not distinguish various phonation properties in his transcription. As a result, in his model, close mid vowels /e/ and /o/ have no modified counterparts.

<sup>5</sup>This excludes a relatively small class of intransitive verbs which denote involuntary and reflexive actions and states, such as “get tired”, “cough”, “boil”, “float”, “be alive”, “wash oneself”, etc. These verbs have vowels of Grade B in all forms, including the non-suffixed forms.

Table 5: Distribution of Grades A-B in inflected verbal forms

(a) Transitive verb			(b) Intransitive verb		
	singular	plural		singular	plural
1			1		
2	Grade A	Grade B	2	Grade A	Grade B
3			3		

Table 6: Exemplification of the patterns in Table 5

	singular	plural		singular	plural
1	nêaaan̩	něankô	1	něn̩	něnkô
1+2 (incl)		něanê	1+2		něnê
2	nêεen̩	něanê	2	něn̩	něnê
3	nêεenê	něankê	3	něnê	něnkê

### 3.3 Other types of stem modification

Variations in vowel quantity, tone and properties of the stem-final consonant are also involved in inflectional morphology. Within the finite paradigm they oppose singular and plural forms, and thus cross-cut the vowel quality alternations described above. Typically only underived transitive verbs are affected. We divide these into two classes, relevant both for tone and vowel quantity alternations.

Let us first look at tone.<sup>6</sup> Class I verbs have a rising contour in the singular, followed by a high tone of the suffix (falling if the vowel of the suffix is modal), and low stem with a low suffix in the plural.<sup>7</sup> Class II verbs have a falling tone (if the stem vowel is modal) or high (if the stem vowel is breathy) tone on the stem followed by the low tone on the suffix in singular forms, and a rise on the stem followed by the fall on the suffix in plural forms. These patterns are summarized in Table 7, abstracting away from the differences in realization of high and falling tones due to the vowel phonation properties. The longer singular stem is represented as having two tonal elements (a spread H-tone in case of Class

<sup>6</sup>The treatment of tone in the verbal system presented in Sections 3 and 4 differs significantly from Gjersøe (2017) who reports only two tonal contours in verbs, and does not distinguish contrast between low and rising tones.

<sup>7</sup>The tone of the 1pl inclusive form will be ignored throughout the discussion, since it has the same tonal contour for all verbs H-H (realized as LH-HL).

Table 7: Tonal patterns in underived transitive verbs

	Singular	Plural	Example		Gloss
Class I	HH-H → LH-H	L-L	2SG	2PL	‘roast’
Class II	HL-L	H-H → LH-H	nêɛɛn̩	nêanê	‘see’

I, shown as HH, and an HL in case of Class II), while the short plural stem has a single tonal element. The tone of the inflectional suffix is always the same as the last tonal element of the stem and is therefore presumed to be a result of tonal spreading from the stem. All spread H-tones split into L and H resulting in rising tones (see Footnote 2).

Without going into the details of tonal derivation, it deserves mentioning that the tonal values of the plural stem (L for Class I and H for Class II) are the same as the first tonal element of the singular stem. We can propose, therefore, that derivation of the plural stem from the singular stem is accompanied by deletion of the second tonal element in addition to shortening.

With stem length, Class I verbs show some variation across dialects (see Table 8). In Eastern varieties, they have a short vowel throughout the paradigm. In Western dialects, stems that end in non-sonorants have a short vowel, but stems that end in a sonorant have an overlong vowel in the singular. Class II verbs (Table 9) are always overlong with singular persons and short with plural persons, in both Eastern and Western dialects.

Table 8: Inflected paradigm of b̩l̩ ‘roast.TR’ (Class I)

	Singular		Plural	Dual
	Western Nuer	Eastern Nuer		
1	b̩ɔɔl̩	b̩l̩	b̩lk̩	
1+2(incl)			b̩lnê	b̩l̩è
2	b̩uul̩	b̩l̩		b̩l̩è
3	b̩ɔɔl̩	b̩l̩		b̩lk̩

For the sake of comparison, Table 10 shows a Western Nuer paradigm of a Class I transitive verb which ends in a non-sonorant. In contrast to sonorant-final verbs, the stem in Table 10 is short in singular forms. The corresponding

Table 9: Inflected paradigm of *nêen* ‘see.TR’ (Class II)

	Singular	Plural
1	nêaaan̩	něankô
1+2(incl)		něanê
2	nêɛɛn̩	něanê
3	nêɛɛnê	něankê

Table 10: Inflected paradigm of *kɔk* ‘buy.TR’ (Class I) (Western Nuer)

	Singular	Plural	Dual
1	kɔay̩	kɔakɔ (EXCL)	
1+2(incl)		kɔaynê (INCL)	kɔahê
2	kɔy̩		kɔahê
3	kɔyê		kɔakê

Eastern Nuer paradigm of this verb is exactly the same, except for the lack of consonantal mutation in the plural.

Finally, in Western dialects of Nuer, stem-final stops are mutated in the plural (Table 11). The underlying stops /p, t̪, t, k, c/ are realized as voiceless continuants /f, θ, ɾ, ç, h/. Moreover, the alveolar and velar stops undergo a separate process of lenition when they are intervocalic: /k/ → /ɣ/ and /c/ → /j/.<sup>8</sup> The result is an alternation between a stop and continuant or between two different continuants (The underlying stop may be found in other parts of the paradigm; e.g. the NSF of ‘buy.TR’ (the form used with an immediately post-verbal subject) is *kɔk*, and the NSF of ‘cane.TR’ is *dw̩c*.) It is perhaps possible to link the morphologically conditioned consonantal mutation to changes in stem vowel length, as was suggested above in regards to tonal alternations.

<sup>8</sup>Note that this must be understood as a morphophonological process targeting stem consonants, because unlenited intervocalic velars occur in other contexts, e.g. in suffix-initial position. Moreover, the variants [ɣ] and [j] also occur word-finally in nominal forms which contain a lengthened vowel, further supporting the notion that we are dealing with two separate morphophonological lenition processes: one that mutates all stops into voiceless continuants, and another that mutates the palatal and velar stops only, yielding voiced continuants.

Table 11: Stem-final consonant lenition (Western Nuer varieties only)

	‘wait.TR’	‘sing.TR’	‘buy.TR’	‘cane.TR’
3SG	liib-ê	kiiid-ê	kɔ̃ɣ-ê	dwɔ̃ɟ-ê
2PL	liɛf-ê	kɛɾ-ê	kɔ̃h-ê	dwɔ̃ɟ-ê

## 4 Verbal derivation

Verbal derivation involves stem modification alone; there are no segmental derivational affixes. In addition to the antipassive (derived intransitive), we have identified derived ditransitive, centripetal and multiplicative paradigms.

All derived verbs have Grade 2 stem vowels.<sup>9</sup> Table 12 illustrates the correspondence between basic transitive verbs with Grade A stem vowels and derived verbs with Grade 2 vowels.

Table 12: Vowel quality modification in derived forms (Western Nuer)

Basic, 2SG (Grade 1)	Derived, 2SG (Grade 2)
t̥aaɣ-ɨ ‘hold’	t̥h-ɨ ‘hold for’ (ditransitive)
rɨŋ-ɨ ‘run’	rɨŋ-ɨ ‘run towards me’ (centripetal)
cɔ̃ɔɔɔɔ-ɨ ‘call’	cɔ̃ɔɔ-ɨ ‘call for’ (ditransitive)
p̥ɨd-ɨ ‘break’	p̥ɨɾ-ɨ ‘break many times’ (multiplicative)
n̥ɛɛɛɛ-ɨ ‘see’ (transitive)	n̥ɛn-ɨ ‘see’ (antipassive)

What distinguishes the different types of derived verbs, is their length and tonal properties. We will focus here on the antipassives, as these are the most productive and hence best represented in our data. We distinguish two types of antipassives. Antipassive I involves complete deletion of the direct object, while Antipassive II allows the inclusion of a demoted direct object with the preposition *ke*. Compare, for example, the transitive construction *m̥aaɔ̃ɟ p̥ɨu* ‘you are drinking water’ with Antipassive II construction *m̥ɔ̃ɟ ke p̥ɨu* (same translation).

The two types of antipassives share some morphological properties and differ in others. Both of them lack the alternations of tone and stem length characteristic of transitive verbs. Stem length is always short, while tone is based on that of the corresponding transitive verb. If derived from a Class I transitive verb, both

<sup>9</sup>With the exception of the class of intransitives mentioned in Footnote 5.

have a low toned stem and a high toned (or falling, if the vowel is modal) suffix. However, the two types of antipassives differ when derived from verbs of Class II: Antipassive I has a rising tone followed by a high (or falling, if the vowel is modal) suffix, while Antipassive II has a high (or falling over a modal vowel) stem and a low suffix. Abstracting away from tonal differences that are due to the phonation of vowels, we have the tonal patterns for the two Antipassives as shown in Table 13.

Table 13: Nuer tonal patterns in basic transitive verbs and Antipassive I and II

	Transitive		Antipassive I	Antipassive II
	Sg (VVV)	Pl (V)	Sg/ Pl (V)	Sg/ Pl (V)
Class I	HH-H → LH-H	L-L	L-H	L-H
Class II	HL-L	H-H → LH-H	H-H → LH-H	H-L

In all the cases shown in Table 13, the tone on the stem of the antipassive is the same as that of the plural of the corresponding transitive. Since both transitive plural and antipassive formation involves shortening, it is tempting to suggest – as we did for the transitive plural – that this is the cause of the tonal contour of the antipassive, i.e. the second tonal element in the singular transitive stem is deleted, leaving behind L for Class I verbs and H for Class II verbs.

However, this does not explain the difference in the tone of the suffix: in Antipassive I it is always high, while in Antipassive II it is polar to the tone of the stem. We propose that this is due to a floating tone that is part of the derivational morphology that produces antipassives: H in Antipassive I, but P(olar) in Antipassive II.<sup>10</sup>

Verbs which may be considered “basic” intransitives (i.e. they do not have a corresponding transitive) share some aspects of Antipassive II morphology. They have a short vowel in all inflected forms, and follow one of two tonal patterns that exist for Antipassives II. Table 14 provides examples for the two tonal classes for each antipassive and for the underived intransitive verbs:

<sup>10</sup>The two antipassives also differ in their NF1 forms. The NF1 form of Antipassive I is a Grade 2 vowel, as expected for an antipassive verb, while for Antipassive II it is Grade 1, i.e. the grade found in the underived transitive: compare transitive *nēen* ‘see’, with its Antipassive I NF1 form *nèn* (Grade 2), and transitive verb *māaq* ‘drink’, with its Antipassive II NF1 form *maaaq* (Grade 1).

Table 14: Examples of tonal classes of Antipassives and Intransitives (Eastern Nuer)

	Antipassive I		Gloss	Antipassive II		Gloss	Intransitive		Gloss
	3SG	2PL		3SG	2PL		3SG	2PL	
Class I	b̥ɪlê	b̥ɪlê	‘roast’	t̥ɛdê	t̥ɛdê	‘dig’	cj̥ɛŋê	cj̥ɛŋê	‘live’
Class II	n̥ɛŋê	n̥ɛŋê	‘see’	m̥ɔ̄d̥ɛ	m̥ɔ̄d̥ɛ	‘drink’	w̥ɪr̥ɛ	w̥ɪr̥ɛ	‘run’

All other derivational classes of verbs have tonal contours that are not based on tonal characteristics of the lexical stem, but rather are predetermined by its derivational class. Table 15 provides a summary and examples.

Table 15: The summary of derivational classes with grammatical tone (Eastern Nuer)

Derivational class	Vowel grade	Tone		Length
		SG	PL	
Ditransitive	2	H-L	H-L	V
Centripetal	2	L-H	H-L	V/VVV
Multiplicative	1 or 2	L-H	H-L	V/VVV
Stative	1 or 2	H-H	H-H	V
Middle	1 or 2	H-H	H-H	V/VVV

Derivational class	Example		Gloss	Basic verb 3SG
	3SG	2PL		
Ditransitive	c̥ɔ̄l-ê	c̥ɔ̄l-ê	‘call’	c̥ɔ̄ɔ̄l-ê
Centripetal	r̥ɪŋ-ê	r̥ɪɛŋ-ê	‘run’	r̥ɪŋ-ê
Multiplicative	p̥ɪd-ê	p̥ɔ̄d-ê	‘break’	p̥ɪd-ê
Stative	d̥ɪd-ê	d̥ɪɛt-ê	‘be big’	n/a
Middle	ŋ̥ɔ̄aaan-ê	ŋ̥ɔ̄aaan-ê	‘tire’	ŋ̥ɔ̄ɔ̄ɔ̄n-ê

Stative and middle verbs also have a similar morphology in some respects. However, while stative verbs follow the alternation between Grade A and Grade B that was established for other intransitive verbs (see Table 5), middle verbs (involuntary and reflexive actions, see Footnote 5) have Grade B in all forms.

Whether consonantal lenition is present in all derivational classes has not yet been fully determined, since our data from Western Nuer dialects is limited in this



regard. However, so far it appears that stem-final consonantal lenition applies in all forms of derived verbs. Table 16 provides necessary examples in support of this assertion.

Table 16: Stem-final consonant lenition (Western Nuer)

Transitive			Derived		Derivational Class
3SG	2PL	Gloss	3SG	2PL	
kɔ̃y-ɛ̃	kɔ̃ah-ɛ̃	‘buy’	kɔ̃h-ɛ̃ kɔ̃h-ɛ̃	kɔ̃h-ɛ̃ kɔ̃ah-ɛ̃	Benefactive (ditransitive) Unknown (meaning ‘sell’)
kiiid-ɛ̃	kɛ̃ɾ-ɛ̃	‘sing’	kɛ̃ɾ-ɛ̃ kɛ̃ɾ-ɛ̃	kɛ̃ɾ-ɛ̃ kɛ̃ɾ-ɛ̃	Benefactive Antipassive
pɔ̃d-ɛ̃	pɔ̃ɾ-ɛ̃	‘break’	pɔ̃ɾ-ɛ̃	pɔ̃ɾ-ɛ̃	Multiplicative

Additionally, in all Nuer dialects, both Western and Eastern, there is a consonantal alteration /t~/l/ which participates in verbal derivation, but not in verbal inflection. For example, the 3SG form of the transitive verb “pound (dura)” is *ɣɔ̃ɔ̃l-ɛ̃* but the 3SG of the intransitive verb derived from the same root (i.e. the antipassive) is *ɣɔ̃t-ɛ̃*. Interestingly, the NF1 form in the Antipassive II paradigm, which has a stem vowel of Grade 1 (see Footnote 10), also has /l/ in stem-final position, not /t/. Therefore, NF1 of Antipassive II patterns with the transitive verb from which it is derived not only in the quality of its vowel but in the quality of its consonant as well.

## 5 Nominal system

### 5.1 Overview

Noun inflection employs the same morphological devices surveyed above for verbal morphology. But in contrast to the verbal system with its fixed paradigmatic templates, noun inflection involves a great number of different patterns that divide the lexicon into an as of yet undetermined number of inflection classes. Given both the large number of distinct types, we cannot do justice to the topic here, and limit ourselves to a general overview.

The noun paradigm is made up of five cells: two numbers and three cases (nominative, genitive and locative) with the genitive and locative always syncretic in

the plural. Alongside stem modification, nominal inflection may involve suffixation, which is also subject to lexical specification (in contrast, again, to the verbal system).

## 5.2 Vowel quality modification

The nominative singular form (NOM SG) may have the vowel of any grade (1A, 1B, 2A, 2B). However, whether this form has a vowel of Grade A or B has repercussions for the rest of the paradigm.

Because suffixation potentially has an effect on stem vowel behavior, we first describe the patterns as found with unsuffixed nouns. For all such nouns, the genitive singular form has the vowel of Grade B. In that minority of paradigms where a distinct locative singular form is found, it has the vowel of Grade A. The plural either has the vowel of Grade B or a vowel that is raised to Grade 2.<sup>11</sup> A distinct minor pattern is represented by so-called “basic plurals”<sup>12</sup>, like *ʃúɔɔl* ‘hip joint’ and *cɛ̃t̃* ‘excrement’, whose vowel alternation between nominative singular and plural is the mirror-image of what we find elsewhere. In this case, the singular oblique forms share properties with both the nominative plural and the nominative singular, i.e. the vowel in GEN SG *cɛ̃at̃* is the lowered counterpart of the vowel in Nom Pl *cɛ̃t̃* but breathy, like NOM SG *cɛ̃t̃*. Table 17 provides a summary of attested vowel quality alternations. Every pattern illustrated in the table also has a variant where there is no distinct locative singular form (i.e. the form labeled *genitive* here serves for both).

Table 17: Vowel quality variation in nominal paradigms (Eastern Nuer)

NOM SG	GEN SG	LOC SG	NOM PL	Examples				
				Gloss	NOM SG	GEN SG	LOC SG	NOM PL
A	B	A	B	‘big river’	kiir	kiɛɛɛr	kiir	kier
A	B	A	raised (2A)	‘back’	ʃɔk	ʃɔak	ʃɔk	ʃɔok
B	B	A	B	‘home’	cjɛɛɛɲ	cjɛɛɲ	cjɛɛɲ	cjɛɛɛɲ
B	B	(A)	raised (2A)	‘pitcher’	liɛɛɛr		liɛr	liɛɛɛr-i
Basic plurals								
B	B	A	A	‘hip joint’	ʃúɔɔl		ʃúɔl	ʃúl
raised (2A)	B	(A)	A	‘excrement’	cɛ̃t̃		cɛ̃at̃	cɛ̃t̃

<sup>11</sup>Where the singular is itself of Grade 2, this raising is vacuous, eg. NOM SG *t̃ʌʌk* ~ NOM PL *t̃ʌʌʌk* ‘ox’.

<sup>12</sup>These are typically nouns which will at least once have had a collective sense, and can thus be interpreted as having descended from ‘basic plurals’ that were suffixed in the singular only (Storch 2005; Dimmendaal 2000).

The system of suffixation can then be described on the basis of this underlying pattern of vowel alternations. The oblique singular suffix is  $-(k)_A$ .<sup>13</sup> The conditions under which the suffix is used are complex, and vary across dialects<sup>14</sup>, so we note here just some basic principles. First and foremost, the suffix is used in the majority of cases where the NOM SG has a vowel of Grade B, and only rarely where it is of Grade A, so its use is roughly correlated with the stem vowel. The suffix always takes a Grade A vowel in the stem, and length and tone of the stem are always the same as in the nominative singular form. The tone of the suffix is polar to the tone of the stem.

Table 18: Nominal paradigms with suffixed obliques (S = suffixed singular oblique form)

NOM SG	OBL SG	NOM PL	Examples			
			Gloss	NOM SG	GEN SG	NOM PL
A	S	A	‘stick’	kèɛɛt	kèɛɛd- $\dot{A}$	kèɛɛd-ní
B	S	A	‘sheep’	ràaaam	ròòom- $\dot{A}$	ròòom

The behavior of stem vowels with suffixes in the nominative plural (see Table 19) is rather more complex. In brief, there are two patterns: (i) the suffix is appended to a plural stem following any of the patterns outlined in Table 17, or (ii) the suffixed form retains the vowel found in the Nom Sg, as in *kèɛɛd-ní* ‘stick’.

### 5.3 Vowel quantity modification

The most common pattern in our data is, taking the nominative singular as a reference point, to have lengthening in the singular oblique cases and/or in the plural, so there is a rough correlation between vowel quality and quantity modi-

<sup>13</sup>The initial [k] of the singular suffix appears only following a vowel, which in our noun data only occurs through the regular deletion of stem-final [h] before [k], thus ‘monkey’: Western Nuer *gòòh* NOM SG, *gòò-k $\dot{A}$*  GEN/LOC SG (vowel-final stems do occur in pronouns, e.g. *ηu-k $\dot{A}$*  ‘what? GEN/LOC SG’). The initial [n] of the plural suffix is often assimilated to a preceding liquid consonant. The tone of both suffixes is predictable based on the stem: H if the stem has L or LH tone, and L if the stem carries an H or HL.

<sup>14</sup>It appears that singular oblique forms that are not lengthened in respect to the nominal singular in Western Nuer are being replaced by suffixed forms in Eastern Nuer, sometimes with both alternatives co-existing. Acceptability of such suffixed forms varies greatly by speaker and by lexical item. For example, W. Nuer *tùòòη* ‘egg’ has a GEN SG *tùòη* which is rejected by some speakers of E. Nuer in favor of *tòòòη- $\dot{A}$* .

Table 19: Suffixed nominative plural forms (Eastern Nuer)

NOM SG	NOM PL	Examples			
		Gloss	NOM SG	GEN SG	NOM PL
1B	2A	‘pitcher’	liɛɛɛr	liɛr	liɛɛɛr-ì
2A	2A	‘spear’	mɔ̃t	mɔ̃ɔt	mɔ̃d-ní
1A	1B	‘chair’	kɔ̃ɔm	kɔ̃aaam	kɔ̃am-ní
1A	1A	‘stick’	kɛɛɛt	kɛɛɛd-ɔ̃	kɛɛɛd-ní

fiction: the alternation from Grade A to B typically involves lengthening. But in principle any combination of the two may occur, as illustrated in Table 20. The only cell in the paradigm that shows a three-way length contrast is the nominative singular; stem vowels in the genitive singular and the nominative plural forms are always either short or overlong. The only paradigms where all three vowel lengths are found, are those of nouns that belong to the “basic plural” class (see Footnote 9) where the nominative singular form has a long vowel. The genitive singular in these paradigms is lengthened and their nominative plural is shortened (see ‘bead’ in Table 20). One pattern (‘fisherman’ in Table 20) is bound with a particular suffixation pattern: if both nominative singular and plural have overlong vowels, the genitive (and locative) singular is suffixed.

Where the locative singular form is distinct from the genitive singular form, it may have an overlong or a short vowel in no apparent relation to the rest of the paradigm.

#### 5.4 Tonal alternations

Tonal alternations between the various singular nominal forms have not been sufficiently understood yet. It appears that every possible tonal pattern is attested.<sup>15</sup> In (unsuffixed) plural forms, on the other hand, the tone is more predictable. The vast majority of plural forms have either high (H) or falling (HL) tone based on the phonation of the vowel: *diiit* ‘birds’, *rɔ̃ɔm* ‘sheep’, *tɔ̃ɔɔl* ‘snakes’, *pɔ̃aaar* ‘clouds’. This generalization is in line with claim made in Gjersøe (2017) that plurals are always high-toned. However, it is important to note that there are two

<sup>15</sup>For Eastern Jikany, Gjersøe (2017) reports L tone as an exponent of oblique singular cases and H tone as an exponent of nominative plural. Our observations contradict her claims on several points. We find that oblique singular and nominative plural forms show the same range of tonal contrasts that is found in the nominative singular forms.

Table 20: Vowel length in nominal paradigms (Eastern Nuer)

NOM SG	GEN SG	NOM PL	Examples			
			Gloss	NOM SG	GEN SG	NOM PL
V	V	V	‘buffalo’	mòk	mòk	mòk
V	VVV	VVV	‘Nile perch’	cəl	cəaal	cəlll
VV	VVV	VVV	‘bird’	điit	điēēet	điīit
V	VVV	V	‘forest’	rɔ̃p	rɔ̃wɔ̃ɔp	rɔ̃wɔ̃p
V	V	VVV	‘rat’	kɔ̃n	kɔ̃ɔn	kɔ̃wɔ̃ɔn
VVV	S	VVV	‘fisherman’	dēēep	dēēep-ə	dēēep
Basic plurals						
VVV	V	V	‘elephant’	gwɔ̃wɔ̃r	gwɔ̃ar	gwɔ̃r
VV	VVV	V	‘bead’	t̃iik	t̃iēēek	t̃iēk

V=short stem vowel, VV = long stem vowel, VVV = overlong stem vowel, S = suffixed singular oblique form

nominal classes that do not follow this rule. In plurals containing a vowel that is raised (sometimes vacuously) in respect to the singular (i.e. Grade 2), the tone of the plural may be H or it may be LH: *ʃjɔ̃ook* ‘dogs’, *t̃l̃l̃l̃k* ‘oxen’, *l̃ēēek* ‘k.o. fish (plural)’. Additionally, as with other morpho-phonological properties, “basic plurals” show a reversal of the expected pattern: the plural form may carry any of the tonal contours found in regular singulars, while the singular form either has a high or falling tone based on the phonation of the vowel. For example, the plural of the “basic plural” noun ‘fish’ is *r̃ɛc*, while the singular form is *r̃ɛc*.<sup>16</sup>

Moreover, suffixed plural forms seem to follow a predictable tonal pattern. First of all, in this regard it is important to make a distinction between two varieties of the plural suffix *-ni*, as the effects of the plural suffix depend on its paradigmatic distribution. One variety of *-ni* is used just as an oblique marker (genitive and locative): it is simply added to the nominative plural form and has no further effect on the stem. The other variety is used as a general plural marker, i.e. for all cases in the plural. The stem vowel used with this suffix may be changed in relation to the nominative singular, or it may remain the same. The tone of such plurals is H-H (realized as LH-H), e.g. *m̃ɔ̃t-ni* ‘spears’ and *w̃ãar-i* ‘shoes’, or L-H, e.g. *t̃ãak-ni* ‘clocks’ and *k̃ãm-ni* ‘chairs’.

<sup>16</sup>The forms shown are in the Eastern dialect of Nuer.

## 5.5 Stem-final consonant lenition

Consonantal lenition in the nominal paradigms of Western Nuer varieties seems vaguely to follow the pattern of vowel quality modification, where the stop corresponds to Grade A and a mutated consonant (i.e. a continuant) corresponds to Grade B in vowels. The correspondence is all the more striking that even though lenited consonants do not normally appear in nominal singular forms, whenever they do, a suffixed oblique singular form is used. This is an intriguing parallel to the use of suffixed singular oblique forms in paradigms where the nominative singular form has a Grade B vowel. The parallel is not perfect, however: as evident from Table 21, vowel Grade B does not actually necessarily co-occur with consonantal lenition – it only tends to favor the same patterns of distribution.<sup>17</sup>

Table 21: Consonantal lenition in nominal inflection (Western Nuer)

NOM SG	OBL SG	NOM PL	Gloss	Examples		
				NOM SG	OBL SG	NOM PL
P	F	F	‘gift’	múç	múçç	múç
P	P	F	‘tongue’	lêp	lêap	lêeef
F	S	P	‘hyena’	jâh	jâkɔ	jâaah
P	F	P	‘fingernail’	rjòp	rjòf	rjóp

P= plosive; F = voiceless continuant; S = suffixed form

As with verbs, this type of consonantal lenition combines with another process of lenition associated with dorsal consonants, which in this case occurs whenever the stem vowel has been lengthened;<sup>18</sup> thus ‘neck’:  $\eta w\grave{a}k$  NOM SG ~  $\eta w\grave{a}h$  NOM PL (with consonant lenition) ~  $\eta w\grave{a}a\eta$  GEN SG (with lengthening-induced lenition).

The stem-final alternation *l-t* also shows up in the nominal paradigm in both Eastern and Western varieties of Nuer. The alternation is confined to those plurals which involve shift from the vowel of Grade 1 to Grade 2 in the plural: compare  $d\grave{e}el$  ‘goat/sheep.NOM SG’ ( $d\grave{e}aaal$  OBL SG) and its NOM PL  $d\grave{e}t$ .

<sup>17</sup>In this regard it may be interesting to note that within the verbal paradigm, consonantal mutation occurs in NF1 forms of underived verbs but not in NSF or NF2 forms. Vowel Grade B likewise never appears in NSF and NF2 (with the exception of “middle” verbs – see Footnote 5), but does occur in NF1 forms of some verbs.

<sup>18</sup>Though lengthened with respect to what is itself a tricky question; in purely descriptive terms, we would expect to find a shorter stem somewhere else in the paradigm of such a noun.

## 6 Conclusions

Stem modification in Nuer is noteworthy both for what it does and does not share across the two major word classes of verbs and nouns. The actual morphophonological operations are the same, perhaps most strikingly in the presence of two phonologically and functionally distinct series of vowel quality alternations. But the way that stem modification behaves could not be more different between the two word classes. Verb inflection follows a strict paradigmatic template, so that given e.g. the 3SG form, the rest of the paradigm is predictable. Nothing of the sort in noun inflection. Of course, all is not chaos – as we have shown, each stem modification process is constrained both in terms of the alternants, and in terms of its paradigmatic distribution. But the fact that (i) whether or not a stem modification process occurs is usually lexically specified, and (ii) the different stem modification processes are largely independent of one another, means that the degree of unpredictability in the paradigm is high.

Having laid out all the facts in regards to vowel quality alternation, we can now address basis for the assumption that Grade B is derived from Grade A, and Grade 2 is derived from Grade 1, and not vice versa. Our primary motivation is that the relationship between the two main grades (1 and 2) and their subgrades (A and B) is easier to capture formally assuming that Grade 1A is the starting point for the derivation of other grades. Adopting the view that Grade 1A is “basic”, both Grade 1B and Grade 2A are just one phonological operation away: diphthongization/lowering to derive the vowel of Grade 1B and raising/addition of breathiness to derive the vowel of Grade 2A. Grade 2B is then derived from Grade 2A by applying removal of breathiness and diphthongization/lowering in a way that parallels derivation of Grade 1B from Grade 1A. If we were to assume Grade 1B as basic, the derivation of Grade 2A would involve two steps: monophthongization and then further raising/addition of breathiness.

Another consideration in regards to treating the Grade 1A as “basic” has to do with markedness, both phonological and morphological. Grade 1A is comprised of [-ATR] monophthongs, most of which are not breathy. They are also found in “simpler” morphological environments. Vowels of Grade 1 are used in underived transitive verbs, while vowel of Grade A are found in unsuffixed forms that are used with inflected auxiliaries or with a postverbal subject (NF1, NF2, NSF). Within the nominal system, vowels of Grade 1A are found in the nominative, never in the genitive (unless segmentally suffixed, in which case one could say the job of case marking has been entirely ceded to the suffix). In contrast, vowels of other grades, can be argued to be more complex phonologically, either by be-

ing diphthongs, or by involving features such as [+SG] (i.e. +Spread Glottis, i.e. breathiness) and [+ATR]. These grades are found in forms which are presumed to be also more complex morphologically: derived verbs and oblique case-forms. It is logical to propose that the complication to the phonological make-up of vowel grades other than Grade 1A is due to presence of derivational and inflectional morphemes that have featural rather than segmental exponents.

The vowel quality modification provides an intriguing point of comparison in relation to Dinka, a close relative of Nuer. Andersen (1993) shows that in Dinka vowel quality in the inflected paradigm is modified in a way similar to Nuer, by means of inserting a lower vocalic element after the basic vowel. However, fewer diphthongs are attested in Dinka than in Nuer. Specifically, stems containing non-high vowels /ɔ/ and /ɛ/ as basic vowels have monophthong /a/ in forms with modified vowel quality. As Andersen theorizes, diphthongs /ɔa/ and /ɛa/ are part of the intermediate representation at some point in derivation of these forms, but the first element in these diphthongs is deleted in Dinka. This parallel between Nuer and Dinka provides another motivation for treating Grade B as derived from Grade A. It is clear that such is the direction of derivation for the equivalent grades in Dinka, since, if the derivation of vowel grades proceeded in the other direction, the outcome of Grade A could not be predicted based on the quality of the vowel in Grade B in Dinka due to the fact that several values of Grade A correspond to a single value of Grade B.

Nevertheless, having justified the notion of Grade 1A as “basic”, it is important to keep in mind that for any specific target that is subject to modification, the “basic” variant may not necessarily be found anywhere in the paradigm. The Western Nuer paradigm of the noun *liɛɛɛr* “water jug/pitcher” can attest to that: the vowel /i/ of Grade 1A does not show up in any of its forms, i.e. NOM SG *liɛɛɛr*, GEN SG *liɛr*, NOM PL *liɛɛɛr-í*. Still, the “basic” vowel is recoverable due to one-to-one correspondences between vowels of different grades, and does indeed show up in the suffixed oblique singular form used in Eastern Nuer varieties (see Footnote 14), i.e. OBL SG *liir-à*.

## Acknowledgements

The research presented here is funded by the Arts & Humanities Research Council (UK) under grant AH/L011824/1 (*Morphological Complexity in Nuer*). We thank our Nuer consultants John Nguany Gai Yok, Andrew Kuong, Yak Wichok, Chuol Tut, Mathew Juany Riek, John Chuol Kuek, Lam Muang, Jacob Gatkuoth, Phillip Muk, John Makuac for sharing their knowledge with us, and also Noam Faust,



Sharon Rose and the Department of Linguistics at University of California San Diego for their input and assistance with data collection.

## Abbreviations

AP	antipassive	NF2	non-finite form 2
CP	centripetal	NSF	non-suffixed form
EXCL	exclusive	NOM	nominative
GEN	genitive	OBL	oblique
IN	intransitive	PL	plural
INCL	inclusive	SG	singular
LOC	locative	TR	transitive
NF1	non-finite form 1		

## References

- Andersen, Torben. 1993. Vowel quality alternation in Dinka verb inflection. *Phonology* 10. 1–42.
- Baerman, Matthew. 2012. Paradigmatic chaos in Nuer. *Language* 88(3). 467–494.
- Crazzolaro, Joseph Pasquale. 1933. *Outlines of a Nuer grammar*. Wien: Verlag der Internationalen Zeitschrift “Anthropos”.
- Dimmendaal, Gerrit J. 2000. Number marking and noun categorization in Nilo-Saharan languages. *Anthropological Linguistics* 42. 214–261.
- Faust, Noam. 2017. How low can you go? A note on vowel mutation in Nuer. *Journal of African Languages and Linguistics* 38(1). 51–64.
- Faust, Noam & Eitan Grossman. 2015. *Nuer (Western Nilotic): A preliminary survey*. [https://www.academia.edu/13645692/Nuer\\_Western\\_Nilotic\\_a\\_preliminary\\_survey](https://www.academia.edu/13645692/Nuer_Western_Nilotic_a_preliminary_survey), accessed 2019-6-8.
- Frank, Wright Jay. 1999. *Nuer noun morphology*. University of New York at Buffalo. (MA thesis).
- Gjersøe, Siri. 2016. *Tone in Nuer nouns: Oblique case and the construct form*. Colloquium on African Languages and Linguistics, Leiden University, August 29-31.
- Gjersøe, Siri. 2017. *Tonal polarity patterns in Eastern Jikany Nuer*. Addis Abeba, Ethiopia. The 13th Nilo-Saharan Linguistics Colloquium May 04-06 2017.
- Reid, Tatiana & Matthew Baerman. 2017. *Vowels in Nuer morphophonology (the case of transitive verbs)*. The 13th Nilo-Saharan Linguistics Colloquium, 04-06 May 2017, Addis Ababa University.

Storch, Anne. 2005. *The Noun Morphology of Western Nilotic*. Cologne: Köppe.

Vandevort, Eleanor. n.d. Nuer field notes. Scanned index cards available from:  
<http://www.dlib.indiana.edu/collections/nuer/> [last accessed 24/01/2018].

## Chapter 27

# Negation coding in Ga

Yvonne Akwele Amankwaa Ollennu

University of Education Winneba

The paper investigates negation coding in Ga, a Kwa language. Data analyzed in the paper was gathered from Ga students at the University of Education, Winneba, in addition to the researcher's native intuition. According to Miestamo (2007) negation could be classified under two categories, standard and non-standard negation. It is noted that whichever type of negation is employed in a language, it will be done either morphologically or syntactically. The paper shows that both morphological and syntactic strategies are used for negation coding in Ga. The NP NP and copula types of sentences in Ga employ a syntactic strategy to code negation. On the other hand, SVO sentences are negated morphologically. The SVO type of sentences is negated morphologically via the tense or aspect of the verb type in Ga. The affixes used to negate the SVO sentences also depend on the type of verb used in the sentence.<sup>1</sup>

## 1 Introduction

The paper investigates negation coding in Ga. Miestamo (2007: 553) categorized negation into two types: standard and non-standard negation. The negation of declarative verbal clauses is termed standard negation and the negation of imperatives, existential, and non-verbal clauses is termed non-standard negation. However, whichever category may exist in the language, certain strategies would be employed to negate the clause. This was noted by Dahl (1979), who examined 240 languages and concluded that negation is expressed either morphologically or syntactically and therefore proposed a typology for negation. He further iterated that the morphological strategy may involve prefixation, circumfixation

---

<sup>1</sup>This paper was presented at the 44th Annual Conference of African Linguistics at Georgetown University. It was mistakenly excluded from those proceedings, so we are including it here as a courtesy to the editors of that volume and to the author.



or suffixation. Though Dakubu (2003) discussed Ga clauses and their negation, the strategies employed were not investigated. The focus of this paper is to find which of these strategies are employed in negating clauses in Ga using Dahl's (1979) proposed typology on negation. Dahl, however, claims that his typology may not be universal and may not be generalized due to some lapses. Data analyzed in the paper was gathered from Ga students at the University of Education, Winneba, in addition to the researcher's native intuition. There were 57 students in all comprising 29 males and 26 females.

The paper is divided into three sections. The first section gives a short typological background of Ga and includes the verb types and clause types. Section two then examines the negation strategies of the Ga clauses. Section three is the final section and presents the summary and conclusion.

### **1.1 Brief typological background of Ga.**

Ga is a two-level tone language from the Kwa branch of the Niger-Congo family. It is spoken in Ghana, along the coastal areas in the Greater Accra region like Ga Mashie, Osu, La, Teshie Nungua, Tema, Kpone among others. Ga has no dialects, but vocabulary differences exist which correlate with differing geographical locations. Ga has cases of downstepping and nasality spreading in certain instances Dakubu (2000). In terms of its vocalic entry, it has five nasal vowels /ã, ã̃, ã̄, ã̅, ã̆/ and seven oral vowels /i, o, ε, ɔ, u, e, a/ . All the vowels contrast as they bring about meaning change as shown in (1).

- (1) a. fa 'to borrow'
- b. fã 'half'
- c. tɔ 'bottle'
- d. tɔ̃ 'to be wrong'

The language is similar to Akan in many ways especially in terms of the sentence structure. The two-level tones, that is Low (L) and High (H) in Ga have grammatical and lexical functions. The language has several affixes made up of derivational and inflectional ones. All the major word classes can be found in the language. Some of these word classes have both derived and non-derived members.

### **1.2 Verb types in Ga**

Dakubu (1970; 2003) recognizes two types of verb in Ga. The simple verbal classes consist of verbal stems and can be attached with eleven different affixes which

may indicate one of the following: polarity, aspect, tense and class of the verb stem. Group 1 or class 1 verbs consist of monosyllabic verbs with initial high tone, polysyllabic stems with low tone throughout and a set of twelve monosyllabic low tone stems. The verbs found in class 2 are stems which are monosyllabic with low tones and all polysyllabic stems with initial low tone followed by high. Below, we see examples of each of the two types of verb stems found in Ga.

## Verb type 1

## (2) Perfect:

- a. Aku é-<sup>1</sup>bí.  
 Aku PERF-ask  
 ‘Aku has asked.’
- b. Progressive:  
 Aku mii-bí  
 Aku PROG-ask  
 ‘Aku is asking.’
- c. Subjunctive:  
 Aku á-bí.  
 Aku SBJV-ask  
 ‘Aku should ask.’

## (3) Aorist:

- a. Aku <sup>1</sup>bí.  
 Aku ask.AOR  
 ‘Aku asked.’
- b. Habitual:  
 Aku bí-ɔ.  
 Aku ask-HAB  
 ‘Aku asks.’
- c. Future:  
 Aku áá-bí.  
 Aku FUT-ask  
 ‘Aku will ask.’

Verb type 2

- (4) a. Perfect:  
Aku é-kè                   mì wòlò.  
Aku PERF-present 1SG book  
'Aku has presented a book to me.'
- b. Progressive:  
Aku mii-kè                mì wòlò.  
Aku PROG-present 1SG book  
'Aku is presenting a book to me.'
- c. Subjunctive:  
Aku à-kè                 mí wòlò.  
Aku SBJV-present 1SG book  
'Aku ought to present a book to me.'
- (5) Aorist:
- a. Aku kè                   mì wòlò.  
Aku present.AOR 1SG book  
'Aku presented a book to me.'
- b. Habitual:  
Aku kè-ɔ                 mì wòlò.  
Aku present-HAB 1SG book  
'Aku presents a book to me.'
- c. Future:  
Aku àá-kè                mì wòlò.  
Aku FUT-present 1SG book  
'Aku will present a book to me.'

In the above, the verbs *bí* 'ask' and *kè* 'present' represent the two types of verbs. It will be noticed that prefixes are attached to the verbs in obtaining the perfect, progressive, subjunctive and future. For habitual, a suffix /-ɔ/ which has the allomorph /-a/, is attached to the verbs depending on the vowel in the root of the verb under consideration. The allomorph /-a/ occurs only with verbs that have the vowel /a/ in the final syllable of the root. However it must be noted that there are other affixes – auxiliaries – which are attached to verbs in Ga, but these will not be discussed in this paper.

### 1.3 Clause types

Dakubu (2003) noted that Ga has NP NP, Copula and SVO clause types. It must be noted that there are sub-groups of the NP NP clause-type. The examples in (7) and (8) are NP plus particles. The particles precede or occur after the NP in the clause.

- (6) Nàà yòó    ʼlé  
 PRT woman DEF  
 'Here is the woman.'

- (7) Nùú ʼlé nɛ  
 Man DEF PRT  
 'This is the man/that is the man.'

- (8) Yòó    ʼlé nì.  
 Woman DEF PRT  
 'It is the woman.'

In examples (7-8) above we observe that the particles *ni* and *nɛ* occur after the noun in the sentences and the particle *naa* occurs at the initial position in (6). These sentences (6-8) do not contain main verbs. It will be completely unacceptable to put a verb in such sentences, as in (9).

- (9) \*Nùú lɛ ba nɛ.  
 Man DEF come PRT

The second sub-group comprises those that contain only two NPs and nothing else. There is no occurrence of particles and these are grammatical in the language. Examples (10)-(11) illustrate this type.

- (10) Nmɛʼné Sòò.  
 today Thursday  
 'Today is Thursday.'

- (11) É-mùsù gògá.  
 3SG-stomach bucket  
 'His stomach is a bucket. (His stomach is big)'

However it should be noted that word order is fixed in (10) and (11) to preserve meaning in the NP NP clause type. It cannot be switched or turned around syntactically to mean the same. The clause in (10) shows a relationship of the NP in first position belonging to the class in the second NP, but in (11) the second NP describes the first entity. The copula clause type consists of a defective verb and can be swapped around. The copula clause is made up of NP and VP where the VP contains a copula verb and an NP. The copula verb *ji* is used below to illustrate in (12-15).

- (12) Nùù jí 'lɛ.  
Man COP 3SG  
'He is a man.'
- (13) Tsòólòò jí Adote.  
Teacher COP Adote  
'The teacher is Adote'
- (14) Mí-fɔ̀-mò gbì jí wó.  
1SG-give.birth-NOM day COP tomorrow  
'My birthday is tomorrow.'
- (15) Mí-mà mí jí pòlísifónyò.  
1SG-mother COP police  
'My mother is a police woman.'

In the above examples in (12) the two NPs are *nùù* 'man' and *lɛ* 'him' and in (13) the two NPs are *tsòólòò* 'teacher' and *Adote* 'name of a person'. The copula verb *jí* has been placed in between the two NPs to form the sentences. It must be noted that without the copula placed in between the two NPs, they will be NPs and not meaningful sentences. One major feature of the Ga copula clause is that the NPs in the clause can be interchanged and the meaning of the sentence remains the same. That is to say, in its structure, there are two NPs and the copula is placed between the two NPs. Changing the positions of the NPs does not alter the meaning of the sentences. There may be a pragmatic change in meaning but the paper will not delve into that. For instance example (13) and (14) above can be rendered as (16) and (17) where the positions of the NPs are changed.



- (16) Adote jí tsòólò.  
 Adote COP teacher  
 ‘Adote is a teacher.’
- (17) Wó jí mì-fó-mò gbì.  
 Tomorrow COP 1SG-give.birth-NOM day.  
 ‘Tomorrow is my birthday.’

I believe the choice of one form over another depends on the speaker’s focus. As discussed by Dakubu (2003), in Ga the abbreviation SVO is itself shorthand for SVOOA. Thus, there is the possibility of having two objects and an adjunct and this is because there are transitive, intransitive and ditransitive verbs in Ga. The adjunct is optional, and a sentence could have more than one in a sentence. The verb is the obligatory element in the SVO clause. The main verb in the sentence could have preverbs attached to them. Illustrations are in examples (18 -19) below.

- (18) Aku tee sukuu.  
 Aku go.AOR school  
 ‘Aku went to school.’
- (19) Aku baa-ba-na le wò.  
 Aku ING-FUT-see 3SG tomorrow  
 ‘Aku will see him/her tomorrow’

In (18) the verb *tee*<sup>2</sup> ‘went’ has a subject *Aku* and object *sukuu* ‘school’. In (19) the sentence structure is Subject-Verb-Object-Adjunct (SVOA). The adjunct is often an optional element in Ga.

## 2 Negation of clauses

Negation of non-verbal clauses in Ga involves the introduction of a negative particle. On the other hand, the verbal clause is negated morphologically through suffixation and circumfixation. The affix chosen in Ga depends on the verb type. Ga negation is discussed in this section.

---

<sup>2</sup>*Tee* is an aorist and an irregular verb form for the verb *ya* ‘to go’.

## 2.1 Non-verbal clauses

At this point, the paper examines the strategies for the negation of non-verbal clauses, which falls in the category of non-standard negation. In negation of both 'NP NP' types of clauses, there is the introduction of a negative particle *jééé*. The source of this particle may be traced to the copula verb *ji*, which when negated becomes *jééé*. It must be noted that it is normally referred to as the negative particle, and that will be maintained in this paper. Clauses in (20-22) below are from the subgroup of the NP type which consists of particles.

(20) *Jééé*     *Aku* *nì*.  
NEG.PRT *Aku*  
'This is not *Aku*.'

(21) *Jééé*     *yòó*     *lè*     *né*.  
NEG.PRT woman DEF PRT  
'That is not a woman.'

(22) *Jééé*     *nùú* *lè*     *nì*.  
NEG.PRT man DEF PRT  
'That is not the man.'

It can be seen from the above examples (20-22) that *jééé* occurs in initial position. The free negative morpheme precedes the first NP in the clause to be negated. With this type of clause, it will be unacceptable in the Ga language to place the morpheme *jééé* after the noun or clause finally. The morpheme inherently is negative and occurs only at initial position to negate the sentences.

The examples below are the negation of examples (12-12b); the particle *jééé* is placed in between the two NPs as shown in (23) and (24).

(23) *Nmɛnɛ* *jééé*     *Sòò*.  
Today NEG.PRT Thursday  
'Today is not Thursday.'

(24) *É-musu*     *jééé*     *gògá*.  
3SG-stomach NEG.PRT bucket  
'His stomach is not a bucket. (His stomach is not big)'

In the second sub-group of two-NP clauses in (10) and (11), the negative particle occurs in between the NPs and not at the initial position in the clauses. When the negative particle is placed at the initial positions of the clauses, the meaning derived is to correct the value or otherwise of a statement made and not negate them for the above in (23) and (24). This may not be so in all instances as seen in (25) and (26).

(25) \* Aku jééé nì.  
NEG PRT Aku PRT

(26) \* Yòó lɛ́ jééé né.  
NEG.PRT woman DEF PRT

In (25) and (26) above, the negative particle cannot be placed before the particle *ni* or *né* as this is ungrammatical, unlike the examples in (23) and (24) where the negative particle can occur between the two nouns in the sentence.

## 2.2 Copula clause

In negating the copula sentence the negative form of the copula verb *ji* which is *jeéé* is introduced into the sentence. For instance, after negating the above copula sentences in (13-15), the outcome will be (27-29).

(27) Jééé nùù jí lè.  
NEG.PRT man COP 3SG  
'He is not a man.'

(28) Jééé tsòólò jí Adote.  
NEG.PRT teacher COP Adote  
'The teacher is not Adote.'

(29) Jééé mi-fɔ-mɔ gbi jí wɔ.  
NEG.PRT 1SG-give.birthday-NOM day COP tomorrow  
'My birthday is not tomorrow.'/ 'Tomorrow is not my birthday.'

It must be noted that with the possibility of the NPs being interchangeable, such sentences still have the negative particle *jeéé* introduced at the initial position of the sentence. For instance (16) and (17) above can be negated and the outcome will be (30) and (31) below.

- (30) Jééé Adote jí tsòólò.  
NEG.PRT Adote COP teacher  
'Adote is not a teacher.'
- (31) Jééé wɔ jí mi-fɔ-mɔ gbì.  
NEG.PRT tomorrow COP 1SG-give.birth-NOM day  
'Tomorrow is not my birthday.'

The strategy employed in the examples that introduce the negative morpheme *jééé* is the syntactic strategy. A morpheme is being introduced into the clause to form the negative construction. It could be said that the negative form of copula verb *jééé* plus the copula verb *ji* is found in the construction. This is the reason why it has been referred to as a negative particle in Ga literature. Dangme, a very closely related language, has allomorphs of the negative morpheme as noted by Caesar (2012) but there are no allomorphs of the *jééé* negative particle in Ga.

### 2.3 SVO clauses

SVO clauses, which fall into the standard negation category, employ morphological strategies to form the negative. Negation is formed by the introduction of an affix which is attached to the verb. In the negation of an SVO clause, the tense and the verb type must be taken into consideration.

When the sentence is declarative and in the following tense/aspect: present, progressive, habitual and past, a double copy of the final vowel of the root verb -VV is attached to a high tone verb (type 1). On the other hand, when it is verb type 2 a prefix *e-* plus the double copy of the vowel is suffixed to the verb to negate it. A circumfix or preferably a discontinuous morpheme *e-VV* therefore is used in the negation process for verb type 2. Examples (32-34), which are in the affirmative, are all negated by the same strategy to obtain (35).

- (32) Aorist:  
Tete bí Aku sàné.  
Tete ask.AOR Aku matter  
'Tete asked Aku about the issue.'
- (33) Progressive:  
Tete mii-bí Aku sàné.  
Tete PROG-ask Aku matter  
'Tete is asking Aku about the matter/issue'

- (34) Habitual:  
 Tete bí-ɔ́ Aku sàné.  
 Tete ask-HAB Aku matter  
 ‘Tete asks Aku about the matter/issue.’

The negative form will be:

- (35) Tete bí-íí Aku sàné.  
 Tete ask-NEG Aku matter  
 ‘Tete did not ask Aku about the matter.’

It can be concluded that in terms of negation, there is no distinction between progressive, habitual, and aorist in Ga. The distinctions get lost as the negation marking on the verb is the same for time sequences.

A sentence in the future is as follows:

- (36) Affirmative verb type 1  
 Tete àá-bí lé.  
 Tete FUT-ask 3SG  
 ‘Tete will ask him/her.’

- (37) Affirmative verb type 2  
 Tete bàá-kè nii.  
 Tete FUT-give thing  
 ‘Tete will give (a gift).’

- (38) Negative verb type 1  
 Tete bí-ɲɲ lé.  
 Tete ask-NEG 3SG  
 ‘Tete will not ask him.’

- (39) Negative verb type 1  
 Tete é-<sup>1</sup>ké-ɲ níí.  
 Tete NEG-give-NEG thing  
 ‘Tete will not give (a gift).’

From the above example (38), it can be observed that the suffix *-ŋ* is used to negate the verb with a high tone and a discontinuous morpheme *e-ŋ* is used for the low tone verb in (39).

Negation of the perfect proceeds as follows in (40-41):

- (40) Affirmative verb type 1

Tete é-<sup>1</sup>bí      <sup>1</sup>mí.

Tete PERF-ask 1SG

‘Tete did not ask me.’

- (41) Affirmative verb type 2

Tete é-kè      mì wòlò.

Tete PERF-give 1SG book

‘Tete has gifted me a book.’

- (42) Negative verb type 1

Tete bí-kò      mì.

Tete ask-NEG 1SG

‘Tete has asked me.’

- (43) Negative verb type 2

Tete é-<sup>1</sup>ké-kò      mì.

Tete NEG-give-NEG 1SG

‘Tete did not present to me...’

The analysis shows that the perfect takes a suffix *-ko* which attaches to the verb for verb type 1 in (42) and a circumfix *e-ko* for verb type 2 in (43).

In negating the subjunctive the negative prefix *-ka* is attached to the verb types. It should be noted that the subjunctive already has a prefix *a-* to indicate that mood.

Let’s consider the subjunctive. The sentence will be negated as follows:

- (44) Verb type 1

Tete á-ká-bí.

Tete SBJV-NEG-ask

‘Tete should not ask.’

- (45) Verb type 2  
 Tete á-ká-kè.....  
 Tete SBJV-NEG-present  
 ‘Tete should not present.....’

The imperative can also be negated by attaching the prefix *-káá* to the verb in the singular and the prefix *-ká* for the plural imperative. It must be noted that the singular imperative is a high floating tone. Below are examples in (46a–d and (47) to illustrate this fact.

- (46) Singular imperative affirmative:  
 a. *Wɔ́* ‘You(SG) sleep.’  
 b. *Yé* ‘You (SG) eat.’  
 Singular imperative negative:  
 c. *Kááwɔ́*. ‘Do not sleep.’  
 d. *Kááyé*. ‘Do not eat.’

- (47) Plural imperative affirmative:  
 a. *Nyé-wɔ́-a*. ‘You(PL) sleep.’  
 b. *Nyé-yè-a*. ‘You(PL) eat.’  
 Plural imperative negative:  
 c. *Nyé-ká-wɔ́-a*. ‘You(PL) do not sleep.’  
 d. *Nyé-ká-yè-a*. ‘You(PL) do not eat.’

From the above discussion, the SVO clause is negated in accordance with the verb type and tense of that verb. In Ga, negation employs prefixes and circumfixes. The verb type 1 employs prefixes while verb type 2 negates with circumfixes, with the exception of the subjunctive and imperative.

## 2.4 Other forms of negation

Sometimes sentences are negated by the use of replacive negative words. This was discussed by Caesar (2012: 23) for Dangme (lexical negation). This normally happens in Ga when the verb *yɛ* ‘to have’ is used. Here, the verb is totally replaced with a negative verb *bɛ* ‘not’. This is exemplified in (48) and (49).

(48) Ajele yε shiká.  
Ajele has money  
'Ajele has money.'

(49) Ajele bε shiká.  
Ajele not money  
'Ajele has no money.'

In (49) the negative verb *bε* is used for negation and the verb *yε* does not occur in the negative construction.

### 3 Summary and conclusion

In summary, Ga clauses were examined and classified into three namely the NP NP clause type, the copula clause type and the SVO clauses. Negation of the NP NP and Copula clauses is done using the syntactic strategy which involves the introduction of the negative particle *jééé* at initial or middle position in the clauses. The following were noted for the SVO clause:

- Ga SVO clauses can be negated morphologically. The negation depends on the verb type in the sentence vis-a-vis the tense of the verb. The habitual, progressive as well as the past and present tenses were negated with the suffix -VV for verb type 1 and *e*-VV for verb type 2.
- The perfect negation for verb type 1 is a suffix -kò. A circumfix *e-kò* is used for verb type 2.
- Future negation is achieved for verb type 1 with a suffix -η. For verb type 2, the circumfix *e-η* is used.
- In the imperative, verb type 1 and 2 both use the prefix *kàá-* and *ká-* for singular and plural imperatives respectively.
- The subjunctive negation uses the *ká-* prefix for both verb types.

#### 3.1 Conclusion

In conclusion, the paper examined the ways of forming negation in Ga. The clause types were discussed and each type was examined to find how they can be



negated. From the study it came to light that non-verbal sentences (NP and Copula types) are negated syntactically by introducing *jééé*, a negative particle. SVO type of sentences is negated morphologically. The negation is marked overtly on the verb in the sentences using affixes. Verb type 1 uses prefixes generally for negation and verb type 2 attaches circumfixes. However it was noted that there are instances where the verb form changed totally when negated. Finally, Ga uses both syntactic and morphological strategies to form negation. This is among the strategies proposed by Dahl (1979) which serves as a stepping stone to examining negation further in Kwa languages as there may be an overlap. The discussion of the negation coding in Ga using Dahl's typology is an attempt to examine the strategies that are used to code negation. The researcher believes that it can also be placed into Miestamo (2007) categorization of negation into standard and non-standard negation. This will be left for future research as Dahl's typology may not cater for all the issues.

## Acknowledgments

I wish to express my heartfelt thanks to the Vice-Chancellor of the University of Education, Winneba for making it possible for me to access sponsorship and also granting me permission to attend the ACAL 44 conference in Washington DC. And to Prof. Essilfie and my colleagues: Dr Samuel Atintono, Dr Clement Appah, Mrs Francisca Adjei, and Mr Emmanuel Adjei for your valuable contributions helped me to improve this paper.

## Abbreviations

AOR	Aorist	PART	Particle
COP	Copula	PERF	Perfect
DEF	Definite	PL	Pural
FUT	Future	PROG	Progressive
HAB	Habitual	PST	Past
INGR	Ingressive	SG	Singular
NEG	Negative	SBJV	Subjunctive
NEG.PRT	Negative particle	1SG	First Person Singular
NOM	Nominal Affix	3SG	Third Person Singular
NP	Nominal Phrase		

## References

- Caesar, Regina O. 2012. Negation in Dangme. In Bruce Connel & Nickolas Rolle (eds.), *Selected proceedings of the 41st Annual Conference on African linguistics*. Sommeville, MA: Cascadilla Proceedings Project.
- Dahl, Östen. 1979. Typology of sentence negation. *Linguistics* 17(1-2). 79–106.
- Dakubu, Mary E. K. 1970. The categories of Ga verbal group. *Journal of African Languages* 9(2).
- Dakubu, Mary E. K. 2000. The Ga nominal phrase. Unpublished manuscript.
- Dakubu, Mary E. K. 2003. *The Ga verb*. Unpublished manuscript.
- Miestamo, Matti. 2007. Negation - an overview of typological research. *Language and Linguistics Compass* 1(5). 552–570.

## Chapter 28

# On the structure of splitting verbs in Yoruba

Alicia Parrish

Michigan State University

Cara Feldscher

Michigan State University

Yoruba has a set of bisyllabic verbs that obligatorily split around a direct object, as in *Adé ba ilé nàá jé*, meaning ‘Adé **destroyed** the house’, where both *ba* and *je* make up the verb for *destroy*. These are called “splitting verbs” and have previously been analyzed as requiring that the first verbal element be merged directly on *v*. We introduce new data using an aspectual marker, *tún*, meaning *again*, which changes the typical word order such that both verbal elements appear string adjacent following the object, as in *Adé tún ilé nàá bajé*, meaning ‘Adé **destroyed** the house again’. This data supports a movement-based analysis of splitting verbs where both verbal elements are initially merged low in the structure, but the first verbal element is moved through Asp to *v*.

## 1 Introduction

Yoruba is widely agreed to be an SVO language, as seen in (1), and reported by many grammars of Yoruba, such as Bamgboṣe (1966), among others.

- (1) Adé je adiye nàá.  
Adé eat chicken the  
‘Adé ate the chicken.’



However, a class of verbs exists that does not follow the usual SVO order. Splitting verbs, as shown in (2a) and (2b), are a class of disyllabic verbs that obligatorily split around the direct object.<sup>1</sup>

- (2) a. Adé ba ilé nàá jé.  
Adé destroy<sub>1</sub> house the destroy<sub>2</sub>  
'Adé destroyed the house'
- b. \* Adé ba-jé ilé nàá.  
Adé destroy<sub>1-2</sub> house the  
Intended: 'Adé destroyed the house'

In one established case, these verbs are found with both halves string adjacent. This lack of a split occurs when the verb has an inchoative alternation (as a few, but not all, of them do), where there is no object to split around, as shown in (3b). Speakers report that, in this case, they consider the verb to be one lexical item.

- (3) a. Adé pa ilèkùn nàá dé.  
Adé close<sub>1</sub> door the close<sub>2</sub>  
'Adé closed the door.'
- b. ilèkùn nàá pa-dé.  
door the close<sub>1-2</sub>  
'the door closed.'

There is some debate over the structure of these verbs, but native speakers are firm in their intuitions that splitting verbs have a semantically noncompositional meaning, as are many scholars in the field (Bode 2000; Awobuluyi 1967; 1971; Bamgboṣe 1966). While some splitting verbs are decomposable into two somewhat compositional pieces, others are not, and are idiomatically composed of two verbs (Awobuluyi 1971). In some cases, the two halves may not even be verbs on their own anymore. In (4–5), we show examples from Awobuluyi (1971) of one splitting verb that is somewhat decomposable and another that is not, as shown by the ungrammaticality of each piece when used in isolation, either transitively or intransitively. Splitting verbs are semantically varied in addition to having varying degrees of compositionality; for further examples demonstrating this, see Awobuluyi (1971).

- (4) bùṣe 'to almost complete' = bù + ṣe, 'take some of' + 'do'

---

<sup>1</sup>Note that it is only around a direct object. In cases where there is an indirect object, it must appear outside of the split.

- (5) *bàjẹ* ‘to spoil’ = *bà* + *jẹ*, ‘?’ + ‘?’
- a. \* *ó*            *bà* (*Òjọ*)  
       3sg-Subj *bà* (*Ojo*)  
       ‘It *bà* (*Ojo*).’
- b. \* *ó*            *jẹ* (*Òjọ*)  
       3sg-Subj *jẹ* (*Ojo*)  
       ‘It *jẹ* (*Ojo*).’

Awóyalé (1974) argues that they are in fact decomposable, but he is forced to add semantic meaning that is greater than what is contributed by the individual elements,<sup>2</sup> and he is in the minority in arguing for full decompositionality.

## 2 Background

### 2.1 Previous analyses

There are two main directions that accounts of splitting verbs have gone in. One possibility is to claim that splitting verbs are two separate verbs in a normal serial verb construction, in which case the challenge is to explain the lexical specificity restrictions of which verbs they can pair with and the semantically non-compositional reading that results. The other is to claim that the two verbs actually make up just one lexical item, in which case the challenge is to explain why the two halves show up separately when a direct object is present.

Bamgboṣe (1966) takes the first route and claims that splitting verbs are reducible to serial verb constructions. Serial verb constructions allow two verbs to share one object, which appears in between the two verbs, like the object in splitting verb constructions. For serial verbs in Yoruba, it is possible for one DP to be the object of both verbs, as in (6a), or the object of the first verb can appear as the subject of the second, as in (6b).

- (6) a. Example from Bode (2000)  
       *Bode ra iwé tà.*  
       *Bode buy books sell*  
       ‘Bode bought books and sold them.’

---

<sup>2</sup>This also confirms their status as idiomatic constructions. His argument is based on a degree of abstract similarity achieved between some groups of splitting verbs that share one element, but the exact contribution each gives to the meaning of the whole in his analysis is never explicitly stated.

- b. Example from Sebba (1987)  
 Adé le Akin wa ilé.  
 Adé drive Akin come home  
 ‘Adé drove Akin home.’

The fact that some splitting verbs cannot be broken down into two independent lexical verbs creating a compositional meaning is explained as these being idiomatic constructions. All analyses of this phenomenon face the same difficulty of accounting for the restriction on which verbal elements can combine.

In contrast, Awobuluyi (1967; 1971) takes the other route and argues that splitting verbs are one lexical item, requiring a different analysis. He considers them their own verb class. In support of his stance considering them as one lexical item, he points out that often neither half of the splitting verb currently functions as an independent verb, and in these constructions a similar verb usually can not be switched in to retain the correct meaning even when the verb phrase is somewhat decomposable. In addition, he points out that their sharing of an object is insufficient to classify them as serial verbs. If they were serial verbs sharing an object, one should be able to paraphrase a sentence with a splitting verb using coordination to create two sentences where the object appears with each verb separately, which he attempts in (7). However, he reports that the two sentences are not semantically identical, and that the coordinated version is ungrammatical, due to a selectional restriction that *gbó* ‘hear’ is unable to take humans as objects.

(7) Examples from Awobuluyi (1967)

- a. Bólá gbà      şíkágò gbó  
 Bola believed<sub>1</sub> Chicago believed<sub>2</sub>.  
 ‘Bola believed Chicago.’
- b. \* Bólá gbà      şíkágò ó      sì gbó o  
 Bola received Chicago 3sg-Subj and heard 3sg-Obj.  
 Intended lit. ‘Bola received Chicago and heard him.’

Additionally, *gbàgbó* ‘believe’ can be used with animate objects, but the second verbal half *gbó* can not when functioning independently, so they have different animacy restrictions (Awobuluyi 1967). This is also indicative that splitting verbs should not be analyzed as sharing an object in exactly the same way that serial verbs are. The inability to coordinate two clauses with each half of the splitting verb in separate clauses would also follow directly in an analysis that considers them noncompositional (or idioms).

More recently, Bode (2000) merged the two halves of a splitting verb separately in his analysis, yet emphasized that they are regarded as a single unit semantically. So in his analysis there is only one VP for splitting verbs, but two verbal elements are inserted into it at different locations. His is the most comprehensive work documenting Yoruba verb structure, and he is able to capture many generalizations with his approach. He proposes for all verbs in Yoruba that they move twice. First from V, they move to Asp to check aspectual requirements, and from there they move to *v*. In turn, the argument moves to Spec Asp. In the case of splitting verbs, however, he places the second verbal element in V, which then moves to Asp as per usual. The first verbal element he merges in *v* directly, thus achieving the SV<sub>1</sub> OV<sub>2</sub> order. This creates a structure as in Figure 1.

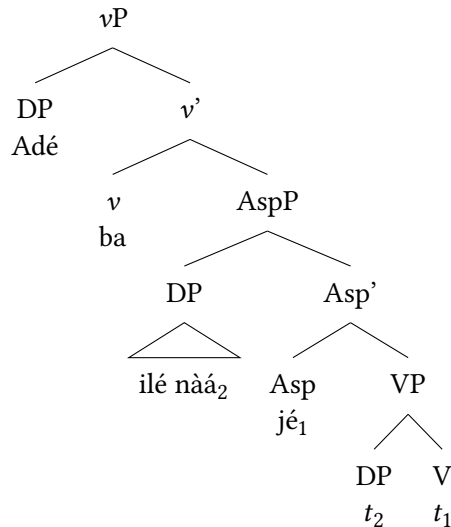

Figure 1: Bode's structure for splitting verbs sentences like (2a)

In cases without a splitting verb, the V head in Asp moves to *v*, which yields the correct SVO order. Thus his account for splitting verbs is that merging V<sub>1</sub> in *v* has blocked movement of Asp to *v*, with the result of the argument being between the two verbal elements, as it still moves to Spec Asp. In the case of intransitives like (3b), the argument will again move to be pulled up to subject position by an EPP feature on T, thus also yielding the correct word orders for the splitting verbs that have a causative/inchoative alternation.

## 2.2 Possible parallels outside Yoruba

One fairly well-known possible parallel for splitting verbs is particle verbs, as in English or German. While native speakers of English report a less strong intuition that *look up* in a sentence like *I looked it up in the dictionary* comprises one lexical item, it is clear that this is similarly two lexical items combining in a semi-idiomatic way. Particle verbs in English and German are semi-formulaic in their composition of a verb plus a preposition, where there is evidence that the verb and particle start together (Johnson 1991). However, English particle verbs have variable order (both *look the word up* and *look up the word* are acceptable), meaning that it is not the best correlate to splitting verbs in Yoruba, which do not have multiple possible orders. In German particle verbs, the split, or lack thereof, is dictated by the syntactic structure of the sentence, with examples below from Zeller (2001). As German is a V2 language, in finite clauses the verb moves, stranding the particle, and in nonfinite clauses it does not, so the verb and particle appear together.

- (8) a. Peter steigt in den Bus ein  
Peter climbs in the bus PART  
'Peter gets on the bus'  
(cf. \*Peter einsteigt in den Bus)
- b. weil Peter in den Bus einsteigt  
because Peter in the bus PART-climbs  
'because Peter gets on the bus'

In Yoruba splitting verbs as well, the split is wholly syntactic and obligatory with the presence of a direct object.

Given the semi-idiomatic meaning, it should be the case that the two pieces are interpreted together, even though the variable word order makes it less apparent. Focusing on particle verbs in German, Zeller (2001) reviews two main approaches to analyzing their structure: a morphological approach that considers the two pieces a verbal compound and a syntactic approach that considers a PartP of sorts as complement to the V.

In both of these approaches, the particle is moved to where it can enter into a relationship with the V at some point in the derivation in order to get this particle verb reading, distinct from a plain verb + preposition structure. Zeller argues for a version of the syntactic approach where the particle is base-generated in such a position. Given the separability of the verb from its particle, they must be two distinct heads, else verb movement would necessarily entail movement of both



halves. For English particle verbs, Zeller (2001) cites Emonds (1972) in showing that particle verb constructions license the use of *right*, like prepositions and unlike verbs, such as in *He looked the answer right up*. This is in support of the claim that the particle is a separate phrase, and not a part of the word/verb. He gives the following structures for particle verbs, where the head direction can be reversed to reflect the differing order between languages, such as English and German. An example is given in (9), with the corresponding structure in Figure 2, where there is an argument, and it is merged in specVP.

- (9) die Tür ab -schließt  
the door PART -lock

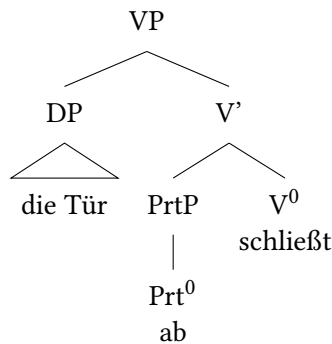

Figure 2: Structure for (9)

Many authors (Bode 2000; Adewole 2007; Awobuluyi 1971; Awóyalé 1974; Bamgboṣe 1966 among others) have reported that both elements of a splitting verb were at one point in their history able to contribute meaning to the sentence. That is, each one was, at one point, a full verb, even though in Modern Yoruba it is sometimes the case that reconstructing what that verb was or what it meant is impossible. Thus both halves of splitting verbs in Yoruba seem to come from verbs historically, but have undergone a process of semantic bleaching, similar to how many verbs in Niger-Congo languages have become complementizers or become more preposition-like over time (Lord 1993).

Although this phenomenon shows up in Germanic languages as particle verbs, other languages also have structures with two verbal elements that act similar to Yoruba splitting verbs. Sande (2016) has documented a similar phenomenon in Guébie, a Kru language spoken in Côte d'Ivoire. Guébie has V to T movement, resulting in an SAuxOV word order when there is an auxiliary in T, or otherwise

SVO when there is not. As seen in (10c), a class of verbs exists where only part of it moves to T, creating a split within the verb.

- (10) a. e<sup>4</sup> ji<sup>3</sup> ʒaci<sup>23.1</sup> jokuni<sup>2.3.4</sup>.  
I will Djatchi visit  
'I will visit Djatchi.'
- b. e<sup>4</sup> ni<sup>4</sup> ʒaci<sup>23.1</sup> joku<sup>2.3</sup>.  
I visit.PFV Djatchi PART  
'I visited Djatchi.'
- c. \*e<sup>4</sup> jokuni<sup>2.3.4</sup> ʒaci<sup>23.1</sup>.  
I visit.PFV Djatchi  
Intended: 'I visited Djatchi.'

These verbs in Guébie share some parallels with Yoruba splitting verbs and other particle verbs: the meaning is not fully decompositional, nor are any of these particles fully productive in their combining with other verbs to make a particle verb, and their split is syntactically motivated. However, Guébie is not closely related to Yoruba, and the other half of its splitting verbs share much more similarity with prepositions than other verbs. Ogie (2009) also reports in passing that splitting verbs appear in Edo, which is closely related to Yoruba, although an analysis is not made in that paper.

### 3 Aspectual marker *tún*

There exists one case beyond just those verbs with the causitive/inchoative alternation that produces the halves of the splitting verbs string adjacent. This other environment is created by what has been referred to in the literature as a preverb, or adverb (Bamgboṣe 1966; Bode 2000). The word *tún* has two distinct meanings, corresponding with two different word orders. When it means 'also', as in (11c), it maintains the regular SVO order seen in (11a). When it means 'again', however, it appears before the object, and the sentence surprisingly appears to be SOV. This word order is seen in (11b).

- (11) a. O se adiyè nàà.  
3sg-Subj cook chicken the  
'He cooked the chicken.'

- b. O            tún adiye nàá se.  
           3sg-Subj TUN chicken the cook  
           ‘He cooked the chicken again.’
- c. O            tún se adiye nàá.  
           3sg-Subj TUN cook chicken the  
           ‘He also cooked the chicken.’

Verbs that are always intransitive are ambiguous between the ‘again’ and ‘also’ readings.

- (12) Adé tún subu.  
           Adé TUN fall  
           ‘Adé fell again.’ or ‘Adé also fell.’

With German particle verbs, there are two possible words orders but a syntactic element, the clause type, determines which one appears. For splitting verbs too, the differing word order tells us this ambiguity is a structural one, which might shed light on verb movement in Yoruba. This pattern is robust, and if we look at the data with *tún* and splitting verbs, we see the pattern repeated; the ‘again’ meaning disrupts the word order. When *tún* means ‘also’, it appears before the verb, which splits like normal. The SV<sub>1</sub> OV<sub>2</sub> order is preserved, as in (13a). When *tún* means ‘again’, the word order is disrupted. Thus in (13b), the order is SOV<sub>1</sub> V<sub>2</sub>, and both halves of the splitting verb appear after the object.

- (13) a. Adé tún tòn        Akin jẹ.  
           Adé TUN deceive<sub>1</sub> Akin deceive<sub>2</sub>  
           ‘Adé also deceived Akin.’
- b. Adé tún Akin tònjẹ.  
           Adé TUN Akin deceive  
           ‘Adé deceived Akin again’

Given Bode’s analysis of verb movement as passing through Asp, the ordering of the verb after the object in (11b) indicates that this movement is being blocked. Assuming Bode’s analysis of verb movement to be correct, if *tún* is blocking the verb from moving to *v*, linearly preceding the object in Spec Asp, it must be in either *v* or in Asp when low and interpreted as ‘again’. Given that ‘again’ could be considered to convey an iterative sort of aspect, we posit that in these cases, *tún* is functioning as an aspectual marker, as opposed to its use when it means ‘also’. By blocking the verb movement, the correct SOV order results. In

the ‘also’ reading, *tún* is acting as an adverb, rather than Asp head, and thus is attaching in a higher adverb position and does not affect the word order in the verb phrase. With a higher attachment, the verb movement to Asp and then to *v* is not blocked, and thus the correct SVO order is achieved. Using a non-splitting verb to illustrate, we posit the structures in Figure 3 and Figure 4 to achieve (11c) and (11b), respectively.

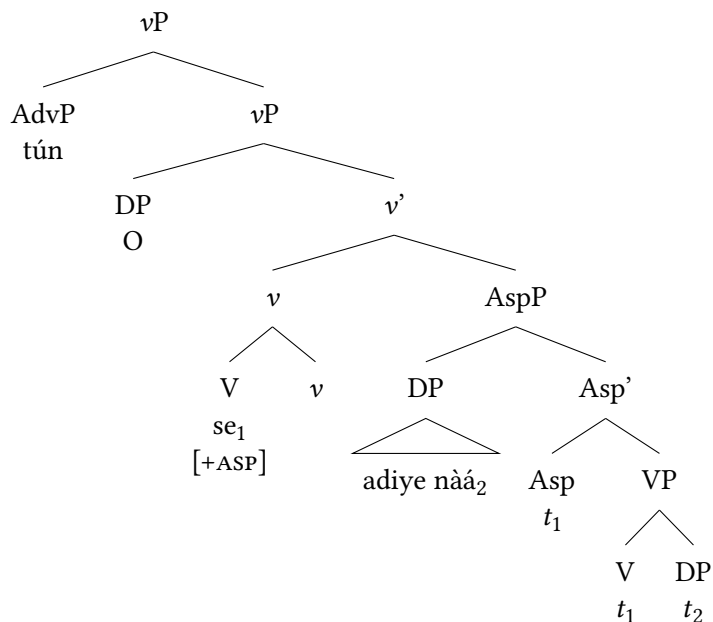

Figure 3: Structure meaning ‘also’ (11c)

In accord with *tún* acting as an Asp head, there are ordering interactions between this and other Asp particles. When *tún* is acting as Asp head and blocking the split, it must be lower in the structure than *ma*, which marks future tense. This is the order in (14a), in contrast to the reverse, ungrammatical ordering in (14b). When functioning as a regular adverb, allowing the split and meaning *also*, *tún* can attach either higher or lower than Tense, as shown in (15).

- (14) *Tún* as Asp head, meaning *again*
- a. *Adé ma tún ilekun nàá pa-de.*  
*Adé will TUN door the close<sub>1-2</sub>*  
 ‘Adé will close the door again.’

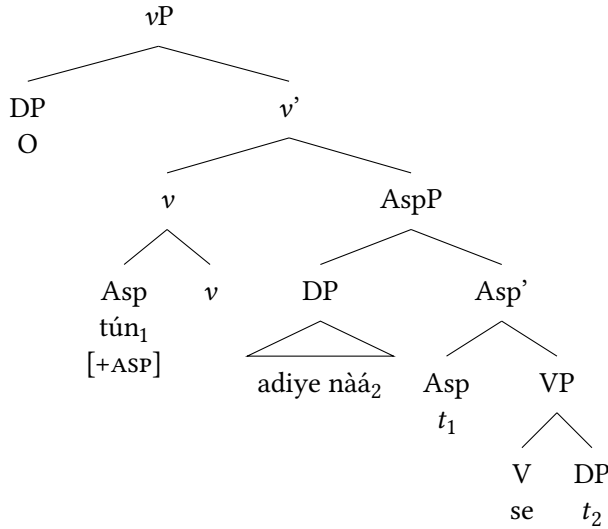

Figure 4: Structure meaning ‘again’ (11b)

- b. \* Adé tún *ma* ilekun nàa **pa-de**.  
 Adé TUN will door the close<sub>1-2</sub>  
 Intended: ‘Adé will close the door again.’

(15) *Tún* as adverb, meaning *also*

- a. Adé tún **ma pa** ilekun nàa de.  
 Adé TUN will close<sub>1</sub> door the close<sub>2</sub>  
 ‘Adé will also close the door.’
- b. Adé *ma* tún **pa** ilekun nàa de.  
 Adé will TUN close<sub>1</sub> door the close<sub>2</sub>  
 ‘Adé will also close the door.’

We can conclude that there is an aspectual ordering, in that *tún* can not order before a tense morpheme and still mean *again*. When ordered before a tense morpheme, the only possible reading is the *also* reading. There is a clear difference between the structures allowing each possible reading. When acting as a regular adverb, *tún* attaches higher than aspect. In particular, the use of *tún* as an aspectual marker will allow us to shed light on the structure of splitting verbs, as they crucially rely on aspect in the course of their derivation.

One thing that would allow us to confirm our analysis of *tún* as an aspectual marker would be if we could find another aspectual particle that has the same effect on word order. There is extensive discussion by Awóyalé (1974) on the status of preverbs in Yoruba in general, where he notes that *tún* appears to be the only element among the modifiers listed that has the syntactic effects that it does, thus our analysis is specific to the interaction of *tún* and splitting verbs.

## 4 Analysis of splitting verbs

### 4.1 Predictions of the previous analysis

Returning to the structure that was proposed by Bode (2000) that was shown in Figure 1, we will show in this section that the previous analysis is unable to account for the surface structure of sentences that contain both splitting verbs and *tún* when it is used as an aspectual marker.

Given that Bode's structure has the first verbal element appearing on *v*, and given that the evidence for the structural position of *tún* discussed in §3 showed that *tún* is merged in *Asp*, we would predict that *tún* should remain lower than the first verbal element, as shown in (16):

- (16) Structure for Bode's prediction of (13b)  
 $[_{VP} \text{ Adé } [_{v'} \text{ t\`an } [_{AspP} \text{ Akin } [_{Asp'} \text{ t\`un } [_{VP} \text{ j\`e} ]]]]]]$

However, such a structure incorrectly predicts that the word order of the resulting sentence should be what is shown in (17), rather than the correct word order (*Adé tún Akin t\`anj\`e*):

- (17) \* *Adé t\`an tún Akin j\`e*

The lack of a split in examples like (13b) can be taken as evidence that verbs splitting is, in fact, the result of movement, much as the regular SVO order is. Considering that an intermediate adjunction point in the derivation of splitting verb structures needs [*Asp*], as Bode showed, we show that placing *tún* on [*Asp*] changes the surface structure. The simplest explanation for this difference is that the presence of the aspectual marker has blocked movement of  $V_1$ .

The simplest way to explain the blocking of movement, however, is to assume that both verbal elements used to create a splitting verb originate lower in the structure. Crucially, we cannot say that  $V_1$  has been merged in *v* directly, as was claimed by Bode (2000), because this derivation gives the incorrect word order shown in (17). Given the need for this slight change in the analysis that was proposed by Bode, we propose the following structure in Figure 5 for a sentence

with a normal split like (2a), which is repeated below as (18a). The structure in Figure 6 then gives the sentence in (18b) where  $V_1$  and  $V_2$  appear string adjacent due to the presence of *tún*. We propose that there are two verbal heads, the second of which has the argument as its complement. The reasoning for the argument being the complement of the second verb is discussed in the following section.

- (18) a. Adé ba ilé nàá jé.  
 Ade destroy<sub>1</sub> house the destroy<sub>2</sub>  
 ‘Ade destroyed the house.’  
 b. Adé tún ilé nàá bajé,  
 Ade TUN house the destroy  
 ‘Ade destroyed the house again.’

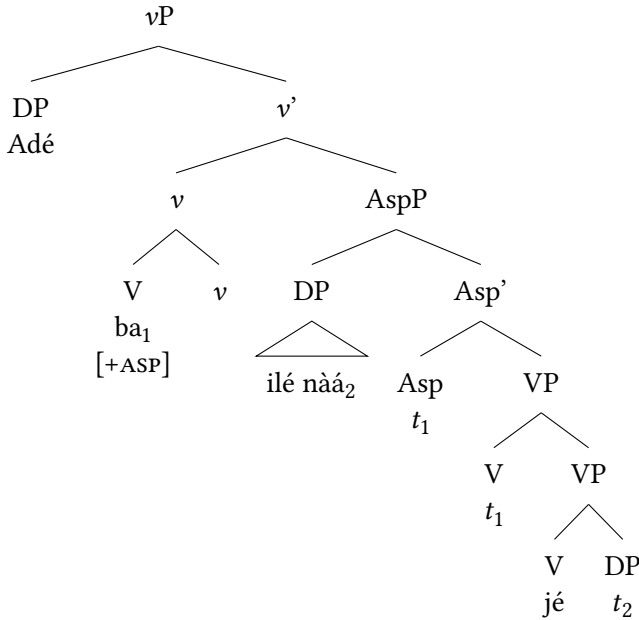

Figure 5: Proposed structure for (18a)

The derivation expressed in Figure 5 deviates little from Bode’s analysis of regular verb movement. The object moves to Spec Asp, and the verb moves through Asp to *v*. The difference is that in this case, the verb movement is being undertaken by the first verbal element, which is still the appropriate head of the next phrase down the tree. The second half of the splitting verb remains in place, also

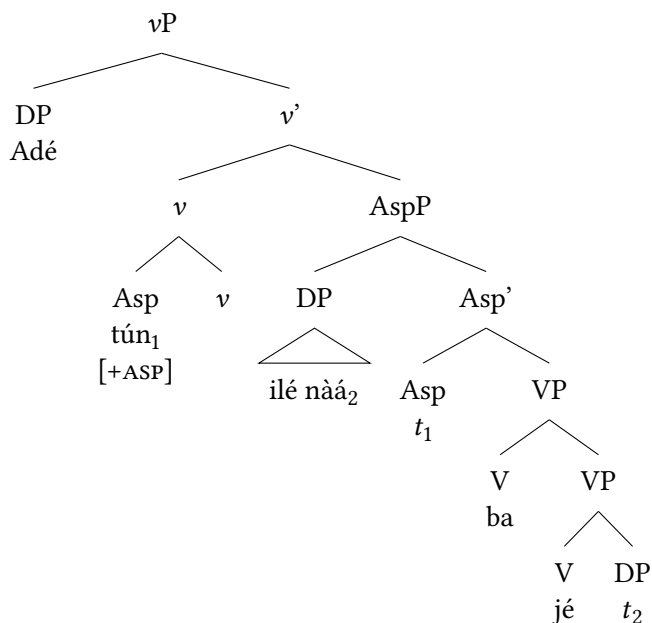

Figure 6: Proposed structure for (18b)

generated low, and thus the  $SV_1 OV_2$  order results. Importantly, considering the likely development of splitting verbs from serial verb constructions, this structure also parallels some proposed structures for serial verb constructions in that the first verbal element merges as the head in a head-complement relation with the second verbal element and the argument, similar to a proposal by Baker & Stewart (2002). This analysis thus aligns splitting verbs more closely with serial verbs, as has been proposed by Bamgboṣe (1966). The resulting structure also parallels analyses of particle verbs in Germanic languages, while following Bode’s insights on verb movement in Yoruba. Unlike English, we see that there is obligatory movement of one part of the splitting verb. This is a similar analysis to the one given for German, but unlike in German, where V moves to C, the word order change in Yoruba results from V moving to  $v$ , as was shown by Bode (2000). Another difference worth mentioning is that particle verbs are verb + preposition, and splitting verbs are two verbal elements.<sup>3</sup>

<sup>3</sup>A good test for whether the structure might look like the one Sande (2016) proposed for Guébie, with the two verbal elements forming a constituent, would be to test it with gapping. However, for independent reasons, Yoruba does not allow gapping. See Lawal (1985) for discussion of gapping in Yoruba.



In a tree like Figure 6, the correct word order is achieved with the addition of *tún* as well. As concluded in the previous section, *tún* is merged in Asp, which blocks the normal verb movement to *v* via Asp. Here, when merged in Asp, *tún* blocks the same movement for the first verbal element, as that is the head of the main VP. Thus the two verbal elements are realized string adjacent while head movement to *v* occurs with *tún* rather than  $V_1$ .

By positing that  $V_1$  and  $V_2$  are merged in in a head-complement relationship, this analysis more directly captures the semantic relationship of the two elements. By generating the verbal elements both within the VP, our analysis is more in accord with the native speaker intuitions that both parts of the verb are interpreted as a unit. But given that the pieces move independently and are separable, they must also be independent phrases (in accord with Zeller's analysis of particle verbs).

#### 4.2 Complement vs. relative clauses

One remaining question this analysis brings up is that if there are two verb heads, which takes the DP object? Noun complement clauses (NCCs) and relative clauses (RCs) are a useful tool to bring to bear on this question. While not the case for all speakers, there are some who make a clear distinction between the way RCs and NCCs pattern when they occur as part of the object of a splitting verb, as shown in (19) and (20):

(19) NCC examples

- a. Ife **gba** alo **nàá gbo** pe Lola ri eni **nàá**.  
 Ife believe<sub>1</sub> story the believe<sub>2</sub> that Lola see person the  
 'Ife believed the story that Lola saw the person.'
- b. \* Ife **gba** alo **nàá** pe Lola ri eni **nàá gbo**.  
 Ife believe<sub>1</sub> story the that Lola see person the believe<sub>2</sub>  
 'Ife believed the story that Lola saw the person.'

(20) RC examples

- a. ? Ife **gba** alo **nàá gbo** ti Akin pa.  
 Ife believe<sub>1</sub> story the believe<sub>2</sub> that Akin tell  
 'Ife believed the story that Akin told.'
- b. Ife **gba** alo **nàá** ti Akin pa **gbo**.  
 Ife believe<sub>1</sub> story the that Akin tell believe<sub>2</sub>  
 'Ife believed the story that Akin told.'

For speakers with this distinction, the NCC in (19a) *must* follow  $V_2$ , though a RC, as in (20a), is strongly dispreferred in that position.<sup>4</sup>

Analyses of these structures suggest a syntactic difference between NCCs and RCs, such that the NCCs are created through a predicative relationship between the DP and CP, whereas in RCs, the NP raises out of the CP. Den Dikken & Singhapreecha (2004) describes this in Thai and Mandarin, and Joshi (2016) notes a similar pattern in Marathi. The effect is that NCCs have a phrase that is further separated from the noun when compared to RCs.

<sup>4</sup>When the RC contains a larger, or “heavier”, constituent, speakers report that the extraposition is more acceptable. However, the distinction between (19) and (20) remains.

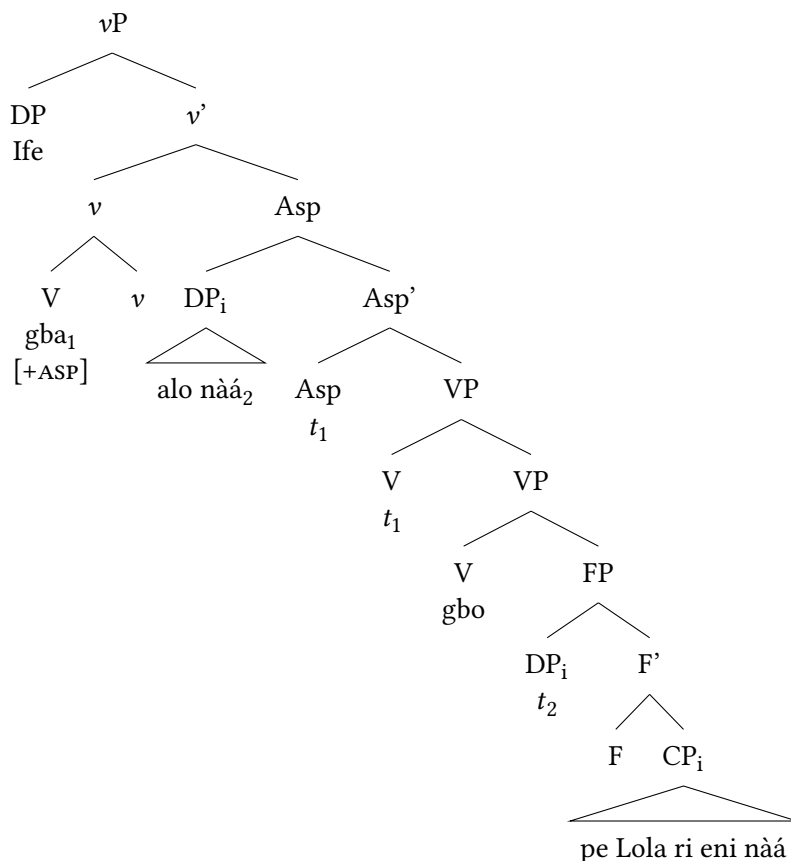

Figure 7: Structure for (19a)

- (21) NCC structure adapted from Den Dikken & Singhapreecha (2004)  
 [<sub>FP</sub> [<sub>DP</sub> *alo nàá* ] [<sub>F'</sub> F [<sub>CP</sub> *pe Lola ri eni nàá* ] ] ]

This structure for NCCs is able to account for what we see with splitting verbs: the DP and CP appear separately, split by the second verbal element. To account for the word order, however, it must be the case that the entire functional phrase is the object of the lower, rather than the higher verbal element.

Were it the case that  $V_1$  is merged with the argument, then we would expect the entire NCC to occur between  $V_1$  and  $V_2$ . Structures with relative clauses do show up between the two verbal elements, as the CP of a relative clause is within the DP (we assume a raising analysis of relative clauses), and thus can not move separately.

## 5 Conclusion

Here we have attempted to provide an analysis of the structure of splitting verbs in Yoruba, which has been the topic of some debate in the literature. Considering the data on verb movement, we conclude that the split results from the standard Yoruba verb movement, and thus the two halves of the verb must both be generated low. We consider the arguments made for particle verbs here as well, and conclude that regardless of whether both verbal elements are viable verbs in Yoruba now, both halves should be independent phrases, rather than a compound. And finally, we incorporate evidence from Marathi noun complement clauses to support the argument that the object of a splitting verb is syntactically complement to the lower verbal element.

Our final analysis is minimally different from the one presented by Bode (2000), however the changes we made allowed us to account for the additional data presented here using aspectual *tún*. These changes also put the analysis more in line with proposals for serial verb constructions, in keeping with their likely evolution from serial verbs.

## Acknowledgements

The authors would like to sincerely thank their three consultants: Tolulope Odebunmi, Adebayo Adenle, and Olayemi Awotayo. Without their hours of help and patience, this project would not have been possible. We also thank Alan Munn for his comments and suggestions on earlier drafts, and the anonymous reviewers for many helpful comments.

## Abbreviations

Asp	Aspect
NCC	Noun complement clause
RC	Relative clause

## References

- Adewole, Stephen Monday. 2007. *Yoruba word formation processes*. University of California at Los Angeles. (Doctoral dissertation).
- Awobuluyi, A. Oladele. 1967. *Studies in the syntax of the standard Yoruba verb*. Columbia University. (Doctoral dissertation).
- Awobuluyi, A. Oladele. 1971. *Splitting verbs in Yoruba*. Vol. 1. 151–164.
- Awóyalé, James Oládùntóyè Yíwolá. 1974. *Studies in the syntax and semantics of Yoruba nominalizations*. University of Illinois, Urbana-Champaign. (Doctoral dissertation).
- Baker, Mark & Osamuyimen T. Stewart. 2002. *A serial verb construction without constructions*. Ms., Rutgers University.
- Bamgbose, Ayo. 1966. *A grammar of Yoruba*. Cambridge: Cambridge Univ Press.
- Bode, Oduntan Gbolahan. 2000. *Yoruba clause structure*. University of Iowa. (Doctoral dissertation).
- Den Dikken, Marcel & Pornsiri Singhapreecha. 2004. Complex noun phrases and linkers. *Syntax* 7(1). 1–54.
- Emonds, Joseph. 1972. Evidence that indirect object movement is a structure-preserving rule. *Foundations of Language* 8(4). 546–561.
- Johnson, Kyle. 1991. Object positions. *Natural Language & Linguistic Theory* 9(4). 577–636.
- Joshi, Amaresh. 2016. Marathi complement clause structure. Graduate Linguistics Expo at Michigan State.
- Lawal, Nike. 1985. Why verbs do not gap in Yoruba. *Journal of African Languages and Linguistics* 7. 155–162.
- Lord, Carol. 1993. *Historical change in serial verb constructions*. Amsterdam: John Benjamins.
- Ogie, Ota. 2009. *Multi-verb constructions in Edo*. Trondheim. (Doctoral dissertation).
- Sande, Hannah. 2016. *Particle verbs and focus in Guébie*. Berkeley Syntax and Semantics Circle.
- Sebba, Mark. 1987. *The syntax of serial verbs*. Amsterdam: John Benjamins.
- Zeller, Jochen. 2001. *Particle verbs and local domains*. Amsterdam: John Benjamins.

## Chapter 29

# Animacy is a presupposition in Swahili

Jonathan Pesetsky

ILLC, University of Amsterdam

In this paper, I argue that the phenomenon of animacy override in Swahili arises from the interaction between a syntactic structure with multiple nominal heads and general principles of distributed morphology. This syntactic analysis narrows the possibilities for a semantic analysis of animacy, strongly suggesting an approach previously proposed for gender in Romance languages. Specifically, I argue that Swahili has an interpretable +ANIMATE feature which denotes a partial function which is defined only on animate predicates of type *et* and which denotes the identity function where it is defined.

## 1 Introduction

In this paper, I argue that a puzzle in the distribution of animate morphology in Swahili arises from the interaction between a syntactic structure with multiple nominal heads and general principles of Distributed Morphology. This syntactic analysis narrows the possibilities for a semantic analysis of animacy, strongly suggesting an approach previously proposed for gender in Romance languages. The central puzzle of this paper is presented in (1), which shows that Swahili animate-denoting nouns obligatorily trigger animate agreement whether or not they themselves bear animate prefixes.

- (1) a. **Ki-ongozi w-etu m-refu a-li-anguka.**  
7-leader 1-our 1-tall 1-PST-fall  
'Our tall leader fell down.'
- b. \* **Ki-ongozi ch-etu ki-refu ki-li-anguka.**  
7-leader 7-our 7-tall 7-PST-fall



I call this phenomenon *animacy override*, adopting a term from Carstens (1991) (who used it to refer to a particular explanation for the phenomenon). Animacy override occurs obligatorily with all nouns whose referents are prototypically animate. My analysis of animacy override is summarized in (2).

- (2) a. Animate morphology is a realization of an interpretable +ANIMATE feature  
b. Other forms of noun morphology are realizations of an uninterpretable GENDER feature  
c. The head hosting +ANIMATE is higher than that hosting GENDER  
d. +ANIMATE is interpreted as a presupposition

The paper is organized as follows. In §2, I introduce Swahili's non-animate noun classes and propose an analysis. This analysis will serve as the basis for the rest of my discussion. In §3, I introduce the animate noun class and animacy override and propose an analysis. In §4, I show that my analysis can be extended to explain the fact that possessors of kinship terms are immune to animacy override. In §5, I raise the puzzle of how the syntax "knows" that a root denotes something animate and show that three potential solutions do not suffice. In §6, I advance my solution to this puzzle, namely that animacy triggers a presupposition.

## 2 Swahili noun classes: Basic facts and a basic analysis

Like other Bantu languages, Swahili divides its nouns into several noun classes whose members share a common prefix and trigger common agreement patterns on all of their dependents. Bantu noun classes are sometimes discussed as if they picked out semantically coherent groups of objects, but this is not true of Swahili noun classes (with the exception of the animate class, which I introduce in §3.1). The nouns in (3), for instance, all belong to class 9/10, but have nothing in common otherwise, since they include kinship terms, animal terms, plant terms, artifact terms, and abstract nouns.<sup>1</sup>

- (3) *n-dugu* 'sibling', *n-cha* 'spear', *n-dizi* 'banana', *n-yani* 'monkey', *n-geli* 'noun class', *n-guvu* 'strength'

Moreover, we can find groups of near-synonyms spread throughout the entire Swahili noun class system. Example (4) shows that there are terms for different kinds of boats in classes 3/4, 5/6, 7/8, and 9/10.

---

<sup>1</sup>For simplicity, I refer to pairings of singular and plural forms as a single class.

- (4) *m-tumbwi* (class 3/4) ‘canoe’,  $\emptyset$ -*jahazi* (class 5/6) ‘big sailboat’, *ch-ombo* (class 7/8) ‘boat’, *n-gawala* (class 9/10) ‘outrigger’

Because non-animate class prefixes in Swahili are not strictly determined by the semantics of the nouns they appear on, I adopt the proposal from Carstens (1991; 2008) that they are realizations of an uninterpretable GENDER feature, although I depart from Carstens’s analysis in ways which will be discussed in later sections. Values of this uninterpretable feature are then realized by rules of the general form shown in (5), which may be less specified in cases of syncretism.

- (5) a.  $n, u[\text{GENDER:3}], i[+\text{SG}] \longleftrightarrow \text{mu-}$   
 b.  $n, u[\text{GENDER:3}] \longleftrightarrow \text{mi-}$   
 c.  $u[\text{GENDER:3}], i[+\text{SG}] \longleftrightarrow \text{u-}$   
 d.  $u[\text{GENDER:3}] \longleftrightarrow \text{i-}$

Following Kramer (2015), I assume that GENDER is introduced on an n-head which is sister to the root. As exemplified by the lexical entry in (6), roots are sorted into classes as a consequence of syntactic selection by categorizing heads marked for GENDER. Each of these heads selects for a disjunctive list of roots.

- (6)  $n[u\text{GENDER:3}], [\text{SEL} : \sqrt{\text{tree}}, \sqrt{\text{river}}, \dots]$

### 3 Animacy in Swahili

#### 3.1 The animate noun class

In contrast to the noun classes discussed in the previous section, class 1/2 picks out a semantically coherent group of nouns, namely a subset of those with animate denotations. Examples are shown in (7).

- (7) *m-toto* ‘child’, *m-walimu* ‘teacher’, *m-tekanyara* ‘hijacker’, *m-dudu* ‘insect’, *m-nyama* ‘animal’, *m-duma* ‘boogeyman’, *mw-anaisimu* ‘linguist’

To explain this generalization, I posit an interpretable binary animacy feature spelled out as in (8). Note that there is only a single realization rule for the plural since all modifiers take the class prefix *wa-* regardless of syntactic category.

- (8) a.  $n, i[+\text{ANIMATE}], [+\text{SG}] \longleftrightarrow \text{mu-}$   
 b.  $i[+\text{ANIMATE}], [+\text{SG}] \longleftrightarrow \text{yu-}$   
 c.  $i[+\text{ANIMATE}] \longleftrightarrow \text{wa-}$

As with the other noun classes, the mechanism that assigns class 1/2 to roots is selection. If a root is selected for by an n-head bearing the feature value +ANIMATE, then it is in class 1/2. The only difference between the behavior of GENDER and ANIMATE so far is that the former is uninterpretable while the latter is interpretable. I will address the question of how ANIMATE is interpreted in §5, where I argue that +ANIMATE is interpreted as a presupposition of animateness.

### 3.2 Animacy override

All class 1/2 nouns are animate-denoting, but not all animate-denoting nouns belong to class 1/2. Some examples of animate-denoting nouns belonging to classes other than 1/2 are shown in (9).

- (9) *m-tume* ‘messenger’, *jirani* ‘neighbor’, *ki-ongozi* ‘leader’, *n-yani* ‘monkey’

Strikingly, even though these nouns do not belong to class 1/2, they still trigger class 1/2 agreement. I call this phenomenon *animacy override*. Animacy override is obligatory on all modifiers of all animate-denoting nouns, with one exception which I will discuss in §4.

- (10) a. **Ki-ongozi w-etu m-refu a-li-anguka.**  
           7-leader 1-our 1-tall 1-PST-fall  
           ‘Our tall leader fell down.’  
       b. \* **Ki-ongozi ch-etu ki-refu ki-li-anguka.**  
           7-leader 7-our 7-tall 7-PST-fall

This phenomenon poses a puzzle. Why are these nouns able to bear prefixes from one class but trigger agreement in another class? My analysis consists of the three claims in (11).

- (11) a. The n-head bearing +ANIMATE selects for the category feature n as well as for some roots.  
       b. The n-heads bearing GENDER do not select for n, only for roots.  
       c. n, [+ANIMATE]  $\leftrightarrow \emptyset / \_ n$

Claims (11a) and (11b) together entail that when ANIMATE and GENDER coexist in an nP, ANIMATE will always be syntactically higher. This result is useful for explaining Animacy Override because, as argued in Kramer (2015), only the highest n in a stack of nP’s can be agreed with. This is because n is a phase boundary and the Phase Impenetrability Condition entails that agreement cannot take place



across a phase boundary. Consequently, when GENDER and ANIMACY coexist in an nP, any modifiers of that nP will agree for ANIMACY and not for GENDER.

The tree in Figure 1 shows the structure for the noun phrase *ki-ongozi m-refu* ‘tall leader’. In this tree, the adjective phrase looks downwards to find values for its noun class features. It receives a value for ANIMATE from the higher n-head but cannot receive a value for GENDER from the lower n head since doing so would require agreement across a phase boundary. The a-head is spelled out as *m-* using (5a), while the lower of the two n-heads is spelled out as *ki-* using the analogous rule for class 7/8.

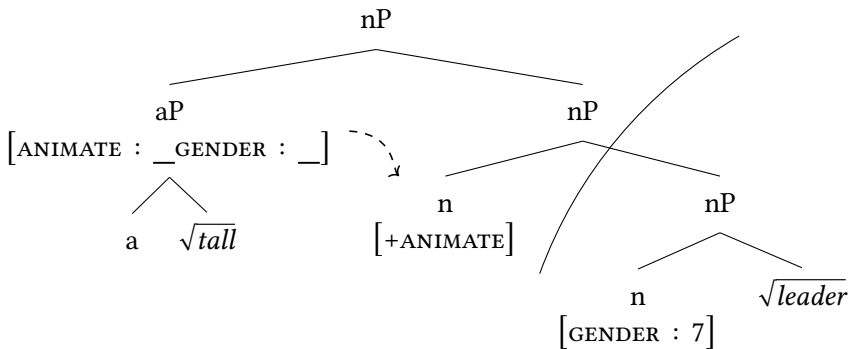

Figure 1: Structure of *ki-ongozi m-refu*. The dotted arrow represents agreement. The lower solid arc shows a phase boundary.

So far I have explained why in these situations, agreement is for ANIMATE rather than GENDER. However, claims (11a) and (11b) alone would wrongly predict the possibility of noun class stacking, for instance in realizing the nominal structure in Figure 1 as \**m-ki-ongozi*. Claim (11c) prevents this wrong prediction by providing a null realization for +ANIMATE in the presence of a GENDER feature. Thus, these three claims add up to an analysis of Animacy Override.

It is interesting to compare this account offered above with the proposal of Carstens (1991), who argued that when a non-animate prefix appears on an animate-denoting stem, it is because the stem’s lexical entry is marked with an *exception feature*. The exception feature instructs the grammar to treat the root as if it were in a different noun class for the purpose of realizing its noun class prefix. Thus, in her analysis, the lexicon contains a list like (12).

- (12) Animate nouns: adapted from (10) in Carstens (1991)  
*-tu* ‘person’, *-ngu* ‘god’\*, *-rani* ‘neighbor’\*\*  
 \*apply formation rules for Gender 3, \*\*apply formation rules for Gender 5

This analysis allows for a simpler syntax than that proposed in (11a) and (11b). While my structure contains two nPs bearing different noun class features Carstens's analysis allows for a single nP which hosts a single noun class feature. This simpler syntax also allows her to avoid introducing a rule like (11c).

Thus, her analysis works well for the facts presented so far. In the next section I present evidence which favors an analysis that places this phenomenon in the syntax rather than in the lexicon.

## 4 An exception to animacy override

In the previous section, I briefly mentioned that animacy override has one exception. In this section, I present this exception and show that my analysis can easily account for it given an independently motivated claim about the syntax of Swahili relational nouns. This is in contrast to allomorphy-based analyses of animacy override, which require further stipulations to do so.

### 4.1 The puzzle

Alone among modifiers, pronominal possessors of some kinship terms in class 9/10 do not show animacy override. Not all kinship terms work this way, but those that do, do so obligatorily. This pattern is demonstrated in (13) with the kinship term *n-dugu*, meaning 'cousin' or 'sibling'.

- (13) a. N-dugu y-angu m-refu a-li-anguka.  
9-sibling 9-my 1-tall 1-PST-fall  
'My tall sibling fell down.'
- b. \*N-dugu w-angu m-refu a-li-anguka.  
9-sibling 1-my 1-tall 1-PST-fall

For a noun to behave this way, it is not sufficient for it to be in class 9/10, as shown by (14), where we see that the class 9/10 animal term *nyani* ('monkey') still shows animacy override on its possessor.

- (14) a. \*N-yani y-angu m-refu a-li-anguka.  
9-monkey 9-my 1-tall 1-PST-fall  
'My tall monkey fell down.'
- b. N-yani w-angu m-refu a-li-anguka.  
9-monkey 1-my 1-tall 1-PST-fall

However, merely being a kinship term is not sufficient either, as shown in (15), where we see that the class 1/2 kinship term *m-ke* ('wife') requires its possessives to be in class 1/2.<sup>2</sup>

- (15) a. \*M-ke y-angu m-refu a-li-anguka.  
           1-wife 9-my 1-tall 1-PST-fall  
           'My tall wife fell down.'  
       b. M-ke w-angu m-refu a-li-anguka.  
           1-wife 1-my 1-tall 1-PST-fall

#### 4.2 Evidence for a difference in syntactic height

It is not surprising that possessive constructions with kinship terms differ syntactically from those with other nouns, since they also differ semantically. As has been recognized since Partee (1983/1997), kinship terms are a subclass of relational nouns, denoting two-place functions rather than one-place ones. This distinction is formalized in (16) following Barker (1995).

- (16) a. [[**ndugu**]] =  $\lambda x \lambda y$ . **sibling**( $x, y$ )  
       b. [[**nyani**]] =  $\lambda x$ . **monkey**( $x$ )

Thus, possessors of relational nouns are arguments of the nouns themselves, while possessors of non-relational ("sortal") nouns are arguments of a separate possession operator. If this distinction in argument structure is represented syntactically, we might suppose that kinship possessors are syntactically lower than regular ones.

Furthermore, there is independent evidence that kinship possessors do in fact attach lower than others. As shown in (17), pronominal possessors can affix to the possessee, indicating that they are located within syntactic the domain where phonological processes apply.

- (17) a. Kaka y-angu ni m-jinga.  
           9.brother 9-my COPULA 1-idiot  
           'My brother is an idiot.'  
       b. Kaka-angu ni m-jinga.  
           9.brother-my COPULA 1-idiot

<sup>2</sup>An audience member at ACAL 47 pointed out to me that some class 1/2 kinship terms take class 9/10 possessives in the plural. I suspect that in these cases, some syntactic peculiarity of plural-marking may block animate agreement, causing class 9/10 morphology to be inserted as default agreement. I do not, however, have a definitive analysis at present.

This pattern is not possible with non-kinship terms, as shown in (18).

- (18) a. N-yani w-angu ni m-jinga.  
 9-monkey 1-my COPULA 1-idiot  
 ‘My monkey is an idiot.’  
 b. N-yani-angu ni m-jinga.  
 9-monkey-my COPULA 1-idiot

### 4.3 Analysis

In the previous subsection, I showed evidence that pronominal possessors have different syntactic heights depending on whether their possessees are relational or sortal. In light of this evidence, I propose the syntactic configuration in (2).

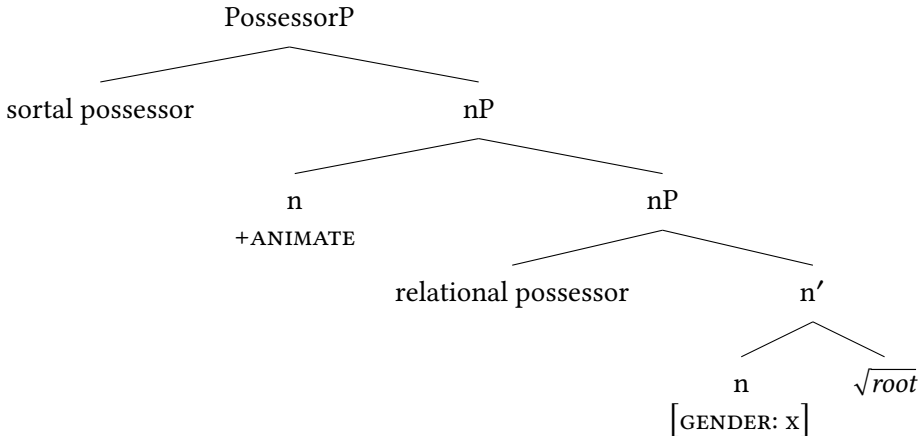

Figure 2: Structure of possessors in Swahili

This structure allows us to solve the puzzle posed in §4.1 by appealing to the positions of the two types of pronominal possessors relative to the two features GENDER and ANIMATE. Pronominal possessors of relational nouns merge between the low n-head which hosts GENDER and the higher n-head which hosts ANIMATE, while pronominal possessors of sortal nouns merge above the locus of both features.

This means that while sortal possessors can agree for animacy by agreeing downward, relational possessors would have to agree upwards in order to do so. Therefore, if Swahili has only downward agreement, the structure in (2) solves the puzzle of the contrast between (13) and (14). When the possessor in (13) looks

downward for a noun class feature, the first thing it sees is GENDER. When the possessor in (14) looks downwards, the first thing it sees is ANIMATE. Likewise, the possessor in (15) sees ANIMATE, since *m-ke* is intrinsically in class 1/2 and therefore has ANIMATE marked on the categorizing head next to the root instead of higher up in the structure.

One might reasonably be skeptical of my claim that Swahili has only downward agreement. Other Bantu languages have been argued to have only upward agreement, since postverbal subjects require default agreement. As shown in (19), from Taniguchi (2013), this is not the case in Swahili.

- (19) A-li-ki-vunja ki-ti Yohana  
 1-PST-7-break 7-chair John  
 'John broke the chair.'

In this section, I have shown that the analysis of Animacy Override which I advanced in the previous section, when combined with an independently motivated structure for relational possessors, accounts straightforwardly for one major exception.

This is in contrast to the aforementioned analysis advanced by Carstens (1991), in which animate-denoting nouns are all in class 1/2, but can receive prefixes from another class if their lexical entries contain exception features (12). Because exception rules only affect the realization of prefixes on the lexical items whose lexical entries they inhabit, they cannot serve as the basis for a satisfactory analysis of the facts in (13–15). To account for this data, a proponent of Carstens' analysis would need to posit that each regular pronominal possessive in Swahili has a homophonous and synonymous twin which is selected for only by kinship terms and which bears an exception feature in its lexical entry. Such a coincidence would be unlikely.

On the other hand, Carstens's analysis could be adapted so as to capture this data by translating it into the framework of distributed morphology. In this framework, exception features would be replaced with impoverishment rules of the sort shown in (20).<sup>3</sup>

- (20) \*[GENDER:1] / \_\_\_ { $\sqrt{\text{god}}$ ,  $\sqrt{\text{messenger}}$ , etc.}, repair by changing [GENDER:1] to [GENDER:3]

The key difference between exception features and impoverishment rules is that while the former affect only how noun class prefixes are realized on the noun

<sup>3</sup>Replacing them with context sensitive realization rules would lose the generalization that animates with non-animate prefixes don't change classes when they pluralize.

root, the latter affect how they are spelled out *anywhere in the context of the root*. If we suppose that for the sake of these rules, “in the context of X” means “in a position m-commanded by X” rather than “in a position sister to X”, then these rules predict (13) and (14). This is because kinship possessors are m-commanded by noun roots, while sortal possessors are not.

Thus, we can come up with an alternative analysis if we make the assumptions shown in (21).

- (21) a. Impoverishment can change feature values to less marked values (rather than deleting them)  
b. X is in the syntactic context of Y iff Y m-commands X (rather than iff X and Y are sisters)

These assumptions are not innocent, since they make our general theory of morphosyntax less constrained. Therefore, since my original analysis achieved the same empirical coverage but was able to do so within the traditional strictures of distributed morphology, I tentatively conclude that it is the stronger of the two. This conclusion should be revised if future work turns up strong evidence supporting the claims in (21).

## 5 Three ideas that don't explain how nouns get animate

In the previous sections, I argued that +ANIMATE occupies a higher position than GENDER when both coexist in a syntactic structure. This claim explains some otherwise puzzling patterns in the marking (or lack thereof) of animacy, but it raises some problems of its own. The value of the ANIMATE feature is determined entirely by the choice of noun root, but I have argued that the ANIMATE feature is in its own nP, where it cannot see which root is being used. This raises the question: how does the root determine the value of ANIMATE?

In this section, I go over three classes of possible explanations, arguing that none of them will suffice. This process of elimination serves as supporting evidence for my actual proposal, explained and otherwise defended in §6.

### 5.1 Idea #1: Syntactic selection

One possible way that roots could get paired with values of ANIMATE is by syntactic selection. This is how I said that roots get paired with values of GENDER. On this account, Swahili's animate categorizing head appears as follows.

- (22) n<sub>[+ANIMATE]</sub>[SEL:  $\sqrt{\text{child}}$ ,  $\sqrt{\text{teacher}}$ ,  $\sqrt{\text{boogeyman}}$ , ...]

However, there are two differences between ANIMATE and GENDER which cause problems for this approach. First, while the head that hosts GENDER is sister to the root and therefore can select straightforwardly, my analysis of animacy crucially depends on ANIMATE not being sister to the root. Moreover, ANIMATE cannot move to be sister to the root. Even if we could come up with an analysis involving lowering across two phase boundaries, we would have to explain why the ANIMATE feature is not pronounced at the landing site.

One can get around the problem of nonlocal selection by positing that Swahili has lexical entries along the lines of (23).

- (23) a.  $n_{[+ANIMATE][SEL:+F]}$  (for some feature F)  
 b.  $n_{[GENDER:x][+F][SEL:\sqrt{root1},\sqrt{root2},\sqrt{root3},\dots]}$  (for each GENDER value  $x$ )  
 c.  $n_{[GENDER:x][-F][SEL:\sqrt{root1},\sqrt{root2},\sqrt{root3},\dots]}$

On this view, the +ANIMATE categorizer does not select for animate-denoting roots. Instead, it selects for some intermediate feature +F which is introduced on a set of GENDER-marked categorizers that select for animate-denoting roots.

This approach solves the problem of nonlocality in selection, but it is still not an adequate solution to the problem at hand. First, it is an inelegant solution, introducing an extra feature F. More importantly, however, it doesn't provide a link between morphological animacy and semantic animacy. According to this explanation, it is an accident that semantically animate nouns are always morphosyntactically marked as +F (and therefore as ANIMATE). This is the fundamental problem with using syntactic selection to capture the generalization that +ANIMATE goes with semantically animate nouns.

## 5.2 Idea #2: Conditions on interpretation

A second approach would be to say that the +ANIMATE feature is necessary to assign an animate denotation to an nP. Kramer (2015) proposes this kind of idea and cashes it out with encyclopedia access rules like the one in (24).

- (24)  $[n_{[GENDER:9]} \sqrt{twiga}] \rightarrow giraffe / +ANIMATE$

On this account, an nP consisting of an n-head marked for GENDER:9 and the abstract root  $\sqrt{twiga}$  is mapped to the concept of a giraffe, but only when it is sister to a node bearing the feature value +ANIMATE. This approach allows us to skirt the locality problems encountered with syntactic selection, since rules like (24) require that +ANIMATE be sister to a constituent containing the root rather than to the root itself.

However, this approach has its own locality problems. Notice that a rule of the form shown in (24) could never apply to kinship terms, since as I argued in section §4, possessors of kinship terms intervene between +ANIMATE and the nP. We could solve this locality problem by saying that the encyclopedia access rules do contain the possessor. However, that would require Swahili speakers to have separate encyclopedia access rules for every possible combination of kinship possessive and pronominal possessor. This seems inefficient at best.

Moreover, even though this explanation links the syntactic component to the semantic component, it does not link syntactic animacy to semantic animacy. Since encyclopedia access rules store idiosyncratic information, the fact that the +ANIMATE feature occurs with all and only animate-denoting nominals is treated as an accident. Nothing in the grammar prevents the existence of an encyclopedia access rule which requires +ANIMATE for the meaning “screwdriver” to be assigned. Thus, the fundamental problem we saw with selection-based approaches is still at play with encyclopedia access rules.

### 5.3 Idea #3: +ANIMATE asserts animacy

A third idea would be to have the +ANIMATE denote a predicate synonymous with the word “animate”. A way of cashing this idea out is shown in (25).

$$(25) \quad [[+\text{ANIMATE}]] = \lambda x. \text{animate}(x)$$

In a structure where +ANIMATE is sister to an nP (as in Figure 1), this denotation will compose with the denotation of the nP via Predicate Modification. As a result, the structure as a whole will denote a function which returns “true” when its argument is an individual which is animate and which satisfies the semantic content of the nP.

This explanation successfully links the morphosyntactic animacy feature to the semantic concept of animacy. The feature ANIMATE takes a positive value in animate-denoting nominals because taking a negative value would make the sentence self-contradictory and therefore semantically anomalous. However, this explanation makes some false predictions.

First, because this explanation has +ANIMATE make an assertion about an individual, it makes the acceptability of its use dependent on contingent facts about that individual. This is not how Swahili works. Rather, the grammatical necessity of animate marking depends only on the choice of predicate. For example, (26) shows that a knife is incompatible with +ANIMATE feature even when it is behaving in typically animate ways. The converse is shown in (27), where we see that even a pig who is really most sincerely dead receives animate morphology.



- (26) Ki-su amba-cho/\*ye ki-/\*a-na-ishi, ki-/\*a-na roho, na ki-/\*a-na-cheza  
 7-knife REL-7/\*1 7/\*1-PRES-live, 7/\*1-have soul, and 7/\*1-PRES-play  
 ngoma ki-/\*a-na-penda Salima.  
 drum 7/\*1-PRES-love Salima.  
 ‘The knife which is alive, has a soul, and dances loves Salima.’

- (27) N-guruwe a-/\*i-li-pik-wa baada ya ku-fa.  
 9-pig 1/\*9-PAST-cook-PASSIVE after 9.of INF-die  
 ‘The pig was cooked after it died.’

These facts can be captured by having +ANIMATE assert that the predicate is animate rather than that the individual is. This idea is shown in (28). Thus, this particular problem is surmountable, though I show a more elegant way of capturing this same idea in §6.

- (28)  $[[+ANIMATE]] = \lambda P \lambda x. P(x) \ \& \ \mathbf{animate}(P)$

A second and less easily fixable problem with an assertion-based analysis is that it does not give us a story for why animate marking is necessary where it is allowed. We cannot appeal to Gricean principles such as the maxim of quantity, since the +ANIMATE feature adds no additional information where it is licit. (The set of animate giraffes is no different from the set of all giraffes and any speaker who knows what a giraffe is will know that the ‘giraffe’ predicate is animate.) In fact, for this very reason, the maxim of manner would predict that animacy marking is forbidden wherever it is possible!

The primary reason why this explanation cannot work is that it wrongly predicts that proper animacy marking is necessary for truth, rather than for well-formedness. Thus, a semantic analysis of animacy is going to need to cause a crash of some sort rather than a successful computation of the output “false”.

In this section, I have demonstrated the inadequacy of three potential mechanisms we could use to explain how the choice of root conditions the value of the ANIMACY feature. This line of inquiry gives us a checklist of what a theory is going to need to contain.

This checklist is shown in (29).

- (29) a. No violations of locality  
 b. Connects morphosyntactic animacy to semantic animacy  
 c. Predicts that animacy marking is necessary where it is possible

- d. Predicts strong unacceptability of improper animacy marking
- e. Predicts that animate marking cares about predicates, not individuals

## 6 How to be animate: Satisfy an animacy presupposition

In the previous section, I addressed the question of how the +ANIMATE feature value comes to be paired with all and only animate-denoting nominals. I showed that three potential solutions do not suffice, since they all fail to meet one or more of the criteria for adequacy listed in (29).

In this section, I argue that the correct solution to this puzzle is to say that +ANIMATE triggers a presupposition of animateness. Specifically, +ANIMATE denotes a partial function which is defined only on animate predicates of type *et* and which denotes the identity function where it is defined. This idea is shown formally in (30).

$$(30) \quad [[+\text{ANIMATE}]] = \lambda P_{et} : \text{animate}(P). P$$

This denotation causes the +ANIMATE feature value to serve as a semantic filter. When +ANIMATE is sister to an animate-denoting nP, it has no semantic effect. When it is sister to an inanimate-denoting nP, it crashes the process of semantic composition. Therefore, this denotation alone gives us the correct prediction that animate marking should only be available with animate-denoting predicates.

This explanation satisfies (29a) and (29b), since the mechanism it uses is semantic composition between sister nodes. It also gives us (29c) because of the principle of MAXIMIZE PRESUPPOSITION (Heim 1991), shown in (31).

$$(31) \quad \text{MAXIMIZE PRESUPPOSITION: Do not use a sentence if there is an alternative with stronger presuppositions.}$$

This explanation also gives us (29d), since it predicts that semantic composition will crash if a non-animate predicate is given animate marking. Lastly, because it uses a metalanguage predicate on predicates of type *et* rather than on individuals, it satisfies (29e).

This analysis may look surprising since animacy doesn't look much like classic examples of presuppositions (e.g. "The present king of France is bald"), since it isn't sensitive to context, as we saw in examples (26) and (27). However, an analogous idea was proposed by Cooper (1983) for gender on pronouns in Romance, as shown in (32).

$$(32) \quad [[\text{masculine}]] = \lambda x_e : \text{male}(x). x$$

Cooper's idea has been adopted for  $\phi$ -features in general in recent literature (Heim & Kratzer 1998; Sauerland 2008; Heim 2008) and extended to predicates of type *et* by Merchant (2014). Thus, insofar as animacy is akin to the  $\phi$ -features, this analysis demonstrates a deep commonality between Romance languages and at least one Bantu language.

## 7 Conclusion

In this paper, I have argued that some peculiar syntactic behaviors of animacy marking in Swahili shed light on its semantic status. Specifically, I have argued that the animacy feature denotes a partial identity function on predicates of type *et*, defined only for predicates which are animate.

This analysis explains why animate-denoting nouns trigger animate morphology regardless of their own class prefix, why possessors of kinship terms are an exception to this rule, and does so in a way that explains why animate morphology correlates strongly with animate meaning. Moreover, it does so in a way that meets the additional criteria for adequacy listed in (29).<sup>4</sup>

## Acknowledgements

This paper would not have been possible if not for extensive discussions with Karlos Arregi. I am also grateful to Itamar Francez, Vera Gribova, Chris Kennedy, Jason Merchant, and Andrew Nevins for discussing these issues with me as well as to Leah Chapman, Elizabeth Wood, Shannon Wotherspoon, and an anonymous reviewer for comments on earlier drafts. Where not specified otherwise, data comes from my consultants Inno Basso and Beja Kitondo.

## Abbreviations

Numbers signify noun classes

PST past tense

SG singular

SEL selectional feature

---

<sup>4</sup>One unsolved problem should be mentioned. As noted by Carstens (1991), classes 5/6 and 7/8 have derivational uses as augmentative and diminutive markers respectively, and in these uses, they are immune to Animacy Override. Several analyses are possible in the framework of this paper as well as that of Carstens (1991) but it is hard to choose among them. For reasons of space, I do not explore the question here.

## References

- Barker, Chris. 1995. *Possessive descriptions*. Palo Alto: CSLI Publications.
- Carstens, Vicki. 1991. *The morphology and syntax of determiner phrases in Kiswahili*. UCLA. (Doctoral dissertation).
- Carstens, Vicki. 2008. DP in Bantu and Romance. In Katherine Demuth & Cecile de Cat (eds.), *The Bantu-Romance connection*, 131–166. Amsterdam: John Benjamins.
- Cooper, Robin. 1983. *Quantification and syntactic theory*. Wiesbaden: Reidel.
- Heim, Irene. 1991. Artikel und definitheit. In Armin von Stechow & Dieter Wunderlich (eds.), *Handbuch der Semantik*, 487–535. Berlin: De Gruyter.
- Heim, Irene. 2008. Features on bound pronouns. In Daniel Harbour, David Adger & Susana Bejar (eds.), *Phi theory: Phi-features across modules and interfaces*, 35–56. Oxford: Oxford University Press.
- Heim, Irene & Angelika Kratzer. 1998. *Semantics in generative grammar*. London: Blackwell.
- Kramer, Ruth. 2015. *The morphosyntax of gender* (Oxford Studies in Theoretical Linguistics). Oxford: Oxford University Press.
- Merchant, Jason. 2014. Gender mismatches under nominal ellipsis. *Lingua* 151. 9–32.
- Partee, Barbara H. 1983/1997. Uniformity vs. versatility: The genitive, A case study. In Johan van Benthem & Alice ter Meulen (eds.), *The handbook of logic and language*, 464–470. Amsterdam: Elsevier.
- Sauerland, Uli. 2008. On the semantic markedness of phi-features. In Daniel Harbour, David Adger & Susana Bejar (eds.), *Phi theory: Phi-features across modules and interfaces*, 57–82. Oxford: Oxford University Press.
- Taniguchi, Ai. 2013. Hakuna matata: Nominal coordination and noun class agreement in Swahili. Unpublished handout.

## Chapter 30

# Hausa chat jargon: Semantic extension versus borrowing

Tristan Purvis

American University of Nigeria

A corpus of WhatsApp chats reveals how Hausa-speaking youth have adopted and spread homegrown Hausa terms, via semantic extension, for the actions (e.g. chatting, forwarding), objects (e.g. image) and space (e.g. group, online/offline) associated with computer-mediated communication rather than strictly borrowing from English chat jargon. Along with other contextual factors, this study reviews the linguistic forms (including source language), range of terminology, and frequency of occurrence of specialized chat terminology found in this corpus, representing 56 different interlocutors in 40 different dyads of chat excerpts.

## 1 Introduction and background

This study analyzes the vocabulary that Hausa-speaking chat participants adopt when consciously referring to the chat environment itself. In particular, I analyze the extent to which chatters either draw on English-based chat jargon or employ equivalent Hausa terms for this purpose. Observations are drawn from a freshly developed corpus of WhatsApp chats between Hausa speakers. The corpus includes 40 different dyads of chats involving 56 different interlocutors. Sixty terms (lemma), including 22 inherent Hausa items and 38 instances of English loanwords or code-mixing, were tracked as terms used in reference to the actions (e.g. *chat(ting)*, *forward(ing)*), objects (e.g., *image*), and space (e.g. *group*, *online/offline*). Results reveal members of the Hausa-speaking community to be quite innovative when it comes to drawing on their language's own lexical resources for use as chat terminology rather than strictly borrowing from popularly known English chat jargon.



## 2 Background

### 2.1 Increasingly multilingual cyberspace

English has long been recognized as the dominant, established lingua franca of the Internet (Danet & Herring 2007) as well as SMS communication. Nonetheless, as smartphones and wireless technology spread to the remotest areas of the world, more and more languages have been adapted for computer-mediated communication (CMC), and by now the Internet and cybersphere can truly be recognized as a relatively diversified, multilingual environment.

But what does it take to truly adapt to this medium? To the extent that online chat and SMS messaging, presumably the most widely used applications of CMC, are similar to spoken conversation, one might think that adapting to the new technology is a simple matter of typing words as they are spoken. However, this naturally comes with various challenges, and I would argue the outcome is that English's influence in computer-mediated communication is partly reinforced by these obstacles.

First of all, of course, users must be literate and share some basic standards or common ground of orthographic conventions with their interlocutors. For languages lacking an established literate tradition, bilingual speakers may end up preferring to use English, thus reinforcing the continued dominance of English as the language of the Internet. For example, when recruiting contributors for the corpus of Hausa-based texts presented in this paper, numerous fluent, mother-tongue speakers of Hausa who otherwise use Hausa frequently in various spoken contexts admitted that they tended to text in English, not Hausa. Likewise, from among those who agreed to participate, several contributions for the corpus building were rejected on the grounds that the majority of texting was in English.

Furthermore, languages using non-Latin scripts face challenges. Although Internet and cell-phone technology has accommodated different language scripts, we still find users adapting their native language to Latin scripts. For example, "Greeklish" is a Latin script-based rendering of Greek that was developed as soon as Internet came to Greek society (Androutsopoulos 2012). Similarly, Palfreyman & al Khalil (2007) have studied the use of a so-called "ASCII-ized Arabic" — where Latin characters along with numerals and other symbols represent different Arabic letters — among college students in UAE. So, even though the language of communication may not be English, the implicit hegemony of English as the language of the Internet is still reflected in the choice of script.

Third, in the online chat environment at least, it is desirable to express oneself as rapidly as possible. This is largely facilitated by the development of abbreviated

forms such as the iconic trends seen in the English-speaking world of CMC with phrases like *y r u s o l s* (in place of the 15-character phrase *Why are you so late?*). While any given language can be used for online chatting without such abbreviations, certain bilingual speakers again might opt for English as the language that gives them a ready-made, established medium for rapid, not to mention playful, communication.

## 2.2 Chat jargon (terminology)

Even where a language has successfully adapted to the CMC environment, there is yet another area where one might expect to see remnant signs of the dominance of English as the global language of technology – namely, in the use of specialized chat terminology. Though meant to mirror in many ways spoken conversation, chatters must on occasion refer to actions, objects, and space that are unique to the computer-mediated medium. In fact, presence in the chat environment often serves as a topic of conversation, as chatters make reference to *profile pictures* that they have *uploaded* to their *account* and request one another *forward snapshots*, for example. Thus, inevitably, chat participants will have a need and desire for jargon of this nature for conscious reference to the virtual electronic environment itself – terms like *email*, *attachment*, *profile*, *upload*, and *online* found in English.

With such chat terminology logically taking cues from the field of information technology and with online chat being a product of globalization in its own right, one might expect, to begin with, bilingual chatters to resort to code-mixing in English (as the dominant language of globalization and IT). Furthermore, even monolingual chatters would be influenced by the multilingual community, and languages might fully adopt (borrow/code-mix) English-based loanwords for such terms as *chat*, *forward*, and *online*.

Indeed, technical communication is often cited among the motivations for code-switching (bilingual speakers switching back and forth between different languages) and among bases for code-mixing (i.e., linguistic borrowing). In general, technological terms, such as these, are prone to spread from the originating or dominant language to other cultures where they get adopted as loanwords. For example, when checking for translation equivalents for the word *computer* in Google Translate, 76% (77 of 101) of the languages supported present a word that is clearly derived from the Latin-cum-English term. Daulton (2012) further confirms that “the most borrowed words refer to technology (e.g. engine) and names for new artifacts (e.g. taxi).”

### 2.3 Alternatives to English loanwords

The use of chat jargon might be inevitable, but the spread of terminology as loanwords is not. After all, the English language itself has drawn on various word-building strategies in the development of jargon dealing with computer technology – from reviving an old term like *cursor* (which itself had been borrowed earlier from Latin like so many English words) to repurposing common words like *mouse* and *web* via semantic extension to use of acronyms like *PC*. Similarly, other languages can draw on their own resources.

In many cases, when languages are found using intrinsic strategies for technological lexical development, it is understood as a conscious effort to defend linguistic purity (Blommaert 2002 [1994]; Haspelmath 2009). For example, the Académie française has long been active with moderating the development and documentation of new French terms, with moderate success thanks to government backing in matters of broadcasting and publication. Examples include recommending the use of *logiciel* and *courriel* in place of *software* and *e-mail* (Daulton 2012). Similar efforts for linguistic purification can be seen with other languages of the world such as Korean and various Eastern European languages (Haspelmath 2009).

### 2.4 Hausa

Hausa, an Afro-asiatic language spoken widely in West Africa, is an example of a language that has successfully been adapted for CMC. For one thing it does have an established, printed literary tradition using a Latin-based script.<sup>1</sup> While many speakers might not be familiar with official standards of orthography, they get by well enough with predictable pronunciation and influence from mixed levels of literacy in English. Secondly, regarding the desire for rapid communication, within the corpus of Hausa chats described in this article, the Hausa speakers do collectively use a variety of abbreviated forms such as *wlh* for *wallahi* ('by God') and *ya kk* for *yaya kake/kike/kuke* ('How are you?' – covering masculine, feminine, and plural forms of second-person reference in Hausa grammar).

But what about specialized chat terminology in Hausa? Returning to the discussion in the preceding section, we can first observe that the Hausa community is not documented as one that is prone to language purification efforts. First of all, the Hausa language has frequently drawn upon languages in contact for ex-

---

<sup>1</sup>Although the Latin-based script was only introduced early in the 20th century, it has overtaken Ajami (an Arabic-based script whose use with Hausa dates back to the 15th century) as the dominant orthographic standard.



panding its lexicon. For example, words like *burodi* ('bread'), *tebur* ('table'), and *famfo* ('pump') have come from English, while terms like *albarka* ('blessing'), *hankali* ('wisdom'), and *wallahi* ('by God') come from Arabic. Some words traced to these two languages were transmitted to Hausa via yet other languages – such as *tasha* ('station') coming into Hausa from Yoruba (or possibly other languages spoken south of Hausa speaking areas) and *kasuwa* ('market') having been introduced via another language of northern Nigeria, Kanuri, which had its own lexical borrowing from the Arabic word *suq* (Newman 2000). Furthermore, and more directly relevant to this study, many of the Hausa speakers in the Hausa chat corpus (all bilingual) frequently code-switch between Hausa and English (and less frequently, Arabic, Fulfulde, and Kanuri) in addition to using English code-mixing within Hausa texts. That is, on average, they are clearly not inclined towards so-called linguistic purity.

So, as a language open to lexical borrowing, one might expect these bilingual chatters to naturally draw on established English terms for chat jargon. Indeed, many do draw on English both for emotive jargon (like 206 instances of *lol* and 3 instances of *l8r* 'later'), which is not analyzed in this study, and for the specialized terminology referring to the chat environment, analyzed in this paper. Yet, interestingly, within this relatively new and modern medium, young Hausa speakers appear to have spontaneously adopted and spread numerous homegrown terms, via semantic extension or metaphor, for the actions or processes (e.g. chatting, forwarding), objects (e.g. image) and space (e.g. group, online/offline) associated with phone-based and Internet-based communication. Hausa still shows itself to be a language with robust semantic extension, among other strategies for lexical expansion.

## 3 Methodology

### 3.1 Corpus development

#### 3.1.1 Data collection

The corpus was originally targeted as a database of SMS texts with the goal of collecting a minimum of 60 texts from at least 50 participants.<sup>2</sup> WhatsApp chats were ultimately adopted with the following justification:

- more widely used for extended communication than SMS;

---

<sup>2</sup>This objective came from University of Maryland Center for Advanced Study of Language (CASL), who conceived of and funded the project.

- more practical to collect;
- largely comparable to SMS texting in form and context.

University students and some other community members shared excerpts of chats for which their interlocutors also agreed for the texts to be used in the database. To meet the originally targeted volume of data, chats were collected such that the contribution from each participant was at least 4200 characters (based on an estimated average SMS length of 70 characters) – although for 6 additional participants included in the study the volume of texts fell short of 4200 characters. At the time of this study, the corpus included 56 participants (representing excerpts for 40 conversations between two individuals). The total volume of the corpus has reached 21,693 lines (about 90,000 words or 380,000 characters).

A short survey of sociolinguistic/contextual information was collected for each participant, the details of which are summarized in Table 1. As can be seen from these demographics, the majority of participants are university students (85.7%) in their early 20s. Although some claim a language other than Hausa as their mother tongue, a majority (48.2%) consider Hausa as their mother tongue, and all are fluent in Hausa. In addition to the details shown in Table 1, all participants claim to speak English, with a handful of them claiming fluency in other languages as well. As noted earlier, the participants are all bilingual, essentially fluent speakers of both Hausa and English (Nigerian standard, which is largely based on British standard).

### 3.1.2 Data processing

Each line of chat was annotated for standardized spelling, word translation, parts-of-speech, language (in case of code-switching) and a free translation of entire comment. This was facilitated through the use of the Linguist's Toolbox (SIL), as illustrated in Figure 1.

## 3.2 Data preparation

To analyze the use of chat jargon, Search & Replace software (Funduc, Inc.) using Regular Expressions scripts was used to search for targeted keywords dealing with the chat environment and presumed to be potential candidates for chat terminology used by this speech community. An example of such a word appears in Figure 1: *sauka* (a Hausa verb that literally means 'to descend or get down,' and which has been extended to refer to 'logging off or going offline'). In order to

30 Hausa chat jargon: Semantic extension versus borrowing

Table 1: Chat participant demographics.

Factor	Details
Gender:	24 Females, 32 Males
Age:	Average=22; Mode=20; Range of 14-35
Education:	Mostly undergraduate; but range from H.S. to Masters
Occupation:	Student (48); Teacher/Lecturer (2); Nurse (1); Entrepreneur (1); Music producer/singer (1); Film maker (1); Music artist (1); Unemployed (2)
Origin/(birth)place:	Adamawa 10; Borno 1 (5); Gombe 2 (1); Jigawa 2(1); Kaduna 4 (5); Kano 20 (19); Katsina 7; Kogi 0 (1); Niger (1); Sokoto 1 (0); Taraba 2(1); Yobe 6 (5)
Residence:	Adamawa 22; Borno 2; Gombe 1; Jigawa 2; Kaduna 6; Kano 10; Katsina 4; Yobe 4; Sudan 2
Mother tongue:	Hausa (27), Fulfulde (16), Kanuri (6), Yoruba (1), Margi (1) , Nupe (1), Other: 5
Language spoken at home:	Hausa (45), Fulfulde (9), English (1), Yoruba (1), Kanuri (2)
Relationship to interlocutor:	(Close/Best/Family) Friend 29, Brother 3, Sister 3, Cousin 3, Uncle 1, Colleague 3

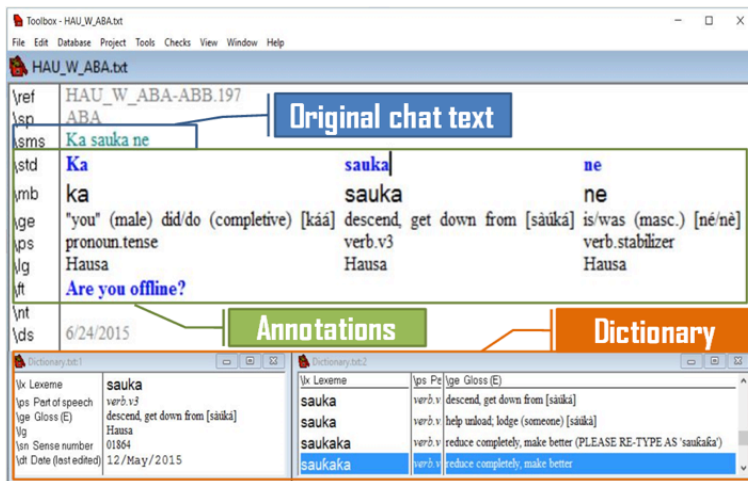

Figure 1: Data annotation example

achieve a relatively exhaustive list of appropriate terms, English equivalents of common chat terms were also searched in the translation field. The set of words ultimately included in the study (i.e., for which at least 1 instance was found to occur in the texts) is presented in Table 2. As seen in the table, jargon was categorized by field of use (Theme group) to help track patterns of choice between Hausa terms and English code-mixing or code-switching.

Table 2: List of words tracked (that appear in the corpus)  
[See Appendix A for brief translations of Hausa terms]

Theme group	Jargon terms
Group A ('talk'):	<i>chat(ing)</i> , <i>gist</i> (Nigerian English term for casual/playful chat), <i>talk(ing)</i> , <i>hira</i> , <i>magana</i> , <i>surutu</i> , <i>tadī</i> , [ <i>kuke</i> ] <i>whatsapp</i> )
Group B ('message'):	<i>answer</i> , <i>comment</i> , <i>link</i> , <i>mail</i> , <i>message</i> , <i>reply(ing)</i> , <i>respond(ing)/response</i> , <i>text</i> , <i>ping</i> , <i>amsa(wa)</i> , <i>sako</i> , <i>taba(wa)</i>
Group C ('send'):	<i>email</i> , <i>forward(ing)</i> , <i>send(ing)</i> , <i>transfer(ing)</i> , <i>tura(wa)</i> , <i>turo(wa)</i>
Group D ('file operations'):	<i>attach(ing/ment)</i> , <i>copy(ing)</i> , <i>download(ing)</i> , <i>screenshot</i> , <i>snapping</i> , <i>delete</i> , <i>saving</i> , <i>goge(wa)</i>
Group E ('image'):	<i>image</i> , ( <i>display/profile</i> ) <i>picture</i> ( <i>dp/pp</i> , <i>pic/pix</i> ), <i>photo</i> , <i>hoto</i>
Group F ('post'):	<i>post(ing)</i> , <i>upload(ing)</i> , <i>sa/saka(wa)</i>
Group G ('enter'):	<i>enter</i> , <i>launch</i> , <i>bude(wa)</i> , <i>shiga</i>
Group H ('online/offline'):	<i>offline</i> , <i>online</i> , [ <i>tana</i> ] <i>on</i> , <i>fita</i> , <i>hau/hawa</i> , <i>sauka</i>
Group I ('group'):	<i>account</i> , <i>group</i> , <i>shafuffukan yada zumunta</i> , <i>azure</i>
Group J ('Internet')	<i>Internet</i> , <i>network</i> , <i>website</i> , <i>yanar gizo-gizo</i>

A total of 1655 instances of the targeted terms were found to occur in the Hausa chat database. This initial tally included all instances, whether used as specialized chat terminology or polysemous terms used in other senses (as in an

English chatter referring to an actual spider web or a web of lies as opposed to the [world wide] web.) Although the Toolbox software used for initial data entry and processing has a concordancing feature, this was not a practical means to complete the next step of data processing – to verify which instances of targeted words were actually used as chat jargon as opposed to other senses (e.g. *sauka* meaning ‘to get off a bus’ versus *sauka* meaning ‘to go offline’). A simple means to facilitate this task, allowing English translations to be viewed alongside the original contextual occurrences in Hausa, was to import the corpus into an Excel spreadsheet (as illustrated in Figure 2).

ChatCode	LineNo	sp	sms	std	ft	sauka
AHA-AHC	228	AHC	Yakasauka lafita	Yaya ka sauka lafiya	How now? Did you arrive safely?	LVA0~sauka
AGA-AGD	43	AGA	PLACE02 duke sauka	[PLACE02] suke sauka	[PLACE02] is where they are stopping	LGA0~sauka
ABA-ABB	197	ABA	Ka sauka ne	Ka sauka ne	Are you offline?	FVS0~sauka
			Ai na sauka yanzukam tunda	Ai na sauka yanzu kam tun da gani ina chat	I have logged off even though you can see me chatting	
ABA-ABB	198	ABB	gani ina chat	chat	It's because I logged off for a	FVS0~sauka
AMA-AMB	122	AMA	Nadan saukane	Na dan sauka ne		FVS0~sauka

Figure 2: Excel table used to verify chat jargon usage

Each occurrence of the targeted terms was tagged for the following contextual features: (1) Usage & language choice (Hausa chat jargon versus other use of Hausa term, and English loanword versus English term used in full instance of code-switching); (2) part-of-speech (Noun, Verb, Gerund/Verbal-noun, Adjective); (3) field of use (Action, Object, Space); (4) Hausa suffixes appearing on words; and (5) whether or not the instance was a typo, correction, or immediate repetition of a previous instance.

## 4 Results

### 4.1 Tally of chat jargon terms

Of the 1655 instances of the target terms, 824 were identified as being used as chat jargon within Hausa texts. The remaining instances were excluded on one of the following grounds: (a) the term was not used as a chat term in the particular context (for example, as in the literal use of *sauka* in the sense of ‘to descend or alight’ – as opposed to going offline – as seen in the first two lines of Figure 2

presented earlier), (b) the term appeared in a full instance of code-switching – i.e., a text entirely or predominantly expressed in English or, more rarely, some other language, (c) the term appeared as a correction to a typing error (thus already counted in an immediately preceding instance). Tables 3–12 present the results of these tallies for each of the 10 theme groups. Each group is presented and discussed in turn.

#### 4.2 Group A: ‘Talk’

Admittedly, the notion of *chat* or *talk* is a relatively problematic theme to track as a jargon term since communication (and thus terms referring to verbal exchange) is a natural part of the chat environment. In any case, as seen in Table 3, the Hausa chatters in this corpus draw predominantly on Hausa vocabulary – using Hausa terms over twice as frequently as corresponding loanwords from English.

Table 3: Frequency of occurrence for words in Group A: ‘Talk’

Word	Total instances	Used as jargon in Hausa
<i>chat</i>	54 (16.5%)	39 (19.8%)
<i>chatting</i>	23 (7%)	22 (11.2%)
<i>gist</i>	4 (1.2%)	0 (0.0%)
<i>talk</i>	14 (4.3%)	0 (0.0%)
<i>talking</i>	1 (0.3%)	0 (0.0%)
<i>[kuke] whatsapp</i> (‘you guys are on WhatsApp’)	1 (0.3%)	1 (0.5%)
		N=62 (31.5%)
<i>hira</i> (‘chat’; lit. ‘gist, informal chat of the evening’)	48 (14.7%)	41 (20.8%)
<i>magana</i> (‘talk, chat’; lit. ‘talking, matter, issue’)	160 (48.9%)	80 (40.6%)
<i>surutu</i> (‘chatting’)	6 (1.8%)	2 (1.0%)
<i>tadi</i> (‘chatting’)	14 (4.3%)	12 (6.1%)
<i>zance</i> (‘talk, chat’)	2 (0.6%)	0 (0.0%)
		N=135 (68.5%)

The frequency of use of these Hausa terms might actually be a bit higher than what is represented here. I was relatively conservative in inclusion of instances of

the word *magana*, which can carry the sense of ‘matter, issue’ in addition to ‘talk, discussion’ (the latter often in combination with the verb *yi* (‘do’)). Where the interpretation wasn’t clear, I treated it as ‘matter’ and excluded it from the chat jargon tally. Though appearing less frequently than *magana* overall, the word *hira* comes across as the principle Hausa word used as jargon to refer to ‘chat.’ While *magana* is a frequently occurring word in Hausa in any context, *hira* has a more specialized original meaning: ‘chat of an evening’ (i.e. speakers making a special point to take time to chat casually), and nowadays it refers to chatting in more general terms. In a similar vein, online forums for chatting present a space for very purposeful yet casual discussion between individuals, and thus the term *hira* must have been a natural choice for semantic extension for referring to this act. A relatively higher frequency of occurrence of *hira* in these chats compared to spoken communication (according to informal input from Hausa speakers) underscores its use as jargon.

#### 4.3 Group B: ‘Message’

Group B includes a wider range of terms – various forms or methods of messaging by which chat users communicate with one another. In this case, it is the use of English code-mixing that is over twice as frequent as seen in Table 4. I speculate this is due to the readily distinguishable nuances available with the well-established the English terms.

Among the Hausa terms found in use, *amsa* (‘respond’/‘response’) and *sako* (‘message’) are relatively general terms. Though it was hard to tell the exact intended sense of the instances of *taba* (verb) and *tabawa* (gerund), judging from the basic meaning of this term (‘touch’), it seems likely that this is a budding extension of this term to refer to something like ‘poking’ as used in social media platforms.

#### 4.4 Group C: ‘Send’

Compared to the various *formats* of message represented in Group B, the *means* of conveying them is more or less constant. Although English has various terms like *send*, *forward*, *email*, and *transfer*, these terms all boil down to basically sending. Incidentally, it is a Hausa word (*tura(wa)/turo(wa)*) that is overwhelmingly the term of choice when referring to the action of sending as seen in Table 5.

The adoption of this term also illustrates a noteworthy case of semantic extension. The term *tura* literally means ‘to push.’ (The difference between *tura* and *turo* is that of directionality (‘push away’ vs. ‘push towards,’ respectively); and

Table 4: Frequency of occurrence for words in Group B: 'Message'

Word	Total instances	Used as jargon in Hausa
<i>answer</i>	10 (6%)	2 (4.1%)
<i>comment</i>	3 (1.8%)	2 (4.1%)
<i>link</i>	1 (0.6%)	1 (2.0%)
<i>mail</i>	9 (5.4%)	8 (16.3%)
<i>message</i>	17 (10.2%)	7 (14.3%)
<i>reply(ing)</i>	12 (7.2%)	3 (6.1%)
<i>respon(ding/nse)</i>	5 (3%)	5 (10.2%)
<i>text</i>	16 (9.6%)	8 (16.3%)
<i>ping</i>	3 (1.8%)	0 (0.0%)
		N=36 (73.5%)
<i>amsa(wa)</i> ('reply')	10 (6%)	2 (4.1%)
<i>sako</i> ('message')	9 (5.4%)	9 (18.4%)
<i>taba(wa)</i> ('poke'?; lit. 'touch')	71 (42.8%)	2 (4.0%)
		N=13 (26.5%)

Table 5: Frequency of occurrence for words in Group C: 'Send'

Word	Total instances	Used as jargon in Hausa
<i>email</i>	9 (4.8%)	3 (2.1%)
<i>forward</i>	1 (0.5%)	0 (0.0%)
<i>forwarding</i>	2 (1.1%)	2 (1.4%)
<i>send</i>	15 (8%)	1 (0.7%)
<i>sending</i>	4 (2.1%)	3 (2.1%)
<i>transfer</i>	3 (1.6%)	3 (2.1%)
<i>transferring</i>	1 (0.5%)	1 (0.7%)
		N=13 (9.2%)
<i>tura</i> ('send'; lit. 'push (out)')	55 (29.4%)	47 (33.1%)
<i>turawa</i> ('sending'; lit. 'pushing')	4 (2.1%)	3 (2.1%)
<i>turo</i> ('send'; lit. 'push (hither)')	90 (48.1%)	76 (53.5%)
<i>turowa</i> ('sending'; lit. 'pushing')	3 (1.6%)	3 (2.1%)
		N=129 (90.8%)



the *-wa* suffix creates a nominalized form of the verb or gerund as pointed out earlier with *tabawa*.) Outside of the chat environment, the term already carries an extended meaning of sending packages physically. So, again, it is a logical choice for conveying the notion of sending messages, pictures, attachments, etc. by electronic means.

#### 4.5 Group D: ‘File-operations’

Compared to sending, which is a straightforward and common action regardless of what we call it, the chat environment involves numerous other specialized file operations. This is an area where we do find the Hausa speakers almost exclusively code-mixing in English as shown in Table 6.

The only specialized file operation for which a Hausa term is found to be used is the notion of deleting (a picture/file), which is expressed by the word *goge* (literally meaning ‘to rub, wipe’ and with an extended meaning of ‘erase’). Next to the 4 instances of *goge*, the only instance of the English word *delete* occurs where a speaker has fully shifted to a full English utterance. All other distinctive file operations referenced in this corpus (attaching, copying, downloading, taking a screenshot, snapping (a picture), saving) draw on English terms.

#### 4.6 Group E: ‘Image’

The most prominent object discussed in the WhatsApp environment is the image – especially the so-called *dp* (display picture) on a user’s profile, but also other images that are shared. In this case, abbreviated English forms *pic* (and related forms like *pix*) and *dp* are extremely ubiquitous, accounting for 61.7% of references to images (Table 7).

However, the Hausa term for picture (*hoto/foto*) appears about as frequently as the most common English term (*pic*). Obviously, the Hausa term is already an English borrowing; yet, here we are dealing with a loanword that entered the Hausa language over 80 years ago at least (Bargery 1934) in reference to physical photographs and has since been fully adopted as a Hausa term carrying the same general scope as the English term *picture*. Included within the tally of Hausa *hoto* (alternative spelling *foto*) are a handful of instances that had been spelled as *photo* but that otherwise pattern as the Hausa word based on clues like use of the Class II plural ending (as in *photuna*, compared to *hotuna*) and the definite marker *-n* (as in *photon* (‘the image’)).

Table 6: Frequency of occurrence for words in Group D: ‘File-operations’

Word	Total instances	Used as jargon in Hausa
<i>attachment</i>	3 (7.1%)	2 (5.9%)
<i>attached</i>	1 (2.4%)	1 (2.9%)
<i>attaching</i>	1 (2.4%)	1 (2.9%)
<i>copy</i> (and paste)	6 (14.3%)	5 (14.7%)
<i>copying</i>	3 (7.1%)	3 (8.8%)
<i>download</i>	2 (4.8%)	0 (0.0%)
<i>downloading</i>	5 (11.9%)	5 (14.7%)
<i>screenshot</i>	3 (7.1%)	3 (8.8%)
<i>snapping</i>	3 (7.1%)	3 (8.8%)
<i>delete</i>	1 (2.4%)	0 (0.0%)
<i>saving</i>	8 (19%)	7 (20.6%)
		N=30 (88.2%)
<i>goge(wa)</i> (‘delete’; lit. ‘rub clean, polish’)	6 (14.3%)	N=4 (11.8%)

Table 7: Frequency of occurrence for words in Group E: ‘Image’

Word	Total instances	Used as jargon in Hausa
<i>image</i>	5 (1.8%)	5 (2.4%)
<i>pic</i> & related forms (e.g. <i>pix</i> )	89 (32.6%)	72 (35.0%)
<i>dp</i> (display pic)	98 (35.9%)	55 (26.7%)
<i>pp</i> (profile pic)	3 (1.1%)	1 (0.5%)
<i>photo</i>	4 (1.5%)	2 (1.0%)
		N=135 (65.5%)
<i>hoto/foto</i> (‘photo, picture’)	74 (27.1%) <sup>a</sup>	N=71 (34.5%)

<sup>a</sup>(including 7 spelled as *photo*)

#### 4.7 Group F: ‘Post’

A specialized operation not included in Group D deals more specifically with images as opposed to other file types: posting. For this operation, which again is both common and straightforward (there being no nuanced ways to post an image), a Hausa term is almost exclusively used: *sa(ka)*. This verb has the basic meaning of ‘put, place.’ The short form, *sa*, is also used in common expressions like *Me ya sa?* (‘What happened?’) and is a very frequently occurring word in general – 289 total instances in this corpus (as shown in Table 8), of which 30 refer to posting in the chat environment.

Table 8: Frequency of occurrence for words in Group F: ‘Post’

Word	Total instances	Used as jargon in Hausa
<i>post(ing)</i>	2 (0.6%)	1 (2.1%)
<i>upload(ing)</i>	3 (0.9%)	1 (2.1%)
		N=2 (4.2%)
<i>sa</i> (‘post’; lit. ‘put, place’)	289 (89.2%)	30 (63.8%)
<i>saka</i> (‘post’; lit. ‘put, place’)	26 (8%)	13 (27.7%)
<i>sakawa</i> (‘placing, posting’)	4 (1.2%)	2 (4.3%)
		N=45 (95.8%)

Technically, *sa* is just a reduced form of *saka*, but in practice the full form is used more rarely and (according to informal input from Hausa speakers) it tends to be used in reference to a very deliberate act like placing a poster or sign on a wall or bulletin board, for example. Given that *saka* is also heard more rarely in speech (based on impressions of Hausa speakers consulted on the difference between *sa* and *saka*), it seems the 1:2 frequency in this corpus relative to the more common short form *sa* is noteworthy – potentially indicative of its status as chat jargon.

#### 4.8 Group G: ‘Enter’

Another type of action that is referenced in the chat environment has to do with navigating the space, as in clicking on a link. Somewhat surprisingly, the English term *click* (seemingly a likely candidate for jargon loanword in the IT environment) is not found to be used at all – only appearing in shared links (copied

text from some other source). As shown in Table 9, the only other English terms found anywhere are 2 instances of *launch* and 1 of *enter* used only when fully switching to English.

Table 9: Frequency of occurrence for words in Group G: ‘Enter’

Word	Total instances	Used as jargon in Hausa
<i>enter</i>	1 (1.2%)	0 (0.0%)
<i>launch</i>	2 (2.3%)	0 (0.0%)
		N=0 (0%)
<i>bude(wa)</i> (‘open’)	18 (20.9%)	7 (33.3%)
<i>shiga</i> (‘enter’)	65 (75.6%)	14 (66.7%)
		N=21 (100%)

All reference to navigating the WhatsApp space (as in guiding an interlocutor through account settings) is carried out with two Hausa terms: 14 instances of *shiga* (‘enter’) and 7 instances of *bude* (‘open’).

#### 4.9 Group H: ‘On/offline’

Another concept that comes immediately to mind as a likely candidate for borrowing from among ubiquitous English chat jargon is the notion of being online or offline. In this case, as seen in Table 10, the English term *online* is indeed frequently used along with a couple instances of *offline*. However, these terms get competition from Hausa equivalents, with the Hausa terms being slightly favored (55.3% versus 44.7%).

The word for offline (*sauka*) and its original meaning of ‘to descend’ was introduced earlier with the examples of data processing presented in §3. Similarly, the concept of being online draws on Hausa’s antonym for *sauka*: *hau* (‘to mount, climb’). These two terms are rather clearly on their way to being spread as the principle Hausa chat jargon terms for online/offline. However, in one instance the verb *fita* (‘to exit/go out’) was used in reference to going offline.

#### 4.10 Groups I & J: ‘Group’ & ‘Internet’

The remaining two theme groups involve direct reference to virtual spaces: from one’s personal account, to exclusive online groups, to the broader Internet itself.

Table 10: Frequency of occurrence for words in Group H: 'On/offline'

Word	Total instances	Used as jargon in Hausa
<i>offline</i>	2 (1.6%)	2 (5.3%)
<i>online</i>	20 (15.5%)	14 (36.8%)
[ <i>tana</i> ] <i>on</i> (i.e. '[she is] on[line]')	1 (0.8%)	1 (2.6%)
		N=17 (44.7)
<i>fita</i> ('enter')	63 (48.8%)	1 (2.6%)
<i>hau/hawa</i> ('go(ing) online'; lit. 'mount')	34 (26.4%)	16 (42.1%)
<i>sauka</i> ('go offline'; lit. 'descend')	9 (7%)	4 (10.5%)
		N=21 (55.3%)

Frequency data for relevant jargon terms found in this corpus are presented in Table 11 (Group I - 'Group') and Table 12 (Group J - 'Internet').

Table 11: Frequency of occurrence for words in Group I: 'Group'

Word	Total instances	Used as jargon in Hausa
<i>account</i>	10 (50%)	3 (30.0%)
<i>group</i>	8 (40%)	5 (50.0%)
		N=8 (80%)
<i>shafuffukan yada zumunta</i> ( 'social network')	1 (5%)	1 (10.0%)
<i>zaure</i> ('group'; lit. 'entry hall to a compound')	1 (5%)	1 (10.0%)
		N=2 (20%)

Two similar observations can be made for the two theme groups represented here. First, in both instances, English terms are more frequently drawn upon, but Hausa equivalents also appear. Secondly, the number of occurrences of any term is quite low, so the relevance of relative frequency between English versus Hausa terms is less conclusive. The fact that the Hausa alternatives exist means that they could conceivably be or become more widely spread, especially if there

Table 12: Frequency of occurrence for words in Group J: ‘Internet’

Word	Total instances	Used as jargon in Hausa
<i>internet</i>	1 (4.5%)	1 (20.0%)
<i>network</i>	18 (81.9%)	2 (40.0%)
<i>website</i>	2 (9.1%)	1 (20.0%)
		N=4 (80%)
<i>yanar gizo-gizo</i> (‘Internet’)	1 (4.5%)	N=1 (20.0%)

is a trend to continue to draw on indigenous terms to fill the role of chat jargon.

The Hausa terms adopted in these cases are especially creative. The word for group (*zaure*) comes from the word for entry hall in the traditional Hausa housing compound where guests wait to be received by the host. This ends up being a fitting extension of this particular word, if not as obvious of a choice as jargon terms like *hira* (‘chat’) and *sa(ka)* (‘post’). Its simple one-word format also makes it a good candidate to catch on as a chat term. The other creative Hausa terms in these groups are built from compounding. The phrase *shafuffukan yada zumunta* was used in place of the term ‘social media.’ The breakdown in meaning is as follows: *Shafuffukan* is the plural form of the word *shafi* (along with the linking suffix *-n*). *Shafi* has a variety of senses having to do with a sheet of something (lining of cloth in a garment, page of a book, coat of paint); *yada* is a verb meaning ‘to spread (news, info, rumors)’; and *zumunta* means ‘close relations, intimacy.’ So, the literal translation is ‘sheets (media) for spreading good relationships.’ Surely, a phrase of this length is not so likely to catch on without an abbreviated form, which is somewhat hard to imagine from this particular complex phrase. Similarly, the term for the Internet, clearly a calque of sorts of English *web*, is a relatively lengthy compound: *yanar gizo-gizo* (‘spider web’). In the latter case, however, it is conceivable that this term could be reduced to *yana*, for example, even though in its original sense *yana* on its own refers to a film or scum covering a surface and does not convey the sense of ‘web’ without being combined with the word *gizo-gizo* (‘spider’). For the younger generation, the sense of ‘web’ comes more readily.

## 5 Discussion and summary

### 5.1 Summary of findings

From the presentation of results, we see that Hausa-speaking chat users are employing a mixture of English code-mixing and Hausa words as chat jargon. That bilingual speakers (or even non-English speakers in a multilingual speech community) end up using English loanwords from the IT field is not surprising. It is, however, somewhat striking to see the degree to which Hausa terms have quickly been adapted for use as chat jargon in a relatively new medium that otherwise tends to be dominated by the English language globally.

When organizing the results by theme groups, we see that the likelihood of finding an English term versus a Hausa alternative is not entirely random. First, a number of Hausa terms emerge as natural candidates to fill the role of key chat jargon where the referenced meaning is clear, having a literal sense or applying only a light metaphorical extension: *hira* ('chat'), *tura* ('send'), *hoto* ('image'), *sa* or *saka* ('place' = 'post'), and a combination of *shiga* ('enter') and *bude* ('open') for clicking on links. In the case of *tura*, *sa* and *shiga/ bude* (or variant forms), the Hausa terms are used almost exclusively.

With a number of other terms, a wider leap of semantic extension is called upon to repurpose Hausa words to expand the Hausa-based chat jargon. For example, the notion of going or being online and offline is aptly equated to climbing on and descending, employing the Hausa verbs *hau* and *sauka* (and variant forms), respectively. Though extremely rare in this corpus (and thus not substantial enough to draw meaningful conclusions about relative frequency of use), we also find innovative semantic extension with terms for online group and Internet, as well as an innovative compound term to refer to social media: *zaure* ('entry hall' = 'group'), *yanar gizo-gizo* ('spider web' = 'Internet'), and *shafuffukan yada zumunta* (= 'social media').

Where English still dominates to a great extent are areas where the widely established English IT terms account for important distinctions or nuances in specialized actions and objects — including various file operations (like attaching, copying, downloading, deleting, and saving) and message types (like comment, response, link, and text). Nonetheless, we do find speakers drawing on Hausa resources for purposes of this sort — such as *bude* ('open'), mentioned above as a logical choice for clicking a link or opening a file and *goge* (literally 'rub, wipe') being used in reference to deletion of a virtual object. It may just be a matter of time before the innovative Hausa-speaking community repurposes other Hausa words for these more specialized IT concepts.

## 5.2 Future directions

When it comes to analyzing lexical choices by bilingual speakers, we should also account more fully for different sociolinguistic factors. In terms of gender differences, the relatively homogenous nature of this corpus (mostly composed of college students around 20 years old), has actually been beneficial, roughly controlling for most other factors. That is, the corpus is relatively balanced (24 females & 32 males as shown in Table 1, with 70% of the chat jargon terms coming from females and 30% coming from males). So, I can briefly report that females are found to prefer a combination of code-mixing (41.5%) and code-switching (19.6%) to Hausa-based jargon (38.9%), compared to their male counterparts: 46.5% Hausa terms versus 36.2% English code-mixing and 17.2% code-switching (Chi-square = 4.284;  $p$ -value = .038473., significant at  $p < .05$ ) – incidentally confirming findings in other studies that female speakers tend to code-mix and code-switch more than men (Ahmed et al. 2015; Hamdani 2012; Wong 2006). In any case, however, it will be of interest to pursue a fuller, more systematic account of the relation between different sociolinguistic factors and use of chat jargon, collecting data from a broader demographic set, if possible.

Another important question to address more systematically is the relation between the chat jargon terms and the use of the same words in various other contexts. For example, while still focusing on chat space: how do the dynamics of a chat group (instead of just one-on-one exchanges) affect word choices and the promotion of particular jargon terms? To what extent are the various IT jargon terms found elsewhere on the Internet? Can we get a more accurate estimate of the relative frequency of the target terms in spoken communication versus online communication? (In the presentation of results in §4, I relied on impressions from native speakers for rough judgments.)

Finally, this article necessarily attributes the spread of Hausa chat jargon to the Hausa-speaking chat participants. But where has this community drawn its inspiration? For example, the term *yana(r gizo-gizo)* had been documented as referring to the Internet as early as 2007 (Newman 2007). Recently, this word has even been used as the title of a “Kannywood”<sup>3</sup> film in which use of social media is the focus: “Yanar Gizo” (A.Y.A. Media, Nigeria). By nature of most Kannywood films, the word also features in song and in multiple film installments – all of which is likely to reinforce or spread its use among Hausa speakers. Other chat conventions might be traced to popular Hausa literature. For example, several speakers use the sequence *mtsw* as an ideophone for a lip-pursing/inward suck-

---

<sup>3</sup>The hub of the Hausa film industry is the city of Kano (hence “Kannywood”).



ing sound used to express disapproval, and one of the users claimed this spelling convention can be traced to Hausa romance novels. While it is quite conceivable that many innovations have and will continue to come directly from within the chat community itself, inspiration by and reinforcement in other media will surely help spread the fuller development of a Hausa-based chat jargon that already appears to be robust based on patterns found in the corpus presented in this study.

## Abbreviations

Forms ending in *-wa* after verb entries are the nominalized forms (akin to gerunds).

n noun

v verb

pers./asp. person/aspect complex (i.e. pronoun + tense/aspect encoding)

## Appendix A – Glossary of Hausa Terms

<i>amsa (amsawa)</i>	v. answer, reply
<i>bude (budewa)</i>	v. open
<i>fita</i>	v. go out
<i>goge (gogewa)</i>	v. rub clean, polish
<i>hau (hawa)</i>	v. mount, climb, ride (figuratively used in the texts in this corpus to refer to going online)
<i>hira</i>	n. chatting, conversation
<i>hoto</i> (alternative spelling: foto)	n. photograph, picture
<i>kuke</i> (in <i>kuke whatsapp</i> )	pers./asp. 2 <sup>nd</sup> person plural relative imperfective (i.e. '(that) you all are ...')
<i>magana</i>	n. speech, talk; matter, affair
<i>sa</i>	v. put, place; wear; appoint (often used in the texts in this corpus in reference to posting)
<i>saka (sakawa)</i>	v. put, place, arrange (often used in the texts in this corpus in reference to posting)
<i>sako</i>	n. message
<i>sauka</i>	v. descend, come down (figuratively used in the texts in this corpus in reference to going offline)

<i>shafuffukan yada zumunta</i>	<i>n.</i> social media (relatively new coinage, literally meaning pages spreading close relations)
<i>shiga</i>	<i>v.</i> enter, go in (sometimes used in the texts in this corpus in reference to clicking/selecting)
<i>surutu</i>	<i>n.</i> talkativeness, chattering
<i>taba (tabawa)</i>	<i>v.</i> touch, feel; affect; have ever done something (used in one text in this corpus in reference to texting or possibly akin to the notion of “poking” in cyberspace?)
<i>tadi</i>	<i>n.</i> conversation, chatting
<i>tana (in tana on)</i>	<i>pers./asp.</i> 3 <sup>rd</sup> person singular feminine imperfective
<i>tura (turawa)</i>	<i>v.</i> push; send (out) (often used in the texts in this corpus in reference to sending)
<i>turo (turowa)</i>	<i>v.</i> push; send (this way) (often used in the texts in this corpus in reference to sending)
<i>yanar gizo-gizo</i>	<i>n.</i> Internet, World Wide Web
<i>zance</i>	<i>n.</i> talk, conversation; subject, matter
<i>zaur</i>	<i>n.</i> entry hall to a compound (figuratively used to refer to a chat group in this corpus)

## References

- Ahmed, Khalid, Ihsan Ali & Hua Xiang. 2015. Code-mixing as a marker of gender identity in SMS language in Pakistan. *Journal of Humanities and Social Science* 20(1). 58–65.
- Androutsopoulos, Jannis. 2012. ‘greeklish’: transliteration practice and discourse in the context of computer-mediated digraphia. In Alexandra Jaffe, Jannis Androutsopoulos, Mark Sebba & Sally Johnson (eds.), *Orthography as social action: scripts, spelling, identity and power*, 359–392. Berlin: De Gruyter.
- Bargery, George P. 1934. *A Hausa-English dictionary and English-Hausa vocabulary*. London: Oxford University Press.
- Blommaert, Jan. 2002 [1994]. The metaphors of development and modernization in Tanzanian language policy and research. In Richard Fardon & Graham Furniss (eds.), *African languages, development and the state*, 213–226. London: Routledge.
- Danet, Brenda & Susan Herring. 2007. Introduction: Welcome to the multilingual Internet. In Brenda Janet & Susan Herring (eds.), *The multilingual Internet: Lan-*

- guage, culture, and communication online*, 3–39. Oxford & New York: Oxford University Press.
- Daulton, Frank E. 2012. Lexical borrowing. In Carol A. Chapelle (ed.), *The encyclopedia of applied linguistics*. London: Blackwell Publishing. DOI:10.1002/9781405198431.wbeal0687
- Hamdani, Fakry. 2012. The influence of gender in determining the language choice of teenagers: Sundanese versus Bahasa. *International Journal of Basic and Applied Science* 1(1). 40–43.
- Haspelmath, Martin. 2009. Lexical borrowing: Concepts and issues. In Martin Haspelmath & Uri Tadmor (eds.), *Loanwords in the world's languages: A comparative handbook*, 35–54. Berlin: De Gruyter.
- Newman, Paul. 2000. Comparative linguistics. In Bernd Heine & Derek Nurse (eds.), *African languages: An introduction*, 259–271. Cambridge: Cambridge University Press.
- Newman, Paul. 2007. *A Hausa-English dictionary*. New Haven: Yale University Press.
- Palfreyman, David & Muhamed al Khalil. 2007. A funky language for teenzz to use: Representing Gulf Arabic in instant messaging. In Brenda Danet & Susan Herring (eds.), *The multilingual Internet: Language, culture, and communication online*, 43–63. Oxford & New York: Cambridge University Press.
- Wong, Kwok-Lan Jamie. 2006. *Gender and codemixing in Hong Kong*. University of Sydney Linguistics Department. (MA thesis). Honours Thesis.



## Chapter 31

# Deriving an object dislocation asymmetry in Luganda

Rodrigo Ranero

University of Maryland

In this paper, I document and analyze an object-dislocation asymmetry in Luganda (Bantu: JE15) that becomes apparent only upon comparing double object left-dislocation versus double object right-dislocation. If two objects are left-dislocated, the object markers (OMs) on the verb are strictly ordered  $OM_{THEME} > OM_{GOAL/BEN}$  and the dislocated objects are ordered freely, either  $GOAL/BEN > THEME$  or  $THEME > GOAL/BEN$ . In contrast, if two objects are right-dislocated, the objects cannot be freely ordered – two right-dislocated objects must be ordered  $GOAL/BEN > THEME$ . However, in double object right-dislocation, the OMs must also be ordered  $OM_{THEME} > OM_{GOAL/BEN}$ . I propose that this asymmetry can be captured if left-dislocated objects are base generated in their surface position, whereas right-dislocated objects are derived via movement. Several predictions concerning binding and superiority effects are borne out, providing support for the analysis.

## 1 Introduction

In this paper, I investigate the syntax of object dislocation in Luganda (Bantu: JE15). Example (1a) below exemplifies object left-dislocation (OLD) and (1b) object right-dislocation (ORD):<sup>1</sup>

---

<sup>1</sup>All data come from my field notes except where indicated. Tone is not marked in the data. When one object/OM is relevant, it is bolded; when two objects/OMs are relevant, one is bolded as well – this does not carry any significance beyond helping the reader identify the relevant aspects of each example. In the orthography used, a <j> corresponds to a voiced palato-alveolar affricate [dʒ], a <g> before an <i> a voiced palato-alveolar affricate [dʒ], a <k> before an <i> a voiceless post-alveolar affricate [tʃ], a <ny> a palatal nasal [ɲ], a <y> a palatal approximant [j]. All others correspond to their IPA counterparts. A double vowel represents a long vowel



(1) Luganda

a. Object left-dislocation (OLD)

A-m-envu o-mw-ana y-a-\*(ga)-gul-a.

6AUG-6-banana 1AUG-1-child 1SA-PST-6OM-buy-FV

‘The child bought the banana.’

b. Object right-dislocation (ORD)

O-mw-ana y-a-ga-gul-a luli, a-m-envu.

1AUG-1-child 1SA-PST-6OM-buy-FV the.other.day 6AUG-6-banana

‘The child bought the banana the other day.’

Empirically, I document the possible syntactic configurations related to object left and right-dislocation in the language, emphasizing in particular an asymmetry that becomes apparent only in ditransitive constructions. From a theoretical perspective, I propose an analysis inspired by Cecchetto (1999) and Zeller (2015) to capture the phenomenon. Given the complexity of the data, a number of standing issues are left for future investigation. The paper is structured as follows – in §2, I briefly discuss object dislocation cross-linguistically and in the Bantu family. In §3, I describe the pattern of object dislocation in Luganda. In §4, I present my analysis, establishing that OLD and ORD are each derived differently – OLD via base generation and ORD via movement. §5 lays out the predictions made by the proposal. Finally, §6 concludes and points out areas for future research.

## 2 Object marking and dislocation in Bantu

The analysis of object dislocation has received significant attention cross-linguistically, with a particularly rich body of work concerning the phenomenon in Romance languages (Anagnostopoulou to appear and references therein). Examples (2)a-b below show instances of object dislocation. Note that in both examples, the direct object is not in its canonical position (as evidenced by the prosodic break) and that the object co-occurs with a co-indexed clitic agreeing in  $\varphi$ -features with the object. The latter observation has led researchers to name the phenomenon clitic left-dislocation and clitic right-dislocation, respectively:<sup>2</sup>

---

and a double consonant a geminate. The notation || between two elements indicates that they are freely ordered. All translations are given in neutral word order, since I have not tried to replicate in English any of the pragmatic aspects of the Luganda data.

<sup>2</sup>Throughout the paper, I will use the neutral term object-dislocation for the Luganda data. Note however, that object markers in Bantu have been argued to be clitics (Diercks et al. 2015), so the clitic left-dislocation and clitic right-dislocation terminology might be appropriate for Bantu as well. I leave for future research determining whether OMs in Luganda should also be treated as clitics.

- (2) Italian (Cecchetto 1999)
- a. Clitic left-dislocation  
**Gianni**, io lo odio.  
**Gianni** I him hate  
 'I hate Gianni.'
  - b. Clitic right-dislocation  
 Io lo odio, **Gianni**.  
 I him hate **Gianni**.  
 'I hate Gianni.'

Object dislocation has also been investigated in the Bantu languages. First, note that across the family, it is possible to pronominalize an object with an object marker (henceforth OM) on the verb. This is shown below:<sup>3</sup>

- (3) Kuria (Diercks et al. 2015)
- a. n-aa-tɛm-ér-é                      ómo-gám̩bi  
 FOC.1sgSA-PST-hit-PERF-FV 1-king  
 'I hit the king.'
  - b. n-aa-mó-tɛm-ér-e  
 FOC.1sgSA-PST-1OM-hit-PERF-FV  
 'I hit him.'

Of particular interest has been whether an OM can co-occur with an *in-situ* object (henceforth OM doubling).<sup>4</sup> For instance, Bresnan & Mchombo (1987) analyze OMs in Chicheŵa as co-occurring with objects outside their canonical position (hence dislocated); in contrast OMs in Samba can co-occur with *in-situ* objects. (4) shows data from Chicheŵa and (5) from Samba:

- (4) Chicheŵa (Bresnan & Mchombo 1987)
- Njũchi zi-ná-wá-lum-a              alenje.  
 bees SA-PAST-OM-bite-INDIC hunters  
 'The bees bit them, the hunters.'

<sup>3</sup>See Marlo (2015) for an overview of OMing in Bantu.

<sup>4</sup>The distinction between Bantu languages that allow OM doubling versus those that only allow an OM to co-occur with a dislocated object mirrors the long tradition of distinguishing between languages that allow clitic doubling versus those that do not—see section 4 for relevant references.

- (5) Smbaa (Riedel 2009)  
N-za-**chi**-m-nka                      ng'wana **kitab**u.  
1sgSA-PERF.DJ-7OM-1OM-give 1child    7book  
'I gave the child a book.'

A Bantu language in which object dislocation has been studied in some depth is Zulu (van der Spuy 1993, Cheng & Downing 2009, Zeller 2009; 2015, Halpert & Zeller 2015); (6)a below shows an instance of left-dislocation; (6)b exemplifies right dislocation:

- (6) Zulu (Zeller 2009; Zeller 2015 respectively)
- a. Object left-dislocation (OLD)  
**UJohn** intombazana i-m-qabul-ile.  
**John**1a girl9                      SA-OM1a-kiss-PERF  
'John, the girl kissed (him).'
- b. Object right-dislocation (ORD)  
Ngi-ya-yi-theng-a i-moto  
1SA-DJ-9OM-buy-FV AUG-9.car  
'I bought (it), the car.'

With this background in mind, we can now turn to the pattern of OMinG and object dislocation in Luganda.

### 3 Patterns of object-dislocation in Luganda

#### 3.1 Object marking in Luganda

In this section, I describe the basic distribution of OMs and object dislocation in Luganda. The generalization that will arise is the following:

- (7) Object Dislocation and Object Marking (OMinG) Generalization in Luganda
- a. When one object is dislocated:
- i. It must co-occur with an OM both in OLD and ORD.<sup>5</sup>
- b. When two objects are dislocated:
- i. The dislocated objects occur in any order in OLD

---

<sup>5</sup>Although see section 6, where I note that an object can be right-dislocated without the appearance of an OM.



- ii. The dislocated objects must occur in the order GOAL/BEN > THEME in ORD
- iii. In both OLD and ORD, the objects co-occur with OMs and the order of OMs is always OM<sub>THEME</sub> > OM<sub>GOAL</sub>

In the interest of brevity, I will not describe in detail the pragmatic interpretation of dislocated objects in Luganda, since they align with broader cross-linguistic patterns of the phenomenon—(i) weakly quantified objects cannot dislocate, (ii) dislocated objects are interpreted as specific, and (iii) dislocated objects cannot be focused (see Hyman & Katamba 1993 and van der Wal & Namyalo 2016 for focus marking strategies in the language). Dislocated objects can function as a variety of topics (in the sense of Reinhart 1981; see Ranero 2015 for discussion), with some differences between left or right-dislocation. Particularly, right-dislocated objects can be exploited as afterthoughts—corrective statements to clarify part of an utterance to the interlocutor (Grosz & Ziv 1998; Villalba 2000).

As shown in the previous section for Bantu more broadly, objects in Luganda can be marked on the verbal stem through an OM that agrees in noun class with its corresponding object. I exemplify this below with a lexical ditransitive; note that Luganda is an SVO language and the order of postverbal objects in the ditransitive examples is strictly GOAL/BEN > THEME:

- (8) a. O-mu-sajja y-a-w-a            a-ba-kazi            ssente.  
1AUG-1-man 1SA-PST-give-FV 2AUG-2-woman 9a.money  
‘The man gave the women money.’
- b. \*O-mu-sajja y-a-w-a ssente a-ba-kazi.

Either of the objects can be OMed on the verb (9)a-b; both objects can be OMed on the verb as well, but the OMs must follow a strict ordering—OM<sub>THEME</sub> > OM<sub>GOAL/BEN</sub> (9)c. The reverse ordering OM<sub>GOAL/BEN</sub> > OM<sub>THEME</sub> is unacceptable (9)d:

- (9) a. O-mu-sajja y-a-ba-w-a            ssente.  
1AUG-1-man 1SA-PST-2OM-give-FV 9a.money  
‘The man gave them money.’
- b. O-mu-sajja y-a-zi-w-a            a-ba-kazi.  
1AUG-1-man 1SA-PST-9aOM-give-FV 2AUG-2-woman  
‘The man gave the women it.’

- c. O-mu-sajja y-a-zi-ba-w-a.  
 AUG-1-man 1SA-PST-9AOM-2OM-give-FV  
 ‘The man gave them it.’
- d. \*O-mu-sajja y-a-ba-zi-w-a.

As noted in the introduction, it has long been a concern in the Bantu literature whether OM doubling configurations are licit in particular languages. In Luganda, it is impossible for an OM to co-occur with an *in-situ* object, as evidenced by several diagnostics.<sup>6</sup> First, a prosodic pause is obligatory before an object in the right-periphery if it co-occurs with an OM on the verb, suggesting that the object is *ex-situ*. This diagnostic has been extensively used in the Romance literature (for instance Cecchetto 1999, Cruschina 2011, Anagnostopoulou to appear).<sup>7</sup> An example is shown below; note the obligatory pause before the object:<sup>8</sup>

- (10) Aisha y-a-bi-lab-a                      luli                      \*(,) e-bi-nyonyi.  
 1.Aisha 1SA-PST-8OM-see-FV the.other.day                      8AUG-8-bird  
 ‘Aisha saw the birds the other day.’

Second, the placement of temporal adverbs to demarcate the edge of the verb phrase has been used by others to diagnose OM doubling in Bantu (Henderson 2006; Riedel 2009 for Sambia; Bax & Diercks 2012 for Manyika; Diercks et al. 2018 for Lubukusu; Zeller 2009; 2015 for Zulu). If an object is to the left of the temporal adverb, it is *in-situ*, whereas an object to the right of the temporal adverb is in a dislocated position. In Luganda, if the object occurs to the left of the temporal adverb *luli*, an OM corresponding to the object cannot appear:

<sup>6</sup>Some diagnostics used in the Bantu literature to diagnose object-dislocation are not applicable to Luganda. These include the conjoint/disjoint alternation in languages like Zulu (Zeller 2015) and penultimate vowel lengthening to indicate the edge of a phrase (also in Zulu; Cheng & Downing 2009). I leave for future investigation the applicability of tonal diagnostics to determine the edge of phrases in Luganda (as in Chicheŵa; Bresnan & Mchombo 1987).

<sup>7</sup>This diagnostic is a one-way diagnostic—that is, the presence of a pause shows that the object is *ex-situ*, but the absence of a pause is not definitive evidence that the object is *in-situ* (see Diercks et al. 2018 for Lubukusu; Diercks et al. 2015 for Kuria). An anonymous reviewer asks to define more precisely what I mean by “prosodic pause” here. What I mean is that there is a short break in my consultant’s flow of speech before the right-dislocated object. I acknowledge that it would be useful to investigate what the acoustic correlates of this break are and whether there are other effects related to melodic contours, vowel lengthening, or tonal processes. I leave this for future research.

<sup>8</sup>Note that here an OM co-occurs with the right-dislocated object. In the final section, I point out the existence of a construction in which an object is right-dislocated but no OM appears.

- (11) \*O-m-wana y-a-ga-gul-a a-m-envu luli.  
 1AUG-1-child 1SA-PST-6OM-buy-FV 6AUG-6-banana the.other.day  
 Intended: ‘The child bought the banana the other day.’

In contrast, if the object is to the right of the temporal adverb, the OM can appear on the verb. I take this to mean that OMs in Luganda can only co-occur with dislocated objects:<sup>9</sup>

- (12) O-m-wana y-a-ga-gul-a luli, a-m-envu.  
 1AUG-1-child 1SA-PST-6OM-buy-FV the.other.day 6AUG-6-banana  
 ‘The child bought the banana the other day.’

Finally, we can construct a ditransitive utterance in which one of the objects is clearly *in-situ*; attempting to double the object with an OM is unacceptable. Consider the following example, where the GOAL/BEN is to the left of a weakly quantified object. Weakly quantified objects function as indefinites and as such cannot be topics (see Diesing 1992 on indefinites and Reinhart 1981 on why quantificational phrases cannot be interpreted as topics). Given that dislocated positions in Luganda are reserved for topics, we expect weakly quantified objects to be *in-situ* rather than dislocated. Since the GOAL/BEN argument is to the left of the weakly quantified object, it must also be *in-situ*:

- (13) \*Nakayiza y-a-mu-w-a Lukwaago e-bi-rabo bitono  
 1.Nakayiza 1SA-PST-1OM-give-FV 1.Lukwaago 8AUG-8-present 8.few  
 Intended: ‘Nakayiza gave Lukwaago few gifts.’ (Jenneke van der Wal field notes)

Given the previous discussion, we arrive at the following generalization—an OM can never double an *in-situ* object in Luganda, but it can co-occur with a dislocated object.

### 3.2 Object left-dislocation

As shown before, OMs can only co-occur with an object in Luganda if the object has been dislocated. Let us first explore the pattern of OLD. An object in Luganda can be dislocated to a pre-verbal position—the left-dislocated object can

<sup>9</sup>An anonymous reviewer asks whether using manner adverbials would be a better diagnostic to demarcate the edge of the verbal phrase, since temporal adverbs could be adjoined as high as TP. Data using manner adverbs were also collected and the pattern is the same as with temporal adverbs. Examples with a manner adverb are shown in (34) and (37).

either precede or follow the subject, as shown by the examples in (14)a-b below.<sup>10</sup> Note crucially that OMed the object is obligatory and failing to do so is unacceptable:<sup>11,12</sup>

- (14) a. **A-m-envu**, o-m-wana y-a-\*(ga-)gul-a.  
           **6AUG-6-banana** 1AUG-1-child 1SA-PST-**6OM-buy-FV**  
           ‘The child bought the bananas.’  
       b. O-m-wana **a-m-envu** y-a-\*(ga-)gul-a.

An object lacking the augment vowel cannot be left-dislocated, regardless of whether it is OMed or not. Augmentless nouns are in focus (Hyman & Katamba 1993), so this suggests that dislocated objects cannot be focused. An example with an augmentless noun is shown below in (15):<sup>13</sup>

- (15) \* **M-envu** o-m-wana y-a-(ga-)gul-a.  
           **6-banana** 1AUG-1-child 1SA-PST-**6OM-buy-FV**  
           Intended: ‘The child bought the bananas.’

In lexical ditransitives, either of the objects can be left-dislocated. As with previous OLD examples, OMed the dislocated object is obligatory; this is shown in (17)a-b:

- (16) Aizaka y-a-w-a            a-ba-kazi            e-ki-rabo.  
       1.Isaac 1SA-PST-give-FV 2AUG-2-woman 7AUG-7-gift  
       ‘Isaac gave the women a gift.’
- (17) a. **E-ki-rabo** Aizaka y-a-\*(ki)w-a            a-ba-kazi.  
           **7AUG-7-gift** 1.Isaac 1SA-PST-**7OM-give-FV** 2AUG-2-woman  
           ‘Isaac gave the women a gift.’

<sup>10</sup> An anonymous reviewer asks whether dislocation of the external argument was studied as well. Note that in (14)b, the subject must be left-dislocated, since it precedes the left-dislocated object. In §5, subject left and right-dislocation are used to test the predictions of the analysis. However, I leave for future research a full investigation of how dislocating the external argument interacts with object dislocation.

<sup>11</sup> A comma indicates a prosodic pause. A pause after a left-dislocated object is optional.

<sup>12</sup> Throughout all the dislocation examples, I will maintain a neutral translation that does not attempt to reflect the information structure considerations that render these constructions licit; I briefly discuss these information structure constraints, but refer the reader to Ranero (2015) for a more complete discussion.

<sup>13</sup> This relates to the observation before regarding the information structure constraints on dislocated objects, which can only function as topics.

- b. **A-ba-kazi**      Aizaka y-a-\*(ba-)w-a      e-ki-rabo.  
 2AUG-2-woman 1.Isaac 1SA-PST-2OM-give-FV 7AUG-7-gift  
 ‘Isaac gave the women a gift.’

Both objects can be left-dislocated in either order. If both objects are left-dislocated—regardless of the ordering in which they are dislocated—the OMs on the verb must follow the  $OM_{THEME} > OM_{GOAL/BEN}$  order. This is shown in (18)a-b below:

- (18) a. **E-ki-rabo** a-ba-kazi      Aizaka y-a-**ki**-ba-w-a.  
 7AUG-7-gift 2AUG-2-woman 1.Isaac 1SA-PST-7OM-2OM-give-FV  
 ‘Isaac gave the women a gift.’  
 b. A-ba-kazi      **e-ki-rabo** Aizaka y-a-**ki**-ba-w-a.  
 2AUG-2-woman 7AUG-7-gift 1.Isaac 1SA-PST-7OM-2OM-give-FV  
 ‘Isaac gave the women a gift.’

In contrast, if the ordering of OMs on the verb is  $OM_{GOAL/BEN} > OM_{THEME}$ , left-dislocating both objects in either order is unacceptable, showing that the ordering of OMs must be strictly  $OM_{THEME} > OM_{GOAL/BEN}$ :

- (19) a. \*Ekirabo abakazi Aizaka yabakiwa.  
 b. \*Abakazi ekirabo Aizaka yabakiwa.

If neither or only one of the left-dislocated objects is OMed, the utterance is unacceptable, as shown below in (20a-f):

- (20) a. \*Ekirabo abakazi Aizaka yawa.  
 b. \***Ekirabo** abakazi Aizaka yakiwa.  
 c. \*Ekirabo **abakazi** Aizaka yabawa.  
 d. \*Abakazi ekirabo Aizaka yawa.  
 e. \***Abakazi** ekirabo Aizaka yabawa.  
 f. \*Abakazi **ekirabo** Aizaka yakiwa.

All the patterns described here are replicated with applicative and causative constructions (see Ranero 2015). The essential observation of OLD for the purposes of the upcoming analysis is the following: in ditransitive constructions, either or both objects can be left-dislocated in either order, but the ordering of OMs is strictly  $OM_{THEME} > OM_{GOAL/BEN}$ .

### 3.3 Object right-dislocation

An object in Luganda can be dislocated to a position in the right periphery; an example in a monotransitive clause is shown below. Recall that objects to the right of a temporal adverb are dislocated:<sup>14</sup> and note that an OM co-occurs with the dislocated object:

- (21) Aisha y-a-**bi**-lab-a luli, e-**bi**-nyonyi.  
1.Aisha 1SA-PST-8OM-see-FV the.other.day 8AUG-8-bird  
'Aisha saw the birds the other day.'

As with OLD, an augmentless object cannot be right-dislocated:<sup>15</sup>

- (22) \* Aisha y-a-**bi**-lab-a luli, **bi**-nyonyi.  
1.Aisha 1SA-PST-8OM-see-FV the.other.day 8-bird  
Intended: 'Aisha saw the birds the other day.'

In ditransitive constructions, either the GOAL/BEN or THEME argument can be right-dislocated; note that an OM co-occurs with the right-dislocated object:<sup>16</sup>

- (23) Namugga y-a-**ba**-fumb-ir-a e-n-gege luli,  
1.Namugga 1SA-PST-2OM-cook-APPL-FV9 AUG-9-tilapia the.other.day  
**a-ba-ana**.  
2AUG-2-child

'Namugga cooked the tilapia for the children the other day.'

- (24) Namugga y-a-**gi**-fumb-ir-a a-ba-ana luli,  
1.Namugga 1SA-PST-9OM-cook-APPL-FV 2AUG-2-child the.other.day  
**e-n-gege**.  
9AUG-9-tilapia

'Namugga cooked the tilapia for the children the other day.'

---

<sup>14</sup>Further evidence for this claim comes from the observation that weakly quantified objects cannot appear to the right of a temporal adverb

- (i) \* Aisha y-a-(bi-)lab-a luli, e-**bi**-wugulu bitono.  
1.Aisha 1SA-PST-8OM-see-FV the.other.day 8AUG-8-owl 8.few  
Intended: 'Aisha saw few owls the other day.'

<sup>15</sup>Regardless of whether the OM is present or not; see §6 for an example of ORD without an OM.

<sup>16</sup>I exemplify throughout with an applicative construction, although the pattern is replicated as well with lexical ditransitives (see Ranero 2015).

Both objects can be right-dislocated in a ditransitive construction. The objects must be dislocated in the order GOAL/BEN > THEME and the OMs on the verb must be strictly ordered  $OM_{THEME} > OM_{GOAL/BEN}$ :

- (25) Namugga y-a-gi-**ba**-fumb-ir-a luli, a-**ba**-ana  
 1.Namugga 1SA-PST-9OM-2OM-cook-APPL-FV the.other.day 2AUG-2-child  
 e-n-gege.  
 9AUG-9-tilapia  
 ‘Namugga cooked the tilapia for the children the other day.’

Right dislocating the objects in the order THEME > GOAL/BEN is unacceptable, as in (26); OMing in the order  $OM_{GOAL/BEN} > OM_{THEME}$  is unacceptable regardless of the ordering of the right-dislocated objects, as in (27a-b):

- (26) \* Namugga y-a-gi-**ba**-fumb-ir-a luli, e-n-gege a-**ba**-ana.  
 (27) a. \*Namugga y-a-**ba**-gi-fumb-ir-a luli, a-**ba**-ana e-n-gege.  
 b. \*Namugga y-a-**ba**-gi-fumb-ir-a luli, e-n-gege a-**ba**-ana.

The essential aspects of ORD are the following: in ditransitives, if both objects are right-dislocated, not only is the ordering of OMs strictly  $OM_{THEME} > OM_{GOAL/BEN}$  (as with the left-dislocation pattern), but the ordering of the dislocated objects is also strict—GOAL/BEN > THEME.

## 4 Analysis

The literature on generative approaches to the syntax of object-dislocation is extensive. In particular, debates have centered on whether dislocated objects surface in their position through base generation or movement, a distinction that I will argue allows us to explain the asymmetry we observed regarding dislocation of both objects in ditransitives in OLD vs. ORD. While it is not my purpose to review the literature in detail, the following are representative of different approaches. Analyzing left-dislocation as base generation, Cinque (1990), Iatridou (1995), Anagnostopoulou (1994), Suñer (2006), De Cat (2007) are representative; analyzing the phenomenon as the result of movement, Kayne (1994), Zubizarreta (1998), and Zeller (2009). Moving on to right-dislocation, Kayne (1994) and Cardinaletti (2002) treat the phenomenon as base generation, while Kayne (1995), Cecchetto (1999), Zeller (2015) and Samek-Lodovici (2016) treat it as movement. Given the variety of possible analyses, I will make my proposal and explore its

predictions. In so doing, I bring Luganda to bear on the issue of the analysis of these phenomena, while also highlighting another instance of a left vs. right periphery asymmetry that deserves further investigation.

First, let us summarize the core of the proposal:

(28) Object-dislocation in Luganda

- a. Object left-dislocation and right-dislocation in Luganda are not derived through the same mechanism.
- b. Left-dislocated objects are base generated.
- c. Right-dislocated objects arise in their surface position via movement.

This proposal is similar in spirit to an argument made for the analysis of dislocation in Romance languages in Cecchetto (1999), which rejected the hypothesis from Vallduví (1992) that clitic right-dislocation is simply the “mirror image” of clitic left-dislocation. Let us now turn to the analytical assumptions which lead me to propose (28). I take a Minimalist approach couched in the Agree based system (Chomsky 2000 and subsequent work). I assume the operation Merge to come in (at least) two flavors: External Merge, which is when an object not previously introduced into the derivation is taken from the Numeration and merged, and Internal Merge, which involves taking an item previously introduced into the derivation and merging it, resulting in Movement. I assume that Internal Merge (Movement) is driven by an operation Agree, which involves feature-valuation between a Probe and Goal:

(29) Agree

Operation in which a Probe enters into a relation with a Goal it c-commands. The operation applies when a Probe bears an unvalued feature [uF] and enters into an Agree relation with a Goal bearing a valued feature [iF].

Unvalued features must be valued in the course of the narrow syntactic derivation in order to avoid a crash—that is, unvalued features may not arrive at LF without having been valued through the Agree operation. An additional ingredient to Movement involves an EPP feature on the Probe. An EPP feature dictates that movement must occur, so the Goal raises locally to the specifier of the Probe head. An illustration of movement in the context of *wh*-features is observed below; notice crucially that the probe is looking for a Goal with the relevant feature (in this case *wh*-features); if there were an intervening DP that did not possess the relevant feature, the probe would ignore it and no intervention effect would arise:



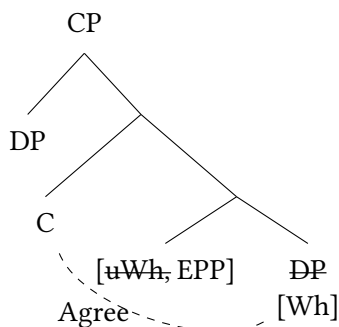

Figure 1: Agree and movement

As can be observed from Figure 1 as well, I assume that moved elements leave behind a copy—thus I also assume the Copy Theory of Movement (Chomsky 1995). Copies that are left behind from movement are readable at LF and contribute to the interpretation of the utterance. If there are several copies of an element in the derivation that is shipped to LF, then LF has a choice as to which copy to interpret, thus accounting for sentences where several readings are possible. As will be observed later on, the existence of these copies make predictions regarding the interpretation of sentences where I analyze that movement has taken place. Furthermore, I also assume that in carrying out the Agree operation, Locality is essential. I define Locality below (see Zeller (2015) for a similar definition):

(30) Locality

A Probe P with an unvalued feature [uF] enters into an Agree relation with a Goal G if G is the closest element bearing a valued Feature [iF]. If there are two Goals G and G' in P's c-command domain, then G is closer to P than G' if G asymmetrically c-commands G'.

Another assumption I will make is that copies of moved elements do not intervene between a Probe and a Goal for Locality purposes. When there are two potential Goals with a relevant Feature, a Probe (P) with an [EPP] feature searches its c-command domain and Agrees with the closest Goal (G). Once this Goal (G) has been moved, a second Probe (P') can then search its c-command domain and reach another Goal (G'). The copy left behind by G between this second Probe (P') and second Goal (G') does not count as an intervener. This is illustrated below:

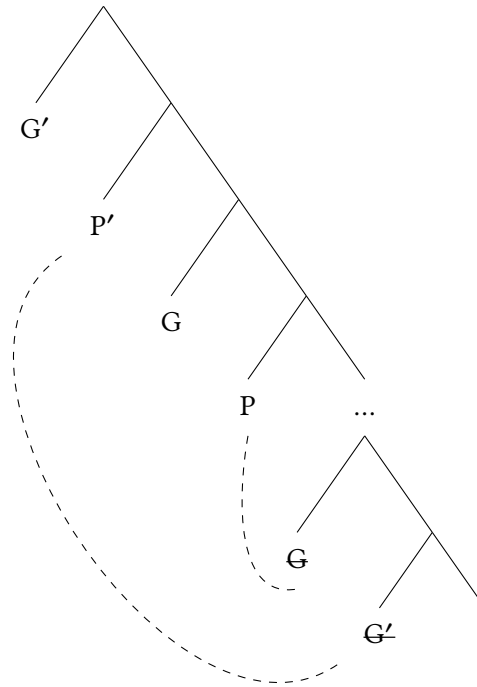

Figure 2: Locality and intervention

With these assumptions in place, we can move to the specifics of the analysis. I propose following Zeller (2015) that right-dislocated objects that co-occur with an OM on the verb move to the right-branching specifier of an optional projection immediately above  $v$ , which is labeled TopP in what follows.<sup>17</sup> The movement of the object is triggered by an Agree operation between the head of the projection Top, which is specified for an unvalued topic feature [uTop]<sup>18</sup> and

<sup>17</sup>Right-branching specifiers have been proposed to account for word order in a variety of languages. For instance, Chung (1998) provides an array of diagnostics showing that specifiers branch rightwards in Chamorro (Austronesian), while Aissen (1992) accounts for VOS order in Mayan languages through the subject occupying a right-branching specifier.

<sup>18</sup>Zeller (2015) calls this feature “anti-focus”, primarily because non-focused DPs in Zulu must vacate the  $vP$ . Given that this does not apply to Luganda, I use [Top] as the relevant feature, given the interpretation of the dislocated objects.

unvalued  $\varphi$ -features [ $u\varphi$ ], and a Goal bearing valued topic [ $iTop$ ] and valued  $\varphi$ -features [ $i\varphi$ ].<sup>19</sup> It is crucial for our analysis that the main probe is the [ $uTop$ ] and the [ $u\varphi$ ] is parasitic on the main probe; we thus ensure that OMs never double an in-situ object, but only topicalized dislocated ones.<sup>20</sup> When the head of the projection Top acts as a Probe and searches its c-command domain, it finds a DP with valued topic features [ $iTop$ ], triggering an Agree relation.<sup>21</sup> The head Top carries an [EPP] feature that causes the DP object with which it agrees to move to a right-branching specifier, resulting in a right-dislocation configuration. The Agreement operation also results in the spell-out of the valued  $\varphi$ -features on the head Top as the object marker OM, which then joins with the verb as the verb moves up through the structure to reach its final landing place, accounting for the morpheme order.<sup>22</sup> Given space considerations, I do not illustrate the analysis with monotransitives, but move directly to the most complex case, with two objects. An illustration of double object right-dislocation is shown below in Figure 3. The curved line indicates an Agree relation and the arrow indicates movement:

- (31) Namugga y-a-gi-**ba**-fumb-ir-a luli, a-**ba**-ana  
 1.Namugga 1SA-PST-9OM-2OM-cook-APPL-FV the.other.day 2AUG-2-child  
 e-n-gege.  
 9AUG-9-tilapia  
 ‘Namugga cooked the tilapia for the children the other day.’ (repeated  
 from (25))

<sup>19</sup>An anonymous reviewer asks why the external argument does not intervene. I assume that the external argument does not carry an [ $iTop$ ], so it cannot be an intervener for the Top that is searching for this specific feature—the object is the first relevant DP carrying the feature. Whether features relevant to information-structure considerations are active in the narrow syntax is an issue of ongoing debate in the literature, particularly among proponents and critics of the cartographic approach (Rizzi 1997 and subsequent work); see for instance Landman & Ranero (2018) for a proposal in favor of such an architecture in Bantu and Horvath (2007) for a contrary position to the general idea.

<sup>20</sup>An anonymous reviewer asks what we mean by the [ $\varphi$ ] features being parasitic on [Top]. I simply mean to capture the fact that OMs never occur unless the Top head is merged; this head then enters into an Agree relation with an object that is a topic and the  $\varphi$ -agreement is spelled-out as the OM. Note that Top enters into an Agree relation with pro and an OM is spelled out in cases where there is no overt object at all—see (9)a-c.

<sup>21</sup>I crucially assume the Weak Phase Impenetrability Condition; the complement of the v phase does not become unavailable for syntactic computation until the higher C phase head is merged (Citko 2014).

<sup>22</sup>An alternative placement for the Topic projection would be high in the left-periphery. However, note that the placement of the OM immediately before the root should reflect the syntactic configuration, in adherence to the Mirror Principle (Baker 1985). Therefore, I propose the existence of the low Top position in Luganda.

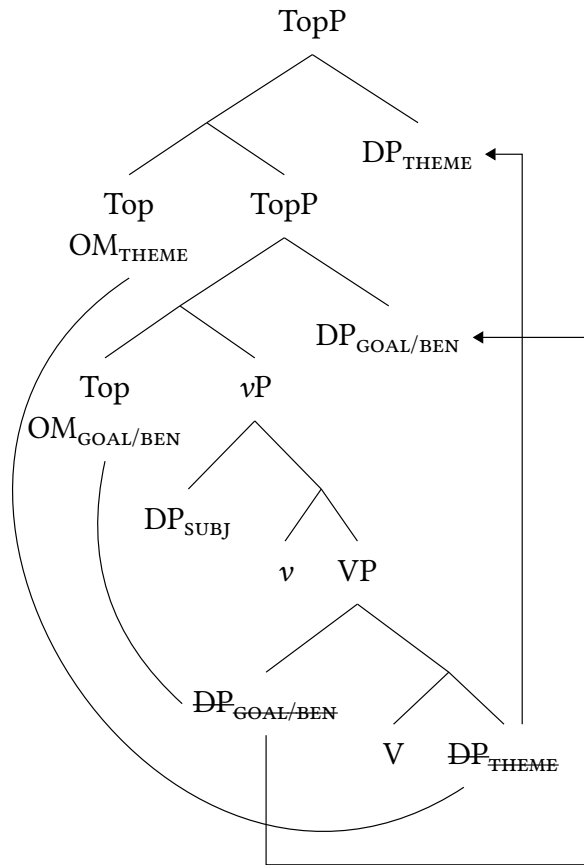

Figure 3: Double object right-dislocation

Let us summarize the essential steps in the derivation above. The first **Top** head merges above **vP** and searches its c-command domain—given Locality, it finds the **DP<sub>GOAL/BEN</sub>**, which moves to a rightward specifier. When a second **Top** is merged (given proper discourse configurations), it searches its c-command domain for a goal and finds the **DP<sub>THEME</sub>**, which moves as well. Therefore, when two DPs carry a Topic feature, the **DP<sub>GOAL/BEN</sub>** will raise to **SpecTopP** of the lower **TopP**, while the **DP<sub>THEME</sub>** will raise to **SpecTopP** of the higher **TopP**; we

have thus derived the strict ordering of dislocated DPs in right-dislocation.<sup>23</sup> Crucially, we have also accounted for the ordering of the OMs—given our analysis, the OM<sub>GOAL/BEN</sub> surfaces closer to the verb root. Since the right-dislocated object is outside the *v*P, which I take to be a prosodic domain, we can also straightforwardly account for the obligatory presence of a pause between *v*P internal elements and the right-dislocated objects.

Let us now turn to OLD. In contrast to the previous discussion, I propose that a left-dislocated object is base generated in its surface position in the specifier of an XP<sup>24</sup> projection above TP. The obligatory OM in left-dislocation constructions arises via an Agree relation between the head Top that searches its c-command domain for a Goal bearing an unvalued Top feature [*i*Top]. The Goal that Top finds is a pro argument that is co-referential with the DP base generated in left-dislocated position; the left-dislocated object binds the null pro<sup>25</sup>. The subject raises to SpecTP, accounting for the observed word order. Given space considerations, I illustrate the analysis with a double object construction outright:

- (32) **E-ki-rabo** a-ba-kazi      Aizaka y-a-ki-ba-w-a.  
 7AUG-7-gift 2AUG-2-woman 1.Isaac 1SA-PST-7OM-2OM-give-FV  
 ‘Isaac gave the women a gift.’ (repeated from (18)a)

<sup>23</sup>This immediately highlights the virtue of this analysis over one that would assume the antisymmetric program (Kayne 1994), which bans rightward specifiers. Under such an approach, right dislocation would have to be derived in Luganda via movement of the DP objects to leftward-specifiers, followed by remnant movement of the *v*P above them — however, note that that account would predict the wrong strict ordering of the dislocated objects (DP<sub>THEME</sub> > DP<sub>GOAL/BEN</sub>). Given this strikingly inaccurate prediction, we do not take such an approach, noting additionally that the antisymmetric program has been called into question for independent reasons (Abels & Neeleman 2009).

<sup>24</sup>I could have called this TopP as well, but I call it XP to avoid confusion with ORD.

<sup>25</sup>Given that pro is phonetically null, it is irrelevant for our purposes whether Top carries an [EPP] feature in examples like these and pro raises to the right-branching specifier of Top. An anonymous reviewer asks how we ensure that left-dislocation does not co-occur with an overt object in base position. In other languages that allow object left-dislocation, having an object in base position as well is unacceptable:

- (i) \*A Juan, yo lo vi a Juan.  
 a Juan I CL saw a Juan  
 Intended: ‘I saw Juan.’ (Spanish)

There certainly exist phenomena where multiple links in a chain are realized (Nunes 2004), but my analysis of OLD does not involve movement. There could be two reasons then for a left-dislocated object not co-occurring with an overt object in base position: (i) as a result of the base generation analysis versus a movement one, or (ii) pragmatic reasons that have nothing to do with the syntax—repetition is simply dispreferred. I leave for future research exploring whether a base generation analysis of object-dislocation excludes the pronunciation of the dislocated object and an identical object in base position due to syntactic or extra-grammatical reasons.

Given Locality, the Top merged first will find the  $DP_{GOAL/BEN}$  argument and Agree with it, resulting in the spell-out of an OM. The Top merged above it will then search its  $c$ -command domain and find the  $DP_{THEME}$  argument, resulting in the spell-out of the second OM. Base generation allows for the left-dislocated objects to be ordered freely, so the position of the dislocated DP objects could be swapped, accounting for the two data points in (18)a-b. Note crucially that the way we derive the OMs is the same between object left and right-dislocation, thus accounting for their identical ordering in both constructions. We therefore derive the strict ordering of the OMs, while also deriving the free ordering of both objects in left-dislocation and the strict ordering of both objects in right-dislocation. In the next section, I show that several predictions made by the analysis are borne out.<sup>26</sup>

## 5 Predictions of the analysis

### 5.1 Principle C violations

In this section, I show that three predictions made by my account are borne out, suggesting that the base generation vs. movement approach to left and right object-dislocation in Luganda is on the right track.<sup>27</sup>

First, the base generation analysis for left-dislocation predicts that an R-expression in a left-dislocated position should be able to co-refer with a pronoun in the main clause.<sup>28</sup> Given that a left-dislocated object does not move out of a  $vP$  internal position, no Principle C<sup>29</sup> violation should be incurred through-

---

<sup>26</sup>The analysis presented here contrasts with Zulu in two ways. First, Zulu allows for double-object dislocation, but only for one OM on the verb (though Adams 2010 claims that a second OM in double object-dislocation constructions is phonologically null; see Zeller 2015 for discussion); second, Zeller (2009) claims that OLD is derived via movement, even if both left-dislocated objects are ordered freely (see fn.27). Given that OMing in other languages such as Chicheŵa is restricted thematically, we do not delve into the details of their analysis, though see Bresnan & Mchombo (1987) for a seminal treatment of objects and OMs in that language.

<sup>27</sup>The three diagnostics presented in this section follow Zeller (2009), which explores OLD in Zulu. Applied to Zulu, the diagnostics in §5.1 and §5.2 yield the opposite result to Luganda, suggesting that left-dislocated objects in Zulu are derived via movement.

<sup>28</sup>This follows from the Copy Theory of Movement, which proposes that a moved phrase leaves behind a copy in  $A$ -bar movement configurations (unpronounced at PF) that is relevant for interpretation at LF. If the left dislocated object were generated from inside the VP and moved to its base position in the left periphery, we would expect that the lower copy of the object R-expression would be bound by the pronoun at LF and a Principle C violation would result.

<sup>29</sup>Principle C: An R-expression (an expression that introduces a referent) must be free; it cannot be  $c$ -commanded by a co-indexed category at LF.

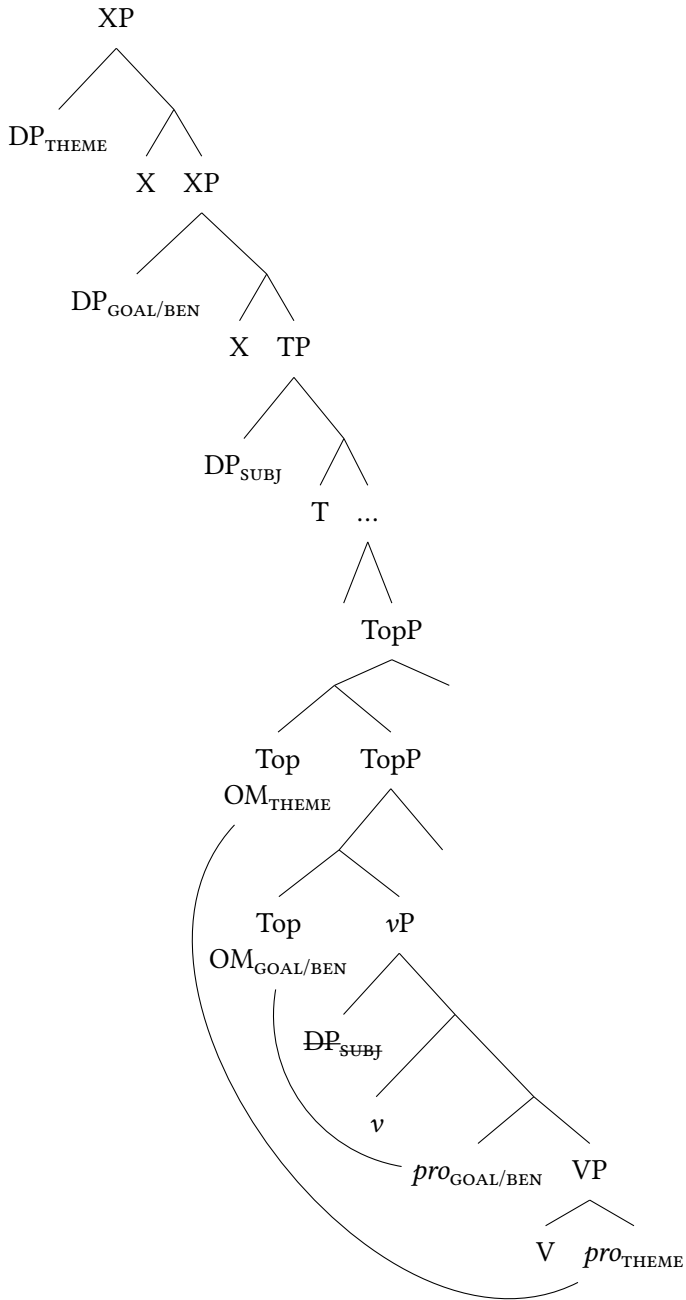

Figure 4: Double object left-dislocation

out the derivation. This is exactly what we find. Consider the following examples: in the canonical sentence in (33)a, a Principle C violation occurs, resulting in an unacceptable sentence if ‘she’ is co-indexed and c-commands ‘Aisha’; contrast with (33)b, where both a free and bound reading are available if the object is left-dislocated:

- (33) a. Ye y-a-lab-a            a-ba-wala            ba    Aisha.  
           she 1SA-PST-see-FV 2AUG-2-daughter 2.POSS 1.Aisha  
           ‘\*She<sub>i</sub> saw Aisha’s<sub>i</sub> daughters.’ (bound) / ‘She<sub>i</sub> saw Aisha’s<sub>j</sub>  
           daughters.’ (free)
- b. A-ba-wala            ba    Aisha, ye y-a-ba-lab-a.  
           2AUG-2-daughter 2.POSS 1.Aisha 3sg 1SA-PST-2OM-see-FV  
           ‘She<sub>i</sub> saw Aisha’s<sub>i</sub> daughters.’(bound) / ‘She<sub>i</sub> saw Aisha’s<sub>j</sub> daughters.’  
           (free)

In contrast, the analysis predicts that the equivalent of sentence (33)b in a right-dislocated context should not have two possible readings. If a right-dislocated R-expression moves out of the VP to its surface position, the lower copy should be bound by the subject pronoun at LF and a Principle C violation would result. This is exactly what we find. Notice that in both the canonical sentence in (34)a and the example with a right-dislocated object in (34)b, the bound reading is impossible:<sup>30</sup>

- (34) a. Ye y-a-vug-a            e-mmottoka ya            Babirye bulunji.  
           3sg 1SA-PST-drive-FV 9aAUG-9a.car 9a.POSS 1.Babirye well  
           ‘\*She<sub>i</sub> drove Babirye’s<sub>i</sub> car well.’ (bound) / ‘She<sub>i</sub> drove Babirye’s<sub>j</sub> car  
           well.’ (free)

---

<sup>30</sup> An anonymous reviewer wonders given (34) why an English example like ‘Which of Sophie’s<sub>i</sub> daughters did she<sub>i</sub> send a care package to?’ is not ungrammatical, since the subject c-commands the lower copy of Sophie. Note that the example offered by the reviewer is not exactly parallel to the Luganda data, since the R-expression is more deeply embedded in the English sentence. The degree of embedding seems relevant for examples involving topicalization in English:

- (i) \*Sophie<sub>i</sub>, she<sub>i</sub> saw <Sophie<sub>i</sub>>.  
       Intended: Sophie saw herself.

The example above seems to involve obligatory reconstruction, resulting in the Principle C Violation; this contrasts with the acceptable example raised by the reviewer. I leave for future investigation whether there are cases in Luganda where reconstruction is not obligatory (similar to the example offered by the reviewer), resulting in acceptable examples involving ORD that contrast with the result in (34).



- b. Ye y-a-gi-vug-a bulunji, e-mottoka ya Babirye.  
 3sg 1SA-PST-9aOM-drive-FV well 9aAUG-9a.car 9a.POSS 1.Babirye  
 \*‘She<sub>i</sub> drove Babirye’s<sub>j</sub> car well.’ (bound) / ‘She<sub>i</sub> drove Babirye’s<sub>j</sub> car  
 well.’ (free)

## 5.2 Binding of variables

Another prediction made by the analysis concerns the binding of variables. If we assume that bound pronouns must be bound at LF by a quantified phrase (see Hornstein & Weinberg 1990), then my analysis would predict that in left-dislocating an object, only a free reading should be possible. This follows from the observation that under a base generation analysis for left-dislocated objects, there is no copy of the object at LF that can be bound by a quantified subject. This prediction is indeed borne out: contrast the readings available for the canonical sentence in (35) below with the unavailability of a bound reading in the sentence in (36), where the object is left-dislocated:

- (35) Buli mu-yiizi y-a-buuz-a o-mu-somesa we.  
 every 1-student 1SA-PST-greet-FV 1AUG-1-teacher 1.POSS  
 ‘Every student greeted his teacher.’  
 For every student *x*, *x* greeted *x*’s teacher. = AVAILABLE  
 For every student *x*, *x* greeted *y*’s teacher. = AVAILABLE
- (36) O-mu-somesa we buli mu-yiizi y-a-mu-buuz-a.  
 1AUG-1-teacher 1.POSS every 1-student 1SA-PST-1OM-greet-FV  
 ‘Every student greeted his teacher.’  
 For every student *x*, *x* greeted *x*’s teacher. = UNAVAILABLE  
 For every student *x*, *x* greeted *y*’s teacher. = AVAILABLE

In contrast, I also predict that a bound reading should be available in the context of right-dislocation, given that there is a copy in base position. This is exactly what we find, as shown by the example below:<sup>31</sup>

<sup>31</sup>An anonymous reviewer asks how movement facilitates binding in ORD. I clarify that it’s not the movement itself that facilitates binding, but the existence of the VP internal copy of the dislocated object in ORD. In contrast, such a copy does not exist in OLD.

- (37) Buli mu-yiizi y-a-mu-buuz-a <o-mu-somesa we> bulunji,  
every 1-student 1SA-PST-1OM-greet-FV <1AUG-1-teacher 1.POSS> well  
o-mu-somesa we.  
1AUG-1-teacher 1.POSS

‘Every student greeted his teacher well.’

For every student x, x greeted x’s teacher well. = AVAILABLE

For every student x, x greeted y’s teacher well. = AVAILABLE

Since right-dislocated objects are the product of movement, the pronoun contained in the right-dislocated phrase above can be bound by the quantifier subject covertly at LF. Thus, we can see that further evidence for the analysis comes from the behavior of bound variables with respect to left and right object-dislocation.

### 5.3 Superiority effects

A final prediction concerns superiority effects. When two phrases undergo A’-movement, the structural hierarchy from which they are extracted affects the linear order in which they appear following movement. If this superiority condition is an inviolable constraint, we expect that in dislocated constructions that are derived via A’-movement, superiority effects would emerge. In contrast, if dislocated phrases are not the result of A’-movement, but are rather base generated in their surface positions, then we predict that no superiority effects would arise. The latter case is exactly what we find in Luganda OLD: no superiority effects arise. Consider first the canonical utterance below:

- (38) O-mu-somesa a-kkakas-a nti a-ba-yiizi ba-a-soma  
1AUG-1-teacher 1SA.PRS-believe-FV COMP 2AUG-2-student 2SA-PST-read  
e-ki-tabo.  
7AUG-7-book

‘The teacher believes that the students read the book.’

In left-dislocating both the embedded subject and object in the sentence above, a movement approach to left-dislocation would predict that the ordering would have to be fixed and mirror the structural relations between the arguments—that is, the dislocated subject would have to precede and c-command the dislocated object. However, in dislocating both embedded subject and object, we find that their ordering is free:

- (39) A-ba-yiizi || e-ki-tabo o-mu-somesa a-kkakas-a nti  
 2AUG-2-student 7AUG-7-book 1AUG-1-teacher 1SA.PRS-believe-FV COMP  
 ba-a-ki-som-a.  
 2SA-PST-7OM-read-FV  
 ‘The teacher believes that the students read the book.’

In contrast, superiority effects arise in right-dislocation contexts. Consider first the sentence below:

- (40) A-ba-yiizi ba-a-som-a e-ki-tabo luli.  
 2AUG-2-student 2SA-PST-read-FV 7AUG-7-book the.other.day  
 ‘The students read the book.’

If both subject and object are right-dislocated, only one ordering is permitted. In (41)a, observe that the dislocated-object precedes the dislocated subject. Attempting the opposite ordering as in (41)b is unacceptable:

- (41) a. Ba-a-ki-som-a luli, e-ki-tabo a-ba-yiizi.  
 2SA-PST-7OM-read-FV the.other.day 7AUG-7-book 2AUG-2-student  
 ‘The students read the book.’  
 b. \* Ba-a-ki-som-a luli, abayiizi, ekitabo.

I take these facts to be evidence that a movement analysis for right-dislocation is on the right track, while a base-generation analysis for left-dislocation also makes the correct predictions.

## 6 Conclusions and future directions

In this paper, I have achieved the following: empirically, I have documented an asymmetry concerning left vs. right object-dislocation in Luganda, therefore contributing to our knowledge on the language and the patterning of these phenomena cross-linguistically; from a theoretical perspective, I have shown that an approach treating these two constructions as arising from different syntactic configurations is on the right track. Several questions remain, which cannot be addressed in this short paper, though they are described in Ranero (2015) and are left for future investigation. First, causative ditransitives do not show the asymmetry we described for ORD – if two objects are right-dislocated in a causative construction, they are ordered freely. Second, there exists a very limited construction in which an object is right-dislocated, but no OMI<sub>ng</sub> is triggered. Observe

the example below: since the object that is not OMed on the verb occurs to the right of a dislocated object that is OMed, then it must also be right-dislocated:

- (42) Namugga y-a-ba-fumb-ir-a luli, a-ba-ana  
1.Namugga 1SA-PST-2OM-cook-APPL-FV the.other.day 2AUG-2-child  
**e-n-gege.**  
**9AUG-9-tilapia**  
‘Namuga cooked the tilapia for the children the other day.’

Objects that are right-dislocated but not OMed are very restricted pragmatically, being limited exclusively to given topics. Due to space considerations, I leave their derivation for future investigation. Third, my analysis makes predictions regarding island effects (Boeckx 2012): right-dislocated objects should be subject to island restrictions, while left-dislocated ones should not. However, this is not consistently the case. For instance, right-dislocating an object out of a coordinated structure is banned (as predicted), but so is left-dislocating the object, contrary to our expectations:

- (43) \*Aisha y-a-fumb-a naye ye Aizaka y-a-(ki-)som-a  
1.Aisha 1SA-PST-cook-FV but 1.FOC 1.Isaac 1SA-PST-7OM-read-FV  
luli, **e-ki-tabo.**  
the.other.day 7AUG-7-**book**  
Intended: ‘Aisha cooked but Isaac read a book the other day.’

- (44) \***E-ki-tabo** Aisha y-a-fumb-a naye ye Aizaka  
7AUG-7-**book** 1.Aisha 1SA-PST-cook-FV but 1.FOC 1.Isaac  
y-a-ki-som-a.  
1SA-PST-7OM-read-FV  
Intended: ‘Aisha cooked but Isaac read a book.’

While such data are puzzling, I note that there exist approaches to left-dislocation that take a base generation approach regardless of island restrictions, such as Cinque (1990) and Iatridou (1995). Given that the study of islands in Luganda has not yet been undertaken in depth, I leave whether these data can be accommodated into our analysis for future investigation as well. Finally, it is necessary to point out avenues for future research in this area of Bantu syntax. As Zeller (2015) notes, while the syntax of object marking in the family has received extensive attention, double object-dislocation constructions specifically

have been restricted to few studies (e.g. Adams 2010, Zeller 2009, and Zeller 2015 for Zulu). Further, the pattern reported here has not been described for other Bantu languages, as far as I know. A first step for future investigation would involve studying double object-dislocation constructions in other Bantu languages that also permit two OMs on the verb. Marlo (2015) points out that the following languages allow for this: Bemba, Dciriku, Ha, Jita, Lungu, Lwena, Nyambo, Nyole, Ruri, Saamia, Taabwa, Tiriki, Ruwund, and Umbundu. Replicating the Luganda data would be a fruitful area of research, both to increase our knowledge of the typology of these constructions, and to explore whether the syntactic principles used here to account for the Luganda patterns can be applied more broadly.

## Acknowledgements

I thank Saudah Namyalo for her patience in providing the acceptability judgments reported here and Jenneke van der Wal for her support throughout the development of this project. Thank you as well to the audience at ACAL 47, Gesoel Mendes, and Ted Levin for helpful comments. This paper summarizes and expands upon Ranero (2015); for questions, contact the author at rranero@umd.edu.

## Abbreviations

Numbers indicate Bantu noun class, following Hyman & Katamba (1990).

APPL	applicative	INDIC	indicative
AUG	augment	OM	object marker
CAUS	causative	PERF	perfective
COMP	complementizer	POSS	possessive
DJ	disjoint	PRS	present
FOC	focus	PST	past
FUT	future	SA	subject agreement
FV	final vowel		

## References

- Abels, Klaus & Ad Neeleman. 2009. *Universal 20 without the LCA*. Jose M. Brucart, Anna Gavarró & Jaume Solá (eds.). Oxford: Oxford University Press.
- Adams, Nikki. 2010. *The Zulu ditransitive phrase*. University of Chicago. (Doctoral dissertation).

- Aissen, Judith. 1992. Topic and focus in Mayan. *Language* 68(1). 43–80.
- Anagnostopoulou, Elena. 1994. *Clitic dependencies in Modern Greek*. Salzburg University. (Doctoral dissertation).
- Anagnostopoulou, Elena. to appear. Clitic doubling. In Martin Everaert & Henk van Riemsdijk (eds.), *The Blackwell companion to syntax*. London: Blackwell Publishing.
- Baker, Mark. 1985. The Mirror Principle and morphosyntactic explanation. *Linguistic Inquiry* 16.3. 373–415.
- Bax, Anna & Michael Diercks. 2012. Information structure constraints on object marking in Manyika. *Southern African Linguistics and Applied Language Studies* 30(2). 185–202.
- Boeckx, Cedric. 2012. *Syntactic islands*. Cambridge: Cambridge University Press.
- Bresnan, Joan & Sam Mchombo. 1987. Topic, pronoun, and agreement in Chichêwa. *Language* 63. 741–782.
- Cardinaletti, Anna. 2002. Against optional and null clitics. Right dislocation vs. Marginalization. *Studia Linguistica* 56. 29–57.
- Cecchetto, Carlo. 1999. A comparative analysis of left and right dislocation in Romance. *Studia Linguistica* 53(1). 40–67.
- Cheng, Lisa & Laura J. Downing. 2009. Where's the topic in Zulu? *The Linguistic Review* 26(2–3). 207–238.
- Chomsky, Noam. 1995. *The minimalist program*. Cambridge: MIT Press.
- Chomsky, Noam. 2000. Minimalist inquiries: The framework. In Roger Martin, David Michaels, Juan Uriagereka & Samuel Jay Keyser (eds.), *Step by step: essays on minimalist syntax in honor of Howard Lasnik*.
- Chung, Sandra. 1998. *The design of agreement: Evidence from Chamorro*. Chicago: University of Chicago Press.
- Cinque, Guglielmo. 1990. *Types of  $\bar{a}$ -dependencies*. The MIT Press: Cambridge, MA.
- Citko, Barbara. 2014. *Phase theory: An introduction*. Cambridge: Cambridge University Press.
- Cruschina, Silvio. 2011. *Discourse-related features and functional projections*. Oxford: Oxford University Press.
- De Cat, Cecile. 2007. French dislocation without movement. *Natural Language & Linguistic Theory* 25(3). 485–534.
- Diercks, Michael, Rodrigo Ranero & Mary Paster. 2015. Evidence for a clitic analysis of object markers in Kuria. In Ruth Kramer, Elizabeth Zsiga & One Boyer (eds.), *Selected Proceedings of the 44th Annual Conference in African Linguistics*, 52–70. Somerville, MA: Cascadilla Proceedings Project.

- Diercks, Michael, Justine Sikuku & Michael R. Marlo. 2018. Pragmatic effects of clitic doubling: Two kinds of object markers in Lubukusu. *Linguistic Variation* 18(2). 359–429. DOI:10.1075/lv.00027.sik
- Diesing, Molly. 1992. *Indefinites*. The MIT Press: Cambridge, MA.
- Grosz, Barbara & Yael Ziv. 1998. Centering, global focus, and right dislocation. In Aravind Joshi Marilyn Walker & Ellen Prince (eds.), *Centering in discourse*, 39–51. Oxford: Oxford University Press.
- Halpert, Claire & Jochen Zeller. 2015. Right dislocation and raising-to-object in Zulu. *The Linguistic Review* 32(3). 475–513.
- Henderson, Brent. 2006. *The syntax and typology of Bantu relative clauses*. The University of Illinois at Urbana-Champaign. (Doctoral dissertation).
- Hornstein, Norbert & Amy Weinberg. 1990. The necessity of LF. *The Linguistic Review* 7. 129–167.
- Horvath, Julia. 2007. Separating ‘focus movement’ from focus. In Vida Samiian Simin Karimi & Wendy Wilkins (eds.), *Phrasal and clausal architecture*, 108–145. Amsterdam: John Benjamins.
- Hyman, Larry & Francis Katamba. 1990. The augment in Luganda tonology. *Journal of African Languages and Linguistics* 12. 1–45.
- Hyman, Larry & Francis Katamba. 1993. The augment in Luganda: Syntax or pragmatics. In Sam Mchombo (ed.), *Theoretical aspects of Bantu grammar*, 209–256. Stanford: CSLI.
- Iatridou, Sabine. 1995. Clitics and island effects. In Roumyana Izvorski & Victoria Tredinnick (eds.), *University of Pennsylvania Working Papers in Linguistics*, vol. 2, 11–30. University of Pennsylvania.
- Kayne, Richard. 1994. *The antisymmetry of syntax*. Cambridge: MIT Press.
- Kayne, Richard. 1995. *Class lectures at Harvard*. (cited by Cecchetto 1999).
- Landman, Meredith & Rodrigo Ranero. 2018. Focus marking in kuria. In Jason Kandybowicz, Travis Major & Harold Torrence (eds.), *African linguistics on the prairie* (Contemporary African Linguistics), 393–412. Berlin: Language Science Press. DOI:10.5281/zenodo.1251754
- Marlo, Michael R. 2015. On the number of object markers in Bantu languages. *Journal of African Languages and Linguistics*. 36(1). 1–65.
- Nunes, Jairo. 2004. *Linearization and sideways movement*. The MIT Press: Cambridge, MA.
- Ranero, Rodrigo. 2015. *The syntax of dislocated objects in Luganda*. University of Cambridge. (MA thesis).
- Reinhart, Tanya. 1981. Pragmatics and linguistics: An analysis of sentence topics. *Philosophica* 27. 53–93.

- Riedel, Kristina. 2009. *The syntax of object marking in Sambia: A comparative Bantu perspective*. Leiden University. (Doctoral dissertation).
- Rizzi, Luigi. 1997. The fine structure of the left periphery. In Liliane Haegeman (ed.), *Elements of grammar: A handbook in generative syntax*, 281–337. Netherlands: Springer.
- Samek-Lodovici, Vieri. 2016. *The interaction of focus, givenness, and prosody*. Oxford studies in theoretical linguistics. Oxford: Oxford University Press.
- Suñer, Margarita. 2006. Left dislocation with and without epithets. *Probus* 18. 127–158.
- Vallduví, Enric. 1992. *The informational component*. New York: Garland Publishing.
- van der Spuy, Andrew. 1993. Dislocated noun phrases in Nguni. *Lingua* 90. 335–355.
- van der Wal, Jenneke & Saudah Namyalo. 2016. The interaction of two focus marking strategies in Luganda. In Doris Payne, Sara Pacchiarotti & Mokaya Bosire (eds.), *Diversity in African languages*, 355–377. Berlin: Language Science Press.
- Villalba, Xavier. 2000. *The syntax of sentence periphery*. Universitat Autònoma de Barcelona. (Doctoral dissertation).
- Zeller, Jochen. 2009. On clitic left dislocation in Zulu. In Sonja Ermisch (ed.), *Focus and topic in African languages* (Frankfurt African Studies Bulletin 18 (2006)), 131–156. Koeln: Ruediger Koeppe Verlag.
- Zeller, Jochen. 2015. Argument prominence and agreement: Explaining an unexpected object asymmetry in Zulu. *Lingua* 156. 17–39.
- Zubizarreta, María Luisa. 1998. *Prosody, focus, and word order*. The MIT Press: Cambridge, MA.



## Chapter 32

# A case based account of Bantu IAV-focus

Naga Selvanathan

Rutgers University

Right dislocation (Cheng & Downing 2012) and movement to a low FocP (van der Wal 2006) are competing analyses of Immediately-After-Verb (IAV) focus. In this paper, I discuss novel Lubukusu IAV focus data which shows that 1) IAV focus requires movement to a low FP and that 2) IAV focus is not a purely focus related phenomenon. Adopting Baker & Collins (2006) analysis of Linkers, I propose that movement to a low FP for focus interpretation is a strategy of case assignment to DPs within the VP. This analysis is shown to be superior to a purely right dislocation analysis as it can also better account for IAV focus asymmetries between Zulu and Lubukusu.

## 1 Introduction

Bantu Immediately-After-Verb (IAV) focus refers to the phenomenon in several Bantu languages in which a focused phrase has to be immediately post-verbal (Hyman 1979; Watters 1979). As the name suggests, the standard view on this positional requirement is that it is a focus-driven phenomenon.

In this paper, I have two objectives. The first is to show that Lubukusu IAV-focus does not require dislocation of the non-focused phrases in the VP. This is pertinent because Cheng & Downing (2012) argue that IAV-focus in Zulu involves dislocation of non-focused phrases and not movement of a focused element to a low FocP position, contra van der Wal (2006) for Makhuwa. These approaches are illustrated below.

In the non-dislocation strategy (eg. van der Wal 2006) in Figure 1(a), a focused XP itself moves to a position that is the closest phrasal position c-commanded by v. Figure 1(b) shows the dislocation strategy (Cheng & Downing 2009), wherein an intervening non-focused WP is moved out of the VP such that the focused XP



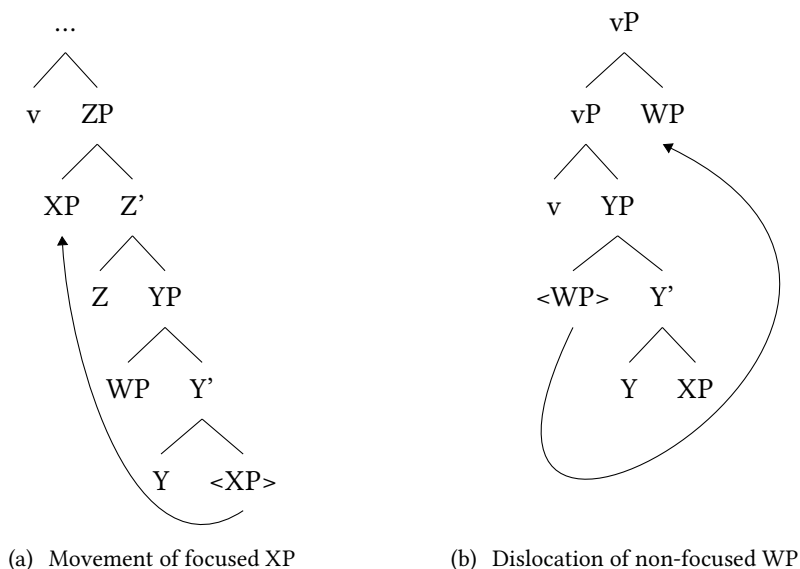

Figure 1: Movement vs. dislocation analysis of IAV focus

becomes the closest phrase c-commanded by v. I assume V to v movement in all of these cases. I argue that Lubukusu provides strong evidence that it utilizes a version of the strategy in Figure 1(a) and not Figure 1(b). In so far as Zulu does employ the dislocation strategy shown in Figure 1(b), this means that Bantu-IAV focus can be realized differently.

My second objective is to argue that IAV-focus in Lubukusu is not a purely focus related phenomenon but something that is partly motivated by case. I propose that Lubukusu has an F head (similar to a Foc head) which is not just sensitive to focus features but also to the case features of the phrase in its specifier. I argue that this F head is a focus sensitive version of the Linker head (Baker & Collins 2006). The main evidence for this claim comes from focused adjuncts in Lubukusu. I then review some evidence that indicates that focused nominals in Zulu also move to this Spec, FP. I then argue that the difference between Zulu and Lubukusu can be boiled down to whether dislocation of non-focused elements in the VP is optional or obligatory.

The outline of this paper is as follows. In §2, I will look at the two different strategies that have been proposed to account for IAV-focus in different Bantu languages, namely the dislocation and non-dislocation strategies. In Sections 3–5, I discuss and analyze IAV focus in Lubukusu where I show that Lubukusu does

not utilize a dislocation strategy and that IAV focus in Lubukusu is unlikely to be a purely focus phenomenon. I also provide a formal account for Lubukusu IAV focus. In §6, I revisit Zulu and show that there is data from focused locatives that indicate that Zulu too has this Spec, FP. I then conclude.

## 2 A (brief) history of IAV-focus

Hyman (1979) and Watters (1979) noticed that focused phrases must occur immediately after the verb in Aghem. Since then, many Bantu languages have been noticed to exhibit this phenomenon. This has been documented quite prominently in Zulu (Buell 2009; Cheng & Downing 2012) and Makhuwa (van der Wal 2006). There have been two types of analyses that have been proposed for IAV-focus; non-dislocation and dislocation strategies.

In the dislocation strategy, the IAV-focused element is argued to remain in situ with other elements in the VP being moved out of the VO. Cheng & Downing (2012) provide strong evidence for such an analysis (at least for Zulu). They argue that in Zulu IAV-focus, it is not the focused element that moves, but rather it is the non-focused elements within the VP that move. First note that in neutral contexts, the word order between the direct object (DO) and the indirect object (IO) is IO-DO in Zulu.<sup>1</sup> However, when the DO is focused, for example, as an answer to a question, the DO has to be immediately post-verbal.

(1) Zulu (Cheng & Downing 2012: 2)

- |    |  |       |
|----|--|-------|
| a. | bá-níké      ú-Síphó í-mà:li.              | IO-DO |
|    | 2SUBJ-give 1-Sipho 9-money                 |       |
|    | ‘They gave Sipho money.’                   |       |
| b. | Q: bá-m-níké:-ni      ú-Sî:phó?            |       |
|    | 2SUBJ-1OBJ-give-what 1-Sipho               |       |
|    | ‘What did they give to Sipho?’             |       |
|    | A1: bá-m-níké:      í-ma:li      ú-Si:pho. | DO-IO |
|    | 2SUBJ-1OBJ-give 9-money 1-Sipho            |       |
|    | ‘They gave money to Sipho.’                |       |
|    | A2: #bá-níké ú-Síphó í-mà:li               | IO-DO |

<sup>1</sup>I use the term ‘neutral context’ to refer to a context which is not associated with any obligatory discourse information, such as topic or focus. This is in line with what appears to be standard practice (Diercks & Sikuku 2013; Diercks et al. 2015).

Example (1a) shows the canonical IO-DO order in neutral contexts in Zulu. (1b) is a question-answer pair in Zulu where the DO is questioned and A1 and A2 show the two potential answers. Of these, only A1 with DO-IO order is judged fully acceptable. A2 with IO-DO order is judged infelicitous. This shows that Zulu does have what looks like IAV-focus.

The strongest evidence that Cheng & Downing (2012) provide for their claim that Zulu IAV focus follows the dislocation strategy in Figure 1(b) is the fact Zulu IAV requires an obligatory object marker (OM) on the verb corresponding to the non-focused arguments. This OM is commonly analyzed as a dislocation marker as van der Spuy (1993), Buell (2005; 2006), Halpert (2012) show that in Zulu, a left-dislocated phrase is obligatorily accompanied by an OM.

(2) Zulu

Q: *ízi-vakâ:shi u-zi-phekéla:-ni?*

8-visitor you-8OBJ-cook.for-what

‘What are you cooking for the visitors?’

A: *ízi-vakáshi ngi-zi-phekél’ í-nya:ma.*

8-visitor I-8OBJ-cook.for 9-meat

‘I am cooking visitors some meat.’

Example (2) shows that an indirect object *ízi-vakâ:shi* ‘visitor’ which usually occurs post-verbally, can be dislocated to the sentence-initial position. The dislocation of this object to a pre-verbal position must be accompanied by the appearance of the marker *zi* on the verb. This marker must have the same class marking as the fronted indirect object. Interestingly, in IAV-focus contexts, the verb must have an OM that is associated with the *non-focused* post-verbal phrase.

(3) Zulu (Cheng & Downing 2012: 4)

Q: *bá-m-níké:-ni ú-Sî:phó?*

2SUBJ-1OBJ-give-what 1-Sipho

‘What did they give to Sipho?’

A: *bá-m-níké: í-ma:li ú-Si:pho.*

DO-IO

2SUBJ-1OBJ-give 9-money 1-Sipho

‘They gave money to Sipho.’

Example (3) shows a question-answer pair where the direct object is focused. As can be seen in the answer, not only must the order between the post-verbal elements be DO-IO, the verb must also carry an OM that matches the class of the non-focused IO. We can compare this with (1a) where we can see that in neutral

contexts, there are no markers on the verb that matches the class of the post-verbal arguments. This OM also appears even if the focused phrase is a IO and the post-verbal elements are in an IO-DO order.

- (4) Zulu (Cheng & Downing 2012: 4)
- Q: Ú-si:pho ú-yí-phékéla ba:ni ín-ku:khu?  
 1-Sipho 1SUBJ-9OBJ-cook.for who 9-chicken  
 ‘Who is Sipho cooking the chicken for?’
- A: Ú-síph’ ú-yí-phékél’ ízí-vakâ:sh’ ín-ku:khu.  
 1-Sipho 1SUBJ-9OBJ-cook.for 8-visitor 9-chicken  
 ‘Sipho is cooking the chicken for the visitors.’

Example (4) shows a question that places focus on the IO. The corresponding answer to this question will thus have an IO-DO order as seen in the answer. Additionally, the verb must have an OM that corresponds to the non-focused DO. In summary, Zulu appears to have an OM that indicates dislocation of a post-verbal argument. In addition, such an OM appears in IAV-focus contexts, but one that matches the non-focused post-verbal argument. These facts are taken by Cheng & Downing (2012) to be an indicator that Zulu IAV-focus is realized by the strategy in Figure 1(b). Namely, the non-focused argument is dislocated out of the VP such that the focused argument appears to be in an IAV configuration.<sup>2</sup>

Alternatively, van der Wal (2006) proposes a non-dislocation account of IAV-focus in Makhuwa. In this approach, a focused phrase direct object acquires an IAV configuration in the following way.

In this analysis, the focused direct object is moved to the specifier of a FocP that is a complement of little *v*. In doing so, this focused phrase moves higher past the non-focused indirect object (I.OBJ). This results in an IAV configuration for the focused phrase as the verb is further assumed to move to little *v*. Such an account is appealing because such a projection has cross-linguistic support as it has been proposed by Belletti (2001; 2004) for Italian, Ndayiragije (1999) for Kirundi, and Jayaseelan (1999; 2001) for Malayalam among others.

In the two accounts we have seen, there is one core difference characterizing each approach. In the dislocation approach, the focused phrase remains in situ and it is the non-focused post-verbal elements that are dislocated out of the VP. In the non-dislocation approach, it is the focused phrase itself that moves.

---

<sup>2</sup>However, note that even if dislocation of non-focused elements is obligatory as Cheng & Downing note, it is still compatible with the view that the focused phrase still moves to a low Spec, FocP as a reviewer notes.

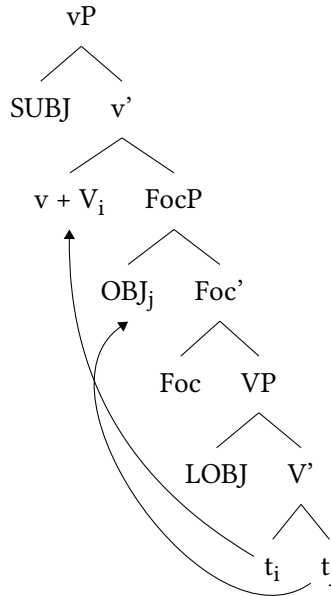

Figure 2: Non-dislocation approach to IAV-focus

### 3 IAV-focus in Lubukusu

In this section, I describe how the IAV-focus configuration is achieved in Lubukusu. In doing so, my objective is to show Lubukusu does not utilize the dislocation approach thus arguing for an approach in which the focused phrase is moved. First, I will show that Lubukusu too realizes IAV-focus. Consider the following base sentences.

(5) Lubukusu

- |    |                              |               |       |
|----|------------------------------|---------------|-------|
| a. | ba-saani ba-rum-ir-a         | Maria bi-tabu | IO-DO |
|    | c2-men c2.TNS-send-APPL-FV   | Mary c8-book  |       |
|    | ‘The men sent Mary books.’   |               |       |
| b. | ba-saani ba-rum-ir-a bi-tabu | Maria         | DO-IO |

(5) shows a ditransitive clause and my informant notes that either order between the direct object and indirect object is possible in neutral contexts.<sup>3</sup> In such contexts, the sentence is a simple declarative statement with neither the direct object nor the indirect object being focused. Thus (5a) and (5b) are both possible. In focus contexts, however, this is not the case.

## (6) Lubukusu

Q: Naanu ni-ye ba-saani ba-rum-ir-a bi-tabu?  
 who that-AGR c2-man c2-send-APPL-FV c8-book

‘Who did the men send the books to?’

A1: ba-saani ba-rum-ir-a Maria bi-tabu IO-DO  
 c2-men c2.TNS-send-APPL-FV Mary c8-book

‘The men sent Mary books.’

A2: #ba-saani ba-rum-ir-a bi-tabu Maria DO-IO

Example (6) shows a question-answer pair where the question places focus on the indirect object. In such contexts, A1, where the indirect object is IAV is fully acceptable whereas A2, where the direct object intervenes between the verb and the indirect object is infelicitous. This illustrates that Lubukusu does exhibit IAV-focus. When the post-verbal elements consist of one argument and one adjunct, we also see IAV-focus.

## (7) Lubukusu

Q: Naanu ni-ye ba-saani ba-a-pa lukali?  
 who that-AGR c2-man c2-TNS-beat fiercely

‘Who did the men beat fiercely?’

A1: Ba-saani ba-a-pa Yohana lukali DO-ADV  
 c2-man c2-TNS-beat John fiercely

‘The men beat John fiercely.’

A2: #Ba-saani ba-a-pa lukali Yohana ADV-DO

Example (7) shows a question-answer pair in which the direct object is focused. In such a configuration, the direct object must occur in an IAV configuration. Thus, A1 is possible but A2 is infelicitous. Note that in A2, the adverb intervenes

<sup>3</sup>As mentioned above, I assume that such contexts are not associated with any topic/focus information. Below, I discuss briefly the afterthought reading that dislocated elements in Lubukusu have (Diercks & Sikuku 2013).

between the verb and the focused direct object. This is in contrast to neutral contexts where either order between the direct object and the adjunct is possible. In addition, when the adverb is focused, it can occur immediately after the verb, i.e. intervening between the verb and the direct object.<sup>4</sup> In that context, A2 is fully acceptable. What this shows, again, is that Lubukusu exhibits IAV-focus.

Note that in all the cases of IAV focus, especially in (6), there is no evidence by way of verbal marking that there has been any dislocation of any post-verbal element at all. Of course, this could just mean that Lubukusu does not mark dislocated elements with an OM, but this is not true as Sikuku (2012) argues that Lubukusu does employ such marking.

(8) Lubukusu (Sikuku 2012: 8)

- a. Mayi a-siima ba-ba-ana  
1mother 1SM-like 2-2-children  
'The mother likes the children.'
- b. Babaana, mayi a-\*(ba)-siima  
2-2-children 1mother 1SM-\*(2OM)-like  
'The children, the mother likes them.'

Example (8a) shows a simple SVO clause with only a marker corresponding to the subject on the verb. This is similar to all the Lubukusu sentences above. While each sentence requires a subject marker, there is no OM corresponding to the direct or the indirect object. Example (8b) shows that when the DO is dislocated (in this case through fronting), an OM corresponding to the dislocated phrase is obligatory. Thus, this shows that dislocation of the direct object is accompanied with verbal marking. It appears that Lubukusu is just like Zulu in this regard. If it is true that Lubukusu is like Zulu in marking dislocated arguments with an OM, then one wonders why such an OM is not seen in A1, the felicitous answer for the question in (6). A dislocation analysis for Lubukusu IAV-focus seems unlikely.

One could argue that perhaps left-dislocation (like in (8)) is different from right-dislocation seen in IAV-focus. Perhaps, right-dislocation is realized without a dislocation marker. But this can be shown to be false as well. Recall from A1 in (6) that there is no OM corresponding to the non-focused indirect object. However, such a marker is possible.

---

<sup>4</sup>Later, we will see that Lubukusu differs from Zulu in an unexpected way. While Zulu adjuncts must also be IAV when focused, Lubukusu adjuncts need not. The case-based proposal for IAV-focus advanced here is argued to better account for this difference.



- (9) Lubukusu  
 ba-saani ba-bi-rum-ir-a                      Maria bi-tabu                      IO-DO  
 c2-men c2.TNS-c8-send-APPL-FV Mary c8-book  
 ‘The men sent Mary books.’

Example (9) shows that an OM is compatible with IAV focus in Lubukusu, such that the answer to the question ‘Who did the men send the books to?’ could look like (9). (9), thus, shows that the non-focused direct object can be dislocated, although crucially, dislocation is not necessary to realize IAV focus in Lubukusu.

Perhaps, the strongest evidence that indicates that Lubukusu IAV-focus does not require dislocation but can co-occur with it comes from instances where the focused phrase is an adjunct. A surprising fact about IAV-focus in Lubukusu (also discussed previously in Carstens & Diercks (2013), and Safir & Selvanathan (to appear)) is the fact that Lubukusu adjuncts, even when focused, do not need to be IAV.

- (10) Lubukusu  
 Q: Wekesa e-ra    embeba aryeena?  
       Wekesa SM-kill the rat    how  
       ‘How did Wekesa kill the rat?’  
 A1: Wekesa e-ra    kalaha embeba                      ADV-DO  
       Wekesa SM-kill slowly the rat  
 A2: Wekesa e-ra embeba kalaha                      DO-ADV

More will be said about this argument-adjunct asymmetry in Lubukusu with respect to IAV-focus later but for now note that when the focus is on the adjunct, it can occur either in an IAV position or after the non-focused DO. Thus, the question in (10) can be answered with A1 or A2. Either order between the direct object and the adjunct is possible. However, it is also possible to add an OM to A1 but in this case the order becomes fixed. Compare the following.

- (11) Lubukusu
- a. Wekesa a-ki-ra    kalaha embeba                      ADV-DO  
       Wekesa SM-OM-kill slowly the rat  
       ‘Wekesa killed the rat slowly.’
- b. \*Wekesa a-ki-ra    embeba kalaha                      \*DO-ADV  
       Wekesa SM-OM-kill the rat    slowly  
       ‘Wekesa killed the rat slowly.’

Example (11a) is a possible answer to the question in (10). Here, there is an OM corresponding to the DO. However, if there is such an OM, then the order between the adjunct and direct object must be the one shown in (11a), i.e. ADJ - DO. The DO-ADJ order as in (13b) becomes impossible.

What these facts show is that dislocation (as evidenced by an OM on the verb) is compatible with IAV-focus in Lubukusu as long as it is the non-focused phrase that is being dislocated. However, (6) shows that IAV-focus of an argument in Lubukusu can be attained even without dislocation. I conclude that Lubukusu IAV-focus can be achieved without using the dislocation strategy but compatible with it. I propose that the reason why dislocation is compatible with the movement strategy in Lubukusu is because dislocated elements in Lubukusu are associated with an after-thought reading (Diercks & Sikuku 2013). Thus, in a VP in which there is a focused element which is moved to a special position, the non-focused element (if it is an object) can be further backgrounded through dislocation. What the comparison of dislocation facts in Zulu and Lubukusu indicate is that a non-dislocation strategy is used by languages like Lubukusu to realize IAV-focus.

#### **4 IAV-focus is not a purely focus phenomenon**

Now that we have seen that the IAV-focus configuration is realized through movement of a focused phrase in Lubukusu, I will now argue that Lubukusu IAV-focus is partly motivated by case-considerations. First, I describe briefly how the two strategies to realizing the IAV-focus configuration have been hypothesized to feed focus interpretation in the literature.

In the non-dislocation strategy where the focused element moves to a focused projection (as in Figure 1(a)), this is quite obvious. Following in the footsteps of the cartographic approaches to clause peripheries (Rizzi 1997), interpretation of the moved element as focus is a direct result of it being in a position reserved for such an interpretation. On the other hand, in the dislocation strategy advanced by Cheng & Downing (2012) (as in Figure 1(b)), dislocation of the non-focused elements out of the VP is driven by prosodic requirements. In Cheng & Downing's (2012) Optimality Theoretic (OT, Prince & Smolensky 1993) analysis, a focused element occurs in an IAV position because of the twin requirements of prosodic prominence and structural prominence. In short, non-focused post-verbal elements are dislocated out of the VP because of the requirement to ensure that the prosodically prominent focused phrase is also structurally prominent, i.e. the highest element within the vP.

However, we have already seen some Lubukusu facts that suggest that IAV-focus cannot be purely a focus phenomenon. For one, if this was the case, then the fact seen in (10) where focused adjuncts in Lubukusu need not be in an IAV-position is surprising for both approaches. In the non-dislocation approach, if a focused phrase has to move to Spec, FocP, then why doesn't a focused adjunct need to? Such data is problematic for Cheng & Downing's account of the dislocation approach as well. If a focused element has to be structurally prominent, then why doesn't a focused adjunct have to be structurally prominent as well? One cannot put these aside by claiming that adjuncts are in general exempt from IAV-focus. For one, Zulu focused adjuncts are required to occur in the IAV position as seen below.

- (12) Zulu (Cheng & Downing 2014: 8)
- |                                      |                    |         |
|--------------------------------------|--------------------|---------|
| a. ú-Si:pho úphéké                   | í-só:bho kamná:ndi | DO-Adv  |
| 1-Sipho 1SUBJ-cooked                 | 5-soup deliciously |         |
| ‘Sipho cooked the soup deliciously.’ |                    |         |
| b. ú-lí-phéké                        | kánja:n’ í-só:bh’  | Adv-DO  |
| 1SUBJ-5OM-cooked                     | how 5-soup         |         |
| ‘How did s/he cook the soup?’        |                    |         |
| c. *ú-lí-phéké                       | í-só:bh’ kánja:n’  | *DO-Adv |

In the representative example above, (12a) shows that an adverbial adjunct occurs after the DO in a neutral context. However, when the adjunct is focused, as in (12b), it has to occur in an IAV position. Note that there is an obligatory OM on the verb indicating dislocation of the direct object. Thus, (12c) as an answer to (12b) is not acceptable. (12) shows that Zulu adjuncts when focused must be IAV as well. I take this to indicate that focused adjuncts can require the IAV configuration. This makes the fact that Lubukusu focused adjuncts need not be in an IAV-position all the more surprising. I conclude that this indicates that IAV-focus is not purely a focus based phenomenon, at least in Lubukusu.<sup>5</sup>

## 5 The analysis of Lubukusu IAV-focus

In this section, I propose an analysis of the Lubukusu facts. I claim that Lubukusu does have a head similar to a Focus head as a complement of *v* as proposed

<sup>5</sup>Later in the paper, I discuss focused locative adjuncts in Zulu which suggest that IAV-focus may not be a purely focus phenomenon in Zulu either.

by van der Wal (2006), but this head is a variation of a Linker head (Lk, Baker & Collins 2006). This head must be in the derivation when there is a focused phrase in the structure. However, this head does not require a focused phrase to be in its specifier, as AGREE (Chomsky 2000; 2001) is sufficient to delete the uninterpretable focus features on this F head. I propose that this head is hybrid in the sense that it checks focus features but is also sensitive to case assignment. In order to place my proposal in the correct setting, it is necessary to see my assumptions first. I do this by describing the structure of a ditransitive in the neutral context first.

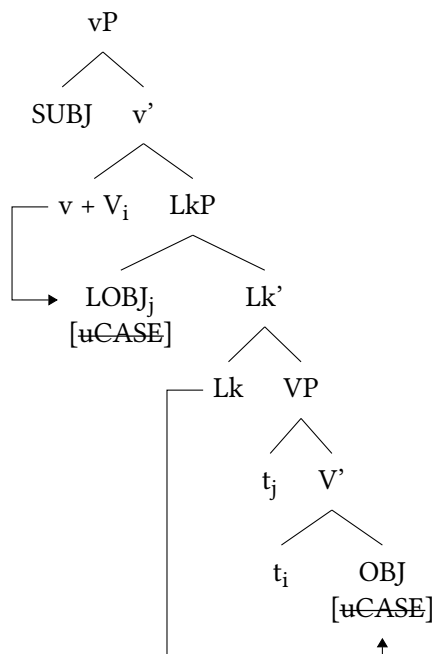

Figure 3: Ditransitive in neutral context

Figure 3 shows the proposed structure of a ditransitive in canonical IO-DO order. I assume, following Baker & Collins's (2006) account of Kinande and other Bantu languages, a linker phrase (LkP) that facilitates case assignment to the two internal arguments. This assumption is supported by the fact that Lubukusu is an object symmetry language Diercks & Sikuku (2013) just like Kinande for which Baker & Collins (2006) propose a LkP. I also largely adopt their assumptions about case assignment which is along the lines of feature checking (Chomsky 1995; 2000, etc.). DPs have uninterpretable case features that can be checked off

by heads such as *v*, preposition heads and *Lk* (unlike *V*). An uninterpretable feature that is to be deleted is at the end of the arrow head as seen in Figure 3 (I do not show the corresponding interpretable features to reduce clutter in the diagram). Thus in Figure 3, little *v* deletes the case feature of the indirect object whereas *Lk* deletes the case feature of the direct object. I also assume following Baker & Collins (2006) that *Lk* provides a specifier position to a DP such that *v* can access it for the purposes of deleting a DP's uninterpretable case feature, in this case, the indirect object's.

A simple way to understand the *F* head I propose for focused structures is to think of it as a head like *Lk* but one which is also responsible for facilitating the focus reading. Thus, like the *Lk* head, it can delete the uninterpretable case features of a DP and provide a specifier position to which a DP can move to in order for *v* to delete this DP's uninterpretable case features. But this *F* head also has uninterpretable focus features that has to be deleted. The best way to understand what this *F* head does is to see some derivations, so we will now see how Lubukusu IAV-focus is derived, starting with a focused direct object in ditransitive constructions. Recall that in Lubukusu, the focused direct object must be in an IAV position.

Consider the following.

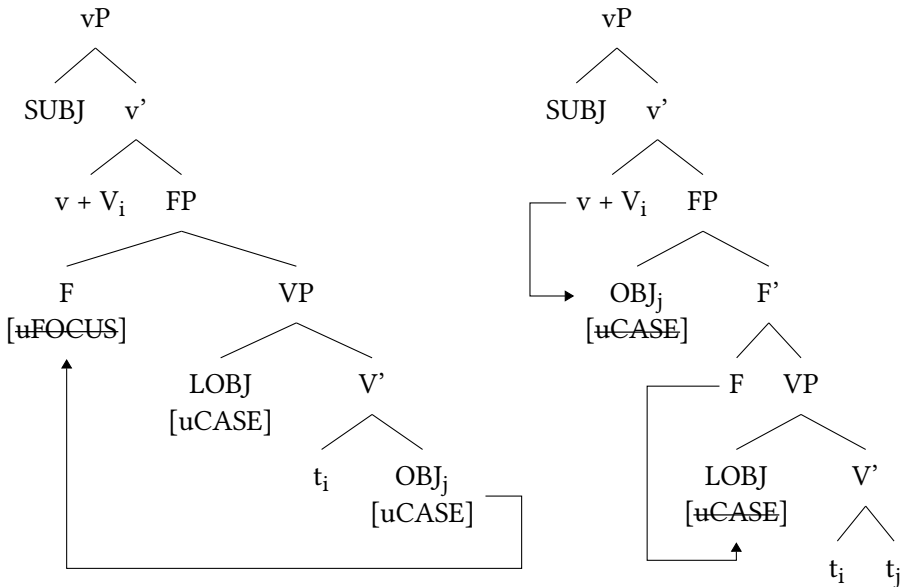

Figure 4: Ditransitive with focused direct object: Step 1 & Step 2

Figure 4 shows the two steps of uninterpretable feature deletion involved. In step 1, instead of a LkP, the FP is generated. The F head has uninterpretable focus features which is deleted by AGREE between the F head and the focused direct object. However, there are still two DPs that have uninterpretable case features which have to be deleted and this can be seen in step 2. Here, the DP that the F head deletes its uninterpretable focus features with moves to Spec, FP. For now, I will assume that the F head has an EPP feature that must be checked by the DP that F has agreed with.<sup>6</sup> This allows v to assign case to the focused object by deleting the object's uninterpretable case features. F, itself, deletes the uninterpretable case features of the lower indirect object.

We can also see how this analysis accounts for transitive clauses which have an adjunct. First, recall that an adjunct in Lubukusu can occur in either order with a direct object in neutral contexts.

(13) Lubukusu

- |    |                |                                 |        |
|----|----------------|---------------------------------|--------|
| a. | Wekesa e-ra    | kalaha embeba                   | ADJ-DO |
|    | Wekesa SM-kill | slowly the rat                  |        |
|    |                | ‘Wekesa killed the rat slowly.’ |        |
| b. | Wekesa e-ra    | embeba kalaha                   | DO-ADJ |
|    | Wekesa SM-kill | the rat slowly                  |        |

Examples (13a) and (13b) show the two possible orders which I account for by assuming that the Lubukusu adjunct can either be right or left-adjoined to the VP. In addition, I assume that there is no Linker Phrase in transitives. This follows Baker & Collins (2006) who also argue that Kinande transitives do not have a LkP. Thus, Figure 5 has the following structures.

In Figure 5 the case feature of the objects is deleted by v. The adjunct in Lubukusu (whether left-adjoined or right-adjoined) does not intervene in case feature checking because it does not have any interpretable case features which v can check since *kalaha* ‘slowly’ is not nominal.<sup>7</sup> Given this basic picture, we can now discuss the structures in which the direct object is focused and the ones in which the adjunct is focused. We start with the case where the direct object is focused. In this sentence, recall that the object must be IAV. I will use the instance where the adjunct is left-adjoined although the main point holds even if the adjunct is right-adjoined.

<sup>6</sup>Below I discuss why it has to be the focused DP that moves to Spec, FP.

<sup>7</sup>In cases where the adjunct is arguably nominal, such as *yesterday*, *today* etc, it could be that such adjuncts have a null P that assigns case.

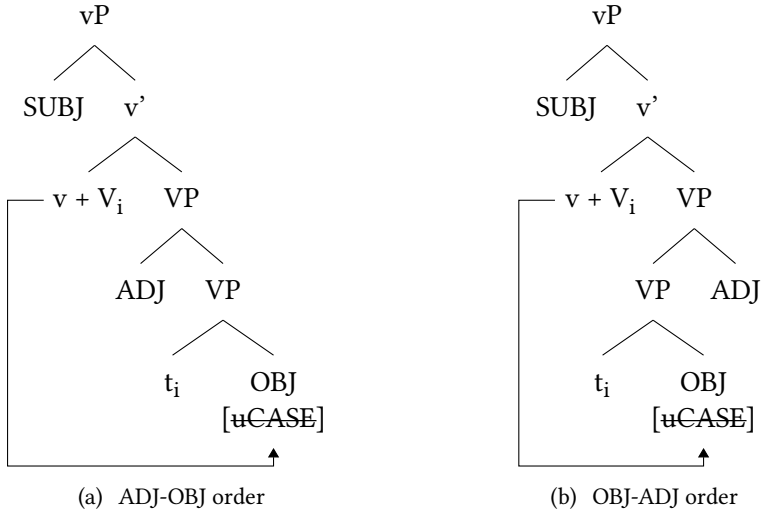

Figure 5: Transitives in a neutral context with an adjunct

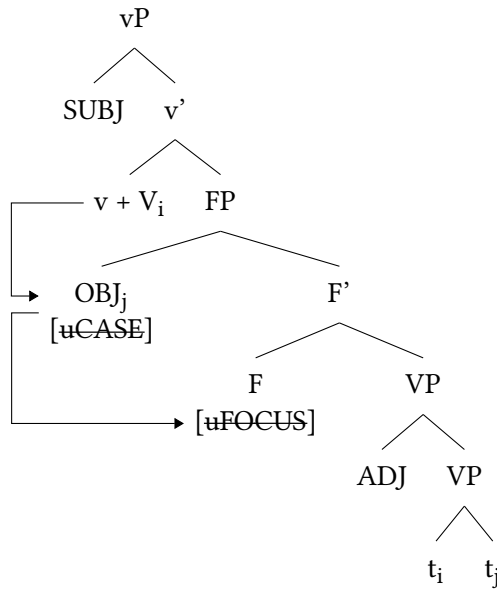

Figure 6: Transitive with a focused direct object

Figure 6 shows a structure in which the direct object is focused. Since there is a focused phrase, FP is projected and the uninterpretable focus features on F are deleted through AGREE with the focused direct object. Since the object is in an AGREE relation with F and it needs case, it moves to Spec, FP to check the EPP feature of the F head. This allows *v* to be in the right configuration to delete the uninterpretable case features of the raised focused object. This also gives the right order for a focused object and an adjunct.<sup>8</sup> Now let's move on to see what happens when it is the adjunct in a transitive that is focused.

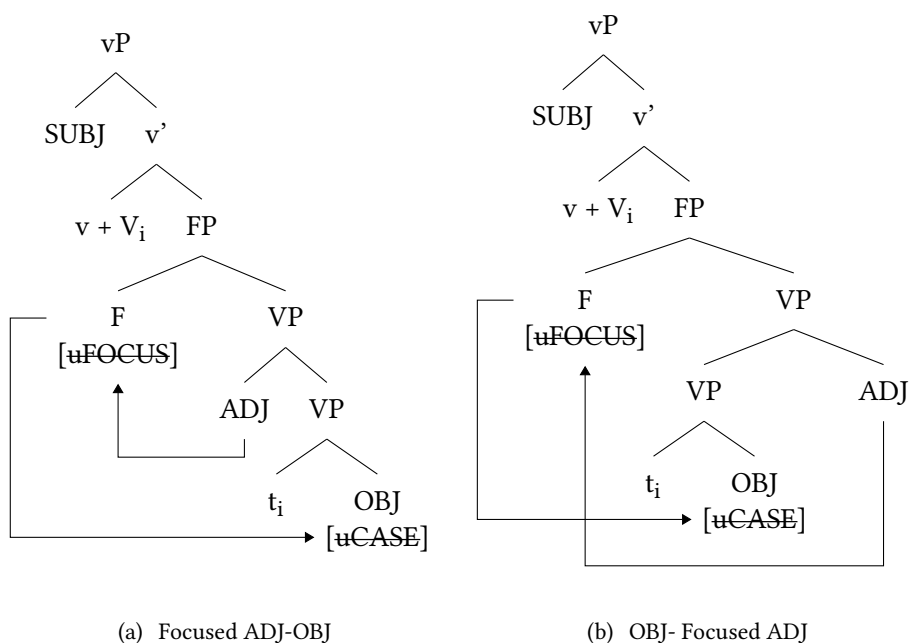

Figure 7: Transitives with a focused adjunct

Figure 7 shows the two different orders that are possible when the adjunct is focused. Since there is a focused phrase in these constructions, there is an FP. The uninterpretable focus features on F are deleted through AGREE with the focused adjunct. The case features of the object are deleted by the F head since it is the closest head to the direct object that can do so. Crucially, there is no movement

<sup>8</sup>F has interpretable case features too but it does not have any DP to check. This does not matter because I assume that interpretable case features that do not take part in a checking relation do not induce a crash at LF, unlike uninterpretable features.



of the adjunct to Spec, FP because the adjunct does not require case and as such need not be in a configuration in which *v* can assign case to it.

Figure 7 reveals two peculiarities of what I have proposed to be an EPP feature of the F head. The first is that the phrase that checks the EPP feature must be focused. In my analysis, this translates to a previously established AGREE relationship between the F head and the focused phrase. The second is that the phrase must be an element that requires case. These two properties mean that only focused DPs move to Spec, FP. Focused adjuncts do not. The implication of this is that the EPP feature of F cannot be formalized as an uninterpretable feature. If this were the case, then derivations like Figure 7 where the focused adjunct does not move to Spec, FP should lead to a crash. Instead, I recharacterize the EPP feature as the following.

(14) Recharacterizing the EPP feature of F<sup>9</sup>

The F head triggers movement of some XP to its specifier iff

1. An independently established AGREE relation holds between F and XP, and,
2. Doing so facilitates case assignment to XP by *v*.

In the Lubukusu IAV facts, a focused DP satisfies both (i) and (ii) and thus has to move to Spec, FP. A non-focused DP cannot move to Spec, FP because it satisfies (ii) but not (i). A focused adjunct cannot move to Spec, FP either as it satisfies (i) but not (ii).

The above shows how IAV-focus is realized in Lubukusu, including an account for why focused adjuncts need not occur in an IAV-configuration. The account provided here fares better than existing accounts. In a non-dislocation approach such as van der Wal (2006), a focused phrase must move to Spec, FocP which is clearly not the case with Lubukusu focused adjuncts. A dislocation approach such as Cheng & Downing (2012) faces the same problem. In my proposal, the F head is not only sensitive to focus features, but also sensitive to the case features of the phrase in question.

## 6 Reconsidering Zulu IAV-focus

While my objective here is not to propose a detailed reanalysis of Zulu IAV-focus, I will review some data which indicates that Zulu IAV-focus is not purely a focus

---

<sup>9</sup>My thanks to an anonymous reviewer who suggested an alternative analysis along these general lines.

phenomenon either. In fact, there is evidence that indicates that something like the FP is present in Zulu as well. Some very suggestive evidence that indicates that Zulu IAV-focus is not just a focus phenomenon comes from locatives in Zulu which do not need to be IAV.

(15) Zulu (Buell 2009: 168)

- a. U-leth-e        izimpahla zami [PP ku-liphi    ikamelo]?  
2s-bring-PERF 10.stuff    10.my        to-5.which 5.room
- b. U-leth-e        [PP ku-liphi    ikamelo] izimpahla zami?  
2s-bring-PERF    to-5.which 5.room    10.stuff    10.my  
‘To which room did you take my stuff to?’

Example (15) shows a construction which has a focused locative argument. Notably, (15) shows that the locative argument need not be IAV as seen in the fact that the direct object can intervene between the verb and the PP, specifically in (15a). If a prosodically prominent phrase has to be structurally prominent as Cheng & Downing claim, then why isn't the prosodically prominent locative argument in (15a) required to be structurally prominent as well?

In fact, the FP analysis I propose can capture this fact. Under my analysis, the reason why the locative need not be IAV is because it does not have case features. There is suggestive evidence that indicates that this is correct. For one, note that the locatives in (15) have a preposition-like element *ku*. Interestingly, when such a locative occurs as a subject, there is no such preposition head. Consider the following alternation.

(16) Zulu (Buell 2007: 107)

- a. Abantu abadala ba-hlala [ku-lezi    zindlu]  
2people 2old    2-stay    at-10these 10houses  
‘Old people live in these houses.’
- b. [Lezi    zindlu] zi-hlala abantu abadala.  
10these 10houses 10-live 2people 2old  
‘Old people live in these houses.’

Example (16a) shows a clause with a locative in a post-verbal position. (16b) shows an inverted clause where the locative occurs in the subject position (as

seen in subject agreement). Notably, the locative does not have a P head anymore.<sup>10</sup> (16) suggests that *ku* is a P head. If true, then this P head would check the case features of the nominal in the locative but the PP itself would not have case features like PPs in general. In my analysis, this means that the locative does not need to be IAV.

If the locative facts in Zulu are showing that only phrases with case features need to move to Spec, FP and this is what IAV-focus is even in Zulu, then we also need to answer why focused adjuncts in Zulu, unlike their Lubukusu counterparts, must be IAV (see (12). If my FP analysis is correct, this must mean that Zulu adjuncts have case features. At first, it seems unusual to analyze adjuncts as having case features, but as it turns out, Halpert (2012) and Cheng & Downing (2014) actually argue that Zulu adjuncts are nominal. Part of the evidence they provide for this claim is that Zulu adjuncts are compositionally made up of pronouns and nouns.

(17) Zulu

- a. ngo-kushesha  
NGA.AUG-15speed  
'quickly'
- b. ngo-buhlungu  
NGA.AUG-14pain  
'painfully'

If these authors are right, it is not a stretch to say that these have case features as well.

I will make a final point with respect to Zulu IAV-focus. While I have discussed some ways in which my FP analysis could account for Zulu-IAV focus, this still leaves the question of why dislocation is necessary in Zulu in IAV-focus constructions. To answer this, recall that while Lubukusu does not require dislocation, it can exhibit dislocation in IAV-focus contexts.

---

<sup>10</sup>It is possible to realize the P head even in a fronted PP as in the following, but the fronted locative would then be better analyzed as a fronted topic, as Buell (2007) does. a) Zulu (Buell 2007: 108) [*Ku-lezi zindlu*] *ku-hlala abantu abadala*. At-10these 10houses 17-live 2people 2old "Old people live in these houses." (a) has a fronted locative but has the *ku* affix. However, I will follow Buell's (2007) claim that the agreement we see in (a) is not subject agreement but a default marker that shows up even in subject-expletive contexts.

(18) Lubukusu

Q: Wekesa e-ra embeba aryeena?

Wekesa SM-kill the rat how

‘How did Wekesa kill the rat?’

A1: Wekesa e-(ki)-ra kalaha embeba

ADJ-DO

Wekesa SM-OM-kill slowly the rat

Thus, the answer to the question in (18) can be optionally dislocated. I take this to mean that dislocation in Lubukusu as seen in A2 is actually orthogonal to the issue of IAV-focus in Lubukusu. I propose that the difference between Lubukusu and Zulu is the following.<sup>11</sup>

Table 1: Difference between Lubukusu & Zulu

	Lubukusu	Zulu
Focused nominal	Must move to prominent position	Must move to prominent position
Non-focused elements	Optionally move out of VP	Must move out of VP

Table 1 shows that in both Lubukusu and Zulu, only focused phrases that require case (i.e. nominal) move to Spec, FP. The difference between the two pertains to how they treat non-focused elements within the VP. While Lubukusu tolerates such elements within the VP, Zulu does not.

## 7 Conclusion

In this paper, I have argued that Lubukusu provides good evidence that IAV focus does not require dislocation in order to be realized. Based on the fact that Lubukusu focused adjuncts do not require to be in an IAV-position, I argued that IAV-focus is not purely a focus phenomenon. Instead I claim that the case features of the focused phrase also determine whether the IAV-position is required. Finally, I argued that the same analysis can be extended to Zulu IAV-focus.

<sup>11</sup>Thanks to an anonymous reviewer for suggesting that the difference between Zulu and Lubukusu is better characterized as shown.

## Acknowledgements

I would like to thank Ken Safir, Mark Baker, Paul Roger Bassong, two anonymous reviewers and the audience at ACAL 46 for discussion and comments at earlier stages of this work. I would like to especially thank Justine Sikuku for all of the Lubukusu data here. Much of the initial groundwork for this paper was carried out during the time I was a research assistant for the Afranaph Project (<http://www.africananaphora.rutgers.edu>) which was/is supported by NSF BCS 0303447, NSF BCS 0523102, NSF BCS 0919086 and NSF BCS 1324404. All errors are solely mine.

## Abbreviations

AGR	Agreement	OM	Object marker
APPL	Applicative marker	PERF	Perfective
AUG	Augment	SM	Subject marker
c1, c2 etc	Class marker	SUBJ	Subject marker
FV	Final vowel	S	Subject marker
OBJ	Object marker	TNS	Tense

## References

- Baker, Mark & Chris Collins. 2006. Linkers and vP structure. *Natural Language and Linguistic Theory* 24. 307–354.
- Belletti, Andrea. 2001. Agreement projections. In Michael Baltin & Chris Collins (eds.), *The handbook of contemporary syntactic theory*, 489–510. Oxford: Blackwell.
- Belletti, Andrea. 2004. Aspect of the low IP area in the structure of CP and IP. In Luigi Rizzi (ed.), *The cartography of syntactic structures*, 16–51. Oxford: Oxford University Press.
- Buell, Leston. 2005. *Issues in Zulu verbal morphosyntax*. University of California Los Angeles. (Doctoral dissertation).
- Buell, Leston. 2006. The Zulu conjoint/disjoint verb alternation: Focus or constituency? *ZAS Papers in Linguistics* 43. 9–30.
- Buell, Leston. 2007. Semantic and formal locatives: Implications for the Bantu locative inversion typology. *SOAS Working Papers in Linguistics* 15. 105–120.
- Buell, Leston. 2009. *Evaluating the immediate postverbal position as a focus position in Zulu*. *Selected proceedings of ACAL* 38. Somerville, MA: Cascadilla Press.

- Carstens, Vicki & Michael Diercks. 2013. *Agreeing how? Implications for theories of agreement and locality*. 179–237.
- Cheng, Lisa & Laura J. Downing. 2009. Where's the topic in Zulu? *The Linguistic Review* 26(2–3). 207–238.
- Cheng, Lisa & Laura J. Downing. 2012. Against FocusP: Arguments from Zulu. In Ivona Kucerova & Ad Neeleman (eds.), *Information structure*, 247–266. Cambridge: Cambridge University Press.
- Cheng, Lisa & Laura J. Downing. 2014. The problem of adverbs. In Johanneke Caspers, Yiya Chen, Willemijn Heeren, Jos Pacilly, Niels O. Schiller & Ellen van Zanten (eds.), *Above and beyond the segments. Experimental linguistics and phonetics*, 42–59. Amsterdam: John Benjamins.
- Chomsky, Noam. 1995. *The minimalist program*. Cambridge: MIT Press.
- Chomsky, Noam. 2000. Minimalist inquiries: The framework. In Roger Martin, David Michaels, Juan Uriagereka & Samuel Jay Keyser (eds.), *Step by step: essays on minimalist syntax in honor of Howard Lasnik*.
- Chomsky, Noam. 2001. Derivation by phase. In Michael Kenstowicz (ed.), *Ken Hale: A life in language*, 1–52. Cambridge, MA: MIT Press.
- Diercks, Michael, Rodrigo Ranero & Mary Paster. 2015. Evidence for a clitic analysis of object markers in Kuria. In Ruth Kramer, Elizabeth Zsiga & One Boyer (eds.), *Selected Proceedings of the 44th Annual Conference in African Linguistics*, 52–70. Somerville, MA: Cascadilla Proceedings Project.
- Diercks, Michael & Justine Sikuku. 2013. *Deriving pronominal incorporation in Lubukusu*. Unpublished manuscript.
- Halpert, Claire. 2012. *Argument licensing and agreement in Zulu*. MIT. (Doctoral dissertation).
- Hyman, Larry M. 1979. Phonology and noun structure. In Larry Hyman (ed.), *Aghem grammatical structure* (SCOPII 7), 1–72. Los Angeles: University of Southern California.
- Jayaseelan, Karattuparambil A. 1999. A Focus Phrase above vP. In *Proceedings of the 2nd Asian GLOW colloquium*, 195–212. Japan: Nanzan University.
- Jayaseelan, Karattuparambil A. 2001. IP-internal topic and focus phrases. *Studia Linguistica* 55(1).
- Ndayiragije, Juvénal. 1999. Checking economy. *Linguistic Inquiry* 30. 399–444.
- Prince, Alan & Paul Smolensky. 1993. *Optimality Theory: Constraint interaction in generative grammar*: Rutgers University Center for Cognitive Science. Technical Report 2.

- Rizzi, Luigi. 1997. The fine structure of the left periphery. In Liliane Haegeman (ed.), *Elements of grammar: A handbook in generative syntax*, 281–337. Netherlands: Springer.
- Safir, Ken & Naga Selvanathan. to appear. Niger-congo transitive reciprocal constructions and polysmeny with reflexives. In Sara Pachiarotti Payne Doris L. & Mokaya Bosire (eds.), *Diversity in African Languages: Selected Papers from the 46th Annual Conference on African Linguistics. (Contemporary African Linguistics 2.)* Berlin: Language Science Press.
- Sikuku, Justine. 2012. Comparing reflexive and object marking in Lubukusu. In *Proceedings of WOCAL 7*.
- van der Spuy, Andrew. 1993. Dislocated noun phrases in Nguni. *Lingua* 90. 335–355.
- van der Wal, Jenneke. 2006. The disjoint verb form and an empty immediate after verb position in Makhuwa. *ZAS Papers in Linguistics* 43. 233–256.
- Watters, John R. 1979. Focus in Aghem: A study of its formal correlates and typology. In Larry Hyman (ed.), *Aghem grammatical structure (SCOPII 7)*, 137–197. Los Angeles: University of Southern California.





## **Part III**

# **Areal features and linguistic reconstruction**



## Chapter 33

# When Northern Swahili met southern Somali

Derek Nurse

Some twelve hundred years an incipient Northern Swahili community had moved up the Kenya coast as far as the Lamu Archipelago, where it came in contact with one or more Somali communities and the isolate Dahalo community. This paper initially uses phonological innovations in the early Swahili dialect to establish the general fact of contact, and then attempts to use sets of loanwords to identify the Somali source. Due to inadequate sources, it has proved difficult to identify the source(s) with certainty but initial contact with Tunni over some centuries, followed by later contact with Garre, is the most plausible explanation. The Tunni and Garre later exited, the latter leaving strong traces behind in Boni.

### 1 Purpose

The target here is a micro-area in NE Kenya and SE Somalia.<sup>1</sup> It was once home to where northern Swahili (including Mwiini<sup>2</sup>, the language of Brava) and some of its relatives are assumed to have emerged and developed, starting some 1200 BP, amidst a background of southern Somali communities. This has been suggested before (Nurse 1983; 1985) but not examined in such detail. The main differences here are the a) inclusion of Mwiini, b) inclusion of southern Somali (see the list in §2, below) other than Aweera = Boni, and c) stratigraphy of the Northern Swahili Dialects (ND). The analysis involves the use of phonological innovations and lexical borrowing, and includes some non-linguistic information.

---

<sup>1</sup>The label “southern Somali” is used in the title solely as a convenient geographical term. By contrast with Northern Swahili, southern Somali is not a recognized linguistic grouping.

<sup>2</sup>Mwiini is here considered a Northern Swahili dialect, although others regard it as a separate language.



## 2 Players, in order of chronological entry on stage

### 2.1 Dahalo

Dahalo is a Cushitic language with a Khoesan component (lexis, clicks) (see Figure 1 for a map). Khoesan split from Sandawe at least 20,000 years ago (S. Tishkoff *pc*).<sup>3</sup> Khoesan communities are assumed to have been spread across East Africa from Ethiopia south for many millennia. We do not know when or where Khoesan and Cushitic came together to form Dahalo, nor how long the Dahalo have been in situ, although minor hints suggest several millennia (Nurse 1986). Today a few hundred (?) aging Dahalo speakers remain.

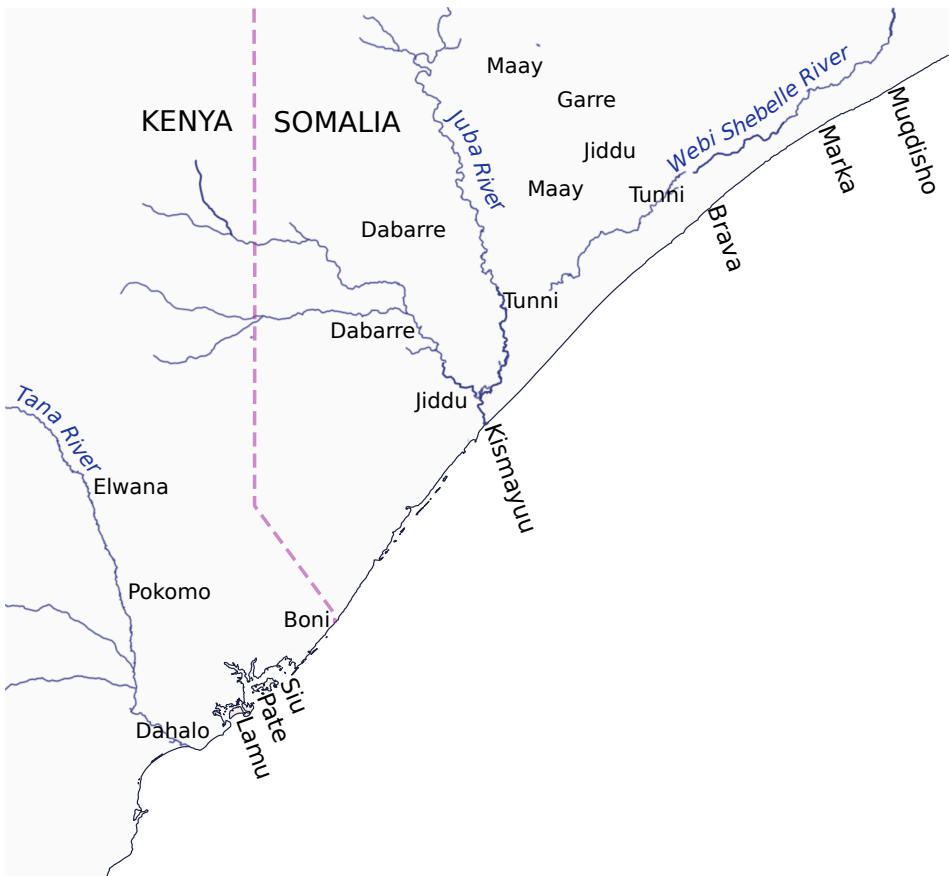

Figure 1: Linguistic communities in the Kenya-Somalia border area

<sup>3</sup>Dates are approximate. Populations from Ethnologue (Lewis et al. 2015).

## 2.2 Somali

Early Eastern Omo-Tana communities started to move SE into Somalia ca. 3000 BP and were in situ in southern Somalia by 2000 BP (Ehret 1995). Many local movements ensued over the next two millennia. Six Somali dialect communities near the target area now can be assumed to have been so also in the past, and are the likely candidates as sources for the material in the ND. They are the:<sup>4</sup>

1. Maay, interriverine<sup>5</sup>, from just south of Muqdisho almost to Kismayu, with over 500,000 speakers
2. Tunni, coastal, from near Merka to north of Kismayuu. 20,000 to 60,000 speakers. Earlier, possibly also further south.
3. Dabarre, interriverine. 20,000 to 50,000 speakers. Tunni and Dabarre are similar. Dabarre is little known.
4. Jiddu, interriverine and coast south of Brava. 20,000 to 60,000 speakers. Not enough is known.
5. Garre/Karre<sup>6</sup>, interriverine and widely scattered, with over 50,000 speakers.
6. Boni, also called Aweera. They live in a small area 60km long, mostly in NE Kenya with a few in SE Somalia, in villages in a forest bordering the coast. 3,000 speakers. Karre and Boni are similar. Along with Tosco (1994) I assume that Boni is a Dahaloised variety of Karre that arose when the Karre moved down to the coast into contact with Dahalo.

Other than the Boni and the more recent Orma and northern Somali, no Somali Cushitic group is south of Kismayuu today, so some group or groups once in situ here, have migrated north (see §6). Ali (1985) suggests that the Garre did not withdraw north but were rather absorbed into the Orma moving south.

---

<sup>4</sup>The distribution of these southern Somali communities is based on maps drawn by Lamberti in the 1980s (Lamberti 1983), before civil war erupted in 1991. They may have changed in the meantime. The outbreak of war had other effects. Up to 1991 the language situation in Somali was fairly stable but when the central government collapsed, coastal Swahili communities were attacked, genocide followed, and the communities collapsed. Dialect ability in the ND communities in northern Kenya has been reduced by a combination of economic and educational factors.

<sup>5</sup>“Interriverine” refers to the area along and between the rivers Juba and Shebelle, the only well watered part of the region and thus long a magnet for farmers and pastoralists.

<sup>6</sup>I follow Tosco and use Karre for the language, Garre for the/a clan. Also spelled “Karee”.

## 2.3 Bantu

Early Bantu moved into East Africa in the closing centuries BC, and one group, labeled the North East Coast Bantu, had reached an area in NE Tanzania, bounded by Mombasa and the Usambara, Taita, and the Pare Mountains, by the early centuries AD. All relevant Bantu languages here form part of the Sabaki group, a subset of NECB<sup>7</sup>. The early ancestral Swahili northern dialect (ND) community moved up along the immediate hinterland of the Kenya coast from NE Tanzania and was most likely living in villages in northern Kenya, in the Lamu Archipelago and adjacent mainland coast, slightly before 800 AD. Two other early Sabaki communities, ancestral to Pokomo and Mijikenda, had by this time also spread into the interriverine area in southern Somalia. The early Elwana community was probably along the Tana River in NE Kenya (Nurse & Hinnebusch 1993: 485ff, 499ff). The three earliest settlements on the Kenya coast are on Pate and Lamu Islands, at or slightly before 800 AD, with nearby sites on the mainland being slightly later (Wilson 2016). The ND and related Sabaki communities are the:

1. Mwiini (ND), up to 1991 exclusively in and around Brava, 10,000 to 15,000 speakers, now scattered, worldwide, few still in Brava, new speakers said to be emerging as outsiders move in (Vianello, p.c).
2. Bajuni (ND), SE Somali and NE Kenya coast and islands. Few speakers are left in Somalia. Ca. 20,000 Bajunis in NE Kenya, but how many are good speakers?
3. Siu (ND), in and around Siu Town, northern Pate Island. 6,000.
4. Pate (ND), in and around Pate Town, Pate Island. 3,000.
5. Amu (ND), in and around Lamu Town, Lamu Island. 15,000. Also other lects on Lamu Island.
6. Malindi (ND), in and around Malindi Town, between Lamu and Mombasa. Size of population speaking the dialect unknown.
7. Mombasa (ND), Mombasa city. It is likely that >25,000 speak the main dialect, Mvita. Also other smaller lects in and around around Mombasa, mostly dead or dying. Malindi and Mombasa are largely ignored in what follows.

---

<sup>7</sup>The Northeast Coast Bantu, a linguistic grouping involving over 20 communities along the coast of southern Somalia, Kenya, and northeastern Tanzania. See, inter alia, Nurse & Hinnebusch 1993: 4-19.

8. Elwana. Along Tana River, Bura to Garissa. >8,000.
9. Pokomo. Along Tana River, from coast to Bura. >65,000.
10. Mijikenda. Just inland of coast north of Mombasa. >630,000.

## 2.4 Communities excluded from this study

Since the focus here is from 800 to 1400 AD, besides the communities above four others known to have been in the area over the last two millennia played little or no role: (1) an unidentified Bantu community in the interriverine area in the early centuries AD, (2) the Mushunguli, along the Juba, descendants of escaped slaves from Tanzania, who settled there in the nineteenth century, (3) Orma, and (4) Northern Somali, who both arrived from the north over the last 500 years, too late to influence the events being discussed, although both are now present in the area.

## 3 Aim and assumptions

The purpose of this paper is twofold, to: see if this archaeology-based scenario can be linked to linguistic – specifically phonological – innovations within the ND, and to try link any such developments to a specific southern Somali community.

Northern Swahili refers to the communities speaking Swahili dialects from Brava down to the Mombasa area and just south. The archaeological sites in the whole area, assumed to be Swahili, were located in the Lamu Archipelago and/or adjacent mainland, slightly before 800 AD. I assume these to be those of the Proto-ND community. The northern communities at Mombasa and maybe Malindi and Mambui must have been the first to move out of the area, as Mombasa shows signs of Swahili settlement already by the late 11<sup>th</sup> century. They were followed closely by the ancestors of the Bravanese, and maybe of people formerly beyond Brava at Munghia, Merka, Gezira, and Mkudisho<sup>8</sup>, who had all moved north by ca 1100 AD. Archaeological sites in the traditional area occupied by Bajuni are later, starting in the 14<sup>th</sup> or 15<sup>th</sup> century (Wilson 1992: 91), along the 250km line from Dondo and adjacent settlements on the Kenya coast, north as far as Kismayu. That these dates are later maybe because archaeological data is incomplete or because the ancestors of the Bajunis spread along the coast later

---

<sup>8</sup>The name Shaangani, a Mkudisho quarter, and some pottery sherds there, suggest Swahili connections.

than the other communities. So far, this chronology is based largely on archaeology. The area in which the proto-ND communities lived was shared with one (or more?) southern Somali-speaking communities. Other than the tiny and low-status Boni community, no southern Somali communities live in that area today.

#### 4 Phonological innovations: ND dialects including Malindi and Mombasa

Southern Swahili dialects, from the Kenya/Tanzania border south, are conservative phonologically – that is, they are close to their Sabaki and North East Coast Bantu forebears – while all the northern dialects have innovated, so it is easier to arrange the latter stratigraphically as branches on a genealogical tree. Several dozen innovations<sup>9</sup> are scattered across the ND spectrum, but most are local and recent, and/or cannot be clearly linked to Somali influence. Those in Table 1 are significant because they occur in all ND and have diagnostic value because they do suggest a Somali source.

These are arranged in approximate chronological order. Numbers 1, 2, 4, 5, 6, 7 involve some form of dentalization. Among coronals, worldwide (Maddieson 1984), in Africa, and in East African Bantu, alveolars are more common than dentals. All the Somali dialects in the area (also Orma) have a dental series as their only or predominant coronal set. Few have phonemic voiced fricatives, although most have [ð] as an allophone of a /d/. Thus it seems that by entering a Somali “dental” area, early ND made an adaptive articulatory choice. Elwana, Pokomo, and Mijikenda have also acquired dentality (Nurse & Hinnebusch 1993: 572-5). Three different mechanisms are involved in the acquisition:

1. the dentals enter in large sets of borrowed vocabulary, as in Pokomo and Mijikenda;
2. inherited alveolars became dental, as in Elwana, presumably by the community absorbing many outsiders for whom dentality was the norm;
3. a phonetic process for the change from (pre)palatal to dental, as in the ND. In both cases the tongue lies in the same region but different parts of the tongue act alternately as the active articulators at the point where they lie. For palatals the blade operates on the palate, while the apex is raised,

---

<sup>9</sup>For instance, over 30 phonological features distinguish Bajuni from Standard Swahili (see Nurse 2013/2011, click on *Bajuni Database*, and go to the list at the end of *Wordlist*).



lying behind the teeth. For dentals, the apex operates on the teeth, while the blade is lowered from the palate. Disposition of blade and tip of tongue is identical or similar in both but, in a kind of rocking movement, one part is raised as the other is lowered.

This is discussed in more detail in Nurse 1985, the results are exemplified in Nurse & Hinnebusch (1993: 572-575) and the details are not discussed further here.

It can be seen that Bajuni is at the centre of the dentalization changes, being affected by all six innovations, Siu/Pate by four, Amu by three, Mwiini and the Mombasa dialects by only two. #3 and #8 do not involve dentalization and are only mentioned for the sake of completeness.

Table 1: Dentalization in Northern Swahili<sup>a</sup>

	North ND				South ND	
	Mwiini	Bajuni	Siu/Pate	Amu	Malindi, Mombasa	Base form/SD
1	<u>t</u>	<u>t</u>	<u>t</u>	<u>t</u>	<u>t</u>	[c]
2	<u>nd</u>	<u>nd</u>	<u>nd</u>	<u>nd</u>	<u>nd</u>	[nj]
3	nd <sup>r</sup>	nd <sup>r</sup>	nd <sup>r</sup>	nd <sup>r</sup>	nd <sup>r</sup>	[nd]
4	nz	<u>nd</u>	<u>nd</u>	<u>nd</u>	nz	[nz]
5	z	ð	ð	z	z	[z]
6	s	θ/s	s	s	s	[s]
7	ny/ <u>ŋ</u>	<u>ŋ</u>	ny	ny	ny	[ny]
8	t	c	c	t	t	[t]

<sup>a</sup>Comments on the table. Underlining = dental, ny = palatal, c, j = alveopalatal. For #6 I heard only [s] in Kenyan Bajuni in the 1970s, but have since heard [θ] from some Somali Bajunis. For #7, Mwiini behaves inconsistently, some words having the dental, others the palatal, no obvious conditioning factors. My guess is that the dentals, or the process itself is a loan from Bajuni where dental nasals are the regular outcome and Bajuni was the nearest community to the south. What happens in #8 might be a systemic compensation for #1, which led to all ND having (inherited) /t/ and (innovated) /t/ for a while – the subsequent affrication made the two less similar. Siu and Pate generally behave like Amu but here as Bajuni. I would guess that the change of [t] to [c] occurred under Bajuni influence. Portuguese records indicate that Bajuni influence and numbers were much greater in the past than today.

What do #1, 2, 4, 5, 6, and 7 tell us about the stratigraphy of the northern dialects? P-ND is defined by #1, 2, 3, which developed presumably in one or more of the early settlements, from about 800 AD to before just 1100 AD, when early Mwiini and Mombasa broke away. #4 developed while early Bajuni, Amu, Siu, and Pate were still adjacent and more or less in situ, between 1100 AD and when Bajuni started to spread along the coast. The implementation of all six changes in Bajuni suggests, by staying more or less in situ on the coast, it remained open to ongoing and later Somali influence (#5, 6, 7), after Mwiini moved north, Mombasa south, and Amu/Siu/Pate stayed the islands.

## **5 Lexical borrowing from Somali in the ND dialects**

The set of phonological innovations in Table 1 point to pressure from Somali-speaking communities but do not identify specific communities. But which Somali? The most obvious way of identifying possible donor communities is by examining loan sets, first those common to all ND, which would point at borrowing in the 800 to 1100 AD period, then in Bajuni/Amu/Siu/Pate, the group left after Mwiini and Mombasa broke away, then in Mwiini, Bajuni, and Amu/Siu separately, and finally in other possible groupings.

### **5.1 Sources**

It is relevant to mention briefly the quality and quantity of the data available. For Dahalo (Nurse 1986; Ehret et al. 1989; Tosco 1991; various minor sources), Mwiini (Kisseberth & Abasheikh 2004), Bajuni, Amu, Siu, Pate (Sacleux 1939; Nurse 2013/2011), Tunni (Tosco 1997; Vianello p.c.; Ehret's notes), Boni (Heine 1977; 1982; Sasse 1979), Karre (Tosco 1994), Elwana (Nurse 1994; 2000), Giryama = Miji Kenda (Deed 1964), Pokomo (various) reasonable data exists but only for Swahili dialects and Giryama/Mijikenda are the quantities of data really adequate. For other southern Somali dialects the lexical data is poor in quantity but also often in quality.

This is important because without large bodies of lexical data it is not possible to pinpoint the language donor communities properly.

### **5.2 Karre and Boni: the devoicing of Somali morpheme initial /d/ and /g/, and the reduction of NC to C (stop)**

Boni and Karre share features which distinguish them from other Somali varieties. One is the devoicing of Somali morpheme initial /d/ and /g/. So where

other Somali varieties have *daar* ‘touch’ and *guur* ‘migrate, move house’, Karre and Boni have *taar* and *kuur*. P-Somali *cimbir* ‘bid’ but G/B *shim(m)ir*. In what follows I take the position that Boni is the result of a coming together of Karre and Dahalo or a Dahalo-like language, when the Karre moved into what is now the Boni area. The term “coming together” is used advisedly, as there are different explanations of how this took place.

### 5.3 The sociolinguistic picture

There are two relevant factors. One is the size of the communities involved. It can be seen from Figure 1 that today the southern Somali communities (except Boni) are much larger than the ND communities. While it is tricky to guess at the size of earlier Somali communities, it is safe to say that the Swahili communities were always small, largely because they depended on wells for fresh water. The wells had and have a balance of fresh and salt water, and if too much fresh water is extracted, the well is eventually overwhelmed by salt water, becoming undrinkable, and the dependent community is doomed.<sup>10</sup> So it is reasonable to guess that relatively small Swahili communities on the islands were surrounded by larger mainland Somali communities. In such a situation, the likely direction of borrowing – of language and other material – is from larger to smaller.

The second factor is economic. As early Sabaki groups – early ND, Elwana, Pokomo, Mijikenda – moved up the coast, they almost certainly combined subsistence farming with hunting. At some point early Swahili communities made the move to maritime activities (fishing, and trading across the Indian Ocean). Wilson (2016) summarizes what was found by the archaeologists (Chittick, Horton) who excavated the three earliest large sites on the island, Pate, Shanga, Manda. At Pate, fish, turtle, chickens, cattle, camels, wild ungulates were present in the deepest levels, 750–850 AD, and sheep/goats by 850–1000 AD. At Shanga, fish were early but only in quantity after 1000, and chickens also appear early. Sheep/goats and cattle are in the record by 840, but in quantity only after about 980. Local hunting groups, such as Dahalo, on the adjacent mainland relied on hunting and fishing. Wilson (2016: 132) cites Horton’s suggestion that “Shanga might have been a multicultural society from its foundation, including (non-Bantu?) pastoralist elements”. Camel bones at Shanga are dated at 1075 AD, and camels certainly came south with Somalis, possibly along with cattle. Nurse (1985: 72) cite a tradition among the Pate people that “the origin of Pate was a per-

---

<sup>10</sup>This happened at Ngumi Island, a Bajuni settlement in southern Somalia, while at nearby Chula Island, the water is only fit for cattle, and water has to be brought in for humans.

son from the mainland who was of the Sanye<sup>11</sup> tribe”. Clearly the non-linguistic evidence suggests the early presence of Somali and other groups.

#### 5.4 Somali loanwords in various ND groupings

The total number of clear loanwords in the ND is much larger than what appears in this section. In Table 2 are included only the words which are loans in the ND and have a likely origin in some Somali dialect (or Dahalo, or maybe Orma).

The strengths and weaknesses of this lexically based approach can be seen from this list (more items could be added). With the exception of ‘deaf’ and ‘dried meat’, all 20 items here are clearly from some Somali source. They cannot be from Karre or Boni as they lack the devoicing of /d, g/, so we can say that they originate in D, J, M, or T. But beyond that, it is not possible to point at a clear single donor for these early ND borrowings: the available lexica do not show these items, so unambiguous source identification is impossible. The best candidate is Tunni. For geographical and (sketchy) historical reasons, Maay and Jiddu are unlikely candidates. We do not know enough of Dabarre.

I think it would be risky to draw too many conclusions about the nature of these loans until we have more complete data. However, most of these terms do not seem to indicate much economic or cultural influence from the Somali contact, which suggests that Somali influence may have resulted from sheer numbers.

At the breakup of the protocommunity, the earliest Bravanese moved up north around 1100 AD, to Brava and maybe further (see §3). For their language, Mwiini, there is a fine dictionary (Kisseberth & Abasheikh 2004), with some 5000 entries. Some entries are followed by a Swahili form, so mostly of Bantu origin, some are Arabic, some are followed by a Somali word, indicating probable Somali origin, and some are followed by no reference to any other language. Some pages have not a single Bantu entry. The authors admit they only consulted a Standard Somali dictionary and had little access to material from Somali dialects. Vianello (p.c.) has calculated that “some 20% of the general lexicon consists of borrowings from Somali and of Arabic words that have entered Chimiini through Somali”. Standard Somali is of northern origin but much of the material in Mwiini is of

---

<sup>11</sup>Name for any local hunting group.

<sup>12</sup>B = Boni, Dab = Dabarre, Dah = Dahalo, G = Karre, J = Jiddu, M = Maay, PSC = Proto-Southern Cushitic (Ehret), S = Somali T = Tunni

<sup>13</sup>Is this a mistake for tamari?

<sup>14</sup>‘Beestings’ (first milk) and ‘limp’ are a puzzle: why does Mwiini have the general Somali shape in both while the other dialects have the Karre shape? I assume separate borrowings.

Table 2: Somali loanwords shared by all ND = early ND

Mwiini	Bajuni	Amu etc	Cushitic <sup>12</sup>
<i>aabo</i> ‘a male name’	<i>abawa</i> ‘older brother’	abawa	T <i>abow/aboo</i> , B <i>ab’ue</i> , general S <i>abboow(e)</i> , M <i>aawow</i> ‘dad’. Is the Mw item from the same source as the others?
<i>baaya</i> ‘my older sister’ <i>bay and abbaay</i> ‘female names’, <i>abadhe</i> from T <i>hawa’adi</i>	<i>abaya</i> ‘older sister’	<i>abaya</i>	General S <i>abbaaye</i> , T <i>abaaya</i> ( <i>abada</i> ‘title for women in poetry’), not in B
<i>buru</i> ‘small fried wheat cake’	<i>avahadi</i> ‘gum for earache’ <i>buru</i> ‘maize’	<i>avahadi</i>  buru	prob. from T, as other S shapes are different  B <i>b’uuru</i> ‘maize’, Arabic <i>burr</i> ‘flour, wheat’, common S, Maay ‘pie’, PSC <i>bur-</i> , Dah <i>b’uru</i> . From Arabic?
<i>dambari</i> ‘beestings’	<i>damari</i> <sup>13</sup>	<i>tamari</i>	S <i>dambar</i> , d > t and mb > m characterize G and B. G <i>tamar</i> Dah <i>kamari</i> (k a mistake for t?) <sup>14</sup>
<i>daara</i> ‘touch’ <i>dhaayika</i> ‘melt’	<i>dara</i> <i>dayuka</i>	<i>dara</i> <i>dayuka</i> , <i>deyuka</i>	General S <i>daar</i> , Bo <i>taara</i> , Maay <i>taar-</i> S/Tu <i>dhay</i> ‘spread ointment’
<i>chi-duku</i> ‘navel’ <i>dhu</i> ‘marrow’,	<i>doko</i> ‘anus’ <i>i-duhu</i> ‘marrow’	<i>doko</i> <i>duhu</i>	S <i>dhuuq</i> ‘vagina’ S <i>dhuux</i> , T ‘marrow’, M <i>dhuu</i>
<i>dhuko</i> ‘deaf’ <i>dhaghaala</i> ‘partly deaf’ <i>duguwa</i> limp’	<i>duku</i> ‘deaf’  <i>dukuva</i> ‘be lame’	<i>duku</i>  <i>dekua</i>	S <i>dhegoole</i> , J <i>dhagaali</i> , M <i>dheghaal</i> , PSC <i>duux</i> , Dah. <i>d’uuko</i> . So <i>dhukay</i> ‘ear wax’  S <i>dugua</i> , M <i>dugh-ow</i> (note g to k in Baj, Amu etc)
<i>fuura</i> ‘swell’ <i>i-garabu</i> ‘shoulder blade’ <i>guura</i> ‘move, migrate’ <i>i-goroori</i>	<i>fura</i> <i>i-garabu</i>  <i>gura</i>  <i>i-gururu</i> ‘curdled milk’, also <i>kirori</i> <i>idhu</i>	<i>fura</i> <i>garabu</i>  <i>gura</i>  <i>gururu</i>	S, J, Dah all <i>fuur</i> S, T, M all <i>garab</i> , J <i>garaw</i> , (but G <i>karab</i> , B <i>karub</i> ) S, T, etc <i>guur</i> (G and B <i>kuur</i> ) S <i>garoor</i> , M <i>guruur</i> , T <i>goroor</i> ,
<i>mazu</i> ‘banana’		<i>izu</i>	Common S, B <i>maadu</i> (pl), Dah <i>madhu</i> . From Arabic?
<i>chi-skita</i> ‘dried meat or fish’	<i>musikita</i> ‘strip of dried meat’	<i>musikita</i>	Dah <i>sikkwita</i> , <i>misikita</i>
<i>muna</i> ‘younger brother/sister’	<i>mnuna</i>	<i>mnuna</i>	B <i>bamuna</i> ‘younger sister’

southern or unidentified Somali origin. The result is that the dictionary has many items not of Bantu, not of Arabic, and not of Northern/Standard Somali origin. Thus the percentage of words of Somali origin is likely to be much higher. My guess is it might be as high as 30% or maybe 40%. So many centuries of coexistence and bilingualism have resulted in very heavy borrowing in Mwiini from Somali. These items cannot be from Karre/Boni because they do not show the phonological characteristics of those dialects. Phonologically they might be from Tunni, Dabarre, Jiddi, or Maay: it would be worthwhile identifying the phonological and lexical differences between these four and against the unidentified lexical items in Mwiini.

Mwiini has also been influenced in non-lexical (morphological, syntactic) ways. Some of these are discussed in Nurse (1991), Henderson (2010), and Vianello (2015).

From what we know of the history of Brava in recent centuries, the most likely source is Tunni. They live and have lived in and around the town for centuries or maybe longer. Vianello (p.c) quotes a letter, written by influential Tunni elders to the Italian authorities in 1953, stating that they had been in the Brava region for 800 years, which of course cannot be confirmed.

After the departure of the Bravanese to the north and Mombasans to the south, a rump of early Bajuni/Amu/Siu/Pate speakers remained. A set of some 25 items is shared by those dialects.<sup>15</sup> They are a mixed bunch: some from an unidentified Somali dialect (not G or B), a couple from Karre/Boni ('beestings', 'limp', see Table 2), some of unknown origin. It stands to reason that one of the sources might be the continuing presence of the same Somali community that left its imprint on the original ND community (Table 2, Tunni?).

Next, the Bajuni community spread north along the coast. Bajuni has some 30 borrowings, many of which seem to be of Somali origin. Contrary to expectation, few are unambiguously from Boni/Karre, but an interesting item is *k<sup>h</sup>amasi* 'clan', with characteristic Boni/Karre devoicing, where Tunni has *gamaasi*.<sup>16</sup> The exact Somali source of most is again unclear but may be (?) one of the sources already mentioned (Tunni). A few apparently originated in Dahalo.<sup>17</sup> Ehret has pointed

---

<sup>15</sup>For reasons of space, these and others following are not shown. I can send them to interested readers.

<sup>16</sup>There is another interesting possibility. In older Bajuni poetry I found *loya* 'cattle'. Tosco (p.c) tells me he finds as the plural of *lo* in Karre the form *looyi*, which with the suffixed article gives *looya* (vowel shortened to Bajuni *loya*) 'the cows/cattle'. He describes it as a "strong connection with Karre".

<sup>17</sup>Sands finds it surprising that the Dahalo could have had much impact. The main source of data for lexicon for flora and fauna in the ND was Sacleux (1939), a huge volume of 1000 pages of

out to me that there is some evidence for a possible second Somali group in far northeastern Kenya before 1500 AD.

After the Bajuni exit, the Amu, Pate, and Siu communities remained in situ. They share a small set of loans, but so small as to make conclusions impossible. Likewise, Mwiini and Bajuni, historically close geographically, share a small loan set from Somali, but examination of these adds little to the general picture. They do not appear to be of Karre/Boni origin so may also be from Tunni.

### 5.5 Conclusions from loanwords (and phonology)

There has been a continuous Somali-speaking presence on the mainland adjacent to the Lamu Archipelago from 800 AD – and probably much earlier – to the present. But the nature of the Somali presence changed during that period. For much of that time, except recently, speakers of southern Somali dialects probably outnumbered the ND communities. At a more recent point in the period the Karre appeared, then withdrew, leaving their imprint in place in the form of the Boni and their language. In the early part of the period – and continuing till an undefined date – the Somali community was different – Tunni, Dabarre, Maay,<sup>18</sup> or Jiddu. There may even have been more than one Somali presence, but it is more economical to assume a single community, unless more than one can be demonstrated. The most likely single candidate is the Tunni, until and unless more lexical data becomes available for the other communities (Dabarre, Maay, Jiddu). I had hoped to be able to show a better, more concrete conclusion.

The somewhat sparse evidence also suggests a Dahalo presence in the area from the earliest period. Various articles in the bibliography deal with Dahalo influence on individual non-Dahalo language in the area but the picture would be improved by an examination of the phonological and lexical influence of Dahalo across the whole area.<sup>19</sup>

### 5.6 General non-linguistic history of the area

Several historians and others have weighed in on the (non-linguistic) history of the target area, and mainly on two topics: one, which was the original southern

---

fine print. I started through it but was daunted and abandoned the task. Once all the data there has been extracted and compared with that for Dahalo we will gain a better overview of the role of Dahalo.

<sup>18</sup>There are few serious suggestions that Maay played a role. It is included because it is in the area.

<sup>19</sup>Some of the consonant changes listed by Ehret (1980: 115-26), or their outcomes, are similar to those undergone by other languages in the area.

Somali group that influenced early ND from 800 AD for several centuries, and two, when did the Garre move south into the area.

The only substantial relevant claim about the original southern Somali group is in Lewis (1969: 15ff). Following earlier Italian scholars, who in turn had gleaned their information from Tunni oral traditions, he states that

“the Tunni once lived on the Juba River, then moved south and settled between Kismayuu and Lamu in the tenth or eleventh centuries AD, then “later” moved north again, across the Juba to settle near Brava, where they live today (which is just north of Kismayuu to just south of Merka, including Brava).”

That is an amazing claim, as it is not based on language. The place and the date correspond quite closely to what is claimed above, on linguistic grounds. The starting point, the “tenth century”, corresponds quite closely to the 800 AD date suggested above. It contains an obvious flaw – what exactly is that dating based on? The linguistic picture needs to be firmed up by examining more closely these lexical borrowings in the ND and how they fit with Tunni. We also need to know better when the Tunni finally withdrew.

All sources agree that Garre people moved south into the area: Bajuni traditions are quite detailed on this – Garre moved onto the islands from the north, original inhabitants e.g. on the north of Koyama Island were forced south, the newcomers carved their mark on a tree opposite Koyama Island before crossing over, Bajuni clan names are of two kinds, one of Bantu origin/toponyms while the others are southern Somali in origin, and one clan is even called the Garre (the others have not been identified yet). The Garre interacted with original hunter-gatherers, probably Dahalo, resulting in the Boni dialect, left behind when the Garre withdrew or were assimilated into the Orma.

The point of disagreement concerns when the Garre arrived. Some scholars have them arriving recently, just before 1700 AD, as the Portuguese were leaving. At the other end of the scale, others, for example, Ali (1985), date the Garre arrival seven centuries earlier, late in the first millennium AD. The loanword evidence in §5.4 above, first in the rump language/dialects left after the departure of the Bravanese and Mombasans and continuing through to the emergence of Bajuni, suggest contact with Karre starting some time after 1100 AD, thus inclining to the earlier date.



## 6 A corollary: the southern dialects of Swahili

Möhlig (1984-5: map p.345) and Nurse (1985: map p.60), independently, show the ancestors of the southern Swahili dialect (SD) communities, including Mwani in Mozambique, as migrating south from a Proto-Swahili origin in the Lamu Archipelago area. In view of the conclusions drawn here, that seems unlikely. All the Sabaki languages which originally went north to the Lamu area or further, show clear signs of Somali influence, phonological (esp. dentalization) and lexical. The SD show no such signs, for which there are two explanations. Either – less likely – the early SD community did go north but stayed a short time, short enough to have avoided all influence from Somali dialects, or – more likely – the SD never went north, having split from the ND at some prior point, which would mean that the Proto-Swahili community was located somewhere other than the Lamu area, somewhere further south. Where might the earliest SD have been located? Archaeology suggests the island of Kilwa, the earliest and largest site in the SD area, roughly contemporary at 800 AD with the three large early ND sites. And in that case, where might the putative Proto-Swahili area have been?

## 7 Conclusion

In the twelve centuries since this narrative began, huge changes have occurred in and around the target area. In 700 AD, only one southern Somali community, possibly Tunni, and the Dahalo lived there. Around 800 AD an early ND community arrived, along other Sabaki communities. The interaction between early ND and the Somali community changed early ND speech. Eventually that early Somali community withdrew – when? – and the Garre entered the scene. They interacted with Dahalo, resulting in the Boni dialect. Dahalo has declined slowly and inexorably over the whole period. First the Orma, then northern Somali moved steadily south into the area. The ND communities, who once lived on the islands and farmed extensively on the adjacent mainland, increasingly withdrew to the islands. This pressure from the north intensified, squeezing Orma into Kenya, followed by northern Somalis themselves, and pushing southern Somali communities south and east. For the ND, the final act came after 1991, when central government collapsed in Somalia, and the two remaining Bantu communities in Somalia, Bravanese and Bajuni, were reduced to almost zero as northern Somalis spread east and south. Since 1991, civil war has changed the linguistic picture to an as yet undetermined extent.

## 8 Acknowledgements

My thanks are due to Alessandra Vianello, Bonny Sands, Mauro Tosco, Tom Spear, Chris Ehret, Sarah Tishkoff, and Kirk Miller, for help with data, ideas, and corrections, and also to the two reviewers.

## References

- Ali, Mohammed Nuuh. 1985. *History of the Horn of Africa 1000 B.C. – 1500 A.D.* UCLA. (Doctoral dissertation).
- Deed, Florence. 1964. *Giryama-English dictionary*. Nairobi.
- Ehret, Christopher. 1980. *The reconstruction of Southern Cushitic phonology and morphology*. Berlin: Dietrich Reimer.
- Ehret, Christopher. 1995. The Eastern Horn of Africa, 1000 BC to 1400 AD: The historical roots. In Ali Jimale Ahmed (ed.), *The invention of Somalia*, 233–262. Lawrenceville, NJ: The Red Sea Press.
- Ehret, Christopher, Edward D. Elderkin & Derek Nurse. 1989. Dahalo lexis and its sources. *Afrikanistische Arbeitspapiere* 18. 55–49.
- Heine, Bernd. 1977. Bemerkungen zur Boni-Sprache (Kenia). *Afrika und Übersee* 60. 242–95.
- Heine, Bernd. 1982. *Boni dialects*. Berlin: Dietrich Reimer.
- Henderson, Brent. 2010. Chimwiini: Endangered status and syntactic distinctiveness. *The Journal of West African Languages* 37(1). 75–91.
- Kisseberth, Charles W. & Mohammad I. Abasheikh. 2004. *The Chimwiini lexicon exemplified*. Tokyo: ILCAA.
- Lamberti, Marcello. 1983. *Die Somali-Dialekte: Eine vergleichende Untersuchung*. Koeln. (Doctoral dissertation). [https://landinfo.no/asset/1800/1/1800\\_1.pdf](https://landinfo.no/asset/1800/1/1800_1.pdf).
- Lewis, I. M. (ed.). 1969. *Peoples of the Horn of Africa: Somali, Afar and Saho*. London: International Africa Institute.
- Lewis, M. Paul, Gary F. Simons & Charles D. Fennig. 2015. *Ethnologue*. Dallas.
- Maddieson, Ian. 1984. *Patterns of sounds*. Cambridge: CUP.
- Möhlrig, Wilhelm J. G. 1984-5. The Swahili dialects of Kenya in relation to Mijikenda and the Bantu idioms of the Tana Valley. *Sprache und Geschichte in Afrika* 6. 253–308.
- Nurse, Derek. 1983. History from linguistics: the case of the Tana River. *History in Africa* 10. 207–238.
- Nurse, Derek. 1985. Denticity, areal features, and phonological change in North-eastern Bantu. *Studies in African Linguistics* 16(3). 243–279.

- Nurse, Derek. 1986. Reconstruction of Dahalo history through evidence from loanwords. *Sprache und Geschichte in Afrika* 7(2). 267–305.
- Nurse, Derek. 1991. Language contact, creolization, and genetic linguistics: The case of Mwiini. In *Proceedings of the Berkeley Linguistic Society 17, Special Session on African Language Structures*, 177–187. Berkeley, CA: UC Berkeley.
- Nurse, Derek. 1994. South meets north: Ilwana = Bantu + Cushitic on Kenya's Tana River. In Peter Bakker & Marten Mous (eds.), *Mixed languages. 15 case studies*, 215–224. Amsterdam: Instituut voor Functioneel Onderzoek van Taal en Taalgebruik.
- Nurse, Derek. 2000. *Inheritance, contact, and change in two East African languages*. Cologne: Ruediger Koeppel Verlag.
- Nurse, Derek. 2013. *Bajuni database*. <http://www.faculty.mun.ca/dnurse/2011>.
- Nurse, Derek & Thomas J. Hinnebusch. 1993. *Swahili and Sabaki: A linguistic history*. Berkeley: UCP.
- Sacleux, C. Rev. 1939. *Dictionnaire swahili-français*. Paris: Institut d'ethnologie.
- Sasse, Hans-Jürgen. 1979. Entlehnung morphophonemischer Regeln im Boni. *Sprache und Geschichte in Afrika* 1. 93–108.
- Tosco, Mauro. 1991. *A grammatical sketch of Dahalo*. Hamburg: Helmut Buske Verlag.
- Tosco, Mauro. 1994. On case marking in the Ethiopian language area (with special reference to subject marking in East Cushitic). In Vermondo Brugnatelli (ed.), *Sem Cam Iafet*, 225–244. Milan: Centro Studi Camito-Semitici.
- Tosco, Mauro. 1997. *Af Tunni, grammar, texts, and glossary*. Koeln: Ruediger Koeppel Verlag.
- Vianello, Alessandra. 2015. *Chimiini profile*. Los Angeles: University of California, Los Angeles. <http://swahiliendangered.cdhl.ucla.edu/chimiini/profile-for-chimiini/>.
- Wilson, Thomas H. 1992. Settlement patterns of the coast of southern Somalia and Kenya. In Hussein M. Adam & Charles L. Gesheker (eds.), *Proceedings of the First International Congress of Somali Studies*, 76–112. Atlanta: Scholars' Press.
- Wilson, Thomas H. 2016. *Swahili monumental architecture and archaeology north of the Tana River*.



## Chapter 34

# The syntactic diversity of SAuxOV in West Africa

Hannah Sande

Georgetown University

Nico Baier

McGill University

Peter Jenks

UC Berkeley

Surface SAuxOV orders abound in West Africa. We demonstrate that apparent examples of this word order have important structural differences across languages. We show that SAuxOV orders in some languages are due to mixed clausal headedness, consisting of a head initial TP and head-final VP, though this order can be concealed by verb movement. Other languages are more consistently head-initial, and what appear to be SAuxOV orders arise in limited syntactic contexts due to specific syntactic constructions such as object shift or nominalized complements. Finally, we show that languages which have genuine SAuxOV, corresponding to a head-final VP, tend to exhibit head-final properties more generally. This observation supports the idea that syntactic typology is most productively framed in terms of structural analyses of languages rather than the existence of surface word orders.

## 1 Introduction

The order subject-auxiliary-object-verb (SAuxOV) is quite common across West Africa. At the same time, it is well-known that syntactic differences exist among the languages with this surface order (Creissels 2005). Our goal in this paper is to identify structural differences across languages for which SAuxOV order occurs,



and to show that these structural differences correlate with other word order properties of the language.

Our central observation is that there is a single clause structure which results in SAuxOV word order as a language-wide property. The relevant structure is MIXED CLAUSAL HEADEDNESS; here, the property of having a head-initial TP and a head-final VP, resulting in SAuxOV word order whenever an overt auxiliary is present. Such a structure is typical of the Kru and Mande language families. One example each from Guébie (Kru) and Dafing (Mande) is provided below.

- (1) a. Marka Dafing (Mande: Burkina Faso; Notes)

wúru-<sup>1</sup>ú <sup>1</sup>ní fwó-<sup>1</sup>ó ñì mì  
dog-DEF PST meat-DEF eat

‘The dog ate the meat.’

- b. Guébie (Kru: Côte d’Ivoire; Notes)

e<sup>4</sup>            ji<sup>3</sup>    ja<sup>31</sup>       li<sup>3</sup>  
1SG.NOM FUT coconuts eat

‘I will eat coconuts.’

This structure occurs in an area of West Africa we call the Mandesphere, the historical sphere of influence for the Mande empires which were politically dominant in West Africa for much of its recent history, as discussed further in §4.

There is one major difference in the clausal syntax of Kru and Mande languages, however. In Kru, but not in Mande, verb movement occurs in sentences without an overt auxiliary, resulting in SVO order. While this is an important syntactic difference between the languages, it seems to be inconsequential for the purposes of word order typology: both Mande and Kru languages are overwhelmingly head-final below the clause level, another property which is characteristic of the Mandesphere.

Outside of the Mandesphere, languages are generally head-initial (Heine 1976). Where apparent SAuxOV orders occur, we demonstrate that these do not involve mixed clausal headedness (Manfredi 1997; Kandybowicz & Baker 2003; Aboh 2009). We examine two such cases. First, we present a novel analysis of Gwari (Nupoid), in which we demonstrate that some auxiliaries such as the completive trigger movement of the object across the verb, while most others do not (2a).<sup>1</sup> The second case of apparent SAuxOV we examine involve nominalized complements, as in the Fongbe (Kwa) example in (2b):

<sup>1</sup>See Kandybowicz & Baker (2003) for a similar analysis of closely-related Nupe.

- (2) a. Gwari (Benue-Congo: Nigeria; Hyman & Magaji 1970: 51)  
 wó lá shnamá si  
 3SG COMPL:SG yam buy  
 ‘S/he has bought a yam.’
- b. Fongbe (Kwa: Benin; Lefebvre & Brousseau 2002:215)  
 Ûn è nú d̀̀ j́  
 1SG fall thing eat.NOM on  
 ‘I began to eat.’

The structures beneath these word orders are quite different from those we saw for Guébie and Dafing in (1). Tellingly, we show that languages with more restricted instances of OV order in (2) are systematically head-initial at the clause level.

Summing up, we will show that a head-final VP, which is a definitional property of SAuxOV languages, is a good predictor of head finality in West Africa. On the other hand the construction-specific presence of SAuxOV orders is not. The larger conclusion we draw from this observation is that typological correlations about headedness should be based on abstract structural analyses of languages, after factoring out independent syntactic operations such as verb movement, rather than on the presence or absence of surface orders in a given language. Moreover, it is the basic analytic toolkit supplied by generative syntax that allows such abstract generalizations to be stated.

The outline of this paper is as follows: §2 lays out the structural characteristics of SAuxOV arising from mixed clausal headedness in Dafing (Mande) and Guébie (Kru). §3 demonstrates that Gwari and Fongbe are head-initial in their clauses, including within the VP; OV orders are shown to occur as an artifact of particular syntactic constructions and contexts. §4 reports the results of a small typological survey showing that languages with mixed clausal headedness are concentrated in the Mandesphere, and compares our structural typology to those relying on surface order, such as the word order properties listed in WALS. §5 concludes.

## 2 Mixed clausal headedness

In this section we present evidence for analyzing some instances of SAuxOV word order as a result of clausal mixed headedness, where T, the position of inflection, is head-initial, but the verb phrase, VP, is head final. We show how these two structural properties are diagnosed in two languages, Guébie (Kru) and Dafing (Mande).

While there are many grammatical morphemes which can be called auxiliaries, we will use the term ‘auxiliary’ to refer to the element that surfaces in a position where TAM marking obligatorily occurs in declarative clauses, a position distinct from the position of the lexical verb. We analyze this position as T (for Tense) regardless of the semantic distinctions it encodes.<sup>2</sup> Many West African languages have such a position. To qualify as showing SAuxOV due to mixed headedness, the T position must be adjacent to the subject, and, in languages which index subjects, the T position must be the locus of subject agreement. If a language allows multiple auxiliaries to occur, the T position will be the position of the highest (usually leftmost) auxiliary.

Once the T position is identified in a language, the crucial test for whether it shows mixed headedness is whether, in the presence of an overt auxiliary in T, objects obligatorily precede the verb. We focus on clauses where the relevant object is the single object of a transitive verb.

## 2.1 SAuxOV in Kru

In this section we show that Guébie, a Kru language spoken in southwest Côte d’Ivoire, has mixed clausal headedness. Word order properties in Guébie are similar to word order across Eastern Kru languages (cf. Marchese 1979/1983), so we are using Guébie data here to diagnose SAuxOV across Eastern Kru more generally. It should be noted that in certain Western Kru languages like Grebo (Innes 1966) some of the tense/aspect marking is done through verbal suffixes, rather than auxiliaries. However, across the family, whenever an auxiliary is present, the verb surfaces after a direct object: SAuxOV (Marchese 1979/1983).

Most clauses in Guébie show SAuxOV order, where nothing can intervene between subject and auxiliary, and the verb is clause final. This is true of both main clauses, (3a), and embedded clauses, (3b).<sup>3</sup>

- (3) a. SAuxOV word order in Guébie (Kru: Côte d’Ivoire; Notes)
- |                        |                 |                  |                 |
|------------------------|-----------------|------------------|-----------------|
| e <sup>4</sup>         | ji <sup>3</sup> | ja <sup>31</sup> | li <sup>3</sup> |
| 1SG.NOM                | FUT             | coconuts         | eat             |
| ‘I will eat coconuts.’ |                 |                  |                 |

---

<sup>2</sup>This position is equivalent to Infl or I<sup>0</sup> in the GB framework.

<sup>3</sup>The Guébie data presented here come from original work on the language. The data were collected between 2013 and 2017, in Berkeley, California and Gnagbodougnoua, Côte d’Ivoire, with six primary consultants (cf. Sande 2017). Guébie is a tonal language with four distinct tone heights. Tone is marked here with numbers 1–4, where 4 is high.



- b. e<sup>4</sup>      wa<sup>2</sup>      gba<sup>1</sup> e<sup>4</sup>      ka<sup>3</sup> tɛɛ<sup>3.3</sup> kɔklalɛ<sup>3.2.2</sup>  
 1SG.NOM want.IPFV that 1SG.NOM IRR snake touch  
 ‘I want to touch the snake’

As is well known, a number of other word order properties correlate with OV across languages (Greenberg 1963; Dryer 2007). These include postpositions, genitive-noun order, and manner adverbs before main verbs.<sup>4</sup> Guébie displays all of these typological characteristics, as shown in (4).

(4) Guébie (Kru: Côte d’Ivoire; Notes)

- a. Postpositions  
 ɔ<sup>3</sup>      ji<sup>3</sup> su<sup>3</sup> mɛ<sup>3</sup> gara<sup>1.1</sup>  
 3SG.NOM FUT tree in perch  
 ‘He will perch in a tree.’
- b. Gen-N  
 touri<sup>1.1.3</sup> la<sup>2</sup> dɔre<sup>3.3</sup>  
 Touri GEN money  
 ‘Touri’s money’
- c. AdvV  
 e<sup>4</sup>      ji<sup>3</sup> fafa<sup>4.4</sup> ja<sup>31</sup> li<sup>3</sup>  
 1SG.NOM FUT quickly coconuts eat  
 ‘I will eat coconuts quickly’

With regards to (4c), some Western Kru languages like Krahn and Wobé place manner adverbs after verbs within the VP (Marchese 1979/1983: 80-81), much like the Mande word order discussed in §2.2. It is possible that this variation is due to contact of some Western Kru languages with Mande. However, because most Eastern and some Western Kru languages show the same word order as Guébie with respect to (4), it would seem that Adv-V order was present in Proto-Kru (Lynell Zogbo, p.c.).

In addition to word order properties that correlate with OV order across languages, we see other head-final properties in Guébie, such as nominalized verbal objects, which surface before the main verb, (5).

<sup>4</sup>We do not consider properties such as noun-adjective, which Dryer does not find to correlate with OV versus VO order across languages.

- (5) SAux[OV]<sub>NOM</sub> V in Guébie (Kru: Côte d'Ivoire; Notes)  
 e<sup>4</sup>        ji<sup>3</sup>    [ ja<sup>31</sup>        la<sup>2</sup> li-li-je<sup>3.2.2</sup>    ] koci<sup>23.1</sup>  
 1SG.NOM FUT coconuts of eat-RED-NMLZ start  
 'I will start eating coconuts.'

We see that word order in Guébie is overwhelmingly head final. However, when there is no auxiliary present, the verb fails to surface clause-finally, and instead appears immediately after the subject, resulting in SVO order, (6). SVO order only appears in two clause types: simple perfective, (6a), and simple imperfective, (6b).

- (6) Verb movement: S-V<sub>i</sub>-O-*t<sub>i</sub>* in Guébie (Kru: Côte d'Ivoire; Notes)
- a. e<sup>4</sup>        li<sup>3</sup>        ja<sup>31</sup>  
 1SG.NOM eat.PFV coconuts  
 'I ate coconuts.'
- b. e<sup>4</sup>        li<sup>2</sup>        ja<sup>31</sup>  
 1SG.NOM eat.IPFV coconuts  
 'I eat coconuts.'

The difference between perfective and imperfective verbs in Guébie is tonal. Verbs are only differentiated for aspect when they surface in the immediately-post-subject position. That is, verbs only show inflection when there is no auxiliary. This is a point of variation in Kru languages, where some languages show inflection on verbs even when they are not in the inflectional position (Marchese 1979/1983; Koopman 1984).

Reviewing the word-order properties of Guébie, we see that it follows the proposed diagnostics for a mixed-headed SAuxOV structure. First, it has a syntactic auxiliary position immediately following the subject, where TAM is marked. Usually TAM is marked by auxiliaries, but when verbs surface in this position (see below), they are marked with inflection. Guébie also shows obligatory OV word order within the verb phrase. The following diagram shows our proposed structure for Guébie SAuxOV clauses.

We see in Figure 1 that the auxiliary is in T, the inflectional position. We also see that objects precede verbs within the verb phrase. When there is no auxiliary present, we propose that the clause-final verb undergoes movement to T, the inflectional position. This is shown in Figure 2.

We will see that it is not only Kru languages which show mixed-headed SAuxOV structure, but other languages in West Africa as well.

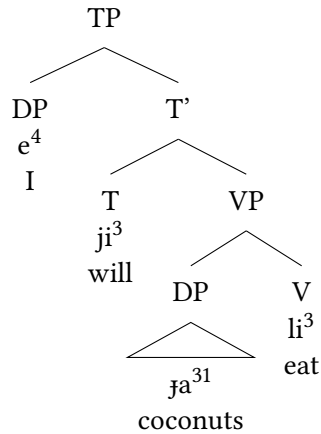

Figure 1: Guébie clause structure (cf. Sande 2017)

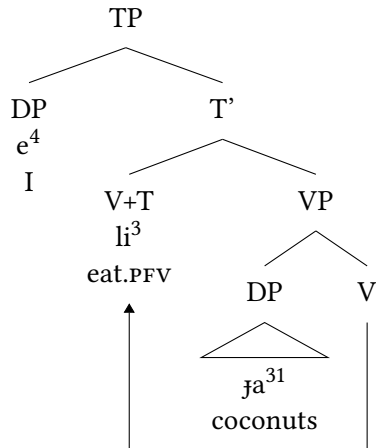

Figure 2: Verb movement in Guébie (cf. Koopman 1984; Sande 2017)

## 2.2 SAuxOV in Mande

Our second example with mixed clausal headedness is Dafing, also known as Marka, a Western Mande language spoken by 180,000 people in Burkina Faso (Prost 1977; Diallo 1988).<sup>5</sup> Dafing is closely related to Bambara and Jula (Dioula), which are both major Mande languages in the area with millions of speakers. Word order in Dafing is representative of Mande languages more generally (e.g. Creissels 2005; Nikitina 2011), and we take it as a representative language. The genetic affiliation of Mande is uncertain; it has been claimed to be of Niger-Congo stock (Greenberg 1966), although this classification is not well established (Dimmendaal 2008).

As in Guébie, Dafing shows SAuxOV word order. There is an auxiliary position which must occur immediately after the subject, and the verb surfaces after the object when auxiliaries are present. This is true for both main and embedded clauses.

(7) SAuxOV word order in Dafing (Mande:Burkina Faso; Notes)

- a. wú-rú-<sup>1</sup>ú ná fwó-<sup>1</sup>ó jì mì  
dog-DEF FUT meat-DEF eat  
‘The dog will eat the meat.’
- b. ê: ná fð ká wú-rú-<sup>1</sup>ú <sup>1</sup>ná fwó-<sup>1</sup>ó jì mì  
3SG PFV say COMP dog-DEF FUT meat-DEF eat  
‘She said that the dog will eat the meat.’

This auxiliary position is typically called the “predicative marker” in the Mandeist literature (e.g. Idiatov 2000; Creissels 2019); the number and types of distinction that are marked in this position are large, as it is a composite marker of tense, aspect, modality, negation, as well as transitivity, for example, in Soninke Creissels (2017).

Like in Guébie, Dafing has obligatory OV order in the verb phrase. Thus, we take Dafing to be a language with mixed clausal headedness, a head initial TP and a head final VP.

---

<sup>5</sup>The Dafing data in this paper was collected via elicitation in Berkeley, CA with a single consultant who is also a native speaker of Jula (Mande), and a fluent speaker of Mooré (Gur).

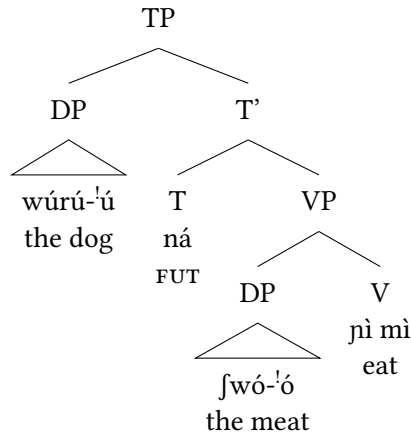

Figure 3: SAuxOV in Dafing

A similar structure is proposed by Nikitina (2009).<sup>6</sup>

Outside of the mixed-headedness in the clause, Mande languages like Dafing have many of the head-final properties that were also found in Kru languages like Guébie. For example, Dafing has postpositions (9a) and genitive-noun word order in the noun phrase (9b).

Another head final property that Dafing shares with Kru languages like Guébie (5) is that nominalized complement clauses precede embedding verbs.

- (8) SAux[OV]<sub>NOM</sub> V (Notes)  
 wú-rú-ú 'ní [ f-wó-ó ñì mí-í ] dàm-nà  
 dog-DEF PFV meat-DEF eat-DEF begin  
 'The dog began eating the meat.'

This is a point of variation in Mande, as Eastern Mande languages such as Wan do not allow the full nominalized VP to precede the higher verb (Nikitina 2009).

<sup>6</sup>A different analysis is suggested by Koopman (1984; 1992), who maintains that objects move from a postverbal position to a preverbal one in Mande. If this analysis is adopted, as it must be if one assumes that syntactic structures across languages are uniformly right-branching (Kayne 1994), then the criterion of mixed clausal headedness we refer to throughout would be reanalyzed as obligatory movement of the object to a position before the verb. In general, then, the main takeaway here and below would be the systematic difference between languages where objects obligatorily move to a position before verbs (Guébie and Dafing), resulting in general surface OV, and languages where objects only move to a position before verbs in specific syntactic contexts.

There are two significant differences which distinguish Mande and Kru. First, in Mande languages, all VP constituents besides the primary object follow the verb, including adverbs, clausal complements, and oblique arguments (Nikitina 2009). This is illustrated in (9c), which shows verb-adverb order in Dafing.

(9) Head finality in Dafing (Notes)

a. Postpositions

wú-rú-<sup>1</sup>ú tá-bà-rí-<sup>1</sup>í zú-kò  
dog-DEF table-DEF under

‘The dog is under the table.’

b. Gen-N

ʃi ká-á wú-rú-<sup>1</sup>ú  
Sidiki GEN dog-DEF

‘Sidiki’s dog’

c. VAdv (\*VAdv)

wú-rú-<sup>1</sup>ú <sup>1</sup>ní ʃwó-<sup>1</sup>ó ɲi mi zò-nà-zò-nà  
dog-DEF PST meat-DEF eat quickly

‘The dog ate the meat quickly.’

As verb-manner adverb order is generally a property of VO languages (Dryer 2007), Mande languages can be seen as somewhat less consistently head-final than Kru languages.<sup>7</sup>

The second difference between Kru and Mande is that Mande languages like Dafing never allow verb movement in transitive clauses, even in the absence of an overt auxiliary.

(10) No verb movement in Dafing (Notes)

wú-rú-<sup>1</sup>ú ʃwó-<sup>1</sup>ó ɲi mi  
dog-DEF meat-DEF eat

‘The dog eats the meat.’

In the preceding sentence, which is interpreted habitually, no overt auxiliary element occupies the T position. Yet SOV order still occurs. We assume that in

---

<sup>7</sup>Valentin Vydrin (p.c.) reports that some Mande languages also have Adv-V word order, so this may indeed be a point of variation across Mande, though we could not identify any convincing cases in the literature. One interesting case is Soninke, which allows adverbial content to occur in the preverbal object position with intransitive verbs, but only if that content is in the form of a DP (Creissels 2017); in such a case the existence of Adv-V word order is a question of analysis.

such cases there is a null auxiliary in T, such that the structure is identical to Figure 3, unlike in Kru, where verbs move to T when T lacks segmental content.

### 2.3 Summary

We have seen that Guébie (Kru) and Dafing (Mande) both have a mixed clausal headedness, a head initial TP and a head final VP. Independent differences conceal their structural similarity, such as differences in verb movement and adverb position. We also saw that Dafing and Guébie have head final structures elsewhere: both have Gen-N word order and postpositions. We revisit this connection in §4, where we will see that when we look at a broader sample of languages in West Africa, mixed clausal headedness is indeed a good predictor of head-finality below the clause level. Verb movement, on the other hand, has no clear correlations with head finality or SAuxOV, as would be expected if it is an independent syntactic operation.

## 3 Apparent mixed clausal headedness

### 3.1 Introduction

In this section we present data from two languages, Gwari (Nupoid) and Fongbe (Gbe) that exhibit apparent mixed clausal headedness as a result of SAuxOV order in a restricted set of constructions. In these languages, SAuxOV is not a general organizing principle of clause structure, as in Kru and Mande. Instead, Gwari and Fongbe have uniformly head-initial clause structures. Their SAuxOV orders instead arise in the context of specific syntactic constructions. In Gwari, (11a), SAuxOV order surfaces with a restricted set of aspectual particles. In Fongbe, (11b), putative OV order only occurs in the context of nominalized VP complements. Hence, putative SAuxOV in Fongbe is in fact SVGenN.

#### (11) Apparent cases of SAuxOV in Gwari and Fongbe

##### a. Gwari (Benue-Congo: Nigeria)

wó kú àshnamá si  
3SG COMPL:PL yams buy

‘S/he has bought yams.’

(Hyman & Magaji 1970: 56)

##### b. Fongbe (Kwa: Benin)

Ûn è nú d̀ù jí  
1SG fall thing eat.NOM on

‘I began to eat.’

(Lefebvre & Brousseau 2002: 215)

Our proposals about Gwari and Fongbe resemble existing syntactic analyses of closely related languages. Putative OV order in Gwari is derived by object shift across the aspectual particle followed by further movement of this particle above the shifted object (Manfredi 1997; Kandybowicz & Baker 2003; Aboh 2009). In contrast, the putative OV order in Fongbe nominalized complements are due to the fact that genitives precede nouns in Gbe languages (Aboh 2005).

### 3.2 Gwari

In clauses without an auxiliary, Gwari (Nupoid, Nigeria) displays SVO word order, as shown in (12).

- (12) SVO word order in Gwari
- a. wo si    ɔbwī  
   3SG buy groundnut  
   'S/he buys groundnuts.' (Hyman & Magaji 1970: 51)
  - b. wo lá    shnamá  
   3SG take:SG yam  
   'S/he takes a yam.' (Hyman & Magaji 1970: 51)

Past tense is marked with an overt auxiliary that appears after the subject. The word order in past tense clauses is SAuxVO, as shown in (13):

- (13) a. Today past continuous  
   wo béi si shnamá  
   3SG T.PST buy yam  
   'S/he was buying yams.' (Hyman & Magaji 1970: 54)
- b. Yesterday past continuous  
   wò bei sii ɔbwī  
   3SG Y.PST buy groundnut  
   'S/he was buying groundnuts.' (Hyman & Magaji 1970: 54)
- c. Beyond yesterday past continuous  
   wò bei si ɔbwī  
   3SG BY.PST buy groundnut  
   'S/he was buying groundnuts.' (Hyman & Magaji 1970: 54)

While Gwari is like Guébie in having optional auxiliaries, the data in (13) distinguish the two types of languages. In Guébie, as we saw above, the presence of



any overt auxiliary forces a change from VO to OV order. In Gwari, the presence versus absence of the past tense marker does not result in such an alternation. Because the presence of an overt auxiliary must block the movement of verbs to T, the persistence of VO word order in the presence of an auxiliary suggests that the Gwari has a head-initial (VO) VP, unlike Guébie.

The fact that Gwari has a head-initial VP correlates with other head-initial properties of Gwari, including prepositions (14a) and verb-adverb order (14c), although the presence of genitive-noun order is a head-final property (14b).

- (14) a. Prepositions/Postpositions  
 wo tú shnamá lō ó tēbùl-`  
 3SG put yam STAT LOC table-LOC  
 ‘S/he is putting the yam on the table.’
- b. Genitive-Noun  
 ēbí yàbà  
 child banana  
 ‘the child’s banana’ (Hyman & Magaji 1970: 25)
- c. V-Adverb  
 yi gô àkyàuta cīcī  
 1PL buy gifts always  
 ‘We always buy gifts.’ (Hyman & Magaji 1970: 51)

In fact, genitive-noun word order is the most common exception to head-initiality in West African languages, which otherwise show word orders that correspond typologically with head-initial VPs, as also noted in Heine (1976). Genitive-noun order plays a critical role in the discussion of Fongbe below.

While it is generally head-initial, some auxiliaries in Gwari trigger OV order, most notably the completive aspect marker.<sup>8</sup> Completive aspect is marked with an auxiliary that occurs between the subject and VP. Unlike the past tense however, where we see the surface order SAuxVO, completive-marked sentences have the surface order SAuxOV:

- (15) a. *lá*: singular objects  
 wó lá shnamá si  
 3SG COMPL:SG yam buy  
 ‘S/he has bought a yam.’ (Hyman & Magaji 1970: 64)

<sup>8</sup>This pattern is also found in closely related Nupe in the completive, analyzed in Kandybowicz & Baker (2003), whose analysis shares several elements with ours, as discussed further below.

- b. *kú*: plural objects  
 wó kú àshnamá si  
 3SG COMPL:PL yams buy  
 ‘S/he has bought yams.’ (Hyman & Magaji 1970: 56)

In addition to the difference in word order that these two auxiliaries enforce, they behave differently with respect to agreement. As shown in (15), the completive auxiliary agrees with the number of the object. This is not the case for the past tense auxiliary, which does not agree with either the subject or the object; this agreement relationship is indicative of a closer syntactic relationship between the completive and the object than the past tense marker.

Now the past tense auxiliary and completive auxiliary may be combined, as shown in (16). In such sentences the past tense precedes the completive aspect, indicating that past tense is structurally higher than the completive, following the general head-initiality of Gwari clause structure. When both past and completive markers are present, the surface word order is SAuxAuxOV, in the today and before yesterday past, or SAuxOV, with the completive and tense markers fusing, in the yesterday past.

- (16) a. Today past completive  
 w-a kú àshnamá si  
 3SG-T.PST COMPL:PL yams buy  
 ‘S/he bought yams.’ [today] (Hyman & Magaji 1970: 57)
- b. Yesterday past completive  
 wò kùì àshnamá si  
 3SG Y.PST.COMPL:PL yams buy  
 ‘S/he has bought yams.’ [yesterday] (Hyman & Magaji 1970: 57)
- c. Beyond yesterday past completive  
 wò bei kú àshnamá si  
 3SG BY.PST COMPL:PL yams buy  
 ‘S/he has bought yams.’ [before yesterday] (Hyman & Magaji 1970: 57)

The fact that the past tense and completive aspect can be combined in this way demonstrates that they are not competing for the same structural position. While the high tense auxiliary is like its auxiliary counterparts in Guébie and Dafing, for example in hosting the subject in its specifier position, the lower completive auxiliary has no clear counterpart in those languages. Furthermore, it is the presence of the completive which is responsible for OV order. We now demonstrate how the completive can have this effect syntactically.

The tree in Figure 4 illustrates an analysis of a Gwari sentence with a past tense auxiliary in T. The verb originates in a VP projection where the object is base-generated and receives its theta role. The verb obligatorily moves to a distinct *v* head which introduces the external argument (not shown), resulting in SVO order.

Following Kandybowicz & Baker (2003), we assume that completive auxiliaries originate in a completive V head (AgrO in Kandybowicz & Baker (2003)), which intervenes between V and *v*, blocking movement of the main verb to V, and moving to *v* in its place. In addition, the completive head triggers movement of the object to its specifier, where it agrees with the object in number (15). The result is the SAuxOV word order in the completive aspect, shown in Figure 5.

Support for the idea that the completive is still a kind of lexical verb, rather than an auxiliary, comes from its transparent identity to the lexical verbs *lá* ‘take’, and *kú* ‘collect,’ which occur with singular versus plural objects, respectively (Hyman & Magaji 1970: 63):

- (17) a. Gwari ‘take’ as a main verb  
 wo lá shnamá lō  
 3SG take yam STAT  
 ‘S/he is taking a yam’ (Hyman & Magaji 1970: 92)
- b. Gwari ‘gather’ as a main verb  
 wo kú àshnamá lō  
 3SG take yam STAT  
 ‘S/he is taking some yams’ (Hyman & Magaji 1970: 93)

Compare Aboh (2009) for a similar analysis of serial verbs involving ‘take’ in Gbe languages.

Evidence for the idea that object movement is responsible for OV orders in Gwari comes from double object constructions. When there is no completive auxiliary, as in (18a), the verb precedes both objects. In completive clauses, however, the verb occurs between the two objects. Either order of arguments is possible, as seen in (18b-c).

- (18) a. SVO<sub>1</sub>O<sub>2</sub>  
 wo bma mi būsì ya lo  
 3SG break 1SG stick PART STAT  
 ‘S/he is breaking my stick’ (Hyman & Magaji 1970: 92)

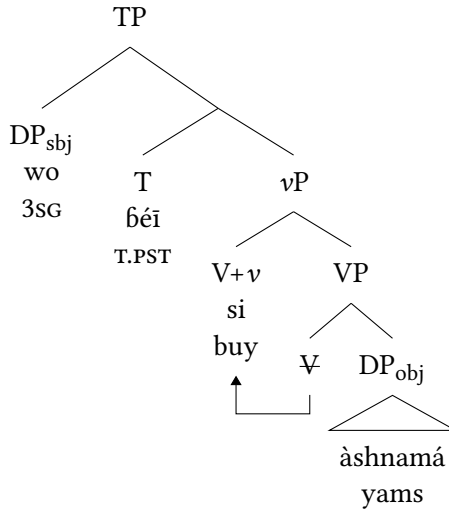

Figure 4: Structure for SAuxVO in Gwari

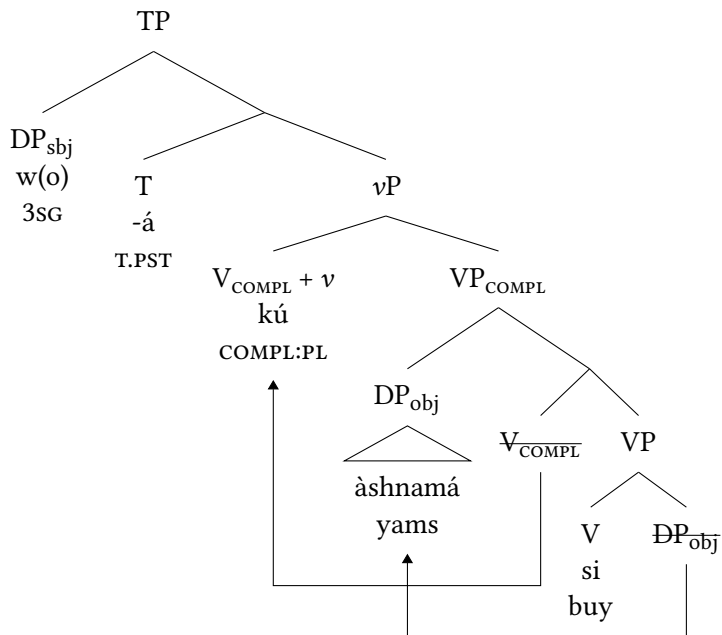

Figure 5: Structure of SAuxOV in Gwari

- b. SAuxO<sub>1</sub>VO<sub>2</sub>  
 wó lá            būsì bmà mi ya  
 3SG COMPL:SG stick break 1SG PART  
 ‘S/he has broken my stick’                    (Hyman & Magaji 1970: 93)
- c. SAuxO<sub>2</sub>VO<sub>1</sub>  
 wó lá            mí bmà būsì ya  
 3SG COMPL:SG 1SG break stick PART  
 ‘S/he has broken my stick’                    (Hyman & Magaji 1970: 93)

Double object constructions provide evidence against a head-final VP analysis. If the Gwari VP were head-final, then we would expect both objects to precede the verb when it does not move to Asp. The current analysis, on the other hand, accounts for this in a simple way: either object in a double object construction is able to move to the specifier of V<sub>COMPL</sub>P.

What we have seen is that Gwari is uniformly head-initial in its clausal spine. When apparent SAuxOV word order still emerges, it is not due to mixed clausal headedness, but instead due to a combination of verb movement of a low aspect head combined with object shift – a simple schematic representation of the structure is SAuxV<sub>1</sub>OV<sub>2</sub>. Like Guébie, verb movement plays a crucial role in the alternation between VO and OV orders. In Gwari, SAuxOV order only emerges when verb movement to Asp is blocked. However, in Gwari, unlike in Guébie, object shift plays a crucial role. Namely, SAuxOV order only occurs because object shift is independent from verb movement to Asp. This is markedly different from Guébie and Dafing, where VP is always head final while TP is head initial.

### 3.3 Fongbe

In this section, we will see that in Fongbe, apparent SAuxOV order emerges from a distinct construction: nominalization. Fongbe is a Kwa language spoken in Benin. Fongbe shows SVO order in main clauses without an auxiliary, as seen in (19). Like Gwari, Fongbe has a set of auxiliaries that occur with SAuxVO word order, such as the habitual in (19b).

(19) SVO

- a. Kòkú xò Àsíbá  
 Koku hit Asiba  
 ‘Koku hit Asiba.’                    (Lefebvre & Brousseau 2002: 247)

- b. SAuxVO  
 Lili nò òù gbàḍé  
 Lili HAB eat corn  
 ‘Lili (habitually) eats corn.’ (Lefebvre & Brousseau 2002: 94)

Other auxiliaries occurring in the same position as the habitual above include the future, irrealis, and anterior markers. So SAuxVO is the general word order in clauses with auxiliaries in Fongbe.

Like Gwari, Fongbe displays mixed headedness properties, an issue which is examined in detail in Aboh (2004) for Kwa languages in general. Like in many Kwa languages, Fongbe nominal complements precede the noun that selects them, a head-final characteristic (20a). On the other hand, possessors follow the noun they modify, a head-initial characteristic, (20b).

- (20) a. Comp-N  
 càkpàlò sín gò ó  
 beer OBJ bottle DEF  
 ‘the bottle of beer’ (Lefebvre & Brousseau 2002: 45)
- b. N-Gen  
 àwà ví ó tòn  
 arm child DEF gen  
 ‘the child’s arm’ (Lefebvre & Brousseau 2002: 45)

Other word order properties also give similar mixed results. Fongbe has both prepositions and postpositions, as shown in (21a). Verbs precede adverbial modifiers, as shown in (22).

- (21) a. Pre- and postpositions  
 Kòkú xò àsón nú Àsibá  
 Koku buy crab for Asiba  
 ‘Koku bought crab for Asiba’ (Lefebvre & Brousseau 2002: 302)
- b. Kòkú òò àxì mèn  
 Koku be.at market in  
 ‘Koku is in the market’ (Lefebvre & Brousseau 2002: 325)

- (22) V-Adv  
 Kòkú wà àzò gànjí  
 Koku do work well  
 ‘Koku worked well’ (Lefebvre & Brousseau 2002: 381)

While it has some head-final properties, Fongbe is largely head-initial at the level of the clause. We demonstrate below that apparent OV order is not due to mixed clausal headedness in Fongbe but rather due to a nominalized complement of a lexical verb.

Our main interest here is what Lefebvre & Brousseau (2002) call an “aspectual verb construction”. Superficially, this construction has SAuxOV word order, in that the lexical verb in the clause is preceded by its object, as shown in (23).

- (23) SV[OV]<sub>NOM</sub>
- a. Àsibá d̀ò [[ ví    ́    kpón            ]] wè ]  
 Asiba be.at child DEF look.at.NOM POST  
 ‘Asiba is looking at the child’ (Lefebvre & Brousseau 2002: 215)
- b. Ûn è [[ nú    d̀ù            ]] jí ]  
 1SG fall thing eat.NOM on  
 ‘I began to eat.’ (Lefebvre & Brousseau 2002: 215)

However, as can clearly be seen from the data in (23), the aspectual verbs *d̀ò* ‘be at’ and *è* ‘begin’ (lit. ‘fall’) actually take a PP complement, the head of which selects a nominalized verb phrase.

This fact makes the Fongbe aspectual verb construction quite different from the constructions we have examined so far. In the other languages surveyed, SAuxOV word order involves a single extended projection of a lexical verb, and the placement of that verb in relation to its object changes based on the properties of heads higher in the clausal spine. In Fongbe, apparent OV order involves a nominalized verb. The inflected verb here is a lexical verb that selects a PP complement; it is not an auxiliary. Aspectual verbs in Fongbe retain their lexical uses. For example, the verb *è* in (23b) can be used to simply mean ‘fall’. Thus, these word orders are better labeled SVGenN or SVO than SAuxOV.

The data above demonstrate Fongbe is head initial for both TP and VP. In SVO clauses, no movement is needed to derive the word order, as shown in Figure 6.

In contrast apparent SAuxOV order in Fongbe occurs when a main verb selects a PP complement.<sup>9</sup> The head of the PP, in turn, selects a nominalized VP complement. The structure is shown in Figure 7.

<sup>9</sup>See Aboh (2010) for discussion of the structure of Kwa noun phrases as well as an account of the combined pre- and postpositions typical of Kwa. Unlike our analysis below, Aboh adopts uniform head-initial structures with righthward complements moving to specifier positions to the left of the noun.

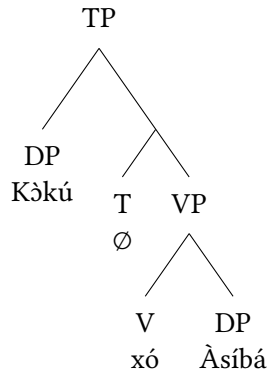

Figure 6: SVO Structure in Fongbe

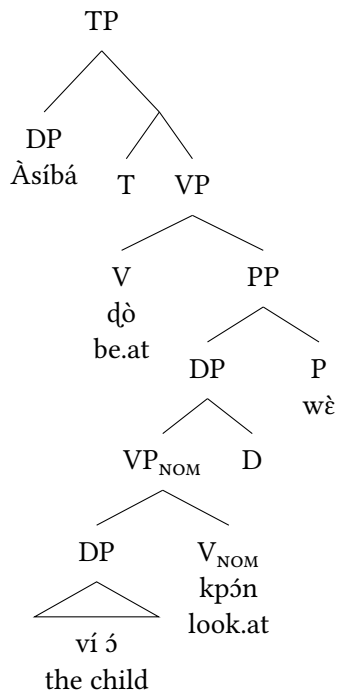

Figure 7: SVOV Structure in Fongbe; cf. Aboh (2004: ch. 6)



Because nominal complements always precede the noun that selects them in Fongbe (20a), apparent OV order inside the nominal VP arises simply because Gen-N is the normal order for noun phrases, including nominal complements. Because Fongbe is head-initial in verb phrases, the aspectual verb precedes its complement, and this gives rise to apparent SAuxOV order. In fact, however, this is simply SVGenN word order, where N is a nominalized verb.

### 3.4 Summary

We have seen that neither Gwari (Nupoid) nor Fongbe (Kwa) has a head-final VP, and therefore OV order is not a general organizing characteristic of their clausal architecture. This makes them different from Guébie and Dafing in several ways. First, surface OV order has a restricted distribution in both languages. In Gwari, it occurs only when there is a completive verb which triggers object shift and blocks movement of the lexical verb. In Fongbe, OV order only occurs in nominalized verb phrases. Second, outside these narrow contexts, auxiliaries occur with VO word order. Under our analysis of Gwari and Fongbe, this is because these auxiliaries occupy the  $T^0$  head of TP, and TP is head-initial.

The derivation of apparent SAuxOV word order in Gwari differs from that in Fongbe. In Gwari, a combination of object shift and lack of verb raising conspires to yield apparent SAuxOV orders, orders that we noted were in fact  $S(\text{Aux})V_1OV_2$ . In Fongbe, OV order emerges in nominalized complements to certain aspectual verbs, so the Fongbe order is in fact  $S(\text{Aux})V\text{GenN}$ . One path forward for formal typological research is to identify how much variation there is within languages with apparent SAuxOV structures. It seems certain that both phenomena (object shift, nominalized complements) are relatively common in West Africa, the latter in particular given the frequency of GenN word order.

There are additional cases of apparent SAuxOV in West Africa that are conditioned by other factors. For example, object shift is obligatory with pronouns in Ogoni languages such as Kana (Ikoro 1996), and it is conditioned by negation in Leggbó (Good 2007). Yet all of these cases, occurring in languages spoken well to the east of the Mandesphere, should not be conflated with the mixed clausal headedness which is at the root of SAuxOV in Kru and Mande languages.

## 4 Survey results: Distribution of SAuxOV

In this section we examine the distribution of SAuxOV order with mixed-headedness within the Macro-Sudan Belt, and specifically within West Africa. In order

to carry out this structure-based typological study, we followed three steps: 1) establishing a relevant structure, 2) identifying structural diagnostics based on descriptive facts, and 3) conducting a survey on the basis of those structural diagnostics. These three steps result in a typological survey based on both hierarchical structure and descriptions of linear word order properties.

Step one, above, is discussed in §2, where we define the relevant structure for SAuxOV with clausal mixed-headedness. This structure involves a dedicated inflectional position immediately following the subject, and general OV word order within the verb phrase. To address steps two and three, we identified 26 syntactic variables meant to identify SAuxOV structures, and we carried out a survey of 54 languages from the Macro-Sudan belt, recording the value for each syntactic variable whenever relevant information was available. Metadata about each language, the sources used to determine the survey responses for those languages, and where each language is spoken were collected. The survey was informed by both typology and hierarchical structure, examining word order properties that have been found to be most closely associated with head finality (Dryer 1992; 2007), those that determine headedness within the VP, and those that distinguish SAuxOV due to clausal mixed-headedness from verb-second languages and head-initial languages with object shift. A full list of the 26 variables examined, along with the values of those variables reported for each language, is given in the appendix.

The languages surveyed comprise a diversity sample based on genetic affiliation and geography, loosely based on the sample used by Clements & Rialland (2008). The number of languages in each family in our survey is given in Table 1. The remainder of this section reports on the results of our survey.

The map in Figure 8 shows the distribution of languages with mixed-headedness in the clause leading to structural SAuxOV based on our survey. Each language is marked on the map with a colored letter, where the letter represents language family. The letter key is given in Table 1. Colors represent different word order relationships between auxiliaries, objects, and verbs, where red represents SAuxOV order with mixed-headedness in the clause. Language families and latitude and longitude for each language are determined from Glottolog (Hammarström & Nordhoff 2011).

We see that there is a strong cluster of SAuxOV with clausal mixed-headedness in West Africa. There is a strong centralization of SAuxOV orders in the area around Mande and Kru languages, which we call the *Mandesphere* given the historical influence of the Mande-speaking Mali Empire in this area.

Table 1: Languages included in survey

Language family	<i>n</i>	Languages	Map key
Adamawa	3	Mundang, Mambay, Banda-Linda	A
Atlantic	2	Sereer, Fula	Z
Bantoid/Bantu	2	Noni, Bisa	B
Bongo-Bagirmi	3	Kabba, Kenga, Mbay	P
Chadic	6	Hausa, Pero, Mupun, Mina, Miya, Lele	C
Central Sudanic	1	Ma'di	S
Cross River	1	Khana	R
Dogon	2	Jamsay, Tommo So	D
Edoid	2	Esan, Degema	E
Ethio-Semitic	1	Amharic	V
Gbaya	1	Ngbaka	Y
Gbe	2	Maxi, Fongbe	F
Gur/Senufo	7	Dagbani, Bwamu, Bariba, Koromfe, Supyire, Dagaare, Lobi	G
Ijoid	1	Kalabari	I
Kordofanian	1	Otoro	O
Kru	5	Guébie, Godié, Grebo, Wobe, Krahn	K
Kwa	2	Tafi, Akan	W
Mande	6	Mano, Dafing, Bamana, Boko, Bobo, Gouro	M
Mel	1	Mani	U
Nilotic	1	Lango	L
Nupoid	1	Gwari	N
Saharan	1	Beria	X
Songhay	2	Koyraboro Senni, Tondi Songway Kiini	H

In order to discover whether other head-final properties are distributed in the same way as SAuxOV structures with mixed headedness, we look first at the distribution of postpositions, which closely mirror the postposition map of Africa from the World Atlas of Language Structure (Dryer 2013a) (Figure 9).

Like postpositions, Genitive-Noun word order correlates with OV across languages (Dryer 2007), and it is well known that adposition and genitive order track each other across languages based on their relationship in grammaticalization. The distribution of Genitive-Noun order given our survey is shown in Figure 10. The WALS map of Genitive-Noun order in Africa shows a very similar distribution.

Dryer (2007) also observes that OV languages surface with manner adverbs before verbs. However, we found that Manner Adverb-Verb order has a much narrower distribution within West Africa than are other head-final properties like postpositions, Genitive-Noun order, and even mixed-headed SAuxOV.

Unlike the distribution of postpositions and Genitive-Noun order, which resemble the distribution of SAuxOV, the order of manner adverbs and verbs does not seem to correlate with other head-final properties in West Africa (Figure 11). This is likely due to the combination of VAdv and OV word order in Mande and some Kru languages.

Verb movement also shows a different distribution from SAuxOV with mixed headedness. We saw in Guébie, a language that shows clausal mixed headedness, that when there is no auxiliary present, the verb surfaces immediately after the subject in the inflectional position. We analyze this SVO order as verb movement. In Figure 12, the combination of two word order properties determines whether verb movement is present in a language: 1) word order when an auxiliary is present (say, SAuxOV), and 2) word order in clauses without an auxiliary (say, SVO). While the Mandesphere is almost entirely characterized by clausal mixed headedness, only a subset of these languages shows verb movement. Verb movement is detectable in a number of head-initial languages, with SAuxVO order, based on the requirement that the verb need not be adjacent to the object, i.e., adverbs can intervene these two elements when an auxiliary is absent. We conclude that verb movement is independent from headedness.

The results of our survey are summarized in Table 2. We conclude that head-final properties like postpositions and Genitive-Noun order correlate strongly with clausal mixed headedness (SAuxOV order) in the Macro-Sudan belt, and specifically in West Africa. As head final properties are centered around the Mandesphere, along with clausal mixed headedness, we concur with Heine (1976) that Proto-Mande was likely head final, and is likely the source of this areal pattern,

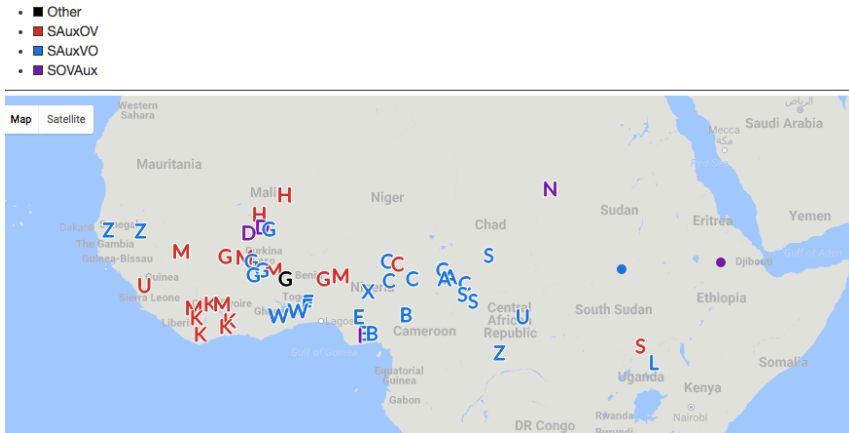

Figure 8: Distribution of SAuxOV (red). The language in black is Dagbani, a Gur language in which we were not able to identify auxiliaries.

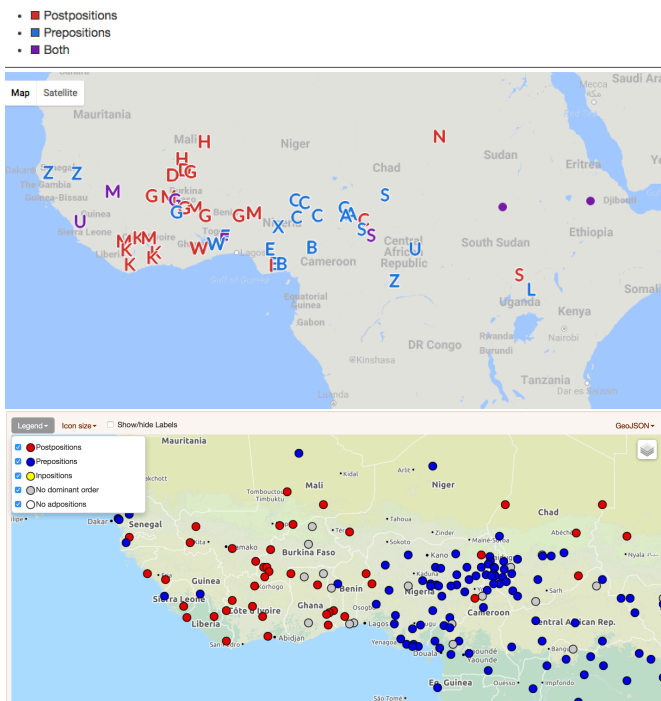

Figure 9: Distribution of postpositions in our survey (top) and WALS (bottom) (Dryer 2013a)

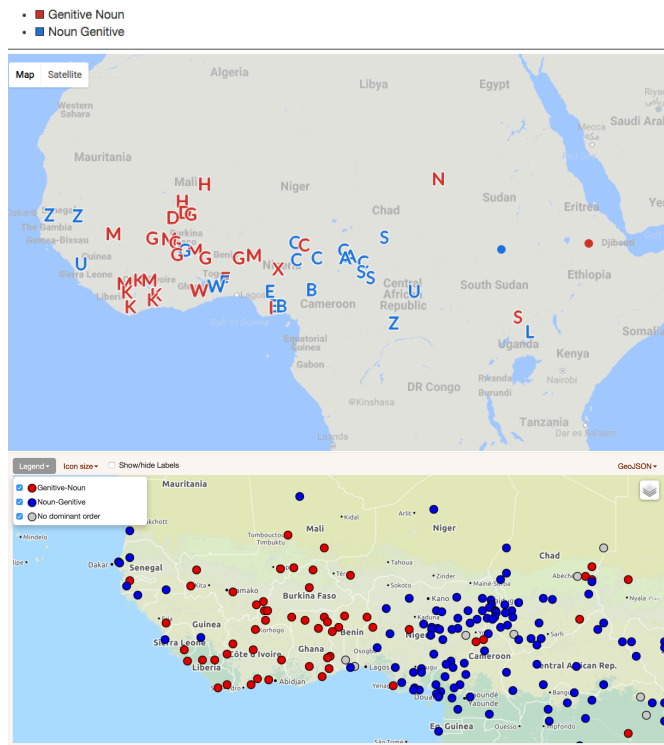

Figure 10: Distribution of GenN in our survey (top) and WALS (bottom) (Dryer 2013b)

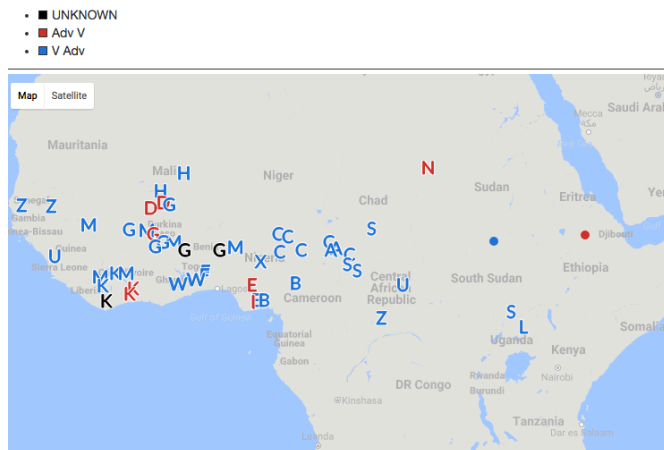

Figure 11: Distribution of Adv-V (red)

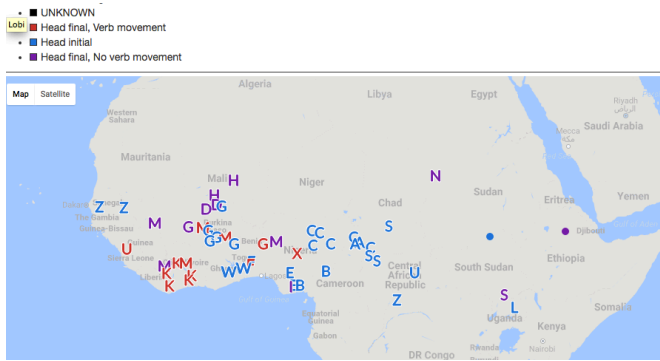

Figure 12: Distribution of verb movement (red)

particularly in light of the outsized economic and cultural influence of Mande speakers in the West African history. The results of our survey show that only languages in the Mandesphere show clausal mixed-headedness. The appearance of conditioned SAuxOV, discussed in §3, does not correlate as neatly with head-final properties as mixed headedness does in the Mandesphere.

Table 2: Head-final properties whose distribution correlates with mixed-headed SAuxOV

	Correlates with SAuxOV	Independent of SAuxOV
Postpositions	X	
Genitive-Noun	X	
Verb-Adverb order		X
Verb movement		X

The fact that clausal mixed headedness is a better predictor of head-final properties than the presence of apparent SAuxOV such as those in Gwari and Fongbe highlights a more general point about syntactic typology we would like to emphasize: while many typological discussions of word order are based on surface order, the results in this section clearly demonstrate that syntactic typologies should be based on structural analyses of languages instead. The success of this approach in the survey above indicates that cross-linguistic tendencies about word order might be more profitably framed in terms of the underlying structures that give rise to these word orders rather the existence of various surface patterns.

## **5 Conclusion**

It has been understood since at least Heine (1976) that SAuxOV word order is a typologically significant property of West African languages. More recently, Güldemann (2008; 2011) has suggested that S(Aux)OVX (with emphasis on X) is a property of a linguistic area he labels the Macro-Sudan Belt, similar to the Sudanic zone of Clements & Riailand (2008), which stretches west to Senegal and Guinea and east to the Central African Republic.

A potential problem for this claim is that, as we have now seen, S(Aux)OVX is almost certainly not a single syntactic phenomenon. In particular, we must be careful to distinguish between the superficial appearance of such a word order with a structure that is actually distinct, as in Gwari and Fongbe, from the existence of genuine mixed clausal headedness in Mande and Kru.

At the same time, the more fine-grained picture we have sketched clarifies a number of interesting historical and areal questions. For example, what is the distribution in West Africa of OV due to object shift (as in Gwari) versus OV due to nominalization (as in Fongbe)? Are these constructions generally found, and hence reconstructable, in their narrower language families? Are these structures more common among languages directly adjacent to the Mandesphere, suggesting a contact-based origin? While these questions can only be asked in the context of a structural analysis, such an approach should provide new insights into the history of linguistic change and contact in West Africa.

## **Acknowledgements**

We would like to thank the group on Areal Linguistic Features in Africa (ALFA) at UC Berkeley for their support and discussion, as well as for providing data on particular languages for our SAuxOV survey. ALFA members (other than the authors) include Larry Hyman, Emily Clem, Matthew Faytak, Jevon Heath, Maria Khachatryan, Spencer Lamoureux, Florian Lionnet, Jack Merrill, and Nicholas Rolle. Thanks also to our two reviewers for their feedback. Finally, we would like to thank the Guébie community and Rassidatou Konate, our Dafing consultant, for providing data discussed in this paper.



## Abbreviations

1	first person	NOM	nominative
2	second person	OBJ	object
3	third person	PART	particle
BY	before yesterday	PFV	perfective
COMPL	completive	PL	plural
DEF	definite	POST	postposition
FUT	future	PST	past
GEN	genitive	RED	reduplication
HAB	habitual	SG	singular
IPFV	imperfective	STAT	stative
IRR	irrealis	T.PST	today past
LOC	location	Y	yesterday
NMLZ	nominalizer		

## Appendix

A list of variables extracted for our survey from grammars and from linguists with expertise in the languages examined is given in Table 3. The survey was conducted primarily in multiple choice format via Google Forms, with the option of choosing multiple possible word orders per question. Space was provided after each question to leave additional comments or examples. The particular variables chosen are meant to determine the headedness properties of each language, along with which languages display mixed-headedness within the clause, which languages have a dedicated tense/aspect position immediately after the subject, and whether verb movement to the auxiliary position is possible.

The values of the six variables most relevant for the results presented in this paper are given in Table 4 and Table 5 for each language in our survey. A \* after the result means that the specified word order only occurs in the case of (nominalized) V complements of aspectual verbs. For further results and survey details, please contact the authors.

Table 3: Variables examined in the SAuxOV survey

Variable
1. Relative order of O and V in clauses containing auxiliaries
2. Relative order of adpositions and their object nouns
3. Relative order of Gen and N in a genitive construction
4. Relative order of S, Aux, O, and V in clauses containing auxiliaries
5. Relative order of manner adverb and V in clauses containing auxiliaries
6. Relative order of PP adjunct and non-locative V in clauses containing auxiliaries
7. Relative order of CP adjunct and V in clauses containing auxiliaries
8. Relative order of object pronoun and V in clauses containing auxiliaries
9. Relative order of NP/PP locative object and V in clauses containing auxiliaries
10. Relative order of CP objects and V in clauses containing auxiliaries
11. Relative order of V and multiple NP objects in clauses containing auxiliaries
12. Relative order of theme and goal in clauses containing auxiliaries
13. Relative order of pronoun and full NP objects in clauses containing auxiliaries
14. Whether it is possible for a sentence to lack an auxiliary
15. Relative order of S, V, and O when no auxiliary is present
16. Which inflectional categories auxiliaries can mark
17. Whether multiple auxiliaries are possible in the same clause
18. Whether there is an overt polar question marker
19. Relative order of polar question marker with S, Aux, O, and V
20. Position of Wh-words within Wh-questions
21. Whether negation is marked with an auxiliary or other overt marker
22. Position of non-auxiliary negative markers within the clause
23. Whether negation affects clausal word order when an auxiliary is present
24. Position of complementizers within embedded clauses
25. Whether objects can appear before auxiliaries (OAuxSV order)
26. Whether adverbs can occur before an auxiliary (AdvAuxSV order)

Table 4: Survey results

Language	1	2	3	4	5	15
Otoro	VO	Pre, Post	NG	SAuxVO	VAdv	SVOX
Guébie	OV	Post	GN	SAuxOV	AdvV	SVOX, SVXO
Mano	OV	Post	GN	SAuxOV	VAdv	SOVX
Bamana	OV	Pre, Post	GN	SAuxOV	AdvV, VAdv	SOVX
Mani	OV	Pre, Post	NG	SAuxOV	VAdv	SVOX
Godié	OV	Post	GN	SAuxOV	AdvV	SVOX, SVXO
Boko/Busa	OV	Post	GN	SAuxOV	VAdv	SOVX
Grebo	OV	Post	GN	SAuxOV		SVOX
Wobe	OV	Post	GN	SAuxOV	VAdv	SVOX
Krahn	OV	Post	GN	SAuxOV	VAdv	SVOX
Bobo	OV	Post	GN	SAuxOV	VAdv	SVOX
Bisa	OV	Post	GN	SAuxOV	VAdv	SVOX, SOVX
Dagbani	VO	Post	GN	SVO (no Aux)		SVOX
Jamsay	OV	Post	GN	SOVAux	AdvV	SOXV
Tafi	VO	Pre	NG	SAuxVO	VAdv	SVOX
Bwamu	VO	Pre, Post	GN	SAuxVO	AdvV	SVOX
Bariba	OV	Post	GN	SAuxOV		SVOX, SVXO
Mundang	VO	Pre	NG	SAuxVO	VAdv	SVOX
Koromfe	VO	Post	GN	SAuxVO	VAdv	SVOX
Gwari	OV, VO	Pre	GN	SAuxVO	VAdv	SVOX
Mambay	VO	Pre	NG	SAuxVO	VAdv	SVOX
Sereer	VO	Pre	NG	SAuxVO	VAdv	SVOX
Supyire	OV	Post	GN	SAuxOV	VAdv	SOVX
Esan	VO	Pre	NG	SAuxVO	AdvV	SVOX
Noni	VO	Pre	NG	SAuxVO	VAdv	SVOX
Hausa	VO	Pre	NG	SAuxVO	VAdv	SVOX

Table 5: Survey results (cont.)

Language	1	2	3	4	5	15
Koyraboro Senni	OV	Post	GN	SAuxOV	VAdv	SOVX
Tondi Songway	VO	Post	GN	SAuxOV	VAdv	SOVX
Kiini						
Dogon	OV	Post	GN	SOVAux	AdvV	SXOV
Mupun	VO	Pre	NG	SAuxVO	VAdv	SVOX
Pero	VO	Pre	NG	SAuxVO	VAdv	SVOX
Amharic	OV	Pre, Post	GN	SOVAux	AdvV	SOXV, SXOV
Maxi	VO	Pre	GN	SAuxVO	VAdv	SVOX
Degema	VO	Pre	NG	SAuxVO	VAdv	SVOX
Pulaar	VO	Pre	NG	SAuxVO	VAdv	SVOX
Mina	VO	Pre	NG	SAuxVO	VAdv	SVOX
Ma'di	OV	Post	GN	SAuxOV	AdvV, VAdv	SOVX
Dagaare	VO	Post	NG	SAuxVO	VAdv	SVOX
Khana	VO	Pre	NG	SAuxVO	VAdv	SVOX
Lango	VO	Pre	NG	SAuxVO	VAdv	SVOX
Kabba	VO	Pre, Post	NG	SAuxVO	VAdv	SVOX
Miya	VO	Pre	GN	SAuxOV, AuxOVS	VAdv	SVOX, VOXS
Banda-linda	VO	Pre	NG	SAuxVO	VAdv	SVOX
Fongbe	VO (OV in gerunds)	Pre, Post	NG	SAspOV*	VAdv	SVOX
Kalabari	OV	Post	GN	SOVAux	AdvV	SXOV
Akan	VO (OV in gerunds)	Post	GN	SAspOV*	VAdv	SVOX
Beria	OV	Post	GN	SOVAux	AdvV	SOXV, SXOV
Kenga	VO	Pre	NG	SAuxVO	VAdv	SVOX
Ngbaka	VO	Pre	NG	SAuxVO	VAdv	SVOX
Mbay	VO	Pre	NG	SAuxVO	VAdv	SVOX
Lele	VO	Post	NG	SAuxVO	VAdv	SVOX
Gouro	OV	Post	GN	SAuxOV, SAuxVO	VAdv	SVOX, SOVX
Lobiri	VO	Pre	GN	SAuxVO	VAdv	SVOX

## References

- Aboh, Enoch. 2004. *The Morphosyntax of complement-head sequences*. Oxford: Oxford University Press.
- Aboh, Enoch. 2005. Object shift, verb movement and verb reduplication. In Guglielmo Cinque & Richard Kayne (eds.), *The handbook of comparative syntax*, 138–177. New York: Oxford University Press.
- Aboh, Enoch. 2009. Clause structure and verb series. *Linguistic Inquiry* 40. 1–33.
- Aboh, Enoch. 2010. The Morphosyntax of the noun phrase. In Enoch O. Aboh & James Essegbey (eds.), *Topics in Kwa syntax*, 11–38. Dordrecht: Springer.
- Clements, George N. & Annie Rialland. 2008. Africa as a phonological area. In Bernd Heine & Derek Nurse (eds.), *A linguistic geography of Africa*, 36–85.
- Creissels, Denis. 2005. A typology of subject and object markers in African languages. In F. K. Erhard Voeltz (ed.), *Studies in African typology*, 43–70. Amsterdam/Philadelphia: John Benjamins.
- Creissels, Denis. 2017. Atypical objects in Soninke (West Mande). *Italian Journal of Linguistics* 29(1). 25–52.
- Creissels, Denis. 2019. Grammatical relations in Mandinka. In Alena Witzlack-Makarevich & Balthasar Bickel (eds.), *Argument selectors. a new perspective on grammatical relations*, 301–348. Amsterdam: John Benjamins.
- Diallo, Mohamadou. 1988. *Éléments de systématique et de dialectologie du Marka-Kan (Burkina faso)*. Université Stendhal - Grenoble III. (Doctoral dissertation).
- Dimmendaal, Gerrit J. 2008. Language ecology and linguistic diversity on the African continent. *Language and Linguistics Compass* 2(5). 840–858.
- Dryer, Matthew S. 1992. The Greenbergian word order correlations. *Language* 68. 81–138.
- Dryer, Matthew S. 2007. Word order. *Language typology and syntactic description* 1. 61–131.
- Dryer, Matthew S. 2013a. Order of Adposition and Noun Phrase. In Matthew S. Dryer & Martin Haspelmath (eds.), *The World Atlas of Language Structures Online*. Leipzig: Max Planck Institute for Evolutionary Anthropology. <http://wals.info/chapter/85>.
- Dryer, Matthew S. 2013b. Order of Genitive and Noun. In Matthew S. Dryer & Martin Haspelmath (eds.), *The World Atlas of Language Structures Online*. Leipzig: Max Planck Institute for Evolutionary Anthropology. <http://wals.info/chapter/86>.

- Good, Jeff. 2007. When arguments become adjuncts: Split configurationality in Leggbó. In J. E. Cihlar, A. L. Franklin, D. W. Kaiser & I. Kimbara (eds.), *Proceedings of CLS 39: Main session*, 110–129.
- Greenberg, Joseph H. 1963. Some universals of grammar with particular reference to the order of meaningful elements. In Joseph Greenberg (ed.), *Universals of language*, Cambridge, Massachusetts: MIT Press.
- Greenberg, Joseph H. 1966. *The languages of Africa*. Bloomington: Indiana University.
- Güldemann, Tom. 2008. The Macro-Sudan Belt: Towards identifying a linguistic area in northern sub-saharan Africa. In Bernd Heine & Derek Nurse (eds.), *A linguistic geography of Africa*, 151–185. Cambridge: Cambridge University Press.
- Güldemann, Tom. 2011. Proto-Bantu and Proto-Niger-Congo: Macro-areal typology and linguistic reconstruction. In Osamu Hieda, Christa König & Hiroshi Nakagawa (eds.), *Geographical typology and linguistic areas: with special reference to Africa*, 109–141. Amsterdam: John Benjamins.
- Hammarström, Harald & Sebastian Nordhoff. 2011. LangDoc: Bibliographic infrastructure for linguistic typology. *Oslo Studies in Language* 3(2). 31–43. <https://www.journals.uio.no/index.php/osla/article/view/75/199>.
- Heine, Bernd. 1976. *A typology of African languages, based on the order of meaningful elements*. Berlin: Dietrich Reimer.
- Hyman, Larry M. & Damiel J. Magaji. 1970. *Essentials of Gwari grammar* (Occasional publication 27). Ibadan: University of Ibadan-Institute of African Studies.
- Idiatov, Dmitry. 2000. Le sémantisme des marqueurs aspecto-temporels du bambara: Une tentative d'analyse. *Mandenkan* 36. 1–59.
- Ikoro, Suanu. 1996. *The Kana language*. Leiden: Research School CNWS, Leiden University.
- Innes, Gordon. 1966. *An introduction to Grebo*. London: School of Oriental & African Studies, University of London.
- Kandybowicz, Jason & Mark Baker. 2003. On directionality and the structure of the verb phrase: Evidence from Nupe. *Syntax* 6(2). 115–155.
- Kayne, Richard. 1994. *The antisymmetry of syntax*. Cambridge: MIT Press.
- Koopman, Hilda. 1984. *The syntax of verbs*. Dordrecht, The Netherlands: Foris Publications.
- Koopman, Hilda. 1992. On the absence of case chains in Bambara. *Natural Language & Linguistic Theory* 10(4). 555–594.

- Lefebvre, Claire & Anne-Marie Brousseau. 2002. *A grammar of Fongbe*. Berlin: Mouton de Gruyter.
- Manfredi, Victor. 1997. Aspectual licensing and object shift. In Rose-Marie Déchaine & Victor Manfredi (eds.), *Object positions in Benue-Kwa*, 87–122. The Hague: Holland Academic Graphic.
- Marchese, Lynell. 1979/1983. *Atlas linguistique des langues kru*. Université d'Abidjan: essai de typologie. ILA.
- Nikitina, Tatiana. 2009. The syntax of postpositional phrases in Wan, an “SOVX” language. *Studies in Language* 33(4). 910–933.
- Nikitina, Tatiana. 2011. Categorical reanalysis and the origin of the S-O-V-X word order in Mande. *Journal of African Languages and Linguistics* 32. 251–273.
- Prost, Pr. André. 1977. *Petite grammaire Marka*. Nouna-Dedougou: Diocèse de Nouna-Dedougou.
- Sande, Hannah. 2017. *Distributing morphologically conditioned phonology*. UC Berkeley. (Doctoral dissertation).





## Chapter 35

# Clicks on the fringes of the Kalahari Basin Area

Bonny Sands

Northern Arizona University

Hilde Gunnink

Ghent University

How do we define the limits of a linguistic area? Typologically rare features may spill out beyond the bounds of an otherwise well-defined linguistic area. Rather than viewing the “fuzzy” boundary of a linguistic area as a problem, it can instead be seen to be an integral part of the structure of the linguistic area which may include a core, “depleted core”, fringe and even areas beyond the fringe. Clicks are a typical feature of the Kalahari Basin linguistic area, but their patterning on the fringes of this area is not so well-known. Clicks have been borrowed into Bantu languages spoken on the fringes of the area, but their functional load, as measured by the number of click phonemes and frequency of clicks in the lexicon, is lower than in the languages of the core of the area. Clicks have also been borrowed into Bantu languages spoken beyond the fringe of the area, but the functional load of clicks in these ultimate recipients is very low. Processes of click loss, both in Bantu languages and Khoisan languages on the fringe, show the same geographical patterning. The geographical distribution of clicks in southern Africa can be compared to the situation in eastern Africa, where there is evidence for an old linguistic area including Hadza and Sandawe in its core and Dahalo in its fringe.

## 1 Introduction

It is well known that linguistic features may cluster in particular geographic regions. We argue that the functional load of a linguistic feature may also exhibit geographical patterning. The traditional reliance on binary feature oppositions in



areal linguistics limits the amount of linguistic patterning that may be detected. By looking at functional load, as we do here, or at inter-speaker variability in the use of a feature (as done by Kulkarni-Joshi 2016), more information about the historical processes of linguistic convergence and divergence in a particular geographical region can be revealed.

Clicks are an oft-cited example of a cross-linguistically rare feature that is shared across multiple language families. Clicks are one characteristic feature of the Kalahari Basin Area (KBA) which has been established as a linguistic area on the basis of morphosyntactic as well as phonological features (Güldemann 1998; 2013; Naumann & Bibiko 2016). Clicks have also spread from the core of the KBA to certain languages spoken on the fringe of the area. We estimate the functional load of clicks in the phoneme inventory and in the lexicon of languages of the KBA core and fringe and show that functional loads are lower in the fringe than in the core. We look at newly attested cases of click loss, showing that there is a geographical patterning to this process as well. Finally, we discuss the functional load of clicks in East African languages, which can be interpreted as evidence for an old linguistic area, where continued contact with clickless languages has resulted in a reduction of the functional load of clicks. By focusing on the fringes of a linguistic area, we gain insight into the processes that may characterize the area over both space and time.

## **2 Comparison of functional load of clicks: Core vs. fringe**

The Kalahari Basin Area (KBA) includes languages from three different families, Kx'a, Tuu and Khoe (formerly referred to as "Khoisan"). Geographically speaking, the area of the KBA is also infiltrated by Bantu languages, as well as English and Afrikaans. None of these are part of the linguistic area; although the Bantu languages encroaching on the KBA share some of its features, the similarities are too small to consider them true members of the area (Güldemann & Fehn to appear: 18). The core of the KBA is situated in south-eastern Botswana and the adjacent area in Namibia. The fringe of the area can be roughly defined as the zone geographically adjacent to the core, which contains languages belonging to two or more families which participate in the linguistic area, as well as many Bantu languages. The fringe of the KBA encompasses most of southern Africa, excluding eastern Zimbabwe and Mozambique (see Figure 1). Clicks, as one of the features of the KBA, occur in certain Bantu languages on the fringes of the KBA. Two main clusters of Bantu click languages can be distinguished on the fringes of the KBA: the South-West Bantu (SWB) click languages, spoken on the south-

western edge of the Bantu-speaking area, and the South-East Bantu (SEB) click languages, spoken on the southeastern edge of the Bantu-speaking area (Pakendorf et al. 2017). The SWB languages are Fwe, Manyo, Mbukushu, Kwangali and Yeyi, spoken on the border of Botswana, Zambia, Namibia and Angola, which is the northern fringe of the KBA. The SEB languages include the Nguni languages Zulu, Xhosa, Swati, Ndebele and Phuthi, and the Sotho language Southern Sotho, and are spoken in South Africa, Swaziland, Lesotho and in western Zimbabwe, which is part of the southeastern fringe of the KBA. Certain Bantu languages are also spoken inside the core of the KBA, such as Tswana, Kgalagadi and Herero, though none of these make use of clicks as a regular phoneme.<sup>1</sup>

It has long been recognized that clicks in Bantu languages are the result of contact with Khoisan languages (Bleek 1862). For the SEB languages, the acquisition of clicks appears to be the result of contact with Khoekhoe mainly, but possibly also with one or more Tuu languages (Pakendorf et al. 2017). For the SWB languages, contact has mainly taken place with Ju varieties and with Khwe (Gunnink et al. 2015). There are different processes that have led to the incorporation of clicks: for the SEB languages, it has been argued that the borrowing of clicks was facilitated by the practice of *hlonipha*, a taboo for married women to pronounce words that resemble the names of their male in-laws (Herbert 1990). Among speakers of the SWB languages, however, the practice of *hlonipha* is unknown: for these languages, the incorporation of clicks may have been motivated by sound symbolism (Bostoen & Sands 2012). Language shift from Khoisan to Bantu has also played a role, specifically from Khoisan-speaking women marrying into Bantu society (Pakendorf et al. 2011), coupled with a certain prestige attached to language of the Khoisan speakers, and the use of clicks to flag a separate identity (Gunnink et al. 2015).

That the functional load of clicks in the phonemic inventory and in the lexicon of different click languages varies widely across languages has been previously noted (Güldemann & Stoneking 2008). Naumann & Bibiko (2016) show that the presence of clicks, and of an inventory of more than three basic click types is characteristic of the KBA. We use different metrics to measure functional load and how it varies between languages of the core vs. those of the fringe of the Kalahari Basin Area, as described below.

Languages of the core of the KBA typically use at least four different click types, i.e. dental, alveolar, palatal and lateral. Some also use a fifth click type,

---

<sup>1</sup>For Kgalagadi, marginal clicks have been reported (Dickens 1987: 298, Lukusa & Monaka 2008: 10), as well as for the Ngwato dialect of Tswana (Tale 2005: 209-210). It is possible that these languages used to have more substantial click inventories in the past, but more research is needed to verify this possibility (Pakendorf et al. 2017).

the bilabial. This contrasts sharply with the fringe languages, many of which only use one click type, most commonly the dental; other fringe languages use two or three contrastive click types. Botswana Yeyi is the fringe language that is geographically closest to the core of the KBA and also the only fringe language to use four contrastive click types. (See Table 1 for an overview.)

The number of click consonants in a language depends on the contrasts made involving click types with various click accompaniments, i.e. particular laryngeal, nasal and dorsal release features). We follow a unitary analysis of clicks whereby, /l, lq, lq<sup>h</sup>/, for example, are considered to be three distinct consonants, rather than a cluster analysis which would see these as a single click (/l/) which may occur in clusters with obstruents /q/ and /q<sup>h</sup>/. See Bradfield (2014) for a discussion of unitary vs. cluster analyses.

In core languages we see as many as 75–80 click phonemes (#Hoan and !Xoon, respectively). Within the core languages, there are differences in the size of the click inventories of different languages: Kua and Shua, spoken on the eastern edge of the core area, use between 20 and 30 click phonemes, and Khoekhoe, spoken on the western edge of the core area, uses only 20 click phonemes. Despite these differences within the core area, click inventories of fringe languages are significantly smaller. Many fringe languages use fewer than 10 click phonemes; between 10 and 20 click phonemes are found in Namibian Yeyi and the Nguni languages. Southern Sotho only has three click phonemes, which may be related to the hypothesis that Southern Sotho did not acquire clicks directly from Khoisan languages, but as a result of contact with Nguni languages, as many Southern Sotho click words are shared with Nguni (Bourquin 1951; Doke & Mofokeng 1957: 23).<sup>2</sup> The largest click inventory is found in Botswana Yeyi, which uses 22 contrastive clicks. It should be noted, however, that Botswana Yeyi is a moribund language displaying some phonetic irregularity, and firm evidence for the phonemic status of all 22 clicks cannot be given (Fulop et al. 2003). The differences in the size of the click inventory between core and fringe languages listed in Table 1 is illustrated in Figure 1.

Another parameter by which the functional load of clicks can be measured, the occurrence in the lexicon, also yields different results for core and fringe languages. In Bantu fringe languages, the percentage of the lexicon in which clicks occur ranges from 1 to 17%. In all the core languages, more than 50% of

---

<sup>2</sup>Sotho-Tswana peoples are believed to have migrated to southern Africa more recently than Nguni-speaking populations (Pakendorf et al. 2017: 31) and thus would have had a shorter period of contact with speakers of click languages, perhaps accounting for the smaller functional load of clicks in Sotho-Tswana languages than Nguni, despite their relative proximity to the KBA.

Table 1: The functional load of clicks in core and fringe languages. Numbers are rounded to the nearest integer.

Language	click types	click phonemes	percentage of lexicon	percentage of basic lexicon
<b>Core</b>				
†Hoan	5	75	64%	52%
Jul'hoan	4	47	69%	68%
Khoekhoe	4	20	72%	66%
Naro	4	28	64%	62%
N uu	5	45	86%	77%
!Xoon	5	80	73%	82%
G ui	4	52	71%	56%
Kua	4	26	58%	55%
Shua	4	29	<i>a</i>	33%
Tsua	4	34	56%	37%
<b>Southern fringe (SEB)</b>				
Zulu	3	15	14%	7%
Xhosa	3	18	17%	10%
Southern Ndebele	2	8	7%	5%
Zimbabwean Ndebele	3	15	8%	6%
Swati	1	4	12%	5%
Phuti	3	12	8%	8%
Southern Sotho	1	3	3-5%	0%
<b>Northern fringe (SWB)</b>				
Namibian Yeyi	2	12	10%	6%
Botswana Yeyi	4	22	15%	8%
Manyo	1	5	1%	1%
Kwangali	1	5	2%	0%
Mbukushu	1	4	<1%	0%
Fwe	1	4	<1%	1%

Sources: SEB and SWB languages: Pakendorf et al. (2017), and sources cited therein. †Hoan: Collins & Gruber (2014), Gruber (1975). Jul'hoan: Dickens (1994), Miller-Ockhuizen (2003). Khoekhoe: Brugman (2009: 47), Haacke & Eiseb (2002). Naro: Visser (2001; 2013). N|uu: Miller (2014), Miller et al. (2009), Miller et al. (2007). !Xoon: Traill (1985; 1994). G|ui: Nakagawa (1996; 2013). Kua: Chebanne & Collins (2014). Tsua: Mathes (2016), Chebanne & Mathes (2013). Shua: Fehn, personal communication, Vossen (2013).

<sup>a</sup>As no full lexicon for Shua is available, the percentage of clicks in the lexicon cannot be given.

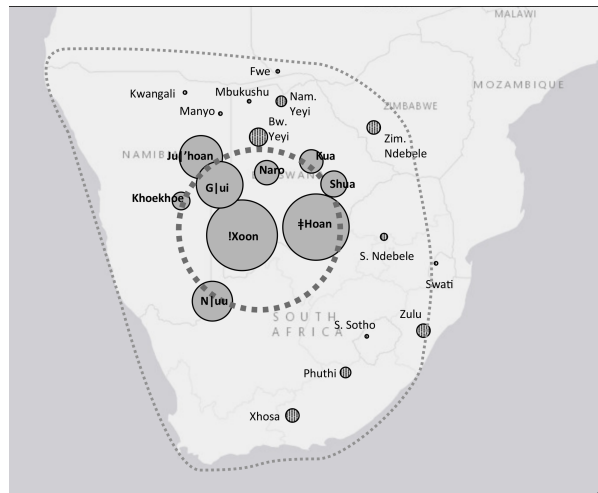

Figure 1: Map showing the relative sizes of click inventories of languages of the core and fringe of the Kalahari Basin Area (based on data in Table 1). (The sizes of filled circles are proportional to the number of click phonemes in each language. The fringe is enclosed by a dotted line, the core by a thicker dashed line. Bantu languages are shown with striped circles; other languages are shown with solid circles.)

the lexicon contains a click. This difference is illustrated in Figure 2. The functional load of clicks may also be estimated, as Idiatov & Van de Velde (2016) do for labial-velar stops. They compare the expected occurrence of each consonant with the actual occurrence, presupposing that each C phoneme occurs with equal frequency. This measure tends to heighten differences between the core and the fringe, e.g. 63% of Nluu consonants are clicks but they occur in 86% of the lexicon; while 29% of Zulu consonants are clicks, they occur in only 14% of the lexicon.

The percentage of clicks in the basic lexicon also differs between core and fringe languages, as shown in Figure 3. Using a version of the Swadesh-100 list of basic vocabulary (Holman et al. 2008), we counted a much higher percentage of click words in basic vocabulary in core languages than in fringe languages. Furthermore, in the core languages, the percentage of clicks in the overall lexicon and the percentage of clicks in basic vocabulary does not differ significantly, whereas in some of the fringe languages, i.e. Zulu, Xhosa and Botswana Yeyi, the percentage of click words in the basic vocabulary is significantly lower than in the overall lexicon. This is probably the result of lexical borrowing, which is less likely to affect basic vocabulary. In the SWB languages, borrowings from Khoisan languages are mainly found in restricted, specialized semantic domains related to the natural environment and a foraging lifestyle (Gunnink et al. 2015).

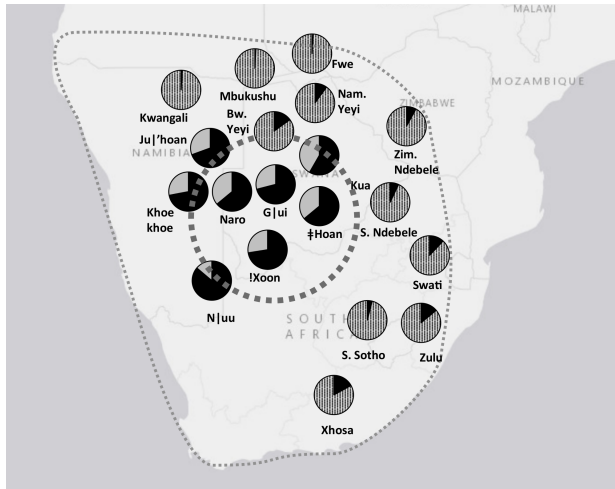

Figure 2: Map with pie charts showing the functional load of clicks in the lexicon in languages of the core of the KBA and on its fringe. The percentage of clicks is shown by the solid dark color. Circles representing Bantu languages have a stippled pattern.

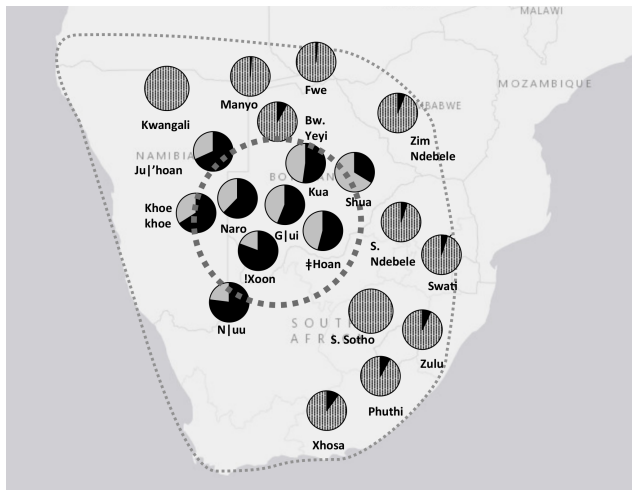

Figure 3: Map with pie charts showing the functional load of clicks in the basic vocabulary of languages of the core of the KBA and on its fringe. The percentage of clicks is shown by the solid dark color. Circles representing Bantu languages have a stippled pattern.

The relative functional load of a feature can be a strong indicator of the source language(s) of the feature. The functional load of clicks in Bantu languages is much lower than it is in Khoe, Kx'a and Tuu languages. The average percentage of words with clicks is more than 8 times as high in the lexicons of core KBA languages (68%) as it is in the languages of the fringe (8%) listed in Table 1. Differences in percentages of clicks in lexicons of core KBA language families are relatively minimal, i.e. Kx'a (67%), Tuu (80%) and Khoe (64%). Another example of features borrowed across language families are labial-velar stops, e.g. from Ubangian into Bantu. These phonemes also have a higher functional load in the source languages than in the recipient languages: the percentage of words with labial-velar stops twice as high in the lexicons of Ubangian languages Ngbaka (18%) and Ngbandi (17%) as it is in the neighboring Bantu language Lingombe (9%) (Bostoen & Donzo 2013).

### 3 Click loss in fringe languages

The functional load of clicks not only differs from one language to the next, but variation can also occur across dialects of a single language. We now discuss a number of cases of Bantu languages on the fringe of the KBA where one of their varieties has undergone click loss, leading either to the complete loss of the feature of clicks or to a reduction in its functional load.

Fwe is one of the SWB click languages spoken on the northern fringe of the KBA. Clicks in Fwe have a low functional load; only four click phonemes are distinguished, and clicks have so far been found in about 80 vocabulary items, none of which are basic vocabulary. Fwe has a northern variety, spoken in the Sinjembela area of Zambia, and a southern variety, spoken in the Zambezi region (formerly known as Caprivi strip) in Namibia. Clicks only occur in the southern variety of Fwe. The northern variety does not use clicks, but uses a velar consonant where the southern variety uses a click.<sup>3</sup>

- (1) kù-ʘ|ânk-à Southern Fwe  
kù-ŋânk-à Northern Fwe  
'to shell groundnuts'
- (2) rù-|ɔ́ mà Southern Fwe  
rù-kómà Northern Fwe  
'papyrus'

---

<sup>3</sup>Many Bantu languages do not use IPA symbols in their official orthographies, but transcribe clicks with the letters <c>, <q> and <x>. Throughout this paper, we transcribe all clicks using the IPA symbols, even where this deviates from the source or the official orthography of the language.



The correspondences in (1-2) could be explained as either click loss in the northern variety or as click insertion in the southern variety. Gunnink (to appear) argues that click loss is the more likely explanation, as can be seen from the form of lexemes that use a click in Southern Fwe, but have a Bantu reconstruction without a click. The original consonant has been replaced by a click at some point in the history of Fwe, such as the southern Fwe word -*ŋùm-ùn-à* ‘to pull out, uproot’. This word is of Bantu origin, as attested by the reconstruction *\*-túmɔd-* ‘take firewood from fire, tear asunder’ (Bastin et al. 2002), and reflexes in Bantu languages related to Fwe such as Tonga *-fum-un-a* ‘pull out as grass from thatch’ (Torrend 1931: 117). The expected reflex in Fwe would be *-sùm-ùn-à*, as Proto-Bantu *\*t* followed by a high back vowel regularly changes to /s/ in Fwe (Bostoen 2009: 118). In northern Fwe, however, this word is realized as *-ŋùm-ùn-à*. The use of /ŋ/ rather than /s/ in the northern Fwe form can only be explained as a change from the nasal click. This shows that northern Fwe, too, must have used clicks in the past, but lost them later, probably as the result of the lack of contact with speakers of other click languages. Northern Fwe is in extensive contact with Lozi, a clickless Bantu language, as well as Kwamashi and Shanjo, also Bantu languages that do not use clicks. Southern Fwe, however, is in contact with Yeyi, a Bantu language in which clicks have a higher functional load than in Fwe, and also with the Khoe-Kwadi language (Caprivi-)Khwe. The continued contact between southern Fwe and languages in which clicks have a high functional load has helped this variety to maintain its clicks.

Another example of click loss is seen in Yeyi, a Bantu click language spoken on the northern fringe of the KBA. Like Fwe, Yeyi has two varieties, a Namibian variety spoken in the Zambezi region (former Caprivi strip), and a Botswana variety spoken in Ngamiland. Although both varieties use clicks, the functional load of clicks in Botswana Yeyi is higher than in Namibian Yeyi (Table 2).

Table 2: Functional load of clicks in Yeyi

	# of click types	# of click phonemes	% of clicks in vocabulary	% of clicks in basic vocabulary
Botswana Yeyi	4	22	15%	10.4%
Namibian Yeyi	2	12	10%	5.6%

As Namibian Yeyi has fewer click types than Botswana Yeyi, it has merged certain click types: examples (3–4) show that both palatal and dental clicks in Botswana Yeyi correspond to dental clicks in Namibian Yeyi.

- (3) *kù-/hàkà* Botswana Yeyi  
*kù-/hàkà* Namibian Yeyi  
'to chop' (Lukusa 2009: 10; Seidel 2008: 41)
- (4) *kù-í-#hòà* Botswana Yeyi  
*ku-i-/hoa* Namibian Yeyi  
'to slap' (Seidel 2008: 41; Sommer & Voßen 1992: 34)

Click loss, where clicks in Botswana Yeyi correspond to non-clicks in Namibian Yeyi, is also attested, as shown in example (5), which shows that a click in Botswana Yeyi can correspond to a non-click velar in Namibian Yeyi.

- (5) *kù-ì-g'ámàni* Botswana Yeyi  
*kù-ì-khyàmínà* Namibian Yeyi  
'to throw' (Seidel 2008: 43; Sommer & Voßen 1992: 32)

Botswana Yeyi is spoken much closer to the core of the Kalahari basin area than Namibian Yeyi, and as such is in contact with languages where clicks have a high functional load; this may have helped the language maintain its click inventory. Namibian Yeyi, on the other hand, is mainly in contact with Bantu languages with fewer clicks, such as Fwe and Mbukushu, or no clicks, such as Lozi, Subiya and Totela. This contact situation may have prompted Namibian Yeyi to simplify its click inventory.

Click loss also occurs in Bantu click languages spoken on the southeastern fringe of the KBA. The Nguni language Ndebele has three varieties: southern Ndebele, spoken in the Mpumalanga province of South Africa, Zimbabwean Ndebele, spoken in eastern Zimbabwe, and northern Ndebele, spoken in the Limpopo province of South Africa. Southern and Zimbabwean Ndebele use clicks, but clicks have been lost in northern Ndebele, where they have been replaced by velar non-click consonants. This click loss must have taken place recently: at the time of Ziervogel's (1959) research, some speakers of northern Ndebele still used clicks in certain plant names, but a later study (Skhosana 2009) found that these too had been replaced by velar non-clicks. Recently, however, northern Ndebele appears to have reborrowed clicks, probably as a result of contact with Zulu (Schulz & Laine 2016).

Another case where contact did not lead to the loss of clicks, but to a decrease in their functional load, is seen in the variety of Zulu spoken in Soweto. Soweto is an urban area south of Johannesburg where extensive language contact, especially between Zulu and Sotho, has led to the creation of an urban register that deviates in certain aspects from the standard language. One of these deviations is

the simplification of its click inventory, specifically the loss of contrast between dental and postalveolar clicks. These click types are contrastive in standard Zulu, but are used as free allophones in Sowetan Zulu. For example, the word *-ela* ‘request’, which has a dental click in standard Zulu, can be realized as either *lela* or *-lela* in Sowetan Zulu; similarly, the word *-lala* ‘start’, which has a postalveolar click in standard Zulu, can be realized as either *-lala* or *-lala* in Sowetan Zulu (Gunnink 2014: 164-165). This merger is likely to be motivated by contact with Sotho, which has only one click type, the postalveolar click. Contact with other, clickless Bantu languages may also have played a role, such as Pedi and Tswana. Sowetan Zulu is widely spoken as a second language by migrants with very diverse linguistic backgrounds, including many languages with no or fewer click contrasts than standard Zulu, which may also have played a role in the reduction of the functional load of its click inventory.

Although click loss may occur as the result of regular sound change, as is attested in for instance the loss of a contrastive retroflex click type in northern and southern Ju languages (cf. Sands 2010), language contact seems to play the crucial role in these Bantu languages. Just as Bantu languages have acquired clicks through contact with languages in which clicks have a higher functional load, in the same way, they appear to reduce or lose their click inventories when they come in contact with languages in which clicks have a lower functional load, or are absent altogether. In addition to contact, however, prestige also plays a role: clicks may be discarded in areas where these sounds are associated with Khoisan speakers, who generally have a much lower social position than Bantu speakers (Wilmsen & Vossen 1990).

#### 4 Clicks beyond the fringe of the Kalahari Basin Area

Clicks have not only spread from the core of the KBA to its fringe, but from the fringe to languages yet more geographically removed from the KBA, as shown in Figure 4. The functional load of clicks in Bantu languages of eastern Zimbabwe, Mozambique and Malawi is low. They occur mainly in borrowings and ideophones. The Changana variety of Tsonga has three click phonemes and 142 words with clicks (Siteo 1996). Other lects seem to have fewer click words. Certain varieties of Karanga, spoken in the Midlands of Zimbabwe, are reported to have a small number click words, such as *mù/irò* ‘whip’, *-ùḅà* ‘rinse mouth’ and *mà-ìmbí* ‘edible caterpillars’ (Pongweni 1990), but the total number of words in the lexicon with clicks is unknown.

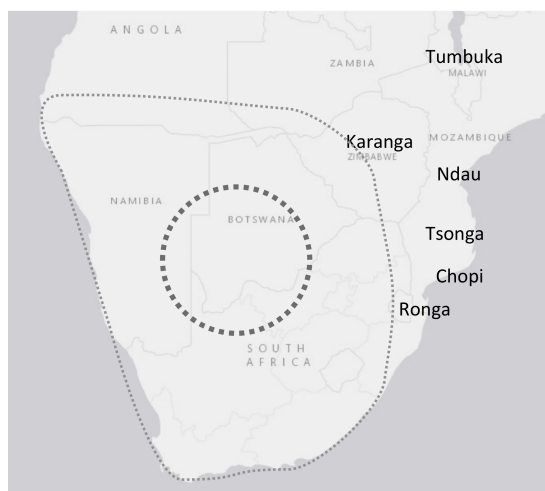

Figure 4: Map showing Bantu languages immediately outside of the Kalahari Basin Area fringe in which clicks occur as (marginal) phonemes

In the Mzimba variety of Tumbuka, spoken in Malawi, clicks occur in certain place names. These clicks correspond to alveolar ejectives in the Nkhamanga variety of Tumbuka, which lacks clicks: the Mzimba place name *!aba* is known as *t'afa* in Nkhamanga, and the Mzimba name *Engu/wini* as *Ngut'wini* in Nkhamanga (Moyo 1995).

In Ndaou as described by Borland (1970), certain words with clicks can be found, most of which are traceable to Zulu, such as *ku-g!oka* 'wear clothes' (Borland 1970: 32), from Zulu *-g!oka* 'wear, put on' (Doke et al. 1958: 85). There is some instability in the pronunciation of clicks in Ndaou: lateral clicks alternate with dental and alveolar clicks, i.e. *chi-!embo* ~ *chi-lembo* 'spoon', or *n!wadi* ~ *n/wadi* 'book'. Clicks also alternate with velar non-clicks, i.e. *chi-g!ogo* ~ *chi-gogo* 'hat' (Borland 1970: 30). Other descriptions of Ndaou, such as Doke (1931), do not mention clicks, suggesting either that they are recently acquired or only found in specific dialects.

Clicks in these Bantu languages beyond the fringe of the KBA are not the result of direct contact with core languages, but of contact with fringe languages. The functional load of clicks in Bantu languages beyond the fringe is even lower than in fringe languages, showing that with each transmission, the functional load of clicks was reduced. In many languages, the relatively high prestige of the donor language may have facilitated the adoption of clicks.

The donor languages are likely to be Nguni languages: many click words have Nguni etymologies, and contact is either ongoing or historically attested. In the case of Ndaou, Tsonga, Chopi and Ronga, the likely donor language appears to be Zulu, a language with more than 10 million native speakers and an equal number of second language speakers, and a relatively high prestige. This prestige may have facilitated the introduction of clicks in certain languages. In the case of Karanga, clicks are likely to be the result of contact with Zimbabwean Ndebele, the main language of western Zimbabwe. For Tumbuka, the use of clicks appears to be the result of contact with Ngoni, the language of the former ruling class of the Tumbuka. Ngoni was a Nguni language spoken by a group of migrants that fled South Africa in the nineteenth century as a result of the political upheaval of the Mfecane. They ultimately settled in eastern Africa, where they came into contact with Tumbuka speakers. Although the Ngoni language is no longer spoken in Malawi today, its influence on some varieties of Tumbuka is still seen in the use of clicks, as well as other phonological features (Moyo 1995).

## 5 Clicks in Khoisan fringe languages

Up to now, we have emphasized the relatively low functional load of clicks in Bantu languages as compared to languages of the core of the Kalahari Basin Area. In this section, we show cases of click loss in non-Bantu languages. Click loss has been documented primarily on the fringes of the KBA, but has affected each of the three families which participate in the linguistic area (Khoe-Kwadi, Tuu, Kx'a), as shown in Figure 5. We are primarily concerned here with the loss of contrastive click types, as this determines the number of click types and click phonemes in each language. Because the lexical documentation of these languages is very uneven, we will not attempt a comparison of the functional load of clicks in their lexicons.

Many Khoe-Kwadi languages have been affected by click loss (Traill & Vossen 1997). Kwadi, just beyond the fringe of the KBA,<sup>4</sup> has lost all Proto-Khoe-Kwadi click types but the dental (Fehn to appear[a]). East Kalahari Khoe languages such as Tshwao and Shua have lost both palatal and alveolar click types, while Khwe has lost only alveolar clicks (Fehn to appear[a]). Tsua has full sets of accompaniments for dental and lateral clicks (11 phonemes per click type) but only 5 alveolar and 7 palatal click phonemes (Mathes 2016). In contrast, G|ui and Naro in the core of the KBA have retained all Proto-Khoe click types, and all click types

---

<sup>4</sup>We have placed Kwadi just outside the fringe because it is geographically further from the other languages and also because the functional load of clicks is comparatively low.

occur with the same set of accompaniments. Click loss is sporadic but affects all click types in Sesfontein Damara (Job 2014), a dialect of Khoekhoe. Interestingly, click loss was previously reported to occur in Sesfontein in an undocumented San language known as Kubun (||Ukun) (van Warmelo 1951: 45).

Click loss in the Kx'a languages Jul'hoan and †Hoan is much less extensive than than seen in Mupa !Xuun. Proto-Kx'a is reconstructed with a contrastive retroflex click \*! which has been lost in all daughter languages apart from Central Ju lects (Heine & Honken 2010; Sands 2010). In addition to the loss of \*!, Mupa !Xuun is in the process of losing most palatal and alveolar clicks (with the exception of those with nasalized, glottalized, delayed aspirated accompaniments which are generally retained) (Fehn to appear[b]). Palatal clicks and alveolar clicks are replaced by alveolar and velar non-clicks, respectively (Fehn to appear[b]). Click loss in the speech of young people speaking varieties of !Xuun in southern Angola appears to go back some generations (Bleek 1928; Traill & Vossen 1997).

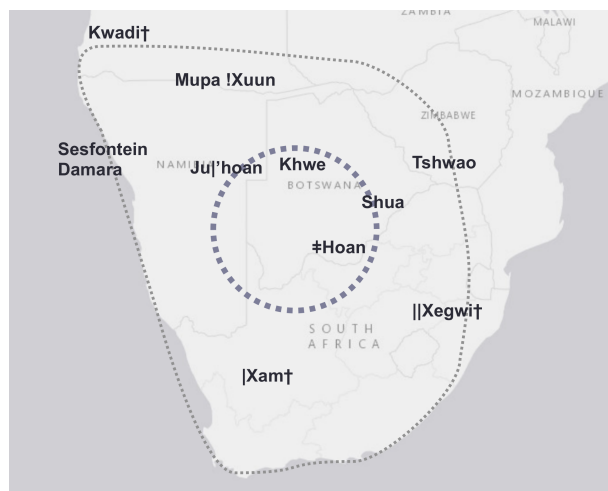

Figure 5: Map showing Non-Bantu languages which have lost click contrasts: Kwadi, Sesfontein Damara, Khwe, Shua, Tshwao (Khoekwadi); Mupa !Xuun, Jul'hoan, †Hoan (Kx'a); !Xam, ||Xegwi (Tuu)

In the southern fringe of the KBA, some Tuu languages of the !Ui subgroup show signs of click loss. ||Xegwi lost Proto-!Ui palatal and alveolar clicks, but reborrowed the latter from Swati (Sands 2014; Traill & Vossen 1997). !Xam merged some or all Proto-!Ui palatal clicks with alveolars, but reborrowed palatal clicks from Khoekhoe (Sands 2014).

In these non-Bantu languages, loss of clicks generally increases with distance from the core of the KBA, suggesting the process may be accelerated by contact with non-KBA languages. Languages in the north came into contact with Bantu languages earlier than those to the south, and we see a higher rate of click loss in the north as compared to the south. Click loss need not be indicative of divergence from the KBA; the loss of retroflex clicks in core languages Jul'hoan and #Hoan may be considered a convergence toward the KBA, since Khoe and Tuu languages do not have retroflex clicks. Different types of click loss must be attributed to different historical contact patterns.

The presence of clicks outside of the KBA in the non-Bantu languages raises the likelihood that the geographical extent of the KBA was once greater than it is today. We distinguish the former presence of a larger linguistic area outside of the present-day core and label it a depleted core. In the case of Bantu languages on the fringe of the KBA, the presence of clicks appears to be a feature which has bled out from the core. With the depleted core languages, clicks have shown signs of fading away with greater distance from the core, particularly to the north of the present-day core. Thus, a geographical fringe may be comprised of both a depleted region and an overlapping region into which a feature has spread.

## 6 Clicks in East Africa

There are three click languages in East Africa, as shown in Figure 6: Hadza (isolate), Dahalo (Cushitic) and Sandawe (which has a tentative link to Khoe-Kwadi, Güldemann & Elderkin 2010). We look at the functional load of clicks in these languages and compare them to the languages of the Kalahari Basin.

With three contrastive click types, Hadza and Sandawe are similar to KBA fringe languages Zulu and Xhosa; Dahalo has only one contrastive click type, similar to fringe languages such as Fwe. The number of click phonemes in these languages is also comparable to those of the KBA fringe, ranging from 4 phonemes (/ǀ, ǁ, ǁ<sup>w</sup>, ǁ<sup>w</sup>/) in Dahalo (Maddieson et al. 1993), to 12 in Hadza (Miller et al. 2012) and 15 in Sandawe (Elderkin 2013; Hunziker et al. 2008).

The frequency of clicks in the lexicon is similar in Sandawe (21%) and Hadza (18%), but much lower in Dahalo (3%) (based on hand counts of words in Miller et al. 2012, Ten Raa 2012, Tosco 1991). These frequencies are similar to frequencies seen in the fringe of the KBA. Rates of clicks in basic vocabulary are shown in Figure 6. The functional load of clicks in the basic vocabulary of Sandawe (37%) and Hadza (16%) however, is higher than that seen in any Bantu language.

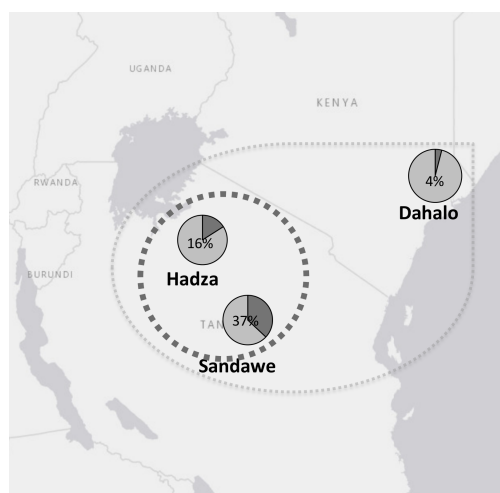

Figure 6: Map of East African click languages showing the percentage of clicks in basic vocabulary. The proposed (depleted) core is enclosed by a heavy dashed line, the fringe by a dotted line.

Unlike most languages of the KBA fringe, populations speaking these languages have been isolated from speakers of other click languages for multiple generations, as shown by genetic evidence (cf. Schlegel et al. 2012, Soi 2015). It seems likely that clicks in all of these languages once had a higher functional load than they do at present, and that continued contact with clickless languages has reduced their functional load, similar to what is seen in southern Africa. If East African click languages once formed a linguistic area, the functional load of clicks suggests that Hadza and Sandawe are part of a depleted core and Dahalo is part of its fringe.

## 7 Conclusion

In this paper, we have examined the distribution of clicks, one of the features of the Kalahari Basin linguistic area, on the fringes of the area. By considering the functional load of this feature, rather than merely its presence or absence, we have been able to reveal considerable substructuring of the linguistic area, distinguishing a core of the area, a depleted core, and a fringe. Weak signals of the area can even be detected beyond the fringe. The functional load of the feature of clicks diminishes with distance from the core of the area, and appears to diminish with each transmission.



We have discussed cases where clicks are used in a specific variety of a language, but are absent in others, or where different varieties differ in the functional load of clicks. Clicks can be acquired through contact with languages where clicks have a higher functional load, but clicks can also be lost through contact with languages where clicks are absent or have a lower functional load. Furthermore, the differences in click inventory between closely-related varieties of the same languages underscore the need for dialect studies, which may elucidate the processes by which these features are acquired and lost.

Finally, we have suggested that differences in the functional load of a linguistic feature may be useful in identifying old linguistic areas. Outside of the Kalahari Basin Area, we have seen that the functional load of clicks is relatively higher in Hadza and Sandawe than it is in Dahalo, a pattern that is reminiscent of the relative functional load of clicks in the core vs. the fringe of the Kalahari Basin Area.

## Acknowledgments

We thank Koen Bostoen, Brigitte Pakendorf, Anne-Marie Fehn, Richard Bailey, Kirk Miller, and Will Grundy for their assistance.

## References

- Bastin, Yvonne, André Coupez, Evariste Mumba & Thilo C. Schadeberg. 2002. *Bantu lexical reconstructions 3*. Tervuren: Royal Museum for Central Africa.
- Bleek, Dorothea F. 1928. Bushmen of Central Angola. *Bantu Studies* 3. 105–125.
- Bleek, Wilhelm H. I. 1862. *A comparative grammar of South African languages*. London: Trübner & Co.
- Borland, Colin Hugh. 1970. *Eastern Sshona: A comparative dialect study*. University of Cape Town. (Doctoral dissertation).
- Bostoen, Koen. 2009. Shanjo and Fwe as part of Bantu Botatwe: A diachronic phonological approach. In Akinloye Ojo & Lioba Moshi (eds.), *Selected proceedings of the 39th Annual Conference of African Linguistics*, 110–130. Somerville: Cascadilla Proceedings Project.
- Bostoen, Koen & Jean-Pierre Donzo. 2013. Bantu-Ubangi language contact and the origin of labial-velar stops in Lingombe. *Diachronica* 30(4). 435–468.

- Bostoën, Koen & Bonny Sands. 2012. Clicks in south-western Bantu languages: Contact-induced vs. language-internal lexical change. In Matthias Brenzinger & Anne-Maria Fehn (eds.), *Proceedings of the 6th World Congress of African Linguistics, Cologne, 17–21 August 2009*, 121–132. Rüdiger Köppe.
- Bourquin, W. 1951. Click-words which Xhosa, Zulu and Sotho have in common. *African Studies* 10. 59–81.
- Bradfield, Julian. 2014. Clicks, concurrency and Khoisan. *Phonology* 31. 1–49.
- Brugman, Johanna. 2009. *Segments, tones and distribution in Khoekhoe prosody*. Ithaca: Cornell University. (Doctoral dissertation.)
- Chebanne, Andy & Chris Collins. 2014. *Kua lexicon*. Ms. University of Botswana & New York University.
- Chebanne, Andy & Timothy K. Mathes. 2013. *Tsua lexicon*. Ms. University of Botswana & New York University.
- Collins, Chris & Jeff Gruber. 2014. *A grammar of #Höã*. Cologne: Rüdiger Köppe.
- Dickens, Patrick. 1987. Qhalaxarzi consonants. *African Studies* 46(2). 297–305.
- Dickens, Patrick. 1994. *English-Jul'hoan, Jul'hoan-English dictionary*. Köln: Rüdiger Köppe.
- Doke, Clement M. 1931. *A comparative study of Shona phonetics*. Johannesburg: Witwatersrand University Press.
- Doke, Clement Martyn, D. McK. Malcolm & J. M. A. Sikakana. 1958. *English and Zulu dictionary*. Johannesburg: Witwatersrand University Press.
- Doke, Clement Martyn & S. Machabe Mofokeng. 1957. *Textbook of Southern Sotho grammar*. Cape Town: Longmans.
- Elderkin, Edward D. 2013. Phonetics and phonology: Sandawe. In Rainer Vossen (ed.), *The Khoesan languages*, 42–45. New York: Routledge.
- Fehn, Anne-Maria. to appear(a). Click loss in Khoe-Kwadi. In Bonny Sands (ed.), *The handbook of clicks*. Leiden: Brill.
- Fehn, Anne-Maria. to appear(b). Click replacement and loss in Ju. In Bonny Sands (ed.), *The handbook of clicks*. Leiden: Brill.
- Fulop, Sean A., Peter Ladefoged, Fang Liu & Rainer Vossen. 2003. Yeyi clicks: Acoustic description and analysis. *Phonetica* 60. 231–260.
- Gruber, Jeffrey S. 1975. *Bushman languages of the Kalahari: #Hoan-vocabulary-stems*. Technical project report to the National Endowment for the Humanities, Washington, D.C.
- Güldemann, Tom. 1998. The Kalahari Basin as an object of areal typology: A first approach. In Mathias Schladt (ed.), *Language, identity and conceptualisation among the Khoisan*, 137–169. Cologne: Rüdiger Köppe.

- Güldemann, Tom. 2013. Typology. In Bonny Sands (ed.), *The Khoesan languages*, vol. 25, 25–37. London: Routledge.
- Güldemann, Tom & Edward D. Elderkin. 2010. On external genealogical relationships of the Khoe family. In Matthias Brenzinger & Christa König (eds.), *Khoisan languages and linguistics: Proceedings of the 1st International Symposium, January 4–8, 2003, Riezlern/Kleinwalsertal*, 15–52. Cologne: Köppe.
- Güldemann, Tom & Anne-Maria Fehn. to appear. The Kalahari Basin Area as a ‘Sprachbund’ before the Bantu expansion: An update. In Raymond Hickey (ed.), *The Cambridge handbook of areal linguistics*. Cambridge: Cambridge University Press.
- Güldemann, Tom & Mark Stoneking. 2008. *A historical appraisal of clicks: a linguistic and genetic population perspective*. Vol. 37.
- Gunnink, Hilde. 2014. The grammatical structure of Sowetan tsotsitaal. *Southern African Linguistics and Applied Language Studies* 32(2). 161–171.
- Gunnink, Hilde. to appear. Click loss and click insertion in Fwe. In Bonny Sands (ed.), *The handbook of clicks*. Leiden: Brill.
- Gunnink, Hilde, Bonny Sands, Brigitte Pakendorf & Koen Bostoen. 2015. Prehistoric language contact in the Kavango-Zambezi transfrontier area: Khoisan influence on southwestern Bantu languages. *Journal of African Languages and Linguistics* 36(2). 193–232.
- Haacke, Wilfrid H. G. & Eliphaz Eiseb. 2002. *A Khoekhoegowab dictionary*. Windhoek: Gamsberg Macmillan Publishers.
- Heine, Bernd & Henry Honken. 2010. The Kx’a family: A new Khoisan genealogy. *Journal of Asian and African Studies (Ajia Afuriku gengo bunka kenkyu)* 79. 5–36.
- Herbert, Robert K. 1990. Labial palatalization in Sotho and Nguni languages: Internal and external evidence. *South African Journal of African Languages* 10. 74–80.
- Holman, Eric W., Søren Wichmann, Cecil H. Brown, Viveka Velupillai, André Müller, Pamela Brown & Dik Bakker. 2008. Explorations in automated language classification. *Folia Linguistica* 42(2). 331–354.
- Hunziker, Daniel A., Elisabeth Hunziker & Helen Eaton. 2008. A description of the phonology of the Sandawe language. In (SIL Electronic Working Papers (SILEWP) 2008-004). <http://www.sil.org/resources/publications/entry/7875>.
- Idiatov, Dmitry & Mark Van de Velde. 2016. *The lexical frequency of labial-velar stops in northern sub-Saharan Africa and its historical implications*. (Paper presented at the Special Workshop on Areal Features and Linguistic Reconstruction, ACAL 47, Berkeley, 23–26 March 2016).

- Job, Sylvanus. 2014. *Features of a sesfontein dialect of Khoekhoegowab*. Paper presented at Linguistisches Kolloquium des Seminars für Afrikawissenschaften, Berlin, 14 January 2014.
- Kulkarni-Joshi, Sonal. 2016. Forty years of language contact and change in Kupwar: A critical assessment of the intertranslatability model. *Journal of South Asian Languages and Linguistics* 3(2). 147–174.
- Lukusa, Stephen T. M. 2009. *Shiyeyi - English dictionary*. München: Lincom.
- Lukusa, Stephen T. M. & Kemmonye C. Monaka. 2008. *Shekgalagari grammar: A descriptive analysis of the language and its vocabulary*. Cape Town: Centre for Advanced Studies of African Society.
- Maddieson, Ian, Siniša Spaijić, Bonny Sands & Peter Ladefoged. 1993. Phonetic structures of Dahalo. *Afrikanistische Arbeitspapiere* 36. 5–53.
- Mathes, Timothy K. 2016. The segmental inventory and status of click replacement in Tsua. In Sheena Shah & Matthias Brenzinger (eds.), *Khoisan Languages and Linguistics: Proceedings of the 5th International Symposium, July 13-17, 2014, Riezlern/Kleinwalsertal*, 223–244. Cologne: Rüdiger Köppe.
- Miller-Ockhuizen, Amanda. 2003. *The phonetics and phonology of gutturals: A case study from Ju'hoansi*. New York, London: Routledge.
- Miller, Amanda. 2014. *Positional constraints in n|uu: Phonological evidence for different types of fricatives and stops*. Unpublished manuscript.
- Miller, Amanda, Johanna Brugman, Bonny Sands, Levi Namaseb, Mats Exter & Chris Collins. 2007. The sounds of n|uu: Place and airstream contrasts. *Working Papers of the Cornell Phonetics Laboratory* 16. 101–160.
- Miller, Amanda, Johanna Brugman, Bonny Sands, Levi Namaseb, Mats Exter & Chris Collins. 2009. Differences in airstream and posterior place of articulation among n|uu clicks. *Journal of the International Phonetic Association* 39. 129–161.
- Miller, Kirk, Mariamu Anyawire, G. G. Bala & Bonny Sands. 2012. *A Hadza lexicon*. Ms. Mang'ola, Tanzania.
- Moyo, T. 1995. Language contact and language change: The case for chiTumbuka in Northern Malawi. *South African Journal of African Languages* 15(4). 186–191.
- Nakagawa, Hiroshi. 1996. An outline of g|ui phonology. *African Study Monographs, Suppl* 22. 101–124.
- Nakagawa, Hiroshi, Kazuyoshi Sugawara & Jiro Tanaka. 2013. *G|ui - English Dictionary: A preliminary edition, March 2013*. Unpublished Ms.
- Naumann, Christfried & Hans-Jörg Bibiko. 2016. *Southern Africa as a phonological area*. Paper presented at “Speaking (of) Khoisan”, a Symposium Reviewing Southern African Prehistory, Leipzig, 14-16 May 2015.

- Pakendorf, Brigitte, Koen Bostoen & Cesare de Filippo. 2011. Molecular perspectives on the Bantu expansion: A synthesis. *Language Dynamics and Change* 1(1). 50–88.
- Pakendorf, Brigitte, Hilde Gunnink, Bonny Sands & Koen Bostoen. 2017. Pre-historic Bantu-khoisan language contact: A cross-disciplinary approach. *Language Dynamics and Change* 7(1). 1–46.
- Pongweni, Alec J. C. 1990. *Studies in Shona phonetics: An analytical review*. Harare: University of Zimbabwe.
- Sands, Bonny. 2010. Juu subgroups based on phonological patterns. In Matthias Brenzinger & Christa König (eds.), *Khoisan Languages and Linguistics: Proceedings of the 1st International Symposium, January 4–8, 2003, Riezlern/Kleinwalsertal*, 85–114. Cologne: Rüdiger Köppe.
- Sands, Bonny. 2014. *Adoption, maintenance and loss of click contrasts*. [http://linguistics.berkeley.edu/SCIHS/abstracts/5\\_FridayAfternoon/Sands.pdf](http://linguistics.berkeley.edu/SCIHS/abstracts/5_FridayAfternoon/Sands.pdf). Paper presented at ‘Sound Change in Interacting Human Systems’, 3rd Biennial Workshop on Sound Change, University of California, Berkeley, May 28-31, 2014.
- Schlebusch, Carina M., Pontus Skoglund, Per Sjödin, Lucie M. Gattepaille, Dena Hernandez, Flora Jay, Sen Li, Michael De Jongh, Andrew Singleton, Michael G. B. Blum, Himla Soodyall & Matthias Jacobsson. 2012. Genomic variation in seven Khoe-San groups reveals adaptation and complex African history. *Science* 338. 374–379.
- Schulz, Stephan & Antti Laine. 2016. *Click loss, variation and acquisition in two South African Ndebele varieties*. Paper presented at the 46th Colloquium on African Languages and Linguistics, Leiden, 29-31 August 2016.
- Seidel, Frank. 2008. *A grammar of Yeyi*. Cologne: Rüdiger Köppe Verlag.
- Sitoe, Bento. 1996. *Dicionário Changana-Português*. Maputo, Mozambique: Instituto Nacional do Desenvolvimento de Educação.
- Skhosana, Philemon Buti. 2009. *The linguistic relationship between Southern and Northern Ndebele*. Pretoria: University of Pretoria. (Doctoral dissertation.)
- Soi, Sameer. 2015. *Characterizing genome-wide patterns of genetic and epigenetic diversity in sub-Saharan African populations*. Philadelphia: University of Pennsylvania. (Doctoral dissertation.)
- Sommer, Gabriele & Rainer Voßen. 1992. Schnalzwörter im Yei (R.41). *Afrika und Übersee* 75. 1–42.
- Ten Raa, Eric. 2012. *A dictionary of Sandawe: The lexicon and culture of a Khoesan people of Tanzania*. Cologne: Rüdiger Köppe.

- Tlale, One. 2005. *The phonetics and phonology of Sengwato, a dialect of Setswana (Botswana)*. Georgetown: Georgetown University. (Doctoral dissertation.)
- Torrend, Julius. 1931. *An English-Vernacular dictionary of the Bantu-Botatwe dialects of Northern Rhodesia*. Natal: Gregg International.
- Tosco, Mauro. 1991. *A grammatical sketch of Dahalo*. Hamburg: Helmut Buske Verlag.
- Traill, Anthony. 1985. *Phonetic and phonological studies of !Xóõ Bushman*. Hamburg: Helmut Buske Verlag.
- Traill, Anthony. 1994. *A !Xóõ dictionary*. Cologne: Rüdiger Köppe Verlag.
- Traill, Anthony & Rainer Vossen. 1997. Sound change in the Khoisan languages: New data on click loss and click replacement. *Journal of African Languages and Linguistics* 18. 21–56.
- van Warmelo, Nicolaas Jacobus. 1951. *Notes on the Kaokoveld (South West Africa) and its people*. Pretoria: Government Printer.
- Visser, Hessel. 2001. *Naro dictionary: Naro-English, English-Naro*. Gantsi, Botswana: Naro Language Project.
- Visser, Hessel. 2013. Phonetics and phonology: Naro. In Rainer Vossen (ed.), *The Khoesan languages*, 60–64. London: Routledge.
- Vossen, Rainer. 2013. Phonetics and phonology: Shua subgroup. In Rainer Vossen (ed.), *The Khoesan languages*, 71–73. London: Routledge.
- Wilmsen, Edwin N. & Rainer Vossen. 1990. Labour, language and power in the construction of ethnicity in Botswana. *Critique of anthropology* 10(1). 7–37.
- Ziervogel, Dirk. 1959. *A grammar of Northern Transvaal Ndebele*. Pretoria: Van Schaik.

## Chapter 36

# Central vowels in the Kru language family: Innovation and areal spreading

Lynell Marchese Zogbo

University of the Free State; Institut de Linguistique Appliquée, Abidjan

While Proto Kru and many languages on both sides of the East-West divide today show a set of 9 oral vowels, a subset of Eastern Kru languages attests a much higher inventory, with up to five distinctive central vowels, resulting in a thirteen vowel +ATR set. The locus for central vowel innovation appears to be in the Godié-Guibéroua region, with neighboring languages at varying stages of innovation. In this paper we attempt to document vocalic inventories, point to developing systems, and speculate on how such innovations occurred, including proximity to resonant liquids (especially in a CV 1 LV 2 environment where V 1 is reduced in various contexts) and to suffixal morpheme boundaries. In some languages, co-existing lexical variation (mɔ ~ mɛ ‘go’, Kagbɔwɔli dialect of Godié) is one clear pathway to phonological change. Pressure for “rounding out” vocalic systems may also play a role in the unusually high number of innovated central vowels. Interestingly one Western language, Bakwé (Marchese 1989), also has a full set of central vowels, an apparent case of areal spreading. Vydrine’s (2009) hypothesis of a wider cross-family spread of central vowels into southern Mande is also discussed. While this article only scratches the surface of this complicated puzzle, evidence points to intricate interaction between phonological change and areal spreading.

## 1 Introduction

A quick inventory of vowel systems in the Kru language family<sup>1</sup> reveals a striking diversity. While in Western Kru, with the exception of /a/, no phonemic central

---

<sup>1</sup>The status of the Kru language family within Niger-Congo is still subject to debate, having been proposed as independent (Westermann), a branch of Kwa (Greenberg), closely connected to Gur (Bennett and Sterk), and of late (Williamson & Blench 2000: 18) an offshoot of Proto West Volta Congo.



Table 1: Kouya vowels

	Front		Central	Back	
	+ATR	-ATR		+ATR	-ATR
+high	i	ɪ		u	ʊ
-high	e	ɛ	a	o	ɔ

Table 2: Kouya ±ATR sets

-ATR		+ATR	
<i>bʊ<sup>1</sup>lɛ<sup>2</sup></i>	‘buffalo’	<i>di<sup>2</sup>de<sup>2</sup></i>	‘father’
<i>tɪbɛ<sup>33</sup></i>	‘snake’	<i>bʊ<sup>2</sup>bui<sup>1</sup></i>	‘smoke, vapor’
<i>mɪɔ<sup>13</sup></i>	‘tear’ (n.)	<i>beli<sup>23</sup></i>	‘brother’
<i>mɔ<sup>3</sup>mɔɛ<sup>44</sup></i>	‘smile’ (v.)	<i>petu<sup>41</sup></i>	‘grass’
<i>bʊɪ<sup>4</sup></i>	‘flower’	<i>libo<sup>33</sup></i>	‘work’ (n.)

vowels are attested, in Eastern Kru, some languages have a full set, with 5 out of 13 vowels being central (or back unrounded). Citing numerous shared features in South Mande and Kru, Vydrine (2009) proposes that central vowels may be one of several areal features of the Ivorian forest region, cutting across genetic boundaries. Thus in this paper, we attempt to:

- explore the innovation of central vowels in Eastern Kru, examining the extent and possible means of this phonological innovation and
- evaluate the viability of areal hypotheses concerning the spread of central vowels within Kru and across its linguistic borders.

All Kru languages show a minimum of 9 oral vowels, featuring two sets of vowels based on the feature +ATR, and usually a strong vowel harmony system affecting word internal stems and suffix affixation. A typical system is seen in Kouya where vowels occur in two sets (Table 1, adapted from Saunders 2009: 50).

Words are made up of either + or - ATR vowels (Table 2) with /a/ co-occurring with both + ATR vowels (Table 3).<sup>2</sup>

<sup>2</sup>As is traditional in Kru literature, in the examples to follow and throughout this paper, tones are marked by raised superscripts. Most Kru languages show four level tones: high (1), mid-high (2), mid (3), and low (4). Exceptionally Godié has only three level tones (high, mid, low), with only remnants of a fourth tone (Gratrix 1975).



Table 3: Kouya words with /a/ with both  $\pm$ ATR sets

-ATR		+ATR	
<i>kɔa</i> <sup>11</sup>	‘bone’	<i>bita</i> <sup>41</sup>	‘mat’
<i>kpe<sup>2</sup>la</i> <sup>1</sup>	‘to refuse’	<i>te<sup>2</sup>la</i> <sup>2</sup>	‘porcupine’
<i>yi<sup>1</sup>ba</i> <sup>1</sup>	‘desire, want’	<i>gba<sup>2</sup>gbo</i> <sup>3</sup>	‘partridge’

Despite its non-participatory status in vowel harmony, /a/ usually patterns in other ways as -ATR. In terms of frequency, -ATR vowels are more frequent than +ATR, and most suffixes (verbal suffixes, noun class markers and other nominal suffixes) are underlying -ATR. Casali (2008) notes in dominant harmony languages, affix harmony involves assimilation of [-ATR] to [+ATR] vowels, a fact that seems to hold in our Eastern Kru samples, for example, in Godié where rightward assimilation frequently shows a -ATR to +ATR shift, as in the following example of object clitics in Godié:

(1) Godié (Marchese 1975)

<i>/ɔ<sup>2</sup> bi<sup>2</sup>bie<sup>2</sup> ɔ<sup>2</sup>/</i>	‘he begs him’ (person)
<i>bibió ɔ</i>	(vowel elision)
[ <i>ɔ bibi o</i> ]	(vowel harmony)

## 2 More elaborate systems

Though both Western and Eastern Kru attest the standard 9 oral vowel system, several Eastern Kru languages (and Western Bakwé) have much larger phonemic vowel inventories, with many additional central (or back unrounded) phonemic vowels<sup>3</sup>, as seen in Table 4.

Within Western Kru, no phonemic central vowels are attested, except in Bakwé, which lies contiguous to Eastern Godié (see Maps 1 and 2 below). For over a century (Delafosse 1904), Bakwé has been classified as a Western Kru language based on important isoglosses such as **t/s** (‘tree’ *tu/su*<sup>3</sup>); **ny/ng** (‘name’, ‘woman’);

<sup>3</sup>Researchers have used both terms. Central vowels in Kru are not rounded. In acoustic studies, Grégoire (1972) has called these vowels in Bété of Guibéroua *central* (see also Zogbo 1981: 15). In other descriptions, Werle & Gbalehi (1976: 61) as well as Kipré (2005: 7) analyze them as *back unrounded*. In Goprou’s more recent study of Kpɔkolo, a Bété dialect (2010; 2014: 177), findings are somewhat skewed. For vowels [i, e, ʌ, and a], a female speaker shows F2 readings around 1500 Hz, indicating a clear central position, while [e] positions itself as a back rounded vowels (under 1500 Hz), as does [ʌ] in male speakers. This issue is important but out of the scope of this paper.

Table 4: Vowel inventories in Eastern Kru languages

Language	Number of Vowels	Number of Central Vowels (excluding /a/)
Godié	13	4
Koyo	13	4
Guibéroua Bété	13	4
Gbawale	13	4
Daloa Bété	12	3
Kpɔkolo	11	2
Gaʋɔgbɔ	11	2
Guébie	10	1
Vata	10	1
Gbadi	9	0
Lakota Dida	9	0
Yocoboue Dida	9	0
Neyo	9	0
Kouya	9	0

Western *ni*<sup>1</sup> ‘water’ vs. PEK \**nyu*<sup>1</sup>. (Marchese 1989). Curiously Lewis et al. (2014) classify Bakwé as Eastern. In this language and the four Eastern languages seen at the top of the table above (Guibéroua Bété, Gbawale, Godié, Koyo), there is a full set of five phonologically contrastive central vowels, which correspond to vowel heights of the peripheral vowels and are also defined as +ATR, as seen in Table 5.

Table 5: Largest oral vowel system in Kru

Front	Central	Back	
i	ɨ [ɯ, ɨ] <sup>a</sup>	u	(+high, +ATR)
ɪ	ɛ [ɣ, ɛ]	ʊ	(+high, -ATR)
e	ə	o	(-high, +ATR)
ɛ	ʌ	ɔ	(-high, -ATR)
	a		

<sup>a</sup>Differences among researchers in transcription complicate our task and it is difficult to identify the exact phonetic realization of such a variety of transcriptions, especially the symbol [ə] used as default schwa in languages without central vowels. As seen above, in languages with full central vowel sets, [ə] is a higher vowel than [ʌ] and is +ATR. In most instances, I tried to respect the author’s original transcription.

Despite the fact that it is hard to find perfect sets of minimal pairs, native speakers clearly distinguish five central vowel qualities and can learn to read and write them without difficulty. In many languages, to establish a full set of contrasts, plural forms complete minimal pairs lists, as shown for Guibéroua Bété in (2), Godié in Table 6, and Bakwé in Table 7.<sup>4</sup>

- (2) Guibéroua Bété (Werle & Gbalehi 1976)
- |                         |          |                        |         |                         |            |
|-------------------------|----------|------------------------|---------|-------------------------|------------|
| <i>kpə</i> <sup>1</sup> | ‘chair’  | <i>pə</i> <sup>3</sup> | ‘cover’ | <i>pɛ</i> <sup>1</sup>  | ‘lie down’ |
| <i>kpi</i> <sup>1</sup> | ‘chairs’ | <i>pɛ</i> <sup>3</sup> | ‘throw’ | <i>kpa</i> <sup>2</sup> | ‘mud’      |

Table 6: Godié (*Kagbɔwɔli* dialect, Association Gwëjekɔmɔ 2004)

<i>li</i> <sup>1</sup>	‘spear’	<i>li</i> <sup>2</sup>	‘wealth/riches’
<i>li</i> <sup>2</sup>	‘eat’	<i>lɛla</i>	‘grill, fry’
<i>luu</i> <sup>12</sup>	‘paddle’	<i>lɔ</i> <sup>1</sup>	‘song’
<i>lɔ</i> <sup>2</sup> <i>lɔ</i> <sup>2</sup>	‘new’	<i>lɔ</i> <sup>3</sup>	‘law’
<i>laa</i> <sup>2</sup>	‘call’	<i>la</i> <sup>3</sup>	‘bring’

Table 7: Bakwé (Centre de Traduction et d’Alphabétisation en langue Bakwé 2006)

<i>pa</i> <sup>3</sup>	‘enter’	<i>gɔ</i> <sup>4</sup>	‘to be old’	<i>gɔ</i> <sup>4</sup>	‘to dig’
<i>pɛ</i> <sup>4</sup>	‘share’	<i>gɛ</i> <sup>4</sup>	‘vines’	<i>gɛ</i> <sup>4</sup>	‘affair’
<i>bi</i> <sup>2</sup> <i>ti</i> <sup>3</sup>	‘thorn’	<i>gi</i> <sup>4</sup>	‘plants’	<i>gɔ</i> <sup>4</sup>	‘tail’
<i>bɛ</i> <sup>3</sup>	‘to be’	<i>gɛ</i> <sup>4</sup>	‘eggs’	<i>gɔ</i> <sup>4</sup> / <i>gr</i> <sup>4</sup>	‘egg’
<i>bɔ</i> <sup>3</sup>	‘to tap’	<i>gu</i> <sup>4</sup>	‘to give birth’	<i>gɛ</i> <sup>4</sup>	‘vine’
<i>bɛ</i> <sup>2</sup>	‘ball (of something)’				
<i>bi</i> <sup>2</sup>	‘balls’ (PL)				
<i>ba</i> <sup>2</sup> <i>li</i> <sup>2</sup>	‘pick up’				

Within these systems, central vowels follow the rules of vowel harmony, with typical +ATR word-internal constraints, illustrated for Guibéroua Bété in Table 8 and Gbawale in Table 9.

<sup>4</sup>The adjective ‘new’ in Godié (Table 6) appears to be inherently +ATR and agrees with the noun it modifies, for example *lolo*, *lala*, *lɔlɔ*.

Table 8: Guibéroua Bété (Werle &amp; Gbalehi 1976)

-ATR		+ATR	
$k\text{ɛ}^3 b\text{ɛ}^3$	‘to grab’	$k\text{o}^4 s\text{u}^2$	‘fire’
$t\text{i}^2 m\text{ɛ}^2$	‘to pay the dowry’	$w\text{u}\text{ɔ}^{2-4}$	‘all’
$g\text{w}\text{ɛ}^1 z\text{i}^3$	‘medecine’	$n\text{u}\text{ɔ}^{1-1}$	‘mouth’

Table 9: Gbawale (Martine 1987)

-ATR		+ATR	
$w\text{ɛ}^3 l\text{i}^3$	‘problem’	$d\text{i}^4 g\text{b}\text{ɔ}^3$	‘mortar’
$k\text{o}^4 k\text{w}\text{ɛ}^1$	‘chicken’	$g\text{o}^4 v\text{ɔ}^3$	‘tree trunk’
$s\text{i}^1 k\text{ɛ}^1$	‘rice’	$d\text{o}^4 p\text{e}^1$	‘proper name’
$z\text{i}^3 k\text{p}\text{o}^4$	‘tomorrow’	$b\text{i}^2 d\text{o}^4$	‘to wash (oneself)’
$m\text{o}^4 m\text{ɛ}^3$	‘you’ (indep)	$c\text{i}^3 g\text{b}\text{e}^4$	‘yesterday’

As in most of these languages, /a/ occurs with both series, as shown for Gbawale in Table 10.

Table 10: Gbawale (Martine 1987)

-ATR		+ATR	
$p\text{i}a$	‘buy’	$a^4 z\text{i}\text{e}^3$	‘proper name*’
$a^4 m\text{ɛ}^1$	‘me’		
$w\text{a}^2 m\text{ɛ}^3$	‘them’		

These systems of 13 phonologically contrastive vowels constitute the largest oral vowel systems in the Kru language family.

## 2.1 Innovation of central vowels

Given that, with the exception of Bakwé, no central vowels occur in Western Kru, and that within Eastern Kru, several languages have no central vowels other than /a/, we are assuming Proto Kru had a basic oral 9 vowel system, as in Kouya today, with no central vowels. Central vowels would represent an important innovation in a defined area and/or sub-branch. In the following map, the dark black line

indicates the main West-East divide in Kru. Areas where full sets of 5 central vowels (darker blue) occur are distinguished from those with no central vowels (rose) and those with an incomplete set (lighter blue). As will be discussed later, the distribution of central vowels suggest an areal spread, across the West-East border, and outside of Kru into Dan, a Mande language.

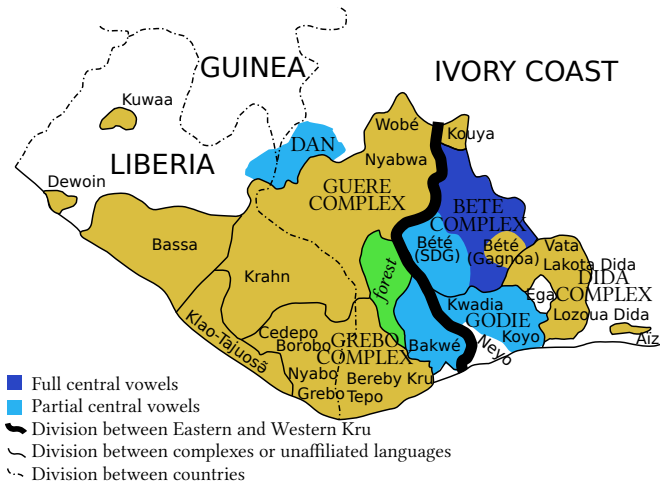

Figure 1: Map 1

## 2.2 Languages without the full set of central vowels

The top languages in Table 4 (Godié, Guibéroua Bété, etc.) along with Western Bakwé (all in darker blue) appear to be the locus of a major innovation which has not (yet?) affected some of the Eastern languages such as Neyo, Kouya, Gbadi, and various dialects of Dida. Examining those languages which have partial sets (light blue) may provide clues as to how full central series developed in certain languages.

### 2.2.1 Daloa Bété

Daloa Bété slightly east and north of Guibéroua-Godié-Bakwé has three non-low central vowels (+ATR) but no low -ATR / $\Delta$ / (Zogbo 2005). /a/ occurs with both sets of +ATR vowels. This system is not as symmetrical as those three mentioned above. However, as far as we know, this dialect shows no signs of developing the -ATR counterpart / $\Delta$ /:

Table 11: Kpɔkolo phonetic vowels

i	ɨ (ɯ)	u
ɪ	ɥ (ʏ)	ʊ
e	ə	o
ɛ		ɔ
	a	

### 2.2.2 Kpɔkolo

Kpɔkolo is a dialect of Bété spoken in 20 villages south of Gagnoa. Goprou (2010; 2014: 175, 179) cites the following phonetic vowel chart:

Table 12: Kpɔkolo phonemes

ɪ	i	u
ɪ	ə	ʊ
e		o
ɛ	ʌ	ɔ
	a	

He notes there are no contrastive minimal pairs for [i] and [e] except in singular-plural forms. He thus analyzes the two high central vowels as allophones of high front vowels high /i/ and /ɪ/, an analysis which might provide some insight into how central vowels develop historically. Vahoua (2011), however, provides good evidence that /ʌ/ has phonemic status in this dialect.

### 2.2.3 Gafɔgbɔ

Gafɔgbɔ spoken in Gagnoa, Lakota (to the south), and the villages in between, attests 11 oral vowels, including two high central (or back unrounded ones, Gnahore 2006: 5, 9).

Table 13: Gafɔgbɔ phonemic vowels

i	ɯ	u
ɪ	ʏ	ʊ
e		o
ɛ		ɔ
	a	

If the two high central vowels are truly phonemic, this language may be one step further than Kpɔkolo in the development of central vowels. Typical vowel harmony is present, with /a/ classified as -ATR.<sup>5</sup>

#### 2.2.4 Guébie

This language, on the border between Bété and Dida, attests only one central vowel, phonetically higher than /a/. Hannah Sande (p.c.) reports that /a/ functions as -ATR and the higher central vowel as +ATR [ə]. As in other Kru languages, /a/ shows a tendency to occur with both +ATR. Sande notes an /-a/ suffix remains constant, no matter the ATR feature of a verbal root.

Table 14: Vata vowels according to Kaye (1980)

+ATR		-ATR	
i	u	ɪ	ʊ
e	o	ɛ	ɔ
	ə		a

#### 2.2.5 Vata

Like Guébie, Vata shows signs of shifting to a 10 vowel system, with Kaye (1980: 70) also reporting an additional central vowel as part of the +ATR series. He notes “The 10<sup>th</sup> vowel, i.e. the advanced low vowel is not pronounced in the speech of all Vata speakers. Nevertheless, there are reasons to justify in every Vata dialect, a system of 10 vowels”. In the following chart we suspect that what is marked as /Λ/ corresponds to what most Kru researchers would write as /ə/, a +ATR vowel phonetically higher than /a/:

Table 15: Vata vowels reanalyzed

+ATR		-ATR	
i	u	ɪ	ʊ
e	o	ɛ	ɔ
	Λ		a

<sup>5</sup>Gnahoure’s vowel chart presents the two high central vowels as -ATR (p. 9): *ɔzwa jama* ‘Ozoua became light’ and *ʒai nyumɔ* ‘Jai became ugly’ (2006: 25). In her examples /a/ combines with both +ATR: *ga<sup>4</sup>ji<sup>1</sup>* ‘proper name’, *a<sup>4</sup>mi<sup>3</sup>* ‘1 SG’ (obj). More study is needed on how central vowels and the feature ATR combine.

### 2.2.6 Gbadi

Curiously, though Gbadi is classified as Bété, with the exception of /a/, it attests no central vowels (C. Goprou, p.c. & H. Tebili, word list), underlining the issue of frequent mismatches between ethnic/social perceptions and linguistic classifications.

What is striking here is that some languages seem to be developing central vowels “from the top”, with high central vowels (Gaḃɔgbɔ, Daloa Bété), while others (Vata, Guébie) appear to be developing them “from the bottom”. In Kpɔkolo, it would appear a lower central vowel /ʌ/ has become phonemic, but it may be the two higher conditioned central vowels will one day become phonemic as well.

## 3 Historic sources for central vowels

Based on the hypothesis that Proto Kru had a nine vowel oral system, the source of central vowels will now be examined. Our research shows that these vowels develop from both front and back vowels as well as central /a/, but the most frequent cases involve front vowels \*i, \*ɪ, and \*e, and central \*a. It is important to note that the emergence of central vowels in Kru never results in the disappearance of peripheral vowels in any given vocalic system.

Below reconstructions from Proto Eastern Kru (PEK) are proposed and traced to their current forms mainly in Godié, a language which shows a very high number of central vowels. In almost all cases the central vowel in question retains the same features for vowel height and +ATR as the proto form. Here we concentrate on *sources* of innovated central vowels, being able to identify very few conditioning factors.

However, it will be noted that a very frequent environment for central vowels to emerge is in the environment of CLV, a fact which will be discussed below. Note that in virtually all Kru languages, /l/ has a variety of allophones (flap n, l, r) in CLV and in some languages implosive d, Marchese 1979/1983). Dialects of Godié are cited when known (jɫəkɔwɔli, kɔgbɔwɔli, and koyo).

Proto back vowels may also give central reflexes, though not as frequently and perhaps following a more complicated path §3.

Note that examples of proto back vowels \*u, \*o, and \*ɔ giving a central reflex are rare. One example might be PEK \*ɓlo ‘one’ → ɓlɛ (Godié, jɫəkɔ dialect). Cases of low vowels \*ɛ and \*ɔ giving a central vowel are equally rare.



Table 16: \*i → i in Godié CLV

PEK	* <i>ɓli</i> <sup>2</sup> or <sup>3</sup>	‘fall’	Kouya, Gbawale, Gaɓɓɔgbɔ	→	<i>ɓli</i> <sup>2</sup>	Godié
PEK	* <i>zli/e</i>	‘fish’		→	<i>zli</i> <sup>2</sup>	kagɓɔwali
PEK	* <i>mli</i>	‘bite’		→	<i>mli</i> <sup>2</sup>	ɟlɔkɔwali, kagɓɔwali, koyo
In some CV words beginning with /l/, often pronounced as implosive d (probably *d)						
PEK	* <i>li</i> <sup>2</sup>	‘eat’	Kouya, Dida, Gbawale, Gaɓɓɔgbɔ, Vata	→	<i>li</i>	ɟlɔkɔwali, kagɓɔwali

Table 17: \*ɪ → ɯ in Godié

PEK	* <i>ɲli</i> <sup>1</sup>	‘name’	Neyo, Dida Guibéroua Bété, Daloa	→	<i>ɲli</i> <sup>1</sup>	Godié, Koyo [ <i>ɲɲi</i> <sup>1</sup> ]
PEK	* <i>di</i> <sup>2</sup>	‘news’	Dida, Daloa Bété; Kouya <i>di</i> <sup>1</sup> ‘chat’, ‘talk’	→	<i>dɯ</i> <sup>1</sup>	Godié, Koyo [ <i>di</i> <sup>1</sup> ]
PEK	* <i>a<sup>4</sup>mi</i> <sup>1</sup>	‘1 SG EMPH’	Kouya, Gaɓɓɔgbɔ	→	<i>a<sup>3</sup>mɯ</i> <sup>1</sup>	Godié
PEK	* <i>ni</i> <sup>1</sup>	‘and (then)’	Guibéroua Bété	→	<i>nɯ</i> <sup>1</sup>	Godié

## 4 Mechanisms for central vowel development

The question as to how these phonologically contrastive central vowels developed from an original 9 vowel proto system is a main concern here. What caused languages to move from a seemingly stable Proto system towards a more complex one, with full or partial sets of central vowels? For the moment, putting aside the question of language contact and areal features, we will explore possible phonetic and phonological explanations of this development.

### 4.1 Phonetically motivated centralization

Of course the development of central vowels is not unique to Kru or to Africa. Central vowels involve less tongue displacement than peripheral vowels. Thus

Table 18: \*a → ʌ in Godié

PEK	* <i>m</i> l <sup>a2</sup>	‘swallow’	Dida, Koyo, Neyo, Guibéroua, Daloa	→	<i>m</i> l <sup>ʌ2</sup>	Godié [mʌñʌ]
PKru	* <i>m</i> l <sup>a1/2</sup>	‘drink’	Gabɔgbɔ <i>m</i> l <sup>a3</sup> ; Tepo <i>m</i> n <sup>a2</sup> , Nyabwa <i>m</i> n <sup>a2</sup>	→	<i>m</i> l <sup>ʌ1</sup>	Godié [mʌñʌ <sup>1</sup> ]
PEK	* <i>k</i> wal <sup>a12</sup>	‘tortoise’	Kouya <i>k</i> wal <sup>a12</sup> ; Gabɔgbɔ <i>k</i> wal <sup>a12</sup>	→	<i>k</i> wl <sup>ʌ12</sup>	Godié
PEK	* <i>k</i> p <sup>a2</sup> l <sup>a2</sup>	‘bottle’	Bakwé	→	<i>k</i> pʌl <sup>a1</sup>	Godié (Kagbo)
PEK	* <i>s</i> a	‘pick (up)’	Dida, Gabɔgbɔ, cf. Wobe <i>s</i> aa ‘choose’	→	sʌ	Godié
PEK	* <i>k</i> a <sup>3</sup>	‘have’	Kouya <i>k</i> a <sup>3</sup>	→	<i>k</i> ʌ <sup>3</sup>	Godié, Gbawale
PEK	* <i>g</i> a <sup>3</sup>	‘to be awake’	Kouya	→	<i>g</i> ʌ <sup>3</sup>	Godié

Table 19: \*ɔ → ɯ

PEK	* <i>z</i> ɔ	‘shame’	Neyo <i>z</i> ɔɔ <sup>2-3</sup> , <i>z</i> ɔ <sup>1</sup> , Daloa <i>z</i> ɔ <sup>2</sup>	→	<i>z</i> ɯ <sup>3</sup>	Godié
PEK	* <i>m</i> ɔ <sup>2</sup>	‘go’	Dida	→	<i>m</i> ɯ <sup>2</sup>	Godié
PEK	* <i>n</i> gbɔ	‘five’	Kouya	→	<i>n</i> <sup>3</sup> gbɯ <sup>2</sup>	Godié <sup>a</sup>

<sup>a</sup>See also *n*<sup>4</sup>gbɔ<sup>3</sup>, Kodia (Leidenfrost, p.c.).

quite naturally many languages develop central allophones. Welmers (1973: 23, 25) notes phonetically conditioned centralizing tendencies of both front and back vowels in certain Mande languages, for example Kpelle where “short front unrounded vowels /i, e, ε/ have centralized allophones [i,ə] after most consonants in monosyllables and in some types of bisyllabic forms”. Within Kru, Bentinck (1978) notes centralized realizations in sentence final position and after labiovelars.

However, more compelling is what appears to be a universal tendency for central vowels to emerge in proximity to resonant liquids /r/ and /l/ as well as their nasal counterparts. Well known examples are high front vowels becoming central in such environments in Middle English, for example, with *bird* losing its short “i” and evolving into a central vowel (Hickey, MS). Lynch (2015: 76) notes

in Proto Oceanic a central vowel reflex in Iaai: \*o > i, ə, as when \*roŋoR ‘hear’ becomes /ləŋ/ or /liŋ/. Though he cites no conditioning factor, the r-l connection seems clear. Closer to home, Morton (2012) notes a high \*ɪ gives rise to a high central /i/ phoneme before liquids and nasals in Anii, an Akan language.

In Kru languages, where the typical syllable structures are V, CV, CVV, CCV (where C<sub>2</sub> is a liquid or sonorant), many researchers note the appearance synchronically of a central transition vowel in CLV words. Marchese (1979/1983: 98) initially described the phenomenon as following:

In many cases, a transition vowel appears between the first consonant and [l]. The quality of this vowel is determined by the main vowel. If the main vowel [i.e. V2] is central or back, the transition vowel is identical to the main vowel. If it is a front vowel, the transition vowel is generally a central vowel of the same height.

Obviously the vowel carries the same ATR feature as the primary vowel, as seen in Table 20.

Table 20: Godié

front vowel			central and back vowel		
/yli <sup>1</sup> /	[y <sup>ɨ</sup> li]	‘eye’	/ɓli <sup>1</sup> ...kɔ <sup>1</sup> /	[ɓ <sup>ɨ</sup> li]	‘pick up’
/gwle/	[gw <sup>ʌ</sup> le]	‘remain’	/ɓlɛ <sup>3</sup> /	[ɓ <sup>ʌ</sup> lɛ]	‘one (certain)’
			/plɛ <sup>2</sup> /	[p <sup>ʌ</sup> lɛ]	‘enter’

In Kouya, an Eastern language with no contrastive central vowels, Saunders reports a phonetically predictable central transition vowel which he writes as [ə], usually when V is a front vowel or /a/:<sup>6</sup>

Table 21: Kouya (Saunders 2009)

/yra <sup>3</sup> /	[y <sup>ə</sup> ra]	‘to look at’
/plɛ <sup>2</sup> /	[p <sup>ə</sup> lɛ]	‘liver’
/fli <sup>41</sup> /	[f <sup>ə</sup> li]	‘forest’

We note for back vowels, as in Godié, the epenthetic vowel is identical to the primary vowel: /ɓlo/ [ɓ<sup>ə</sup>lo] ‘one’.

<sup>6</sup>The exact nature of [ə] is not known, but Saunders (p.c.) reports there is no violation of + ATR harmony.

For Western Glaro, where there are no central vowel phonemes, Wolfe (p.c.) reports that retracted /ɪ/ becomes central in fast speech in certain words such as /nyɪnɔ/ ‘woman/wife’. Note that here C<sub>2</sub> provides the expected liquid-nasal environment.

Of course while current synchronic analyses vary, with some positing epenthetic vowel insertion and others an underlying dissyllabic C<sub>1</sub>V<sub>1</sub>C<sub>2</sub>V<sub>2</sub> with a subsequent reduction, it is clear that historically these sequences derived from dissyllables. Reduction to one syllable CLV is precipitated by C<sub>2</sub> being a liquid or nasal sonorant and tones on both vowels being identical. Identical tones speed up the realization of the word, which favors a centralized transitional vowel rather than a full one. A difference in tone on V<sub>1</sub> and V<sub>2</sub> blocks the reduction process. Compare wɪ<sup>2</sup>li<sup>2</sup> ‘goat’ vs. wo<sup>3</sup>lo<sup>4</sup> ‘look’ in Gbawale (Martine 1987: 20, 31) or the Godié examples in (9) to words like gɔ<sup>3</sup>lɔ<sup>1</sup> ‘canoe’ and lu<sup>3</sup>lu<sup>2</sup> ‘tamtam’ where no reduction occurs.

Note, however, that in many languages, a reduced CLV functions synchronically as a single syllable (see Gratrix 1975 for Godié).<sup>7</sup> It is interesting to note, however, that linguists who are native speakers of Kru languages often opt for C<sub>1</sub>V<sub>1</sub>C<sub>2</sub>V<sub>2</sub>. Thus Kipre (2015) argues strongly for a synchronic underlying two syllable structure in Daloa Bété. Guehoun, as well, as a native speaker of Lakota Dida, notes in the case of CLV “the transition vowel is predictable [but] “when enunciating the word, when they are asked to slow their speech or to pronounce the sequences of a words with insistence, they pronounce two syllables”. He also notes “a child learning to speak automatically says CLV words as CVLV, without the word becoming unintelligible.” (1993: 55–56). Thus Guehoun proposes /ngɛlɛ/ ‘odor’ for [nglɛ], and /kpo<sup>3</sup>ke<sup>3</sup>le<sup>3</sup>/ ‘bench, chair’ for [kpokle].

## 4.2 Pathways of development

While the above discussion shows that central vowels are phonetically predictable, it does not provide a pathway for these sounds becoming phonemic. At this stage, considering the data, we can only suggest possible pathways. However, Kpɔkolo may serve as a good example of a language that appears to be currently developing central vowels. In this language, Goprou (2014: 191) notes centralization in a similar environment as outlined in the preceding section (liquid-sonorant), but with dissimilar tones. Another a native speaker linguist, he too posits identical vowels as underlying:

---

<sup>7</sup>Note also in all Kru languages, when alveolars (+cor) are involved, /l/ → r, and the vowel disappears completely, for example, t<sup>ɔ</sup>lɔ ‘to blossom’ → [trɔ], enhancing perception as one syllable (Marchese 1979/1983).

- (3) Kpɔkolo  
 /br<sup>4</sup>lɪ<sup>2</sup>/ ‘neck’ → [bɛlɪ]  
 /kɪ<sup>1</sup>lɪ<sup>4</sup>/ ‘first’ → [kɔlɪ]

He thus posits [ə] as an allophone of /ɪ/, and likewise for [i] as an allophone of /i/. He notes however that for the latter, there are some minimal pairs, but only in a singular-plural paradigm. As noted, this language has apparently developed a lower central phonemic vowel /ʌ/ (Vahoua 2011). Our major problem is finding a pathway for development for these central vowels in Kpɔkolo and other innovating languages.

One possible pathway might be the development of a central vowel V<sub>1</sub> position and the loss of the final syllable CV<sub>2</sub>, leaving the new vowel in a contrastive CV# position. Unfortunately however, we have found few examples which could justify this scenario. Also arguing against this hypothesis is the fact that Western languages, showing the most word final syllable reduction, have not developed any central vowels. Another possibility is that rightward assimilation (a common Kru process in vowel harmony) would affect V<sub>2</sub>, with V<sub>1</sub> taking on a central quality and then coming to dominate V<sub>2</sub>. This would give a central vowel in a primary vocalic position where it would come into contrast with peripheral vowels, for example: *kpala* → *kp<sup>ʌ</sup>la* → *kplʌ*.

### 4.3 The effect of morpheme boundaries

Examples above open up another possible pathway for central vowel development. Kru languages are primarily suffixing. Historically noun class suffixes have interacted and often coalesced with stem final vowels. To these forms are added plural markers and, in some languages, definite suffixes (Marchese 1979/1983; Zogbo 2017). Verbs as well carry object clitics but also aspectual markers, causative, and other transitivity-changing suffixes. In some of our data, these instances of vowels “coming together” at morpheme boundaries seems to effect word (and syllable?) structure, resulting in some centralizing phenomena.

For example, the environment *noun + class marker* is clearly to be reconstructed for Proto Kru. Did this environment create a context where central vowels emerged in a single syllable? To give an example, current variant forms such as /kpɔ/ and /kpɔ/ ‘oil’ can be seen as deriving from \*kpV + \*ɔ, root + noun class suffix. In all likelihood the form could have been \*kpɪ + \*ɔ, where in some languages the first vowel was centralized, as in Godié and Bété (/kpɔ/). In others the initial stem vowel was lost and the noun class marker took its place yielding (/kpɔ/).

It is worth noting that Kru plurals—most often marked with human suffix *-ɔa* or non human *-ɪ*—have a peculiar feature of effecting upward centralization, a process which is hard to account for synchronically on a strictly phonological level in Eastern Kru and Bakwé (Marchese 1979/1983). This is particularly predominant in Godié, for example, in singular plural pairs such as *li<sup>1</sup>/li<sup>1</sup>* ‘spear’, *mu<sup>1-2</sup> mɛu<sup>1-2</sup>* ‘boat’, *kpɔ/kpɛ* ‘herd’. While *mu + -ɪ* might give *mɛu<sup>1-2</sup>*, it is hard to derive *li<sup>1</sup>* from *li + -ɪ*.<sup>8</sup> It is as if the mere presence of the plural morpheme boundary produces heightening and centralization. Goprou (2014) also reports a similar centralization of back vowels (which he describes as unrounding, but could also be considered as fronting) in the environment of plural *-ɪ*. Thus Kpɔkolo shows central vowels on the surface in plural forms but not in underlying ones:

Table 22: Kpɔkolo (Goprou 2014: 202-206)

<i>/pɔ<sup>2</sup>lɔ<sup>3</sup>/ + ɪ</i>	→ <i>/pɔlɪ/</i>	→ [pəlɪ]		‘piece’ + PL
<i>/so<sup>4</sup>lu<sup>2</sup>/ + ɪ</i>	→ <i>/solu + ɪ/</i>	→ <i>/soli/</i>	→ [sɔli]	‘pail + PL’
<i>/kɔ<sup>2</sup>lɪ<sup>2</sup>/ + ɪ</i>	→ [kɔlɪ]			‘bamboo + PL’
<i>/mu<sup>4</sup>du<sup>2</sup>/ + ɪ</i>	→ <i>muɔ + ɪ</i>	→ <i>mudi</i>	→ [midi]	‘(finger)nail’ + PL

Note that this is basically the same CLV environment as the transition vowels in other languages<sup>9</sup>, and it is again a question of vocalic assimilation of back vowels moving front. Welmers (1973) notes a similar “derounding” as well as fronting of back vowels /o/ and /ɔ/ in Kpelle when followed by a front vowel, either directly or after an intervening /l, r, n/. As Goprou, he calls these centralized forms “allophones” of other vowels. Welmers notes however, that “native speaker reaction “strongly favors the interpretation of the underlying vowel, in this case /o/ and /ɔ/”.

The data from Kpɔkolo confirms yet again the “weakness” of the position of the first vowel in a CVCV [lateral/sonorant] word. Clearly the C<sub>L</sub>V environment lends itself to centralization in Kru (and cross-linguistically), but the addition of a morpheme boundary seems to add “additional weight” to this tendency. For Koyo, Kokora (another native speaker, 1976: 39) cites the form */mala+à/* [mɪlá-à] (drink-PERF PAST) where in addition to the CVLV environment, we think the “added weight” of the rightward morpheme boundary causes the first /a/ to weaken, and here, to heighten as well. Another example comes from Nyabwa where no

<sup>8</sup>According to morpho-phonological rules *li + ɪ* should give *lii* (assimilation, vowel harmony) and *mu + ɪ*, *mɛu*.

<sup>9</sup>We might suspect that *d* in the last example is a reflex of \**d*.

phonemic central vowels exist. Bentinck (1978: 50) reports phonetic centralizing of the vowel /e/, at the end of conjugated verbs in a CV + V environment: /ɪn<sup>2</sup> li<sup>3</sup> e<sup>4</sup> pi<sup>2</sup>te<sup>4</sup>/ (I eat-SUFFIX banana) ‘I’m eating a banana’. Word boundaries may also come into play, as seen in the following examples from Lakota Dida, where Guehoun (1993: 47) reports a phonetic /a/ → [ə] development, which seems a “change in progress”:

Table 23: Lakota Dida

/ɔ <sup>3</sup> sa <sup>3</sup> ka <sup>4</sup> fi <sup>1</sup> /	→ [ɔ sə kəfi]	‘He’s picking coffee’
/ɔ <sup>3</sup> la <sup>4</sup> du <sup>1</sup> tu <sup>3</sup> bo <sup>3</sup> du <sup>4</sup> kwo <sup>2</sup> /	→ [ɔ lə dutu bodukwo]	‘He brought a package to the village chief’
/ɔ <sup>3</sup> ka <sup>4</sup> ce <sup>1</sup> /	→ [ɔ kə ce]	‘He has noise (he’s loud)’

Despite these various scenarios, we cannot say exactly *how* allophones or phonetic realizations become contrastive phonologically. Neither do we know if these changes occurred early on, i.e. high up in the Eastern Kru tree and consequently spread, or even (though extremely less probably), whether the innovation occurred in Bakwé and slowly spread eastward into Eastern Kru (See discussion below).

We do know, however, as is well attested in all types of linguistic change, that variation plays an important role in the adoption of central vowels. Indeed, in the *kagbɔwali* dialect of Godié, *mɔ* and *mɛ* ‘go’ are in free variation, while in the *jlɛkɔ* dialect the central vowel has become the standard form. In Lakota Dida Guehoun (1993: 48) notes that /a/ and [ə] are often in free distribution, “...since a speaker can use or not use either realization without it affecting the meaning of the message.” It would thus hardly be surprising if this dialect of Dida develops a slightly higher phonemic central vowel to join /a/, with each occurring in its own separate harmonic set.

#### 4.4 Pressure for symmetric systems

Casali (2008: 501, 502) notes that a 9 vowel systems with five [–ATR] and four [+ATR] vowels, where “a contrastive non-high [+ATR] counterpart of /a/...is absent” are “extremely common (numbering, by any reasonable estimate, in the hundreds) and are geographically and genetically widespread within Niger-Congo and Nilo-Saharan”. He further notes that while 10 vowel languages are not the most common within NC, many ATR languages “have nine contrastive vowels, with a tenth vowel on the surface, a predictable [+ATR] variant of /a/ that occurs in the neighborhood of [+ATR] vowels”. This seems to be Kaye’s mysterious 10<sup>th</sup>

vowel in Vata. Certainly however, while symmetry in vowel systems is not universal, it is common for languages to attempt to “round out” their vocalic systems (Welmers 1973: 21). This tendency seems to be at work in Kru today, for example, in Guébie, where a 10<sup>th</sup> vowel /ə/ seems to have emerged to balance out the +ATR vowel harmony system (Sande, p.c.).

One final observation seems important in regards to the high numbers of central vowels in some Eastern Kru languages and Bakwé. It may be significant that in Western languages, where phonemic central vowels have not developed, there are full sets of nasalized vowels, whereas in the languages with central vowel phonemes, nasalized vowel phonemes do not exist or are marginal (Marchese 1979/1983). So it may be that the size of the vowel inventory may be a factor in central vowel formation in Kru. In Western Kru the full vowel inventory may have blocked the development of central vowels, due to limits on perception, while in Eastern Kru, where nasalized vowels do not appear contrastively (and presumably may have been lost), space has been created to allow for such a development. At this point, we cannot affirm this, but the complimentary distribution, noticed in other parts of Africa (Rolle 2013), is most intriguing. Note that this explanation would work for Kru but not for Dan (southern Mande) where both sets (central and nasalized) do co-occur (see below).

## 5 The areal hypothesis

Examining southern Mande and Kru languages, Vydrine (2009: 92, 112) proposes an “Upper Guinean Coast Sprachband” sharing numerous features, including +ATR, vowel harmony, a high vowel inventory (7+), nasalized vowels, asymmetry of oral and nasalized vowels, lack of nasal consonants, at least three or more level tones, consonant homo-resonance, implosives, labiovelars, *v* and *z*, high frequency of CVV feet, locative nouns, and, importantly for this study, central or back unrounded vowels. While these observations are intriguing, it is important to note that some of the above features are not systemically shared by *both* Western and Eastern Kru. Thus, while most Western Kru can be analyzed as having nasalized vowels with no nasal consonants, Eastern Kru does not exhibit this behavior. And while Eastern Kru attests central or back unrounded vowels, Western Kru does not.

In this section, we would like to consider the details and/or implications of areal sharing of central vowels as it affects this region. In exploring this areal hypothesis, several questions emerge:



- First, within Kru itself, how much of the central vowel phenomenon is due to *areal contact*? Or are central vowels a result of *genetic affiliation* (for example, an innovation in PEK occurring, say, before Guibéroua Bété and Godié split)?
- Regarding the Kru-Mande areal connection, what is the locus/source of central vowel innovation and which direction is the borrowing/language contact going?
- What factors might play a role in the spread of centralization? What are the possible scenarios and what might this tell us about the history of the Kru peoples and their interaction with Mande populations?

### 5.1 Internal spreading of central vowels within the Kru language family

Within Eastern Kru, it is clear that central vowels are emerging, which may well be a case of family-internal areal spreading. The question remains: are languages such as Guébie and Kpɔkolo adopting central vowels because of natural phonetic developments (internal phonological processes and pressure as described above), or rather, is this a case of language contact? Or are both factors at work? Kru languages constitute complex and numerous dialect chains and when speaking, Kru peoples regularly “switch back and forth”, adapting words to be understood by other Kru speakers. Thus contact as well as phonological processes seem likely influences.

Most noteworthy as a candidate for areal spreading is Bakwé, traditionally considered a Western Kru language.<sup>10</sup> This language seems to have acquired a full set of central vowels through language contact or areal spreading. Leidenfrost (p.c.) points out that the Bakwé, who are a very small group, pride themselves in speaking other languages and in the fact that their neighbors cannot speak their language. Though culturally they have been greatly influenced by Western Guere culture, having incorporated Guere masks (who, it turns out, must speak Guere!), their small number and sociolinguistic profile might make them susceptible to influence from adjacent and currently much larger Godié-Guibéroua Bété groups to the east. Also note in Figure 1 Bakwé is today separated from related Western languages by the huge Tai forest. However, questions remain. If this such contact and borrowing did occur, it is hard to know why Bakwé, which is contiguous to Godié, would borrow central vowels, while Kouya, contiguous to

---

<sup>10</sup>Linguistic evidence confirms this classification, as well as strong oral tradition (Centre de Traduction et d’Alphabétisation en langue Bakwé 2013).

Bété, would resist incorporating them! Another hypothesis is that Bakwé itself first innovated central vowels, which spread either to a Proto Eastern Kru ancestor, or spread slowly (as is still happening) throughout Eastern Kru (especially the Bété complex), but this seems less probable.

## 5.2 Central vowels spreading across language families

Cases of borrowing of central vowels across language families is not uncommon. M. Harley (p.c.), notes that in Western Chadic, Ywom and Goemai with 7 vowels (including 3 central vowels), “appear to have developed a third central vowel through contact with the neighbouring Tarok (a Benue-Congo language), which has an identical 7-vowel system.” Southern Mande includes two Dan languages with vowel systems which closely resemble Kru systems, in that full series of central vowels are present. Eastern Dan attests the following:

Table 24: Eastern Dan vowels (Vydrine 2009)

Oral vowels			Nasal vowels		
i	ɯ	u	ĩ	ɯ̃	ũ
e	ɤ	o			
ɛ	ʌ	ɔ	ɛ̃	ʌ̃	ɔ̃
æ	a	ɒ	æ̃	ã	ɒ̃

With the exception of Goo, other languages of the southern Mande group and of other Mande branches do not have central vowels. Though it is possible that these languages underwent similar processes as Kru in developing central vowels, Vydrine (2009) is probably correct in assuming that these languages must have been influenced by Kru languages through language contact. This scenario is more likely (than the other way around, with Kru borrowing from Mande), since far more Kru languages show centralization than is the case in Mande, where, besides these 2–3 affected languages, central vowels are virtually unknown. In the map below, we see Kru languages with central vowels, those without and the area where they are attested in Mande languages.

We note that Akye, an Akan language spoken by peoples who immigrated from Ghana, also attests two central vowels<sup>11</sup> (ɤ and ʌ). We have yet to investi-

<sup>11</sup>Bogny, Joseph, “Typological features template for Attie”, [https://typecraft.org/tc2wiki/Typological\\_Features\\_Template\\_for\\_Attie](https://typecraft.org/tc2wiki/Typological_Features_Template_for_Attie).

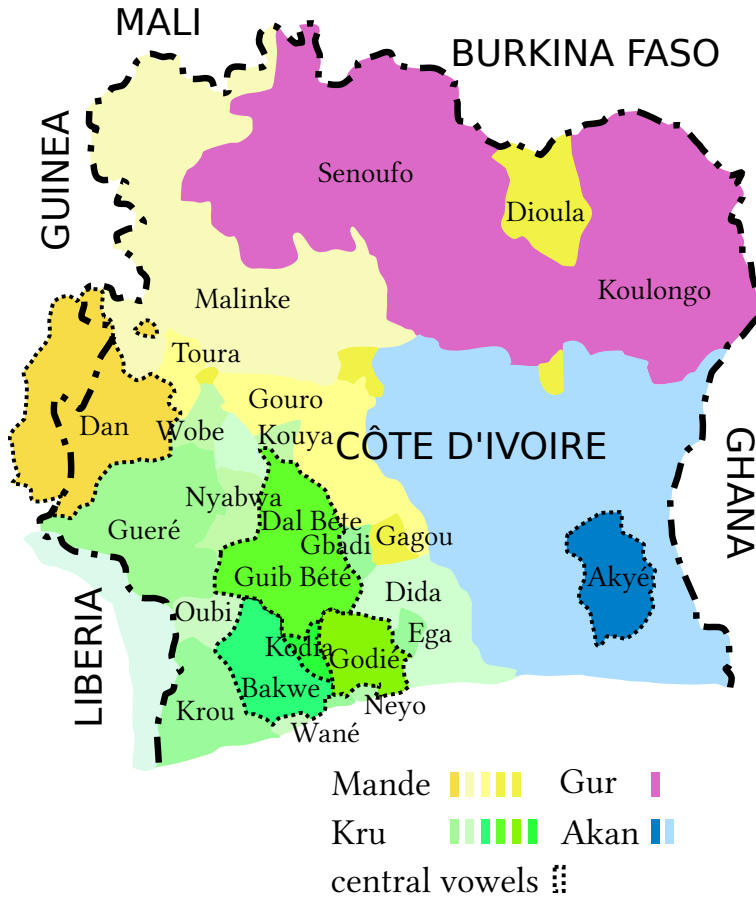

Figure 2: Map 2

gate this link, which may point to another case of language contact and areal spreading of central vowels in this region.

## 6 Historical explanations

As the above map demonstrates, one problem with the areal hypothesis concerning central vowels in subsets of southern Mandé and Kru is that currently Dan is separated from the centralizing Eastern languages by a huge space occupied by Western Kru, where central vowels have not innovated. This fact suggests that historical explanations may need to come into play. If central vowels are a shared feature of Mandé and Kru, this would suggest at some point the Dan peo-

ples and the ancestors of the Godié-Bété branch of Eastern Kru and/or Bakwé were geographically contiguous. Thus, in this case, linguistic evidence may help us determine certain people movements.

Despite late oral traditions describing a movement of Kru peoples from west to east (i.e. from Liberia into the Ivorian forests), it is commonly accepted that the Kru were once located much further north, and then were pushed down into the forest by the Mande expansion. S. Lafage (1983) traces the Kru immigrations towards the south in three stages:

- 14<sup>th</sup> to 18<sup>th</sup> century: Mandes and Kru were positioned “on the Niger”, with the Mande pushing small Kru groups into the forest.
- 15<sup>th</sup> century onward: the Kru move towards the coast (in light of European trade, including the slave trade).
- 18<sup>th</sup> century: the arrival (in waves) of the Akan from the East would have pushed the Kru further south and west. Kipré (2005: 68) notes as well that in the 18<sup>th</sup> there were early Akan infiltrations and a certain “akanization” of certain Dida villages.

Though the individual Kru groups appear to be fairly autonomous, Kipré also notes a high level of contact not only between Kru themselves, but between Kru and Mande groups, describing a process of “compression”:

[in Côte d’Ivoire] ...several peoples were in contact with one another, interpenetrating each other, whether easily or not, certainly not without conflict. There were frequent confrontations between Gouro and Bété, between Gagou and Bété, between Dan and Wè during this time frame. Also we have here a “transition zone” where several peoples are **pressed together in a kind of “metissage culturel”**... Niabwa and Nidedboua are squeezed between Wè and Bété; the Bakwé’s are squeezed in between the Southern Kru and the Bété...”

This kind of geographic as well as socio-cultural ‘compression’ point to conditions which could easily lead to linguistic borrowing and the development of areal features. Kipré goes on to note (2005: 69) that within Côte d’Ivoire the “progressive interpenetration of peoples makes the idea of ethnic groups as ‘pure peoples’ (or races) inappropriate”.

What do these facts tell us? Probably that present territorial placements of various ethnic groups do not reflect past history. It is likely, for example, that the Dan tribes came into contact at an earlier period with parts of what today is the Godié-Bété branch of Eastern Kru, where central vowels were innovated. Despite the fact that the Mande would be considered the “dominators” over the last three to four centuries (Lafage 1983; Vydrine 2009: 108), it is possible that

the Mande super-stratum assimilated some of the substratum language features, especially on the phonological level. Recent scholarship suggests other “higher” areal features for a wider region such as a common S AUX O V word order may have come from the other direction, namely from Mande to Kru (Güldemann 2008; Sande et al. 2019). Besides past historical contact and borrowing, it is clear that foreigners of all provenances (Mande, Akan, etc.) have penetrated and continue to penetrate into the rich and fertile Kru territory.<sup>12</sup> Will such mixing lead to more language change and sharing of other linguistic features?

## 7 Conclusions

In this study, we have tried to go beyond Vydrine’s initial observations (2009), to study in some detail the innovation of central vowels in a subset of Eastern Kru languages, with the locus of initial change presumably being the Godié-Guibéroua Bété complex, possibly before this group subdivided into today’s individual languages. It seems highly probable that Bakwé, a Western Kru language, but contiguous to Godié, has acquired central vowels through language contact. It may be the case that current central vowel innovations maybe constitute cases of language contact within the Kru group itself. However, Western Kru has, for whatever reasons, resisted any such innovation, perhaps due to its already very full vowel inventory.

In terms of the wider region, it would appear that two or three southern Mande languages have indeed incorporated central vowels through language contact, despite what appears to be a dominator-dominated social scenario.<sup>13</sup> Our data might suggest that the innovation of central vowels in Godié-Bété occurred rather early, that the Dan-Kru contact occurred sometime after that, but still quite some time ago, in a linguistic and geographical setting quite different from that of today. It is possible the Godié-Guibéroua Bété were initially in closer geographic contact with Dan-Glio than Western Wè was (currently contiguous to Dan), and that the Godié-Guibéroua Bété group “moved on”, pushing further down into the forest into their current position, while the Wè peoples seem to

---

<sup>12</sup>Lafage (1983: 54) notes for example that in Côte d’Ivoire today in Kru regions, Krus are in the minority, for example in the prefecture of Daloa, prior to 1980, the following figures held: Kru (from the region) 27.81 %; Non Ivoirians, 25.49 % ; Akan, 18.74 %; N. Mande, 13.64%; S Mande, 9.71%; Gur, 4.57.

<sup>13</sup>Bonny Sands (p.c.) suggests that in some African cultures, speaking “differently” is a way for leaders to gain social status and upward mobility. Could this be behind the adoption of Kru central vowels among the Dan dialects?

have moved in between them and their Mande neighbors. It remains to be seen if any traditional accounts or historical evidence exists to justify such a scenario.

The conditions and mechanisms leading to central vowel innovation are multiple and certainly have not all been identified. The means by which areal features propagate is also not clear, but hopefully we are beginning to better understand these kinds of phenomena, and we may learn more as we continue to watch central vowels emerging (and perhaps spreading) within Kru (and beyond).<sup>14</sup>

## Acknowledgements

Thanks to H. Sande, J. Singler and V. Vydrine for comments on this and/or a previous version of this paper, to Dada Jean, I. Egner, P. Saunders, C. Leidenfrost, C. Wuesthoff and L. Wolfe for information on data as well as a special thanks to B. Alvarez for maps and H. Sande for formatting. French quotations are translated by myself.

## Abbreviations

1	first person	PL	plural
PERF	perfective	SG	singular

## References

- Association Gwëjekɔmɔ. 2004. *Petit dictionnaire godié: A sa gwëje zɔɔ!* Abidjan: SIL.
- Bentinck, Julie. 1978. *Etude phonologique du niaboua*. Abidjan: Publications conjointes ILA-SIL.
- Casali, Roderic F. 2008. ATR harmony in African languages. *Language and Linguistics Compass* 2/3. 496–549.
- Centre de Traduction et d'Alphabétisation en langue Bakwé. 2006. *Bakwɛwɛklüüa-pɔɔkv. (édition préliminaire)*. Méagui.
- Centre de Traduction et d'Alphabétisation en langue Bakwé. 2013. *Exposé historique sur le peuple Bakwé de l'émission radiophonique 'au cœur de la Côte d'Ivoire' de Jules Koffi Yebou*. Méagui.
- Delafosse, Maurice. 1904. *Vocabulaires comparatifs de plus de 60 langues ou dialectes parlés à la Côte d'Ivoire*. Paris.

---

<sup>14</sup>The examination of Akye central vowels is certainly a subject for further research.

- Gnahore, Dalilie Laure Inès. 2006. *Essai sur le système verbal du gabɔ̀gbɔ̀*. Université d'Abidjan. (MA thesis).
- Goprou, Djaki Carlos. 2010. *Etude phonétique et phonologique du kpəkolo, parler Bété de Gagnoa*. Université de Cocody, Abidjan. (Doctoral dissertation).
- Goprou, Djaki Carlos. 2014. Les voyelles centrales en kpəkolo. *Cahiers d'Etudes linguistiques*.
- Gratrix, Carol. 1975. *Morphotonologie du godié* (Annales de l'Université d'Abidjan, Série H). Abidjan: ILA.
- Grégoire, H-C. 1972. *Etude acoustique du système vocalique du bete (région de Guibéroua)*. Abidjan: ILA.
- Guehoun, M. Augustin. 1993. *Description systématique du dida de Lakota*. Université Stendhal de Grenoble. (Doctoral dissertation).
- Güldemann, Tom. 2008. The Macro-Sudan Belt: Towards identifying a linguistic area in northern sub-saharan Africa. In Bernd Heine & Derek Nurse (eds.), *A linguistic geography of Africa*, 151–185. Cambridge: Cambridge University Press.
- Hickey, Raymond. n.d. *Vowels before r in the history of English*. [https://www.uni-due.de/~lan300/Vowels\\_before\\_R\\_\(Hickey\).pdf](https://www.uni-due.de/~lan300/Vowels_before_R_(Hickey).pdf).
- Kaye, Jonthan. 1980. The mystery of the tenth vowel. *Journal of Linguistic Research* 1. 1–14.
- Kipre, Blé François. 2015. Interprétation phonologique des structures syllabiques CVlv et CWV du Bété revisitée. *Afrique, Langue et Cultures* 5.
- Kipré, Pierre. 2005. *Côte d'Ivoire: La formation d'un peuple*. Paris: Éd. SIDES-IMA.
- Kokora, Dago Pascal. 1976. *Studies in the grammar of Koyo*. University of Indiana. (Doctoral dissertation).
- Lafage, Suzanne. 1983. *Etude sociolinguistique de l'aire kru de Côte d'ivoire*. Abidjan: ACCT-ILA, 2 édition.
- Lewis, M. Paul, Gary F. Simons & Charles D. Fennig (eds.) 2014. *Ethnologue: Languages of the world*. 17th edn. Dallas, Texas: SIL International.
- Lynch, John. 2015. The phonological history of IaaI. *Languages and Linguistics in Melanesia* 3(1). 2–15.
- Marchese, Lynell. 1975. Morphophonologie du verbe godié. *Annales de l'Université d'Abidjan. Série H, Fasc 1*. 215–239.
- Marchese, Lynell. 1989. Kru. In Bendor Samuel (ed.), *The Niger-Congo languages*, 119–139. Lanham: University Press of America, Inc.-SIL.
- Marchese, Lynell. 1979/1983. *Atlas linguistique des langues kru: Essai de typologie, vol. LXXIII*. Abidjan: ILA.

- Martine, Seri Guezé. 1987. *Système nominal du Gbawalı (sous groupe bété)*. D.E.A., Université d'Abidjan. (Doctoral dissertation).
- Morton, Deborah. 2012. [ATR] harmony in an eleven vowel language: The case of Anii. In Michael R. Marlo, Nikki B. Adams, Christopher R. Green, Michelle Morrison & Tristan M. Purvis (eds.), *Selected Proceedings of the 42nd Annual Conference on African Linguistics*, 70–78. Somerville, MA: Cascadia Proceedings.
- Rolle, Nicholas. 2013. *Nasal vowel patterns in West Africa*.
- Sande, Hannah, Nico Baier & Peter Jenks. 2019. The syntactic diversity of SAuxOV in West Africa. In Emily Clem, Peter Jenks & Hannah Sande (eds.), *Theory and description in African Linguistics: Selected papers from the 47th Annual Conference on African Linguistics*, 667–701. Berlin: Language Science Press. DOI:10.5281/zenodo.3367195
- Saunders, Philip. 2009. *A study of the key phonological, syntactic and discourse properties of an endangered Kru language*. Encountering Kouya: University of Ulster at Jordanstown. (Doctoral dissertation).
- Vahoua, Kallet A. 2011. L'instabilité de la voyelle dans un parler Bete langue kru de Côte d'Ivoire. *Nordic Journal of African Studies* 20(2). 150–176.
- Vydrine, Valentin. 2009. Areal features in South Mande and Kru languages. In Cyffer N. & George Ziegelmeyer (eds.), *When languages meet: Language contact and change in West Africa*, 91–116. Köln: Rüdiger Köppe Verlag.
- Welmers, William E. 1973. *African language structures*. Berkeley: University of California Press.
- Werle, Johannes-Martin & Dagou Justin Gbalehi. 1976. *Phonologie et morphologie du bété de la région de Guibéroua*. Abidjan: Publications conjointes ILA-SIL.
- Williamson, Kay & Roger Blench. 2000. Niger Congo. In Bernd Heine & Derek Nurse (eds.), *African languages: An introduction*, 11–42. Cambridge: Cambridge University Press.
- Zogbo, Gnoléba Raymond. 2005. *Dictionnaire bété-français*. Abidjan: CERAP.
- Zogbo, Gnoléba Raymond. 1981. *Description d'un parler Bété (Daloa)*. Université de Paris III, Sorbonne Nouvelle. (Doctoral dissertation).
- Zogbo, Lynell. 2017. Les vestiges de classes nominales dans les langues kru: Accord et suffixes. In Firmin Ahoua & Benjamin O. Elugbe (eds.), *Typologie et documentation des langues en Afrique de l'Ouest. Actes du 27ème congrès de linguistique de la SLAO*, vol. 2017, 241–262. Paris: L'Harmattan.



# Name index

- Abasheikh, Mohammad I., 656, 658  
Abdhullahi, Mohamed Diriye, 121  
Abels, Klaus, 611  
Abo, Sharif Ahmed Omar, 120  
Aboh, Enoch, 330, 668, 678, 681, 684–686  
Aboh, Enoch O., 396  
Abramson, Arthur, 250  
Abubakari, Hasiyatu, 325  
Adams, Bodomo, 325, 396  
Adams, Nikki, 612, 619  
Adewole, Stephen Monday, 543  
Agyeman, Nana Ama, 404, 415  
Ahmed, Khalid, 590  
Aikhenvald, Alexandra Y., 410  
Aissen, Judith, 608  
Ajello, Roberto, 120, 130  
Akinlabi, Akinbiyi, 104, 427, 428  
Akumbu, Pius W., 8–10, 12  
Al Khalil, Muhamed, 572  
Ali, Mohamed Nuuh, 121, 122  
Ali, Mohammed Nuuh, 651, 662  
Ameka, Felix, 304–306  
Anagnostopoulou, Elena, 596, 600, 605  
Andersen, Torben, 518  
Androutsopoulos, Jannis, 572  
Andrzejewski, Bogumił W., 121, 130, 199–203, 207  
Ansre, Gilbert, 252, 253, 256  
Antonino, Melis, 234  
Anttila, Arto, 21, 22, 24, 37  
Aoun, Joseph, 447  
Apel, Viktoria, 354  
Appah, Clement K. I., 402  
Arellano, Jorge Eduardo, 45  
Ashton, Ethel O., 82, 84  
Awobuluyi, A. Oladele, 538, 540, 543  
Awóyalé, James Oládùntóyè Yíwolá, 539, 543, 548  
Azeb, Amha, 287, 288, 295  
Baayen, R. Harald, 279  
Baerman, Matthew, 499, 503  
Baker, Mark, 369, 371, 387, 425, 428, 435, 437, 550, 609, 623, 624, 634–636, 668, 678, 679, 681  
Baker, Mark C., 429  
Baković, Eric, 239  
Bangboşe, Ayç, 537–539, 543, 544, 550  
Banksira, Degif Petros, 54  
Bannerman, J. Yedu, 404  
Banti, Giorgio, 120  
Bargery, George P., 583  
Barkema, Henk, 397, 410  
Barker, Chris, 561  
Barrett-Keach, Camillia, 441, 444, 445  
Bastin, Yvonne, 711  
Bateman, Nicoleta, 41, 43, 49  
Bax, Anna, 600  
Beaver, David, 336

*Name index*

- Beavon, Keith H., 142, 143  
Beckman, Jill, 239  
Beckman, Jill N., 84  
Béjar, Susana, 387  
Bell, Christopher, 119, 120  
Belletti, Andrea, 627  
Bender, Lionel M., 287  
Bennett, Wm G., 43  
Bennett, Wm. G., 43, 45, 46, 53  
Bentinck, Julie, 736, 741  
Bermúdez-Otero, Ricardo, 106  
Bibiko, Hans-Jörg, 704, 705  
Bickmore, Lee, 177–180, 184  
Bickmore, Lee S., 170, 232  
Bitjaa Kody, Zachée Denis, 156  
Bjorkman, Bronwyn, 387  
Blažek, Václav, 287  
Bleek, Dorothea F., 716  
Bleek, Wilhelm H. I., 705  
Blench, Roger, 725  
Blevins, Juliette, 43  
Blommaert, Jan, 574  
Boadi, Lawrence A., 404, 407, 409, 410, 412  
Bode, Oduntan Gbolahan, 538, 539, 541, 543, 544, 548, 550, 553  
Bodomo, Adams, 21, 22, 24, 26, 37, 328, 396, 426, 428  
Boeckx, Cedric, 618  
Boersma, Paul, 16, 98, 203, 254, 272  
Bole-Richard, Rémy, 252, 253  
Booij, Geert, 417, 420  
Borland, Colin Hugh, 714  
Bossi, Madeline, 370, 388, 483  
Bostoen, Koen, 318, 319, 705, 710, 711  
Bourquin, W., 706  
Bradfield, Julian, 706  
Bradshaw, Mary M., 249–251, 253, 255, 259, 262  
Braver, Aaron, 43  
Bresnan, Joan, 597, 600, 612  
Brookes, Heather, 305, 309  
Brousseau, Anne-Marie, 362, 677, 683–685  
Brown, Lea, 423, 425, 437  
Brugman, Johanna, 707  
Brysaert, Marc, 279, 282, 283  
Buell, Leston, 217, 222, 226, 227, 625, 626, 640, 641  
Byarushengo, Ernest R., 53  
Bybee, Joan, 278, 474  
Caesar, Regina O., 530, 533  
Cardinaletti, Anna, 605  
Carlson, Gregory N., 487  
Carlson, Robert, 362, 466  
Carstens, Vicki, 369, 370, 387, 388, 556, 557, 559, 563, 569, 631  
Casali, Roderic F., 727, 741  
Cassimjee, Farida, 89, 216  
Cecchetto, Carlo, 596, 597, 600, 605, 606  
Chafe, Wallace, 326  
Chavula, Jean Josephine, 76  
Chebanne, A. M., 45, 56  
Chebanne, Andy, 707  
Cheng, Lisa, 214, 222, 226, 598, 600, 623, 625–627, 632, 633, 639, 641  
Cheucle, Marion, 141–143  
Chie, Esther P., 5  
Childs, Tucker C., 81, 305, 318  
Chisholm, William, 115  
Chistovich, L. A., 249, 250  
Chomsky, Noam, 369, 370, 375, 387, 446, 450, 606, 607, 634

- Christaller, Johannes Gottlieb, 404, 407
- Chung, Sandra, 485, 487, 608
- Cinque, Guglielmo, 605, 618
- Citko, Barbara, 609
- Clark, Brady, 336
- Clements, George N., 10, 12, 75, 85, 86, 103, 135, 137, 138, 158, 187, 688, 694
- Cohen, Kevin, 241
- Cole, Desmond T., 42, 44, 45, 47–52, 56, 57
- Collins, Chris, 426, 623, 624, 634–636, 707
- Comrie, Bernard, 361, 362, 464, 475
- Connell, Bruce, 12, 157, 158
- Cooper, Robin, 568
- Corbett, Greville G., 487
- Crane, Thera Marie, 476
- Crass, Joachim, 288
- Crazzolaro, Joseph Pasquale, 500
- Creider, Chet, 483
- Creider, Jane, 483
- Creissels, Denis, 45, 216, 356, 423, 667, 674, 676
- Crowley, Terry, 362
- Cruschina, Silvio, 600
- Crystal, David, 137
- Dahl, Osten, 470, 475, 477
- Dahl, Östen, 463, 468, 471, 475, 476, 521, 522, 535
- Dakubu, Mary E. K., 522, 525, 527
- Danet, Brenda, 572
- Dassidi, Ezéchiél, 242
- Daulton, Frank E., 573, 574
- Davis, Stuart, 114
- De Cat, Cecile, 605
- de Lacy, Paul, 237, 241
- Deal, Amy Rose, 369, 382
- Deed, Florence, 656
- Delafosse, Maurice, 727
- Demolin, Didier, 140, 271, 277
- Den Dikken, Marcel, 552, 553
- Devos, Maud, 222
- Diallo, Mohamadou, 674
- Dichabe, Seipati Bernice, 45
- Dickens, Patrick, 705, 707
- Diercks, Michael, 371, 374–377, 387, 388, 390, 483, 596, 597, 600, 625, 629, 631, 632, 634
- Diesing, Molly, 601
- Dieu, Michel, 143
- Dik, Simon C., 354
- Dimmendaal, Gerrit J., 156, 512, 674
- Dingemanse, Mark, 81, 84, 305
- Dixon, R. M. W., 410
- Doke, Clement M., 77, 714
- Doke, Clement Martyn, 706, 714
- Donzo, Jean-Pierre, 319, 710
- Dougère, Lucie, 142, 143
- Downing, Laura J., 76, 77, 79, 85, 214, 222, 226, 252, 598, 600, 623, 625–627, 632, 633, 639, 641
- Downing, Laura Jo, 114, 155, 157
- Driemel, Imke, 97
- Dryer, Matthew S., 423, 425, 437, 671, 676, 688, 690–692
- Duah, Reginald A., 325, 337, 338, 418
- Duncan, Philip T., 425, 427, 428
- Durand, J. B., 25
- Duthie, Alan S., 264
- Dyakonova, Maria, 396
- É. Kiss, Katalin, 325–329, 338
- Eastman, Carol M., 306
- Ebarb, Kristopher J., 179

*Name index*

- Edmondson, Jerold A., 199, 201, 202, 210  
Ehret, Christopher, 121, 122, 651, 656, 661  
Eiseb, Eliphaz, 707  
Elderkin, Edward D., 717  
Elfner, Emily, 166, 224, 239  
Emonds, Joseph, 543  
Essien, Okon E., 424, 425, 428  
Ewan, William G., 138  
  
Faust, Noam, 501, 504  
Faye, Souleymane, 350, 352, 356  
Faye, Waly, 349–353, 355–357, 363, 364  
Faye, Waly Coly, 349, 352  
Fehn, Anne-Maria, 704, 715, 716  
Fennig, Charles D., 287, 349  
Ferguson, Charles A., 288, 306  
Fiore, Lynne, 95, 96, 99, 103, 113, 114  
Fleming, Harold C., 287  
Ford, Kevin C., 12, 187  
Forster, Kenneth, 279  
Fox, Danny, 441, 442, 451–454, 456, 457  
Frank, Wright Jay, 499, 500  
Fransen, Margo Astrid Eleonora, 95, 96, 98–100, 103, 110, 113, 114  
Fraser, Bruce, 304  
Frege, Gottlob, 484  
Fries, Charles C., 304, 318  
Fromkin, Victoria, 137  
Fujisaki, Hiroya, 304  
Fulop, Sean A., 706  
  
Gbalehi, Dagou Justin, 727, 729, 730  
Ghazeli, Salem, 202  
Gil, David, 304, 318  
Gillon, Carrie, 484  
  
Gisbert, Fanselow, 340  
Givón, Talmy, 354, 355, 363  
Gjersøe, Siri, 99, 189, 501, 505, 514  
Gnahore, Dalilie Laure Inès, 732  
Goldie, Hugh, 425  
Goldsmith, John, 75, 85, 86  
Good, Jeff, 354, 687  
Goprou, Djaki Carlos, 732, 738, 740  
Gordon, Matthew, 78, 84  
Gratrix, Carol, 726, 738  
Grebe, Karl, 6  
Grebe, Winnifred, 6  
Green, Christopher R., 120, 124, 128, 199, 204  
Greenberg, Joseph H., 137, 671, 674  
Grégoire, H-C., 727  
Gregory, Michelle L., 354  
Grenoble, Lenore A., 304–306, 315  
Grice, H. Paul, 380  
Grimm, Nadine, 139, 141, 142, 144, 149  
Grimm, Scott, 23  
Grossman, Eitan, 501  
Grosz, Barbara, 599  
Gruber, Jeff, 707  
Gruber, Jeffrey S., 707  
Grubic, Mira, 492  
Guehoun, M. Augustin, 741  
Güldemann, Tom, 354, 694, 704, 705, 717, 747  
Gunnink, Hilde, 705, 708, 711, 713  
Gussenhoven, Carlos, 75, 114  
  
Haacke, Wilfrid H. G., 707  
Haiman, John, 360  
Halle, Morris, 202  
Halliday, M. A. K., 326  
Halpert, Claire, 214, 215, 598, 626, 641  
Hamann, Silke, 115  
Hamdani, Fakry, 590

- Hamlaoui, Fatima, 156, 160, 163–165,  
171  
Hammarström, Harald, 688  
Hanks, William F., 473, 474  
Hansson, Gunnar Ólafur, 53  
Harizanov, Boris, 388  
Harris, John, 84  
Harris, Zellig, 304, 318  
Hartmann, Katharina, 325, 328, 340–  
343  
Haspelmath, Martin, 463, 574  
Hay, Jennifer, 278  
Hayes, Bruce, 42, 57, 114  
Hayward, Richard J., 287, 288, 295  
Heath, Jevon, 356, 359  
Heath, Teresa, 142, 143  
Hedin, Eva, 476  
Heim, Irene, 445, 448, 454, 484, 568,  
569  
Heine, Bernd, 121, 656, 668, 679, 690,  
694, 716  
Henderson, Brent, 444, 600, 660  
Henson, Bonnie J., 142, 143  
Herbert, Robert K., 43, 49, 705  
Herring, Susan, 572  
Hess, Susan, 202  
Hickey, Raymond, 736  
Hinnebusch, Thomas J., 652, 654, 655  
Hiraiwa, Ken, 325, 396, 426, 428  
Hirose, Keikichi, 304  
Höhle, Tilman, 385  
Holman, Eric W., 708  
Honken, Henry, 716  
Horn, Laurence R., 325, 339  
Hornby, Peter A., 354  
Hornstein, Norbert, 615  
Horvath, Julia, 609  
Hudu, Fusheini, 325, 331  
Hulsey, Sarah, 451  
Hunziker, Daniel A., 717  
Hyman, Larry, 103, 114, 156, 158, 161,  
163, 179, 599, 602, 619  
Hyman, Larry M., 3, 4, 6, 8, 9, 11–13,  
16, 18, 53, 55, 75, 77, 82–84,  
114, 124, 221, 240, 252, 293,  
300, 361, 362, 623, 625, 669,  
677–681, 683  
Iatridou, Sabine, 605, 618  
Idiatov, Dmitry, 371, 674, 708  
Ikoro, Suanu, 687  
Inkelas, Sharon, 84, 90, 114  
Innes, Gordon, 670  
Ito, Junko, 156, 166, 168, 171, 224  
Jaggar, Philip J., 342  
Jake, Janice, 373, 483  
Jayaseelan, Karattuparambil A., 627  
Jesney, Karen, 239  
Job, Sylvanus, 716  
Johanessen, Janne Bondi, 430  
Johnson, Kyle, 542  
Jones, Daniel, 55–57  
Jones, Patrick J., 179  
Joshi, Amaresh, 552  
Jun, Jongho, 233, 243, 245  
Jun, Sun-Ah, 115  
Kadmon, Nirit, 492  
Kaji, Shigeki, 63, 64  
Kaltenböck, Gunther, 305  
Kambon, Obadele, 396, 397, 410, 414,  
415  
Kandybowicz, Jason, 668, 678, 679,  
681  
Katamba, Francis, 599, 602, 619  
Kawahara, Shigeto, 57

*Name index*

- Kawasha, Boniface, 371, 374, 389  
Kaye, Jonathan, 733  
Kayne, Richard, 430, 446, 605, 611, 675  
Keach, Camillia N., 441, 444, 445  
Kendon, Adam, 305  
Kennedy, Jack, 21, 22, 24, 26, 31, 32, 34  
Kewley-Port, Diane, 210  
Keyser, Samuel Jay, 54  
Khabanyane, Khathatso Evelyn, 45  
Khachaturyan, Maria, 465, 466  
Kingston, John, 202  
Kiparsky, Paul, 34, 106, 242  
Kipre, Blé François, 738  
Kipré, Pierre, 727, 746  
Kisseberth, Charles W., 75, 77, 79, 81, 85, 86, 89, 91, 180, 656, 658  
Klatt, Dennis, 249, 250  
Klein, Wolfgang, 474  
Kochetov, Alexei, 41, 43  
Kokora, Dago Pascal, 740  
Koopman, Hilda, 672, 673, 675  
Koptjevskaja-Tamm, Maria, 405  
Kotzé, Albert E., 43, 49  
Kramer, Ruth, 388, 557, 558, 565  
Kratzer, Angelika, 445, 448, 454, 482, 492, 496, 569  
Krifka, Manfred, 327, 342, 487  
Krones, Robert, 138  
Kula, Nancy C., 115, 232  
Kulkarni-Joshi, Sonal, 704  
  
Labov, William, 211, 278, 283, 476  
Ladd, Robert, 158, 166  
Ladefoged, Peter, 137, 140, 150, 270  
Ladusaw, William A., 487  
Lafage, Suzanne, 746, 747  
Laine, Antti, 712  
  
Lamberti, Marcello, 120, 121, 651  
Lambrecht, Knud, 354  
Lamont, Andrew, 234, 239, 241, 242, 245  
Landman, Fred, 492  
Landman, Meredith, 609  
Laniran, Yetunde, 158  
Larson, Richard, 166  
Lawal, Nike, 550  
Le Roux, Jurie, 45  
Le Roux, Mia, 45  
Lea, Wayne A., 251  
Lecarme, Jacqueline, 124  
Lee, Seunghun Julio, 157  
Lefebvre, Claire, 362, 677, 683–685  
Lemb, Pierre, 142, 143  
Letouzey, René, 139  
Letsholo, Rose, 371, 374, 375, 389  
Levinson, Stephen C., 339  
Lewis, I. M., 662  
Lewis, M. Paul, 121, 156, 270, 310, 311, 370, 650, 728  
Li, Audrey, 447  
Li, Shaoni, 202  
Lindau, Mona, 137  
Lindstedt, Jouko, 477  
Link, Godehard, 487  
Lionnet, Florian, 161  
Lisker, Leigh, 250  
Lodhi, Abdulaziz Yusuf, 84  
Lombardi, Linda, 237, 239  
Lord, Carol, 543  
Louw, J. A., 43, 49  
Lukusa, Stephen T. M., 705, 712  
Lynch, John, 736  
  
Maddieson, Ian, 137, 140, 144, 145, 150, 269–271, 318, 654, 717  
Magaji, Daniel J., 669, 677–681, 683

- Maho, Jouni F., 139, 141, 142  
Maïsak, Timur, 464, 476, 477  
Major, Travis, 425, 426, 428  
Makasso, Emmanuel-Moselly, 156–  
160, 165  
Malepe, Adam Tsele, 45, 53, 55, 58  
Manfredi, Victor, 668, 678  
Manus, Sophie, 180  
Maran, La Raw, 249, 250  
Marchese, Lynell, 670–672, 725, 727,  
728, 734, 737–740, 742  
Marlo, Michael R., 179, 180, 187, 597,  
619  
Martine, Seri Guezé, 730, 738  
Mateene, Kahombo, 178  
Mathes, Timothy K., 707, 715  
Matisoff, James A., 249, 250  
Matthewson, Lisa, 482, 485, 489, 490,  
495, 496  
May, Robert, 450  
McCarthy, John J., 24, 231–234, 236,  
237, 239, 243, 245  
McCawley, James, 75, 85  
McCoard, Robert W., 475  
McCollum, Adam, 54  
McGregor, William, 137  
Mchombo, Sam, 597, 600, 612  
McLaughlin, Fiona, 349, 350  
Meeussen, Achiel. E., 85  
Meinhof, Carl, 55, 124  
Merchant, Jason, 569  
Merrill, John, 349, 353  
Mester, Armin, 156, 166, 168, 171, 224  
Meyer, Julien, 305  
Meyer, Ronny, 288  
Michael, Rochemont, 326  
Michaelis, Laura A., 354  
Miestamo, Matti, 521, 535  
Miller, Amanda, 707  
Miller, Kirk, 717  
Miller-Ockhuizen, Amanda, 707  
Mofokeng, S. Machabe, 706  
Mohamed, Mohamed A., 82  
Möhlig, Wilhelm J. G., 663  
Molnár, Valeria, 326  
Monaka, Kemmony C., 114, 705  
Montoye, Henry, 283  
Moreno, Marcelo M., 120, 121  
Morimoto, Yukiko, 355  
Morrison, Michelle E., 124  
Morton, Deborah, 737  
Mous, Maarten, 288, 350, 352, 356  
Moyo, T., 714, 715  
Mphande, Lupenga, 76, 79–81, 84  
Munn, Alan, 430  
Munro, Pamela, 360  
Murray, Wayne, 279  
Mutaka, Ngessimo M., 5  
Mwita, Leonard Chacha, 187  
Myers, Scott, 184  
Naden, Anthony J., 21  
Nagano-Madsen, Yasuko, 140, 142,  
143, 146, 148, 149  
Nakagawa, Hiroshi, 707  
Namyalo, Saudah, 599  
Naumann, Christfried, 704, 705  
Ndayiragije, Juvénal, 627  
Neeleman, Ad, 611  
Neely, Kelsey, 356, 361  
Nespor, Marina, 166  
Newman, Paul, 84, 342, 575, 590  
Nformi, Jude, 97  
Ngonyani, Deo, 441, 443, 444, 446–  
448, 454, 456, 460  
Ngue Um, Emmanuel, 139, 142  
Ní Chiosáin, Máire, 54

*Name index*

- Nikitina, Tatiana, 674–676  
Nordhoff, Sebastian, 688  
Nuckolls, Janis B., 319  
Nunes, Jairo, 611  
Nurse, Derek, 649, 650, 652, 654–657,  
660, 663
- Obeng, Samuel Gyasi, 401, 402, 407  
Odden, David, 11, 12, 75, 77–79, 81,  
85, 91, 160, 166, 170, 177–180,  
185, 250, 373, 483
- Ogie, Ota, 544  
Oglesbee, Eric N., 251, 256  
Ohala, John J., 43, 57, 251  
Olawsky, Knut J., 424  
Ollomo Ella, Régis, 142, 143  
Omar, Sh Yahya Ali, 306  
Orgun, Cemil Orhan, 114  
Osam, E. Kweku, 396, 397, 404, 408,  
415, 417, 418  
Osu, Sylvester, 138
- Padgett, Jaye, 54  
Pakendorf, Brigitte, 705–707  
Palfreyman, David, 572  
Partee, Barbara H., 487, 561  
Paster, Mary, 119–122, 128, 130  
Pater, Joe, 233, 240  
Patin, Cédric, 89  
Patton, Michael Quinn, 404  
Payne, Doris L., 374  
Pearce, Mary, 252  
Peirce, Jonathan, 272, 280  
Perkins, Jeremy, 251  
Petrollino, Sara, 288, 291, 295, 298  
Philippon, Gérard, 77, 85, 86, 89  
Pierrehumbert, Janet Breckenridge,  
104  
Pierson, William, 283
- Pike, Kenneth L., 304, 318  
Plaatje, Solomon Tshekisho, 55–57  
Plungian, Vladimir, 464, 475  
Poggi, Isabella, 305  
Polomé, Edgar C., 82  
Pongweni, Alec J. C., 713  
Poulos, George, 216, 220  
Pozdniakov, Konstantin, 349  
Precoda, Kristin, 270  
Preminger, Omer, 387  
Prince, Alan, 24, 33, 105, 231, 232,  
239, 632  
Prince, Ellen F., 362  
Prost, Pr. André, 674  
Puech, Gilbert, 142, 143  
Puglielli, Annarita, 130  
Pulleyblank, Douglas, 11, 12, 53  
Putnam, Michael, 387
- Ranero, Rodrigo, 120, 121, 128, 130,  
599, 602–604, 609, 617, 619  
Rao, Meghana, 380  
Rapold, Christian J., 288  
Reid, Tatiana, 503  
Reinhart, Tanya, 354, 482, 485, 492,  
599, 601  
Remijnsen, Bert, 98  
Renans, Agata M., 333  
Renaud, Patrick, 139, 141, 142, 147,  
149  
Renaudier, Marie, 349–354, 356–358,  
365  
Rezac, Milan, 387  
Rialland, Annie, 114, 135, 137, 155, 157,  
158, 688, 694  
Rice, Curtis, 79  
Rickford, Angela E., 315  
Rickford, John R., 315  
Riedel, Kristina, 598, 600



- Rizzi, Luigi, 609, 632  
Roberts, Craige, 336  
Roberts, Ian, 388  
Roberts-Kohno, Ruth, 177, 181–190,  
192, 194  
Rodman, Robert, 137  
Rolle, Nicholas, 742  
Rooryck, Johan, 388  
Rooth, Mats, 327, 342  
Rose, Sharon, 269–271, 273  
Ross, John Robert, 431  
Rubongoya, L. T., 63  
Russell, Bertrand, 484  
  
Saah, Kofi K., 418  
Sacleux, C. Rev, 656, 660  
Saeed, John, 199  
Saeed, John I., 119, 120  
Safir, Ken, 371, 374, 375, 389, 631  
Samek-Lodovici, Vieri, 605  
Sande, Hannah, 114, 543, 550, 670,  
673, 747  
Sands, Bonny, 318, 319, 705, 713, 716  
Sapir, J. David, 233  
Sasse, Hans-Jürgen, 355, 656  
Sauerland, Uli, 451, 569  
Saunders, Philip, 726, 737  
Scannell, Kevin, 278  
Schachter, Paul, 305  
Schadeberg, Thilo, 77  
Schegloff, Emmanuel, 305  
Scherer, Klaus R, 304  
Schiffrin, Deborah, 304  
Schlebush, Carina M., 718  
Schulz, Katrin, 339  
Schulz, Stephan, 712  
Schwarz, Florian, 484  
Sebba, Mark, 540  
Segerer, Guillaume, 349  
  
Seidel, Frank, 712  
Selkirk, Elisabeth, 156, 160, 166, 167,  
223, 224, 326  
Selvanathan, Naga, 631  
Shih, Stephanie, 84, 90  
Shimizu, Katsumasa, 250  
Shimoyama, Junko, 492  
Shosted, Ryan, 269–271, 273  
Shryock, Aaron, 234, 242, 244  
Sichel, Ivy, 459  
Sichinava, Dmitriy, 474, 476  
Sicoli, Mark, 305  
Sikuku, Justine, 625, 629, 630, 632,  
634  
Simons, Gary F., 287, 349  
Simons, Mandy, 380  
Singhapreecha, Pornsiri, 552, 553  
Siteo, Bento, 713  
Skhosana, Philemon Buti, 712  
Skopeteas, Stavros, 340  
Smith, Jennifer L., 90, 287, 300  
Smith, Neil, 253  
Smolensky, Paul, 105, 231, 632  
Snider, Keith, 9, 11, 12, 16, 264  
Snider, Keith L, 96, 103  
Soi, Sameer, 718  
Somé, Penu Achille, 158  
Sommer, Gabriele, 712  
Stahlke, Herbert F. W., 253  
Starwalt, Coleen, 202  
Steriade, Donca, 42, 57, 84, 245  
Stevens, Kenneth N., 54, 202, 249,  
250  
Stewart, John M., 12  
Stewart, Osamuyimen T., 550  
Stirling, Lesley, 360, 364  
Stoneking, Mark, 705  
Storch, Anne, 500, 512

*Name index*

- Strawson, Peter F., 354  
Stritz, Timothy, 241  
Suñer, Margarita, 605  
Szabolcsi, Anna, 325, 326, 337, 338  
Szendrői, Kriszta, 160, 164, 165, 171
- Tang, Katrina E., 249–251  
Taniguchi, Ai, 563  
Ten Raa, Eric, 717  
Tewolde, Yohannes Tesfay, 269  
Thornell, Christina, 140, 142, 143, 146,  
148, 149  
Tlale, One, 705  
Torrence, Harold, 371, 374, 375  
Torend, Julius, 711  
Tosco, Mauro, 124, 651, 656, 717  
Toweett, Taaita, 373  
Traill, Anthony, 707, 715, 716  
Treis, Yvonne, 360, 365  
Trigo, Loren, 202  
Trommer, Jochen, 105  
Truckenbrodt, Hubert, 166, 167
- Urua, Eno E., 427, 428
- Vahoua, Kallet A., 732, 739  
Vail, H. Leroy, 75, 76, 79, 81, 91  
Valinande, Nzama, 179  
Vallduví, Enric, 326, 606  
Van de Velde, Mark, 708  
Van der Hulst, Harry, 12  
van der Spuy, Andrew, 222, 598, 626  
Van der Wal, Jenneke, 336, 339–342,  
599, 623, 625, 627, 634, 639  
Van Koppen, Marjo, 369  
van Koppen, Marjo, 387  
van Kuppevelt, Jan, 339  
Van Oostendorp, Marc, 105, 106, 396  
van Rooij, Robert, 339
- Van Warmelo, Nicolaas Jacobus, 218  
van Warmelo, Nicolaas Jacobus, 716  
Vanden Wyngaerd, Guido, 388  
Vandevort, Eleanor, 500  
Vendler, Zeno, 413  
Vianello, Alessandra, 660  
Vilkuna, Maria, 326  
Villalba, Xavier, 599  
Visser, Hessel, 707  
Vogel, Irene, 166  
Vossen, Rainer, 707, 713, 715, 716  
Voßen, Rainer, 712  
Vydrine, Valentin, 725, 726, 742, 744,  
746
- Wagner, Michael, 166  
Watters, John R., 423, 623, 625  
Webb, Charlotte, 233  
Weenink, David, 16, 98, 203, 254, 272  
Weinberg, Amy, 615  
Welmers, William E., 83, 736, 740,  
742  
Welmers, William Everett, 423, 425  
Werle, Johannes-Martin, 727, 729,  
730
- Westermann, Diedrich, 253  
Wiesemann, Ursula, 362  
Williamson, Kay, 725  
Willie, Willie Udo, 425, 428, 435, 437  
Wilmsen, Edwin N., 713  
Wilson, Thomas H., 652, 653, 657  
Winter, Yoad, 482  
Wong, Kwok-Lan Jamie, 590  
Wright, Richard, 249  
Wurmbrand, Susi, 387
- Xi, Cun, 136, 138  
Xu, Yi, 98, 254

Yemmene, Patrice A., 143  
Yip, Moira, 10, 11, 103, 239, 251  
Yokwe, Eluzai, 241  
  
Zaborski, Andrej, 287  
Zeijlstra, Hedde, 387  
Zeller, Jochen, 214, 215, 423, 542, 543,  
596, 598, 600, 605, 607, 608,  
612, 618, 619  
Zerbian, Sabine, 43, 49  
Zhang, Jie, 105  
Ziervogel, Dirk, 712  
Zimmermann, Eva, 105, 114  
Zimmermann, Malte, 325, 327, 328,  
340–343, 489, 492  
Ziv, Yael, 599  
Zogbo, Gnoléba Raymond, 727, 731  
Zogbo, Lynell, 739  
Zoll, Cheryl, 105, 114, 238  
Zomparelli, Marina, 305  
Zubizarreta, María Luisa, 605



# Language index

- Aari, 287  
Abo, 161  
Af-Ashraaf, 119–122, 131  
Afrikaans, 51, 241, 242<sup>4</sup>, 243–245,  
704  
Afro-Asiatic, 121, 287, 360<sup>14</sup>  
Aghem, 625  
Akan, 202, 325, 337, 338<sup>5</sup>, 396,  
397, 402<sup>5</sup>, 404–406, 408–  
410, 410<sup>6</sup>, 414–416, 418, 522,  
689, 698, 737, 744, 746, 747,  
747<sup>12</sup>  
Akuapem, 404, 414  
Akye, 744, 748<sup>14</sup>  
Amharic, 270, 271, 689, 698  
Amu, 652, 655, 656, 659–661  
Anii, 737  
Arabic, 122, 202, 572, 574<sup>1</sup>, 575, 658–  
660  
Arbore, 287  
Asante, 398<sup>3</sup>, 404, 414  
Aweera, 649, 651  
Babanki, 3–5, 5<sup>2</sup>, 6, 6<sup>3</sup>, 7, 9–13, 16, 16<sup>8</sup>,  
18  
Bafut, 362  
Bajele, 139, 142  
Bajuni, 652, 653, 655, 656, 659, 660,  
660<sup>16</sup>, 661, 662  
Bakoko, 310, 312–315, 317  
Bakola, 139, 142, 147<sup>9</sup>  
Bakweri, 180  
Bakwé, 727, 728, 730, 731, 736, 740–  
744, 746, 747  
Bambara, 674  
Banna, 287  
Bantu, 3, 5, 18, 43, 44, 53, 55, 55<sup>13</sup>, 63,  
64<sup>1</sup>, 72, 75–77, 79, 82, 84–  
86, 89, 91, 95, 135, 136, 138–  
140, 141<sup>3</sup>, 144, 145, 151, 156,  
160, 161, 166, 170, 171, 178,  
180, 181, 183, 184, 195, 196,  
213–216, 216<sup>5</sup>, 217, 220, 221,  
226, 227, 232, 311, 318, 319,  
355<sup>8</sup>, 370, 371, 389<sup>11</sup>, 410,  
476, 556, 563, 569, 595, 596,  
596<sup>2</sup>, 597, 597<sup>3</sup>, 597<sup>4</sup>, 598–  
600, 600<sup>6</sup>, 609<sup>19</sup>, 618, 619,  
623–625, 634, 653, 654, 657,  
658, 660, 662, 689, 704–706,  
710, 710<sup>3</sup>, 711–715, 717  
Bari, 241  
Basaa, 139, 141, 142, 151  
Bashadfa, 287  
Bekol, 142, 143  
Bekwel, 135, 142, 143  
Benaadir, 121, 122  
Benue-Congo, 355<sup>8</sup>, 361, 362, 669,  
677, 744  
Bomwali, 141<sup>2</sup>  
Boni, 649, 651, 654, 658, 660–662  
Bravanese, 653, 658, 660, 662  
Buli, 325

*Language index*

- Bulu, 139, 141, 144, 311–315, 317  
Bété, 727<sup>3</sup>, 728, 731–735, 738, 739,  
743, 744, 746, 747
- Cameroonian Pidgin English, 311  
Chamorro, 608<sup>17</sup>  
Changana, 713  
Chichewa, 76  
Chimiini, 658  
Chinese, 41  
Copperbelt Bemba, 232  
Cushitic, 121, 131, 287, 288, 360<sup>14</sup>, 650,  
651, 659, 717
- Dabarre, 651, 658, 660  
Dafing, 668, 669, 674, 674<sup>5</sup>, 675, 675<sup>6</sup>,  
676, 677, 680, 683, 687, 689,  
694  
Dagaare, 21–25, 32, 33, 34<sup>8</sup>, 35, 35<sup>9</sup>,  
36, 37, 325, 328, 689, 698  
Dagara, 158  
Dagbani, 325, 331, 423, 424, 689, 691,  
697  
Dahalo, 650, 651, 657, 660, 660<sup>17</sup>, 661,  
661<sup>17</sup>, 662, 717–719  
Daloa, 728, 734–736, 738, 747<sup>12</sup>  
Dan, 731, 742, 744–747, 747<sup>13</sup>  
Dangme, 530, 533  
Dhaasanac, 287  
Dida, 731, 733, 735, 736, 738, 741, 746  
Digo, 85, 85<sup>1</sup>, 86–91  
Dinka, 499, 518  
Diola Fogany, 236
- Edo, 544  
Efik, 425, 425<sup>3</sup>  
Ekegusii, 184  
Elwana, 653, 654, 657
- English, 41, 54, 54<sup>12</sup>, 55, 82, 83, 138,  
202, 251, 252, 272, 278, 279,  
281, 283, 304, 309–312, 319,  
325, 350<sup>2</sup>, 385, 411<sup>7</sup>, 424,  
430, 430<sup>8</sup>, 445, 446, 451, 457,  
457<sup>12</sup>, 459, 460, 463<sup>2</sup>, 486,  
494, 542, 543, 550, 571–581,  
583, 585–590, 596<sup>1</sup>, 614<sup>30</sup>,  
704, 736  
Ewe, 250, 252, 253, 256, 258, 262, 264,  
361
- Fante, 404, 414  
Fon, 362  
Fongbe, 668, 669, 677–679, 683–685,  
687, 689, 693, 694, 698  
French, 138, 301, 309–312, 470, 475<sup>4</sup>,  
477, 574, 748  
Fula, 353, 689  
Fwe, 705, 710–712, 717
- Ga, v<sup>1</sup>, 521–528, 530, 531, 533–535,  
735, 736  
Gagou, 746  
Garre, 651, 651<sup>6</sup>, 662  
Gàbùgbù, 728, 734  
Gbadi, 728, 731, 734  
Gbawale, 728, 735, 736, 738  
Gbe, 250, 251, 253, 266, 361, 362, 677,  
678, 681, 689  
Gengbe, 250–254, 256, 258, 259, 264–  
266  
German, 120, 279, 542, 543, 545, 550  
Germanic, 241, 362, 369, 369<sup>1</sup>, 370,  
373, 543, 550  
Godié, 726<sup>2</sup>, 727, 728, 731, 734–741,  
743, 746, 747  
Goemai, 744  
Goo, 744

- Gouro, 689, 698, 746  
Grassfields, 3, 5, 18, 95, 311  
Grebo, 670, 689, 697  
Greek, 572  
Guibéroua, 727<sup>3</sup>, 728, 731, 735, 736,  
743, 747  
Guibéroua Bété, 729  
Gur, 21, 674<sup>5</sup>, 689, 691, 725<sup>1</sup>, 747<sup>12</sup>  
Guébie, 668, 670–672, 728, 733, 734,  
742, 743  
Gwari, 668, 669, 677–681, 683, 684,  
687, 689, 693, 694, 697  
Gwere, 63  
Gyeli, 136, 138–142, 144–147, 147<sup>9</sup>,  
149–151  
Hadza, 717–719  
Hamar, 287–289, 291<sup>3</sup>, 292, 293, 295,  
295<sup>6</sup>, 296–298, 300  
Hausa, 41, 325, 342, 492<sup>14</sup>, 571, 572,  
574, 574<sup>1</sup>, 575–590, 590<sup>3</sup>,  
591, 689, 697  
Haya, 53  
Herero, 705  
Hungarian, 325, 337  
Iaai, 737  
Ibibio, 371, 374, 375, 424, 425, 425<sup>3</sup>,  
426, 427, 427<sup>5</sup>, 428, 428<sup>6</sup>,  
428<sup>7</sup>, 429, 430, 430<sup>8</sup>, 431–  
433, 433<sup>10</sup>, 434, 435, 437  
Igbo, 361  
Ikalanga, 371, 374, 375, 389<sup>12</sup>  
Italian, 597, 627, 660, 662  
Japanese, 41, 53, 58, 251, 256  
Jiddu, 651, 658  
Jikany, 500, 500<sup>1</sup>, 501, 514<sup>15</sup>  
Ju, 705, 707, 713, 716, 717  
Jula, 674, 674<sup>5</sup>  
Kalenjin, 370  
Kana, 687  
Kanuri, 575, 577  
Kara, 287  
Karanga, 713, 715  
Karee, 651<sup>6</sup>  
Karre, 651, 651<sup>6</sup>, 658, 658<sup>14</sup>, 660,  
660<sup>16</sup>, 661, 662  
Kaulong, 362  
Kazakh, 54<sup>12</sup>  
Kera, 251, 361  
Kgalagadi, 705, 705<sup>1</sup>  
Kgatla, 58  
Khoe, 704, 710, 711, 715–717  
Khoekhoe, 705–707, 716  
Khoesan, 650  
Khoisan, 704–706, 708, 713  
Khwe, 705, 711, 715  
Kihunde, 178, 179  
Kikamba, 180, 181, 181<sup>5</sup>, 183, 185, 187,  
189, 191, 194–196  
Kikuyu, 189  
Kimatuumbi, 166, 167  
Kinande, 179, 370, 634, 636  
Kipsigis, 370, 370<sup>3</sup>, 370<sup>4</sup>, 371, 373–  
377, 380, 381, 382<sup>8</sup>, 383–  
389, 389<sup>11</sup>, 481, 481<sup>1</sup>, 483,  
483<sup>5</sup>, 483<sup>6</sup>, 484, 486–488,  
495, 496  
Kirundi, 627  
Kom, 6, 18  
Konzime, 142, 143  
Korean, 41, 574  
Kouya, 726, 728, 730, 731, 735–737,  
743  
Koyo, 728, 735, 736, 740  
Koyraboro Senni, 689, 698

*Language index*

- Kpelle, 736, 740  
Kpəkolo, 727<sup>3</sup>, 728, 733, 734, 738–740, 743  
Krahn, 671, 689, 697  
Kru, 543, 668–672, 675–677, 687–690, 694, 725, 725<sup>1</sup>, 726, 726<sup>2</sup>, 727, 727<sup>3</sup>, 730, 731, 733–738, 738<sup>7</sup>, 739–747, 747<sup>12</sup>, 747<sup>13</sup>, 748  
Kubun, 716  
Kuria, 187<sup>8</sup>, 597, 600<sup>7</sup>  
Kusaal, 325, 325<sup>1</sup>, 326, 326<sup>2</sup>, 327–329, 331, 334<sup>3</sup>, 336, 338, 340, 344, 345  
Kwa, 337, 522, 535, 668, 669, 677, 683, 684, 685<sup>9</sup>, 687, 689, 725<sup>1</sup>  
Kwadi, 711, 715, 715<sup>4</sup>, 717  
Kwamashi, 711  
Kwasio, 139, 141–143, 150  
Kwena, 53  
  
Lakota Dida, 728  
Lamnsoq, 6  
Latin, 572–574, 574<sup>1</sup>  
Lebdjom, 139, 142  
Lillooet Salish, 482  
Limbum, 95, 96, 97<sup>2</sup>, 97<sup>4</sup>, 101, 103, 104, 106, 107, 107<sup>7</sup>, 107<sup>8</sup>, 110, 113–115  
Lingombe, 319, 710  
Lozi, 711, 712  
Lubukusu, 370, 374–377, 388, 389<sup>11</sup>, 600, 600<sup>7</sup>, 623–625, 628, 629, 629<sup>3</sup>, 630, 630<sup>4</sup>, 631–636, 639, 641, 642, 642<sup>11</sup>, 643  
Luganda, 63, 595, 596, 596<sup>1</sup>, 596<sup>2</sup>, 598–600, 600<sup>6</sup>, 601, 604, 606, 608<sup>18</sup>, 609<sup>22</sup>, 611<sup>23</sup>, 612, 612<sup>27</sup>, 614<sup>30</sup>, 616–619  
  
Luvale, 371, 374  
  
Maay, 120–122, 124–128, 130, 131, 651, 658–660  
Makaa, 142, 143  
Makhuwa, 623, 625, 627  
Makwe, 222<sup>9</sup>  
Malayalam, 627  
Malindi, 652, 653, 655  
Mandarin, 41, 552  
Mande, 371, 463, 668, 669, 671, 674, 674<sup>5</sup>, 675, 675<sup>6</sup>, 676, 677, 687–690, 693, 694, 726, 731, 736, 742–747, 747<sup>12</sup>, 748  
Mano, 463, 463<sup>1</sup>, 464–467, 470, 474, 475, 475<sup>4</sup>, 476, 476<sup>6</sup>, 477, 478, 689, 697  
Manyika, 600  
Marathi, 552, 553  
Marka, 119–131, 674  
Marka Dafing, 668  
Masa, 234–236, 238–240, 242, 243  
Mayan, 608<sup>17</sup>  
Mbukushu, 705, 712  
Mende, 84  
Merca, 119  
Mijikenda, 653, 654, 657  
Mojave, 360  
Mombasa, 652, 653, 655, 656  
Mpiemo, 135, 140, 142–146, 148, 149  
Mundari, 241  
Musey, 242–245  
Mushunguli, 653  
Mwiini, 649, 649<sup>2</sup>, 652, 655, 656, 658, 658<sup>14</sup>, 659–661  
Mzimba, 714  
  
Namibian Yeyi, 706, 711, 712  
Nandi, 483<sup>5</sup>



- Naro, 707, 715  
Ndau, 714, 715  
Ndebele, 705, 712, 715  
Neyo, 728, 731, 735, 736  
Nez Perce, 369<sup>1</sup>, 382<sup>8</sup>  
Ngamo, 492<sup>14</sup>  
Ngbaka, 689, 698, 710  
Ngbandi, 710  
Ngoni, 715  
Ngoshie, 311–313, 316, 317  
Nguni, 252, 705, 706, 706<sup>2</sup>, 712, 715  
Ngwato, 705<sup>1</sup>  
Nidedboua, 746  
Nij, 476<sup>6</sup>, 477  
Nilo-Saharan, 287, 499, 741  
Nilotic, 240, 287, 370, 370<sup>4</sup>, 481, 495,  
499, 689  
Njem, 142, 143  
Nkhamanga, 714  
Nkore-Kiga, 53, 53<sup>10</sup>  
Noni, 240, 689, 697  
Nuer, 499, 500, 500<sup>1</sup>, 501, 502, 504,  
506, 507, 510, 511, 513<sup>13</sup>,  
513<sup>14</sup>, 515<sup>16</sup>, 516–518  
Nupe, 41, 577, 668<sup>1</sup>, 679<sup>8</sup>  
Nyabwa, 736, 740  
Nyangatom, 287  
Nyomiñka, 349, 349<sup>1</sup>, 351, 353, 354,  
356, 358, 365  
Ogoni, 687  
Omoti, 287, 288, 295<sup>6</sup>, 360<sup>14</sup>  
Orma, 651, 653, 654, 662  
Pastaza Quichua, 319  
Pate, 652, 655–657, 660, 661  
Pedi, 713  
Phuthi, 705  
Pokomo, 653, 654, 657  
Portuguese, 662  
Ring, 3, 5, 6, 18  
Rolong, 45, 53, 53<sup>9</sup>  
Romance, 555, 568, 569, 596, 600, 606  
Ronga, 715  
Rutooro, 63, 64, 64<sup>1</sup>, 71–73  
Sabaki, 657  
Salish, 482, 495  
Sambaa, 597, 598, 600  
San, 716  
Sandawe, 650, 717–719  
Senegalese Wolof, 306, 316  
Senufo, 362  
Sere-Sine, 358  
Sereer, 355, 689, 697  
Serer, 349–358, 359<sup>12</sup>, 360–365  
Sesfontein Damara, 716  
Setswana, 42, 42<sup>1</sup>, 43, 43<sup>3</sup>, 44, 44<sup>4</sup>, 45,  
49, 53–58, 58<sup>14</sup>, 59, 216<sup>4</sup>  
Shanjo, 711  
Shingani, 120–122, 131  
Shingazidja, 89, 89<sup>4</sup>, 91  
Shiwa, 135, 136, 142, 142<sup>4</sup>, 143  
Shona, 252  
Shua, 706, 707, 715  
Sikuku, 643  
Sine, 349, 349<sup>1</sup>, 350–352, 355–357,  
363, 364  
Siu, 652, 655, 656, 660, 661  
So, 141<sup>2</sup>  
Somali, 120–128, 130, 131, 199–202,  
204, 209, 211, 649, 649<sup>1</sup>,  
651, 651<sup>4</sup>, 652–654, 656, 658,  
658<sup>14</sup>, 660–662  
Sotho, 45<sup>6</sup>, 705, 706, 706<sup>2</sup>, 712, 713  
Sowetan Zulu, 713  
Sudanic, 287, 689, 694

*Language index*

- Supyire, 362, 689, 697  
Swahili, 82–84, 306, 441–444, 446, 448<sup>5</sup>, 449, 451, 451<sup>8</sup>, 453, 454, 456, 456<sup>11</sup>, 457–460, 555–557, 560, 562–566, 569, 649, 649<sup>1</sup>, 649<sup>2</sup>, 651<sup>4</sup>, 653, 653<sup>8</sup>, 657, 658  
Swati, 705, 716  
  
Tarok, 744  
Thai, 251, 552  
Thok Reel, 499  
Tibeto-Burman, 250  
Tigre, 270  
Tigrinya, 54, 269–272, 277–281  
Tlhaping, 45, 53, 53<sup>9</sup>  
Tlharo, 45, 53, 53<sup>9</sup>  
Tondi Songway, 689, 698  
Tonga, 711  
Totela, 476, 712  
Tshivena, 223  
Tshivenda, 213, 213<sup>2</sup>, 214, 214<sup>3</sup>, 216, 216<sup>4</sup>, 216<sup>5</sup>, 217, 220–222, 225<sup>11</sup>, 226–228  
Tshwao, 715  
Tsonga, 713, 715  
Tswana, 42, 44, 55, 58, 705, 705<sup>1</sup>, 706<sup>2</sup>, 713  
Tumbuka, 76–85, 85<sup>1</sup>, 86–89, 89<sup>4</sup>, 90, 91, 714, 715  
Tunni, 651, 658, 660–662  
Turkish, 54<sup>12</sup>  
Tuu, 704, 705, 710, 715–717  
  
Ubangian, 710  
Udi, 476<sup>6</sup>, 477  
Umbundu, 619  
  
Vata, 728, 733–735, 742  
  
Vietnamese, 250  
  
Walman, 425, 437  
Wan, 675  
West Flemish, 370  
Wobe, 689, 697, 736  
Wolof, 306–309, 315  
Wè, 746, 747  
  
Xamar, 120, 122  
Xhosa, 705, 708, 717  
  
Yagua, 41  
Yao, 76  
Yapese, 271  
Yeyi, 318, 705, 706, 708, 711, 712  
Yiddish, 362  
Yocoboue Dida, 728  
Yoruba, 158, 537, 539, 541–545, 548, 550, 550<sup>3</sup>, 553, 575, 577  
  
Zina Kotoko, 250  
Zulu, 51, 214, 214<sup>3</sup>, 215, 216, 220, 222<sup>9</sup>, 598, 600, 600<sup>6</sup>, 608<sup>18</sup>, 612<sup>26</sup>, 612<sup>27</sup>, 619, 623–627, 630, 630<sup>4</sup>, 632, 633, 633<sup>5</sup>, 639–641, 641<sup>10</sup>, 642, 642<sup>11</sup>, 705, 708, 712–715, 717

# Subject index

- agreement marker, 357, 443, 444, 444<sup>1</sup>, 445, 448<sup>5</sup>
- airstream mechanism, 136–138, 149
- alignment constraint, 87, 87<sup>2</sup>, 88, 91, 232, 244<sup>5</sup>
- amplitude increase, 143, 145, 147, 147<sup>8</sup>, 148<sup>10</sup>
- animacy, 540, 555–557, 562, 564–569
- aorist, 463<sup>1</sup>, 464, 466, 466<sup>3</sup>, 468, 474, 477, 527<sup>2</sup>
- aspect, 23, 37, 38, 84, 85, 178, 216, 313, 318, 395, 395<sup>1</sup>, 403, 425, 464, 523, 530, 545, 547, 591, 670, 672, 679, 683, 695
- assertive phrase, 189, 191
- attention-getting gesture, 312, 314, 315, 318
- auxiliary, 128–130, 464, 466, 466<sup>3</sup>, 467, 475, 543, 668, 670, 672, 674, 676–681, 683, 685, 690, 695, 696
- basic vocabulary, 708, 710, 711, 717
- case assignment, 634, 639
- case feature, 635, 636
- cheek expansion, 136, 139, 145–147, 147<sup>9</sup>
- choice function, 492, 494, 495
- clause structure, 353, 668, 677, 680
- clause type, 178, 429, 534, 545
- click, 304, 307, 309–312, 315–319, 704, 705, 705<sup>1</sup>, 706, 706<sup>2</sup>, 707, 708, 710–713, 715–719
- click loss, 704, 710–713, 715–717
- closure duration, 144, 145, 148, 148<sup>10</sup>, 149, 275, 282, 283
- common ground, 379, 380, 385, 572
- complement clause, 361, 388, 458, 554
- complementary distribution, 63, 64, 214, 216, 227, 255, 290, 342, 344, 419
- complementizer agreement, 369, 371, 372, 374, 376, 382<sup>8</sup>, 389, 390
- completive aspect, 679–681
- conditional, 389, 405, 417–419, 475
- conjoint, 213–216, 216<sup>4</sup>, 216<sup>5</sup>, 217, 218, 220, 222, 223, 226, 227, 464, 466, 600<sup>6</sup>
- consecutive, 170, 171, 289, 362, 466, 467, 477
- contrastive click, 706, 715, 717
- contrastive interpretation, 326, 328
- coordination, 337, 338, 408, 424, 425, 430, 430<sup>8</sup>, 431, 433, 437, 540
- copula, 296, 464, 465, 526, 528–530
- copula clause, 526, 534
- coronal place, 234, 237, 238, 240, 243
- default agreement, 372, 374, 375, 388, 437, 561<sup>2</sup>, 563
- default place, 237, 238, 240, 241, 243

## *Subject index*

- definite determiner, 122–124  
definiteness, 484  
depressor consonant, 250, 251, 253, 261  
direct object, 217, 455, 458<sup>13</sup>, 465, 466, 508, 538, 538<sup>1</sup>, 539, 542, 596, 625–627, 629–633, 635, 636, 638, 640, 670  
direct speech, 363, 364, 467, 470  
disjoint, 213–216, 216<sup>4</sup>, 217, 218, 220, 222, 222<sup>9</sup>, 223, 225–227, 359, 362, 600<sup>6</sup>  
disjoint analysis, 226, 227  
dorsal place, 241–243  
double object, 611, 681, 683  
downstep, 12  
  
embedded clause, 361, 376–381, 381<sup>7</sup>, 386, 418, 419, 445, 457<sup>12</sup>, 458  
exhaustive focus, 328, 336–344  
  
f<sub>0</sub>, 250–252, 254–256, 258, 265, 266  
false accusation, 399, 414  
feminine, 122–125, 128, 132, 234, 237, 246, 294, 297, 574, 592  
final vowel, 69, 70, 102, 183, 189, 191, 194, 292, 297, 298, 461, 530  
first person, 86, 125, 126, 128, 373, 374<sup>5</sup>, 461, 695, 748  
focus, 25, 46, 63, 122, 156, 158, 166, 178, 183, 185, 186, 188, 189, 223, 225, 250, 254, 325–331, 333, 334<sup>3</sup>, 336, 338–340, 343, 344, 352, 354, 371, 372, 385, 387, 404, 427, 427<sup>4</sup>, 429, 432, 442, 450, 453, 464, 471, 477, 481, 502, 508, 522, 527, 590, 599, 602, 608<sup>18</sup>, 623–625, 625<sup>1</sup>, 626–629, 629<sup>3</sup>, 630, 630<sup>4</sup>, 631–633, 633<sup>5</sup>, 634–636, 638–642, 653, 670  
focus particle, 327, 329–331, 334<sup>3</sup>, 335, 336  
free variation, 45, 141, 142, 150, 291, 307, 741  
functional load, 291, 297, 319, 703–706, 706<sup>2</sup>, 708, 710–715, 715<sup>4</sup>, 717–719  
  
gap position, 444–448  
gender, 121–124, 126, 128, 131, 240, 242, 291, 291<sup>3</sup>, 292, 294, 297, 298, 300, 555, 568, 590  
glottal constriction, 140, 145, 271  
gradual place assimilation, 234, 238  
grammatical accent, 293, 298, 300  
  
harmonic improvement, 232, 233, 235, 236  
head raising, 441, 446, 448<sup>5</sup>, 450, 451, 453, 457, 459  
headedness, 668–670, 674, 675, 675<sup>6</sup>, 677, 683–685, 687, 688, 690, 693–695  
  
identificational focus, 326, 327, 330  
ideophone, 91, 590  
imperfective suffix, 25, 27, 29, 31, 36  
impersonal, 364, 372, 374, 384, 385, 388  
implicit argument, 492, 494, 495  
implosive, 135–141, 141<sup>3</sup>, 142–151  
in-situ focus, 328, 334<sup>3</sup>, 335, 337  
indefinites, 484  
indirect object, 455, 461, 538<sup>1</sup>, 625–627, 629, 630, 635, 636  
information focus, 326, 327, 329, 330, 336, 340, 344

- information structure, 150, 214, 223, 226, 227, 354, 602<sup>12</sup>, 602<sup>13</sup>
- ingressive airstream, 137, 139, 140, 145, 151
- intonational phrase, 165, 166, 214, 221, 223
- language contact, 139, 150, 712, 713, 735, 743–745, 747
- left-dislocation, 171, 354–356, 363, 595, 596, 596<sup>2</sup>, 597, 598, 605, 606, 611, 611<sup>25</sup>, 612, 616–618, 630
- lenition, 507<sup>8</sup>, 510, 511, 516
- lexical borrowing, 575, 649, 708
- lexical frequency, 270–272, 278–280, 282–284
- linguistic area, 694, 704, 715, 717, 718
- liquid, 63–73, 81, 260, 264, 265, 295, 513<sup>13</sup>, 737, 738
- locality, 375, 383, 453, 454, 454<sup>9</sup>, 455–457, 457<sup>12</sup>, 458, 459, 565–567
- long-distance dependency, 442, 443, 445, 449, 459
- main clause, 358, 361, 362, 370, 373, 375, 376, 378, 387, 389, 612
- markedness constraint, 107, 110, 113, 232, 235, 236, 239, 244
- masculine, 122–125, 128, 130, 132, 234, 237, 246, 291–293, 297–300, 574
- movement, 99, 104, 137, 140, 150, 215, 228, 276, 277, 306, 315, 334<sup>3</sup>, 370<sup>3</sup>, 388, 432, 433<sup>10</sup>, 433<sup>9</sup>, 441, 442, 444, 445, 445<sup>2</sup>, 445<sup>3</sup>, 446, 447, 447<sup>4</sup>, 448, 448<sup>5</sup>, 449–454, 454<sup>9</sup>, 455–457, 459, 460, 541–543, 545, 548, 550, 551, 596, 605–609, 611<sup>23</sup>, 611<sup>25</sup>, 612, 612<sup>26</sup>, 612<sup>27</sup>, 612<sup>28</sup>, 615<sup>31</sup>, 616, 617, 623, 624, 632, 638, 639, 655, 668, 672, 675<sup>6</sup>, 677–679, 681, 685, 687, 690, 746
- negation, 405, 406, 408, 410, 411, 413, 417, 425, 426, 428, 428<sup>7</sup>, 429, 434, 437, 484–486, 491, 521, 522, 527, 528, 530–535, 687, 696
- negative particle, 466
- negative verb, 533, 534
- nominalized verb, 299, 405, 685, 687
- nominative, 370<sup>4</sup>, 511–514, 514<sup>15</sup>, 515–517, 519, 695
- non-standard negation, 521, 528, 535
- nonderived environment blocking, 34<sup>8</sup>
- noun class, 148, 161, 349, 353, 410, 417, 444, 556, 559, 560, 563, 599, 619, 727, 739
- noun complement, 372, 378, 553
- noun complement clause, 375, 377, 384, 387
- noun phrase, 169, 353, 355, 359, 375, 376, 465, 559, 675
- object dislocation, 595, 596, 598, 602<sup>10</sup>, 612<sup>26</sup>
- object marker, 217, 353<sup>3</sup>, 597, 609, 626
- object right-dislocation, 595, 609
- object shift, 678, 683, 687, 688, 694
- overt movement, 442, 449, 450, 452, 457, 459, 460

*Subject index*

- past tense, 124, 408, 432, 569, 678–681
- perfect, 34, 83, 179, 399, 400, 405, 410, 413, 463, 463<sup>1</sup>, 464–472, 474–477, 503, 516, 524, 532, 534, 729
- phonemic inventory, 289, 303, 305, 311, 318, 319, 705
- phonological form, 396, 408, 410, 410<sup>6</sup>, 413, 416
- phonological phrase, 64<sup>1</sup>, 156, 164, 165, 165<sup>3</sup>, 166–168, 171, 191
- phrasal stress, 79, 83, 84
- pitch pattern, 251, 253, 258, 266
- placeless segments, 235
- plural form, 49, 490, 490<sup>11</sup>, 515, 588
- positional faithfulness, 238–240
- predicate coordination, 424, 425, 430, 431, 433
- primary phonemic system, 304, 307, 318, 319
- progressive place assimilation, 233, 236, 238–240, 242, 243, 245
- pronoun, 127, 128, 132, 335, 343, 350–353, 353<sup>3</sup>, 354–356, 358, 359, 361–363, 363<sup>17</sup>, 364, 441, 444, 445, 445<sup>2</sup>, 447, 447<sup>4</sup>, 451<sup>8</sup>, 456, 465, 470, 488, 493, 493<sup>16</sup>, 494, 495, 591, 612, 612<sup>28</sup>, 616, 696
- prosodic phrasing, 78, 166, 171, 220, 223
- prosodic structure, 31, 32, 114, 166, 168, 214, 221–226
- quantification, 481, 483, 487, 489<sup>10</sup>, 490, 495
- quantifiers, 484
- register, 4, 11–13, 103–106, 110, 115, 155, 156, 158, 202, 250–253, 256, 258, 265, 266, 712
- register feature, 96, 103–107, 107<sup>8</sup>, 111, 113, 115
- regressive assimilation, 233, 234, 239, 241, 242
- relative clause, 216<sup>5</sup>, 441–445, 454, 459, 484, 553
- relative pronoun, 444<sup>1</sup>
- resumptive pronoun, 444<sup>1</sup>
- right edge, 31, 34, 78, 87, 88, 103, 164, 191, 232
- scope, 218, 245, 259, 331, 333, 338, 352, 363, 433<sup>9</sup>, 441–443, 447, 449–454, 454<sup>9</sup>, 455–457, 457<sup>12</sup>, 458–460, 477, 485, 486, 491, 491<sup>12</sup>, 492, 583, 727<sup>3</sup>
- scope economy, 445<sup>2</sup>, 454, 454<sup>9</sup>, 456, 456<sup>11</sup>, 457, 457<sup>12</sup>, 458, 459
- second person, 127, 128, 351, 461, 695
- secondary predicate, 217, 220, 222, 222<sup>8</sup>, 223, 224
- selection, 557, 558, 564, 565
- semantic composition, 494, 568
- semantic extension, 574, 575, 581, 589
- serial verb, 396, 426, 428, 437, 539, 550, 553
- spectral slope, 202–204, 206, 209, 210
- speech community, 305, 306, 576, 589
- splitting verb, 538–541, 543, 545, 546, 548–551, 553
- stem modification, 499, 500, 508, 512, 517

- stress language, 79, 81, 83, 91  
 stress system, 82, 83 748<sup>14</sup>  
 subject agreement, 186, 188, 374, 388,  
 434, 437, 641, 641<sup>10</sup>, 670  
 subject marker, 148, 185, 189, 630  
 subject pronoun, 126, 127, 132, 335,  
 350, 354, 355, 358, 359, 362,  
 364, 365, 614  
 subordinate clause, 359, 419  
 subordination, 364  
 supralaryngeal cavity, 271, 276, 277,  
 284  
 switch-reference, 359, 360, 360<sup>14</sup>,  
 360<sup>15</sup>, 361, 361<sup>16</sup>, 362–365  
 syllable structure, 35, 35<sup>9</sup>, 264, 288,  
 738  
 syntactic movement, 441, 442, 444,  
 446  
 temporal adverb, 217, 600, 601, 604,  
 604<sup>14</sup>  
 tense marker, 426, 432, 679, 680  
 third person, 86, 125, 126, 128, 130,  
 188, 296, 343, 373, 384, 461,  
 695  
 third-person, 351–353, 360, 361,  
 361<sup>16</sup>, 363, 365  
 tonal root node, 96, 103–105, 107, 111,  
 113  
 tone, 3–15, 15<sup>6</sup>, 16, 16<sup>8</sup>, 18, 21, 22<sup>2</sup>,  
 34, 63, 64<sup>1</sup>, 75–85, 85<sup>1</sup>, 86,  
 87, 87<sup>2</sup>, 88, 89, 89<sup>4</sup>, 90, 91,  
 95, 96, 96<sup>1</sup>, 97, 97<sup>3</sup>, 99, 100,  
 102–107, 107<sup>8</sup>, 110–115, 124,  
 155–158, 160<sup>2</sup>, 161–164, 165<sup>3</sup>,  
 166, 169–173, 178, 178<sup>1</sup>, 179,  
 179<sup>3</sup>, 180, 181, 181<sup>5</sup>, 182–196,  
 221, 222, 232, 233, 244<sup>5</sup>,  
 250–256, 258–266, 288, 293,  
 298–300, 314, 370<sup>4</sup>, 374<sup>5</sup>,  
 405, 416, 417, 483<sup>5</sup>, 500–502,  
 502<sup>2</sup>, 503, 505, 505<sup>6</sup>, 505<sup>7</sup>,  
 506, 508, 509, 513, 513<sup>13</sup>, 514,  
 514<sup>15</sup>, 515, 522, 523, 530, 532,  
 533, 670<sup>3</sup>, 726<sup>2</sup>, 738  
 tone span, 184, 186, 191, 193, 194  
 toned, 509  
 transition vowel, 737, 738  
 universal quantifier, 447, 448, 451,  
 455, 456<sup>11</sup>, 457, 457<sup>12</sup>, 481,  
 488, 495  
 velar nasal, 10, 25, 29, 306, 496  
 verb movement, 456<sup>11</sup>, 542, 545, 546,  
 549–551, 553, 668, 669, 676,  
 677, 683, 690, 695  
 verbal gesture, 306, 307, 313, 316, 317  
 verbal inflection, 120, 130, 178, 416,  
 511  
 verbal morphology, 21, 131, 500, 501,  
 504, 511  
 verum focus, 382, 382<sup>9</sup>, 385, 386  
 voice quality, 200, 202, 210, 211  
 voiced obstruent, 252, 253, 255, 256,  
 265, 266  
 voicing amplitude, 144, 146–149, 151  
 vowel deletion, 10, 34, 68, 71  
 vowel harmony, 34, 45<sup>6</sup>, 200, 211,  
 300, 726, 727, 729, 733, 739,  
 740<sup>8</sup>, 742  
 vowel inventory, 22, 45, 199, 742, 747  
 vowel length, 21, 22<sup>2</sup>, 24–26, 29, 31,  
 33, 34, 37, 80, 114, 221, 254,  
 255, 293, 507  
 vowel quality, 25, 274, 427<sup>5</sup>, 500,  
 503–505, 512, 513, 516–518

*Subject index*

vowel shortening, 24, 27, 31, 33–35,  
289<sup>2</sup>

yesterday past, 678, 680





# Did you like this book?

This book was brought to you for free

Please help us in providing free access to linguistic research worldwide. Visit <http://www.langsci-press.org/donate> to provide financial support or register as a community proofreader or typesetter at <http://www.langsci-press.org/register>.

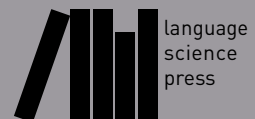



# Theory and description in African Linguistics

The papers in this volume were presented at the 47th Annual Conference on African Linguistics at UC Berkeley in 2016. The papers offer new descriptions of African languages and propose novel theoretical analyses of them. The contributions span topics in phonetics, phonology, syntax, semantics, and pragmatics and reflect the typological and genetic diversity of languages in Africa. Four papers in the volume examine Areal Features and Linguistic Reconstruction in Africa, and were presented at a special workshop on this topic held alongside the general session of ACAL.

ISBN 978-3-96110-205-1



9 783961 102051