**Vincenzo Lombardo,* Andrea Valle,*
John Fitch,† Kees Tazelaar,**
Stefan Weinzierl,†† and
Wojciech Borczyk§**

*Centro Interdipartimentale di Ricerca
Sulla Multimedialità e l'Audiovisivo
Università di Torino
Virtual Reality and Multi Media Park
Via S. Ottavio 20
10123 Torino, Italy
vincenzo@di.unito.it;
andrea.valle@unito.it

†Department of Computer Science
University of Bath
BA2 7AY, Bath, United Kingdom
jpff@cs.bath.ac.uk

**Institute of Sonology
Royal Conservatory
Juliana v. Stolberglaan 1
2595CA Den Haag, The Netherlands
tazelaar@wanadoo.nl

††Fachgebiet Audiokommunikation
Technische Universität Berlin
Einsteinufer 17c
D-10587 Berlin, Germany
stefan.weinzierl@tu-berlin.de

§Instytut Informatyki
Wydział Automatyki
Elektroniki i Informatyki Politechniki
Ślaskiej Akademicka
16 44-100 Gliwice, Poland
wborczyk@gmail.com

A Virtual-Reality Reconstruction of *Poème Électronique* Based on Philological Research

“The last word is imagination” [Le dernier mot est imagination] (Edgard Varèse, in Charbonnier 1970, p. 79): with this statement, Varèse replies to George Charbonnier, closing a 1955 interview about the aesthetic postulates of his long but difficult career. While speaking about the relationship between music and image, Varèse declares—somewhat surprisingly—that he would like to see a film based on his last completed orchestral work, *Déserts* (1954). Such a film was created only after Varèse’s death (Viola 1994; see also Mattis 1992). However, three years after that interview, Varèse did see a marriage of sound and image in his *Poème*

Électronique (1958). This seminal work was Varèse’s only purely electroacoustic work (apart from the very short *La Procession de Vergès* of 1955; Bernard 1987, p. 238), and also, to the best of our knowledge, the first electroacoustic work in the history of music to be structurally integrated in an audiovisual context (cf. Chadabe 1997).

The history of *Poème Électronique*, as documented by Petit (1958) and Treib (1996), goes back to the idea of Louis Kalf, artistic director of Philips, to exhibit the Philips technological achievements through an impressive installation to be hosted in the Philips Pavilion at the Brussels World Fair in 1958 (see Figure 1). The architect Le Corbusier conceived an electronic poem and involved Edgard Varèse to take care of the music. The multimedia

Computer Music Journal, 33:2, pp. 24–47, Summer 2009
© 2009 Massachusetts Institute of Technology.

artwork consisted of a number of different elements:

1. a pre-stressed concrete pavilion, built as a container for the multimedia artwork and designed by Iannis Xenakis, who was working at the time in Le Corbusier's studio;
2. a three-channel piece of tape music, called *Poème Électronique*, composed by Edgard Varèse, including electronic and recorded sound objects;
3. an interlude piece of tape music, *Interlude Sonore*, composed by Iannis Xenakis, which was played in the background during the change of audience;
4. a system for sound projection over clusters of loudspeakers and along "sound routes" (paths along which sound appeared to travel by being played through a succession of adjacent loudspeakers);
5. a film mainly consisting of black and white stills, selected by Le Corbusier, projected onto two approximately opposite walls; and
6. a variety of visual effects, designed by Le Corbusier in collaboration with Philips art director Louis Kalff and set up by Philips technicians.

But the Philips Pavilion was pulled down at the end of the Fair. "The building was neither intended nor destined to endure," according to Treib (1996, p. 226), and the destruction of the pavilion rendered *Poème Électronique* an incomplete masterpiece without its essential context. The preservation and maintenance of technology-based art, such as media art, electroacoustic music, or multimedia installations, is a current challenge, owing to their explicit questioning of the notion of permanence (Vidolin, Leman, and Canazza 2001; Wharton 2005). Problems arise at the institutional level owing to the involvement of multiple disciplinary domains (in this case, architectural, visual, musical, technological); at the conceptual level owing to fragmentation over several human and technological agents, multiple moments of creation, realization, and performance, and several theoretical concepts; and finally the technical level owing to the rapid evolution of technology that impedes access to works conceived

only a few decades ago. As an example, consider the recent effort to reconstruct John Chowning's computer-generated composition *Stria* (1977) in a joint musicological and technological effort (Zattra 2007). For an installation such as the *Poème*, it is not inappropriate to speak of "archaeology of multimedia" (Lombardo et al. 2006).

With its technologic and artistic complexity, *Poème Électronique* can be regarded as an exemplary case for the problem of preservation. Because the pavilion was dismantled after the end of the world fair, posterity was always confronted with fragmented documentation and the individual components of the installation. In the case of the music, the original component has been re-elaborated for distribution on stereo LP and then CD. In fact, there have been a number of releases of *Poème Électronique* on vinyl (Philips A 01494 L and Columbia MS 6146) and compact disc (Attaca Babel 9263-2; Decca 460 208-2, in which the work was played back in the small hall of the Concertgebouw, Amsterdam, and recorded with microphones; and BV Haast 06/0701, a stereo version of Kees Tazelaar's eight-channel reconstruction, including Xenakis's *Interlude Sonore*). Kees Tazelaar also realized a multichannel installation in The Hague during 2003. The mono tape of *Interlude Sonore* produced by Xenakis at the Philips offices in Paris was redone in a stereo version at GRM in 1961, and then in four channels in 1969 (Harley 2002). Those versions are 2'30" minutes long, the original version only 1'52". At the time of the pavilion, the piece was called *Interlude Sonore*; see the credits in Petit (1958). Later renamed by Xenakis as *Concret PH*, the work has gained attention in recent years as a precursor of the glitch electronica genres; see Cascone 2000 and Di Scipio 2002. The archival material includes photos (pictures of the pavilion and of the construction works, hosted at the Philips company archives, as well as a vast iconic collection described in Petit 1958 and Treib 1996); technical reports of the realization of the Philips Pavilion and of *Poème Électronique* in the Philips Technical Review (Kalff, Tak, and de Bruin 1958; Xenakis 1958); original sound tapes (archived at the Institute of Sonology of the Royal Conservatory in The Hague); films (original film material of *Poème Électronique* at the Dutch Film Museum in Amsterdam, a VHS

Figure 1. *The Philips Pavilion at the Brussels World Fair in 1958*
(Courtesy Anton Buczynski).



tape of the film of *Poème Électronique* at the Philips company archives, and a film of the construction works of the pavilion at the Philips company archives); and drawings and models (archived at Fondation Le Corbusier in Paris and the Getty Center in Los Angeles [sketches, plans, and scale models of the pavilion; schemata of the technical equipment, described in the *Philips Technical Review*; control score for the succession of visual effects; and sketches and descriptions of the visual effects]).

But the experience of *Poème Électronique*, “conceived and executed for a specific space, and perhaps more importantly, utilizing a specific sound system related to that space” (Treib 1996, p. 211), was lost. The *Poème* was received by the audience as a *Gesamtkunstwerk*: “one no longer hears the sound[,] one finds oneself in the heart of the sound source. One does not listen to sound, one lives it” (Ouellette 1966, p. 201). Varèse himself heard his music for the first time “literally projected into

space” (Varèse as quoted in Schwartz and Childs 1967, p. 207). Thus, every archival effort that seeks to preserve the essence of this aesthetic concept must allow for an integration of the music, visual elements, and their architectural realization, which was specifically designed as a delivery instrument for the multimedia content.

This article describes an integral approach to regain access to *Poème Électronique* through virtual reality (VR) technologies that include a reconstruction of the physical space in computer graphics (CG). We pursued a simulative approach to the reconstruction of the work; that is, we simulate the processing/temporal aspects of the artwork by integrating in a VR software environment all the findings of a thorough philological investigation, converted into a digital format. The final work can then be delivered as a VR installation. This approach realizes Treib’s “silver lining” about the music of the *Poème*: “[N]o recording can conjure the space as

Figure 2. *Andrès Lewin-Richter at the 2005 International Computer Music Conference exhibit in Barcelona.*



well as the sound—until perhaps virtual reality is perfected” (Treib 1996, p. 211).

The installation we deliver brings back the experience of 1958 to a great degree. This has been reported by two eyewitnesses of the 1958 event, during two public installations of the installation (at the 2005 International Computer Music Conference in Barcelona and the World Congress of Architecture of Torino 2008). The eyewitnesses were Andrès Lewin-Richter (see Figure 2) and Françoise Xenakis. Both commented that our reconstruction was “very realistic” and that they “could recall the sensations experienced in ‘58.”

The software’s modular architecture is open to new sources and new findings for integration into the simulation. We consider our approach “philological,” because we think about the *Poème* in terms of a multimedia text comprising different sub-texts (music, architecture, images). This is peculiarly true for the *Poème*, because all the components were coordinated by a score. Each of these texts must be reconstructed following a methodology based on the reconstruction of historical artifacts and conditions, following the example of textual philology. This article proceeds with a description of *Poème Électronique* and its importance from musical and multimedia-art perspectives, and then it illustrates the simulative approach to reconstruction with our VR installation.

Poème Électronique

Poème Électronique was an eight-minute synthesis of sound, light, colors, and rhythm, organized in seven thematic sections (see Table 1; cf. Treib 1996, pp. 119–120). Le Corbusier entrusted the sound component to Varèse. After agreeing on the *Poème* structure, the two artists worked independently. Varèse’s *Poème Électronique*, which remained “the most enduring fragment” (Treib 1996, p. 181) of the artwork, was realized in a dedicated studio in Eindhoven and specifically conceived for spatialization through the clusters and routes of loudspeakers of the Philips Pavilion. Le Corbusier selected the images for the film and designed the color effects.

Iannis Xenakis designed a self-supporting pavilion with walls shaped by hyperbolic paraboloid curves, over a stomach contour on the ground (see Figure 3). Spectators entered on one side and exited on the other to attend a multimedia show, with several visual components and the spatialized music; about 500 persons could fit inside the pavilion; it was estimated that two million visitors could have attended *Poème Électronique* performances during the whole period of the exhibit (Chadabe 1997, p. 61; Manning 2004, p. 82).

***Poème Électronique* and Varèse’s Music Research**

In the almost twenty years of silence separating *Density 21.5* for solo flute (1936) and *Déserts* (premiered in 1954), Edgard Varèse’s artistic research was directed toward a search for “new instruments,” considered as a necessary condition for “new music” (Varèse 1971), as well as new strategies of music projection into space. The French-American master tried to create his own electronic instrument, starting from the Dynaphone by René Bertrand. “[S]omewhat similar to the Theremin, Givélet, and Martenot electrical instruments,” the modified Dynaphone should have allowed the composer to obtain “new sounds . . . by means of loading the fundamentals with certain series of harmonics” (Varèse, quoted in Chadabe 1997, p. 59; see also Varèse 1971). But the Guggenheim Foundation

Table 1. Thematic Sections of *Poème Électronique*: Selection of Images from the Film and Sounds from the Music Soundtrack

<i>Section</i>	<i>Film images</i>	<i>Sounds</i>
<i>Genesis</i> 0''–60''	Le taureau [the bull], Le toréador [the bullfighter], Tête du jour de Michel-Ange [Head of the day of Michelangelo], Un film animé: un visage de femme s'éveillant, souriante puis ahurie [An animated film: a face of woman awakening, smiling, then dazed]	Bell, Wblock, Oscsweep, Ebtuplets, HisynSwell, GrainAb, Osc's, LoblipE-B, Metalshake
<i>Spirit and Matter</i> 61''–120''	Crane [Skull], Objets L.C. [Objects from Le Corbusier's collection], Les quatre savants [the four wise men], Tête de nègre Congo [Congolese head], Tête de fille Monebutu [Head of Monebutu girl], Courbet femme couchée [Courbet's woman lying down], Art Sumerien [Sumerian art], Squelette d'homme et dinosaurien [Skeleton of man and dinosaur], Les masques esquimaux [Eskimo masks]	Oscshake, 4hits, Shakes, Machinesweep, 3squeeks, 4bassoonnotes, Sigh, Bassoonsolo, Gulls
<i>From Darkness to Dawn</i> 121''–204''	Yeux de hibou [Eyes of owl], Tête de pintade [Head of guinea fowl], Les écrans sont blancs [White screens], Statue Dieu de la guerre [God of war statue], La main du squelette de Cro-magnon [Hand of Cro-magnon skeleton], Camp Ohreruf [Ohreruf Camp], Jouets d'enfants [Children's toys], Descente de croix de Giotto [Giotto's descent from the cross], Christ, Vierge et enfant [Virgin and child], La vierge de douleur [Virgin of pain]	Timpani, Tju-tja, Tjukketjuk, WhistleFinger, Oempang, pss-pss, Parabool, Tok-Tok, Reeds
<i>Man-Made Gods</i> 205''–240''	Île de Pâques [Easter Island], Tôto Angkor, Coquillages L.C. [Le Corbusier's shells], Bouddha [Buddha], Art Baga nègre [Black Baga art], Le signe de Mahomet [Muhammad's sign], Les mains de Bouddha [Buddha's hands]	Shakers, Slowblocks, 4notes, Vox_lowtrill, Uhh-gah, Wehweh, 4-blocks, Ooo
<i>How Time Molds Civilization</i> 241''–300''	Variations sur la tête et les outils de l'ingénieur atomique [Variations on the head and the tools of the atomic engineer], Variations sur la foule [Variations on crowd], Stratosphère	Longoo, Voxperc-hit, Percmusic, Vocal, Lowtamhit, Footsteps, Lf-beasts
<i>Harmony</i> 301''–360''	Télescope, Radar, Fusée et lune [Rocket and moon], Les L43 regardent [The L43s look], Les explosions nucléaires [The nuclear explosions], L'écheveau embrouillé [The tangled hank], Les treillis ordonnées de la tour Eiffel [The ordered wire grills of the Eiffel tower], Ballet des éléments mécaniques [Dance of mechanic elements], Visages [Faces]	Osc-cluster
<i>To All Mankind</i> 361''–480''	Laurel et Hardy, Galaxie [Galaxy], Eclipse solaire [Solar eclipse], Flammes solaires [Solar flames], Charlot, 2 amoureux sur un banc [2 in love on a bench], Noir [Black], Les bébés [Babies], Les 4 gratte-ciel Paris [The four Paris skyscrapers], New-York hirsute [Shaggy New York], Chandigarh, Nantilus Modulor, Le plan de Paris [The plan of Paris], Le plan dessiné au fusain extrait du film <i>Kast</i> [The plan drawn in charcoal, extracted from the film <i>Kast</i>], Jeu des 2 enfants [Game of 2 children], La main ouverte [The open hand], Femme seule [Solitary woman], Clochard [Tramp], Gosses [Kids], Le chemin dans la boue [The path into the mud], Le ballet des bébés [Dance of babies]	Lowperc, Loworgan, Drums, Highblocks, stereojet, Metalclang, Electricbell, Scrapes, Timbales, Organbursts, Highticks, Tonebend, Tone2jet

The descriptive names of the images and sounds are either original names from the scenario and the 30-second control score ("Tju-tja," "Tjukketjuk," etc.; see Figure 4) or guesses using a similar style ("Footsteps," "Uhh-gah," etc.). The sounds can be easily recognized in listening to the *Poème*.

Figure 3. The hyperbolic-paraboloid walls intersecting the “stomach” contour.

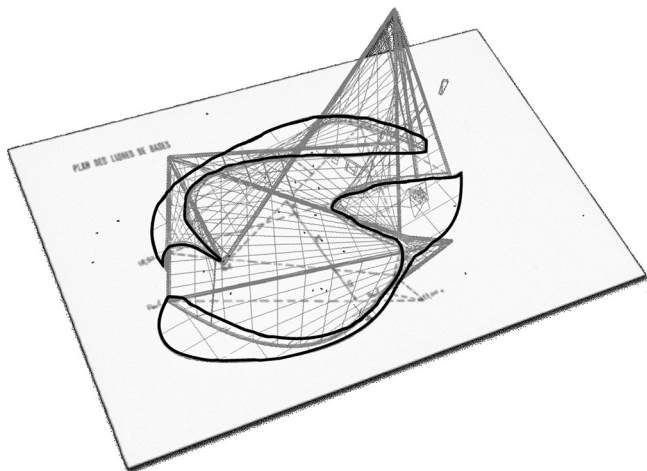

retreated its support, and Varèse's project remained unrealized (Wen-Chung 1971; Chadabe 1997).

The other pole of Varèse's aesthetics, namely, music projection into space, was inspired by a primal sonic experience that occurred in the first decade of the 20th century in the Parisian Salle Pleyel, where Varèse was listening to Beethoven's Seventh Symphony:

“Il me semblait sentir la musique se détacher à tel point d'elle-même, en se projetant dans l'espace, que je devins conscient d'une quatrième dimension musicale” [It seemed to me that I felt the music detaching from itself to such an extent, in projecting itself into the space, that I became aware of a fourth musical dimension] (Varèse, quoted in Charbonnier 1970, p. 74; see also Cabrera 1994).

Varèse was in many ways aesthetically far beyond the possibilities that technology could enable during the 1930s and 1940s in terms of sound spatialization, hence the failure of his plans for two compositions, namely *Espace* and *Astronome*, “both involving ideas that would require electronic means for their realization” (Wen-Chung 1971, p. 50). In the 1930s, “the situation really seemed hopeless” to the composer (Varèse, quoted in Schuller 1971, p. 37). But progress after World War II brought Varèse the necessary electronic technology for two seminal works, *Déserts* and *Poème*

Électronique. In particular, the *Poème* stands out as the apex of this long-pursued research. In fact, whereas *Déserts* is still scored for acoustic instruments along with the electronic tape, the *Poème* is an entirely acousmatic piece. Avoiding altogether the scholastic opposition between studio conventions of Paris and Cologne, in *Poème Électronique* Varèse escaped both the aesthetics of the *objet trouvé* [found object] favored by the *musique concrète* school and the purity of synthetic sound endorsed by *elektronische Musik*. In the piece (see Table 1), many different sources (“machine noises, the sound of aircraft, bells, electronically generated sounds, singers, and piano and organ sounds”) are “subjected to elaborate processes of pitch transformation, filtering, and modification in their attack and decay characteristics” (Manning 2004, p. 82).

In this sense, the *Poème* constitutes a crucial reference for other fundamental electronic works, such as Stockhausen's *Hymnen* and *Telemusik* (Manning 2004, pp. 140, 144). Even if he was speaking from a perspective biased toward instrumental music, for Griffiths (1995, p. 130) the *Poème* “stands with [Stockhausen's] *Gesang der Jünglinge* and *Kontakte* in the rather small repertory of electronic masterpieces.” But *Poème Électronique* is not only relevant in terms of the way it exploits and organizes sound material (cf. Charbonnier 1970, p. 75; also see Cogan 1984 and 1991):

“There is an idea, the basis of an internal structure, expanded and split into different shapes or groups of sound constantly changing in shape, direction, and speed, attracted and repulsed by various forces. The form of the work is the consequence of this interaction” (Varèse, quoted in Chadabe 1997, p. 61).

What is relevant here is the constant reference to a spatial vocabulary that considers composition in terms of the “collision” of “sound masses” (Varèse 1971). This spatial imagery was a constant for Varèse, and spatial categories proved to be fruitful while assessing an analytical framework for the composer's instrumental scored music (Bernard 1987). In fact, *Poème Électronique* reveals this spatiality in its inner sonic structure twice: on one hand, the siren and

siren-like sounds were for Varèse—from *Amériques* to *Ionisation* through *Hyperprism*—a usual way of conveying a sense of space in music (Varèse and Hirshour 1983; Bernard 1987); on the other hand, the use of reverberation provides indices for an effective symbolization of a space (Wishart 1986).

Finally, the piece was conceived for a specific place: the Philips Pavilion. As Varèse himself pointed out, it was the first time he was able to hear his music “literally projected into space” (Blessner and Salter 2007, p. 171). Thus, to discuss the spatialization in *Poème Électronique*, we cannot neglect the physical, architectural space of the Philips Pavilion and the visual show that occurred inside the pavilion.

Architectural Space and the Multimedia Show

The integration of music and image inside a space has been said to make *Poème Électronique* (here intended as the entire installation) the first modern multimedia event (Bredel 1984, p. 178)—and, one could argue, an *ante litteram* virtual-reality installation. As noted by Sterken: “Based principally on illusion, the immersive experience the audience lived in the Philips Pavilion does not actually largely differ from the way virtual reality is evoked today” (Sterken 2001, p. 266).

Poème Électronique foreshadows many current multimedia installations. Its main spatial property derives from the peculiar nature of the architectural space. The Pavilion’s structure is explicitly thought of as an envelope—a bottle (in Le Corbusier’s original idea), a tent, a shell—thus underlining the relevance of the internal against the external. A true tactile theatre, Pavilion’s curved surfaces (following the model of hyperbolic paraboloids that arise many times in Xenakis’s architectural and musical thought) are explicitly described in terms of stretched “pellicles” covering its internal space (Xenakis 1979, p. 53). The Pavilion exhibits a

passage d’une conception translative du volume (élévation issue du plan par translation verticale), à une conception nouvelle du volume, réellement à trois dimensions distinctes et non homomorphes [shift from a translative concep-

tion of volume (elevation from the plan through vertical translation) toward a new conception of volume, really in three distinct and non-homomorphic dimensions] (Xenakis 1958, p. 2).

In this sense, “Xenakis’s architecture was an early and explicit manifestation of the deconstruction of Cartesian space” (Sterken 2001, p. 266). The Pavilion is a real *lisse* space (see Deleuze and Guattari 1980 for a discussion), i.e., local and lacking a center, in which every place is given the same perceptual relevance:

un volume décentralisé, non uniforme, dont toutes les parties soient également intéressantes, sans point focal au centre, autour de quoi les gens risquent de s’agglomérer [a decentralized, not uniform, volume, in which all parts are equally interesting, without a focal point at its center, around which the audience would risk to agglomerate] (Matossian 1981, p. 132).

This *lisse* (smooth) quality was enhanced by the multiplication of visual foci. The whole Pavilion was a curved surface. The *écrans* [screens] deformed the projected black and white stills of the film (see Figure 4a), and the centrality of the projected content was blurred by four other visual effects. The result of all four of these effects was a visual disorientation, and the audience, immersed in the darkness, could not really recognize the pavilion’s internal structure.

Ambiances

Ambiances refers to composite effects creating several chromatic zones inside the pavilion. In general, there were three zones (see Figure 4b): the main surface (middle dark area in the figure), lower horizon, and higher accents (the two top light areas in the figure).

Hanging Objects Receiving a Fluorescent Light (“Volumes”)

There were two hanging objects: a female mannequin and the “mathematical object” (see Figure 4c), the latter being a geometric object made of metallic tubes.

Figure 4. (a) One of the two screens in a photo of the original show; (b) ambiance schema; (c) a reproduction of the mathematical object,

currently situated on the Eindhoven campus; (d) two of the tritrous (at upper left), from the virtual reality reconstruction. (Figures 4a

and 4b reproduced from Philips Technical Review, Kalf et al. [1958], courtesy of Philips Company Archives.)



(a)

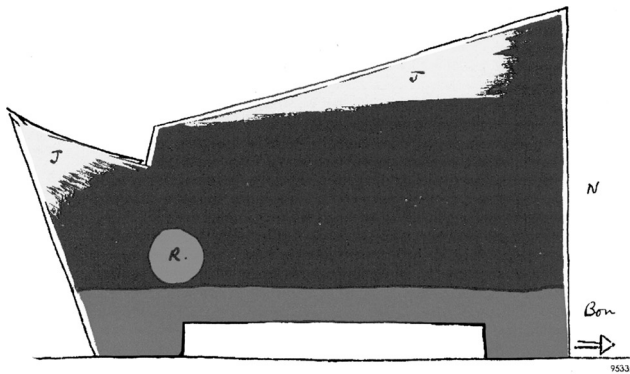

(b)



(c)

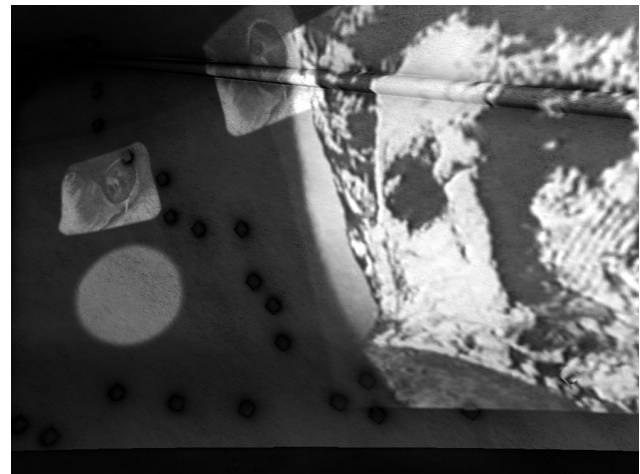

(d)

“Tritrous” Colored Spots

Colored spots, sometimes filled with photographic images, were projected around the *écrans*. For example, in Figure 4d, the main screen displays Michelangelo’s statue “Head of the day,” while the two *tritrous* on the left each contain a photo of a baby.

Other Projected Elements

Other projected elements included a red circle (a “sun” in the schema above, also visible in Figure 4d),

a white circle (a “moon”), colored spots (“clouds”), and glittering bulbs (“stars”).

Gesamtkunstwerk

The Pavilion was a realization of the Wagnerian hypothesis of a *Gesamtkunstwerk* in the modern era, in which the scenic space is transformed into a part of the whole work of art. It is well known that electricity has profoundly altered the “sense of place,” allowing the diffusion of sound independently

from its physical source (see Meyrowitz 1986 for a discussion, following McLuhan 1964). In the Philips Pavilion, this detachment was exploited to the highest degree, thanks to the circulation of three layers of sound material through 350 loudspeakers. Xenakis's research on the continuously curved morphology of the Pavilion, together with the use of asbestos as sound-absorbing material, led to an architectural space that was unique in its apparent lack of reverberation. A strange cavern with no echo, the Pavilion was responsible for a consequent paradoxical effect on the audience, as it gave both the sensation of being "in the heart of the sound source" and of being surrounded by moving trajectories of sound.

This paradoxical nature is a distinctive feature of the whole work. The projected images oscillate between the rationalism of Le Corbusier's architecture and the primitivism of various ethnic masks and objects (see Table 1). Varèse's sounds include both apparently synthetic sounds and primitivistic meaningless vocal emissions. It can also be noted that the order of the ruled surface geometry, as seen from the outside, is completely overturned by the dark, cavern-like internal space (Ouzounian 2007).

The automation mechanism of *Poème Électronique* was extremely complex. In addition to the controls of the individual content elements (sound motion, sound positioning, light switching, *tritrous* projection, film projection, etc.), all the components were to be synchronized together. A 15-channel tape, called the "control score" (Kalff, Tak, and de Bruin 1958), automated two logically separate timetables. Figure 5a shows the visual *minutage* (timing, Petit 1958), represented as a 480-row table (one row per second), with one column for each visual element; the aural score was implicitly represented by the three tracks with the succession of sounds, together with the routing of these sounds over the loudspeaker groups in the control score. Figure 5b shows a partial representation of the "control score." In particular, we see control channels 7–11, reserved for sound routing. The Philips Pavilion and the *Poème* were a real technological and artistic hapax, having no successors until the Montréal Expo (1967), where Xenakis presented

the first of his *Polytopes* (Treib 1996; Harley 2002).

Reconstruction

The simulative approach pursued in this paper follows the operation cycle shown in Figure 6. From the philological investigation of artwork, we collected documentation and content elements. After an analysis of this material, we devised a model of the artwork and digitized the content elements and implemented a corresponding virtual reality environment. This led to the VR installation that can be delivered to an audience. Audience interaction triggers the retrieval of further material, a revision of the model, or a reimplementa-tion of the VR environment.

The strength of the simulative approach is the implicit constraint on the coherence of the artwork model, enforced by the implementation of the VR environment. All the content elements, once digitized or realized in computer graphics, must fit in the implemented model. If this does not occur, it becomes impossible to deliver a functioning virtual reconstruction of the artwork. Finally, great attention must be paid to the installation of the VR environment. The audience must be accommodated to experience the original artwork, though with novel modalities. We believe that a simulative approach, providing we clearly state what parts result from a thorough investigation and what parts result from sustainable guesswork on missing aspects, can greatly contribute to the knowledge and preservation of the artwork, also proposing a novel means of realization. The integration of these elements in a unique, virtual environment strengthens the knowledge about the individual components and their role in the entire artwork.

Now, we describe the reconstruction process by addressing the phases of the simulative approach. Given the high demand on computational resources for the real-time processing of this approach, the reconstruction is limited to those items that made essential contributions to the aural and visual perceptions of the original installation from the central position in the pavilion; for example, the

Figure 5. (a) Visual minutage (timing) from 81 to 95 sec: this is the second section (“Of spirit and matter”), ambiance 11 (all dark with a “moon” effect). One can observe: no lighting on hanging volumes; on the screens, the “four

sages,” “heads” of several ethnic groups, and artistic samples from all over the world; on the tritrons, the “four sages” with added blue and red colored lights. The “reference” column reports the identifier from Le Corbusier’s catalog.

The notes indicate that all the heads on the screens will be “animated” to “avoid monotony and slowness. They should be alive . . .”; (b) the aural part of the control score from 2:05 to 2:35 (the only excerpt available):

three sound tracks (marked I, II, III), five control channels (marked 7, 8, 9, 10, 11). (Figures 5a and 5b reproduced from Philips Technical Review, Kalff, Tak, and de Bruin [1958], courtesy of Philips Company Archives.)

Sec	Volumos		Ecrans			Sec	Tritons	Paroles
	Mat	Fon	Notes	Vision	Référence			
81				Les quatre savants	T.113	81	Les quatre savants dans les trons éclairés en couleur bleu et rouge.	
82						82		
83						83		
84			Toutes ces têtes seront animées, c'est-à-dire qu'il faut à tout prix éviter la monotonie et la lenteur. Cela doit être vivant	Tête de nègre Congo	T.114	84		
85				Tête de nègre Haori	T.116	85		
86				Tête de nègre Hayogo	T.117	86		
87				Tête de fille Hembetu	T.118	87		
88				Courbet: femme couchée EAL 227	D.121	88		
89				Art Attique MAL 49	D.124	89		
90				Art Supérieur MAL 11	D.125	90		
91				Egypte MAL 68	D.128	91		
92				Dane D'Niého MAL 94	D.130	92		
93				Art Supérieur MAL 11	D.125	93		
94			César MAL 171	D.133	94			
95			Art Celtique MAL 212	D.135	95			

95334

(a)

equipment hidden behind the internal wall was not reconstructed.

The Space and the Physical Objects

After we retrieved a number of sketches, plans, photos, and movies about the Philips Pavilion, we devised a model through an application of the hyperbolic paraboloids, which we then transferred to a computer graphics model. This model was integrated into the VR environment of the whole application (see Figure 7).

To reconstruct space virtually, we first devised a model of the space by creating and positioning objects (such as loudspeakers, doors, walls, etc.) in the CG model on the basis of plans and sketches. Next, we matched CG objects with real photos from the archives, to verify the positions, or to tune the guesses made at the previous step. Finally, we verified the consistency of the functioning hypothesis with the supporting technical equipment that was reported to be in the original Pavilion.

The choice of the architectural elements to be reconstructed depended on the role they played in the artwork. The external geometry of the Pavilion

Figure 5. Continued.

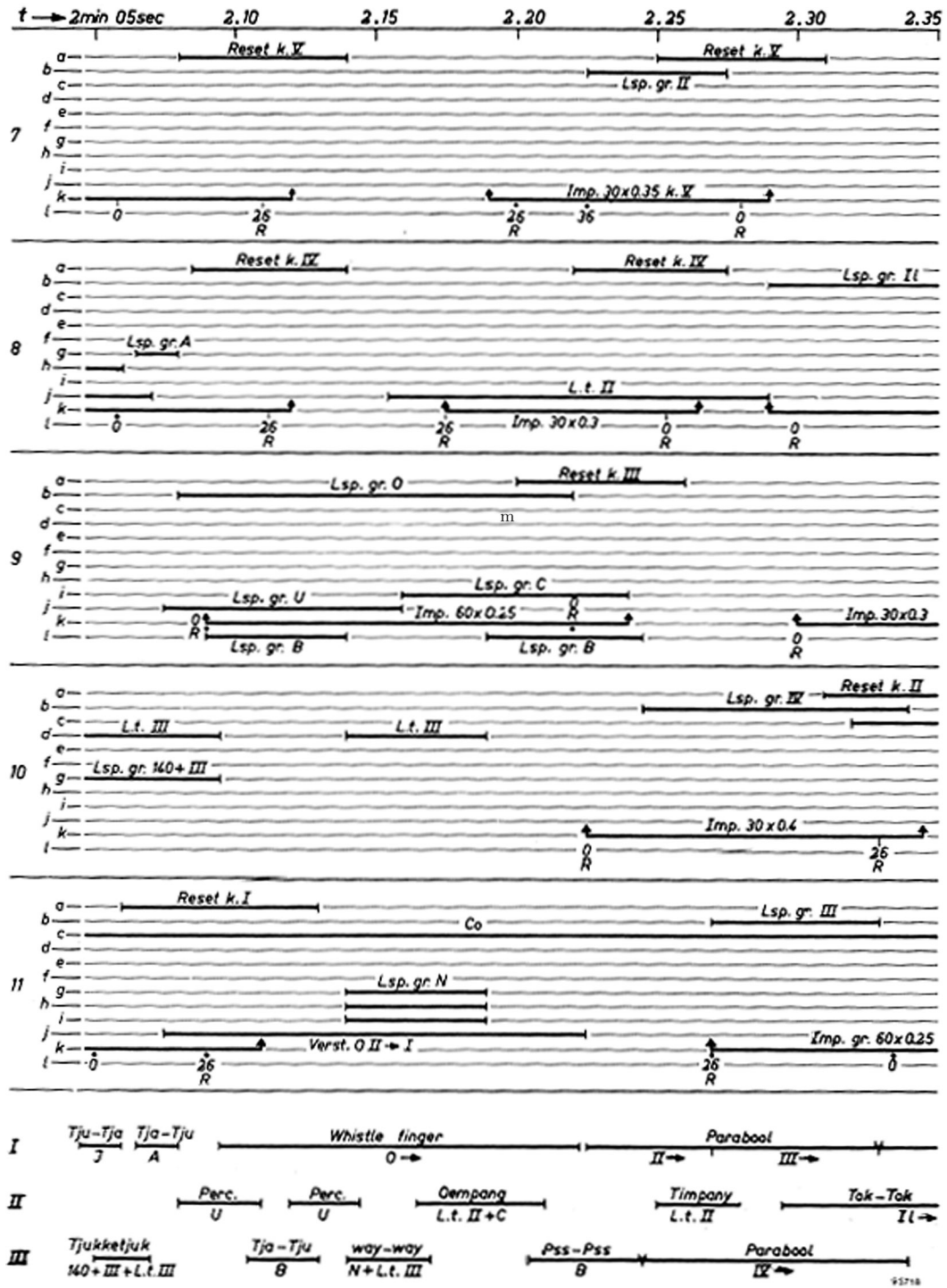

(b)

Figure 6. The simulative approach.

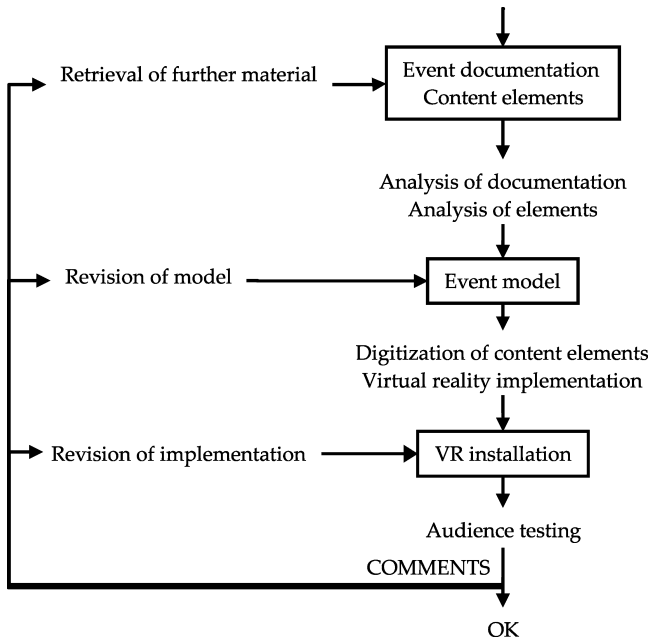

was modeled in computer graphics for validation purposes, with poorly sketched materials, because it was not included in the final VR experience (see Figure 8a). In the original Pavilion, the internal curved walls were the screens for the film and ambiance projections, creating distorted images. One goal of the reconstruction was to locate as accurately as possible the projection areas to yield the same distortion in the CG reconstruction through an analysis of the technical plans of the projectors (see Figure 8b) and validated through photo matching with pictures of the show. Surface materials of the internal walls simulated the asbestos coverage, which contributed to the visual aspects by damping the brilliance of the colored ambiances (see Figure 8c). This aspect was also taken into account for aural rendering purposes, owing to the sound absorption properties of asbestos. The surrounding wall used to hide the technical equipment (not necessary in the virtual reconstruction) was modeled, because the purple fluorescent light at the base served as a visual reference for the spectators immersed in an otherwise dark environment (see Figure 8c).

The two hanging volumes were modeled in CG owing to their role in the original show. (The

Figure 7. Computer graphics (CG) reconstruction of the Pavilion. We can recognize the loudspeakers on the

walls, the projection cabin in the middle, and the female mannequin hanging from the ceiling on the right.



visual timetable in Figure 5a reports the instants when the volumes were illuminated by fluorescent light.) Finally, the modeling and positioning of loudspeakers on the internal surfaces of the CG reconstruction was important to recreate the “decoration” of the surfaces and to implement the music spatialization (see subsequent discussion). We retrieved the specifications of the specific loudspeaker type (Philips 9710M) used in the original installation from the *Philips Technical Review*, modeled it in computer graphics, guessed at their number, positioned them on the pavilion surfaces, validated their positions through photo-matching, and then passed the loudspeaker positions onto the sound-spatialization processor.

This last item needs further discussion. The modeling, numbering, and positioning of the loudspeakers has been solved through a constraint-propagation approach by assembling a coherent picture over several information sources. The total number of loudspeakers is uncertain; the documentation sources give numbers ranging from 300 to 450 (Kalff, Tak, and de Bruin 1958; Petit 1958; Treib 1996). But we knew that the loudspeakers were organized in clusters and sound routes (five clusters and ten sound routes according to the original sketch by Xenakis; see Figure 9). A few original images provided clues to identify 243 correct positions through photo-matching on the CG model (see Figure 10). Then, empirically, with a systematic hypothesize-and-test method that took into account the association of amplifiers to loudspeakers (20 amplifiers that could feed

Figure 8. (a) External geometry of the Pavilion in the CG reconstruction; (b) positioning of the technical equipment, particularly projectors (adapted from Xenakis

et al. 1958 in Philips Technical Review, courtesy of Philips Company Archives); (c) interior of the Pavilion in the CG reconstruction.



(a)

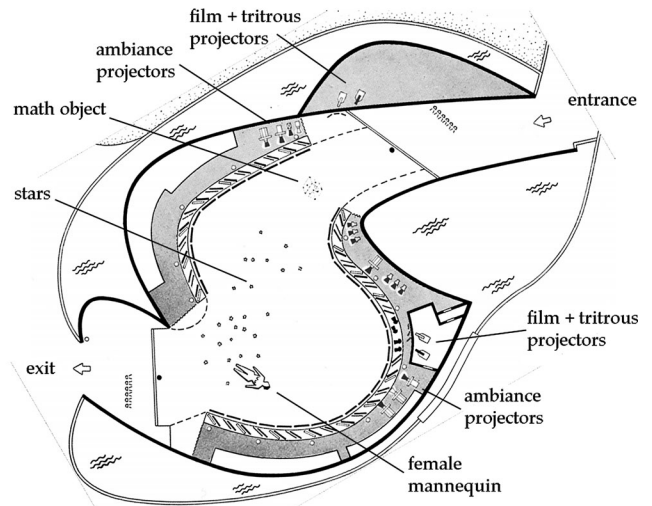

(b)

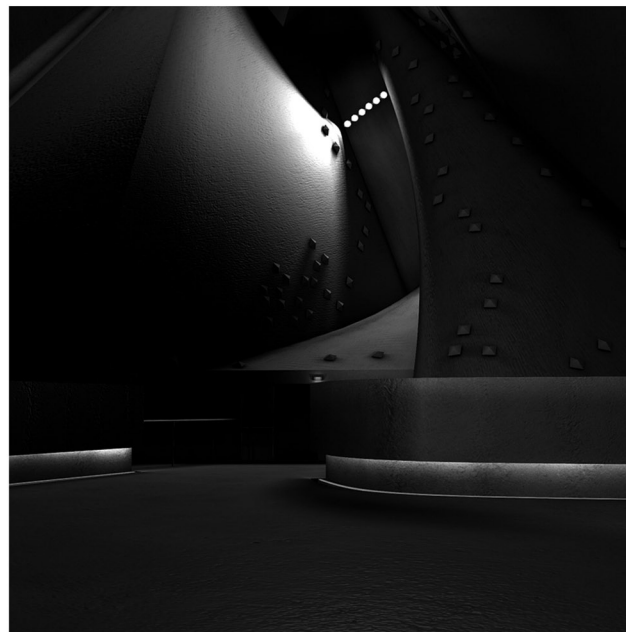

(c)

at most 12 loudspeakers each), the 52-step telephone selectors that controlled the sound routes (a sound would move along a route through arrays of five speakers of which, for each step, one new speaker

was taken in and one speaker was taken out), the distribution density of loudspeakers over the surfaces (guessed from photos), the only extant excerpt of the control score (30 seconds from 2:05 to 2:35, shown in

Figure 9. Diagram of clusters and routes of loudspeakers, adapted from Xenakis's original sketch (reported in Petit 1958).

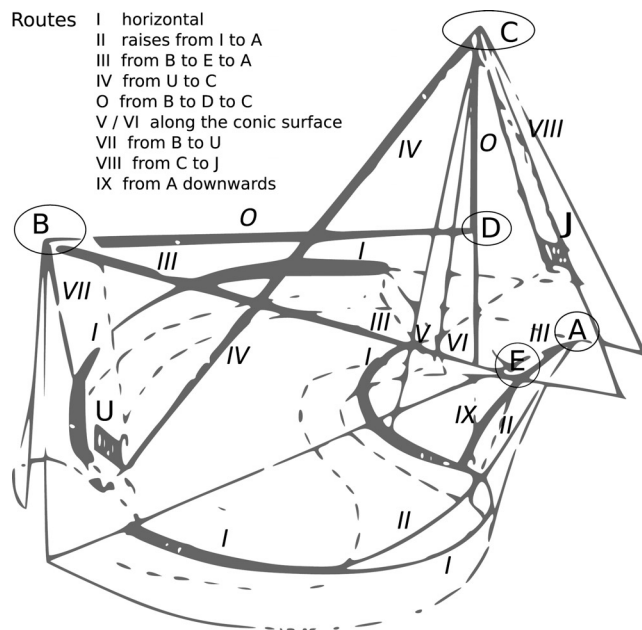

Figure 5b), we were able to locate 350 loudspeakers, as claimed in Kalff, Tak, and de Bruin (1958), organized into seven clusters and eight routes. (Notice that we ended up with 15 groups, as in Xenakis's drawing, but a different organization.) For final aural-rendering purposes, the speakers of the routes were organized into 181 five-speaker groups. Each of the seven clusters and each five-speaker group counted as an individual sound source for the virtual show, with a total of 188 virtual sound sources.

To validate the CG model, we selected a number of original photos (from the archives) that were representative of all the viewpoints, and we guessed an adequate positioning, orientation, and field of view of a virtual camera for carrying out a matching process between the original and the virtual photos.

The Visual Component

Retrieval of content elements from the visual component included the original black-and-white film, conceived by Le Corbusier, arranged by Jean Petit, and edited by Philippe Agostini; and the visual effects, conceived by Le Corbusier and Kalff and realized through a number of projection devices.

Figure 10. Loudspeaker positioning through photo-matching of the original loudspeakers in the CG model.



The film was retrieved from the Philips Company Archives on a VHS tape and digitized after a time-stretching process: in fact, the 25-frame PAL format tape shortened the original film of 8 minutes (at 24 frames per second) to 7'41". The digitized film was delivered through a player implemented in the visual-rendering process (see subsequent discussion).

The ambiances and special effects were not available contents, but they were reconstructed by taking into account the original technical setup of the installation (Kalff, Tak, and de Bruin 1958; Petit 1958). The visual effects were reconstructed from the schemata sketched by Le Corbusier and documented by Petit. These schemata were retrieved from the Fondation Le Corbusier in Paris and the Getty Center in Los Angeles. The latter schemata had hand-written marks in German, French, and Dutch, that represent decisions made at the last minute in Brussels with the goal of simplifying the color combinations. We identified 56 different ambiances, including the three color zones, the shapes and colors of the light projections, and special effects (e.g., sun, moon, lightning).

Then, we positioned the projections (in terms of graphical textures) on the surfaces again by studying the placement of projectors and other lighting devices in the CG model (based on Figure 8b). The visual rendering of all the effects was achieved through a mixture of real-time and off-line CG techniques (see Figure 11). Each ambiance was

Figure 11. Three images of the virtual show: (a) *la femme* [the woman], with the cloud effect; (b) *les quatre savants* [the four sages], with the lightning effect; and (c) *bébé* [baby], with the sun effect. See also a fourth image in Figure 4d: *Tête de jour* [head of the day], with the sun effect.



(a)

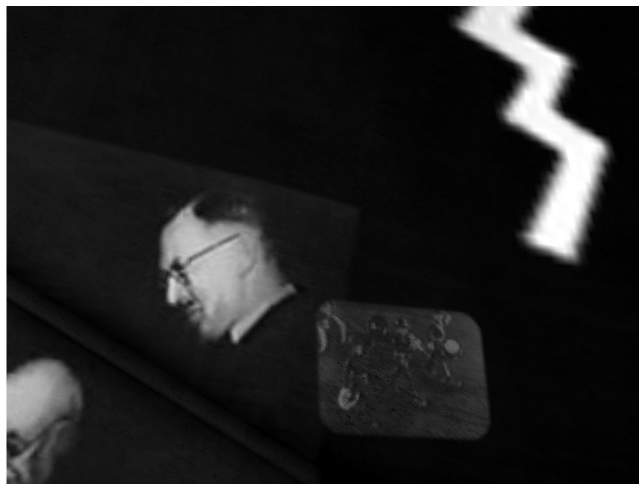

(b)

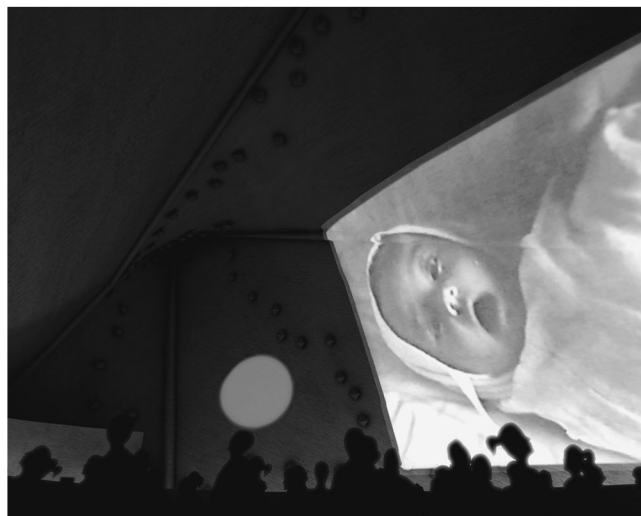

(c)

pre-calculated at design time (e.g., its lighting state is saved to light maps for performance boosting) and loaded at execution time. The result was validated through subjective testing.

Recovery of the Original Audio Material

Published versions of the music were not suitable for our reconstruction owing to the subsequent editing they had undergone; therefore, we turned

to the original tapes for our VR installation. To retrieve and recover the audio material, we searched the laboratories that contributed to the production process and the subsequent storage of the archived tapes. The tapes of the electronic compositions produced at the Philips Research Laboratories passed on to the Institute of Sonology of the Utrecht State University, when Philips closed the doors of their electronic music studio by the end of 1960. The Institute of Sonology moved to the

Figure 12. The production process of the several tapes that contained *Poème Électronique*, with a photo of the original perfo tape.

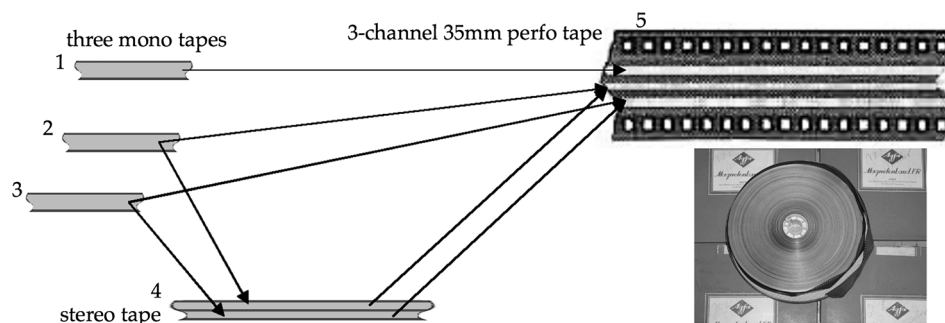

Royal Conservatory of The Hague in 1986 with its archives, and there Kees Tazelaar found the production tapes of *Poème Électronique*. There were three mono tapes, one stereo tape (1/4-inch, 30 inches per sec), and one three-channel 35-mm perfo tape of *Poème Électronique* (see Figure 12).

The common electronic-music production technique of the time was to record the various layers of a composition on individual mono tapes, which were then played simultaneously to be copied onto the master. In the case of the *Poème*, this master was the 3-channel perfo tape, a medium chosen because it allowed synchronization with the film projectors and the second perfo machine playing the 15-channel tape containing control signals. From the perfo master, perfo copies were produced: perfo tapes would break once in a while, and therefore it was important to have multiple copies of both the music and the control signals; moreover, a double set of perfo tapes was needed at all times, as one set was rewound while the other was playing.

We digitized the four pre-master tapes, which were then synchronized using the perfo master tape and the Columbia version (authorized by Varèse) as a reference. This reconstruction of the music has revealed a version of the work not heard before on record or compact disc. Comparing the pre-masters with the digitized perfo master, some differences become clear. There is considerably more distortion in the perfo recording. Also, a high synthetic sound on tape one in the interval 0:35–0:40 has a strong sub-harmonic difference tone after being copied to the perfo master. This is most likely caused by the line amplifiers of the tape recorders of that time (Philips EL3509), since a later analog copy made

at Philips Research using the pre-masters has this distortion on it, too.

To synchronize the four original separate tapes while being played back from individual machines, a sync signal was recorded simultaneously on the four tape recorders as a lead-in of the *Poème* tracks. This signal consists of regular metallic clicks and a Dutch man's voice saying, "One, click, two, click click, three, click click click, . . ." (for several minutes, not copied to the perfo tape). When the four machines were started for the final mix-down to perfo tape, these regular clicks enabled the technicians to get the playback in sync before the actual music would start by slightly manipulating the tape flanges manually. After the count-off, the three mono tapes contained the tracks for the *Interlude Sonore* (1'52" plus 8 seconds of silence) and *Poème Électronique* (8 minutes).

For the digital synchronization, the tapes were played on a modified Studer A-810, transferred to the computer, and aligned. When using the clicks to align the tracks, one immediately notices that the original machines were not completely identical in their tape speeds (a known problem of the so-called Viennese machines) and that the durations of the single tracks were different (through alignment using the sync part). Thus, we used the existing mixed versions to yield an acceptable alignment of the three tracks. We had three sources available: the perfo master, the mono soundtrack of the video copy of the film supplied by the Philips Company Archives, and the Columbia gramophone record. Because we know from chronicles (Treib 1996) that Le Corbusier and Varèse worked independently and the Columbia version was authorized by Varèse

Figure 13. (a) Sonogram from the final 30-sec excerpt of *Poème Électronique*; a tape edit is clearly visible in the final part of the sonogram,

though one pitch sweep is unaffected by this edit (that particular sound was probably recorded from a separate tape that had no edit there); (b) diagram

adapted from Varèse's hand-written sketches that were retrieved from the Philips Company Archives (see Treib 1996).

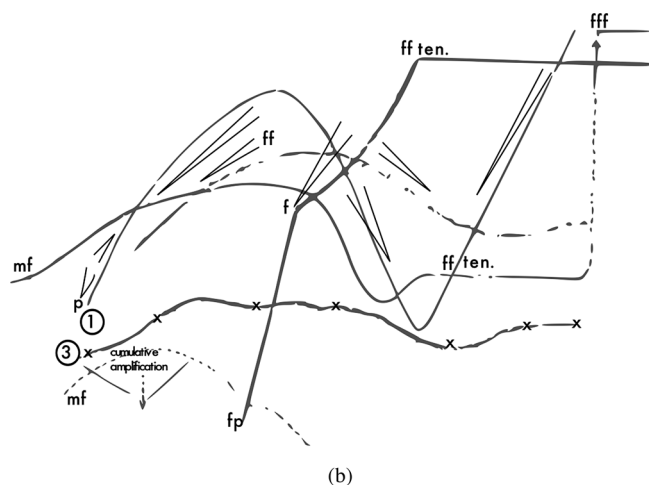
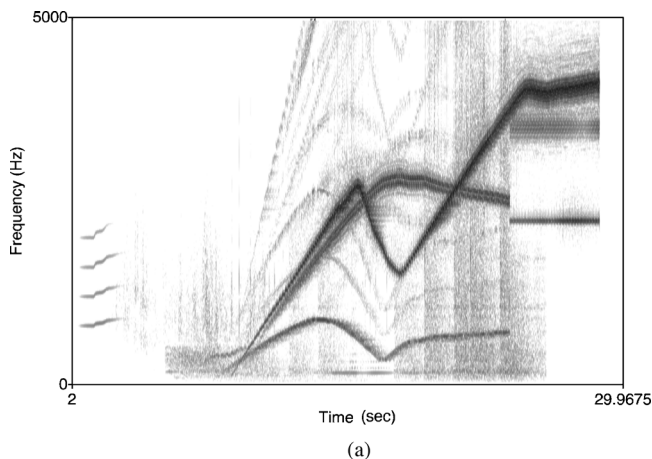

(whereas the Philips one might be not have been), we decided to use the Columbia version as a reference.

We then provided a formal validation for some parts of the digitized music. A few sketches retrieved in the Philips archives and attributed to Varèse's own hand (Treib 1996) contain indications about the dynamics and frequency content of the *Poème*. For example, the comparison between the sonographic analysis of the final seconds of the *Poème* and one of these sketches reveals a high degree of correlation (see Figures 13a and 13b; see Dobson et al. 2005). Most easily apparent to the eye, there is a collection of broadband pitched sweeps that accumulate toward the end. The track marked "1" in the sketch (see Figure 13b) matches the loudest trace on the

sonogram (see Figure 13a), and the line marked with periodic crosses and indicated with the circled numeral 3 in the sketch matches the lowest track on the sonogram. A valuable insight is also provided by the curious circular quadrant diagram at the middle-left of the sketch, which is annotated "cumulative amplification." This indicates, particularly given the copious dynamic markings, an impressive final effect, as the sounds were routed cumulatively to more and more speakers within the space.

Positional Re-Composition and Delivery Using Binaural Techniques

The documentation we retrieved for the spatialization of *Poème Électronique* included the 30-second score excerpt (2:05–2:35) that displays a very dynamic use of the sound routes, and Tak's report in the *Philips Technical Review*. We found no sources about the spatial delivery of the *Interlude Sonore*; thus, we speculated that it could have been played through the loudspeaker groups above the entrance and the exit, given that it accompanied the movements of the entering and the exiting audiences.

To devise a coherent model of the music spatialization task, we worked out a generalization of the 30-sec excerpt's spatial features and then guessed plausible solutions. We implemented the following spatial notions acquired through an analysis of the excerpt (refer to Figure 5b).

Splitting Sounds into Loudspeaker Sections at Different Locations

Evidence for splitting is the "Parabool" sound (Tape 1) sent first to Route II, and then to Route III. Similarly, on Tape 3, "Pss-Pss" and "Parabool" are sent to cluster B followed by Route IV. Therefore, it seemed reasonable to guess that some longer sounds might also be similarly split and sent to distinct clusters. The choice of the number and types of long sounds to split was an arbitrary choice, subject to our personal interpretation of Varèse's intentions.

Moving a Sound Along a Route and Wrapping It Around

In moving a sound, we guessed stepping rates (i.e., the rate at which the sound travels along a route) by dividing the duration of a sound by the length of a route, with some approximations. Wraparound in particular was used only once, for the “footsteps” section (at around 300 sec). The horizontal route (I) around the audience and the upper route (O) were the obvious candidates for this practice.

Use of Low-Frequency Loudspeakers

The 30-sec extract indicates a fairly regular use of the low-frequency speakers, often in conjunction with loudspeaker clusters. We had no evidence that woofers were combined with routes, so we avoided this.

Effects Tapes 2 and 3

We used two basic kinds of effects: a panning effect from one track to another, and a quasi-reverberation effect where the dry sound on tape 2 has a corresponding “wet” sound on tape 3. (Typically the wet sound is much louder than the dry sound.) Typical sounds that undergo this practice are “uhh-gah,” “longooo,” and “footsteps” (see Table 1). There are a few instances that are somewhat ambiguous (e.g., a very low-level dry sound—about -54dB or so—on one tape). We generally placed panned sounds on clusters. Then, we introduced one non evidence-based decision by placing one track of a “reverb-style” sound on one route, and the other (usually the “wet” sound) on a cluster. (It would be equally reasonable to do the opposite.)

The structure and pacing of effects in this spatial re-composition process followed a few musical boundaries identifiable in *Poème Électronique* (cf. Felciano 1996; Dobson et al. 2005; Kendall 2006). We individuated 15 sections; some of these could be interpreted as sub-sections within the seven thematic sections defined for the *Poème* presentation, but not always (cf. Kendall 2006). Also, we retained the given names for the extant

30-sec section; elsewhere, we used descriptive names that are connected easily to the sounds on the tapes. Names reflect any “ambiance” relationship (e.g., “4hits-pan”), and they also indicate any splitting of long continuous sounds (e.g., “stereojet(dry)” and “stereojet(wet)”).

Sound routes and clusters were implemented as Csound (www.csounds.com) instruments to explore tentatively possible alternative approaches to spatialization. The result of the digitization process was a set of 188 eight-minute-long sound files (corresponding to the 188 aggregated sound sources defined previously) containing the sound conveyed to each speaker (stored with its x , y , and z coordinates; see Dobson et al. 2005).

As a technological approach to recreate the auditory experience of the audience in the original pavilion, we chose to implement room-acoustical computer modeling and auralization through binaural technology, which ensures high fidelity in reproducing real environments (Moldrzyk et al. 2004, 2005; Weinzierl and Tazelaar 2006). The CG model of the pavilion was scaled down in resolution for room-acoustical simulation software (EASE 4.1, shown in Figure 14a).

Absorption coefficients according to the original surface of 5-cm concrete with an approximately 3-cm coating of asbestos were assigned to the inner surfaces, and this resulted in a reverberation time (RT60) of 0.7 seconds at medium frequencies in the occupied pavilion (see Figure 14b). Radiation characteristics and frequency response of an original Philips 9710M loudspeaker similar to the type used in the pavilion were measured in the anechoic chamber of the Aachen University of Technology and assigned to the loudspeakers used in the computer model (see Figure 14c).

Because we needed to keep the computational load tractable, we limited the computation of the sets of room impulse responses for each of the 188 loudspeaker groups sounding during the performance to a central listener position in the pavilion (see also the next section). They were converted to binaural room impulse responses using head related transfer functions (HRTFs) with 1° horizontal and 5° vertical resolution (Moldrzyk et al. 2004).

Figure 14. (a) CG scale model of the Pavilion for purposes of sound spatialization; (b) reverberation time of the Pavilion, expressed as time (sec) versus frequency

(Hz), with curves that show different ways of calculating the time; (c) frequency response of the original Philips 9710M loudspeaker.

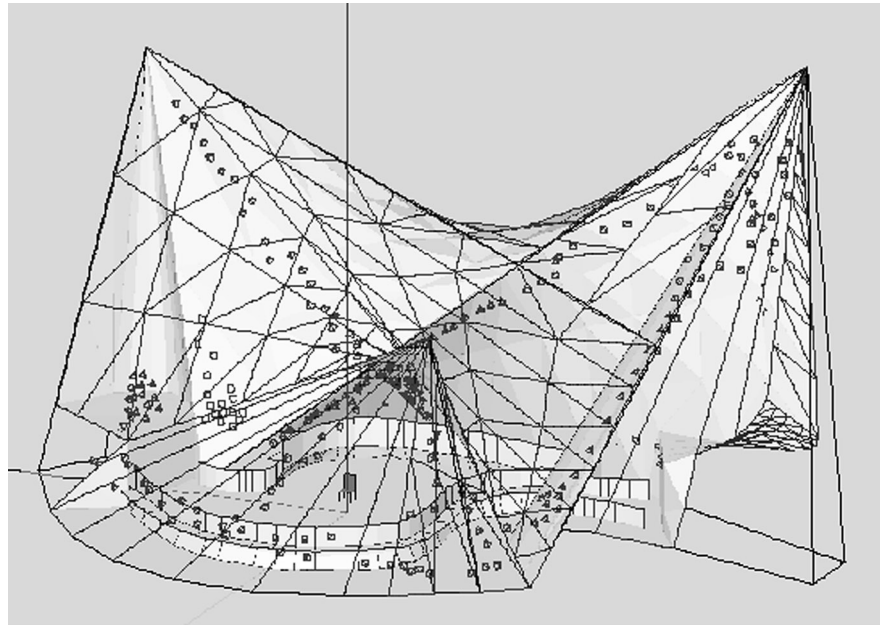

(a)

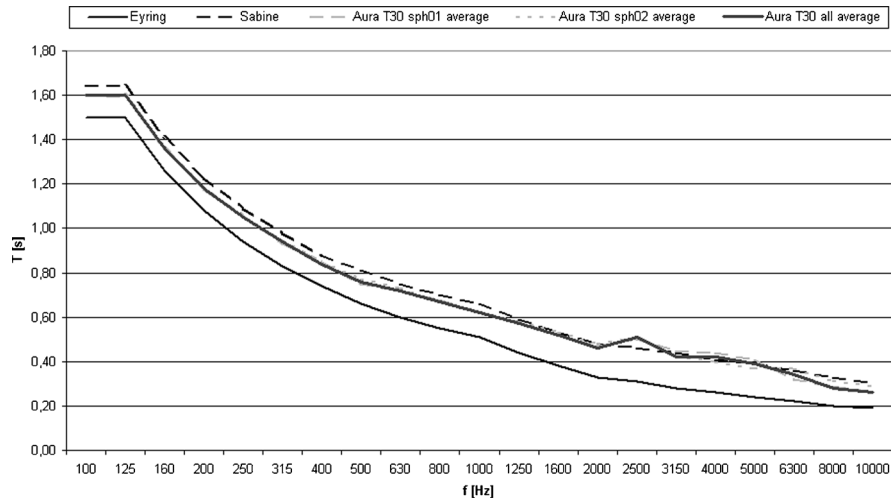

(b)

Integration of the Content Elements in a Software Environment and Virtual-Reality Installation

Figure 15 illustrates our VR environment that integrates all the contributions described in the previous sections. The visual elements (i.e., the CG

model of the pavilion and the visual components of *Poème Électronique*) are rendered through a custom application, developed in C++, that uses the 3D-graphics libraries of the open-source Object-Oriented Graphics Rendering Engine (OGRE, available online at www.ogre3d.org) under Linux or Windows. It

Figure 14. Continued.

Figure 15. The architecture of the virtual reality environment.

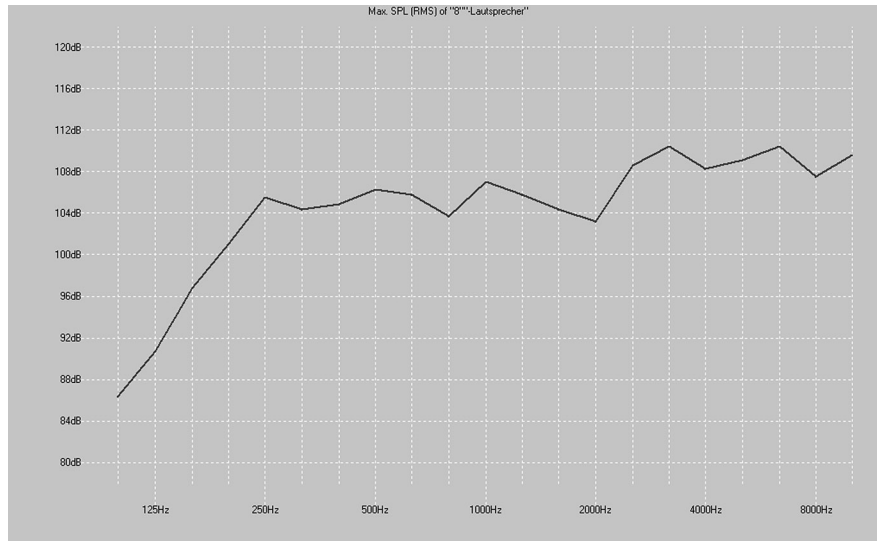

(c)

Figure 14

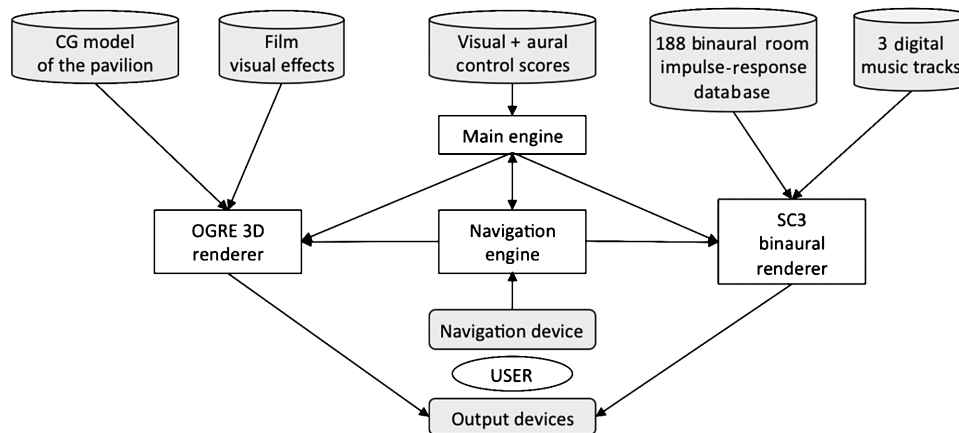

Figure 15

combines the base material of the walls with the basic light effects; then, on this layer, it adds the film projection and the other visual effects.

The real-time binaural rendering of the music combined with the spatial effects is realized through a custom application (Kersten et al. in press) written in SuperCollider (supercollider.sourceforge.net) under Linux. The application plays the three-track audio processed with the binaural impulse responses

loaded from disk according to the listener's orientation in the virtual space. A predictive algorithm asynchronously caches impulse responses in the proximity of the current head orientation.

Events are scheduled by the main engine (written in Java), which reads the visual and aural control scores; user orientation is tracked through the input devices and handled by the navigation engine, which communicates such data to the aural and

Figure 16. The individual setup: (a) schema; (b) photo.

visual renderers. The aural rendering output is sent to headphones, and the visual rendering output depends on the installation.

Currently, there are three available settings for experiencing the reconstructed *Poème Électronique*. The most immersive setting is a single-user setup in immersive virtual reality, with a stereoscopic head-mounted display (HMD) and headphones that simulate visual depth and sound directionality, respectively (see Figure 16). The spectator can explore the pavilion space interactively during the show sitting on a revolving chair; orientation data relative to the observer are tracked and used to process audio and video elements in real time (Lombardo et al. 2005). The second setting is a multiple-user setup that uses a widescreen display and, again, binaural audio over the spectators' headphones, with the audience orienting sight through a joystick (see Figure 17). This setting can accommodate many persons at the same time, so the experience can be shared, though immersivity is limited to a certain extent. The third setting is a non-interactive widescreen version with six-channel audio on a DVD-video that includes a recorded sequence of head movements inside the pavilion that catches most of the visual material—colors, visual effects, video projections—displayed in the pavilion.

A virtual-reality presentation is also available on the Internet, though with reduced capabilities for sound delivery and definition of the visual part. The Web application presents the virtual-reality reconstruction of *Poème Électronique* through interactive computer graphics that use relatively popular and accessible technology (Macromedia Director with Shockwave with a user interface in Flash). In the Web version, the user can move freely during the show, with control on the camera field of vision for zooming into details (see Figure 18). It serves as promotion for the on-site installation and provides a good approximation of the real show with acceptable performance even on low-end home computers.

Conclusions and Future Work

This article has presented a virtual-reality reconstruction of *Poème Électronique* through a

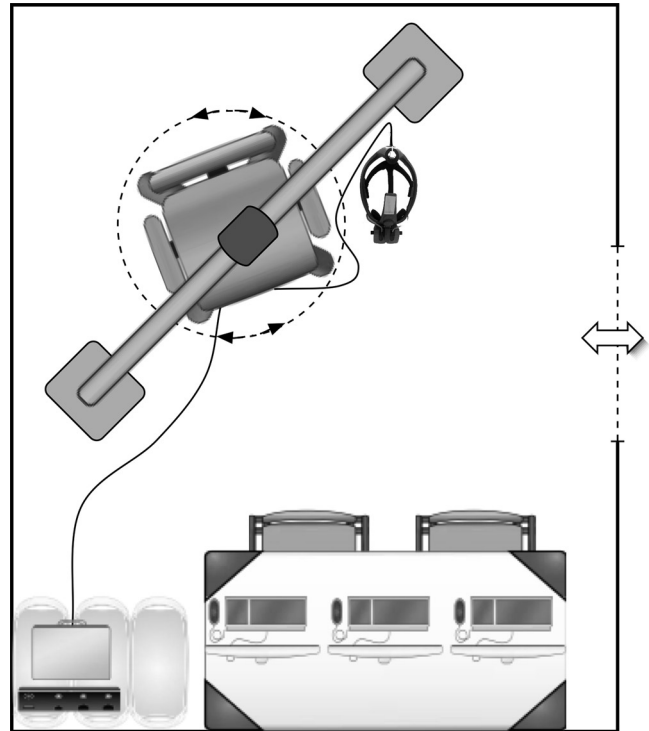

(a)

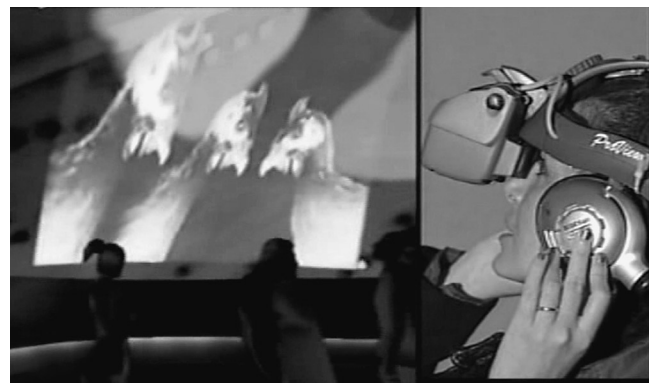

(b)

simulative methodology. The immersive audiovisual environment that we developed allows sensory access to this milestone of media art 50 years after its demolition. The project has relied upon sophisticated philological research to provide coherent delivery as required by the simulative methodology. An important lesson we can learn from this recovery is that documentation produced for a complex

Figure 17. Multiple-user setup: (a) schema; (b) photo.

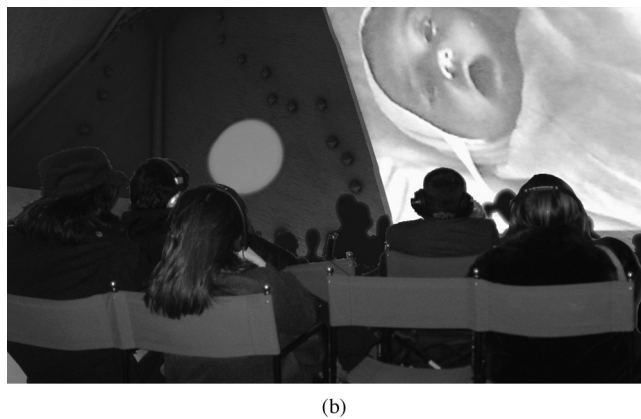
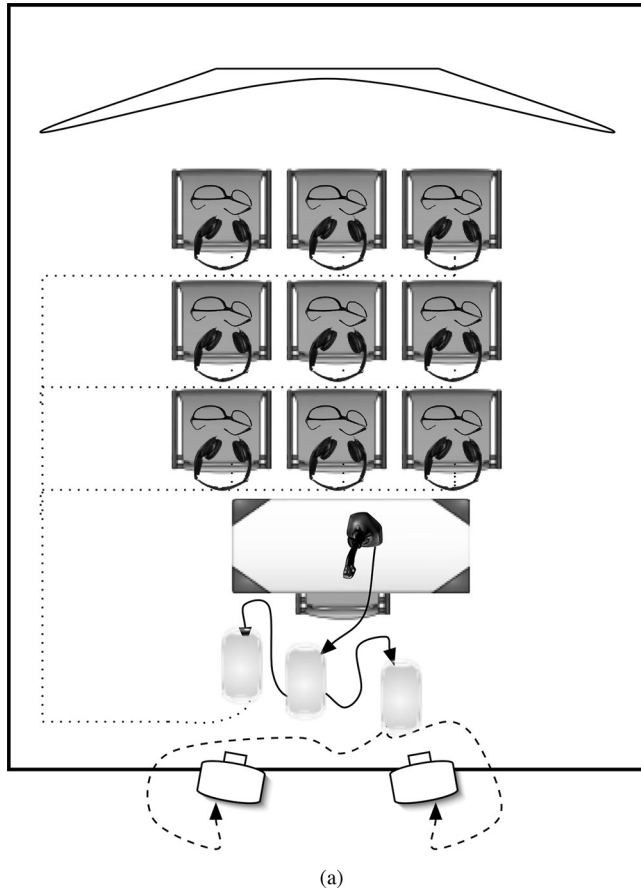

multimedia installation is, in practice, never enough for the purposes of maintenance and restoration.

The simulative methodology has involved the development of a framework capable of integrating

Figure 18. Two screenshots of the virtual Poème on the Internet: (a) the bull; (b) the four sages.



(a)



(b)

the recovery process of the media materials, the language for expressing the controls of the audiovisual contents, and the hardware/software architecture for experiencing the renovated installation.

Although the responses provided by participants were positive (including those of eye-and-ear witnesses of the original *Poème*), we are aware that a number of aspects could only be reconstructed with plausible guesses. This underlines the importance of philological as well as artistic competence within what seems, at first sight, a primarily technological task, while the modular architecture developed

in the project leaves the option of replacing such interventions as soon as new sources or new conclusions are available.

Acknowledgments

We thank Doug Keislar for his guidance in improving the article. We also thank two anonymous reviewers for their comments. We thank Andrea Arghinenti, Sebastian Benser, Richard Dobson, Francesco Giordana, Stefan Kersten, Sławomir Niedbała, Fabrizio Nunnari, Julian Padget, Wojciech Pytlik, Roman Starosolski, and Heinrich H. Vogel for their collaboration on the Virtual Electronic Poem (VEP) project. We thank all the participants to the VEP installations for their invaluable feedbacks on the installation. We also thank the EU Commission/Culture 2000 program for their funding of the VEP project. We thank the Philips Company Archives, the Getty Center Archives, Fondation Le Corbusier, the Institute of Sonology of the Royal Conservatory in The Hague, Centro Ricerche Musicali, and Valerio Casali for available material on *Poème Électronique*. The Web site of the project is www.edu.vrmmp.it/vep.

References

- Bayle, F. 1993. *Musique Acousmatique, Propositions ... Positions*. Paris: INA-Buchet/Chastel.
- Bernard, J. 1987. *The Music of Edgard Varèse*. New Haven, Connecticut: Yale University Press.
- Blessner, B., and L.-R. Salter. 2007. *Spaces Speak, Are You Listening?: Experiencing Aural Architecture*. Cambridge, Massachusetts: MIT Press.
- Bredel, M. 1984. *Edgard Varèse*. Paris: Mazarine.
- Cabrera, D. 1994. "Sound Space and Edgard Varèse's *Poème Électronique*." MA Thesis, Sydney University of Technology.
- Cascone, K. 2000. "The Aesthetics of Failure: 'Post-Digital' Tendencies in Contemporary Computer Music." *Computer Music Journal* 24(4):12–18.
- Chadabe, J. 1997. *Electric Sound: The Past and Promise of Electronic Music*. Upper Saddle River, New Jersey: Prentice Hall.
- Charbonnier, G. 1970. *Entretiens avec Edgard Varèse*. Paris: Belfond.
- Cogan, R. 1984. *New Images of Musical Sound*. Cambridge, Massachusetts: Harvard University Press.
- Cogan, R. 1991. "Varèse: An Oppositional Sonic Poetics." *Sonus* 11(2):26–35.
- Deleuze, G., and F. Guattari. 1980. *Mille Plateaux: Capitalisme et Schizophrénie*. Paris: Minuit.
- Di Scipio, A. 2002. "System of Embers, Dust, Clouds: Observations after Xenakis and Brün." *Computer Music Journal* 26(1):22–32.
- Dobson, R., et al. 2005. "Varèse's *Poème Électronique* Regained: Evidence from the VEP Project." *Proceedings of the 2005 International Computer Music Conference*. San Francisco, California: International Computer Music Association, pp. 29–35.
- Felciano, R. 1996. "An Analysis of the *Poème Électronique*." In M. Treib, ed. *Space Calculated in Seconds: The Philips Pavilion, Le Corbusier, Edgard Varèse*. Princeton, New Jersey: Princeton University Press, pp. 212–213.
- Griffiths, P. 1995. *Modern Music and After*. Oxford: Oxford University Press.
- Harley, J. 2002. "The Electro-Acoustic Music of Iannis Xenakis." *Computer Music Journal* 26(1):33–57.
- Kalf, L.C., W. Tak, and S. L. de Bruin. 1958. "The 'Electronic Poem' Performed in the Philips Pavilion at the 1958 Brussels World Fair." *Philips Technical Review* 20:2–3.
- Kendall, G. S. 2006. "Juxtaposition and Non-Motion: Varèse Bridges Early Modernism to Electroacoustic Music." *Organised Sound* 11(2):159–171.
- Kersten, S., et al. In press. "A Binaural Simulation of Varèse's *Poème Électronique*." In S. Wilson, D. Cottle, and N. Collins, eds. *The SuperCollider Book*. Cambridge, Massachusetts: MIT Press.
- Lombardo, V., et al. 2005. "The Virtual Electronic Poem (VEP) Project." *Proceedings of the 2005 International Computer Music Conference*. San Francisco, California: International Computer Music Association, pp. 451–454.
- Lombardo, V., et al. 2006. "Archeology of Multimedia." *Proceedings of the 2006 ACM Multimedia Conference*. New York: Association for Computing Machinery, pp. 269–278.
- Manning, P. 2004. *Electronic and Computer Music*. Oxford: Oxford University Press.
- Matossian, N. 1981. *Iannis Xenakis*. Paris: Fayard/Sacem.
- Mattis, O. 1992. "Varèse's Multimedia Conception of *Déserts*." *The Musical Quarterly* 76(4):557–583.
- McLuhan, M. 1964. *Understanding Media: The Extensions of Man*. Berkeley, California: University of California Press.

- Meyrowitz, J. 1986. *No Sense of Place: The Impact of Electronic Media on Social Behavior*. Oxford: Oxford University Press.
- Moldrzyk, C., et al. 2004. "Head-Tracked Auralization of Acoustical Simulation." *Proceedings of the 117th AES Convention*. New York: Audio Engineering Society, preprint 6275.
- Moldrzyk, C., et al. 2005. "Perzeptive Evaluation binauraler Auralisationen." *Fortschritte der Akustik*. München: DAGA, pp. 545–546.
- Ouelette, F. 1966. *Edgard Varèse*. Paris: Seghers.
- Ouzounian, G. 2007. "Visualizing Acoustic Space." *Circuit, Musiques Contemporaines* 17(3):45–56.
- Petit, J. 1958. *Le Corbusier: Le Poème Electronique*. Paris: Edition Le Minuit.
- Schuller, G. 1971. "Conversation with Varèse." In B. Boretz and E. T. Cone, eds. *Perspectives on American Composers*. New York: Norton, pp. 35–39.
- Schwartz, E., and B. Childs, eds. 1967. *Contemporary Composers on Contemporary Music*. Ann Arbor: University of Michigan Press.
- Sterken, S. 2001. "Towards a Space-Time Art: Iannis Xenakis's Polytopes." *Perspectives of New Music* 39(2):262–273.
- Treib, M. 1996. *Space Calculated in Seconds: The Philips Pavilion, Le Corbusier, Edgard Varèse*. Princeton, New Jersey: Princeton University Press.
- Varèse, E. 1971. "The Liberation of Sound." In B. Boretz and E. T. Cone, eds. *Perspectives on American Composers*. New York: Norton, pp. 25–33.
- Varèse, E., and L. Hirbour. 1983. *Écrits*. Paris: Christian Bourgois.
- Vidolin, A., M. Leman, and S. Canazza, eds. 2001. *Journal of New Music Research* 30:4, Special Issue on Preserving Electroacoustic Music.
- Viola, B. 1994. *Déserts*. Video. New York: Electronic Arts Intermix.
- Weinzierl, S., and K. Tazelaar. 2006. "Raumsimulation und Klangkunst." In H. de la Motte-Haber, M. Osterwolth, and G. Weckwerth, eds. *Sonambiente Berlin 2006 Klang Kunst Sound Art*. Heidelberg: Kehrer, pp. 350–365.
- Wen-Chung, C. 1971. "Open Rather than Bounded." In B. Boretz and E. T. Cone, eds. *Perspectives on American Composers*. New York: Norton, pp. 49–54.
- Wharton, G. 2005. "The Challenges of Conserving Contemporary Art." In B. Altshuler, ed. *Collecting the New*. Princeton, New Jersey: Princeton University Press, pp. 163–178.
- Wishart, T. 1986. "Sound Symbols and Landscapes." In S. Emmerson, ed. *The Language of Electroacoustic Music*. London: MacMillan, pp. 41–60.
- Xenakis, I. 1958. "Genèse de l'Architecture du Pavillon: Le Pavillon Philips à l'Exposition Universelle de Bruxelles 1958." *Philips Technical Review* 20(1):2–11.
- Xenakis, I., C.G.J. Vreedenburgh, A. L. Bouma, F.K. Ligtenberg, and H.C. Duyster. 1958. "The Philips Pavilion at the 1958 Brussels World Fair," *Philips Technical Review* 20(1).
- Xenakis, I. 1979. *Arts-sciences alliages*. Tournai: Casterman.
- Zattra, L. 2007. "The Assembling of Stria by John Chowning: A Philological Investigation." *Computer Music Journal* 31(3):38–64.