

Mitigating the effects of rain-induced fading in satellite communications systems using time diversity in concert with maximal ratio combining

Leshan Uggalla¹, Jon Eastment², Ifiok Otung¹

¹Faculty of Computing, Engineering and Science, Mobile and Satellite Communications Research Group, University of South Wales, Pontypridd, CF37 1DL, UK

²Rutherford Appleton Laboratory, Science and Technology Facilities Council, Chilton, Didcot, Oxfordshire, OX11 0QX, UK
E-mail: leshan.uggalla@southwales.ac.uk

Published in *The Journal of Engineering*; Received on 9th November 2015; Accepted on 15th February 2016

Abstract: This paper reports on a preliminary study using Eutelsat Hotbird 13A beacon data at 19.7 GHz and 29.5 GHz (scaled data) to evaluate the benefit of using Time Diversity (TD) and Maximal Ratio Combining (MRC) on an experimental next generation Ka-band (26.5–40 GHz) satellite link in the UK. The authors have used the 2nd generation of video broadcasting via satellite (DVB-S2) as the broadcasting standard to investigate the novel integration of TD and MRC. The benefit of the TD and MRC scheme was quantified in terms of percentage enhancement of the link availability. Long-term statistics of rain and atmospheric attenuation were derived from a period of three year's measurements made in Pontypridd, South Wales and in Chilbolton, England, at 19.7 GHz. A hypothetical Ka-band satellite broadcast link between Pontypridd and Chilbolton has been designed to use 29.5 GHz as the uplink frequency while 19.7 GHz is used as the downlink frequency. The paper discusses the performance enhancement provided by TD and MRC during different types of fading events. The integration of TD and MRC into the DVB-S2 standard provides the capability to continue delivering services at lower carrier-to-noise (C/N) levels by lowering the bit error rate (BER).

Introduction

Steadily increasing user-demand for higher capacity satellite links has driven satellite operators to move into the higher frequency bands, such as Ka-band and above, in order to accommodate the necessary data rates. However, a major issue at these frequencies is the effect of severe rain-induced fading on link reliability, which requires that the system must be designed to implement mitigation techniques in order to achieve an acceptable quality of service. These techniques generally involve sophisticated error correction coding methods, adaptive modulation and coding rates, together with various forms of diversity, switching or combining. There are numerous research groups working to find solutions which increase the link availability of satellite communication systems at higher frequencies. So as to avoid the limitations that arise from these serious propagation impairments, a class of techniques have been introduced which are able to improve system availability and throughput.

Collectively, these measures are called Fade Mitigation Techniques. By using advanced coding, error-correction and modulation techniques, the broadcasting protocol named '2nd generation of digital video broadcasting via satellite' (DVB-S2) has been developed and standardised as an evolution of the earlier digital video broadcast via satellite (DVB-S) waveform for European satellite broadcasting by the European Telecommunications Standards Institute (ETSI), so as to enhance the capabilities of video broadcasting services via satellite [1].

In this work, we analyse and quantify the benefits of adding time diversity (TD) and maximal ratio combining (MRC) [2] to a high-fidelity computer simulation of a satellite link which uses DVB-S2 as the broadcasting protocol. The computer simulation uses MATLAB as the software platform. The entire DVB-S2 system architecture has been fully implemented as a combination of individual functional blocks according to the DVB-S2 protocol standard. The simulator is conditioned using both measured and frequency-extrapolated attenuation data. The results indicate that a substantial reduction in bit error rate (BER) and significant reductions in outage duration are readily achievable. In order to

investigate various possible fading scenarios, a set of representative attenuation events was selected which included different types of fading, such as short, -deep fade, long, -medium fade etc. These attenuation events, which included different attenuation values and durations, were extracted from a 3-year database of satellite beacon propagation measurements made at two UK sites.

Since July 2010, the University of South Wales and the Science and Technology Facilities Council have undertaken a programme of simultaneous satellite beacon measurements at their sites at the University campus in Pontypridd, Wales, and at the STFC Chilbolton Observatory [3], near Andover in Southern England, respectively. Transmissions from the Eutelsat Hotbird 13A (previously Hotbird 6) satellite [4] at 19.7 GHz were recorded, together with meteorological measurements, at both sites. These data enabled reliable estimation of the instantaneous propagation conditions and carrier-to-noise ratio (C/N) on the Ka-band beacon downlinks. Using standard ITU-R recommendations [5], the resulting data-set of measured 19.7 GHz attenuations was also frequency-scaled to yield a predicted data-set of 29.5 GHz attenuations.

Input to the system simulator comprised a random test data stream, together with the link attenuation time-series data for the fading event being studied. Simulations were performed for the existing DVB-S2 system without TD + MRC and for the proposed DVB-S2 system with TD + MRC, which we have named as DVB-S2TD. The simulation's output consists of the BER statistics as a function of time. During the selected fading events, when the signal-to-noise (SNR) falls below the lowest acceptable ratio (~ -2 dB in DVB-S2 [6]), TD is enabled such that the transmitted data is duplicated into parallel streams with a selectable time offset between them. The variation in system BER performance due to selecting different time offsets for the same fading event provides useful data from which to determine future time offset choice. In the receiver, MRC is employed in order to obtain an SNR improvement leading to a lower BER. Our results show that the performance of the proposed DVB-S2TD is superior to that of the existing DVB-S2 standard. Thus, TD + MRC provides the potential to continue delivering services at SNRs significantly below the currently acceptable threshold defined for various applications, such as

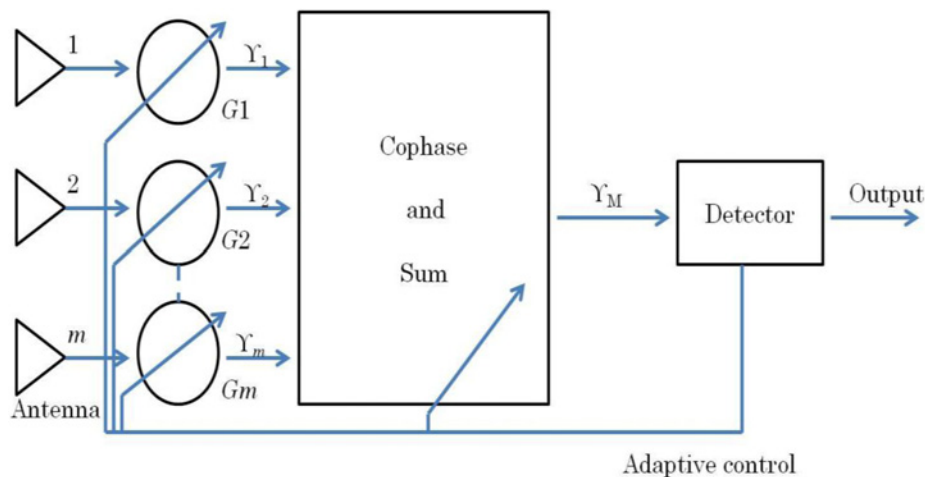

Fig. 1 Original MRC concept based on multi-antenna signal combining

would be experienced under the propagation impairments associated with severe weather conditions.

In this paper, we describe the experimental systems used to collect the satellite beacon data and meteorological measurements. We briefly outline the key features of the DVB-S2 standards. The implementation of the DVB-S2 architecture on the MATLAB simulator, together with the necessary extensions to accommodate TD and MRC, is detailed. Finally, we compare the performance of the baseline DVB-S2 system with that of the proposed new DVB-S2TD system employing TD and MRC. We quantify the improvement in link availability as a percentage.

Diversity techniques

The increased level of rain attenuation experienced at high frequencies makes satellite communication system design more complicated and demanding than that required at lower frequencies. As frequency increases, the impact of atmospheric effects (rain, cloud and other attenuations) on radio-wave propagation becomes severe, leading to signal degradations. Consequently, satellite operators at Ka-band and above are particularly interested in

effective counter measures to mitigate signal losses, and, thus, to improve reception quality.

Diversity is a powerful communication receiver technique which can provide link improvement at relatively low cost. There are a wide range of diversity techniques, many of which are very practical and provide significant link reliability improvement at modest added cost. The diversity concept can be explained simply. If one radio path undergoes a deep fade, another independent path may have a strong signal containing the same information. By having more than one path to select from, both instantaneous and average SNRs at the receiver may be improved. The repeated signal, or the duplicated signal, can be a separate signal which is transmitted from a separate antenna or a time-shifted signal from the same transmitter.

Time diversity and maximal ratio combining

TD has recently been proposed as an affordable fade mitigation strategy against rain attenuation impairment on extremely high frequency satellite links [7]. TD involves repeated transmission of the same information over the same channel at different times in order



Fig. 2 Facilities available at both sites

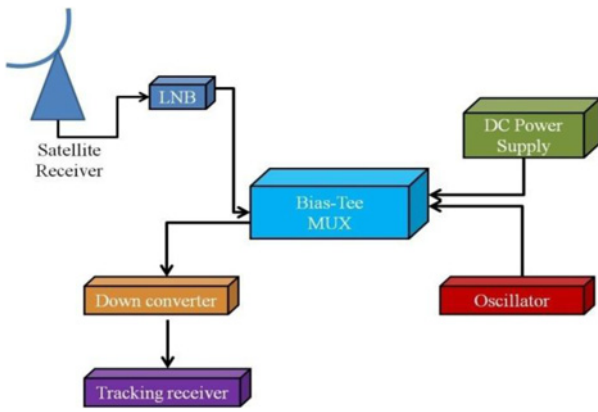

Fig. 3 Beacon receiver setup

to reduce signal impairments. TD performance within a fading event depends on a number of factors, including event duration, event depth (which is the maximum attenuation level within the event), retransmission delay (which must be limited to values acceptable to the type of communication service), the variability of the attenuation time series within the event's duration (which is referred to as event dynamics), and the threshold C/N ratio at the demodulator input, which determines how often TD is activated on the link.

The MRC method was first proposed by Khan in the context of combining signals from multiple antennas. As illustrated in Fig. 1, in MRC, the signals from all M branches are weighted according to their individual SNR and then summed. In MRC, the signal voltage r_i from each of the M diversity branches are co-phased to provide coherent voltage addition and are individually weighted to provide optimal output SNR. If each branch has a gain G_i , then the resulting signal envelope applied to the detector is [2]

$$r_M = \sum_{i=1}^M G_i r_i \quad (1)$$



Fig. 4 Physical connectivity of complete satellite

Assuming that each branch has the same average noise power N , the total noise power is given by

$$N_T = N \sum_{i=1}^M G_i^2 \quad (2)$$

which results in an SNR applied to the detector, γ_M , given by

$$\gamma_M = \frac{r_M^2}{2N_T} \quad (3)$$

In our specific scenario, complex samples of the receiver's intermediate frequency signal corresponding to individual data frames are combined, rather than multiple antenna inputs. The signals from both individual frame must be co-phased before being summed. MRC then produces an output frame which has an enhanced C/N as a result of a weighted summation of each frame's individual C/N. This enhanced output C/N leads to a lower system BER.

Satellite beacon monitoring stations

The Mobile and Satellite Communications Research Group at the University of South Wales has been operating two receiving earth stations, one at the University of South Wales, Pontypridd (Latitude: 51.59°N, Longitude: 3.33°W), and the other at Chilbolton Observatory in Hampshire, England (Latitude: 51.14°N, Longitude: 1.44°W), measuring the signals from the beacon carried on Eutelsat Hotbird 13 A, since July 2010. Eutelsat Hotbird 13 A was in geostationary orbit at 13° East and could be seen at elevations of 29.30° and 29.91° from the receiving stations in Pontypridd [8] and Chilbolton, respectively. The received 19.7 GHz beacon signal is sampled at 5 Hz in Pontypridd, and at 1 Hz in Chilbolton. Eutelsat Hotbird 13A stopped its transmission on 3rd July 2013 at 9.00 am, where upon 3 years of dual-site beacon measurements had been successfully collected.

Alongside the beacon receivers, a variety of meteorological instruments are operating at both earth stations in order to measure temperature, humidity, pressure and rainfall. The meteorological data is sampled at 1 Hz. Some of the facilities available at

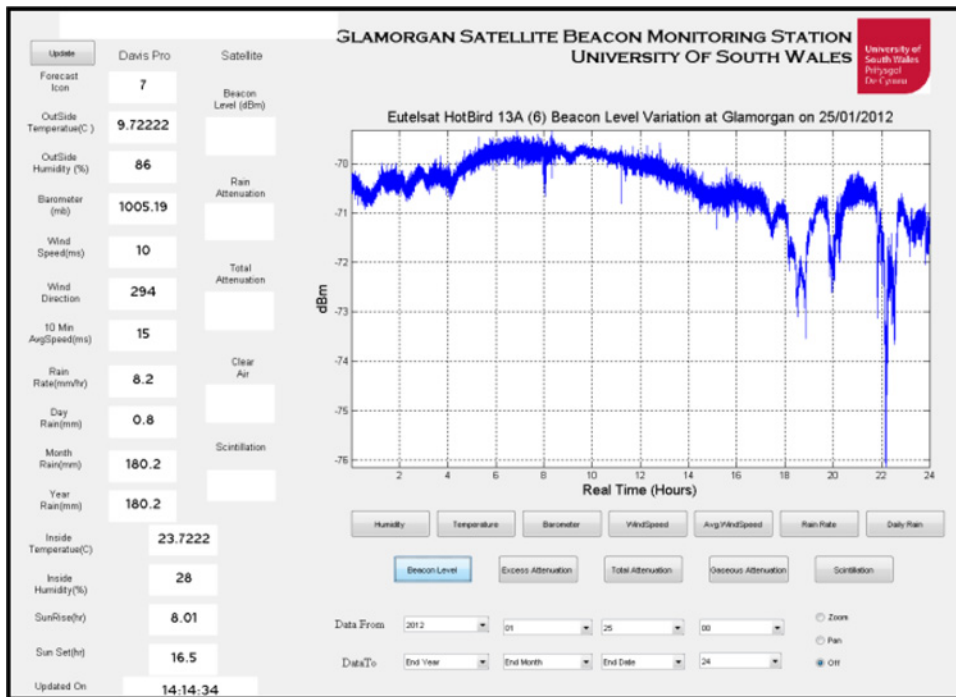

Fig. 5 GUI beacon monitoring station

both sites are shown in Fig. 2. Data recording is a fully-automated process which runs continuously.

A block diagram of the beacon receiver design is given in Fig. 3, while the complete system configuration of the receiving earth stations is illustrated in Fig. 4. The data received from both ground stations are saved in a central data logging server. A graphical user interface (GUI), which is pictured in Fig. 5, has been designed to allow users to query data from the central data logging server from anywhere within the university campus network. The entire data logging process and the data access and presentation GUI were developed as in-house projects.

2nd generation of digital video broadcasting via satellite

Here, we briefly described the background to, and the key features of, the DVB-S2 standard.

DVB-S2 (EN 302 307) is a digital satellite transmission system developed by the DVB Project. It makes use of the latest modulation and coding techniques to deliver performance that approaches the theoretical limit for such systems. Satellite transmission was the first area addressed by the DVB Project in 1993 and DVB standards form the basis of most satellite DTV services around the world today, and, therefore, of most digital TV in general. DVB-S2 will gradually replace DVB-S as new HD/Ultra HDTV services entice users to upgrade their receivers to more efficient DVB-S2 models.

DVB-S2 is a single, very flexible standard, covering a variety of applications delivered by satellite. It is characterised by:

- (i) A flexible input stream adapter, suitable for operation with single and multiple input streams of various formats (packaged or continuous).

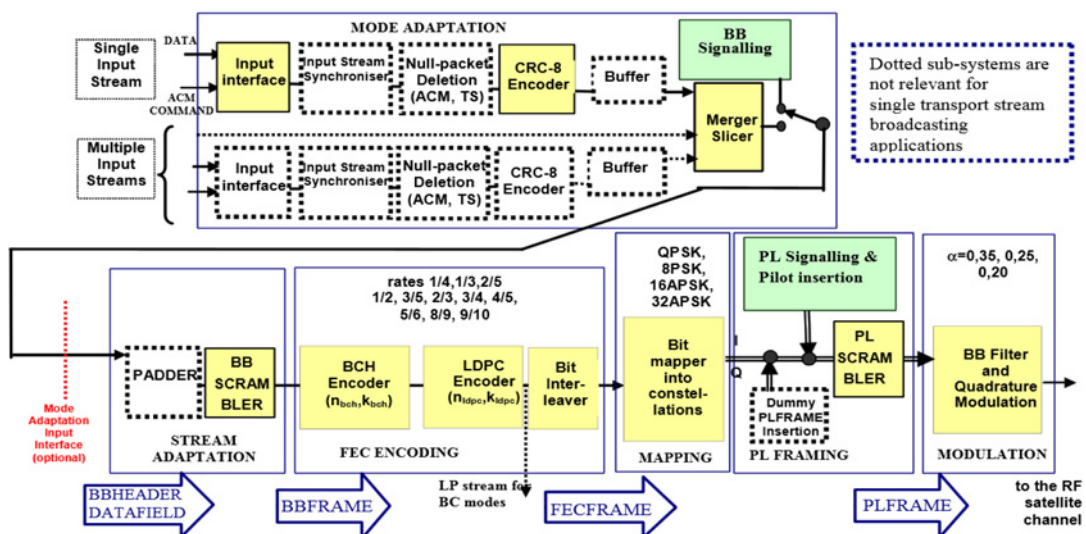

Fig. 6 Functional Block Diagram of the DVB-S2 System

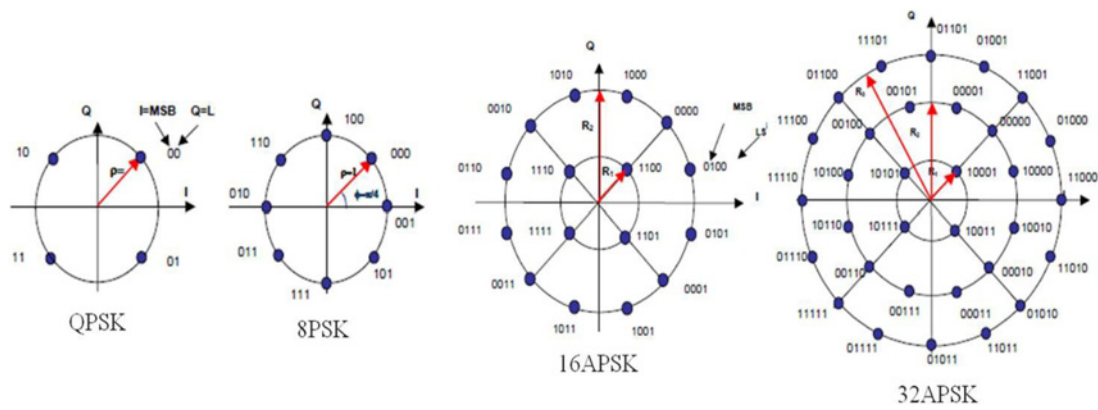

Fig. 7 Constellation diagrams for the various DVB-S2 modulation schemes

- (ii) A powerful forward error-correction system, based on low-density parity check codes concatenated with Bose–Chaudhuri–Hocquenghem codes, allowing quasi-error-free operation at about 0.7 to 1 dB from the Shannon limit for an additive white Gaussian noise channel, depending on the transmission mode.
- (iii) A wide range of code rates (from 1/4 up to 9/10) with four constellations, ranging in spectral efficiency from 2 to 5 bit/s/Hz, optimised for operation over non-linear transponders.
- (iv) A set of three spectrum shapes, with roll-off factors of 0.35, 0.25 and 0.20.
- (v) Adaptive coding and modulation functionality, optimising channel coding and modulation on a frame-by-frame basis.

The DVB-S2 system comprises several functional blocks of equipment. These functional blocks perform the adaptation of the baseband digital signals, from the output of a single (or multiple) MPEG transport stream multiplexer(s), or from the output of a single (or multiple) generic data source(s), to the satellite channel characteristics. The functional block diagram of the DVB-S2 system is shown in Fig. 6. In our system simulator, all these

functional blocks were individually implemented using MATLAB and independently verified before connecting them together in order to build the entire DVB-S2 system architecture. Fig. 7 shows the different constellations for the modulation schemes used in DVB-S2. The switching threshold between the various modulation schemes and the lowest cutoff margin for the various services is defined for DVB-S2 in the ETSI standard documentation. This states that, for frame size of 64 800 bits, the relevant cutoff margin for DVB-S2 is $C/N = -2.35$ dB. The authors have used 64 800 bit frame size throughout their simulations, as on to comply with the protocol's standard for live broadcasting. The DVB project recently released an updated standard of DVB-S2, named DVB-S2X. However, even with the latest standard, the lowest possible C/N threshold for live broadcasting using normal frames (64 800 bits) is -2.45 dB [9].

Data processing and frequency scaling

Pre-processing is necessary in order to convert the recorded raw beacon receiver output (DC levels) and the meteorological

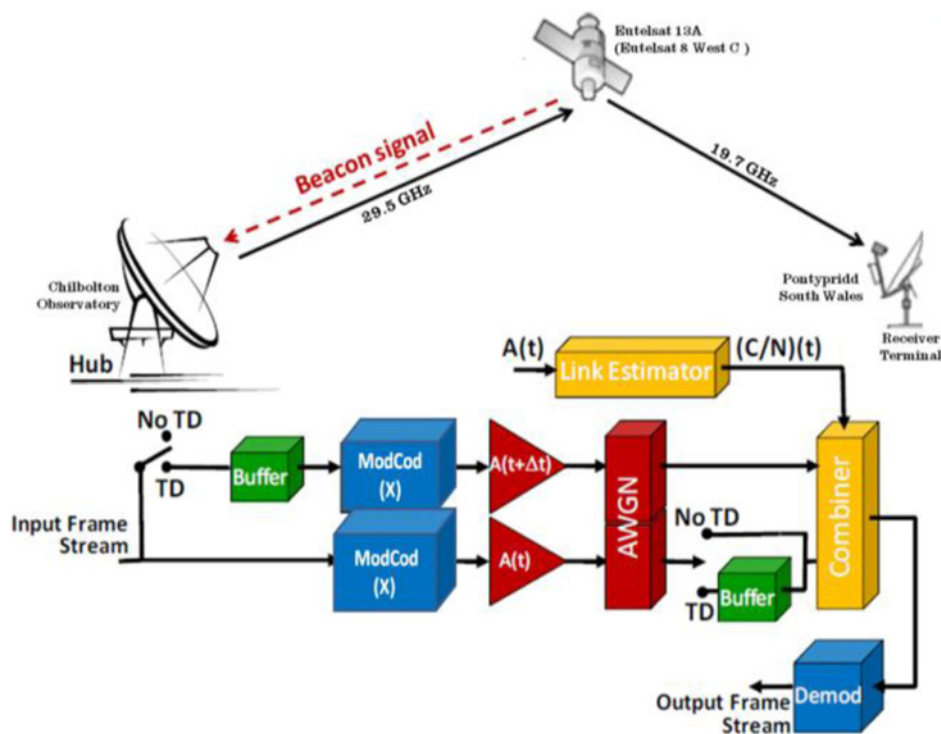

Fig. 8 Experimental satellite communication

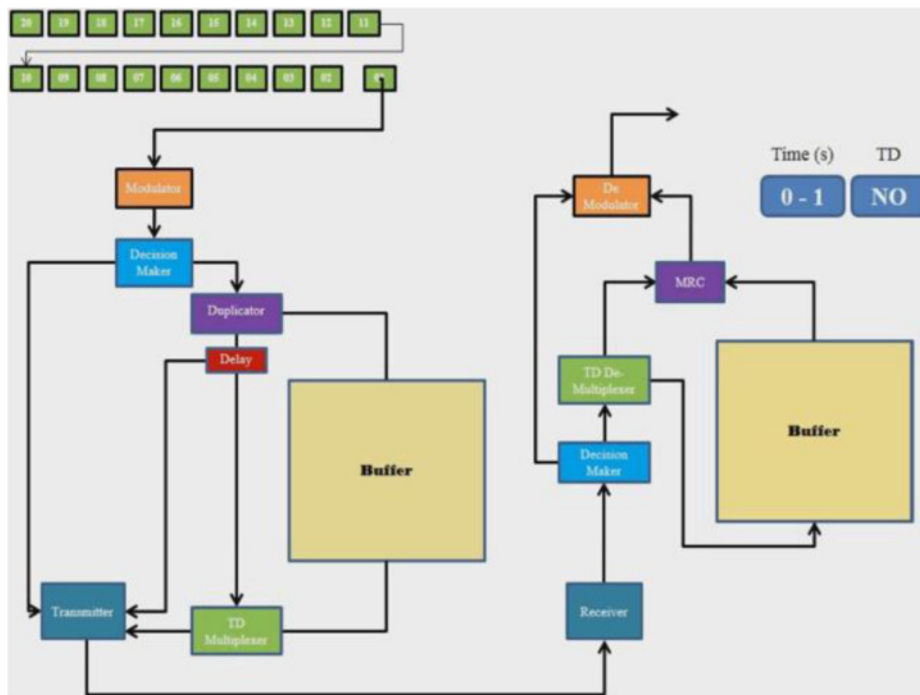

Fig. 9 Simulation system setup for DVB-S2TD system incorporating TD and MRC

sensor data (DC levels) into standard units (dB, °C, mm/h etc.) and then to calculate the necessary atmospheric attenuation components (gaseous, scintillation, excess and total). Changes in the received beacon signal level can be caused by atmospheric effects, diurnal variations due to satellite movements in geostationary orbit, thermal shifts and power fluctuations. In order to remove the diurnal attenuation variation from the recorded beacon data, a reference level known as the ‘Zero dB Reference’, has been defined [10]. By using the zero dB reference level, total attenuation has been extracted, which contains scintillation, gaseous, cloud, rain and other atmospheric attenuation components [11].

The resulting total attenuation time-series (expressed in dB) is processed to exclude scintillations by passing the data through a pass filter [12]. The gaseous attenuation components is extracted at the link frequencies of interest (19.7 and 29.5 GHz) using the established ITU-R computation method for gaseous attenuation [13]. The temperature and humidity data, recorded at 1 Hz rate during the experimental period, are used as input parameters in the computation to yields a gaseous attenuation time-series containing 86 400 samples per day.

Finally, rain attenuation is extracted from the smoothed total attenuation time-series by subtracting the gaseous attenuation time-series. The extracted rain attenuation at 19.7 GHz was then scaled

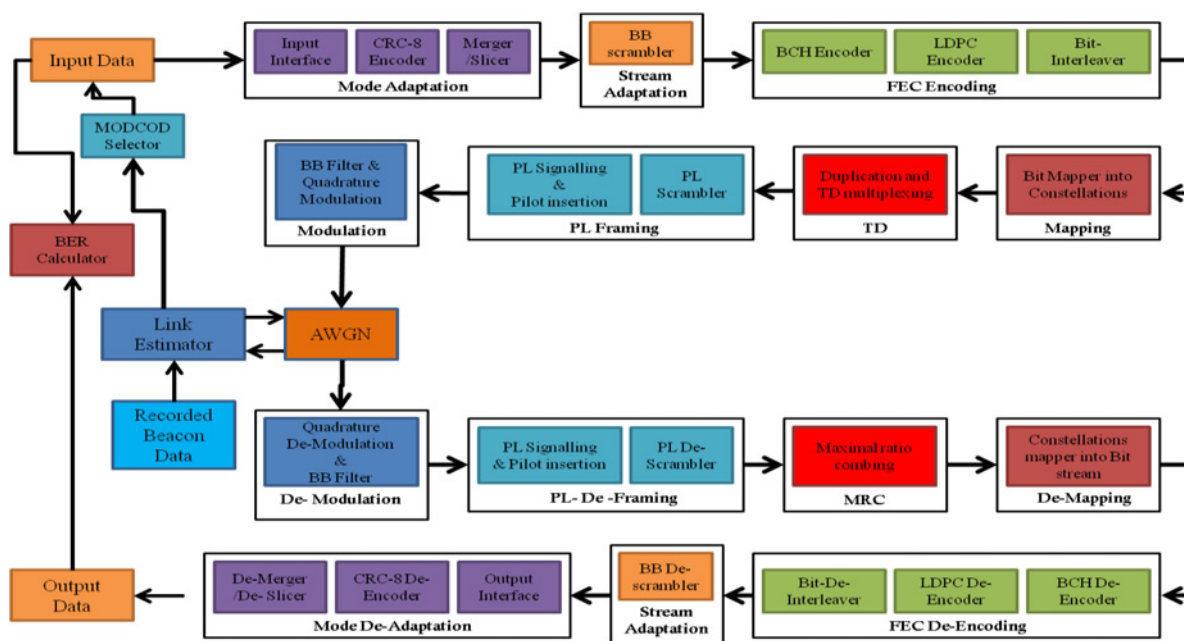

Fig. 10 Functional Block Diagram of the DVB-S2TD System, as simulated in MATLAB

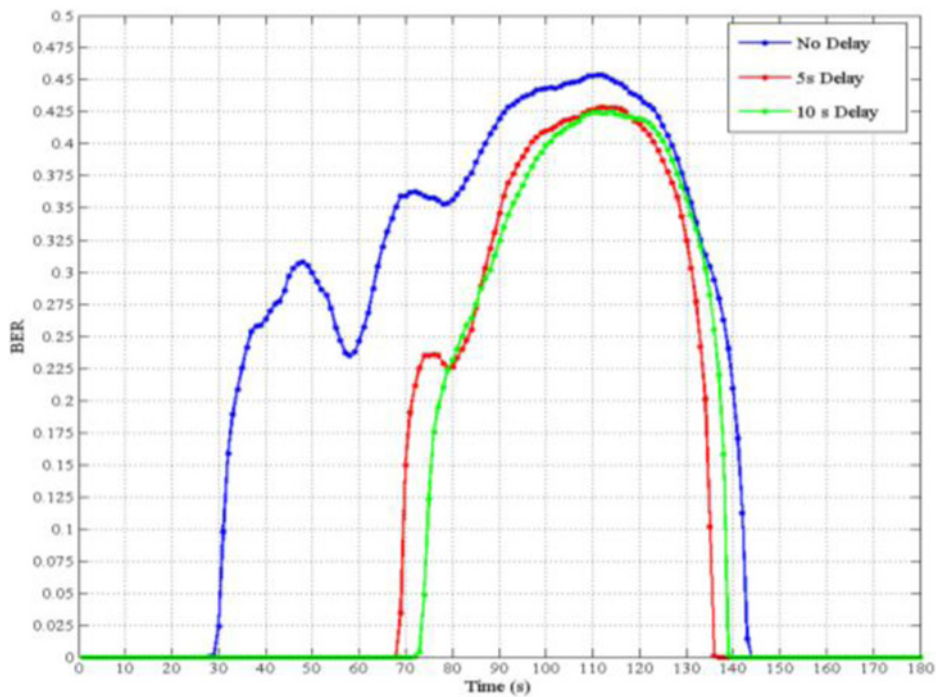

Fig. 11 BER for different time delays

to rain attenuation at 29.5 GHz by using the standard ITU-R frequency-scaling method P 618-10 [5]. This procedure produced a reliable estimate of the rain attenuation time-series on the uplink. The resulting attenuation data sets for both the uplink and downlink are used in the link budget calculations in order to estimate the received signal C/N. These link estimations, together with the specification of a cutoff C/N (the lowest acceptable operational signal level), were used as the trigger criterion to activate TD and MRC in the system simulator.

Computer simulation setup and procedure

As discussed above, TD is activated whenever the instantaneous link C/N falls below the lowest acceptable threshold, C/N_{th} of -2.35 dB. When TD is activated a single repeat of each frame of 64 800 bits occurs after a delay of $\Delta T = 5$ s. Experimentation has shown that increasing the fixed time delay ΔT employed between duplicated packets in TD+MRC yields only a marginal improvement in performance (i.e. a reduction in BER or in link outage), unless very high levels of ΔT , unsuitable for real time applications,

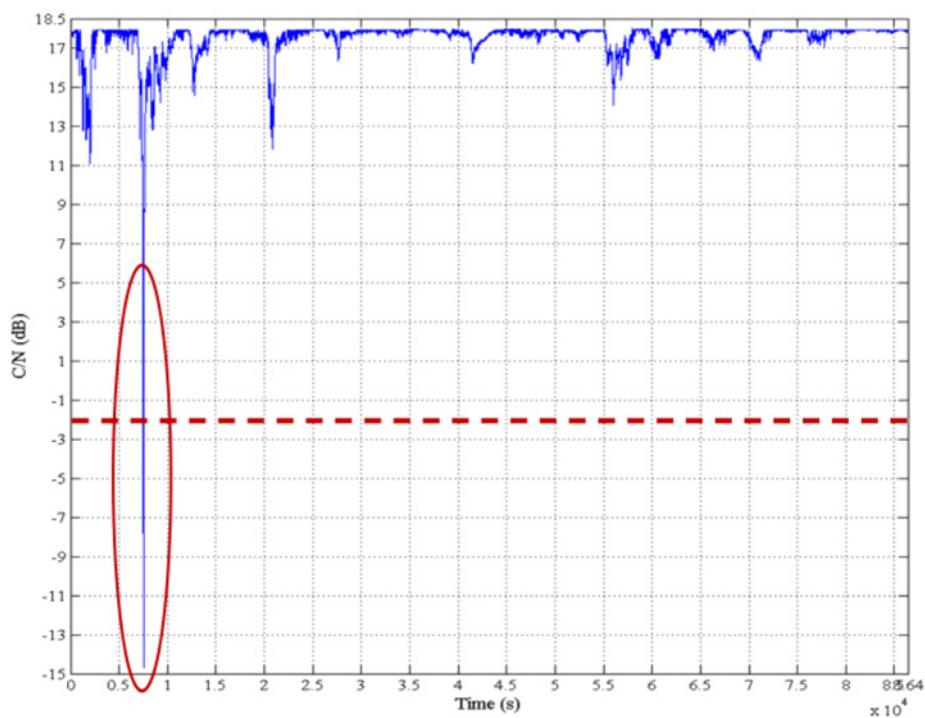

Fig. 12 The process of selecting fading events

Table 1 Comparison of DVB-S2 and DVB-S2TD system performances for six representative fading events

Event's date and time (GMT) HH:MM:SS	Event duration s	Outage duration, s		Reduction in outage, %
		No TD	TD + MRC	
2011-12-01 01:54:00–01:57:00	180	113	67	40.70
2012-04-12 13:30:30–13:42:09	700	260	0	100
2012-05-07 18:36:00–21:06:02	2874	2501	778	68.89
2011-10-05 18:40:00–19:05:00	1500	886	296	66.59
2011-08-06 22:35:00–23:00:00	1500	864	23	97.33
2012-05-01 03:11:20–03:23:00	700	498	158	68.27

are chosen. Buffers are employed at both the transmit hub and at the receiver terminal in order to synchronise corresponding frames in the combiner.

When C/N exceeds C/N_{th} , TD is not used and frames are transmitted once only without a repeat. Immediately following the activation of TD, at time t_o , the transmitter begins to buffer a copy of each frame that it sends and continues this buffering for the entire TD-active period, while the receiver simultaneously pauses received-frame processing. Then, ΔT seconds into the activation of TD, the transmitter begins to send frames taken alternately from its source input and from its FIFO buffer, while the receiver simultaneously begins to process a newly-received frame combined with a corresponding frame from its buffer received ΔT seconds earlier. This phase of the operation continues until TD is deactivated at time t_1 , whereupon the transmitter stops putting any

more frames into its buffer. Note, therefore, that data throughput is at half of the normal rate during the time interval from $t_o + \Delta T$ to $t_1 + \Delta T$ due to TD deployment which necessitates the transmission of buffered frames along with new ones. Outside this interval, both transmitter and receiver operate at full data rate, sending and receiving exclusively non-buffered frames.

The implementation of TD + MRC in a generalised satellite communication transmission scenario is shown in Fig. 8, while the simulator setup for evaluating the performance of the proposed DVB-S2TD system is outlined in Fig. 9. A detailed block diagram of the DVB-S2TD system architecture, as implemented in MATLAB is shown in Fig. 10.

During TD operation, the receiver presents two noisy copies of the same frame to the combiner. Using MRC, the combiner co-phases these two input signals to ensure coherent voltage addition and delivers a gain-weighted sum of the two signals to the demodulator, thereby improving the SNR at its input and consequently the BER at its output. The weighting factors are derived from the link estimator process, which produces a value for the instantaneous C/N . As discussed above, the output BER after demodulation following the MRC process varies with the choice of ΔT , as illustrated in Fig. 11.

To quantify the relative performance of the existing DVB-S2 protocol and the proposed DVB-S2TD scheme described above, computer simulations were implemented using MATLAB and comprised the following stages:

- (i) Calculate the gaseous attenuation at 19.7 GHz for Pontypridd, and at 29.5 GHz for Chilbolton, by using the meteorological data, according to ITU-R recommendation P.676-10.
- (ii) Scale the rain attenuation at 19.7 to 29.5 GHz for the Chilbolton site by following the procedure of ITU-R recommendation P.618-10
- (iii) Use the results from 1 and 2 to calculate the link budgets, enabling the estimation of link conditions for the uplink, $(C/N)_{UL}$; for the downlink, $(C/N)_{DL}$; and, finally, for the total end-to-end link, $(C/N)_{Total}$.

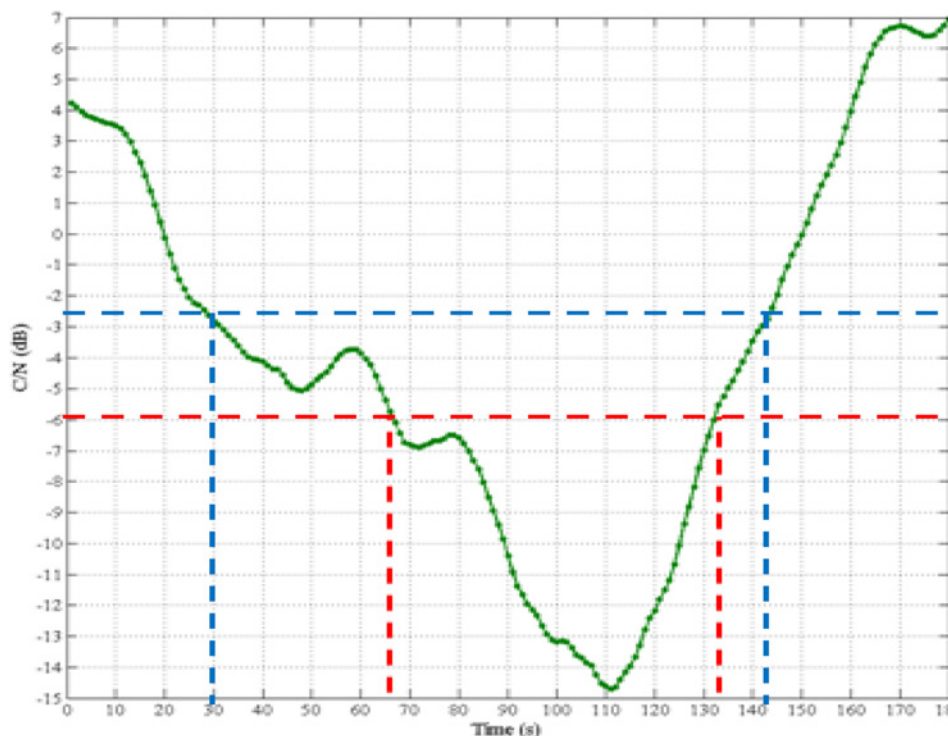

Fig. 13 C/N link estimation on an event on 01/12/2011

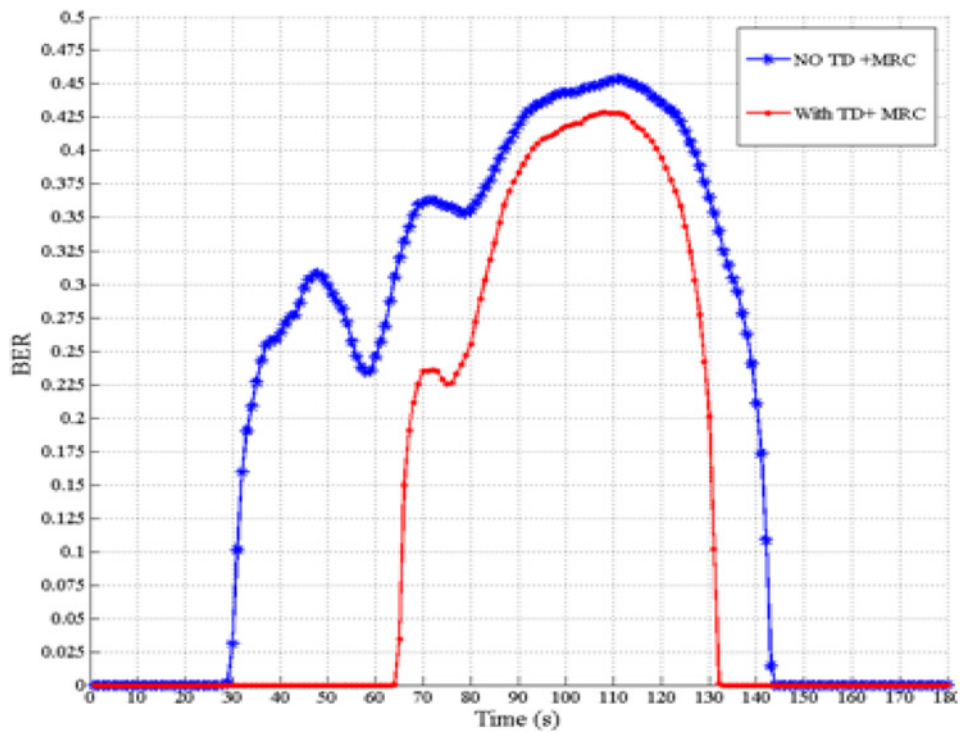

Fig. 14 BER performance on 01/12/2011

- (iv) Choose appropriate experimental events from the database, as shown in Fig. 12.
- (v) Use the chosen attenuation time-series as an input to the simulator in order to calculate the BERs for the following scenarios:
 - (i) Existing DVB-S2 at QPSK 1/4 (without TD + MRC)
 - (ii) Proposed DVB-S2TD at QPSK 1/4 (with TD + MRC)

Results and analysis

Six different events were chosen to cover different types of representative fading scenarios. Simulations were then carried out for each individual event as described in the previous section. The results obtained are presented in Table 1.

Table 1 illustrates the satellite link performance during six different rain events using for existing DVB-S2 system and the proposed

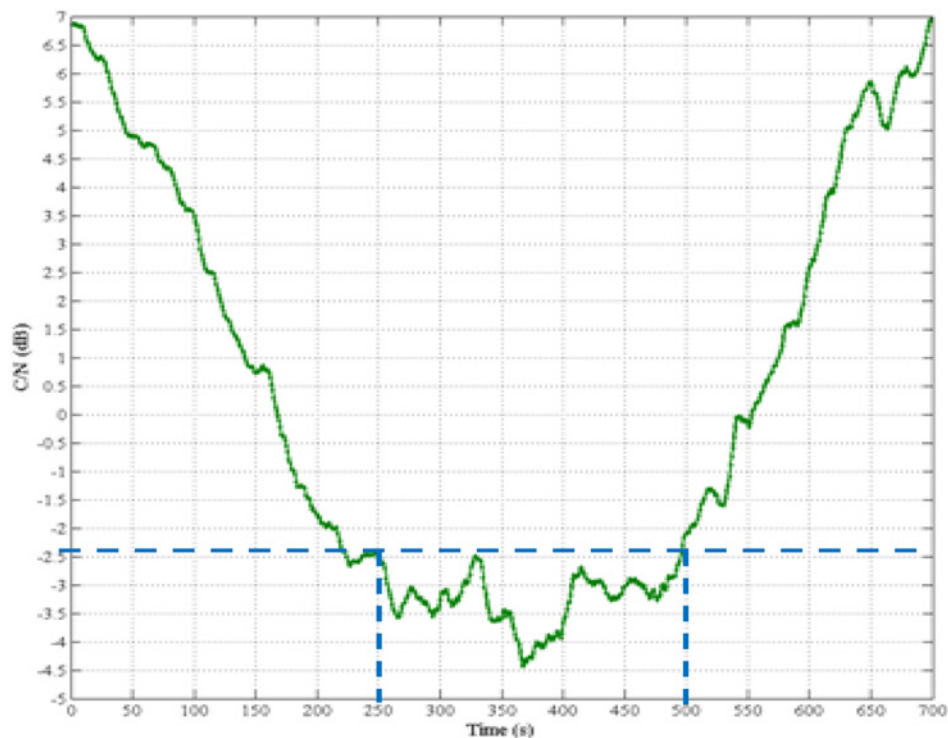

Fig. 15 C/N link estimation for an event on 12/04/2012

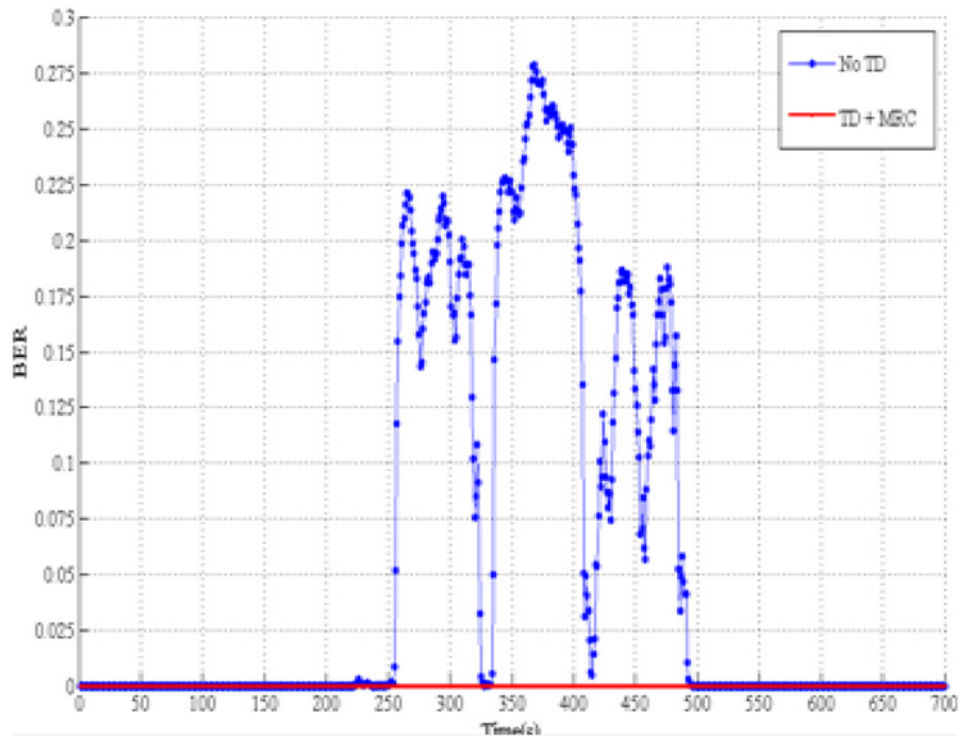

Fig. 16 BER performance on 12/04/2012

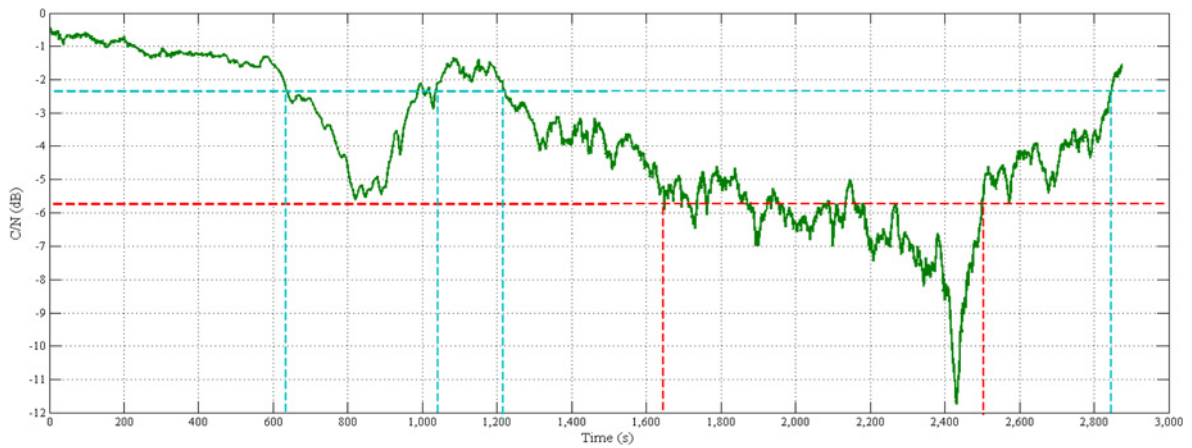

Fig. 17 C/N link estimation for an event on 07/05/2012

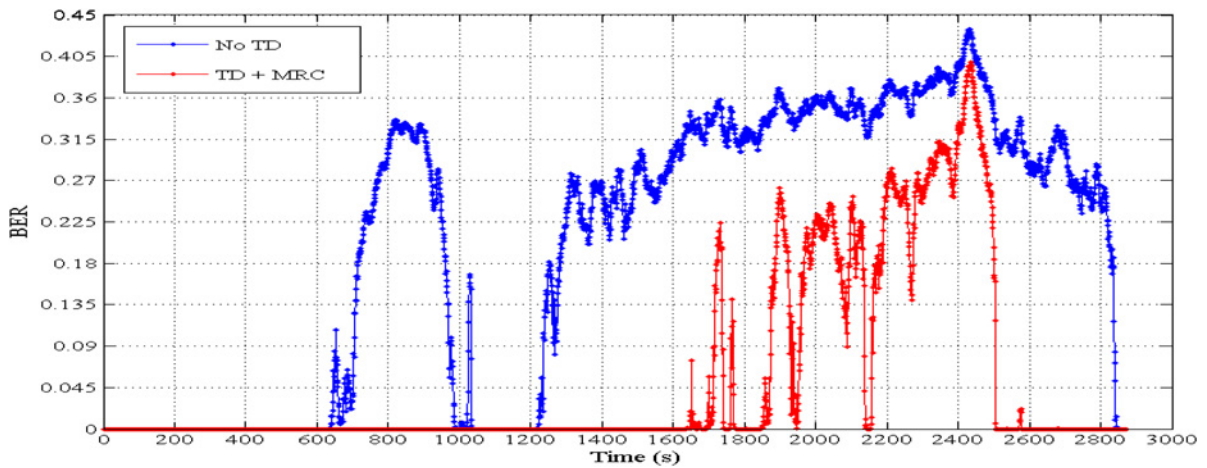

Fig. 18 BER performance on 07/05/2012

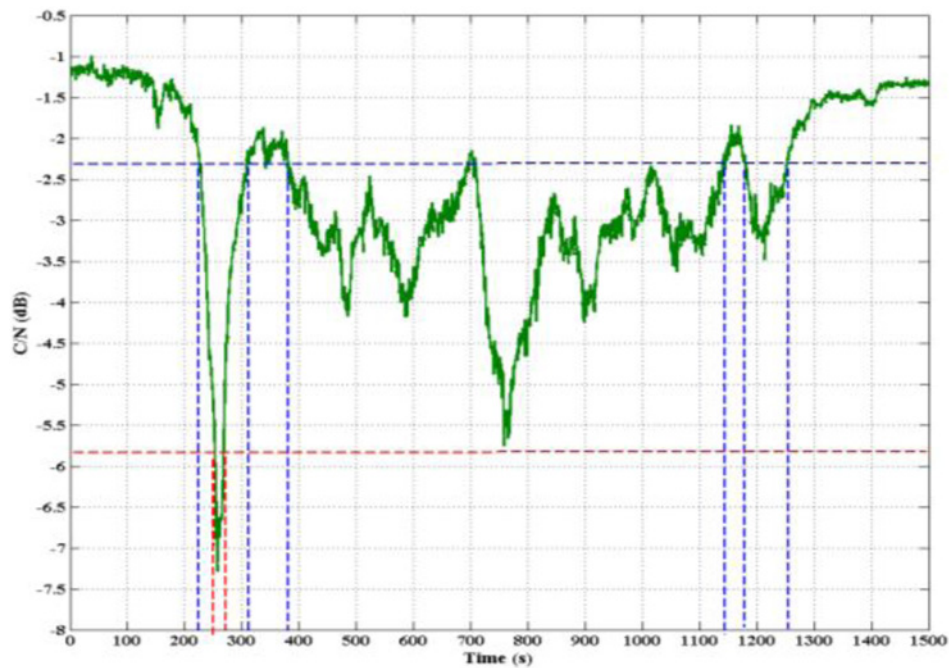

Fig. 19 C/N link estimation for an event on 05/10/2011

DVB-S2TD system. The outage durations are obtained by automatically determining when the output BER of the simulator is below the threshold BER value required by the DVB-S2 standard. The resulting outage times for the case of (i) TD + MRC operational and (ii) TD + MRC not in use are calculated and informed. The improvement in link availability is quoted as percentage. These estimation results are for a fixed delay of 5 s.

The date and GMT-time of the event is stated to the nearest second in column 1. The selected experimental event duration in seconds, is given in column 2. The third and fourth columns provide the link-outage durations for each system in seconds, while the last column states the outage reduction due to the incorporation of TD + MRC, as a percentage.

The blue dotted line in Figs. 13, 15, 17, 19, 21 and 23 shows the C/Nth level for the link estimation using the existing DVB-S2 system. The red colour dotted lines in Figs. 13, 15, 17, 19, 21 and 23 shows the C/Nth level for the link estimation using the proposed DVB-S2 system. The green line shows the actual link estimation variation during the event. In Figs. 14, 16, 18, 20, 22 and 24, the graphs have illustrated the BER performance for each of the systems.

The first event, shown in Fig. 13, has a total duration of 180 s. It was recorded on 1st December 2012 during rain, whereby the link outage was 113 s with the existing DVB-S2. The use of TD + MRC reduced the link outage to 67 from 113 s, as shown in Fig. 14. This improved the link availability by an additional 46 s. As a

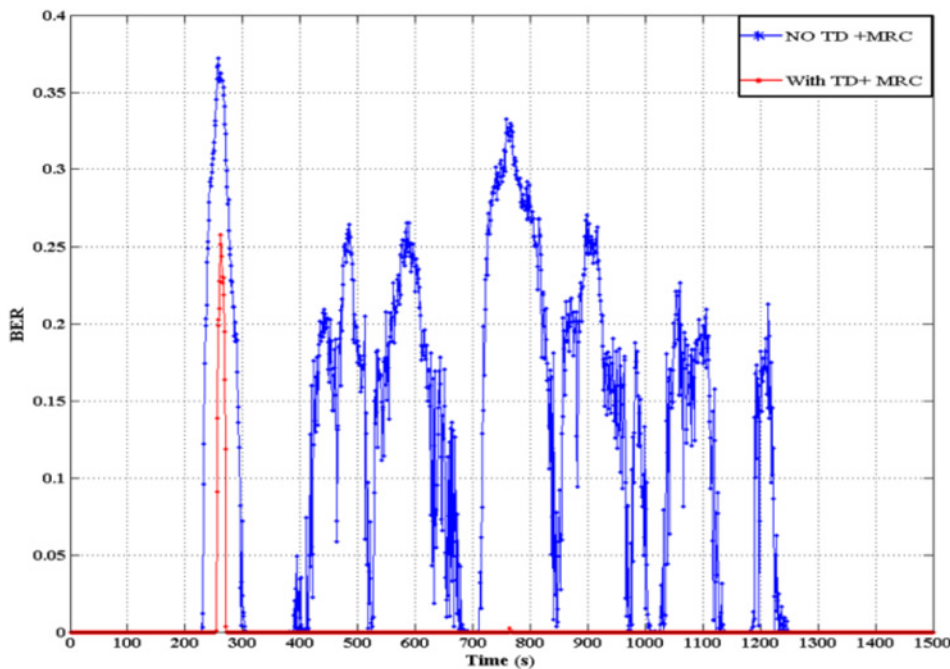

Fig. 20 BER performance on 05/10/2011

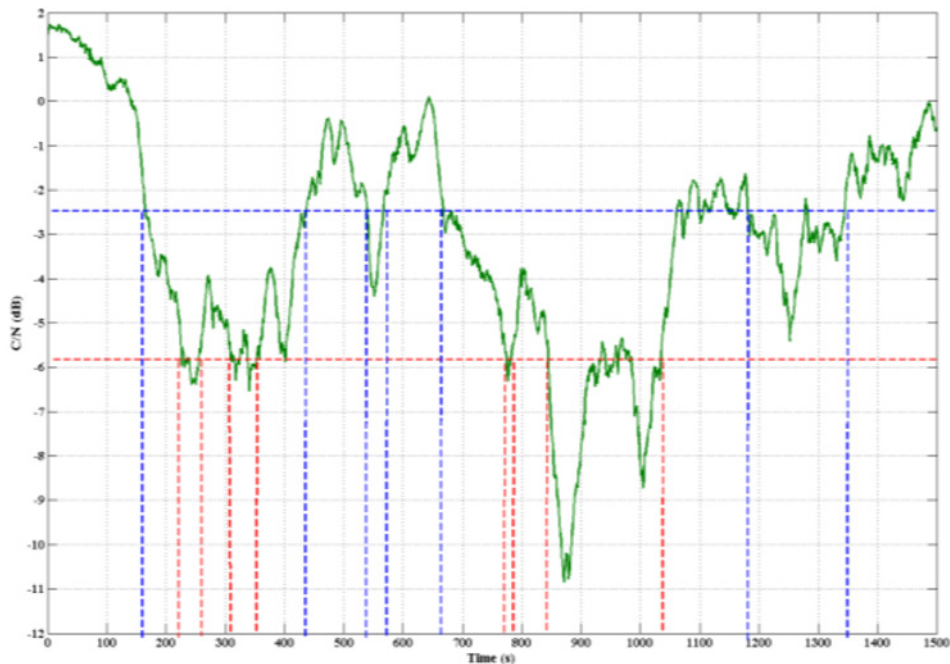

Fig. 21 C/N link estimation for an event on 06/08/2011

percentage, the link outage reduced by 40.70%. In this particular event, the C/N level drops from -2 dB to -15 dB within around 100 s and recovers to -2 dB within around 40 s. This is an example of a deep fade event.

The second event, shown in Fig. 15, has a duration of 700 s. It was recorded on 12th April 2012, with an outage of 260 s when using DVB-S2. The BER reduction, due to the use of TD + MRC, improved the link availability to 100%. The outage duration was reduced from 260 to 0 s, as shown in Fig. 16. At one point, the C/N level drops from -2 dB to -4.45 dB within 180 s, and returns to -2 dB within 150 s. This type of event can be categorised as exhibiting a medium fade-depth.

The third event, shown in Fig. 17, has an outage of 2501 s. It was recorded on 7th May 2012 and has a total duration of 2874 s. The integration of TD + MRC provided a link outage reduction of 68.89% by adding 1723s to the link availability, as shown in Fig. 18. This event can be categorised as a mix of medium and deep fades, as it has a deep fade for a short period and a medium fade for a comparatively long period. During the deep fade, the values of BER were significantly higher.

The fourth event shown in Fig. 19, has a total duration of 1500 s. It was recorded on 5th October 2011 during rain, whereby the link outage was 886 s with the existing DVB-S2. The use of TD + MRC reduced the link outage to 296 s from 886 s, as shown in Fig. 20. This improved

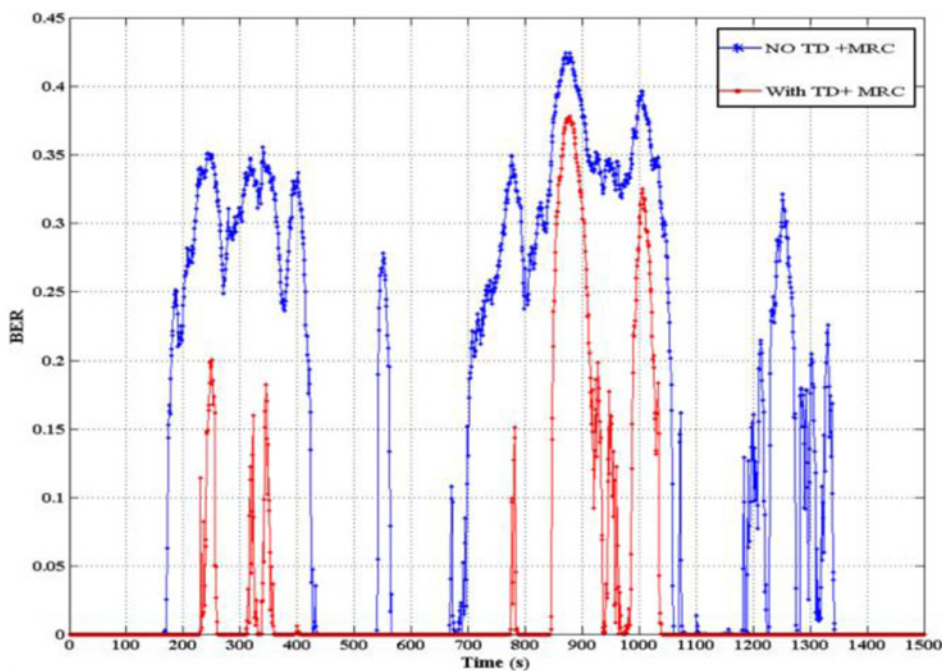

Fig. 22 BER performance on 06/08/2011

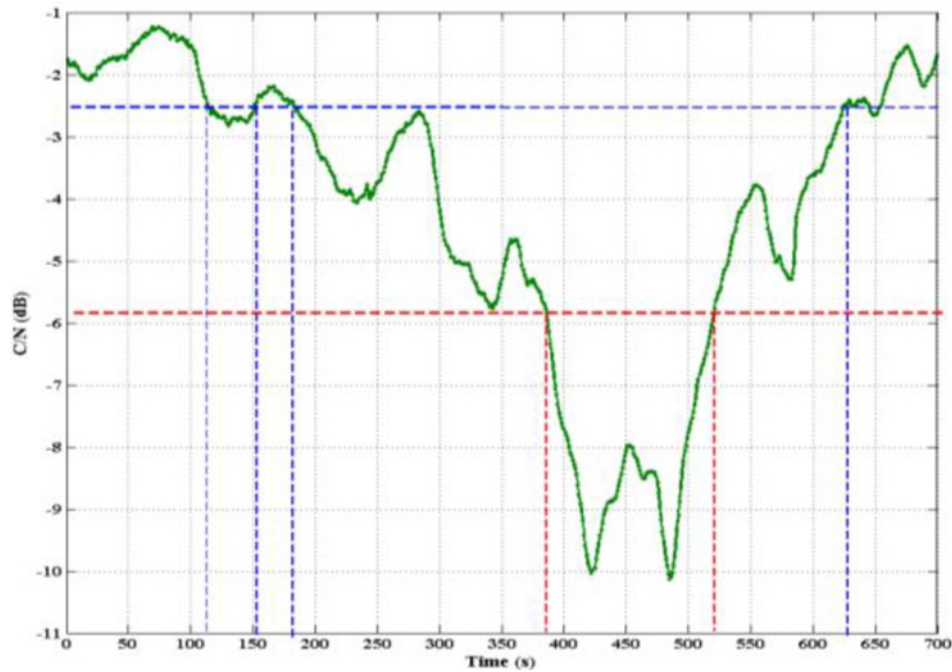

Fig. 23 C/N link estimation for an event on 01/05/2012

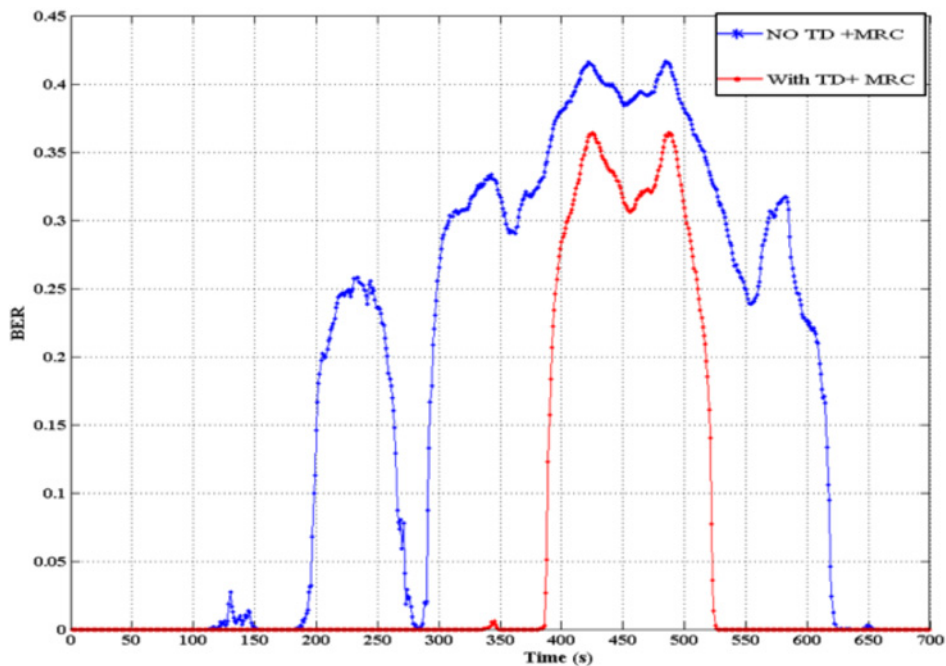

Fig. 24 BER performance on 01/05/2012

the link availability by an additional 590 s. As a percentage, the link outage reduced by 66.59%. In this particular event, the C/N level drops below the -2.34 dB DVB-S2 threshold on several occasions.

The fifth event shown in Fig. 21, also has a duration of 1500 s. It was recorded on 6th August 2011, with an outage of 864 s when using DVB-S2. The outage duration was reduced from 864 to 23 s by the use of TD + MRC, as shown in Fig. 22. Expressed as a percentage, the outage was reduced by 97.33%. Similarly to the previous event, the C/N level drops below -2.34 dB on several occasions.

The sixth event, shown in Fig. 23, has duration of 700 s. It was recorded on 1th May 2012 and has an outage of 498 s. The

integration of TD + MRC reduces the outage period by 68.27% by adding 340 s to the link availability, as shown in Fig. 24.

Conclusion

In this paper, we have shown how the twin techniques of TD and MRC can be successfully introduced into the existing DVB-S2 standard, thereby bringing about significant performance gains for satellite broadcasting systems operating at Ka-band. Our system simulations were based on a high-fidelity MATLAB model of the DVB-S2 protocol, which was driven by both directly measured and frequency-scaled satellite beacon attenuation data at 19.7 and

29.5 GHz, respectively. A 3-year, 2-site database of beacon measurements was used to select six representative fading events for comparative testing purposes. For each event, the performance of the existing DVB-S2 standard was compared with that of the proposed new scheme, DVB-S2TD, which incorporated TD and MRC.

On the basis of our comparative testing, we conclude that DVB-S2TD offers significant link availability enhancement over DVB-S2 across a variety of different fading event depths and durations. The TD + MRC technique offers the greatest system performance improvement under conditions where fades are long, but of moderate depth. The improvement becomes less significant for events comprising intense, short-period fades. The short time delay of 5 s used in this study is appropriate for near real-time applications requiring low-latency, such as live video broadcasting. Experimentation with longer time delays suggests that modest additional performance gain is achievable only at the expense of unacceptably long latency.

It is appreciated that the immediate activation of TD when C/N drops below threshold is not realistic in a practical system. This is because the decision to switch to TD (and to switch back to normal operation) requires feedback from the receiver, which will always involve some delay – the exact time taken being dependent on the particular technological implementation of the system. However, by accounting for fade dynamics, and by employing an appropriate degree of hysteresis with respect to the C/N levels used in the TD on/off switching decision process, the system's quality-of-service can be maximised.

In summary, DVB-S2TD provides operationally-useful performance benefits over DVB-S2, and is also competitive with the very latest standard, DVB-S2X. The lowest supported C/N level in the DVB-S2X standard for normal frames is -2.45 dB, whereas we have shown that integration of TD + MRC into DVB-S2 to yield DVB-S2TD provides continued system operation down to C/N values of around -6 dB.

The techniques described herein should be of benefit to satellite communications systems used for applications such as remote operations of unmanned aerial vehicles; military communications during combat operations; telemedicine; communications during natural disasters, peacekeeping operations or in conflict zones; live air and maritime tracking; and video and voice conferencing via VSAT.

A more detailed account of the work comprising this paper is given in [14].

References

[1] ETSI_DVB_S2, Digital Video Broadcasting (DVB); Second generation framing structure, channel coding and modulation systems for broadcasting, interactive services, news gathering and other

broadband satellite applications (DVB-S2) ETSI EN 302 307 V1.2.1 2009, ETSI.

[2] Rappaport T.S.: 'Wireless communications, principles and practise' (Prentice-Hall, New Jersey, 2002, 2nd edn.), ISBN 81-203-2381-5, p. 387

[3] STFC_Rutherford_Appleton_Laboratory: 'Radio Communication Research Unit – Science and Technology Facilities Council, STFC Rutherford Appleton Laboratory – Official web Page. 2015 [cited 2015 03/04]'. Available at <http://www.rcru.rl.ac.uk/show.php?page=home>

[4] EutelSat. Official web site for Eutelsat communications via satellite. /The Fleet / EUTELSAT HOT BIRD 13°. . 2014 [cited 2015 03/04]. Available at <http://www.eutelsat.com/en/satellites/the-fleet/EUTELSAT-8WC.html;jsessionid=BAEFCB952B3017DADA4B503975E8587C>.

[5] ITU_R_Scaling. Propagation data and prediction methods required for the design of Earth – space Telecommunication systems-Recommendation ITU-R P.618-10 (10/2009) – P Series Radio wave propagation-ITU-R Radio communication Sector of ITU- PDF document copy. 2013 [cited 2015 03/04]; Available at https://www.itu.int/dms_pubrec/itu-r/rec/p/R-REC-P.618-10-200910-S1!PDF-E.pdf.

[6] ETSI_DVB_S2_Fact_Sheet. DVB Fact Sheet – August 2012 2nd Generation Satellite (DVB-S2). 2009; Available from: https://www.dvb.org/resources/public/factsheets/DVB-S2_Factsheet.pdf.

[7] Otung I., Udofia K.: 'Efficacy of Time Diversity on V-band satellite links and impact of event dynamics'. ESA workshop on Radiowave Propagation 2011: ESA/ESTEC, Noordwijk, Netherlands

[8] Uggalla L., Eastment J., Otung I.E.: 'The Glamorgan satellite beacon monitoring station'. 6th Faculty of Advanced Technology Research Student Workshop, University of South Wales, 2011

[9] ETSI_DVB_S2X. ETSI EN 302 307-2 V1.1.1 (2014–10) Digital Video Broadcasting (DVB); Second generation framing structure, channel coding and modulation systems for broadcasting, interactive services, news gathering and other broadband satellite applications part:2 DVB-S2 Extensions (DVB-S2X)2014; Available at http://www.etsi.org/deliver/etsi_en/302300_302399/30230702/01.01.01_20/en_30230702v010101a.pdf

[10] Ventouras S., Callaghan S.A., Wrench C.L.: 'Long-term statistics attenuation from the Ka/U band ITALSAT satellite experiment in the United Kingdom'. Radio science, 2006. Vol. 41(RS2007)

[11] Chung T.K.P., Gallois A.P., Gremont B.C.: 'Frequency scaling of rain attenuation: results from Olympus satellite'. Antennas and Propagation, 1995., Ninth International Conference on (Conf. Publ. No. 407), 1995

[12] Otung I.E., Al-Nuaimi M.O., Evans B.G.: 'Extracting scintillations from satellite beacon propagation data', *IEEE Trans. Antenna Propag.*, 1998, **46**, (10), pp. 1580–1581

[13] ITU-R: 'Attenuation by atmospheric gases. ITU-R P series Recommendations P.676-10 – Radiowave propagation (09/2013), 2013, ITU: Geneva

[14] Uggalla L.: 'A resilient Ka-band satellite video broadcast system incorporating Time Diversity and Maximal Ratio Combining', PhD Thesis, University of South Wales, United Kingdom, 2015