



## FRACTIONAL ORDER CONTROLLER BASED FUZZY CONTROL ALGORITHM FOR SWITCHED RELUCTANCE MOTOR

Yang Congkun, Chen Chaobo and Fu Yongsheng  
School of Electronics and Information Engineering  
Xi'an Technological University, 710021  
Xi'an, shannxi, China  
Email: [yangcongkun2005@sina.com](mailto:yangcongkun2005@sina.com)

---

*Submitted: Dec. 27, 2015*

*Accepted: Mar. 29, 2016*

*Published: June 1, 2016*

---

*Abstract- The doubly salient mechanical structure and switching characteristics of switched reluctance motor (SRM) led to torque ripple, low dynamic performance and other problems when using conventional control algorithm in speed control method. In view of the fractional PID control algorithm has strong robustness and advantage of fuzzy control, and it does not depend on the precise mathematical model, the paper proposed a control algorithm based on fuzzy fractional order PID torque control algorithm. On the basis of fuzzy rules, using this control algorithm to adaptive SRM torque control, and using speed deviation and deviation changing rate as its input, the SRM turn torque ripple is smaller by changing proportional coefficient, integral order and differential order of the fuzzy inference adaptive fractional order PID controller. The simulation results indicate that the control algorithm is feasible, torque ripple of switched reluctance motor is smaller, dynamic response is better.*

**Index terms:** fuzzy control, fractional order PID, switched reluctance motor, speed control.

## I. INTRODUCTION

As a new speed control system, the Switched reluctance motor (SRM) has more advantages: such as simple structure and rugged, low cost, reliable, control flexible, high efficiency, etc. Thereby it has more applications in equipment of high-power and harsh environment, such as mining, oil, textile machinery, fans, pumps, planer [1], etc. In these cases, the advantages of SRM have been plated to reduce the cost and improve the efficiency greatly.

The Switched Reluctance Drives (SRD), consists of SRM, power converter, controller and detector, has more advantage than the AC and DC transmission system. The SRD is a kind of new speed control and drive system which is developed in the 1980s, which has widely speed control range, excellent speed performance and it has a high efficiency at whole process of speed control range with high reliability. Recently, The SRD technology has becoming a hot spot research and development [2].

Because of the doubly salient mechanical structure and switching characteristics of switched reluctance motor (SRM), it needs a long time to run in saturation to get the maximum output torque, thus, it leads to its electromagnetic showing much high non-linear. When the conventional PID control algorithm using for speed control, due to the structure and parameters are changing in the whole system, the fixed parameter PID controller is difficult to obtain the desired performance index. Because of some shortcomings: such as large torque ripple and torque unsmooth, the application of the fixed parameter PID controller at high-precision speed control occasions has been confined. For now, in order to improve the performance of SRM, more and more scholars begin to study intelligent control algorithm in SRM to improving its control strategies. A lot of work has been performed to study intelligent control algorithm application in SRM to make it easier to be applied in micro-control system [3].

Reference [4] completing the single neuron adaptive controller by the self-learning and adaptivity neurons to control the SRM. The controller could adjust controller parameters immediately by on-line identification to system through BRF network. The experiment results showed that the algorithm has more advantages of high accuracy, good dynamic performance and good adaptive ability. However, the algorithm cannot be used widely because of the large amount of calculation and complicated steps.

Reference [5], using the algorithm combined with fuzzy control and neuron PID, the simulation result shows that the algorithm has good dynamic performance and the anti-jamming performance is better than conventional PID control algorithm. But the shortcoming is smaller control accuracy.

Reference [6], the author put the iteration learning control method into torque control of SRM. By the iterative correction control parameters, that control method could get the inhibit torque ripple effect of SRM. However, the control method can only be used in low speed conditions because of the low efficiency.

Reference [7], the author used current double amplitude chopper control method to control the speed of the SRM. The experiment results showed that this method could reduce noise when the SRM work in low speed. But the method is limited to suppressing torque ripple.

For the strong coupling, nonlinearity and uncertainty characteristics of SRD, utilizing the advantage of flexible structure、strong robustness and adaptive fuzzy algorithm of fraction PID control algorithm [8], this paper presents a composite algorithm which depends on complex control algorithm with fractional PID control and fuzzy control according to actual project needs, a fuzzy reasoning table is proposed. That composite algorithm establishes the fuzzy reasoning table and changes proportionality coefficients、integral and derivative order of the fractional order PID controller, using speed deviation and deviation rate as the fuzzy controller input to control speed of switched reluctance motor.

## II. MATHEMATICAL MODEL OF SWITCHED RELUCTANCE MOTOR

### a. Operating Principle of SRM

The SRM has essential difference compare with the normal motor not only from the structure but also the operation mechanism. For example, the device structure of the SRM with 12 stators and 8 rotors is shown in figure 1.

In figure 1, the stators and rotors of SRM are made from silicon steel sheet overlying the alveolar shape, so make up a double salient structure. There are concentrated windings around the teeth on the stator and the windings radially spaced could form each phase reliably. While on winding and no permanent magnet on the rotor and the number of stator and rotor is not equal [9].

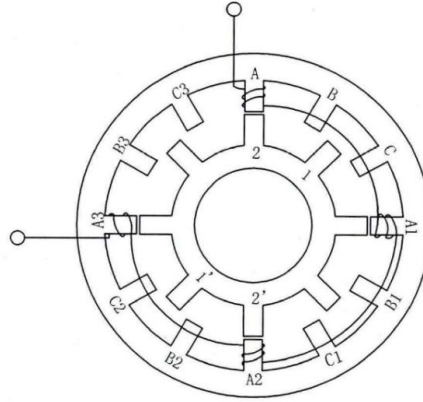

Figure 1. The structure of the SRM

The switch reluctance motor and the stepper motor have the same principle, it is electrical pulses driving the stator so that the stator rotate and it is according to the reluctance minimum path theory (RMPT).

The RMPT is flux along with the smallest path of reluctance closed at any time. According to that theory, the centerline axis of rotor salient always aligned with the center line flux which is generated by stator of conduction phase, it is called reluctance minimum position [2], because of this trend, the effective electromagnetic torque can be generated by SRM. Thus the rotor rotation at a reasonable logical energized for windings, and changing the energized sequence the rotor can be reversal.

#### b. Mathematical Model of SRM

According to the fundamental theorem, the each phase formula as following (1) :

$$u_k = Ri_k + \frac{d\Psi_k}{dt} \quad (1)$$

Here  $u_k$  and  $R$  represent voltage and winding resistance in  $K$ -phase motor winding, respectively, while  $i_k$  and  $\psi_k$  represent current and flux in  $K$ -phase, respectively.

When building a mathematical model of SRM, ignoring the mutual inductance characteristics in each phase, so that the flux is expressed as following equation (2):

$$\Psi_k = L_k(\theta, i_k)i_k \quad (2)$$

Here  $L_k$  is equivalent inductance while it is function about angle  $\theta$  and current  $i_k$  ( $\theta$  and  $i_k$  represent angle between the stator and rotor and stator current respectively.). In order to simplify

the math, the schematic of mathematical model can be show in figure 2. From figure 2, the equivalent inductance is a function of angle between the rotor and the stator, it is an isosceles trapezoid.

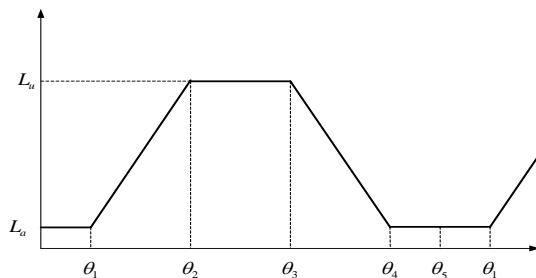

Figure 2. A mathematical model of the equivalent inductance

And the SRM electromechanical equation as shown in equation (3) and (4):

$$J \frac{d\omega}{dt} = T_e - T_L \tag{3}$$

$$T_e = \left. \frac{dW}{d\theta} \right|_{i=const} \tag{4}$$

In equation (3) and (4):

$J$  is the moment of inertia of motor;

$T_e$  is the electromagnetic torque of motor respectively;

$T_L$  is the load torque of motor.;

$W$  is the total magnetic energy,  $W = \sum_{j=1}^k \int_0^i \psi_j dt$ ;

The Switch Reluctance Motor is the K-phase motor.

Because of the equivalent inductance mathematical model is a nonlinear function, so the SRM mathematical model with nonlinear and time-varying characteristics. The major parasitic problem is torque ripple when the conventional linear control algorithm is used for speed control system of Switch Reluctance Motor[10].

### III. FUZZY FRACTIONAL ORDER PID ALGORITHM

#### a. Fractional Order Controller

With the development of modern technology and computer application technology, the theory of

fractional order calculus provides a theoretical basis and mathematical tool for the development of many disciplines. Fractional order theories and fractional order controller become new research areas in the control system, the main problem is solving fractional equations. In recent years, numerical methods and algorithms of the fractional calculus improving continuously, analysis methods and control strategy of various fractional order systems are put forward, as well as design method of fractional order controller, which further promotes the application and rapid development of fractional order control.

Fractional order controller can be described by fractional differential equations. These systems that can be described by fractional model and they can be regarded as fractional order control system. From controlling theory of fractional order, closed-loop control system consists of four categories [11, 12]: integer order controller and integer order controlled targets, integer order controller and fractional order controlled targets, fractional order controller and integer order controlled targets, fractional order controller and fractional order controlled targets. Application of fractional calculus in PID controller can enhance controlling performance it is better than traditional PID controllers, significantly [13]. Theoretically, fractional order controller can be used to control targets with any orders, the traditional PID controller is just special case of fractional order controllers.

Professor I.Podlubny proposed fractional order  $PI^\lambda D^\mu$  controller [14]. He also proved that the fractional order  $PI^\lambda D^\mu$  controller controls better than the integer order on fractional targets, and it can obtain better performance and robustness.

The fractional order  $PI^\lambda D^\mu$  controller is the generalized form of the conventional PID controller, including an integration order  $\lambda$  and a differential order  $\mu$ ,  $\lambda$  and  $\mu$  can be any real numbers. Its frame is shown in figure 3.

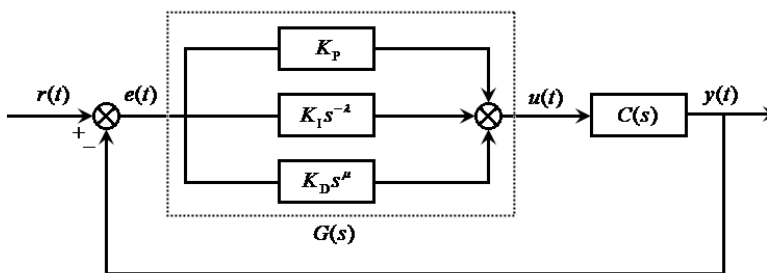

Figure 3. Structure diagram of the fractional order  $PI^\lambda D^\mu$  controller

In figure 3:

$e(t)=r(t)-y(t)$  is signal errors of system, it is input signal of fractional order controller;

$r(t)$  is expect signal of fractional order system;

$y(t)$  is the actual output of fractional order system;

$G(s)$  is transfer function of fractional order  $PI^\lambda D^\mu$  controller;

$C(s)$  is transfer function of controlled targets.

The transfer function of Fractional  $PI^\lambda D^\mu$  controller can be express equation (5):

$$G(s) = K_p + K_I \frac{1}{s^\lambda} + K_D s^\mu \quad (5)$$

The time-domain output signal  $u(t)$  can be express equation (6):

$$u(t) = K_p e(t) + K_I D^{-\lambda} e(t) + K_D D^\mu e(t) \quad (6)$$

It is similar with integer order PID, in equation (6):

$K_p$  is the proportional factor;

$K_I$  is the integral coefficient;

$K_D$  is the differential coefficient;

$\lambda$  is the order of integration ;

$\mu$  is the order of differential.

The traditional integer order PID controller is a special case of fractional order PID controller when fractional order PID controller is  $\lambda = 1$  and  $\mu = 1$ . When  $\lambda = 1$  and  $\mu = 0$ , it is a integer order PI controller; when  $\lambda = 0$  and  $\mu = 1$ , it is a integer order PD controller; when  $\lambda = 0$  and  $\mu = 0$ , it is a integer order P controller, as shown in figure 4(a). Thus it can be seen which all of these types of PID controllers are special cases of fractional order PID controller [15]. Differently, the parameter values of fractional order PID controller are not on the fixed point, but on the P-I-D plane discretionarily, as shown in figure 4(b).

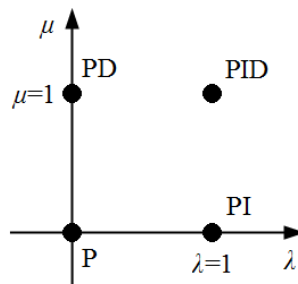

Figure 4(a). Integer order PID controller

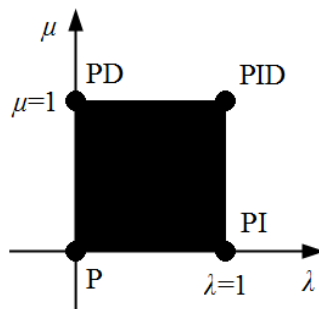

Figure 4(b). Fractional order PID controller

Compare with traditional integer order PID controller, because the fractional order  $PI^\lambda D^\mu$  controller has two more adjustable control parameters  $\lambda$  and  $\mu$ , It is has more two design freedom. Thus, it is difficult for tuning and optimizing these five parameters. But it is easier to change frequency response of the control system by changing the order of differentiation and integration, which is compare with changing controller proportional, differential and integral coefficients [14]. So we can get the better dynamic performance and robustness than traditional integer order PID.

#### b. Fractional Order PID Algorithm

Fractional calculus as a new language, it has its own unique logic and grammar rules. Fractional calculus allows any one order to be calculus order and it is extension of classic integer calculus. Fractional calculus has no uniform mathematics definition. Currently, there are three fractional definitions [16]: Riemann-Liouville definition, Grünwald-Lethnikov definition and Caputo definition. The Grünwald-Letnikov definition is expansion of Riemann-Liouville definition and its application is wider. Analogously, the Caputo is another improvement definition for Grünwald-Letnikov definition [17]. In practical supplication, which definition fractional derivative can be used that is depends on different situation.

This paper selects the GL(Grünwald-Letnikov) fractional calculus definition:

$${}_a D_t^\alpha f(t) = \lim_{h \rightarrow 0} h^{-\alpha} \sum_{j=0}^{[(t-\alpha)/h]} (-1)^j \binom{\alpha}{j} f(t - jh) \quad (7)$$

in equation (7):

${}_a D_t^\alpha$  is the fractional calculus operator;



$\alpha$  is the calculus order, meanwhile, it could be a real number;

$\alpha$  and  $t$  represent the bounds of the fractional operators,  $\binom{\alpha}{j} = \frac{\alpha!}{j!(\alpha-j)!}$ .

According to the GL fractional calculus definition, discretize the equation (6) [16], the fractional order PID expression is gotten as shown in equation (8):

$$u(k) = K_p e(t) + K_I T_s^\lambda \sum_{j=0}^k q_j e(k-j) + K_D T_s^{-\mu} \sum_{j=0}^k d_j e(k-j) \quad (8)$$

in equation (8):

$T_s$  is the sampling time;

$q_j$  and  $d_j$  are binomial coefficients;

Meanwhile,  $q_0 = 1$ ,  $q_j = (1 - \frac{1+\lambda}{j})q_{j-1}$ ,  $d_0 = 1$ ,  $d_j = (1 - \frac{1-\mu}{j})d_{j-1}$ ;

$u(k)$  is the output of controller,

$e(k)$  is the deviation of controller.

Incremental fractional order PID algorithm can be shown in equation (9):

$$\Delta u(k) = K_p \Delta e(t) + (K_I T_s^\lambda + K_D T_s^{-\mu})e(k) - \sum_{j=0}^k \left( \frac{1+\lambda}{j} K_I T_s^\lambda q_{j-1} + \frac{1+\mu}{j} K_D T_s^{-\mu} d_{j-1} \right) e(k-j) \quad (9)$$

Assume:  $K_A = (K_I T_s^\lambda + K_D T_s^{-\mu})$ ;  $K_j = \frac{1+\lambda}{j} K_I T_s^\lambda q_{j-1} + \frac{1-\mu}{j} K_D T_s^{-\mu} d_{j-1}$

Equation (9) can be derived from equation(10):

$$\Delta u(k) = K_p \Delta e(k) + K_A e(k) + \sum_{j=0}^k K_j e(k-j) \quad (10)$$

It has a higher historical memory compare with equation(9) and classic incremental PID algorithm, because of the differential order  $\mu$  and integral order  $\lambda$ . Choosing a reasonable parameter, the fractional order PID algorithm will get better robustness.

### c. Fuzzy Fractional Order PID Algorithm

Because of its technical features, such as serious nonlinearity, variable structure and parameters, it is difficult to establish the precise mathematical model of the SRM. It could not obtain ideal performance indicators using the conventional fixed parameter PID control method with various control strategies. The order of integral and differential can be extended to any real number in

conventional controller by Fractional calculus, it provide a better performance extension for the design of controller.

Fuzzy control method is a way of intelligent control method that it is used in the control engineering application widely. It is a kind of nonlinear control strategy essentially and is not depend on exact mathematical model of controlled object. It could obtain better control effect at nonlinear, time-varying, time-delay or variable structure control objects by the fuzzy control method, especially at the switched reluctance motor which is very difficult to be established the exact model. In recent years, more and more research and application have been acquired about fuzzy control method.

Combined with fractional proportional PID controller and fuzzy control logic, the fuzzy fractional PID controller can be created. It has characteristics of intelligent inference and nonlinear, particularly the PID controller based on fuzzy logic self-tuning parameters. It could obtain better control effect at complex control objects when it is used for some complex control object which is difficult to be modeled [18].

[19] completed fuzzy fractional order PID control algorithm to fuzzy reasoning through fuzzy inference's proportional coefficient  $K_P$ 、 integral coefficient  $K_I$  and differential coefficient  $K_D$  and regulated the weight of each aspects.

This paper achieve the fuzzy fractional order PID control algorithm by choosing proportional coefficient  $K_P$ 、 integral order  $\lambda$  and derivative order  $\mu$  to complete fuzzy reasoning. The principle diagram of fuzzy fractional order PID controller is shown in figure 5. Both deviation and deviation rate are as the input of fuzzy reasoning, and proportional coefficient、 integral order and derivative order as the output of fuzzy inference, the controller object can be controlled by passing these three parameters to the fractional order PID controller.

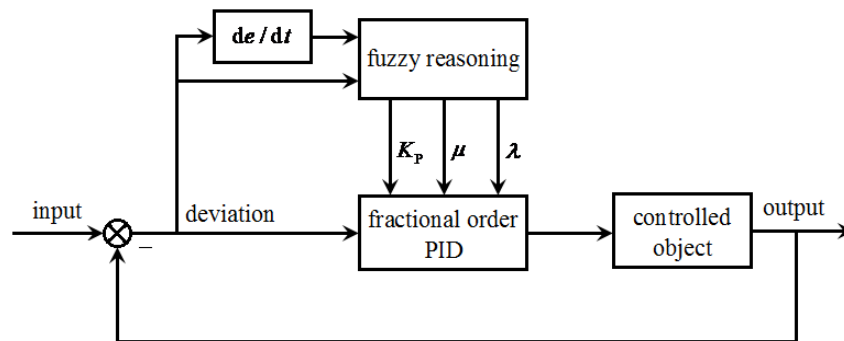

Figure 5. The principle diagram of fuzzy fractional order PID controller

According to the reference [20] and the analysis conclusions [21-22] of fractional order PID controller in the frequency domain, which indicates: the system adjust time is shorter and response is more sensitive when the proportional coefficient  $K_P$  increase, but too big  $K_P$  could lead to larger system overshoot even shock. The smaller integral order  $\lambda$  can be obtained the smaller overshoot and the larger static error if the  $\lambda$  is between 0 and 2. The larger  $\lambda$  can cause the system has a larger lag and even shock, although it will be reduce the static error. The larger differential order  $\mu$  lead to overshoot smaller and it is sensitive to noise of system. Summarize three factors for the system, using deviation and the rate of deviation as input, this paper designed appropriate fuzzy rules and finished fuzzy control fractional order PID control algorithm.

According to the system characteristic of SRM, the membership function of deviation and deviation rate  $\Delta e$  defined in this paper can be shown in figure 6. the domain of deviation and deviation rate total are {negative large, negative middle, negative small, zero, positive small, positive middle, positive larger}, and by letter can be shown in {NB, NM, NS, ZO, PS, PM, PB}.

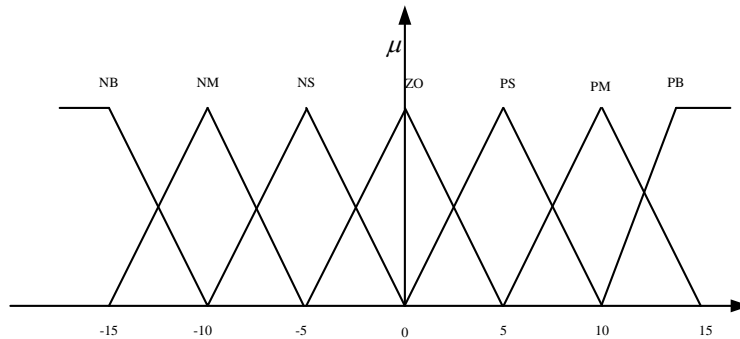

Figure 6. The membership functions of the deviation and the deviation rate  $\Delta e$

About fuzzy inference there are three outputs  $\Delta K_P$ ,  $\Delta \lambda$  and  $\Delta \mu$ , respectively. In order to easy to debug, this paper used the normalization processing: output as a percent of original amount. The membership functions of  $\Delta K_P$ ,  $\Delta \lambda$  and  $\Delta \mu$  is shown in figure 7, their domain are total {NB, NM, ZO, PM, PB}, and represent negative large, negative middle, zero, positive middle, positive larger, respectively.

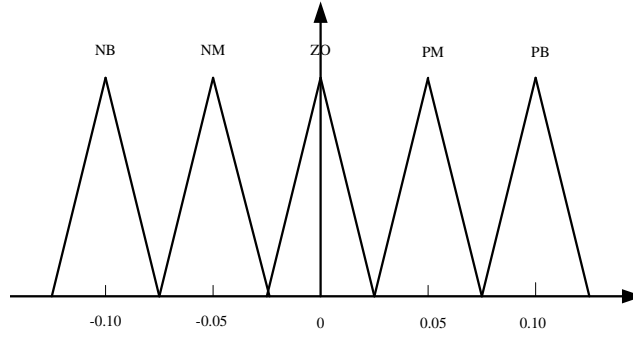

Figure 7. The membership functions of  $\Delta K_P$ ,  $\Delta\lambda$  and  $\Delta\mu$

Firstly, input and output variables membership function of controller should be determined, and according to experience, we can determine the fuzzy rules. The fuzzy rules of  $\Delta K_P$ ,  $\Delta\lambda$ ,  $\Delta\mu$ , deviation  $e$  and deviation rate  $\Delta e$  can be shown in table 1, table 2 and table 3.

Tab.1 The fuzzy rule table of the  $\Delta K_P$

$e$	$\Delta e$						
	NB	NM	NS	ZO	PS	PM	PB
NB	PB	PB	PM	PM	PM	ZO	ZO
NM	PB	PM	PM	PM	PM	ZO	NM
NS	PM	PM	PM	PM	ZO	NM	NM
ZO	PM	PM	PM	ZO	NM	NM	NM
PS	PM	PM	ZO	NM	NM	NM	NM
PM	PM	ZO	NM	NM	NM	NM	NB
PB	ZO	ZO	NM	NM	NM	NB	NB

Tab.2 The fuzzy rule table of the  $\Delta\lambda$

$e$	$\Delta e$						
	NB	NM	NS	ZO	PS	PM	PB
NB	NB	NB	NB	NM	NM	NM	ZO
NM	NB	NB	NM	NM	NM	ZO	PM
NS	NB	NM	NM	NM	ZO	PM	PM
ZO	NM	NM	NM	ZO	PM	PM	PM
PS	NM	NM	ZO	PM	PM	PM	PB
PM	NM	ZO	PM	PM	PM	PB	PB
PB	ZO	PM	PM	PM	PB	PB	PB

Tab.3 The fuzzy rule table of the  $\Delta\mu$ 

$e$	$\Delta e$						
	NB	NM	NS	ZO	PS	PM	PB
NB	NB	NB	NB	NM	NM	NM	ZO
NM	NB	NB	NM	NM	NM	ZO	PM
NS	NB	NM	NM	NM	ZO	PM	PM
ZO	NM	NM	NM	ZO	PM	PM	PM
PS	NM	NM	ZO	PM	PM	PM	PB
PM	NM	ZO	PM	PM	PM	PB	PB
PB	ZO	PM	PM	PM	PB	PB	PB

The control variable is a fuzzy variable that is obtained from the fuzzy reasoning decision and it is cannot be used to control the controlled object directivity. We should adopt some reasonable approach to convert the fuzzy amount into precise amount, this processing is called defuzzification: that is make the fuzzy set mapped to mapped accurately output which is output of inference system.

For defuzzification, the algorithm in this paper is same to classical algorithm compare proposed algorithm, so it is do not need to explanation [23-25].

This algorithm process as follows:

- (1) Initialization parameters. The initial values of proportional coefficient, integral coefficient and differential coefficient are set by conventional PID control algorithm. The integral order and derivative order are set to 1.
- (2) The system starts running, obtained deviation  $e$  and deviation  $\Delta e$  of the system. And through the fuzzy reasoning, the parameters  $\Delta K_P$ 、 $\Delta\lambda$  and  $\Delta\mu$  can be derived.
- (3) From equation (9), output of fractional PID is obtained. Finally, the algorithm process skips to step 2.

In this paper, the four-phase simulation system of SRM has been established by Matlab/Simulink, as shown in figure 8.

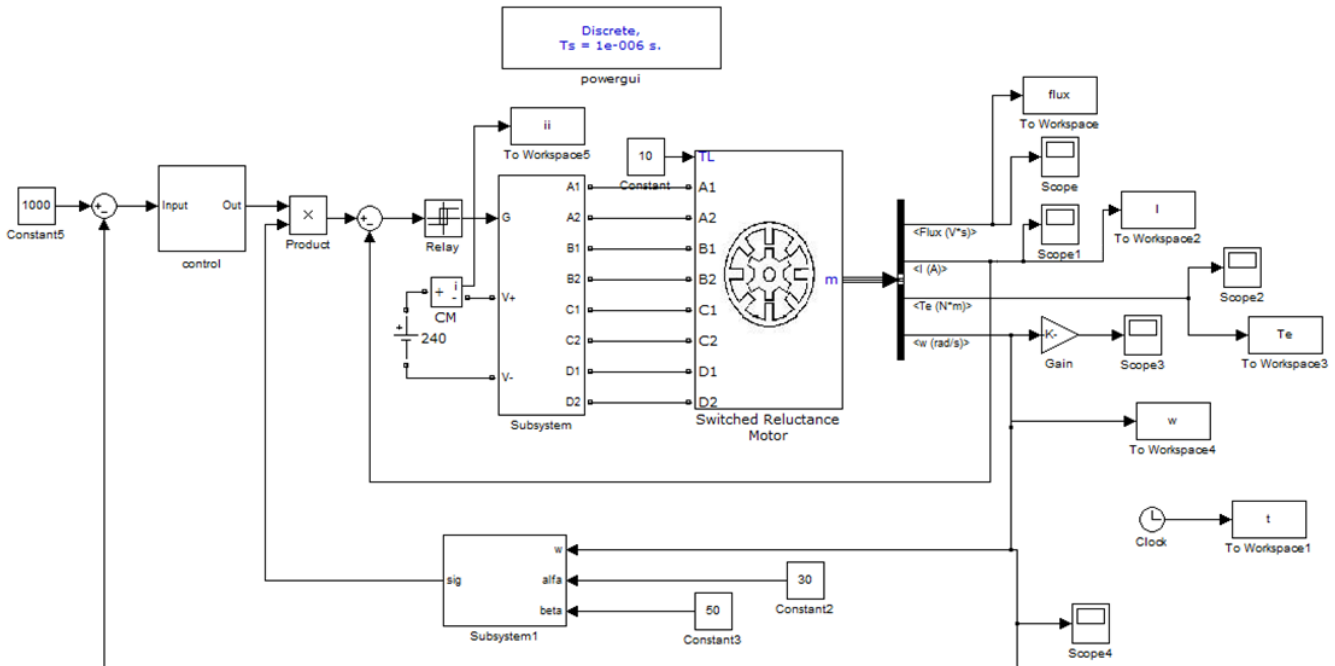

Figure 8. The simulation model of SRM based on fuzzy fractional PID control strategy

Where the SRM is four-phase and 8/6 classes, the switches are IGBT. The inner ring is current chopping mode and it is needs a constant turn-on and turn-off angle. By repeating debugging, the paper select turn-on angle is  $30^\circ$  and turn-off angle is  $50^\circ$  at last. And this paper established current chopping automatic control system through current negative feedback.

#### IV. SIMULATION RESULT AND ANALYSIS

##### a. Step Response of the Three Algorithms

In this paper, the controlled object is a SRM with 4kw power and rated current is 25A, rated voltage is 110v and moment of inertia is  $0.002kg\ m^2$ , saturated inductance  $3500\mu H$ , unsaturated inductance  $300\mu H$ , circuit resistance of  $100\ m\Omega$ .

Proportional coefficient, integral coefficient and differential coefficient are total determined by conventional PID algorithm. The parameters of the fractional PID algorithm parameters are based on the parameters of the conventional PID algorithm. In parameters setting function with tuning differential order and integral order, the parameters are:  $K_P=8.7$ ,  $K_I=0.4$ ,  $K_D=0.06$ ,  $\lambda =0.7$ ,  $\mu=0.9$ , respectively. The initial parameters of fuzzy fractional order PID control algorithm is based on

fractional order PID algorithm parameters, and the self-tuning of  $K_P$ ,  $\lambda$  and  $\mu$  is on the base of the fuzzy rules.

The simulation results of the step response by three algorithms at SRM speed control system can be shown in figure 9 by Matlab.

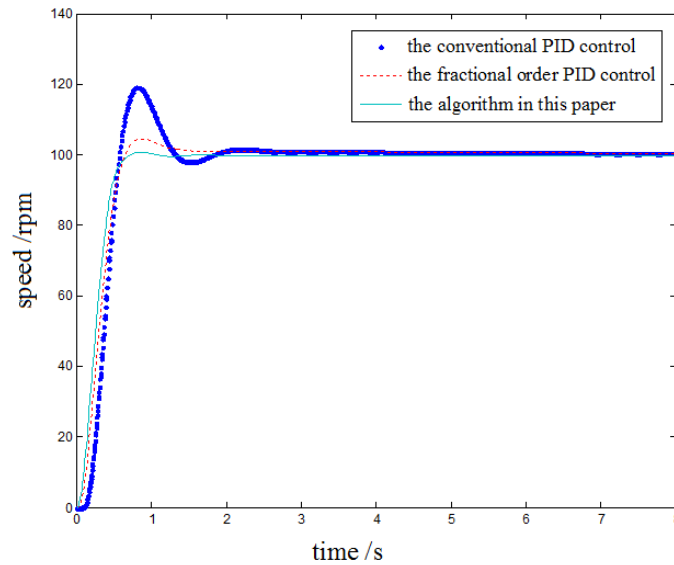

Figure 9. Compared with the step response of the three algorithms

From figure 9, the overshoot of fuzzy fractional order algorithm in this paper is smaller than conventional and fractional order PID algorithm, and the adjust time is also smaller. To further explicate the validity of the algorithm in this paper, here the evaluation control effect results are shown in table 4. And that is through evaluation index of control system.

Table 4. The control effect of the three algorithms

index algorithm	Over-shoot	Adjustment time	ISE	ITAE
Conventional PID algorithm	18%	2.12s	3.2722 $\times 10^7$	2.2992 $\times 10^5$
Fractional order PID algorithm	5%	1.25s	2.4037 $\times 10^7$	1.0205 $\times 10^5$
Fuzzy fractional order PID algorithm	1%	0.95s	1.9459 $\times 10^7$	9.0103 $\times 10^4$

From the table 4, the overshoot and adjusting time of fuzzy fractional order PID are better than the other two kinds of algorithms, and it has better control effect.

### b. Output Torque of the Three Algorithms

About the torque ripple, the contrasting results of the fuzzy fractional order algorithm in this paper, the conventional PID algorithm and the fractional order PID algorithm are shown in figure 10.

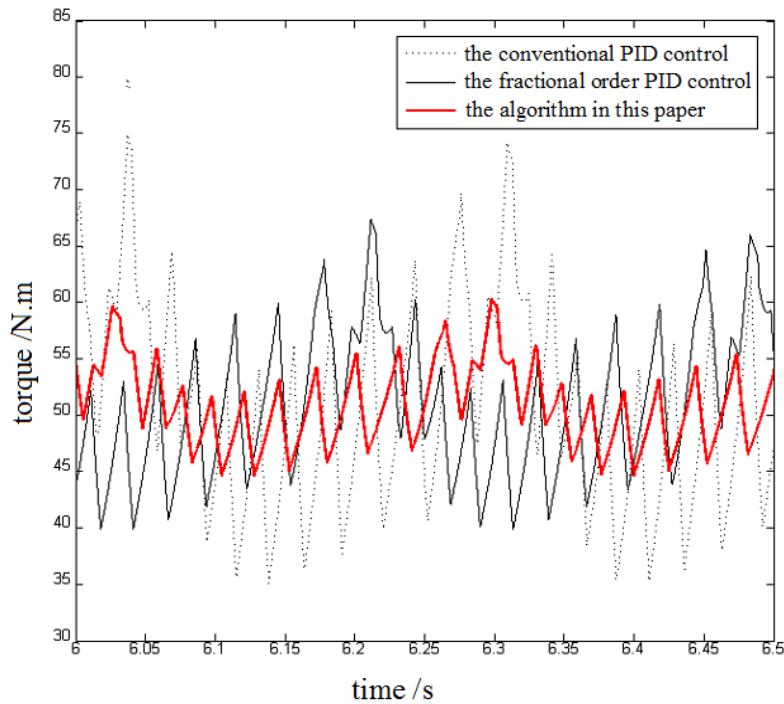

Figure 10. Compared with the output torque of the three algorithms

From figure 10, the torque ripple coefficient of the fuzzy fractional order control algorithm is smaller, its variance is 29.0477. However, the variance of the conventional PID algorithm is 38.8742, and the variance of the fractional order PID algorithm is 32.4876.

### c. Flux Linkage Ripple of the Three Algorithms

About flux pulsation, the result shown in figure 11, which is the paper's control algorithm compare with conventional PID control algorithm and fractional PID control algorithm.



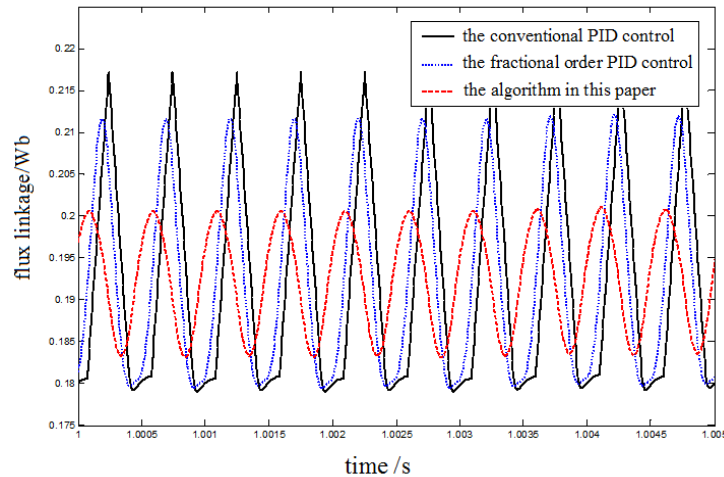

Figure 11. Compared with the flux linkage ripple of the three algorithms

From figure.11, the flux ripple of conventional PID algorithm is bigger, and it is about 0.038Wb, the control effect of classic algorithm can be improved by fractional PID algorithm, the flux pulsation reduce to 0.032Wb. In this paper the fuzzy fractional algorithm is better than the other two algorithms, significantly, pulse coefficient is smaller and the flux pulsation greatly reduced to 0.018Wb. So the current harmonic distortion will be reduced, while improve the stability of the motor, significantly.

#### d. Current Fluctuation of the Three Algorithms

About current fluctuation, in this paper the result shown in figure.12, which is the paper's control algorithm compare with conventional PID control algorithm and fractional PID control algorithm.

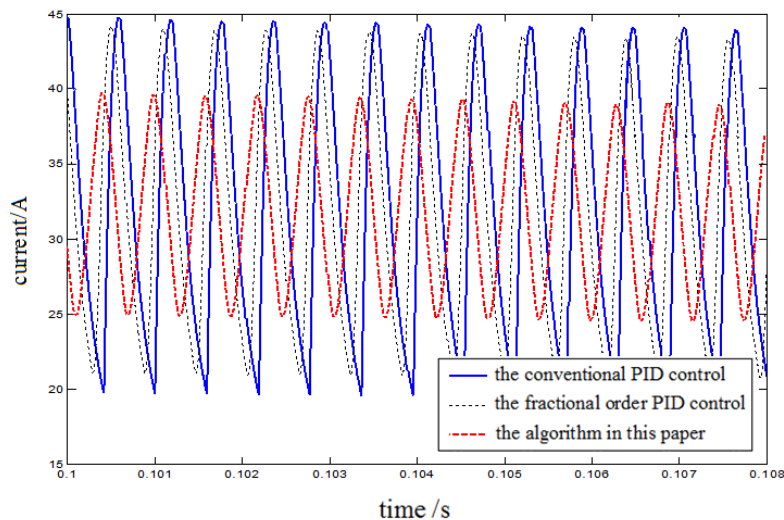

Figure 12. Compared with the current fluctuation of the three algorithms

Due to the switching characteristics of SRM, a good control algorithm to reduce the current fluctuation is necessary, so that the interference and impact of power grid can be reduced. From figure 12, the current ripple is bigger in conventional PID algorithm, but the fractional PID algorithm can reduce the current fluctuations. In this paper the fuzzy fractional algorithm is superior to other two kinds of algorithm, and it is improve the safety of the system, significantly. In conclusion, the Matlab simulation result indicate: compared with the conventional PID control algorithm and the fractional order PID control algorithm, the fuzzy fractional order algorithm in this paper has better overshoot and adjustment time performance, etc. And the torque ripple, flux pulsation and current fluctuations can be reduced, significantly. This algorithm is a kind of effective control algorithm and it can obtain better control effect.

## V. CONCLUSIONS

In this paper, the effect of SRM speed control is analyzed and simulated through fuzzy fractional order PID algorithm. Compared with conventional PID algorithm and fractional PID algorithm, the results validate it greatly improves the speed quality of SRM, and it has more advantages: better robustness and faster adjustment time, smaller overshoot and smaller torque ripple.

It is a research hotspot that the fractional calculus is used in traditional automatic control field. With the development of the study and application, fractional Order Controller will become a highlight in the field of control. The fuzzy fractional order PID controller which has very good robustness and adaptability will be obtain the widespread application in the systems with parameter uncertainty and the nonlinear systems. Therefore, given the complexity in the fractional control algorithm, optimization algorithm will be studied further so that it can be used for micro-control system.

## ACKNOWLEDGEMENTS

These works were supported by Weapon Pre-research Support Fund of China (62201070317) and Industrial technology research project in shaanxi Science and Technology Department (2014K06-40).

## REFERENCES

- [1] Ge Baoming and Jiang Jingping, "Overviews of Control Strategies for Switched Reluctance Motor", *Electric drive*, Vol. 31, No.2, 2001, pp. 8-13.
- [2] Wu Jianhua, "Switched reluctance motor design and application", Beijing: China Machine Press, 2001.
- [3] Chen Zhemin and Pan Zaiping, "Switch reluctance motor optimal control research based on iterative learning", *Journal of Zhejiang University*, Vol.40, No.1, 2006, pp. 25-28.
- [4] Xia Changliang and Wang Mingchao, "Single Neuron PID Control for Switched Reluctance Motors Based on RBF Neural Network", *Proceedings of the CSEE*, Vol. 25, No.15, 2005, pp. 161-165.
- [5] Chen Yongguang and Wang Honghua, "Study of Fuzzy- single Neuron PID Control of Switched Reluctance Motor", *Machine Building & Automation*, Vol. 1, 2013, pp. 157-159.
- [6] Pan Zaiping and Luo Xingbao, "Torque Ripple Minimization of Switched Reluctance Motor Based on Iterative Learning Control", *Transactions of China Electrotechnical Society*, Vol. 07, 2010, pp.51-55.
- [7] Xang Xudong, Wang Xilian, Wang Yan et al, "Double Amplitude Chopping Control of Switched Reluctance Motor", *Proceedings of the CSEE*, Vol.04, 2000, pp. 84-87.
- [8] Xiu Jie and Xia Changliang, "GA-Based Adaptive Fuzzy Logic Controller for Switched Reluctance Motor", *Transactions of China Electrotechnical Society*, Vol. 22, No.11, 2007, pp. 69-73.
- [9] P.J.Lawreson, J.M.stephenson,P.T.Blenkinsop, et al, "Variable-speed Switched Reluctance Motors", *IEEE Proceedings on Electric Power Applications*, Vol.127, No.4, 1980, pp.253-265.
- [10] Podlubny I., "Geometric and physical interpretation of fractional integration and fractional differentiation", *Fractional Calculus and Applied Analysis*, Vol.5, No. 4, 2002, pp.367-386.
- [11] Li Hongsheng, "fractional-order control and  $PI^{\lambda} D^{\mu}$  controller design and progress", *Machine Tool & Hydraulics*, Vol. 35, No.7, 2007, pp. 237-240.
- [12] Bhaskaran T, Chen Y Q, Xue D Y. "Practical turning of fractional order proportional and integral controller(I): tuning rule development.//Proceedings of the ASME 2007 International Design Engineering Technical Conference & Computer and Information in Engineering Conference IDETC/CIE. Las Vegas, Nevada, USA: Design Engineering Division and Computers and Information in Engineering Division, Vol. 5, 2007, pp. 1245-1258.

- [13] Petras I, Vinagre B M., "Practical application of digital fractional-order controller to temperature control", *Acta Montanistica Slovaca*, Vol.7, No.2, 2002, pp. 131-137.
- [14] Podlubny I. "Fractional-order system and PI $\lambda$ D $\mu$ -controllers", *IEEE Transactions on Automatic Control*, Vol. 44, No.1, 1999, pp. 208-214.
- [15] Vinagre B M, Monje C A, Calderon. Fractional order systems and fractional order control actions. Lecture 3 of the IEEE CDC02 TW#2: Fractional Calculus Applications in Automatic Control and Robotics. USA: IEEE, 2002, pp.1-23.
- [16] Zhao Chunna, Li Yingshun, Lu Tao, "Fractional Order Systems Analysis and Design", Beijing: National Defense Industry Press, 2011.
- [17] Podlubny I., "Fractional Differential Equations", San Diego: Academic Press, 1999.
- [18] Ferreira N M F, Machado J A T., "Fractional-order hybrid control of robotic manipulators", *Proceedings of the 11th International Conference on Advanced Robotics*, Piscataway, Japan: IEEE Press, 2003, pp.393-398.
- [19] Cao Junyi, Liang Jin and Cao Binggang, "Fuzzy Fractional Order Controller Based on Fractional Calculus", *Journal of Xi'an Jiaotong University*, Vol.39, No.11, 2006, pp. 1246-1249.
- [20] Liang Taonian, "Fractional Order PID Controllers and Analysis of Stability Region for Fractional Order Systems with Uncertain Parameters", Xidian University, 2011.
- [21] T.Ohji, S.C.Mukhopadhyay, M.Iwahara and S.Yamada, "Permanent Magnet Bearings for Horizontal and Vertical Shaft Machines - A Comparative Study", *Journal of Applied Physics*, Vol. 85, No. 8, pp 4648-4650, April 1999.
- [22] Aghababa M P, Borjkhani M., "Chaotic fractional - order model for muscular blood vessel and its control via fractional control scheme", *Complexity*, 2014.
- [23] S.C.Mukhopadhyay, T.Ohji, M.Iwahara and S.Yamada, "Design, Analysis and Control of a New Repulsive Type Magnetic Bearing", *IEE proceeding on Electric Power Applications*, vol. 146, no. 1, pp. 33-40, January 1999.
- [24] Dumlu A and Erenturk K, "Trajectory Tracking Control for a 3-DOF Parallel Manipulator Using Fractional-Order PID Control", *Industrial Electronics, IEEE Transactions on*, Vol. 61, No.7, 2014, pp. 3417-3426
- [25] Vinagre B M, Podlubny I, Hernandez A, Feliu V., "Some applications of fractional order operators used in control theory and applications", *Fractal Calculus and Applied Analysis*, Vol.3, No.3, 2000, pp.231-248.