



AUTOMATIC CONTROL PROCESS OF SOLENOID VALVE PRODUCTION LINE BASED ON PLC AND TOUCH SCREEN

Jian Chu^{1,2}, Yan Feng^{1*}

¹School of Automation and Electrical Engineering
Tianjin University of Technology and Education
Tianjin, 300222, China

²Key laboratory of Information Sensing & Intelligent Control
Tianjin University of Technology and Education
Tianjin, 300222, China

Emails: xiaoshitou322@126.com

Submitted: June 26, 2013

Accepted: Nov. 17, 2013

Published: Dec. 23, 2013

Abstract- This article introduces the automatic control process of solenoid valve production line with PLC control and touch screen user interface. The production line can produce four types of solenoid valves. There are numerous steps in the production process to ensure the quality of the products, e.g.

image error detection and Helium leak detection. The control process uses the Siemens S7-300 as the control core, in conjunction with the Siemens touch screen TP 177B as the human machine interface to achieve the real-time control for the production line. The system control structure, hardware components, software design, as well as the process of automatic control are articulated in this article. The production line runs with consistent stability, the man-machine interface is user friendly, and all the processes have a high level of automation.

Index terms: Solenoid valve, production line, distributed control, PLC, touch screen, PROFIBUS-DP, magnetic levitation.

I. INTRODUCTION

Because of growing beneficial economic development, more and more families buy private cars, this higher demand from these families gives the Chinese automotive industry a bright future and great potential. Car buyers are paying more and more attention to safety features of a car. ABS (anti-lock brake system), not only has normal break functionality, but also can prevent the wheels from locking up (ceasing rotation) and avoiding uncontrolled skidding. This system stabilizes the direction of a car when it is braking, which prevents skidding and wandering. ABS is currently the most advanced braking system and has the most beneficial effects in the braking system. The main component of this device is the solenoid valve [1-2]. The production process of solenoid valve involves assembly and welding. The assembly process is very difficult, and the welding process must meet high standard requirements. Using artificial production is not only inefficient, but also has low product pass rate. This article describes an automatic production line control system, mainly based on Siemens PLC. It uses the Siemens PLC to control the entire production process, which tremendously improves production efficiency and product quality.

II. PRODUCTION LINE PROCESSES

This production line can produce four models of solenoid valves. To switch among the four models to produce, the operator just needs to choose from the models on the touch screen of the host computer controller. The process of production includes preparing product parts, assembling products and removing products off the assembly line. The production processes are illustrated in Figure 1.

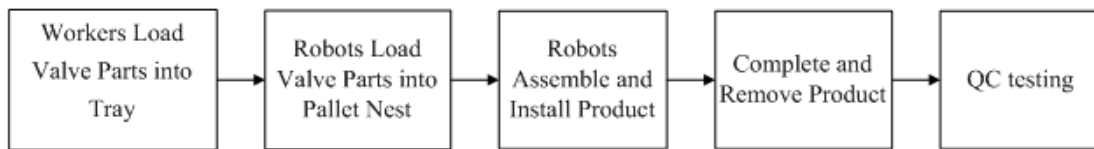

Figure 1. The processes of production line

Valve parts for the corresponding model are prepared and loaded into the tray on turntable. The turntable takes the tray and rotates to the side of the robot. The robot takes out the parts and loads them into pallet nest. Then the pallet nest is transported to various stations by the transport system to be assembled and welded. This process also includes numerous detection steps to ensure that the correct product model is built, the welding has high quality, parts are assembled correctly, and it maintains good air tightness.

III. CONTROL SYSTEM DESIGN

According to the requirements of the production situation, the production line is divided into two control modes: the production management level control and the lower machine level control. The host computer acts as the production management level control in order to manage lower machine monitoring, production and operations. The lower machine level control is mainly used to collect field data and monitor the control process.

The production line adopts Siemens PLC to control and monitor the production line, in order to fulfill process requirements, achieve the intended control effect as well as online monitoring. It builds up PLC communication network by PROFIBUS-DP [3], to realize the distributed control. ET200M distributes I/O devices, sensor communicates with PLC through PROFIBUS-DP, and sensor collects the measurement data which is used for the production process.

The production line includes a dial, vacuum robot, laser welder, helium leak detector, laser marker, loading and unloading stations, a transport mechanism as well as a testing agent. The operation of these stations is controlled by the PLC through the network. The PROFIBUS-DP network [4-5] is shown in Figure 2. All communication among working processes is executed through the network monitoring system in order to achieve real-time monitoring.

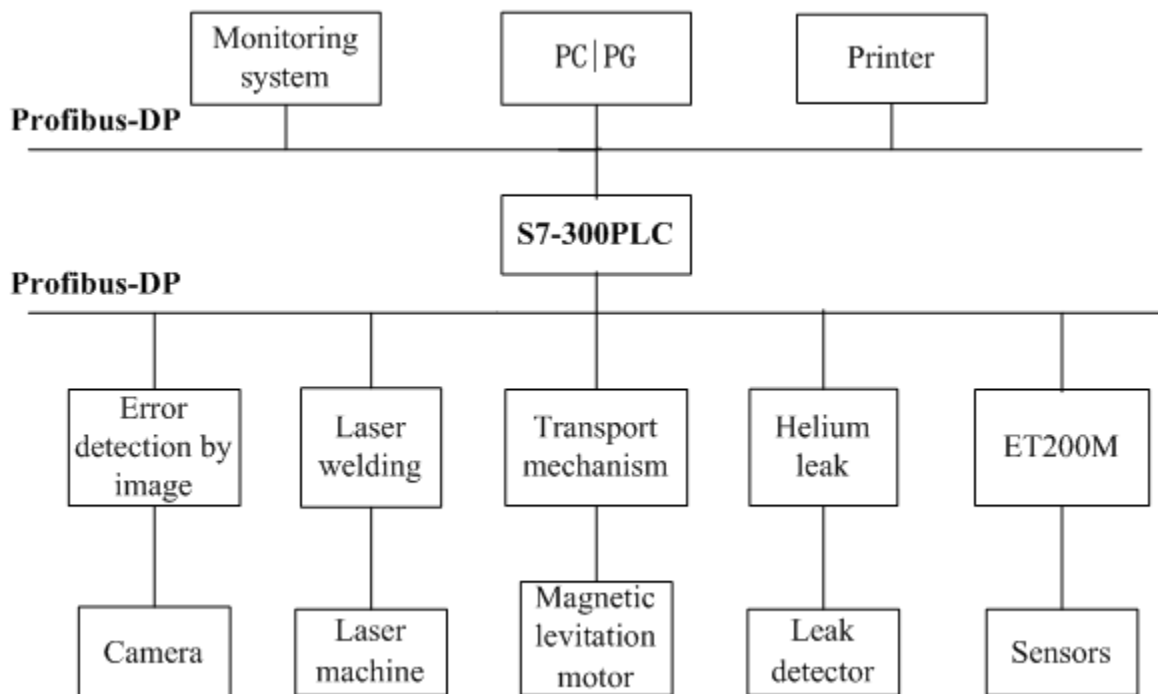

Figure 2. System PROFIBUS-DP network diagram

IV. HARDWARE CONSTITUTION

The hardware constitution of the production line is shown in Figure 3[5]. The hardware core of the control system is the PLC. The hardware system includes the vacuum robot system, an image error proofing system, a line station delivery system, a laser welding system, and a Helium Leak detector. PROFIBUS-DP master adopts Siemens S7-300 PLC, and CPU module uses CPU 315-2DP central processing unit, which comes with the DP interface as the DP network master. The maximum data transfer rate of the network is 12Mbps. ET200M modules are used as the I/O modules. ET200M is a multi-channel modular distributed I/O, which can use a full range of modules of S7-300.

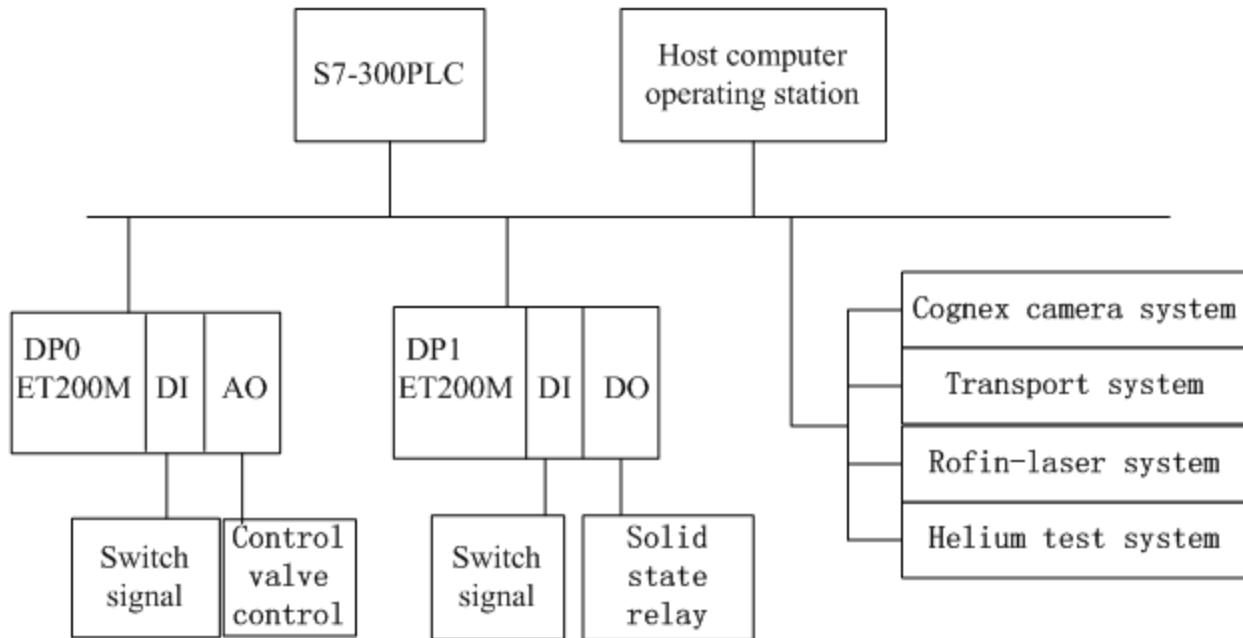

Figure 3. Hardware constitution of the production line

Automatic control and parameter setting are done through a human-machine interface, such as the Siemens touch screen TP177B. In addition, the transmission system uses a magnetic levitation motor, the laser system uses the Rofin-Laser system, the helium detection system uses helium leak detectors, and the image error detection uses Cognex Camera. Introduction of each of these systems are described below:

1. Line station system control

The assembly mode of production line is called line station. Each station is designed to complete a specified operation. The transport system takes the pallet nest to each station. When the pallet nest arrives, the proximity sensor on the station senses the nest and sends feedback to PLC. We decided to use inductive proximity sensors after comprehensive consideration.

We adopted Schneider OSIPROX series XS4 model sensor in this system. It is a kind of switch output position sensor [6-7], which consists of a high-frequency LC oscillator, a switch circuit and an amplifying processing circuit. The oscillator generates an alternating magnetic field, which excites the vortex inside the metal target when the metal target is close to this field, therefore it can sense distance. Due to the fact that ferromagnetic metal objects have hysteresis loss, both the oscillation circuit resistance and the energy loss will increase, resulting in attenuation of the oscillation, as well as a halt in vibrations; So that the internal circuit parameters will be changed. The diversification of the oscillation and halt in vibrations in the oscillator will be processed and converted into a switching signal by the post-stage amplifier circuit, which touches off and drives the device, to achieve the purpose of non-contact detection.

PLC issues corresponding operation instructions to control the robot action. The operations of the robot include collecting parts by vacuum robot, loading the parts into the solenoid valve body, and squeezing spare parts. After finishing one step, the pallet nest is sent to the next station, and such actions go on until the product is completed and off the assembly line. Some stations are shown in Figure 4.

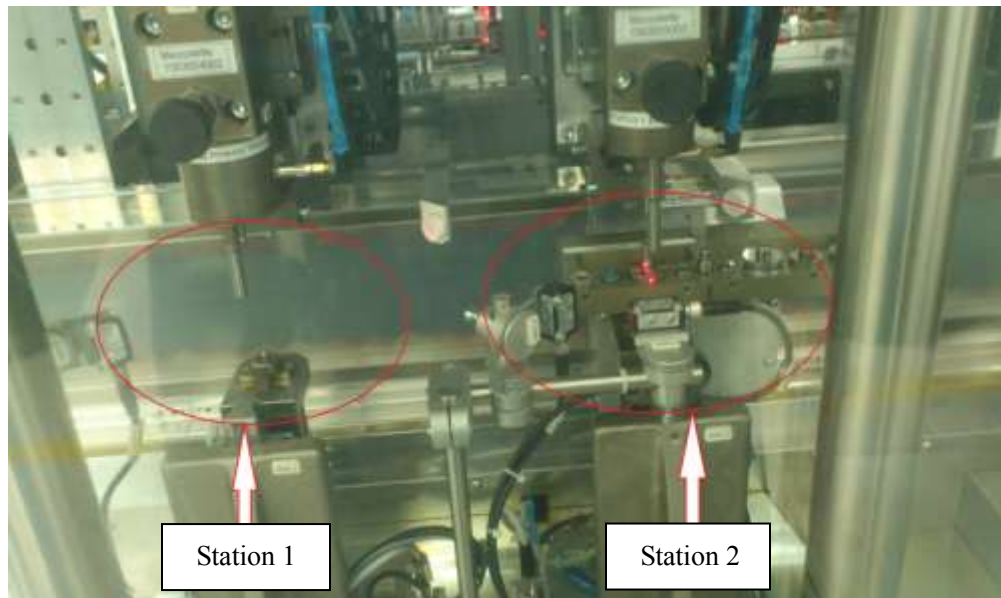

Figure 4. The line stations on the production line

2. Transport system control

Because the production line of the solenoid valve is in a dust-free, clean room and the pallet nest should be delivered fast with high accuracy, conventional motors cannot be used by the transmission system. Therefore, the production line uses magnetic levitation motor system[8]. The magnetic levitation bearing has no mechanical wear. It does not cause any related pollution and it is able to maintain high precision and high speed under the conditions of high load carrying capacities. In addition, the system doesn't need lubricants, and does not need to be sealed, so the system configuration can be further simplified.

As the production line station, the pallet nest must be accurately transmitted to each station which requires the magnetic levitation motor to move in a rapid speed with higher precision. The important aspect of the levitation motor system is the ability for the sensor to detect precise rotor position. In order to sense the movement position of the rotor, we must use a non-contact type displacement sensor. When choosing the rotor displacement sensor, it is necessary to consider the measurement range, linearity, sensitivity, resolution and frequency range. If the sensor is based on

electromagnetic principles, we also need to prevent other magnetic noise interference and the interaction between the sensors.

According to the actual situation at the scene, this production line uses the light displacement sensor [8-9]. The sensor uses the following principle: the measured object modulates the light between the light source and the light receiver; thus, by using the measured object as a mirror, the light reflects off the measured object and emits to the receiver. The receiver measures the optical signal that changes with the rotor position. A benefit of the optical sensor is it has no interference from magnetic fields, so it has a steady performance and a high degree of linearity of the signal. The transport system is shown in Figure 5.

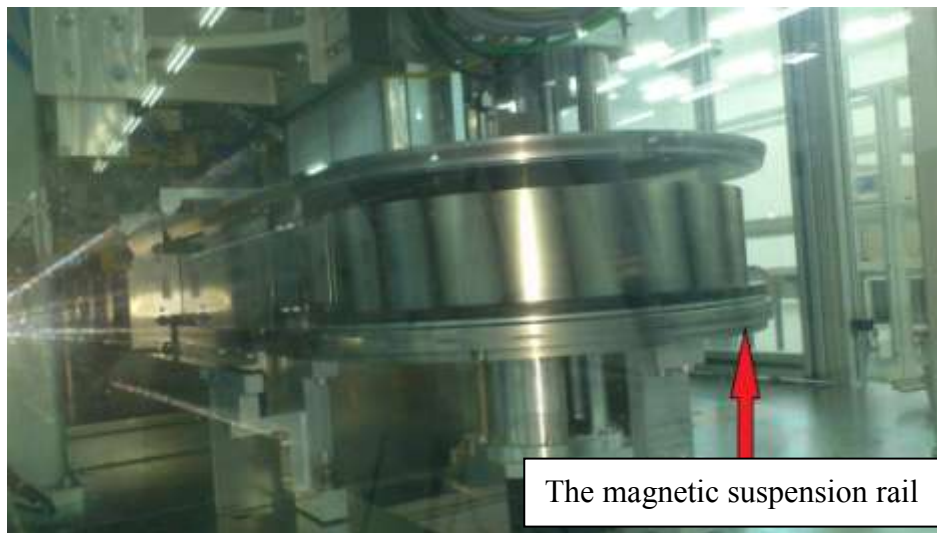

Figure 5. The magnetic levitation motor transport system

Overall, the use of magnetic levitation motor has the following benefits: minimum moving friction with fast, precise movement.

3. The image error detection system control

The purpose of using this system is to prevent the production loss from the misplacement of spare parts into the tray. This system uses the Cngnex Camera. Technical personnel first obtain the clear pictures of each type of solenoid valve sleeve by the camera. Then with the help of the image analysis tools, the picture taken in the production process contrasts with the standard picture, and the technical personnel judge whether the models to be produced are correct. If the comparison

INTERNATIONAL JOURNAL ON SMART SENSING AND INTELLIGENT SYSTEMS VOL. 6, NO. 5, DECEMBER 2013
model is correct, then they will notify the PLC to execute the next step instruction, or otherwise directly deliver the faulty model to the waste box and send an alarm.

4. Laser system control

The production line adopts the Rofin-Laser system, which is shown in Figure 6. It is mainly used in the welding and marking of the solenoid production. Lasers can weld in vacuums, air and certain gaseous environments. It can also weld through the glass or the transparent material. The equipment is easy to use, by focusing of the laser beam, we can obtain a small spot, and the spot can be accurately positioned. At the same time, the welding has to be rapidly executed at a great depth within the materials. Thus, the laser system is apt to fulfill the assembly requirements for the production line.



Figure 6. The laser welding apparatus

5. Helium leak detection system control

The functionality of the system is to detect a possible laser welding leak. The method detects a leak by using a helium mass spectrometer leak detector. The instrument uses the helium as an indicator for a leakage of gas. It has a stable performance, high sensitivity, and is the most commonly used leak detector. The helium leak detection device is shown in Figure 7.



Figure 7. The helium leak detection device

Finally, a portion of the production line is shown in Figure 8.



Figure 8. A portion of the production line

V. SOFTWARE DESIGN

The production line's software includes two parts: the PC monitoring interface software and the configuration programming of the lower machine. The configuration programming adopts Siemens programming software STEP7 V5.5 while with PC monitoring interface is utilizes the

Siemens WinCC flexible. PLC control is maintained through the acquisition of signals issued by the touch screen control panel, sensor detectors, output scene control, and the touch screen display.

Considering the system's security, reliability and readability of the program, the assembly process of the control program uses a sequence control [10]. We formulated the action timing of each actuator, making the actuator action go down step by step, thereby enabling the system to run in an orderly and reliable process. Figure 9 is a flow diagram of loading material. Figure 10 is the main flow diagram of the operation control in the time of assembly for each station. Figure 11 is a flow diagram of unloading product.

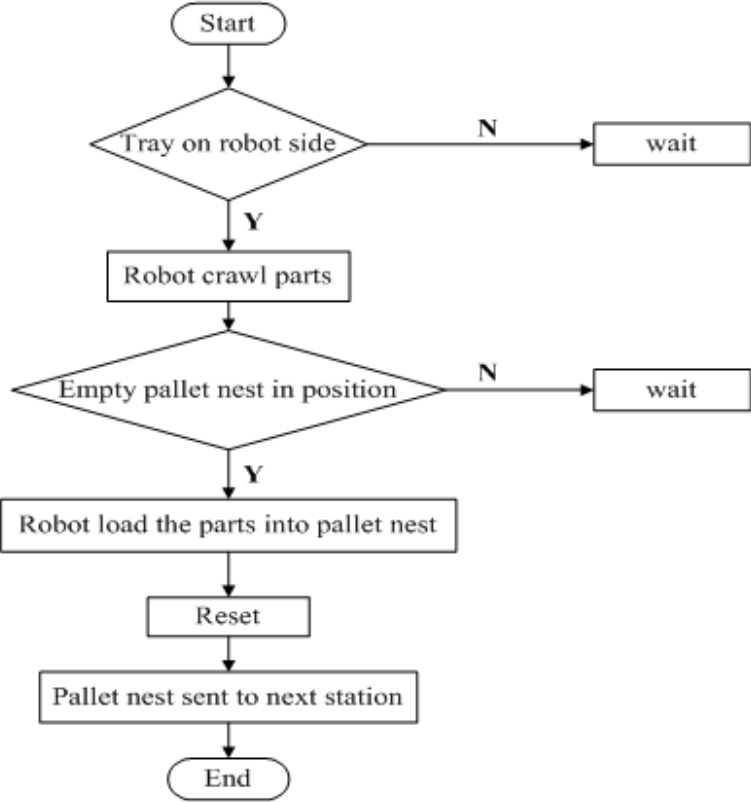

Figure 9. The flow diagram of load material

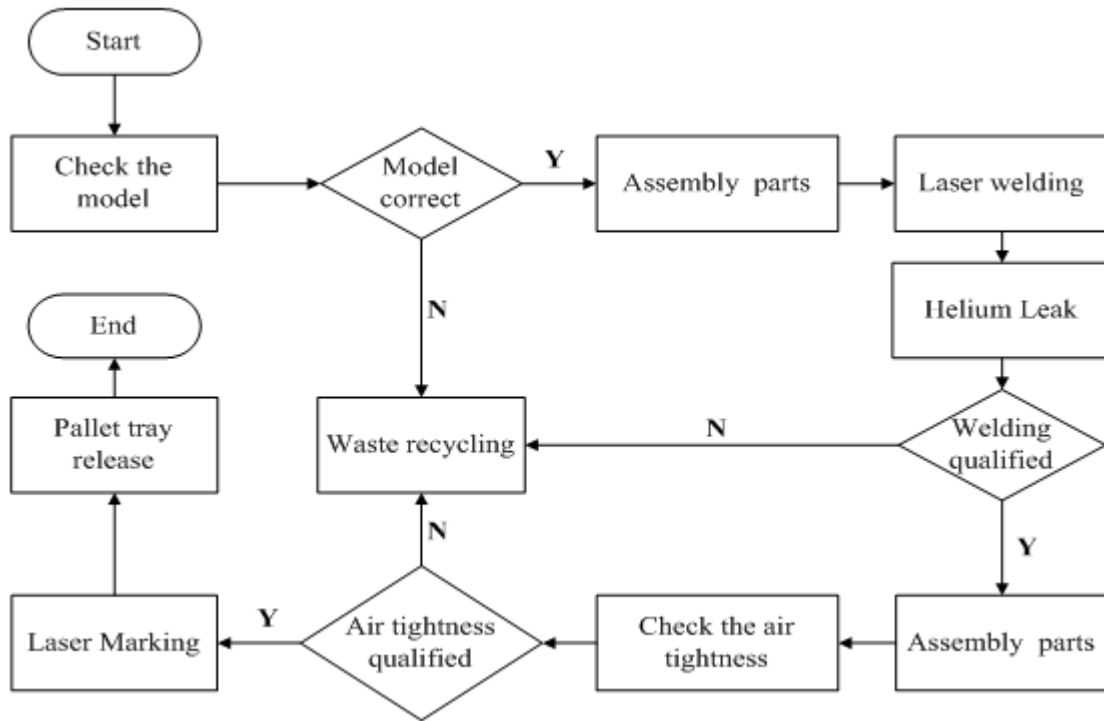

Figure 10. Main flow diagram of the operation control

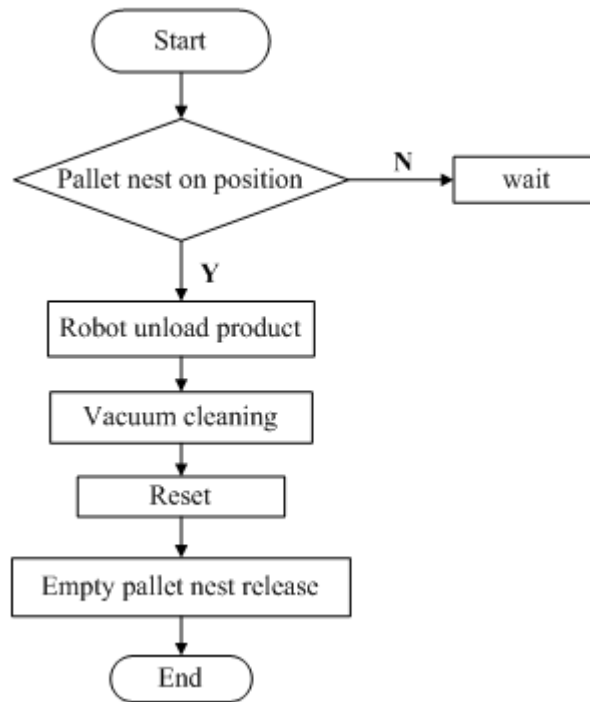

Figure 11. The flow diagram of unloading product

In addition, according to the control requirement of the production process, we had the man-machine interface design created and made relevant settings, then compiled. Lastly, we downloaded the software into the touch screen. The touch screen interface structure is shown in Figure 12. It contains a main menu and a fault alarm display interface. The main menu offers four buttons: automatic operation, manual operation, system settings and change type production. They can provide four operating states for the system. After clicking the button to enter the corresponding sub-menu, we can do the corresponding operation. When needed to change the solenoid type to produce, we simply clicked the change-type production button directly on the model selection interface. The interface is shown in Figure 13.

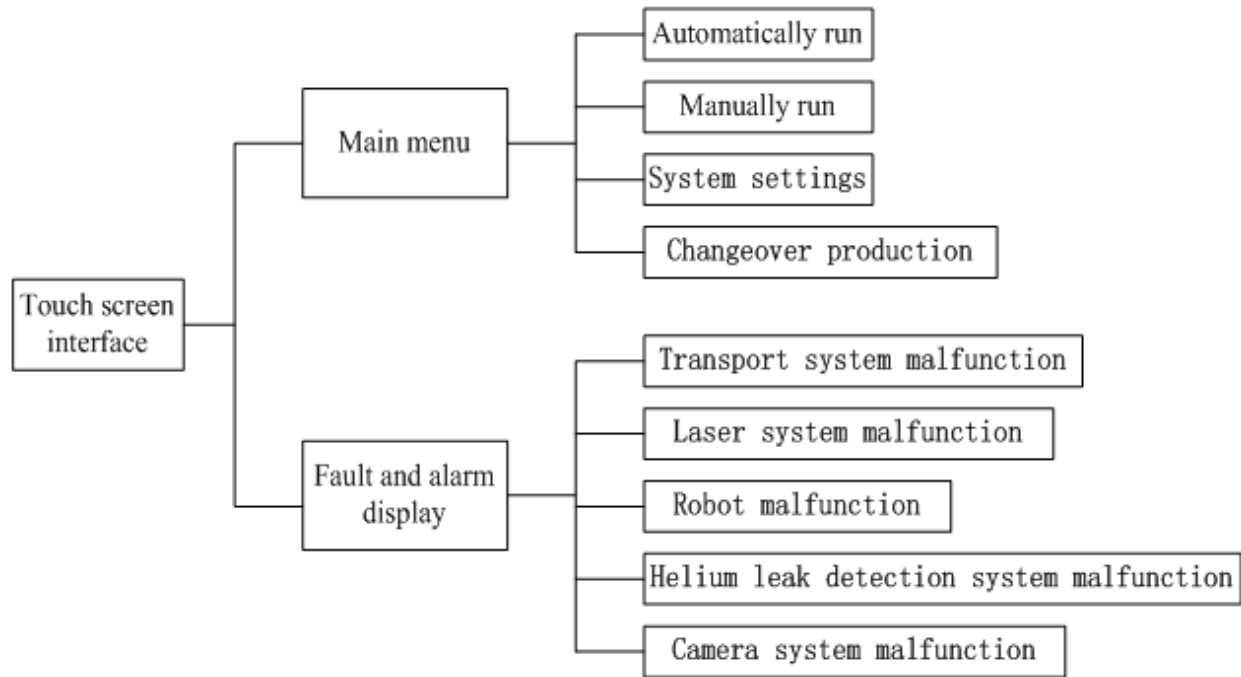

Figure 12. The touch screen interface structure

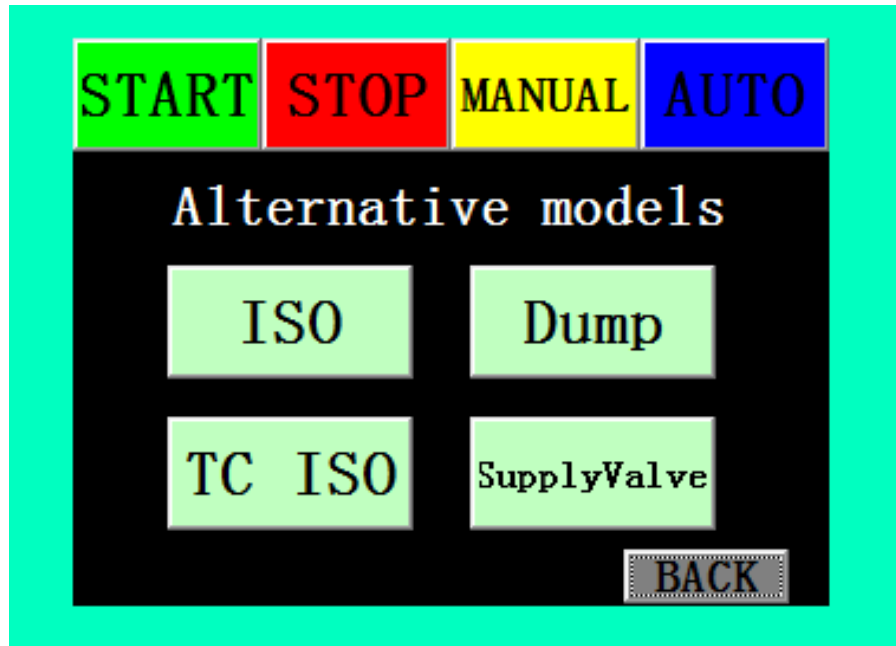

Figure 13. The model selection interface

The finished product is shown in Figure 14. Because the welding causes the length L of solenoid valve to be different from each other, accuracy of the value L reflects the quality level of the production line. According to user requirements, the value L is 38mm and the permissible limit is $\pm 0.03\text{mm}$. After producing an ample amount of the finished product, we randomly selected 10 samples of the solenoid valve, and used a digital micrometer to measure the length L of each sample. The micrometer used was from the Steinmeyer brand of Germany which has a division value of 0.001mm. Measure data shown in table 1.



Figure 14. The finished product

Table1. The measure data of 10 samples

Sample Number	VALUE L (mm)	Sample Number	VALUE L (mm)
1	38.015	6	37.994
2	38.018	7	38.021
3	38.009	8	38.015
4	37.998	9	37.989
5	38.013	10	38.011

The root-mean-square error of this sample data is 0.01029mm. This shows that the sample length deviation is relatively stable. We can also see every sample’s deviation between measured data and the actual requirements is less than 0.03mm, which meets production requirements.

VI. CONCLUSIONS

The production line adopts the Siemens S7-300 series PLC as the control core part, using the touch screen as an interactive interface. The whole system has good compatibility and compact

structure. It is easy to install, and the line running is stable in the actual production. As for the user-friendly human-machine interface operation, the labor intensity is greatly reduced for workers, so it has a high degree of automation. On the basis of ensuring the quality, it improves product efficiency, and brings great economic benefits to the production side.

VII. ACKNOWLEDGEMENTS

This work was supported by the scientific research development found project from Tianjin University of Technology and Education (KJ11-24).

REFERENCES

- [1] LI Xiao-dong, ZHOU Feng-xing, MA liang, LI Wei, "Based on single-chip automotive solenoid valve Detection System", *microcomputer information*, 2010(4), pp.165-166.
- [2] Li Qiang, "Importance and Operative Principles of Automobile's ABS System", *Tractor & Farm Transporter*, Jan. 2007, pp.10, 12.
- [3] Chongsheng Hou, "The Crosscut Production Line Control System Based on PROFIBUS-DP Bus", 2011 Second International Conference on Mechanic Automation and Control Engineering, 2011, pp.1740-1743.
- [4] Jungong Ma, Hongwei Jiang, Juan Chen, "Study of PLC communication technology based on profibus-DP", *Advanced Materials Research*, 2012, pp.433-440.
- [5] Kun Qiao, "Process Control of Stepping Billet Reheating Furnace Based on PLC and WinCC", *Automation applications*, 2012, (7):52-53, 56.
- [6] LIANG jin, "Study on fault diagnosis of the inductance-type proximity sensor", *Journal of Transducer Technology*, Vol.20, No.12, 2001, pp.13-14

- [7] Ph.A Passeraub, G Rey-Mennet , P.A Besse , H Lorenz , R.S Popovic, "Inductive proximity sensor with a flat coil and a new differential relaxation oscillator", *Sensors & Actuators: A. Physical*, 1997, Vol.60 (1), pp.122-126
- [8] Tang Shuangqing, Hu Huan, "The Current Application and Development Trend for Magnetic Suspension Bearing", *MACH INE TOOL and HYDRAUL ICS*, Vol.37, No.12, Dec.2009, pp.209-211
- [9] M. Yasin, H.A. Rahman , N. Bidin , S.W. Harun , H. Ahmad, "Fiber optic displacement sensor using fiber coupler probe and real objects", *Sensor Review*, 2012, Vol.32 (3), pp.212-216
- [10] Jiner Huang, "The automatic production line design based on PLC", *Coal Technology*, Vol.31, No.04, April, 2012, pp.74-75
- [11] Lu Jianfeng, Zhu Zhihao, "Design and application of a production control system for multi-products line", *Electric Information and Control Engineering (ICEICE)*, 2011 International Conference on, 2011, pp. 4864-4867.
- [12] Kun Zhou, Yanmin Song, Xintian Shen, Yurong Yan, Wen Wang, "An Application of Fuzzy Control Based on PLC in the Electrical Control System of Fancy Soap Production", *Fuzzy Systems and Knowledge Discovery*, 2008. FSKD '08. Fifth International Conference on, 2008, pp. 279-283.
- [13] Wang Yang, "Study on Electroplating Production Line Based on PLC", *Information Science and Engineering (ICISE)*, 2009 1st International Conference on, 2009, pp. 5426-5429.
- [14] Montague, j. "Microbrewery grows big with micro PLC", *Control*, April 2012, pp. 49-50, 52
- [15] M. F. Rahmat, N. H Sunar, Sy Najib Sy Salim, Mastura Shafinaz Zainal Abidin, A. A Mohd Fauzi and Z. H. Ismail, "Review on Modeling and Controller Design in Pneumatic Actuator Control System", *International Journal on Smart Sensing and Intelligent Systems* VOL. 4, NO. 4, DECEMBER 2011.
- [16] W.K. Lai, M.F. Rahmat and N. Abdul Wahab, "Modeling and Controller Design of Pneumatic Actuator System with Control Valve", *International Journal on Smart Sensing and Intelligent Systems* VOL. 5, NO.3, SEPTEMBER 2012.

- [17] Qianlai Sun, Zhiyi Sun, Xuwen Yan, Hong Li, "Development of Automatic Control System for a Rolling Shear line ", *Advanced Materials Research*, January, 2011, pp. 471-476.
- [18] Xia Lian, Ma Chao, Han Jiang, Bai Yong-shuai, Tian Xiao-qing, "Real-time control for flexible manufacturing systems based on PROFIBUS-DP", *Mechanical & Electrical Engineering Magazine*, July, 2010(7), pp.5-8.
- [19] Pan Hongxia, Guo Yanqing, "Automatic control of deep-hole chrome-plated system basing on WinCC", *2009 IEEE International Symposium on Industrial Electronics (ISIE 2009)*, January, 2009, pp.954-959.
- [20] Mohd Heidir Mohd Shah, Mohd Fua'ad Rahmat, Kumeresan A. Danapalasingam and Norhaliza Abdul Wahab , "PLC Based Adaptive Fuzzy PID Speed Control of DC Belt Conveyor System ",*International Journal on Smart Sensing and Intelligent Systems VOL. 6, NO.3, JUNE 2013*.
- [21] Guo Rui, "Automatic Control System of Steel Bar Production Line Based on PLC Programming", *E-Product E-Service and E-Entertainment (ICEEE)*, *2010 International Conference on*,2010, pp.1-5.
- [22] Liu Xi-mei, Guo Jing, Chu Yan-he, "Application of PLC and WinCC in Heating Control System", *Journal of Qingdao University of Science and Technology (Natural Science Edition)* , Aug.2011, pp. 415-419, 425.