



PERFECT TRACKING CONTROL WITH DISCRETE-TIME LQR FOR A NON-MINIMUM PHASE ELECTRO-HYDRAULIC ACTUATOR SYSTEM

¹R. Ghazali, ¹Y. M. Sam, ¹M. F. Rahmat, ¹Zulfatman, ²A. W. I. M. Hashim

¹Department of Control and Instrumentation, Faculty of Electrical Engineering,
Universiti Teknologi Malaysia, 81310 Skudai, Malaysia

²College of Science and Technology, International Campus,
Universiti Teknologi Malaysia, 51400 Kuala Lumpur, Malaysia

Emails: yahaya@fke.utm.my, rozaimi@ieee.org, fuaad@fke.utm.my

Submitted: June 16, 2011

Accepted: 15, 2011

Published: September 1, 2011

Abstract- This paper presents a perfect tracking control for discrete-time nonminimum phase of electro-hydraulic servo (EHS) system by adopting a combination of feedback and feedforward controller. A linear-quadratic-regulator (LQR) is firstly design as a feedback controller and a feedforward controller is then proposed to eliminate the phase error emerge by the LQR controller during the tracking control. The feedforward controller is develop by implementing the zero phase error tracking control (ZPETC) technique which the main difficulty arises from the non-minimum

phase system is have no stable inverse. Subsequently, the controller is applied to EHS system which is represented in discrete-time model where the model is obtained experimentally using system identification method. The proposed controller design using ZPETC is particularly suited to the various positioning control applications that encounter non-minimum phase problem. It is also shows that the controller offers good performance in reducing phase and gain error that typically occur in positioning or tracking systems.

Index terms: Nonminimum phase system, linear quadratic control, zero phase error tracking control, electro hydraulic actuator system, perfect tracking control

I. INTRODUCTION

In recent years, electro-hydraulic servo (EHS) system has attracted a great interest in industrial engineering as an actuator for high performance and precision positioning applications. With a compact size and design, EHS system capable to generate high forces in fast response time and produced great durability in particular for heavy engineering system [1]. By utilizing the advantageous of EHS system, different applications such as aircrafts [2], manufacturing machines [3-5], fatigue testing [6], hydraulic excavator [7], sheet metal forming process [8] and automotive applications [9-11] established that the actuator system can be more well-known and crucial nowadays. Therefore, a feedback tracking control is always required in designing the high performance tracking and positioning EHS system.

Various types of feedback controller ranging from linear to nonlinear type are widely implemented and published among academia and researchers for position tracking control of EHS system. The increasing numbers of works dealing with EHS system over the past decades involved a linear control, intelligent control and nonlinear control approaches such as neural network (NN) [12], self-tuning Fuzzy-PID [13-14], model reference adaptive control (MRAC) [15-16], generalized predictive control (GPC) [17] and sliding mode control [18]. Most of tracking control system is typically necessary in minimizing gain and phase error from the output to the desired trajectory. This requirement can be achieved by introducing a feedforward controller to cancel out the zeros and poles in the closed loop system. The main objective in that control scheme is to drive the actuator to follow perfectly the desired trajectory and minimizing

the phase lag that regularly caused by feedback loop in closed loop system.

Generally, a zero phase tracking error can be achieved mathematically by synthesized the inverse model of the closed loop feedback system in the feedforward design. Thus, a perfect tracking control strategy can be introduced to eliminate phase error and high performance tracking can be developed. An optimal feedback controller basically is needed to reduce the disturbance effect from the varying in plant parameters. Several works have been done over the past decades using the direct inverse of the plant model. As example, sliding mode control is proposed in the feedback design and the direct inverse of the closed-loop system model is taken the feedforward design by Wang et. al [19]. The robust perfect tracking control is implemented by Wang et. al [19] is particularly for minimum phase systems and has been applied experimentally to the drive motor. Direct inverse of the plant can be made since the zeros polynomial a stable. However, the feedforward controller is unable to design if the class of system with disturbance considered is a non-minimum phase which presents zeroes outside the unit circle. For nonminimum phase systems, the main difficulty arises from these systems which have no stable inverse. The zeros presented outside the unit circle will be unstable poles during the inversion process.

Direct inverse of the closed loop systems will cause unstable phenomenon in the output of the feedforward controller and this is adverse in designing the feed-forward control which caused an uncontrollable system. This is only associated for the minimum phase systems. It is established that in [20], the minimum phase continuous-time system may become nonminimum phase system for sufficiently fast sampling time. One of the most successful feedforward controller designs is the zero phase error tracking controller (ZPETC), which has wide application in advanced manufacturing equipment particularly for nonminimum phase discrete-time system. By implementing the ZPETC method, the unstable controller can be design appropriately by an approximation of the inverse plant and the transfer function from the reference input to the output is approximately unity. The ZPETC method that was first proposed by Tomizuka [21] had attracted many researchers as one of solution to nonminimum phase system in feedforward control strategy.

However, the gain error is unable to be eliminated by this method and also good tracking performance cannot be achieved if the feedback controller is not robust due to varying in parameters, uncertainties and disturbances. Another method is proposed in [22] without factorization of the nonminimum phase system. The performance of ZPETC controller is

significantly depends on the quality of the model. The output should closely follow the reference input, which results in very small tracking errors when the model is perfectly obtained. Otherwise, with inadequate plant model, the improvement in preciseness and accuracy with ZPETC controller may be reduced.

In this study, a perfect tracking control for a discrete-time nonminimum phase systems by adopting optimal control strategy which is linear-quadratic regulator (LQR) as a feedback controller. A combination feedback with feedforward controller is highlighted in the controller design where the tracking performance of the systems can be improved and the feedforward controller is introduced to eliminate the phase error that always emerges during the tracking control. The perfect tracking controller is then demonstrated to the EHS system which is represented in discrete-time model where the model is obtained experimentally using system identification method. With a small sampling time, a nonminimum phase third order model is obtained to represent the EHS system in the development of perfect tracking control strategy.

II. ELECTRO-HYDRAULIC ACTUATOR SYSTEM

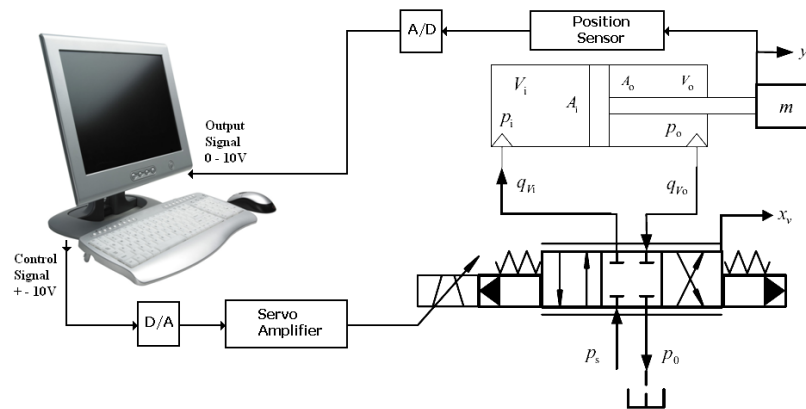

Figure 1. Electrohydraulic Servo System

A perfect tracking control with optimal control design is implemented to EHS system for position tracking control and a discrete-time model is needed in the designing the feedback and feedforward controller. To perform a position tracking control of EHS system, mathematical model of that system is needed. Basic idea of perfect tracking controller is to achieve the transfer function from the desired trajectory to the output of the systems to become unity. With that, the

feedforward controller can be obtained by the inverse of closed loop system transfer function and the phase error can be eliminated in the tracking control system. A modeling of EHS system is required in designing the proposed control strategy.

A complete mathematical model with internal leakage, actuator leakage and friction model have been discussed lately in [23] with intelligent control strategy. However, the physical models derived in that simulation study are highly complex and difficult to utilize in some of the control designs especially in industrial field. Most of the parameters involved in that mathematical model are usually not available in the manufacturer's datasheet and vastly vary with time due to its nonlinearity. Besides, the parameters are affected by the hydraulic oil temperature, supply pressure changes and aging. A mathematical model of an EHS system in figure 1 can be developed by neglecting these nonlinearities such as internal or external leakage and dynamics of the valve as explained in [12]. In servo valve design, the dynamics of the valve can be approximated as a single gain where the spool valve structure is assumed as critical-center and symmetrical. The equation relates the input signal (normally voltage) and the spool valve position is given by

$$x_v = K_v u \quad (1)$$

With that, the dynamics of the electro-hydraulic system are derived from a Taylor series linearization by the following equation:

$$Q_L = K_q u - K_C P_L \quad (2)$$

Defining the load pressure, P_L as the pressure across the actuator piston, its derivative is given by the total load flow through the actuator divided by the fluid capacitance as given by

$$\dot{P}_L = \frac{4\beta_e}{V_t} (Q_L - C_{tp} - A_p \dot{y}) \quad (3)$$

And the force of the actuator can be determined,

$$F_a = A_p P_L = M_t \ddot{y} \quad (4)$$

Substituting equations (2) and (3) into equation (4) and taking a Laplace transform that yields,

$$\frac{Y(s)}{U(s)} = \frac{K \omega_n^2}{s(s^2 + 2\xi \omega_n s + \omega_n^2)} \quad (5)$$

where,

$$K = \frac{K_q}{A_p}, \omega_n = A_p \sqrt{\frac{4\beta_e}{V_t M_t}} \text{ and } \xi = \frac{M_t (K_c + C_{tp})}{2A_p^2}$$

Open loop transfer function of the EHS system relates between the control signal from the computer/controller and position of the hydraulic actuator. The corresponding discrete-time model follows by transforming the continuous-time model in equation (5) with zero-order-hold is expressed as

$$G(z) = \frac{y(k)}{u(k)} = \frac{b_1 z^2 + b_2 z + b_3}{z^3 + a_1 z^2 + a_2 z + a_3} \quad (6)$$

Linearization of EHS system has been studied and employed over the past decades to encounter the nonlinearities subsists in the modeling process. There are numerous researchers who used that linear model in either continuous-time or discrete-time in their proposed control strategy. Most of the modeling approaches for discrete-time model that have been implemented in previous researches are developed from first principle or physical laws. Although the importance of physical modeling is always considered in the controller design, but in real implementation, validation of the physical plant model is necessary in optimizing the use of controller that commonly designs via computer simulation. Furthermore, any changes in the EHS system's parameter may reduce the controller performance and the desired specification possibly not achieved. Therefore, system identification with online estimation technique is always performed as an adaptive mechanism integrating with other control design. The discrete-time transfer function can be represented in state-space control canonic form.

$$x(k+1) = Ax(k) + Bu(k) \quad (7)$$

$$y(k) = Cx(k) \quad (8)$$

$$A = \begin{bmatrix} -a_1 & -a_2 & -a_3 \\ 1 & 0 & 0 \\ 0 & 1 & 0 \end{bmatrix} \quad (9)$$

$$B = [1 \ 0 \ 0]^T \quad (10)$$

$$C = [b_1 \ b_2 \ b_3] \quad (11)$$

From the state space model, the discrete-time transfer function can be derived as:

$$\frac{y(k)}{u(k)} = C(zI - A)^{-1}B = G(z) \quad (12)$$

Since the ZPETC design is based on cancellation of all of the poles and well-damped zeros of feedback loop systems, the plant dynamics must be known in advance. A discrete-time model is determined using system identification technique from real plant of EHS system. A third order system is instigated to be adequate to represent the EHS system and being used in the control analysis. The percentage of best fit for a third order model is 92.11% while the final prediction error is 0.003331. In Fig. 2, the zero-pole plot shows that the EHS system is nonminimum phase which having a single zero outside the unit circle. The discrete-time transfer function obtained from the identification is represented as

$$G(z) = \frac{y(k)}{u(k)} = \frac{0.1478z^2 + 0.1617z - 0.06549}{z^3 - 0.9139z^2 - 0.2599z + 0.1743} \quad (13)$$

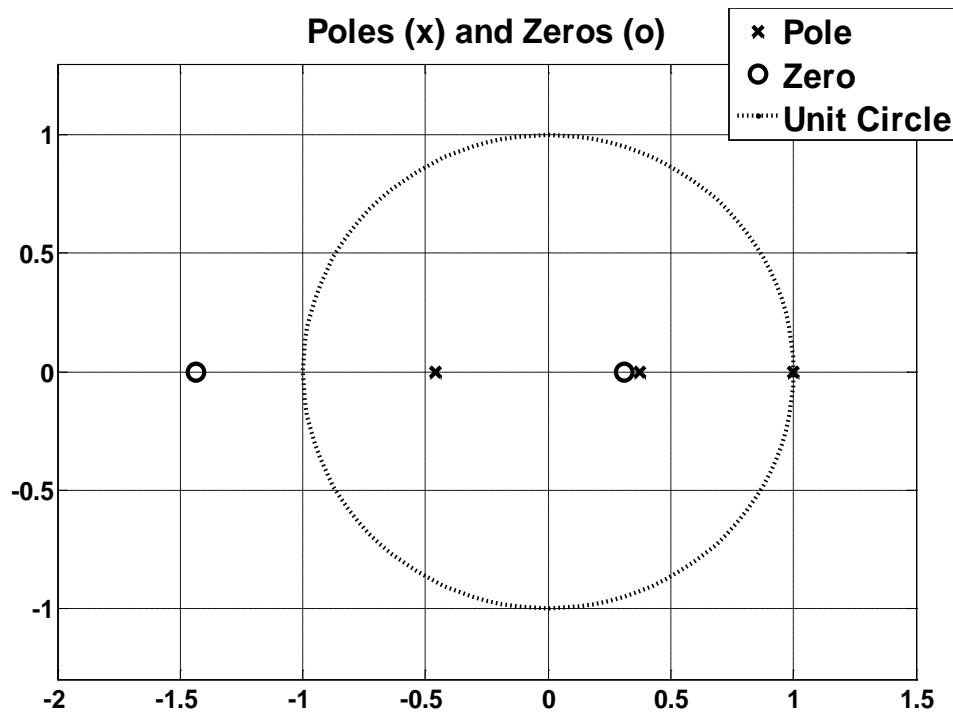

Figure 2. Pole-zero Plot for nonminimum EHS System

III. LINEAR QUADRATIC REGULATOR CONTROL

Linear-quadratic-regulator (LQR) is a part of optimal control strategy which has been widely developed and used in various applications. Optimal control is the standard method for solving dynamic optimization problems, when those problems are expressed in continuous time. In this approach, it is advantageous using an optimal control which is LQR to design the feedback control where the method is well-known of its robustness towards disturbances and uncertainties. By taking feedforward controller to be the inverse of the closed loop feedback system, the perfect tracking control can be achieved. For a discrete-time state-space model in (7), by minimizing the cost function in equation (14), the LQR gain can be determined.

$$J = \sum x' Qx + u' Ru + 2x' Nu \quad (14)$$

The matrix N is set to zero when omitted. Also returned are the solution that associated algebraic Riccati equation and the closed-loop Eigen values. The closed loop transfer function incorporating the LQR controller can derive as follows:

$$u(k) = -Kx(k) \quad (15)$$

$$x(k+1) = (A - BK)x(k) \quad (16)$$

$$A_{cl} = A - BK \quad (17)$$

$$x(k+1) = A_{cl}x(k) + Br(k) \quad (18)$$

$$\frac{y(k)}{r(k)} = C(zI - A_{cl})^{-1}B = G_{cl}(z) \quad (19)$$

Based on identified discrete-time model of EHS system in equation (13), the system matrix A and input matrix B is used to design the LQR. By letting,

$$Q = C^T * C \text{ and } R = 1$$

and minimizing the cost function in Eq. 8, the LQR gain is:

$$K = [0.2341 \quad 0.0194 \quad -0.0393] \quad (20)$$

Then, the closed-loop system matrix can be determined,

$$A_{cl} = \begin{bmatrix} 0.6798 & 0.2405 & -0.1350 \\ 1 & 0 & 0 \\ 0 & 1 & 0 \end{bmatrix} \quad (21)$$

Therefore, the closed-loop transfer function can be represented as;

$$G_{cl}(z) = \frac{y(k)}{r(k)} = C(zI - A_{cl})^{-1}B = \frac{0.1478z^2 + 0.1617z - 0.06549}{z^3 - 0.6798z^2 - 0.2405z + 0.1350} \quad (22)$$

The feed-forward control can be design by letting the inverse of closed loop transfer function with LQR controller as

$$G_{ff}(z) = [G_{cl}(z)]^{-1} \quad (23)$$

As can be seen from the closed-loop transfer function, the numerator which represents the zeroes in the system is dominated by the open-loop system and caused a nonminimum phase problem. The problem of inversion is occurred when the $G_{cl}(z)$ have any zeros outside the unit circle where the nonminimum phase of the open-loop EHS system will have influence to the closed loop systems. Direct inverse of the $G_{cl}(z)$ will cause unstable condition in $G_{ff}(z)$. So, Tomizuka [21] method will be used in developing the feedforward controller to avoid the instability.

IV. FEEDFORWARD CONTROLLER DESIGN FOR NONMINIMUM PHASE EHS SYSTEM

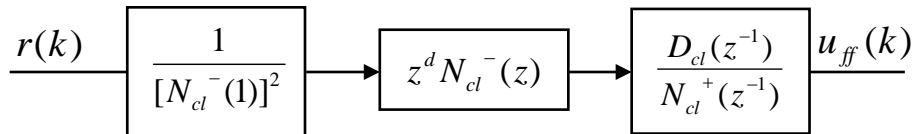

Figure 3. ZPETC block diagram

Since the direct inverse of the closed loop transfer function is unfeasible, the approximation of the feedforward controller can be implemented to represent the inverse of closed loop system and cancelled the poles and zeros. The direct inversion of closed loop system can be represented as:

$$G_{ff}(z) = [G_{cl}(z)]^{-1} = \frac{D_{cl}(z)}{N_{cl}(z)} = \frac{z^3 - 0.6798z^2 - 0.2405z + 0.1350}{0.1478z^2 + 0.1617z - 0.06549} \quad (24)$$

The block diagram as shown in figure 3 described the approximation of feed-forward control design for nonminimum phase systems using ZPETC strategy. The proposed method can be divided into three blocks which are gain compensation filter, phase compensation filter and stable inverse. From equation, one of the poles in the feedforward controller is outside in the unit circle which. In the feedforward design, equation in (9) can represent in delay form,

$$G_{ff}(z^{-1}) = \frac{D_{cl}(z^{-1})}{N_{cl}(z^{-1})} = \frac{1 - 0.6798z^{-1} - 0.2405z^{-2} + 0.1350z^{-3}}{0.1478z^{-1} + 0.1617z^{-2} - 0.06549z^{-3}} \quad (25)$$

The numerator of the closed-loop systems can be factorized in the feedforward controller,

$$G_{ff}(z^{-1}) = \frac{D_{cl}(z^{-1})}{N_{cl}^+(z^{-1})N_{cl}^-(z^{-1})} = \frac{1 - 0.6798z^{-1} - 0.2405z^{-2} + 0.1350z^{-3}}{0.1478z^{-1}(1 - 0.3146z^{-1})(1 + 1.4086z^{-1})} \quad (26)$$

where

$$N_{cl}^+(z^{-1}) = 0.1478z^{-1}(1 - 0.3146z^{-1})$$

$$N_{cl}^-(z^{-1}) = 1 + 1.4086z^{-1}$$

Based on the proposed method, stable inverse can be stated as following equation;

$$G_{ff1}(z^{-1}) = \frac{D_{cl}(z^{-1})}{N_{cl}^+(z^{-1})} = \frac{1 - 0.6798z^{-1} - 0.2405z^{-2} + 0.1350z^{-3}}{0.1478z^{-1}(1 - 0.3146z^{-1})} \quad (27)$$

In advance form, the phase compensation filter can be described as;

$$G_{ff2}(z) = z^d N_{cl}^-(z) = z(1 + 1.4086z) \quad (28)$$

where $d=1$.

And the gain compensation filter is:

$$G_{ff3} = \frac{1}{[N_{cl}^-(1)]^2} = \frac{1}{[1 + 1.4086(1)]^2} = 0.1724 \quad (29)$$

V. RESULTS AND DISCUSSION

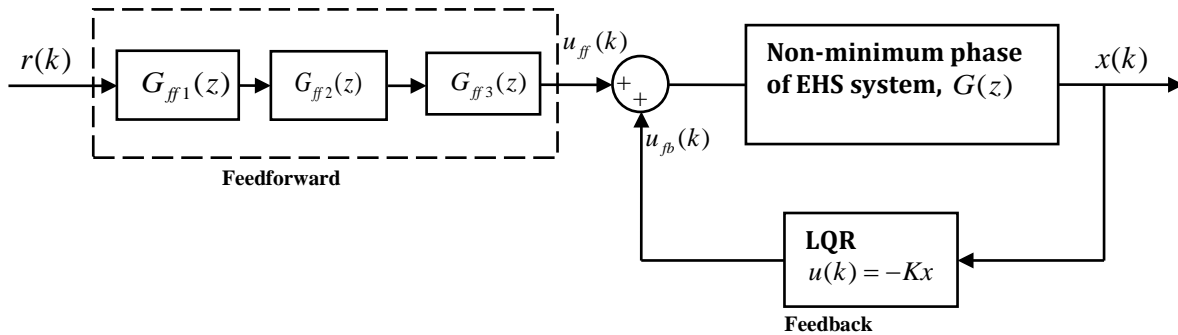

Figure 4. Proposed Controller Design

For the overall controller design as shown in figure 4, the feedforward is represented by ZPETC where its function is approximation of the inverse closed loop system with LQR controller.

Output from the nonminimum phase of EHS system is fed into the LQR controller. The LQR controller operated as a feedback control which permits the system's output to follow the desired trajectory. The proposed ZPETC based on inverse closed-loop system is introduced to reduce the phase lag due to feedback control problem.

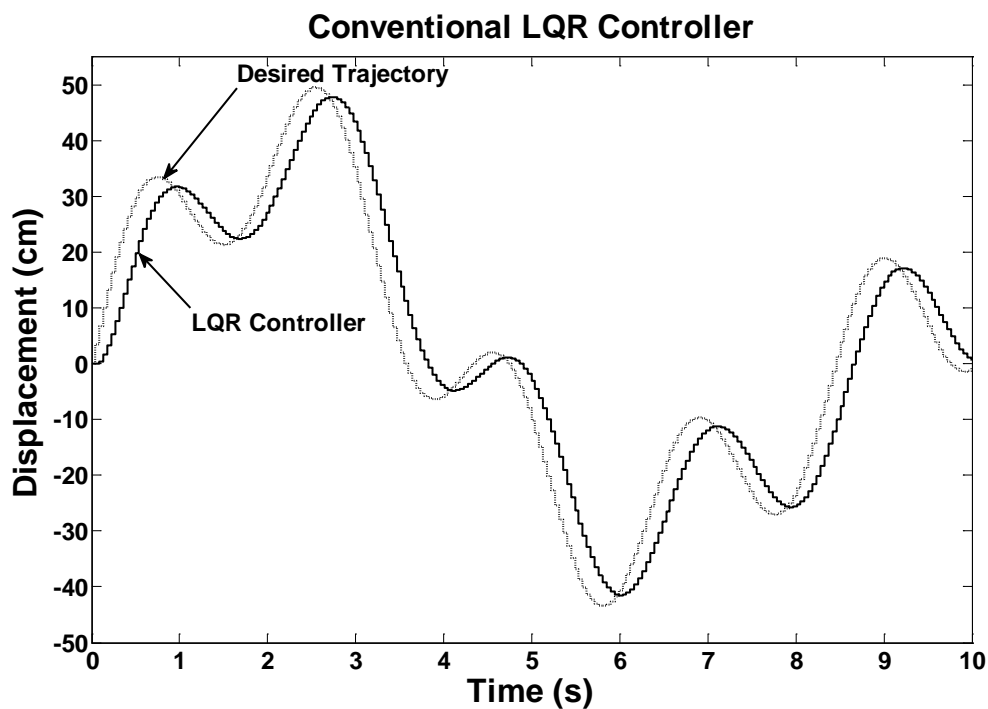

Figure 5. Position tracking using conventional LQR

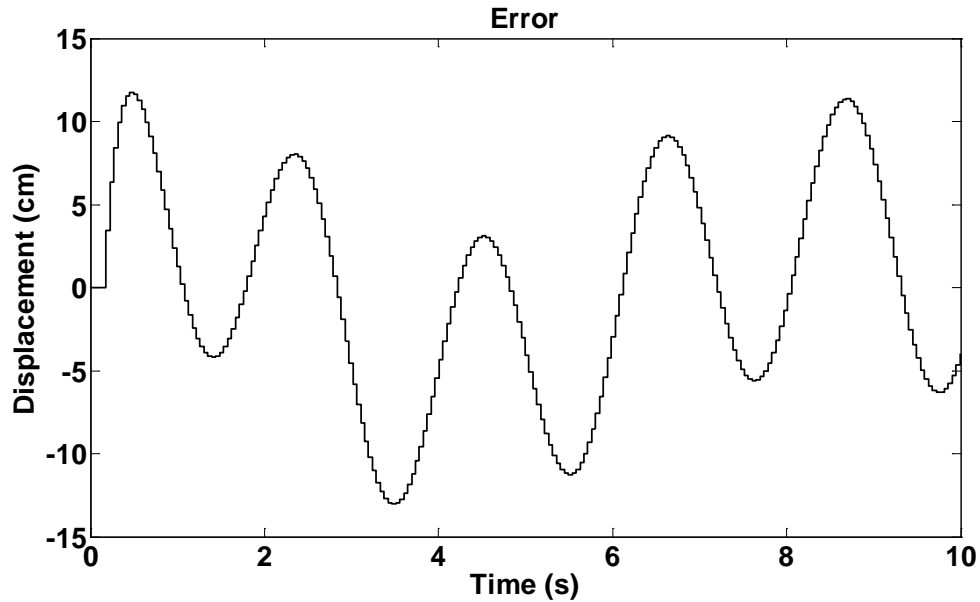

Figure 6. Position error using conventional LQR

Figure 5 shows that the performance of tracking control using conventional LQR controller. It shows that the phase lag problem occur during the tracking control. The tracking error shows significant different between the desired trajectory and the actual output in Fig. 6. By introducing the ZPETC controller, the phase lag can be reduced in the tracking control process. The tracking results using LQR with ZPETC is shown in figure 7. The error also is reduced significantly compared with conventional feedback control in figure 8.

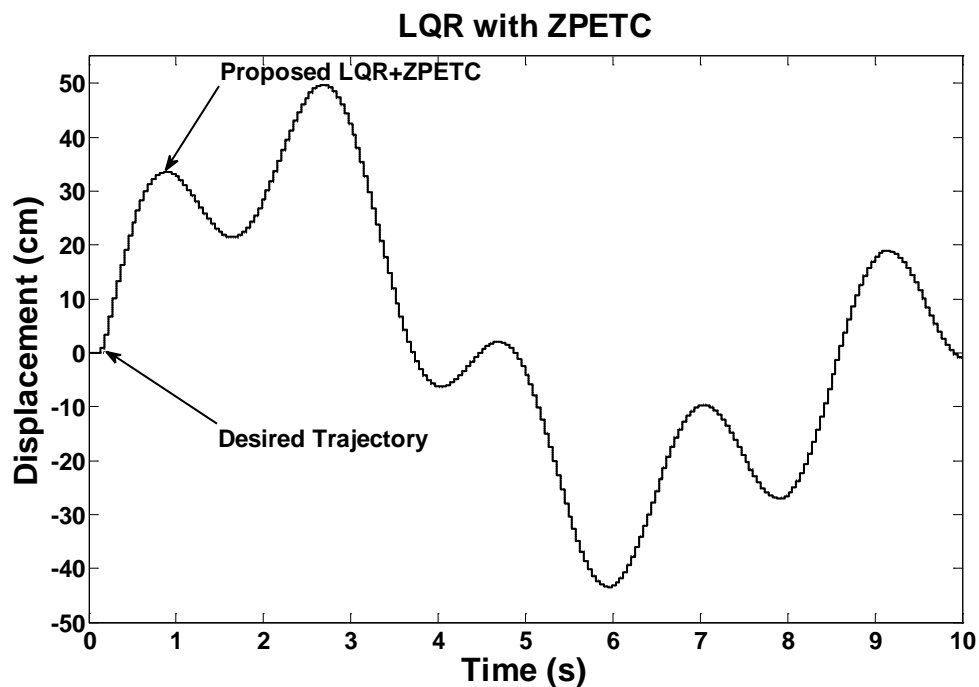

Figure 7. Position tracking using LQR with ZPETC

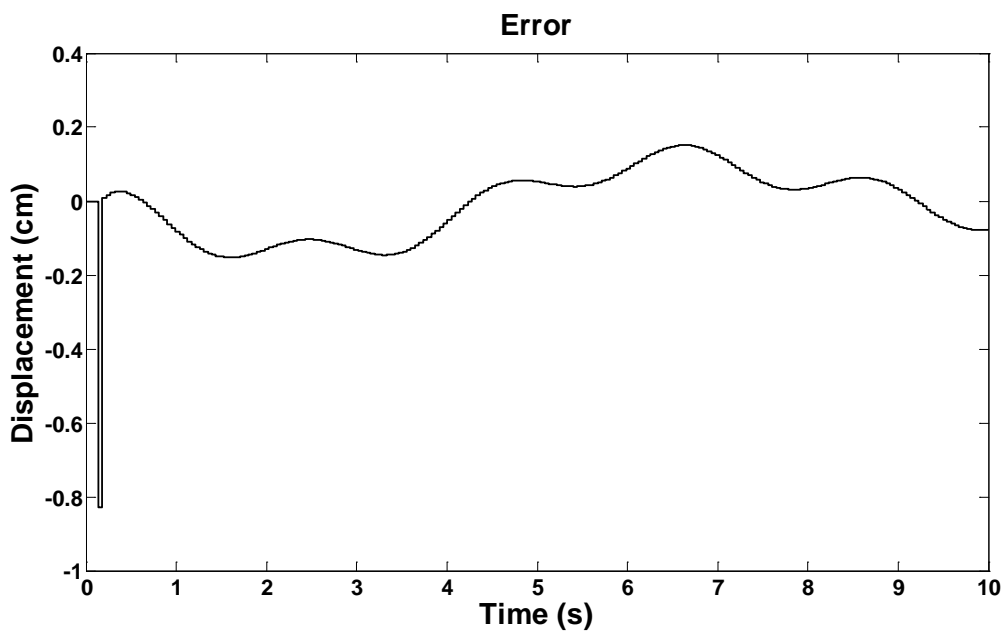

Figure 8. Position error using LQR with ZPETC

VI. CONCLUSIONS

In this study, the feedforward controller is developed based on ZPETC technique to reduce the phase lag emerge by feedback controller during the tracking control. An approximation of the inverse closed loop system in the feedforward controller design is adopted due to non-minimum phase problem in the EHS system model. It is shows that the controller offers good performance in reducing phase and gain error that usually occur in positioning or tracking systems. As conclusion, the proposed controller design using ZPETC is particularly suited to the various positioning control applications that encounter non-minimum phase problem to achieve perfect tracking control.

REFERENCES

- [1] H.E. Merrit, "Hydraulic Control Systems", John Wiley & Sons, Inc., New York, 1967.
- [2] M. Karpenko and N. Sepehri, "Hardware-in-the-loop simulator for research on fault tolerant control of electrohydraulic actuators in a flight control application", *Mechatronics*, Vol. 19, 2009, pp.1067-1077.
- [3] J. Renn and C. Tsai, "Development of an unconventional electro-hydraulic proportional valve with fuzzy-logic controller for hydraulic presses", *International Journal of Advanced Manufacturing Technology*, Vol. 26, 2005, pp.10-16.
- [4] M. H. Chiang, F. L. Yang, Y. N. Chen and Y. P. Yeh, "Integrated control of clamping force and energy-saving in hydraulic injection moulding machines using decoupling fuzzy sliding-mode control", *International Journal of Advanced Manufacturing Technology*, Vol. 27, 2005, pp.53-62.
- [5] S. Jha and V. K. Jain, "Design and development of the magnetorheological abrasive flow finishing (MRAFF) process", *International Journal of Machine Tools & Manufacture*, Vol. 44, 2004, pp.1019-1029.
- [6] J. Ruan, X. Pei and F. M. Zhu, "Identification and modeling of electrohydraulic force control of the material test system (MTS)", *Journal of Physics, Conference Series*, Vol. 48, 2006, pp.1322-1326.

- [7] M. H. Chiang and C. C. Huang, "Experimental implementation of complex path tracking control for large robotic hydraulic excavators", *International Journal of Advanced Manufacturing Technology*, Vol. 23, 2004, pp.126-132.
- [8] S. W. Lo and T. C. Yang, "Closed-loop control of the blank holding force in sheet metal forming with a new embedded-type displacement sensor", *International Journal of Advanced Manufacturing Technology*, Vol. 24, 2004, pp.553-559.
- [9] M. C. Wu and M. C. Shih, "Simulated and experimental study of hydraulic anti-lock braking system using sliding-mode PWM control", *Mechatronics*, Vol. 13, 2003, pp.331-351.
- [10] Y. M. Sam, J. H. S. Osman and M. R. A. Ghani, "A class of proportional-integral sliding mode control with application to active suspension system", *System and Control Letters*, Vol. 51, 2004, pp.217-223.
- [11] A. R. Plummer, "Model-in-the-loop testing", *Journal of System and Control Engineering*, Vol. 220, 2006, pp.183-199.
- [12] T. Knohl and H. Unbehauen, "Adaptive position control of electrohydraulic servo systems using ANN", *Mechatronics*, Vol. 10, 2000, pp.127-143.
- [13] Zulfatman and M. F. Rahmat, "Application of self-tuning Fuzzy PID controller on industrial hydraulic actuator using system identification approach", *International Journal on Smart Sensing and Intelligent Systems*, Vol. 2, No. 2, 2009, pp.246-261.
- [14] S. Cetin and A. V. Akkaya, "Simulation and hybrid fuzzy-PID control for positioning of a hydraulic system", *Nonlinear Dynamics*, Vol.61, No. 3, 2010, pp.465-476.
- [15] K. Ziaei and N. Sepehri, "Design of a nonlinear adaptive controller for an electrohydraulic actuator", *Journal of Dynamic Systems, Measurement and Control*, Vol. 123, 2001, pp.449-456.
- [16] A. Kirecci, M. Topalbekiroglu and I. Eker, "Experimental evaluation of a model reference adaptive control for a hydraulic robot: a case study", *Robotica*, Vol. 21, 2003, pp.71-78.
- [17] N. Sepehri and G. Wu, "Experimental evaluation of generalized predictive control applied to a hydraulic actuator", *Robotica*, Vol. 16, 1998, pp.463-474.
- [18] R. Ghazali, Y. M. Sam, M. F. Rahmat, A. W. I. M. Hashim and Zulfatman, "Sliding Mode Control with PID Sliding Surface of an Electro-hydraulic Servo System for Position Tracking Control", *Australian Journal of Basic and Applied Sciences*, Vol. 4, No. 10, 2010, 4749-4759.

- [19] J. Wang, H. V. Brussel and J. Swevers, “Robust perfect tracking control with discrete sliding mode controller”, *Journal of Dynamic Systems, Measurement and Control*, Vol. 125, No. 1, 2003, pp.27-32.
- [20] K. J. Astrom, B. Wittenmark, “Computer-controlled system: Theory and Design”, Prentice Hall, Englewood Cliffs, N.J, 1997.
- [21] M. Tomizuka, “Zero phase error tracking algorithm for digital controller”, *Journal of Dynamic Systems, Measurement and Control*, Vol. 109, No. 1, 1987, pp.65-68.
- [22] M. Mustafa, “Trajectory-adaptive digital tracking controllers for non-minimum phase systems without factorization of zeros”, *IEE Proc. Control Theory Applications*, Vol. 149, No. 2, 2002, pp.157-162.
- [23] M. Kalyoncu and M. Haydim, “Mathematical modelling and fuzzy logic based position control of an electrohydraulic servosystem with internal leakage”, *Mechatronics*, Vol. 19, 2009, pp.847-858.