

Markus Millinger

---

Systems assessment of biofuels –  
Modelling of future cost and greenhouse  
gas abatement competitiveness between  
biofuels for transport on the case of  
Germany



# Systems assessment of biofuels

Modelling of future cost and greenhouse gas abatement competitiveness between  
biofuels for transport on the case of Germany

Von der Wirtschaftswissenschaftlichen Fakultät  
der Universität Leipzig  
genehmigte

DISSERTATION

zur Erlangung des akademischen Grades  
Doktor-Ingenieur  
Dr.-Ing.

vorgelegt von  
Civ.-Ing. MSc. MARKUS MILLINGER  
geboren am 27. August 1984 in Stockholm, Schweden

Gutachter  
Prof. Dr.-Ing. Daniela Thrän  
Prof. Dr. rer.-nat. Thomas Bruckner

Tag der Verleihung 12. Dezember 2018

## **Bibliographic description**

Millinger, Markus

Systems assessment of biofuels: Modelling of future cost and greenhouse gas abatement competitiveness between biofuels for transport on the case of Germany

The University of Leipzig, Dissertation  
XVII+92 P., 247 Lit., 28 Fig., 14 Tab.

Abstract: Biofuels are a renewable alternative for reducing the climate impact of transport. Due to the versatility of biomass and complexity of economics and impacts, biofuels are part of a complex system, which is here analysed from a systems perspective. Several models are developed in order to assess the competitiveness of various crop based biofuel options as part of a system, using different economic and environmental functional units. The scope is set to Germany until 2050.

The capital and feedstock costs were revised to higher levels compared to common assumptions. The different functional units result in different merit orders for the biofuel options. Currently used biofuels, rape seed based biodiesel and starch crop based bioethanol, were found not to be competitive when considering differentiated and increasing feedstock costs. Advanced liquid fuels were only competitive at extreme assumptions, contrary to common expectations. Instead, sugar beet based ethanol dominated for most of the time span when comparing energetic cost, whereas Synthetic Natural Gas (SNG) was competitive on a greenhouse gas abatement (GHG) cost basis, especially at a rapid decarbonisation of the power mix. With a land use GHG abatement functional unit, silage maize based biomethane was the best, with SNG converging only at very high renewables shares of the background systems.

Switching from current practise to higher yielding biofuel options can treble the abatement per land area for the present day, and potentially increase it by a factor five in the future. A focus on GHG abatement per area of arable land results in the land passenger transport sector to be of the highest priority due to the suitability of higher yielding biofuel options, followed by land goods transport, shipping and finally aviation. If gaseous fuels are not possible to introduce on a large scale, sectors where liquefied gaseous fuels are suitable become the priority, i.e. goods transport and shipping. The current practise of applying admixture quotas to sub-sectors of land transport renders a significantly lower climate benefit compared to an overall optimal usage, and a large societal transition is required before aviation biofuels become the climate optimal biomass usage.

The direct importance of land use has thus far not received enough attention in terms of the economics of biofuels from dedicated crops, as well as for the greenhouse gas emissions policy. Biofuels produced from arable land can provide a strong GHG benefit if an expansion of arable land is hindered through redirecting land use, which requires a holistic policy approach.

---

## Selbständigkeitserklärung

Hiermit erkläre ich, die vorliegende Dissertation selbständig und ohne unzulässige fremde Hilfe, insbesondere ohne die Hilfe eines Promotionsberaters, angefertigt zu haben. Ich habe keine anderen als die angeführten Quellen und Hilfsmittel benutzt und sämtliche Textstellen, die wörtlich oder sinngemäß aus veröffentlichten oder unveröffentlichten Schriften entnommen wurden, und alle Angaben, die auf mündlichen Auskünften beruhen, als solche kenntlich gemacht. Ebenfalls sind alle von anderen Personen bereitgestellten Materialien oder erbrachten Dienstleistungen als solche gekennzeichnet.

Hiermit erkläre ich, dass die vorgelegte Dissertation weder im Inland noch im Ausland in gleicher oder in ähnlicher Form einer anderen Prüfungsbehörde zum Zwecke einer Promotion oder eines anderen Prüfungsverfahrens vorgelegt und insgesamt noch nicht veröffentlicht wurde.

Hiermit erkläre ich, dass ich die Promotionsordnung der Wirtschaftswissenschaftlichen Fakultät der Universität Leipzig, vom 12. Oktober 2010 anerkenne.

Leipzig, den 19 Dezember 2017

Markus Millinger



*till Bianca, Elsi och Wilma*





*Zur Einsicht in den geringsten Teil  
ist die Übersicht über das Ganze nötig*

J.W. GOETHE

*Allting är mycket osäkert,  
och det är just det som lugnar mig  
All things are so very uncertain,  
and that's exactly what makes me feel reassured*

TOO-TICKI  
Trollvinter by Tove Jansson

*Where we're going,  
we don't need roads*

Dr. EMMETT BROWN  
Back to the Future



# Abstract

Biofuels are a renewable alternative for reducing the climate impact of transport. Due to the versatility of biomass and complexity of economics and impacts, biofuels are part of a complex system, which is here analysed from a systems perspective. Several models are developed in order to assess the competitiveness of various crop based biofuel options as part of a system, using different economic and environmental functional units. The scope is set to Germany until 2050.

The capital and feedstock costs were revised to higher levels compared to common assumptions. The different functional units result in different merit orders for the biofuel options. Currently used biofuels, rape seed based biodiesel and starch crop based bioethanol, were found not to be competitive when considering differentiated and increasing feedstock costs. Advanced liquid fuels were only competitive at extreme assumptions, contrary to common expectations. Instead, sugar beet based ethanol dominated for most of the time span when comparing energetic cost, whereas Synthetic Natural Gas (SNG) was competitive on a greenhouse gas abatement (GHG) cost basis, especially at a rapid decarbonisation of the power mix. With a land use GHG abatement functional unit, silage maize based biomethane was the best, with SNG converging only at very high renewables shares of the background systems.

Switching from current practise to higher yielding biofuel options can treble the abatement per land area for the present day, and potentially increase it by a factor five in the future. A focus on GHG abatement per area of arable land results in the land passenger transport sector to be of the highest priority due to the suitability of higher yielding biofuel options, followed by land goods transport, shipping and finally aviation. If gaseous fuels are not possible to introduce on a large scale, sectors where liquefied gaseous fuels are suitable become the priority, i.e. goods transport and shipping. The current practise of applying admixture quotas to sub-sectors of land transport renders a significantly lower climate benefit compared to an overall optimal usage, and a large societal transition is required before aviation biofuels become the climate optimal biomass usage.

The direct importance of land use has thus far not received enough attention in terms of the economics of biofuels from dedicated crops, as well as for the greenhouse gas emissions policy. Biofuels produced from arable land can provide a strong GHG benefit if an expansion of arable land is hindered through redirecting land use, which requires a holistic policy approach.

**Keywords:** biofuels; greenhouse gas; economics; competition; land use; advanced; conventional; systems perspective .



# Acknowledgements

This thesis would not have been possible without the help of many people. First of all, thank you to all scientists on DBFZ who have been part of providing and critically discussing data for the biofuel options.

A special thank you to Oliver Arendt, who inspired another level of science, through experience, critical thinking and discussions about the model in development and how to go about it in a scientific and constructive manner. Thank you also to Jens Ponitka, who with his experience and general attitude kept a calm in the project, as well as having a very critical eye for inconsistencies and mistakes which helped me forward. Martin Zeymer helped with the cost calculations in a crucial stage, as well as providing important data of very high quality, without which this work as well as other work at DBFZ would suffer.

A special thank you also to Kathleen Meisel, without whom the work on greenhouse gas abatement would still be in its infancy, for always setting precious time aside between all the projects you are juggling. Your expertise on the policy and legal side of biofuels helped put the work into context, and it is a great pleasure working with you on projects. Maik Budzinski, thank you for your insightful reflection, comments and discussion on the paper.

Philip Tafarte, thank you for ever interesting discussions on anything from samba in Rio to Kaurismäki movies, as well as always insightful reflections on renewable energy - I really enjoy doing project work together with you. Marcus Eichhorn, thank you for being who you are, and always being there for us in the working group.

Daniela Thrän, thank you for the opportunity to do this and for your patience with the long process of developing the model, which now has spawned into several strands. Thank you also for allowing me to develop my own ideas and for teaching me to walk the tough and narrow ridge between science and politics, as well as for handing me responsibilities which made and still make me push my envelope.

Thank you to Erik Ahlgren at Chalmers, who before this adventure started put me up to speed on science and scientific writing.

Thank you also, to everybody past and present in the department, especially and in no particular order Julian Braun, Alberto Bezama, André Brosowski, Katja Oehmichen, Stefan Majer, Christiane Hennig, Sínead O’Keeffe, Diana Pfeiffer, Angela Gröber, Kathrin Greve, Caroline Lichtmann, Claudia Klötzing, Katrin Pätz, Matthias Jordan, Frazer Musonda, Raik Becker, Urs Moesenfechtel, Sebastian Rauner, Nora Szarka, Walther Zeug, Viktoria Haider, Kristian Möller, Thorsten Gunkel, Eric Billig, Sebastian Bohnet, Christian Klassert, Alexandra Purkus, Christian Dietrich, Steffen Schock, Felix Witing, Anke Siebert, Jakob

---

Hildebrandt, Linda Bausch, Martin Dotzauer and Mattes Scheftelowitz.

Thank you also Alexander Haverkamp, Jörg Kretschmar, Andreas Ortwein, Arne Gröngröft, Konstantin Zech, Nils Rettenmaier, Sven Gärtner, Rüdiger Schaldach, Matthias Koschorrek, Volker Grimm, Malte Engel, Volker Schwarze, Diego Peñaloza and Thomas Bruckner who have all supported the work with this thesis in one way or another. I am sure I have forgotten many who deserve a thank you - sorry.

Danke Vanni für deine große Hilfe. Danke alle leipziger Freunde für so viel Spaß, Wander- und Kletterausflüge und Fußball. Tack Dôle, Dan-Eric, Oskar, Jonas P., Diego, Yaseen och Richard för att ni alltid finns där. Kiitos Virpi ja Olaf neuvoista ja Sinikka tuesta. Ein riesen Dank an Alex und Klaus, dafür dass ihr immer da und so tolle Großeltern seid. Danke Matscher, weil du immer eine extra Schaltung findest.

Tack pappa för att du så gärna läser Plupp och Alfons, för att du tänker i system och alltid tänker framåt. Kiitos äiti siitä, että opetit minua kirjoittamaan, kiroilemaan ja nauramaan. Tack Jonas och Edvin för att ni är världens bästa bröder.

Elsi och Wilma, ni är det finaste som finns. Bianca - ohne dich wäre das alles nicht möglich. Danke.

Markus Millinger

Leipzig, December 2017

# List of Publications

This thesis is based on the following appended papers:

- I** Millinger, M., Ponitka, J., Arendt, O. and Thrän, D. (2017) *Competitiveness of advanced and conventional biofuels: Results from least-cost modelling of biofuel competition in Germany*. Energy Policy. 107, 394-402.
- II** Millinger, M. and Thrän, D. (2016) *Biomass price developments inhibit biofuel investments and research in Germany: The crucial future role of high yields*. Journal of Cleaner Production. In Press.
- III** Millinger, M., Meisel, K., Budzinski, M. and Thrän, D. (submitted) *Relative greenhouse gas abatement cost competitiveness of biofuels in Germany*.
- IV** Millinger, M., Meisel, K. and Thrän, D. (submitted) *Climate optimal deployment of biofuels from crops in Germany*.

Work related to this thesis has also been presented in the following publications:

- Thrän, D., Schaldach, R., **Millinger, M.**, Wolf, V., Arendt, O., Ponitka, J., Gärtner, S., Rettenmaier, N., Hennenberg, K., Schüngel, J. (2016). *The MILESTONES modeling framework: An integrated analysis of national bioenergy strategies and their global environmental impacts*. Environ. Modell. Softw. 86, 14 - 29.
- Thrän, D., Arendt, O., Banse, M., Braun, J., Fritsche, U., Gärtner, S., Hennenberg, K. J., Hünneke, K., **Millinger, M.**, Ponitka, J., Rettenmaier, N., Schaldach, R., Schüngel, J., Wern, B., Wolf, V. (2017). *Strategy elements for a sustainable bioenergy policy based on scenarios and systems modeling demonstrated on the example of Germany*. Chem. Eng. Technol. 40 (2), 211-226.
- Thrän, D., Arendt, O., Ponitka, J., Braun, J., **Millinger, M.**, Wolf, V., Banse, M. Schaldach, R., Schüngel, J., Gärtner, S., Rettenmaier, N., Hünneke, K., Hennenberg, K., Wern, B., Baur, F., Fritsche, U., Gress, H.-W. (2015). *Meilensteine 2030 – Elemente und Meilensteine für die Entwicklung einer tragfähigen und nachhaltigen Bioenergiestrategie*. In: Thrän, D.; Pfeiffer, D. (Hrsg.): Schriftenreihe des BMWi-Förderprogramms „Energetische Biomassenutzung“, Band 18. Leipzig 2015. – ISSN: 2199-2762.
- Millinger, M.**, Ponitka, J., Arendt, O., Thrän, D. (2015). *On future competitiveness of advanced and conventional biofuels: Results from least-cost modelling of biofuel competition in Germany*. Bioenergy 2015 international bioenergy exhibition and conference proceedings p.120, Jyväskylä, Finland.







---

# List of Acronyms

BENSIM	–	BioENergy Simulation Model
BTL	–	Biomass-To-Liquid
CCS	–	Carbon Capture and Storage
CH <sub>4</sub>	–	Methane
CHP	–	Combined Heat and Power
CO <sub>2</sub>	–	Carbon dioxide
CO <sub>2</sub> <i>eq</i>	–	Carbon dioxide equivalent
dLUC	–	direct Land Use Change
DM	–	Dry Matter
EtOH	–	Ethanol
EF	–	Emission Factor
EV	–	Electric Vehicle
FM	–	Fresh Matter
FT	–	Fischer-Tropsch
GHG	–	GreenHouse Gas
iLUC	–	indirect Land Use Change
IPCC	–	Intergovernmental Panel on Climate Change
LCA	–	Life-Cycle Assessment
LR	–	Learning Rate
LSNG	–	Liquid Synthetic Natural Gas
LUC	–	Land Use Change
MC	–	Marginal Cost
MFA	–	Material Flow Analysis
N <sub>2</sub> O	–	Nitrous oxide
NG	–	Natural Gas
PR	–	Progress Rate
PtG	–	Power-to-Gas
PtL	–	Power-to-Liquid
PtX	–	Power-to-Anything
R&D	–	Research and Development
RED	–	Renewable Energy Directive by the European Union
RME	–	Rape seed MethylEster
SNG	–	Synthetic Natural Gas
SRC	–	Short Rotation Coppice
TC	–	Total Cost
vRES	–	variable Renewable Energy Sources
WTT	–	Well-To-Tank
WTW	–	Well-To-Wheel

# Contents

<b>Abstract</b>	<b>ix</b>
<b>Acknowledgments</b>	<b>xi</b>
<b>List of Publications</b>	<b>xiii</b>
<b>List of Acronyms</b>	<b>xv</b>
<b>I Introductory chapters</b>	<b>1</b>
<b>1 Background</b>	<b>3</b>
1.1 Biofuels . . . . .	4
1.2 Technological Change and Modelling . . . . .	6
1.3 Aim and objectives . . . . .	6
<b>2 Methodology</b>	<b>9</b>
2.1 Systems modelling . . . . .	9
2.2 Model description . . . . .	10
<b>3 Results and discussion</b>	<b>17</b>
3.1 Biofuel techno-economic potential and competitiveness . . . . .	17
3.2 Discussion . . . . .	19
3.2.1 Resource base . . . . .	19
3.2.2 Biomass climate benefit in other sectors . . . . .	20
3.2.3 Other renewable fuel options . . . . .	21
3.2.4 Summary . . . . .	22
3.2.5 Applicability of results to other regions . . . . .	22
<b>4 Conclusions</b>	<b>25</b>
4.1 Future research . . . . .	26
<b>Bibliography</b>	<b>29</b>
<b>Contribution to Appended Papers</b>	<b>33</b>

---

<b>II</b>	<b>Appended papers</b>	<b>35</b>
<b>1</b>	<b>Competitiveness of advanced and conventional biofuels: Results from least-cost modelling of biofuel competition in Germany</b>	<b>37</b>
<b>2</b>	<b>Biomass price developments inhibit biofuel investments and research in Germany: The crucial future role of high yields</b>	<b>49</b>
<b>3</b>	<b>Relative greenhouse gas abatement cost competitiveness of biofuels in Germany</b>	<b>61</b>
<b>4</b>	<b>Climate optimal deployment of biofuels from crops in Germany</b>	<b>83</b>

## Part I

# Introductory chapters



# Chapter 1

## Background

EMISSIONS of fossil carbon dioxide cause an increase in atmospheric radiative forcing, leading to a net warming of the earth's surface (Arrhenius, 1896). Since Arrhenius' days, anthropogenic greenhouse gas emissions have increased manifold and atmospheric CO<sub>2</sub> concentration has increased from pre-industrial 278ppm (IPCC, 2013, p.50) to above 400ppm (Vaughan, 2015), and the additional relevance of other greenhouse gases such as CH<sub>4</sub>, N<sub>2</sub>O and halocarbons has been realised (IPCC, 2013).

The critical consequences of climate change for life on earth are far better understood than only a few decades ago (Field et al., 2014; IPCC, 2013). A large majority of all countries have ratified the Paris accord, thus agreeing upon measures for curbing global warming to 1.5°C or at least less than 2°C compared to pre-industrial levels (UNFCCC, 2015).

Transport emits 14% of total anthropogenic greenhouse gas emissions (IPCC, 2014a), with an increasing trend (IPCC, 2014b, p.7). In heavily industrialised countries such as Germany, the transport share of emissions is even higher, at 21% (EEA, 2017). Measures to reduce transport emissions are in place both in Germany (BImSchG, 2014) and in the European Union (European Parliament, 2009).

Climate change mitigation in the transport sector can be divided into the following measures (IPCC, 2014b, p.9): modal shift to less emitting modes of transport; reduction of fuel carbon intensity; reduction of energy intensity of vehicles; and reduction of activity. All measures are necessary in order to substantially reduce impact, which will also be seen later on in this work.

Biofuels are a measure for reducing the fuel carbon intensity for transport modes dominated by vehicles relying on fossil hydrocarbon fuels, such as diesel, gasoline, natural gas and kerosene. Policy quota for adding biofuels to diesel and gasoline has been in place in Germany for a good decade (BioKraftQuG, 2006), and almost as long in the EU (European Parliament, 2009), setting energetic quota to be achieved. In Germany, the focus has changed from such an energetic quota to a GHG abatement quota (BImSchG, 2014). The types of feedstocks used are changing too; the use of biomass residues and wastes has increased (BLE, 2017), while limits for crop-based biofuels will be in place shortly (BImSchV, 2017).

## 1.1 Biofuels

In this work, biofuels denote fuels of biogenic (phyto- or zoomass, as also defined in e.g. BiomasseV, 2001) origin used in transport. Conventional biofuels denote the biofuels which use food crops, whereas advanced biofuels denote those based on biomass with a high lignocellulose content (woody biomass).

The use of biomass and agricultural land is, due to its versatility, connected to virtually all sectors of society, making it an inherently complex subject. Biomass is needed for food and feed, fibre, building materials, chemicals as well as for energy, and can potentially replace fossil resources in all sectors (Ragauskas, 2006), both directly or in cascade (Haberl and Geissler, 2000). When designing biofuel policies, this greater context needs to be taken into account, in order to avoid sub-optimal solutions.

Many long-term scenarios assume significant shares of biofuels for the future in order to achieve climate goals (Szarka et al., 2017). The presently most common conventional biofuels such as oilseed based biodiesel and grain or maize based ethanol are food crop based and use only a small share of the crops for energetic purposes, thus being both inefficient as well as competing directly with food production. Furthermore, the use of dedicated crops for biofuel production risks increasing the pressure on land, thus leading to an extension of arable land into previously unused lands, potentially leading to substantial carbon emissions which overshadow the potential GHG abatement of the fuels (Fargione et al., 2008; Searchinger et al., 2008). Therefore, focus has been turned to crops grown on agricultural so called marginal or fallow lands (Tilman et al., 2006) as well as residual biomass.

The global biomass residue potential is limited as well as highly uncertain (Thrän et al., 2010; Hoogwijk et al., 2003; Haberl et al., 2010), and for degraded or marginal lands there is no common definition (IPCC, 2011, p.234). Furthermore, strong doubts have been raised as to how feasible such a use would be (Bryngelsson and Lindgren, 2013). However, also the notion of reducing the land required for meat production, which stands for 75% of agricultural land use (Foley et al., 2011), for achieving both a direct and substantial emission reduction as well as freeing land for biofuels has been raised (Bryngelsson et al., 2017; Foley et al., 2011; Tilman et al., 2009). Thus, as biomass residue and marginal land potentials are limited and uncertain, biomass from arable land may continue to be an important source for producing biofuels.

Dedicated crops suitable for biofuel production come in many different varieties, with differing characteristics in terms of climate requirements, photosynthesis, yield, type of energy storage, structural properties, growth period etc. Among biofuels, there are numerous pathways, with varying feedstocks (with differing shares of oil, sugar and lignocellulose content), varying technological characteristics, complexity and developmental stage, as well as varying costs and end-products (diesel, ethanol, methane and hydrogen). One can distinguish between three main routes for biofuel production (McKendry, 2002; Huber et al., 2006; IPCC, 2011, p.279):

1. Mechanical extraction and (trans-) esterification, where oil is extracted from oilseeds and converted into fatty-acid methyl esters (biodiesel).
2. Bio-chemical/biological (anaerobic digestion, fermentation), where sugar monomers are converted by bacteria into ethanol, methane or hydrogen.



- Thermo-chemical (gasification, pyrolysis, liquefaction, hydrolysis), where lignocellulose rich biomass is converted to a range of possible products, including Fischer-Tropsch (FT)-diesel, advanced bioethanol (combined with a subsequent fermentation), Synthetic Natural Gas (SNG) and hydrogen.

The first two belong to the conventional biofuels (if derived from food crops), and the thermo-chemical options belong to the advanced biofuels.

Figure 1.1 shows the different pathways which are included in this work (see e.g. Huber et al., 2006, for more information on the various biofuel production pathways). Rape seed, sugar beet, wheat and maize silage are classified as food crops, and thus fuels derived from these feedstocks belong to conventional biofuels. Poplar, willow and miscanthus are not food crops and have a high lignocellulose content; fuels derived from them belong to advanced biofuels.

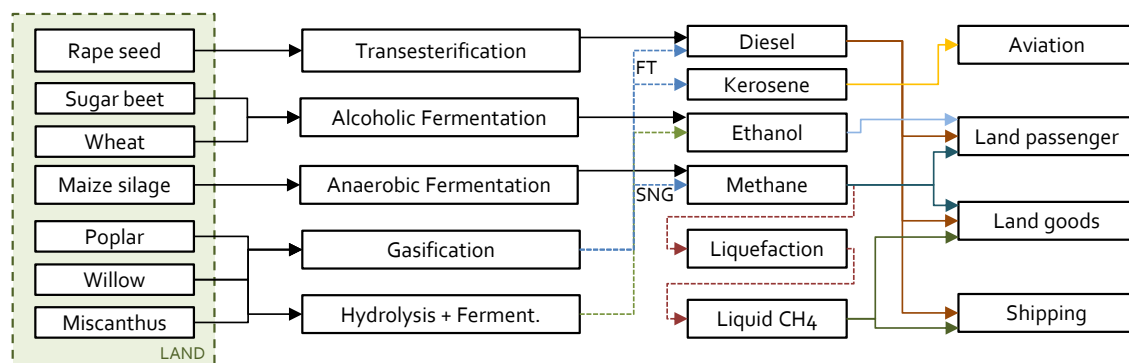

Figure 1.1: All biofuel pathways considered in this work. In paper 4, all of the shown pathways are included; in paper 1-3 only land transport and no liquefied methane; in paper 2 all pathways except advanced ethanol; in paper 1 without differentiation between lignocellulose rich feedstocks.

Diesel fuels can in this work be produced either through transesterification of rape seed or gasification and Fischer-Tropsch-synthesis of woody biomass. With the latter route, also Kerosene can be produced. Ethanol can be produced either through alcoholic fermentation of sugar beet or starch based crops such as wheat, or through hydrolysis and subsequent fermentation of woody biomass. Methane can be produced either through anaerobic fermentation of silage maize or gasification of woody biomass. The methane can then be cryogenically liquefied to liquid methane. In total, ten fuel pathways are included, although with differences between papers.

For each step in the pathway, there are differences in crops yields, inputs and costs; inputs, byproducts, costs and conversion efficiencies; fuel type suitability, demand differences and differing other types of renewable or modal split options for different sectors.

Currently, liquid conventional options are the most common biofuels, whereas neither conventional nor advanced gaseous fuels are used to a large degree in transport in Germany. The liquid advanced biofuel options have also not yet achieved a market break-through, despite reportedly promising cost competitiveness of both feedstocks and crops (IPCC, 2011, p.234) as well as of conversion options (IPCC, 2011, p.244ff & p.281f). Both economics and environmental performance are dependent on a range of parameters, bound with large uncertainties.

## 1.2 Technological Change and Modelling

Despite the uncertainties, policy and investment decisions need to be made. IPCC (2014a, p.872) emphasises the need for supporting technologies that are estimated to have high development potential, due to two market failures: the external costs of GHG emissions as well as of learning effects, which lead to an underestimation of future benefits or the benefits not being appropriated by the investor. For biofuels, both learning (including also initial costs) as well as environmental performance are subject to uncertainties and dependent on market competitiveness; still there is a surprising lack of systematic and detailed model-based analyses of these factors, especially in combination.

A wide range of models have been developed in order to assess the future role of biofuels for different regions of the world (summarized in Börjesson et al., 2013, p.27ff.). However, many of the models aggregate the biofuels to one or a few available options, thus not representing a competitiveness between biofuels; and many are perfect foresight models and most without endogenous technological change, thus lacking market interactions and path dependencies. For the one other model assessing biofuel competition in Germany with a high level bottom-up detail for the technologies (Martinsen et al., 2010), some factors are lacking: the feedstock cost and greenhouse gas emission developments are not detailed and technological learning is not included. All three have potentially crucial importance for the modelling results and conclusions.

The competitiveness between biofuels depends on a multitude of factors such as land use, yields, feedstock costs, conversion efficiencies, infrastructural costs and GHG abatement, as well as fit into the current system, among other factors. All of these factors are bound with more or less uncertainty and the competitiveness is always relative to the development of the other options.

In order to capture the complexity, a systems perspective is imperative, in order to consider not only the biofuels production pathways, but also the surrounding systems (Mangoyana et al., 2013; Heyne et al., 2015).

## 1.3 Aim and objectives

The aim of this thesis is to assess techno-economic development potentials of relevant biofuel options, and to model their competitiveness in the long-term under various scenarios and using different functional units: costs related to energy content and GHG abatement, as well as GHG abatement related to land use.

The following research questions are assessed:

1. What is the techno-economic development potential of biofuel options?
2. Which, if any, biofuels are favourable from a systems perspective?

A sound data basis is first established and a myopic simulation model is developed for assessing the competitiveness between various conventional and advanced biofuels for road transport in Germany until 2050, highlighting the influence of learning effects and feedstock cost developments. The role and potential of feedstock cost developments is highlighted

in a second stage, whereupon relative GHG abatement costs are assessed and finally an overall optimisation of biofuel deployment is performed in a perfect foresight optimisation model. This thesis includes four papers, listed in Tab. 1.1.

Table 1.1: Overview of papers and their connection to the research questions. RQ=research question

Paper	RQ	Description
1	1	Techno-economic review of biofuel options, model development
2	1	Feedstock cost assessment and method development
3	1&2	GHG module development, analysis of GHG abatement costs
4	2	Multi-sector optimisation model, optimal land use

The thesis consists of two parts. Part I is a general introduction to the field and puts the appended papers into context. Part II contains the appended papers.



## Chapter 2

# Methodology

**W**ITH the use of a systems perspective, partial analyses and thus sub-optimal solutions can be avoided, and therefore such a perspective will be used in this work in order to assess possible biofuel developments in mobility. A systems perspective does not merely consider each biofuel option independently, but their development in a system and is in the theory of industrial ecology manifested through the following areas (Lifset and Graedel, 2002; Erkman, 1997): (i) a life-cycle perspective, (ii) material and energy flow analyses, (iii) systems modelling and ideally (iv) interdisciplinary analyses. A further important aspect, (v) technological change, should also be mentioned in this context (Lifset and Graedel, 2002; Grubler, 1998). Aspects i-iii and v are considered in this work, and brought together with systems modelling.

### 2.1 Systems modelling

For the modelling of technological change, Grubler (1998, p.372) suggests the following elements to be included as a minimum: uncertainty and experimentation; R&D and learning; diffusion and substitution (interaction with existing technologies); economic, environmental and resource impacts and their feedbacks for technological change.

Due to uncertainty, interdependencies and unexpected growth patterns, markets can lock-in on solutions which may be sub-optimal from a systems perspective (Cowan, 1991; Grubler, 1998, p.71f.). Thus, increasing returns may lead to path dependencies, which may be difficult to break (Grubler, 1998, p.104ff.). The role of technological learning, potentially leading to cost reductions in each part of the value-chain, is also important (Grubler, 1998, p.81ff.). The diffusion of technologies in society often follows a logistic (S-shaped) curve, where technologies experience an introductory phase, a growth phase and saturation. The possible interaction of a technology with its technological environment needs to be examined to assess the potential of diffusion (Grubler, 1998, p. 49ff. and 58ff.).

Following these recommendations and in order to capture these elements, a myopic model, depicting uncertainty and market imperfection is developed. A recursive model, building on cumulative development in terms of both costs through technological learning and standing capacities is required. The competition of new options with the standing capacities that have

sunk capital investment costs requires a high detail of capital and marginal costs, and thus of input and output streams, resulting in a bottom-up approach. This enables capturing path dependencies. Endogenous technological learning introduces dynamics, reinforcing the cost-competitiveness of deployed options. Through the use of a partial equilibrium approach with an investment and production merit order until demand is satisfied, ensures least-cost developments.

Uncertainty (through myopic simulation), technological learning, diffusion and substitution as well as economic (learning) impacts are endogenised in the simulation model, whereas R&D, the exogenous part of technological learning, resource cost developments and environmental effects are handled exogenously. Thus, apart from stochastic elements and diverse agent behaviour, the suggested elements will all be captured in the modelling in this work.

For a national assessment covering only one of the many sectors using biomass, dynamic feedstock prices would be misleading, as both global trade and developments in other sectors would dominate the results, apart from being inherently impossible to foresee. Furthermore, although risk behaviour under uncertainty and experimentation certainly may strongly affect technological progress, such an assessment is out of the scope of an assessment of the relative competitiveness of biofuels, with the analysis aiming on normative conclusions rather than describing patterns. Instead, substantial sensitivity analyses are required. As a result of the assessment focusing on Germany, also R&D is relevant to include, as exogenous learning.

The system boundary in all papers is from Well-To-Tank (WTT), see Fig. 2.1, and thus a complete life-cycle perspective, including the use stage and beyond is out of the scope of this thesis. The status quo of biofuel production sets the starting point, with a temporal scope until 2050 and a spatial scope limited to Germany. Energetic, GHG abatement and land use functional units are assessed.

## 2.2 Model description

In order to model the competition between different technology options, a simulation model has been developed. BENSIM (BioENERgy SIMulation Model) is a myopic recursive dynamic bottom-up least-cost simulation model with endogenous technological learning, seeking the least-cost mix of biofuel production options on a yearly basis for fulfilling a set demand. Through the recursive elements of learning effects and previously built capacities, path dependencies can be captured by the model.

The existing biofuel plant infrastructure in the region in focus (Germany) is the basis at the starting point of the modelling. For each year of the simulation, BENSIM starts by removing the plants that have reached the end of their life-time (capacities present at the beginning are assumed to be decommissioned linearly over the life-time of the plants). In the next step, the technology options are sorted in the orders of total costs (TC; equation 2.1) and in merit order after marginal costs (MC; equation 2.2). A given biofuel demand sets the limit for the production and is also the basis for calculating a minimum market price ( $p_{sys}$ ), defined by the MC of the most expensive option in the merit order which is put into production. If there are options which have TC lower than the  $p_{sys}$ , capacity

investments<sup>1</sup> take place, beginning with the option with the lowest TC.

This continues until the market price adjusts on a level below the TC of still available options and the system reaches a (partial) equilibrium. In order to account for e.g. regional differences, investment risk behaviour and market imperfections, options with TC within 10% of the least-cost alternative are treated equally with the least-cost option, i.e. they are also invested in during the same round. There are no capacity expansion constraints in relation to previously built capacities.

After the investment phase, biofuel production takes place following the merit order based on marginal costs of production, until the hypothetical biofuel target is fulfilled (and/or until a given biomass potential is exhausted). In the following year, the technology options that experienced an expansion are subject to learning effects, reducing the investment costs by the learning rate for each doubling of capacity. The options which were not expanded experience “exogenous” learning through a research and development mechanism, defined as one learning rate unit in a specified number of years.

### Biofuel costs

Eqn. 2.1 shows the investment cost  $I_j^{(t)}$  [ $\text{€ GJ}_{fuel}^{-1}$ ] for technology  $j$  at time point  $t$  as a relationship of the initial investment cost  $I_j^{(0)}$  [ $\text{€ GJ}_{cap,fuel}^{-1}$  converted from  $\text{€ MW}_{cap,fuel}^{-1}$ ] with an assumed capacity factor  $C_{f,j}$  and an annuity factor with an assumed discount rate  $i$  over a set time-span  $T$ , including a learning effect by a learning rate  $LR_j$  with increasing cumulative production capacity  $k_j^{(t)}$  divided by the initial capacity  $k_j^{(0)}$  (see Grubler (1998, p81ff) and IEA (2000)). This relationship holds with the assumption that relative expansion in the region in focus is equal to the relative expansion globally. In order to have a nonzero denominator, a virtual initial capacity  $k_j^{(0)}$  for options not presently at the market is set at 2 PJ in this work, whereas actual initial capacities are set to zero. As the starting capacity for these options is relatively small, the capacities multiply relatively quickly in case of investments and thus can experience substantial learning.<sup>2</sup>

$$I_j^{(t)} = \frac{I_j^{(0)}}{C_{f,j}} \frac{i(1+i)^T}{(1+i)^T - 1} \left( \frac{k_j^{(t)}}{k_j^{(0)}} \right)^{-\log_2(1-LR_j)} \quad (2.1)$$

<sup>1</sup>Investments take place in units of  $1 \text{ PJ}_{cap} \text{ a}^{-1}$  (ca 35  $\text{MW}_{cap}$  at 8000 full-load hours), an assumption which enables a competition on equal terms. Typical plant sizes for the included options range between 7-250 MW (Ponitka et al., 2016) and thus the model units do not correspond to whole plants, but in some cases more and in some less. However, as the additional demand to be fulfilled surpasses at least 8 PJ  $\text{a}^{-1}$ , options with typically large plants may reach realistic capacity increments, especially when taking the development over time into account. Similarly, for options with typically small plant sizes the model unit corresponds to several plants.

<sup>2</sup>The set biofuel target influences the amount of expansion possible, thus limiting the possible cost reductions through technological learning. If the final biofuel target of 400 PJ is met by one of these technologies, about 9 virtual capacity doublings are possible, translating into a ca 60% investment cost reduction with a 10% learning rate, which may be seen as a rather high reduction but in line with some estimates for future costs (see e.g. Haarlemmer et al. (2012) and Hamelinck et al. (2005)).

$$\begin{aligned}
MC_j^{(t)} = & c_{om,j}^{(t)} + \frac{p_f^{(t)}}{e_f \eta_j^{(t)}} + p_{f2}^{(t)} \dot{m}_{f2,j} + p_{el}^{(t)} \dot{m}_{el,j} + p_{th}^{(t)} \dot{m}_{th,j} \\
& + c_{log,j}^{(t)} - p_{bp,j}^{(t)} \dot{m}_{bp,j} + p_{CO_2}^{(t)} \dot{m}_{CO_2,j}
\end{aligned} \tag{2.2}$$

Eqn. 2.2 shows the marginal cost  $MC_j^{(t)}$  [ $\text{€ GJ}_{fuel}^{-1}$ ] for technology  $j$  at time point  $t$  as a sum of operation and maintenance costs and personnel costs  $c_{om,j}^{(t)}$ , costs for main feedstock ( $p_f^{(t)}$  [ $\text{€ t}_{DM}^{-1}$ ] divided by feedstock specific energy content  $e_f$  [ $\text{GJ t}_{DM}^{-1}$ ] and conversion efficiency  $\eta_j^{(t)}$ ), secondary inputs  $p_{f2}^{(t)}$  [ $\text{€ t}^{-1}$ ], electricity ( $p_{el}^{(t)}$  [ $\text{€ kWh}^{-1}$ ] multiplied by amount required,  $\dot{m}_{el,j}$  [ $\text{kWh GJ}^{-1}$ ]), process heat ( $p_{th}^{(t)}$  [ $\text{€ kWh}^{-1}$ ] multiplied by amount required,  $\dot{m}_{th,j}$ ), logistic cost  $c_{log,j}^{(t)}$ , a credit for by-products  $p_{bp,j}^{(t)}$  and a cost of GHG emissions (the price of emissions  $p_{CO_2}^{(t)}$  multiplied by amount emitted  $\dot{m}_{CO_2,j}$ ).

The by-product income (tied to the respective feedstock cost developments), as well as input and infrastructure costs are elaborated in Paper 1.

Eqn. 2.3 shows the constitution of total costs as a sum of investment and marginal costs.

$$TC_j^{(t)} = I_j^{(t)} + MC_j^{(t)} \tag{2.3}$$

Technologies are assumed to improve their efficiencies linearly, with the end-point being set as a technical limit, to be reached in 2050. Initial plant investment costs are set per unit output in the starting year with further investment cost developments being independent of the efficiency improvements (*ceteris paribus*, this would mean that plant prices per input feedstock increase in line with the efficiency improvement, the sum being zero).

Economies of scale are applicable to biofuel plants, with larger plants having lower relative investment costs (see e.g. Lange, 2001; Bridgwater, 2009). However, the counteracting effect of feedstock availability and supply-chains affects the optimal sizing of a plant and is site specific, for which a more spatially detailed model would be appropriate. Thus, costs for relatively large-scale plants are assumed from the beginning of the simulation and economies of scale are not explicitly highlighted in the modelling.

## Feedstock costs

A common methodology for estimating the costs of energy crops is to add the per hectare profit of a benchmark crop to the per hectare production cost of the energy crop(s) (Witzel and Finger, 2016). This opportunity cost also serves as the shadow price of land, whereas published land rents may rather be seen as marginal land rents (Ericsson et al., 2009). Common benchmark crops include cereals (Krasuska and Rosenqvist, 2012; Faasch and Patenaude, 2012; Ericsson et al., 2009), corn (James et al., 2010; Khanna et al., 2008), soybeans (Khanna et al., 2008) and rape seed (Faasch and Patenaude, 2012). Usually, the most common crop in the region is selected, but sometimes also the one(s) deemed most likely to be replaced by energy crops. In Germany, by far the most common crop is wheat (Destatis, 2017), which is therefore used as a benchmark for all other crops in this work.



The hectare profit for wheat is calculated as the market price  $p_w^{(t)}$  [ $\text{€ t}_{FM}^{-1}$ ] times yield  $Y_w^{(t)}$  [ $\text{t}_{FM} \text{ ha}^{-1}$ ] minus production costs  $c_w^{(t)}$  [ $\text{€ ha}^{-1}$ ]. Other crops are to achieve this profit per ha, adding production costs  $c_i^{(t)}$  [ $\text{€ ha}^{-1}$ ]. The prices are then divided with the yield  $Y_i^{(t)}$  [ $\text{t}_{FM} \text{ ha}^{-1}$ ] to come up with a market price  $p_i^{(t)}$  [ $\text{€ t}_{DM}^{-1}$ ] of feedstock  $i$ . Over time, this results in a market price development including opportunity costs for each feedstock (Eqn. 2.4).

$$p_i^{(t)} = \left( p_w^{(t)} Y_w^{(t)} - c_w^{(t)} + c_i^{(t)} \right) Y_i^{(t)-1} \quad (2.4)$$

All perennials are assumed to provide the same and equivalent good<sup>3</sup>, "lignocellulosic biomass", for which the least-cost perennial crop sets the price on an annual basis. Thus, the marginal cost formulation is slightly transformed (Eqn. 2.5)

$$MC_j^{(t)} = c_{om,j}^{(t)} + \min_{\forall i \in f_j} \frac{p_i^{(t)}}{e_i} \frac{1}{\eta_j^{(t)}} + p_{f2}^{(t)} \dot{m}_{f2,j} + p_{el}^{(t)} \dot{m}_{el,j} + p_{th}^{(t)} \dot{m}_{th,j} + c_{log,j}^{(t)} - p_{bp,j}^{(t)} \dot{m}_{bp,j} \quad (2.5)$$

## Greenhouse gas abatement

In order to model greenhouse gas cost competitiveness, the model is transformed to have GHG abatement cost (instead of an energetic cost used previously) as the deciding factor, with a GHG abatement goal (instead an energetic goal) to be reached through substituting fossil fuels by the deployment of biofuels. The costs of the options on an energetic basis [ $\text{€ GJ}^{-1}$ ] are calculated according to (Millinger et al., 2017a), with the feedstock costs calculated according to (Millinger and Thrän, 2018). The costs are an output of the modelling, as learning effects affect the investment costs of the options if they expand due to their relative competitiveness. Feedstock costs are exogenous, with scenario differences.

In order to come up with the GHG abatement costs, some additional calculations are required. Firstly, the GHG emissions of each biofuel pathway need to be calculated and secondly, the total costs per GHG abatement unit need to be derived. The system boundaries are shown in Fig. 2.1.

Eqn. 2.6 shows the total GHG emissions  $\varepsilon_{tot,j}^{(t)}$  [ $\text{kgCO}_{2eq} \text{ GJ}_{fuel}^{-1}$ ] of option  $j$  at time-point  $(t)$  as a sum of all emissions in the different stages of the process:  $F$ , feedstock cultivation;  $T_1$ , transport of the biomass to the conversion facility;  $P_1$ , first process step (with allocation factor  $\alpha_1$ );  $P_2$ , second process step ( $\alpha_2$ ); transport of the fuel to the fuelling station  $T_2$ . The input data is all related to the feedstock input [ $\text{t}_{FM}$ ], except for the final fuel transport, whereby a conversion to  $\text{GJ}_{fuel}$  is performed through division by feedstock energy content  $e_j$  [ $\text{GJ t}_{FM}^{-1}$ ] multiplied by fuel conversion efficiency  $\eta_j$ . The inputs for the feedstock cultivation are on a hectare basis, thus a division by yield  $Y_j$  [ $\text{t}_{FM} \text{ ha}^{-1}$ ] is necessary. The

<sup>3</sup>i.e. the energy content part in the different lignocellulosic biomass types can be used equivalently, e.g. without needing to adapt the conversion step

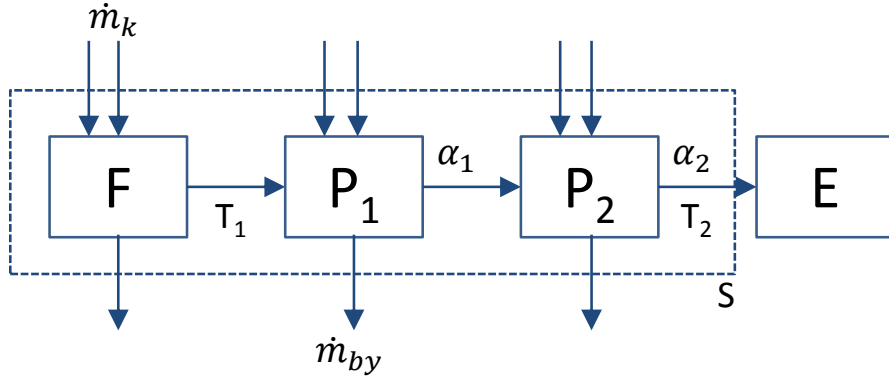

Figure 2.1: System boundaries of the Well-To-Tank (WTT) assessment from feedstock cultivation to tank for each pathway, shown by the dashed line S. The resulting abatement is compared on the basis of different functional units, such as GHG abatement per energy unit, cost per GHG abatement and GHG abatement per land area used. F=feedstock cultivation; T= transport; P<sub>1</sub>= process one; P<sub>2</sub>= process two; E= end use;  $\dot{m}_k$ = process inputs;  $\dot{m}_{by}$ = process by-products;  $\alpha$  = allocation factor, based on which the preceding greenhouse gas emissions are allocated to the main product, weighted based on the energy content of the different process outputs. The end use as well as potential indirect land use effects are not included. The biofuel combustion is assumed to be carbon neutral, as the carbon absorbed during plant growth is emitted, thus closing the cycle.

emissions of all process steps preceding the end of  $P_1$  are allocated to the fuel according to  $\alpha_1$ , whereas those preceding the end of  $P_2$  are additionally allocated according to  $\alpha_2$ . The allocation factors are weighted based on the energy content of the different process outputs.

$$\begin{aligned} \varepsilon_{tot,j}^{(t)} = & \frac{\alpha_1 \alpha_2}{e_j \eta_j} \left( \frac{1}{Y_j^{(t)}} \sum_{k \in F} \dot{m}_{k,j}^{(t)} \varepsilon_k^{(t)} + \sum_{k \in T_1} \dot{m}_{k,j}^{(t)} \varepsilon_k^{(t)} + \sum_{k \in P_1} \dot{m}_{k,j}^{(t)} \varepsilon_k^{(t)} - \dot{m}_{cr,j}^{(t)} \varepsilon_{cr}^{(t)} \right) \\ & + \frac{\alpha_2}{e_j \eta_j} \left( \sum_{k \in P_2} \dot{m}_{k,j}^{(t)} \varepsilon_k^{(t)} - \dot{m}_{cr,j}^{(t)} \varepsilon_{cr}^{(t)} \right) + \sum_{k \in T_2} \dot{m}_{k,j}^{(t)} \varepsilon_k^{(t)} \end{aligned} \quad (2.6)$$

For each input to any process, for all inputs  $k$  belonging to the respective process steps, the input amount  $\dot{m}_{k,j}^{(t)}$  is multiplied by its emission factor  $\varepsilon_k^{(t)}$ . Byproducts which are not considered in the allocation, but through a credit, are denoted  $cr$ .

The total costs  $TC_{j,e}^{(t)}$  are divided by the avoided fossil GHG emissions minus the biofuel pathway GHG emissions  $\varepsilon_{tot,j}^{(t)}$ , in order to come up with the GHG abatement cost  $TC_{j,\Delta\varepsilon}^{(t)}$  [€ kgCO<sub>2eq</sub><sup>-1</sup>] for time point  $(t)$  of option  $j$  (Eqn. 2.7).

$$TC_{j,\Delta\varepsilon}^{(t)} = TC_{j,e}^{(t)} \left( \varepsilon_{ref} - \varepsilon_{tot,k}^{(t)} \right)^{-1} \quad (2.7)$$

### Allocation optimisation

Complementing the simulation model, an optimisation module has been developed in GAMS. The technology and scenario data are imported and generated in BENSIM/Matlab,

and then exported to GAMS. Using the Cplex solver, the optimal GHG abatement under the given restrictions is calculated and the results sent back to Matlab, where plotting is performed.

The model is fully deterministic, bottom-up and uses perfect foresight. The objective function used here is maximising the GHG abatement  $\varepsilon_{tot}$  [tCO<sub>2eq</sub>] over the whole time period  $t$ , as a sum of all produced biofuels  $\pi_{i,t}$  [PJ] multiplied by their net GHG abatement  $\varepsilon_{i,t} - \varepsilon_{sub,t}$ , with  $\varepsilon_{sub,t} = 83.8$  [ktCO<sub>2eq</sub> PJ<sup>-1</sup>], for all options  $i$  and time points  $t$ .

The model restrictions are as follows: the biofuel production  $\pi_{i,t}$  for option  $i$  in time  $t$  is the sum of production in all sectors  $s$ , with a total demand  $\delta_{s,t}$  [PJ] for each sector which sets an upper limit for the total production of all options for each sector in each time point. The production cannot surpass the capacity available  $\kappa_{i,t}$ .

The capacity is the sum of the capacity in the previous year,  $\kappa_{i,t}$  [PJ] and new capacities  $\kappa_{i,t+1}^+$ , minus the capacities  $\kappa_{i,t-\hat{t}_i}^+$  which have reached the end of their life time  $\hat{t}_i=25$  [a]. Capacities available at the beginning  $\kappa_0$  are decommissioned linearly over their life time. Capacity expansion is subject to the sum of a constant ramp factor  $r_{min}=0.1$  [PJ a<sup>-1</sup>] and the product of standing capacity and  $r_f=0.5$ , and cannot surpass  $r_{max}=25$  [PJ a<sup>-1</sup>]. This sets a system inertia and ensures that capacities cannot expand suddenly, resulting in S-curve shaped market share increases (cf. Grubler, 1998).

The required land for each option is given by the production, divided by yield  $Y_{i,t}$  times conversion efficiency  $\eta_{i,t}$ . The total land use cannot surpass  $\Lambda_t=1.5$  [Mha] (in most scenarios in this paper) for each time point.

If a biofuel quota is in place, the quota  $q_t=0.5$  is the fraction of diesel fuels  $i \in I_{di}$  to ethanol  $i \in I_{pe}$ .

$$\max_{\varepsilon} \quad \varepsilon_{tot} = \sum_{i,t} (\varepsilon_{i,t} - \varepsilon_{sub,t}) \cdot \pi_{i,t} \quad (2.8a)$$

s.t.

$$\pi_{i,t} = \sum_s \pi_{i,t,s}, \quad \forall (i, t, s) \in (I, S, T), \quad (2.8b)$$

$$\delta_{s,t} \geq \sum_{i \in S} \pi_{i,t,s}, \quad \forall (i, s, t) \in (I, S, T), \quad (2.8c)$$

$$\pi_{i,t} \leq \kappa_{i,t}, \quad \forall (i, t) \in (I, T), \quad (2.8d)$$

$$\kappa_{i,t+1} \leq \kappa_{i,t} + \kappa_{i,t+1}^+ - \kappa_{i,t-\hat{t}_i}^+, \quad \forall (i, t) \in (I, T), \quad (2.8e)$$

$$\kappa_{i,t+1}^+ \leq r_{min} + r_f \cdot \kappa_{i,t}, \quad \forall (i, t) \in (I, T), \quad (2.8f)$$

$$\kappa_{i,t+1}^+ \geq r_{max}, \quad \forall (i, t) \in (I, T), \quad (2.8g)$$

$$\Lambda_t \geq \sum_{i,s} \pi_{i,t,s} (Y_{i,t} \eta_{i,t})^{-1}, \quad \forall (i, s, t) \in (I, S, T), \quad (2.8h)$$

$$q_t \sum_{i \in I_{pe}} \pi_{i,s_{pl},t} = \sum_{i \in I_{di}} \pi_{i,s_{pl},t}, \quad \forall (i, s, t) \in (I, S, T) \quad (2.8i)$$

The costs are in this case calculated ex-post, according to Millinger et al. (2017a), including technological learning effects based on the resulting expansion of the technologies in each

scenario. The feedstock costs were calculated according to (Millinger and Thrän, 2018), with an annual reference feedstock cost increase of 4%.

## Chapter 3

# Results and discussion

**M**ODELLING of the competitiveness of selected biofuels was carried out in this work, with foci on crop-based biofuel costs and GHG abatement. The role of technological learning effects and feedstock cost developments, as well as the development of GHG abatement and GHG abatement cost were analysed under German conditions. Finally, a GHG optimal allocation between transport sectors was carried out. The results differ from both current practice as well as from common expectations on advanced liquid biofuels. The main findings from the modelling and papers are here related to the research questions and then discussed from a systems perspective. For the details, please consult the respective papers.

### 3.1 Biofuel techno-economic potential and competitiveness

The techno-economic development of biofuel options depends on the competitiveness compared to other options and is thus best analysed in a competitive context. However, in contrast to e.g. wind and solar power, the potential cost reductions through technological learning are limited, and feedstock costs contribute to a large share of the total costs. Under a global decarbonisation, the feedstock cost is in the long-term likely to be determined by the land required.

In Paper 1, it was found that the investment cost of advanced biofuels has commonly been underrated, through optimistic assumptions for both initial investment costs, conversion efficiencies as well as for learning rates. Also, the feedstock cost developments have commonly been assumed to decrease, due to both optimistically assumed high yields (Haberl et al., 2010; Witzel and Finger, 2016; Searle and Malins, 2014), as well as learning effects for the cultivation. Instead, what is argued in Paper 2 is that the feedstock costs should be expected to increase, due to the fact that this has been the trend for the past several decades, as well as due to the high expectations on biomass in a global decarbonisation. A large scale deployment of biofuels for greenhouse gas abatement only makes sense in a large scale global transition, and thus such a development should be assumed when designing policy. The role of uncertain future feedstock prices is characteristic for any usage of biomass, in stark contrast to other renewable options such as wind and solar photovoltaics which have no operational resource costs, and must be considered when

designing policy for any sector of the bioeconomy. These results are all relevant also in a global context.

Through the application of a method commonly used for estimating minimum selling prices for energy crops, four main findings can be highlighted (Paper 2): currently common biofuels (rape seed based biodiesel and starch crop based bioethanol) were quickly displaced (by sugar beet based bioethanol); all feedstock costs were found to increase even at moderate price increases ( $2\% \text{ a}^{-1}$ ) well below developments in the recent decade ( $4\% \text{ a}^{-1}$ ), in stark contrast to assumptions found in literature; some conventional biofuels (sugar beet based bioethanol and silage maize based biomethane) were found to be more competitive than both currently common options as well as the advanced ones; gaseous biofuels (silage maize based biomethane and advanced Synthetic Natural Gas), especially among advanced options, were found to be highly competitive, also in stark contrast to current focus in literature and policy.

Investment cost reductions through technological learning were found to be overshadowed by feedstock cost developments, which presents a considerable market barrier, as the feedstock costs are not under the control of the investors. Focusing on optimising conversion efficiencies may thus prove more fruitful compared to reducing investment costs. However for some pathways, such as liquid advanced biofuels, thermodynamic limits set important limitations for the potential compared to gaseous biofuel pathways.

In Paper 3, combining these developments with detailed GHG abatement scenarios, the picture changed somewhat in that SNG was found more competitive than when compared with an energetic functional unit, with sugar beet based bioethanol and silage maize based biomethane being strong competitors. Currently common biofuels as well as advanced liquid options were found to be at least 40% more expensive. Overall lower yields and conversion efficiencies increase costs as well as at the same time reducing the GHG abatement, creating a double effect on the GHG abatement costs. Through switching from currently most common biofuels, rape seed based biodiesel and wheat based bioethanol to biomethane and SNG, the GHG abatement per land area can potentially be increased by a factor five. For present day, a switch to biomethane and sugar beet based bioethanol with renewable heat sources would double the spatial GHG abatement, despite the fact that the heat source requires substantial amounts of land.

In Paper 4, a focus on high yielding biofuels in terms of GHG abatement per area of arable land resulted in the following prioritisation for Germany, when taking current fuel suitability restrictions into account: land passenger transport sector would be of the highest priority due to the suitability of higher yielding biofuel options, followed by land goods transport, shipping and finally, when all other sectors have been covered by renewables, aviation.

An important finding of this work is that the direct importance of land use has thus far not received enough attention in terms of the economics of biofuels (Paper 2), as well as for the greenhouse gas emissions policy (Paper 3). Further effects related to land use which are of high concern in public debate, such as land use change, competition with food production and the potential of freeing land for conservation, result in strong arguments across the triple bottom line (social, economic, ecologic) for a stronger focus on land use of biofuels in policy and including the required arable land in the functional unit, instead of merely energy or GHG abatement as is presently the case. As could be expected in light of

previous results, the total cost differences between scenarios in Paper 4 were rather small, despite having no cost restrictions, and thus the greenhouse gas abatement per land area would be an important long-term indicator for crop-based biofuels.

Currently, substantial uncertainties lead to sub-optimal solutions being practised in each part of the pathway: uncertain policy leads to short-term and market-available, easily transportable and tradable feedstocks to be used, instead of using those which would result in lower cost as well as lower greenhouse gas emissions. Furthermore, investment uncertainties lead to low-cost conversion options being invested in, leading to simpler processes which require a larger share of the conversion to a usable fuel to be performed on the field (especially rape seed based biodiesel), which leads to lower yields.

An optimal GHG abatement through biofuels thus requires substantial policy in all parts of the pathway: on the feedstock side in assuring the availability of high yielding crop types while at the same time assuring a sustainable humus balance and a curbing of soil N<sub>2</sub>O emissions; on the conversion side in assuring that long-term investments are made feasible despite high uncertainties regarding feedstock costs, market demands and feedstock availability; on the demand side in assuring that a market for high yielding fuels exists through a higher deployment on flex fuel vehicles which allow for higher bioethanol and biomethane shares. Due to these barriers, a technology neutral policy is unlikely to result in high shares of these fuels; instead directed action would be required.

The current practise of applying admixture quotas to sub-sectors of land transport renders a significantly lower climate benefit compared to an overall optimal usage, and a large societal transition is required before aviation biofuels become the best biomass usage for mitigating climate change. Nevertheless, due to the lack of alternatives for aviation, such fuels remain of importance for the longer term.

## 3.2 Discussion

Thus far, competitiveness modelling results between biofuels have been assessed. However, the question under which circumstances biofuels are the best usage of biomass is important in this context. The answer to the question demands a systems perspective, as it depends essentially on the resource base, climate benefits in different sectors and competing renewable alternatives:

1. The biomass demand for food and feed
2. The biomass demand for all other non-food/feed sectors
3. The development of the fossil solutions which are to be substituted by biomass in each sector
4. The development of other non-biomass and non-fossil solutions for those sectors

### 3.2.1 Resource base

The role of biomass in a successful societal decarbonisation transition will change drastically. Current practise and demand for biomass is dominated by producing feed for meat production, with 75% of agricultural land used for raising animals (Foley et al., 2011),

with an increasing trend (FAO, 2017), which adds pressure on land use, leading to an extension of agriculture into previously largely pristine areas such as rain forests (Foley, 2005). Due to this added pressure, previously bounded soil carbon is emitted, leading to vast CO<sub>2</sub> emissions (Fargione et al., 2008), beside heavy biodiversity loss (Foley, 2005) among other effects. In order to avoid these effects - termed direct and indirect land use change - increased uses of biomass crops in any sector, such as for bioenergy, require an equivalent reduction of demand in other sectors. This is mainly achievable through a reduction of land required for meat production (Tilman et al., 2009; Bryngelsson et al., 2017; Foley et al., 2011) as well as thorough land use governance policy (Popp et al., 2012; Thrän et al., 2017), the latter which may prove difficult to implement on a global scale (Bryngelsson and Lindgren, 2013). In fact, a reduction of ruminant meat production is necessary in order to achieve climate goals (Bryngelsson et al., 2017), and the double effect of being able to use the land areas for replacing fossil fuels further enhances the positive effect (Tilman et al., 2009; Bryngelsson et al., 2017). Thus, an increase of bioenergy from dedicated crops relies on a redirection of currently used biomass or the lands used therefore (Tomei and Helliwell, 2016).

Current land required for producing biofuels used in Germany (including imports) amounts to ca 1.5 Mha (see Paper 4), while it has been estimated that 8.4 Mha (including imports) is needed for German meat consumption (Witzke et al., 2011). Thus, a reduction of land used for meat consumption by a fifth, through demand reduction or switching to less land intensive meat would, in addition to reducing GHG emissions resulting from ruminant meat production (Bryngelsson et al., 2017), allow for a doubling of the assumed area used for biofuels today, and thus essentially double the direct climate benefit resulting from biofuels.

### 3.2.2 Biomass climate benefit in other sectors

For the other non-food and feed sectors, biomass is a viable alternative to reduce GHG emissions through replacement of fossil options. Presently, the transport sectors stand for 21% of German GHG emissions (in total 926 Mton a<sup>-1</sup>), power production stands for 33%, manufacturing, construction and industrial processes stand for 24%, commercial and residential energy (mainly heating) 14% and agriculture 7% (EEA, 2017).

As a benchmark, the permissible carbon budget in order to achieve certain climate goals can be allocated per capita (WWF, 2017). For example, in order to achieve a 2°C target with a 66% likelihood, 9.9 Gton CO<sub>2eq</sub> (on average 291 Mton CO<sub>2eq</sub> a<sup>-1</sup>, assuming carbon neutrality after 2050) would be permissible for Germany. In the best scenario in Paper 4, the power and transport sectors emit ca 170 Mton a<sup>-1</sup>, leaving 121 Mton a<sup>-1</sup> for the other sectors. These sectors combined today emit ca 431 Mton (EEA, 2017), and thus a dramatic transition is required there as well.

The energy demand of some of the sectors can be reduced through efficiency measures (e.g. room and water heating), whereas e.g. construction requires a shift towards renewable materials where biomass can play a large role (Peñaloza, 2017; Rockström et al., 2017). For some industrial processes, the most suitable renewable options are biomass also in the long run (e.g. where the chemical properties of hydrocarbons are sought, such as in steel production and hydrocarbon chemistry). These sectors all compete with the transport



sector for the limited biomass available and more research is needed regarding optimal allocations of biomass across all sectors.

As long as there are options in the power mix, as well as in heat production and industrial applications, which emit more CO<sub>2</sub> than the transport fuel fossil reference, and can be replaced by biomass application with sufficient efficiency to achieve a higher climate benefit than through biofuels, then clearly these applications are to be prioritised from a climate perspective. This is for instance the case as long as coal power can be replaced by biomass in the power mix (i.e. as long as coal is the power generation option on the margin in terms of relative GHG emissions), especially by combined heat and power (CHP) processes with higher overall efficiencies and the possibility to serve both the power and heat sectors. Seasonal variations in demand and vRES supply may result in coal as an option in the winter to remain longer, for which biomass also may become important due to a lack of low-cost seasonal storage options (Millinger et al., 2017b).

When coal is no longer used and natural gas is the fossil option on the power (and heat) mix GHG margin, biofuels would substitute more fossil GHG emissions (Tab. 3.1). In this case however, efficiencies are important, as the difference between producing methane and liquid fuels may flip the advantage if gaseous biofuels are not viable in transport. As an example for wood-based advanced biofuels, conversion efficiencies of  $\eta = 0.58-0.73$  for SNG would require advanced liquid equivalents of  $\eta = 0.39-0.49$  in order to achieve the same GHG benchmark under RED - *ceteris paribus* - when excluding the process emissions, which are to the disadvantage of advanced liquid biofuel options. If the IPCC default values are used, this disadvantage is larger.

Table 3.1: Default emission factors for selected fossil fuels in stationary and mobile combustion (IPCC, 2006). The higher end of the range for the liquid fuels is the standard emission factor from the EU Renewable Energy Directive (European Parliament, 2009).

	tCO <sub>2</sub> TJ <sup>-1</sup>
Lignite	101.0
Anthracite	98.3
Liquid fuels	69.3-83.8
Natural gas	56.1

### 3.2.3 Other renewable fuel options

In the case of mobility, the two most viable alternatives to biofuels are electric (Armaroli and Balzani, 2011) and hydrogen (from water electrolysis) (Dunn, 2002) mobility, both of which could be supplied renewably in sufficient quantities (Jacobson and Delucchi, 2011) and without the use of hydrocarbons. For these options, the GHG emissions rely on those of the power mix. For the fuel versions, the combination with conversion losses (Sterner, 2009, p.109f.) renders those alternatives superior to biofuels only at very high shares of variable renewables (vRES). Alternatively, excess power produced could be utilised, with the advantage of (near) zero GHG emissions, but with a limited amount available, possibly even at very high vRES shares (Schill, 2013; Tafarte et al., 2014). Such high levels may even be infeasible due to decreasing marginal values of vRES leading to a heavy reliance on dedicated subsidies, with high CO<sub>2</sub>-prices potentially counteracting vRES throughput by favouring baseline options such as CCS and - if permitted - nuclear power (Hirth, 2014). If an (almost) fully renewable power mix is achieved, for the hydrocarbon options the

question remains as to where a cost-competitive source of carbon is to be found, as the fossil options would be largely phased out by then. Thus, possibly hydrogen may be the long-term competitor to biofuels in transport modes where battery storage based propulsion is not an option - and potentially even a serious competitor to battery EVs (van der Zwaan et al., 2013).

For solar and wind power, the direct usage of the generated power for producing fuels (often called Power-to-X, PtX, or electrofuels) is an alternative which would circumvent the relatively slow progress in the power mix. Thus substantially higher yields per land area can be achieved (Larkum, 2010), but there are at least three caveats: firstly, due to the variable nature of vRES leading to low capacity usage and the high cost of PtX facilities (Albrecht et al., 2016), the solutions to produce fuels are costly; secondly, the power is better used directly, and without substantial conversion losses, in a system-friendly manner (Tafarte et al., 2014; Millinger et al., 2017b) in the power mix as long as it can replace any fossil fuels there; thirdly, photovoltaic modules can be installed on non-arable areas and thus compete directly for the arable land only when these have been saturated. Nevertheless, this is a field which grants further research.

### 3.2.4 Summary

Thus, solutions which may appear elusive, such as liquid lignocellulose based fuels, lignocellulosic crops from marginal lands, aviation fuels as well as PtX, are not necessarily the immediately best options for transport, when viewed from a systems perspective.

Table 3.2: A sketch of possible short, medium and long-term priorities of biomass allocation, summarising this section.

	Options
Short-term	replacing coal, CHP, fuels fitting into current system
Medium-term	gaseous biofuels (possibly of perennial origin), seasonal storage
Long-term	building materials, aviation, hydrocarbon based chemicals and materials

The overall priorities emerging from this discussion are shown in Tab. 3.2, where the options relevant in the short, medium and long terms are sketched. Some of the options which are relevant also in the long-term, such as building materials, are relevant immediately. Others, such as gaseous biofuels would require an early policy to stimulate supply and demand.

### 3.2.5 Applicability of results to other regions

Although this work is based on Germany, several key findings can be generalised for a global context. The results for investment costs and technological learning are applicable globally. Expectation on advanced biofuels are high, due to expected learning in each part of the chain. However, the findings in this work suggest that the expectations are set too high.

Furthermore, the importance of feedstock costs for the cost developments has been underrated, due to often assumed decreasing feedstock costs, especially for short rotation coppice. As instead demand for biomass is likely to increase, the general increasing feedstock cost trend in the past decades is likely to continue, perhaps even at higher rates. The feedstock

cost developments overshadow potential investment cost reductions. This in turn inhibits investments due to high uncertainties and as the feedstock costs are not in the control of the investors, and thus no technological learning takes place.

German per capita arable land corresponds roughly to the global average<sup>1</sup>, and is thus a relevant measure also in a global context - albeit with significantly higher than average yields (FAO, 2017). As the supply side is not significantly skewed, the results from a German study can thus to some extent be scaled up or transferred to other regions.

The best biofuels differ between regions, due to different climate, crop suitability, yields, as well as differing power mix and other background systems. In addition, the availability of biomass residues is an important difference between regions. Also, the role of electric mobility and electrofuels, especially in regions with a high share of renewables in the power mix, may differ, as does the composition of the vehicle fleet. Thus, although some results can be generalised, important differences would lead to other optimal biofuel developments.

---

<sup>1</sup>World arable land is 1530 Mha (Foley et al., 2011). A current population of 7.6 billion gives 0.20 ha cap<sup>-1</sup>. German arable land is ca 12 Mha, with ca 82 million capita (Destatis, 2017), giving 0.15 ha cap<sup>-1</sup>. As the global population increases while the German one is relatively stagnant, the per capita arable land will converge.



## Chapter 4

# Conclusions

**B**Y applying a systems perspective, some common preconceptions about biofuel futures have in this work been scrutinised in terms of economic developments and greenhouse gas abatement, using energetic, GHG abatement and land use functional units. The results differ from both current practice as well as from common expectations on advanced liquid biofuels.

It was found that the costs of advanced biofuels have commonly been underrated, through optimistic assumptions for the feedstocks (optimistic high yields, learning effects, baseline cost reductions) and conversion step (initial investment costs, conversion efficiencies, learning rates). Through a thorough data and plausible assumption set, all of these factors were revised compared to common assumptions, leading to some interesting conclusions.

Currently most common practise, i.e. rape seed based biodiesel and wheat based bioethanol was found not to be economical when considering differentiated and increasing feedstock costs. Instead, sugar beet based bioethanol in the short to medium term, and silage maize based biomethane as well as lignocellulosic crop based SNG in the medium to long-term were found to be the more economical options, both with energetic and GHG abatement functional units. Notably, advanced liquid fuels were found substantially inferior to these three options. Switching from current practise to higher yielding biofuel options can treble the abatement per land area for the present day, and potentially increase it by a factor five in the future.

Notably, the different functional units result in different merit orders for the biofuel options. With an energetic cost functional unit, sugar beet based ethanol dominated for most of the time span, whereas a relative GHG abatement cost functional unit resulted in SNG being a strong option, especially at a rapid decarbonisation of the power mix. With a land use GHG abatement functional unit, silage maize based biomethane was the best, with SNG converging only at very high renewables shares of the background systems.

The land use of biofuels perspective decides large parts of both economics and GHG emissions and thus in an optimal development, current practise would be rapidly replaced by higher yielding options. However, some important market barriers require dedicated policy in order for this to take place: investment cost reductions through technological learning are overshadowed by feedstock cost developments, which inhibits investments as the feedstock costs are not under the control of the investors; perennial crops are

a long-term investment for farmers with increased risks, which would likely need to be circumvented through policy; for gaseous biofuels as well as for higher bioethanol shares, the vehicle market needs to be stimulated. Furthermore, other ecological parameters need to be monitored in order to ensure sustainable practises.

Due to differences in available options, it is likely that the transport sub-sectors are transformed at different paces, and thus biofuels would wander between them in order to perform incremental improvements until larger transformations occur. A focus on high yielding biofuels in terms of GHG abatement per area of arable land results in the land passenger transport sector to be of the highest priority due to the suitability of higher yielding biofuel options, followed by land goods transport, shipping and finally aviation. The current practise of applying admixture quotas to sub-sectors of land transport renders a significantly lower climate benefit compared to an overall optimal usage, and a large societal transition is required before aviation biofuels become the best biomass usage for mitigating climate change. If gaseous fuels are not possible to introduce on a large scale, sectors allowing liquefied gaseous fuels become the priority, e.g. goods transport and shipping.

The direct importance of land use has thus far not received enough attention in terms of the economics of biofuels from dedicated crops, as well as for the greenhouse gas emissions policy. Biofuels produced from arable land can provide a strong GHG benefit if an expansion of arable land is hindered through redirecting land use, which requires a holistic policy approach.

## 4.1 Future research

As the topic at hand spans a multitude of disciplines, future work identified through this work is divided into work related to modelling as well as to other issues. Each identified area grants substantial further research.

Future research related directly to the modelling includes:

1. Analysis across regions (e.g. EU), with differing yields, potentials, power mix etc.
2. Spatially explicit extension of the model and assessment of optimal locations of biofuel conversion facilities
3. Analysis across more societal sectors (e.g. power, heat, industry)
4. Competitiveness and potential of PtX/electrofuels compared to biofuels
5. Biofuels from perennials grown on marginal lands
6. Technological learning effects and endogenous efficiency developments in the perfect forecast model
7. Comparison of the myopic and perfect forecast models
8. Assessment of vehicle market developments, extending the analysis to Well-to-Wheel and analysing the potential role of differences between drive trains on the competitiveness.

Thus, the spatial scope and detail, the sectors, technology and feedstock options included, system boundary extensions and model technical aspects can all be extended in order to provide answers to further questions regarding this topic.

Future research related to surrounding issues includes:

1. Sustainable high yielding biofuel crop practises possibly allowing for land conservation and the resulting ecological trade-offs
2. Regional assessment of soil N<sub>2</sub>O emissions, and practises curbing these
3. Feedstock cost developments under a global energy and bioeconomy transition
4. Investment costs and conversion efficiencies of advanced biofuel options as well as yields and costs of perennials

More holistic research is required in order to come up with practises combining high yields across the whole value-chain, while assuring ecologically sustainable practises. The notion of assessing land use as a basket of goods rather than on an individual pathway level would include the possibility of land conservation enabled through higher yielding practises, which locally may not be the best practise but globally perhaps optimal. Thus trade-offs could be analysed from a systems perspective.

The N<sub>2</sub>O balance of agricultural practises are highly variable, dependent on regional characteristics such as climate, soil and weather (Bouwman et al., 1993), but is also dependent on farming and can be curbed through more sustainable practises (Skenhall et al., 2013). Both should be monitored and regulated, as these emissions show a large span (Crutzen et al., 2008; Cherubini and Strømman, 2011; Menten et al., 2013) and thus present considerable uncertainties for any given biofuel.

Future feedstock cost developments are an uncertain field, which cannot viably be analysed through the use of historical developments in a previously unprecedented global transition to a bioeconomy. Mere market models are also not sufficient, as bio-physical limits are of crucial importance (Bryngelsson and Lindgren, 2013; Millinger and Thrän, 2018), and assumptions of learning effects for some feedstocks without including overall feedstock cost developments are not sufficient. The notion of feedstock costs decreasing over long periods of time (in stark contrast to the developments in past decades) simultaneously with a global decarbonisation must be held to be absurd. Since this parameter was found to be of utmost importance, the field must receive more attention.

Investment costs of advanced biofuel options show a large span in literature (Haarlemmer et al., 2014), as do the yields and costs of perennial crops (Witzel and Finger, 2016; Searle and Malins, 2014), as well as the conversion efficiencies (Millinger et al., 2017a). This therefore requires more research, as the uncertainties, together with those of the feedstock costs, are detrimental to investment as well as policy decisions.





# Bibliography

- Friedemann G. Albrecht, Daniel H. König, and Ralph-Uwe Dietrich. The potential of using power-to-liquid plants for power storage purposes. In *2016 13th International Conference on the European Energy Market (EEM)*, pages 1–5, Piscataway, NJ, 2016. IEEE. ISBN 978-1-5090-1298-5. doi: [10.1109/EEM.2016.7521203](https://doi.org/10.1109/EEM.2016.7521203).
- Nicola Armaroli and Vincenzo Balzani. Towards an electricity-powered world. *Energy & Environmental Science*, 4(9):3193, 2011. ISSN 1754-5692. doi: [10.1039/c1ee01249e](https://doi.org/10.1039/c1ee01249e).
- Svante Arrhenius. On the Influence of Carbonic Acid in the Air upon the Temperature of the Ground. *Philosophical Magazine and Journal of Science*, 41(5):237–276, 1896.
- BImSchG. Bundes-Immissionsschutzgesetz in der Fassung der Bekanntmachung vom 17. Mai 2013 (BGBl. I S. 1274), das zuletzt durch Artikel 1 des Gesetzes vom 20. November 2014 (BGBl. I S. 1740) geändert worden ist. *Bundesgesetzblatt*, I(53):1740–1747, 2014.
- BImSchV. Achtunddreißigste Verordnung zur Durchführung des Bundes-Immissionsschutzgesetzes (Verordnung zur Festlegung weiterer Bestimmungen zur Treibhausgasminde rung bei Kraftstoffen): 38. BImSchV. *Bundesgesetzblatt*, I(77):3892, 2017.
- BioKraftQuG. Gesetz zur Einführung einer Biokraftstoffquote durch Änderung des Bundes-Immissionsschutzgesetzes und zur Änderung energie- und stromsteuerrechtlicher Vorschriften: Biokraftstoffquotengesetz - BioKraftQuG. *Bundesgesetzblatt*, I(62):3180–3188, 2006.
- BiomasseV. Verordnung über die Erzeugung von Strom aus Biomasse. *Bundesgesetzblatt*, I:1234, 2001.
- BLE. *Hintergrunddaten zum Evaluations- und Erfahrungsbericht 2016*. Bundesanstalt für Landwirtschaft und Ernährung, Bonn, 2017.
- Martin Börjesson, Maria Grahn, and E.O. Ahlgren. *Transport biofuel futures in energy-economy modelling - a review: Available at www.f3centre.se: Report No 2013:10*. f3 - The Swedish Knowledge Centre for Renewable Transportation Fuels, 2013.
- A. F. Bouwman, I. Fung, E. Matthews, and J. John. Global analysis of the potential for N<sub>2</sub>O production in natural soils. *Global Biogeochemical Cycles*, 7(3):557–597, 1993.
- A.V. Bridgwater. *Technical and Economic Assessment of Thermal Processes for Biofuels: Available at: http://www.globalbioenergy.org: NNFCC project 08/018*. Consultants On Process Engineering Ltd., 2009.
- David Bryngelsson, Fredrik Hedenus, Daniel Johansson, Christian Azar, and Stefan Wirsenius. How Do Dietary Choices Influence the Energy-System Cost of Stabilizing the Climate? *Energies*, 10(2):182, 2017. ISSN 1996-1073. doi: [10.3390/en10020182](https://doi.org/10.3390/en10020182).
- David K. Bryngelsson and Kristian Lindgren. Why large-scale bioenergy production on marginal land is unfeasible: A conceptual partial equilibrium analysis. *Energy Policy*, 55:454–466, 2013. ISSN 0301-4215. doi: [10.1016/j.enpol.2012.12.036](https://doi.org/10.1016/j.enpol.2012.12.036).
- Francesco Cherubini and Anders Hammer Strømman. Life cycle assessment of bioenergy systems: State of the art and future challenges. *Bioresour ce Technology*, 102(2):437–451, 2011. ISSN 09608524. doi: [10.1016/j.biortech.2010.08.010](https://doi.org/10.1016/j.biortech.2010.08.010).
- R. Cowan. Tortoises and Hares - Choice among Technologies of Unknown Merit. *Economic Journal*, 101(407):801–814, 1991.
- P. J. Crutzen, A. R. Mosier, K. A. Smith, and W. Winiwarter. N<sub>2</sub>O release from agro-biofuel production negates global warming reduction by replacing fossil fuels. *Atmospheric Chemistry and Physics*, 8(2): 389–395, 2008. ISSN 1680-7324. doi: [10.5194/acp-8-389-2008](https://doi.org/10.5194/acp-8-389-2008).
- Destatis. *Statistisches Jahrbuch 2017: Deutschland und Internationales*. Statistisches Bundesamt, Wiesbaden, 1 edition, 2017. ISBN 978-3-8246-1057-0.
- Seth Dunn. Hydrogen futures: toward a sustainable energy system. *International Journal of Hydrogen Energy*, 2002(27):235–264, 2002. ISSN 03603199.
- EEA. *European Environment Agency Greenhouse Gas Data Viewer: www.eea.europa.eu/data-and-maps/data/data-viewers/greenhouse-gases-viewer*. European Environment Agency, 2017.

- Karin Ericsson, Håkan Rosenqvist, and Lars J. Nilsson. Energy crop production costs in the EU. *Biomass and Bioenergy*, 33(11):1577–1586, 2009. ISSN 09619534. doi: \url{10.1016/j.biombioe.2009.08.002}.
- S. Erkman. Industrial ecology: an historical view. *Journal of Cleaner Production*, 5(1-2):1–10, 1997. ISSN 09596526.
- European Parliament. Directive 2009/28/EC of the European Parliament and of the Council of 23 April 2009 on the promotion of the use of energy from renewable sources and amending and subsequently repealing Directives 2001/77/EC and 2003/30/EC, 2009.
- Rouven Jonas Faasch and Genevieve Patenaude. The economics of short rotation coppice in Germany. *Biomass and Bioenergy*, 45:27–40, 2012. ISSN 09619534. doi: \url{10.1016/j.biombioe.2012.04.012}.
- FAO. *FAOSTAT*: [www.fao.org/faostat/](http://www.fao.org/faostat/). Food and Agriculture Organization of the United Nations, 2017.
- Joseph Fargione, Jason Hill, David Tilman, Stephen Polasky, and Peter Hawthorne. Land Clearing and the Biofuel Carbon Debt. *Science*, 319(5867):1235–1238, 2008. ISSN 0036-8075. doi: \url{10.1126/science.1152747}.
- Christopher B. Field, Vicente R. Barros, David Jon Dokken, Katharine J. Mach, and Michael D. Mastrandrea. *Climate Change 2014 Impacts, Adaptation, and Vulnerability*. Cambridge University Press, Cambridge, 2014. doi: \url{10.1017/CBO9781107415379}.
- J. A. Foley. Global Consequences of Land Use. *Science*, 309(5734):570–574, 2005. ISSN 0036-8075. doi: \url{10.1126/science.1111772}.
- Jonathan A. Foley, Navin Ramankutty, Kate A. Brauman, Emily S. Cassidy, James S. Gerber, Matt Johnston, Nathaniel D. Mueller, Christine O’Connell, Deepak K. Ray, Paul C. West, Christian Balzer, Elena M. Bennett, Stephen R. Carpenter, Jason Hill, Chad Monfreda, Stephen Polasky, Johan Rockström, John Sheehan, Stefan Siebert, David Tilman, and David P. M. Zaks. Solutions for a cultivated planet. *Nature*, 478(7369):337–342, 2011. ISSN 0028-0836. doi: \url{10.1038/nature10452}.
- Arnulf Grubler. *Technology and global change*. Cambridge University Press, Cambridge, 1998. ISBN 0521543320.
- Geert Haarlemmer, Guillaume Boissonnet, Juliette Imbach, Pierre-Alexandre Setier, and Emanuela Peduzzi. Second generation BtL type biofuels – a production cost analysis. *Energy & Environmental Science*, 5(9):8445, 2012. ISSN 1754-5692. doi: \url{10.1039/c2ee21750c}.
- Geert Haarlemmer, Guillaume Boissonnet, Emanuela Peduzzi, and Pierre-Alexandre Setier. Investment and production costs of synthetic fuels – A literature survey. *Energy*, 66:667–676, 2014. ISSN 03605442. doi: \url{10.1016/j.energy.2014.01.093}.
- H. Haberl and S. Geissler. Cascade utilization of biomass: strategies for a more efficient use of a scarce resource. *Ecological Engineering*, 16(1, SI):S111–S121, 2000. ISSN 0925-8574.
- Helmut Haberl, Tim Beringer, Sribas C. Bhattacharya, Karl-Heinz Erb, and Monique Hoogwijk. The global technical potential of bio-energy in 2050 considering sustainability constraints. *Current Opinion in Environmental Sustainability*, 2(5-6):394–403, 2010. ISSN 18773435. doi: \url{10.1016/j.cosust.2010.10.007}.
- Carlo N. Hamelinck, Geertje van Hooijdonk, and André P. C. Faaij. Ethanol from lignocellulosic biomass: techno-economic performance in short-, middle- and long-term. *Biomass and Bioenergy*, 28(4):384–410, 2005. ISSN 09619534. doi: \url{10.1016/j.biombioe.2004.09.002}.
- Stefan Heyne, M. Grahn, and F. Sprei. Systems perspectives on alternative future transportation fuels: A literature review of systems studies and scenarios, challenges and possibilities for bioenergy, production of biofuels and use of alternative transportation fuels: Report within project “A pre-study to prepare for interdisciplinary research on future alternative transportation fuels”, financed by The Swedish Energy Agency., 2015.
- Lion Hirth. *The Economics of Wind and Solar Variability : how the Variability of Wind and Solar Power affects their Marginal Value, Optimal Deployment, and Integration Costs*. PhD-thesis, TU Berlin, Berlin, 2014.
- Monique Hoogwijk, André Faaij, Richard van den Broek, Göran Berndes, Dolf Gielen, and Wim Turkenburg. Exploration of the ranges of the global potential of biomass for energy. *Biomass and Bioenergy*, 25(2): 119–133, 2003. ISSN 09619534. doi: \url{10.1016/S0961-9534(02)00191-5}.
- George W. Huber, Sara Iborra, and Avelino Corma. Synthesis of Transportation Fuels from Biomass: Chemistry, Catalysts, and Engineering. *Chemical Reviews*, 106(9):4044–4098, 2006. ISSN 0009-2665. doi: \url{10.1021/cr068360d}.
- IEA. *Experience Curves for Energy Technology Policy*. IEA Publications, Paris, France, 2000. ISBN 92-64-17650-0-2000.
- IPCC. *2006 IPCC Guidelines for National Greenhouse Gas Inventories: Volume 2 - Energy*. Institute for Global Environmental Strategies, Hayama, Japan, 2006. ISBN 4-88788-032-4.

- IPCC. *Renewable Energy Sources and Climate Change Mitigation: Special Report of the Intergovernmental Panel on Climate Change*. Cambridge University Press, Cambridge, United Kingdom and New York, NY, USA., 2011.
- IPCC. *Climate Change 2013: The Physical Science Basis: Working Group I Contribution to the Fifth Assessment Report of the Intergovernmental Panel on Climate Change*. Cambridge University Press, Cambridge, 2013. ISBN 978-1-107-05799-1.
- IPCC, editor. *Climate Change 2014: Mitigation of Climate Change: Contribution of Working Group III to the Fifth Assessment Report of the Intergovernmental Panel on Climate Change*. IPCC, Cambridge University Press, Cambridge, United Kingdom and New York, NY, USA, 2014a. ISBN 978-1-107-05821-7.
- IPCC. Climate Change 2014: Mitigation of Climate Change: Chapter 8 - Transport. In IPCC, editor, *Climate Change 2014: Mitigation of Climate Change*. IPCC, Cambridge University Press, Cambridge, United Kingdom and New York, NY, USA, 2014b. ISBN 978-1-107-05821-7.
- Mark Z. Jacobson and Mark A. Delucchi. Providing all global energy with wind, water, and solar power, Part I: Technologies, energy resources, quantities and areas of infrastructure, and materials. *Energy Policy*, 39(3):1154–1169, 2011. ISSN 0301-4215. doi: \url{10.1016/j.enpol.2010.11.040}.
- Laura K. James, Scott M. Swinton, and Kurt D. Thelen. Profitability Analysis of Cellulosic Energy Crops Compared with Corn. *Agronomy Journal*, 102(2):675, 2010. ISSN 1435-0645. doi: \url{10.2134/agronj2009.0289}.
- Madhu Khanna, Basanta Dhungana, and John Clifton-Brown. Costs of producing miscanthus and switchgrass for bioenergy in Illinois. *Biomass and Bioenergy*, 32(6):482–493, 2008. ISSN 09619534. doi: \url{10.1016/j.biombioe.2007.11.003}.
- Ewa Krasuska and Håkan Rosenqvist. Economics of energy crops in Poland today and in the future. *Biomass and Bioenergy*, 38:23–33, 2012. ISSN 09619534. doi: \url{10.1016/j.biombioe.2011.09.011}.
- Jean-Paul Lange. Fuels and Chemicals Manufacturing: Guidelines for Understanding and Minimizing the Production Costs. *CatTech*, 5(2), 2001.
- A. W. D. Larkum. Limitations and prospects of natural photosynthesis for bioenergy production. *Current Opinion in Biotechnology*, 21(3):271–276, 2010. ISSN 09581669. doi: \url{10.1016/j.copbio.2010.03.004}.
- R. Lifset and T. Graedel. Industrial ecology: goals and definitions. In Robert U. Ayres and Leslie W. Ayres, editors, *A handbook of industrial ecology*, pages 3–15. Edward Elgar Publishing Ltd, Cheltenham, 2002. ISBN 978-1840645064.
- Robert B. Mangoyana, Timothy F. Smith, and Rodney Simpson. A systems approach to evaluating sustainability of biofuel systems. *Renewable and Sustainable Energy Reviews*, 25:371–380, 2013. ISSN 13640321. doi: \url{10.1016/j.rser.2013.05.003}.
- Dag Martinsen, Carolin Funk, and Jochen Linssen. Biomass for transportation fuels—A cost-effective option for the German energy supply? *Energy Policy*, 38(1):128–140, 2010. ISSN 0301-4215. doi: \url{10.1016/j.enpol.2009.08.064}.
- Peter McKendry. Energy production from biomass (part 2): conversion technologies. *Bioresource Technology*, 83(1):47–54, 2002. ISSN 09608524. doi: \url{10.1016/S0960-8524(01)00119-5}.
- Fabio Menten, Benoît Chèze, Laure Patouillard, and Frédérique Bouvart. A review of LCA greenhouse gas emissions results for advanced biofuels: The use of meta-regression analysis. *Renewable and Sustainable Energy Reviews*, 26:108–134, 2013. ISSN 13640321. doi: \url{10.1016/j.rser.2013.04.021}.
- Markus Millinger and Daniela Thrän. Biomass price developments inhibit biofuel investments and research in Germany: The crucial future role of high yields. *Journal of Cleaner Production*, 172:1654–1663, 2018. ISSN 09596526. doi: \url{10.1016/j.jclepro.2016.11.175}.
- Markus Millinger, Jens Ponitka, Oliver Arendt, and Daniela Thrän. Competitiveness of advanced and conventional biofuels: Results from least-cost modelling of biofuel competition in Germany. *Energy Policy*, 107(107):394–402, 2017a. ISSN 0301-4215. doi: \url{10.1016/j.enpol.2017.05.013}.
- Markus Millinger, Philip Tafarte, Martin Dotzauer, Katja Oehmichen, Annedore Kanngießner, Benedikt Meyer, Anna Grevé, and Anna Hagemeyer. BalanceE - Synergien, Wechselwirkungen und Konkurrenzen beim Ausgleich fluktuierender erneuerbarer Energien im Stromsektor durch erneuerbare Optionen: Endbericht, 2017b.
- Diego Peñaloza. *The role of biobased building materials in the climate impacts of construction: Effects of increased use of biobased materials in the Swedish building sector*. PhD Thesis, KTH Royal Institute of Technology, Stockholm, Sweden, 2017.
- Jens Ponitka, Oliver Arendt, Volker Lenz, Jaqueline Daniel-Gromke, Walter Stinner, Andreas Ortwein, Martin Zeymer, Arne Gröngroft, Franziska Müller-Langer, Marco Klemm, Julian Braun, Walther Zeug, Daniela Thrän, Sinéad O’Keeffe, and Markus Millinger. *Focus on: Bioenergy-Technologies: Conversion pathways - towards biomass energy use in the 21st century*. DBFZ, Leipzig, 2 edition, 2016. ISBN 2192-1156.

- Alexander Popp, Michael Krause, Jan Philipp Dietrich, Hermann Lotze-Campen, Marian Leimbach, Tim Beringer, and Nico Bauer. Additional CO<sub>2</sub> emissions from land use change — Forest conservation as a precondition for sustainable production of second generation bioenergy. *Ecological Economics*, 74:64–70, 2012. ISSN 09218009. doi: \url{10.1016/j.ecolecon.2011.11.004}.
- A. J. Ragauskas. The Path Forward for Biofuels and Biomaterials. *Science*, 311(5760):484–489, 2006. ISSN 0036-8075. doi: \url{10.1126/science.1114736}.
- Johan Rockström, Owen Gaffney, Joeri Rogelj, Malte Meinshausen, Nebojsa Nakicenovic, and Hans Joachim Schellnhuber. A roadmap for rapid decarbonization. *Science*, 355(6331):1269–1271, 2017. ISSN 0036-8075. doi: \url{10.1126/science.aah3443}.
- Wolf-Peter Schill. *Residual Load and Storage Requirements for Renewable Integration in Germany*. German Institute for Economic Research - DIW, Berlin, 2013. ISBN 1433-0210.
- Timothy D. Searchinger, Ralph Heimlich, R. A. Houghton, Fengxia Dong, Amani Elobeid, Jacinto Fabiosa, Simla Tokgoz, Dermot J. Hayes, and Tun-Hsiang Yu. Use of U.S. Croplands for Biofuels Increases Greenhouse Gases Through Emissions from Land-Use Change. *Science*, 319(5867):1238–1240, 2008. ISSN 0036-8075. doi: \url{10.1126/science.1151861}.
- Stephanie Y. Searle and Christopher J. Malins. Will energy crop yields meet expectations? *Biomass and Bioenergy*, 65:3–12, 2014. ISSN 09619534. doi: \url{10.1016/j.biombioe.2014.01.001}.
- Sara Alongi Skenhall, Göran Berndes, and Jeremy Woods. Integration of bioenergy systems into UK agriculture—New options for management of nitrogen flows. *Biomass and Bioenergy*, 54:219–226, 2013. ISSN 09619534. doi: \url{10.1016/j.biombioe.2013.04.002}.
- Michael Sterner. *Bioenergy and renewable power methane in integrated 100% renewable energy systems: Limiting global warming by transforming energy systems: Zugl.: Kassel, Univ., Diss., 2009*. Kassel Univ. Press, Kassel, 2009.
- Nora Szarka, Marcus Eichhorn, Ronny Kittler, Alberto Bezama, and Daniela Thrän. Interpreting long-term energy scenarios and the role of bioenergy in Germany. *Renewable and Sustainable Energy Reviews*, 68: 1222–1233, 2017. ISSN 13640321. doi: \url{10.1016/j.rser.2016.02.016}.
- Philip Tafarte, Subhashree Das, Marcus Eichhorn, and Daniela Thrän. Small adaptations, big impacts: Options for an optimized mix of variable renewable energy sources. *Energy*, 72:80–92, 2014. ISSN 03605442. doi: \url{10.1016/j.energy.2014.04.094}.
- Daniela Thrän, Thilo Seidenberger, Jürgen Zeddies, and Ruth Offermann. Global biomass potentials — Resources, drivers and scenario results. *Energy for Sustainable Development*, 14(3):200–205, 2010. ISSN 09730826. doi: \url{10.1016/j.esd.2010.07.004}.
- Daniela Thrän, Oliver Arendt, Martin Banse, Julian Braun, Uwe Fritsche, Sven Gärtner, Klaus J. Henning, Katja Hünneke, Markus Millinger, Jens Ponitka, Nils Rettenmaier, Rüdiger Schaldach, Jan Schüngel, Bernhard Wern, and Verena Wolf. Strategy Elements for a Sustainable Bioenergy Policy Based on Scenarios and Systems Modeling: Germany as Example. *Chemical Engineering & Technology*, 40(2): 211–226, 2017. ISSN 09307516. doi: \url{10.1002/ceat.201600259}.
- David Tilman, Jason Hill, and Clarence Lehman. Carbon-Negative Biofuels from Low-Input High-Diversity Grassland Biomass. *Science*, 314(5805):1598–1600, 2006. ISSN 0036-8075. doi: \url{10.1126/science.1133306}.
- David Tilman, Robert Socolow, Jonathan A. Foley, Jason Hill, Eric D. Larson, Lee R. Lynd, Stephen Pacala, John Reilly, Timothy D. Searchinger, Chris Somerville, and Robert Williams. Beneficial Biofuels—The Food, Energy, and Environment Trilemma. *Science*, 325(5938):270–271, 2009. ISSN 0036-8075. doi: \url{10.1126/science.1177970}.
- Julia Tomei and Richard Helliwell. Food versus fuel? Going beyond biofuels. *Land Use Policy*, 56:320–326, 2016. ISSN 02648377. doi: \url{10.1016/j.landusepol.2015.11.015}.
- UNFCCC. *Adoption of the Paris Agreement: FCCC/CP/2015/L.9/Rev.1*. United Nations Framework Convention on Climate Change, 2015.
- Bob van der Zwaan, Ilkka Keppo, and Filip Johnsson. How to decarbonize the transport sector? *Energy Policy*, 61:562–573, 2013. ISSN 0301-4215. doi: \url{10.1016/j.enpol.2013.05.118}.
- Adam Vaughan. Global carbon dioxide levels break 400ppm milestone. *The Guardian*, May 6, 2015, 2015.
- Carl-Philipp Witzel and Robert Finger. Economic evaluation of Miscanthus production – A review. *Renewable and Sustainable Energy Reviews*, 53:681–696, 2016. ISSN 13640321. doi: \url{10.1016/j.rser.2015.08.063}.
- Harald von Witzke, Steffen Noleppa, Inga Zirkova, Tanja Dräger de Teran, and Thomas Köberich. *Meat eats land*. WWF Germany, Berlin, 2011.
- WWF. *Zukunft Stromsystem: Kohleausstieg 2035 - vom Ziel her denken*. World Wildlife Foundation, Berlin, 2017. ISBN 978-3-946211-07-5.

# Contribution to Appended Papers

The authors' contribution to the work reported in the appended papers were as follows:

**I** Millinger, M., Ponitka, J., Arendt, O. and Thrän, D. (2017) *Competitiveness of advanced and conventional biofuels: Results from least-cost modelling of biofuel competition in Germany*. Energy Policy. 107, 394-402.

Millinger had the idea, developed the model, carried out all the modelling and calculations and wrote the paper. Ponitka and Arendt provided feedback on the model, data and manuscript. Thrän provided expert guidance and feedback on the model results and manuscript.

**II** Millinger, M. and Thrän, D. (2016) *Biomass price developments inhibit biofuel investments and research in Germany: The crucial future role of high yields*. Journal of Cleaner Production. In Press.

Millinger had the idea, developed the model, carried out all the modelling and calculations and wrote the paper. Thrän provided feedback on the manuscript.

**III** Millinger, M., Meisel, K., Budzinski, M. and Thrän, D. (submitted) *Relative greenhouse gas abatement cost competitiveness development of biofuels in Germany*.

Millinger had the idea, developed the model, carried out all the modelling and wrote the paper. Meisel provided LCA and legislature expert feedback and contributed to the GHG calculations as well as to the new goal function. Budzinski provided some LCA data and feedback on the manuscript. Thrän provided feedback on the manuscript.

**IV** Millinger, M., Meisel, K. and Thrän, D. (submitted) *Climate optimal deployment of biofuels from crops in Germany*.

Millinger had the idea, developed the model, carried out all the modelling and calculations and wrote the paper. Meisel provided LCA expert and manuscript feedback. Thrän provided feedback on the manuscript.



## Part II

# Appended papers





## Paper 1

# Competitiveness of advanced and conventional biofuels: Results from least-cost modelling of biofuel competition in Germany

Millinger, M., Ponitka, J., Arendt, O. and Thrän, D.

*Energy Policy* (2017), 107, 394-402.

*Reproduced with kind permission from Elsevier*



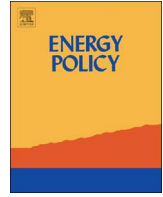

# Competitiveness of advanced and conventional biofuels: Results from least-cost modelling of biofuel competition in Germany



M. Millinger<sup>a,\*</sup>, J. Ponitka<sup>b</sup>, O. Arendt<sup>b</sup>, D. Thrän<sup>a,b</sup>

<sup>a</sup> Dep. of Bioenergy, Helmholtz Centre for Environmental Research - UFZ Permoserstraße 15, 04318 Leipzig, Germany

<sup>b</sup> Dep. of Bioenergy Systems, Deutsches Biomasseforschungszentrum - DBFZ Torgauer Straße 116, 04347 Leipzig, Germany

## ARTICLE INFO

### Keywords:

Biofuels  
Technological learning  
Modelling  
2nd generation  
Advanced biofuels  
Methane

## ABSTRACT

Techno-economic variables for advanced biofuels produced from lignocellulosic biomass have been scrutinized and combined with a newly developed transparent model for simulating the competitiveness between conventional and advanced biofuels for road transport in the medium to long term in Germany. The influence of learning effects and feedstock cost developments has been highlighted, including also gaseous fuels. Thorough sensitivity analyses were undertaken. Previously reported cost assumptions for advanced biofuels were found to have been too optimistic. The most cost-competitive biofuels for most of the time period remained conventional biodiesel and bioethanol, but the costs of these options and biomethane and Synthetic Natural Gas (bio-SNG) converged in the medium term and thus other factors will play a decisive role for market developments of biofuels. Feedstock cost uncertainties for the future remain a challenge for long-term planning, and low-cost short-rotation coppice may change the picture more than any other parameter. Of the advanced biofuels, bio-SNG was found significantly more cost-competitive and resource efficient than Fischer-Tropsch-diesel and lignocellulose-based ethanol, but still requiring a dedicated long-term policy. The results and the large sensitivities of biofuel competitiveness stress the need for more data transparency and for thorough sensitivity analyses of the results in similar system studies.

## 1. Introduction

Global concern for climate change calls for alternatives in the transport sector, which accounts for 14% of global anthropogenic (IPCC, 2014) and 20% of German GHG-emissions (BMWi, 2013). Germany aims to reduce transport emissions by 6% until 2020 (BImSchG, 2014), with subsequent further emission reductions required in order to meet overall climate targets (UNFCCC, 2015). Aside from demand reduction and modal shift, biofuels and a switch to electric mobility are the main renewable solutions for road transport, with biofuels fitting comparably well into the current vehicle fleet.

The presently dominant biofuels in the German road transport sector are biodiesel from oil bearing crops and bioethanol from sugar beet or grains. These conventional biofuels compete with food production (see e.g. Foley et al., 2011) and have a limited GHG-abatement even when excluding indirect land use effects (Cherubini et al., 2009). Advanced biofuels derived from biomass with a high share of cellulose, hemicellulose and/or lignocellulose potentially avoid these problems and are thus often proposed as a solution, with promising future cost estimates reported (Chum et al., 2011, p.282; Eisentraut et al., 2011,

p.32; IEA, 2008, p.335). However, to date advanced biofuels have not yet become commercially available, and large-scale attempts have failed (Hogan, 2011).

The capital investment and production costs of advanced biofuels have been subject to a large range of estimates (Haarlemmer et al., 2012). The future cost development is subject to the development of feedstock costs and to learning effects, both being uncertain. At any point in time, the biofuel options are also subject to competition between each other to fulfill biofuel mandates. Yet - to our knowledge - the effect of these uncertainties on cost developments and competitiveness of biofuels have not been thoroughly assessed before.

There is a large number of future modelling studies including biofuels, with a wide array of different scopes and results (Börjesson et al., 2013). The models are often large and the focus often on whether to use biomass in the power or transport sector (as Martinsen et al. (2010) did for Germany) and thus the techno-economic details of the different biofuels have not been central (Börjesson et al., 2013). Wit et al. (2010) performed a modelling study including learning and competition between biofuels for transport in Europe. However, the model did not build the yearly development on prevalent capacities,

\* Corresponding author.

E-mail address: [markus.millinger@ufz.de](mailto:markus.millinger@ufz.de) (M. Millinger).

thus missing out on path-dependencies, gaseous biofuels were excluded and advanced liquid fuels were seemingly assumed to be lower cost than conventional biofuels already from the beginning of the time-period, indicating a need for further scrutiny of the data basis. Most other models are optimisation models with perfect foresight, thus losing information regarding learning effects and path dependencies, which are of value to policy makers. Also, there is a lack of thorough sensitivity assessments to results in energy systems modelling (Hedenus et al., 2012). This is perhaps of particular importance in the bioenergy sector, which is subject to influence from numerous parameters.

To address the open points mentioned above, a sound data set has been developed and used as a basis for a newly developed least-cost myopic simulation model in order to answer the research question: Which liquid or gaseous biofuel options from domestic biomass are potentially most cost-competitive in Germany in the medium to long term?

## 2. Methodology, scenarios and data

Three pathways of conventional biofuels (biomethane produced from maize, bioethanol from sugar beet and biodiesel from rape seed) and three pathways as advanced biofuel counterparts (Synthetic Natural Gas (bio-SNG), bioethanol from lignocellulosic biomass (Ligno-EtOH) and Biomass-to-Liquid (BtL)/Fischer-Tropsch (FT)-diesel, all produced from biomass with high lignocellulosic content) were included in the simulation. All biofuels were assumed to be equivalent at the end user stage (with some differences regarding transport and storage costs).

Vehicle costs are neglected in this paper, as various and possibly fuel type specific strategies for implementing biofuels can be foreseen in a likely rapidly changing market (see e.g. Economist (2016)), which highly affect vehicle usage rates and efficiencies and have large consequences for the vehicle cost added to the fuel cost.

Germany has relatively much experience with the conventional biofuel options biomethane, bioethanol and biodiesel, the data for which are elaborated in Thrän et al. (2015). For advanced biofuel options there is less experience, why a literature review was additionally performed in order to come up with estimates for techno-economic parameters. All costs used in the modelling were converted to €<sub>2010</sub>.

### 2.1. Model description

In order to model the competition between different technology options, a simulation model has been developed. BENSIM (BioENergy Simulation Model) is a myopic recursive dynamic bottom-up least-cost simulation model with endogenous technological learning, seeking the least-cost mix of biofuel production options on a yearly basis for fulfilling a set demand. Through the recursive elements of learning effects and previously built capacities, path dependencies can be captured by the model.

The existing biofuel plant infrastructure in the region in focus (here Germany) is the basis at the starting point of the modelling. For each year of the simulation, BENSIM starts by removing the plants that have reached the end of their life-time (capacities present at the beginning are assumed to be decommissioned linearly over the life-time of the plants). In the next step, the technology options are sorted in the orders of total costs (TC; Eq. (1)) and in merit order after marginal costs (MC; Eq. (2)). A given biofuel demand sets the limit for the production and is also the basis for calculating a minimum market price ( $p_{sys}$ ), defined by the MC of the most expensive option in the merit order which is put into production. If there are options which have TC lower than the  $p_{sys}$ , capacity investments<sup>1</sup> take place, beginning with the option with the

lowest TC.

This continues until the market price adjusts on a level below the TC of still available options and the system reaches a (partial) equilibrium. In order to account for e.g. regional differences, investment risk behaviour and market imperfections, options with TC within 10% of the least-cost alternative are treated equally with the least-cost option, i.e. they are also invested in during the same round. There are no capacity expansion constraints in relation to previously built capacities.

After the investment phase, biofuel production takes place following the merit order based on marginal costs of production, until the hypothetical biofuel target is fulfilled (and/or until a given biomass potential is exhausted). In the following year, the technology options that experienced an expansion are subject to learning effects, reducing the investment costs by the learning rate for each doubling of capacity. The options which were not expanded experience “exogenous” learning through a research and development mechanism, defined as one learning rate unit in a specified number of years.

Eq. (1) shows the investment cost  $I_j^{(t)}$  [€ GJ<sub>fuel</sub><sup>-1</sup>] for technology  $j$  at timepoint  $t$  as a relationship of the initial investment cost  $I_j^{(0)}$  [€ GJ<sub>fuel</sub><sup>-1</sup> converted from € MW<sub>cap, fuel</sub><sup>-1</sup>] with an assumed capacity factor  $C_{f,j}$  and an annuity factor with an assumed discount rate  $i$  over a set time-span  $T$ , including a learning effect by a learning rate  $LR_j$  with increasing cumulative production capacity  $k_j^{(t)}$  divided by the initial capacity  $k_j^{(0)}$  (see Grubler (1998, p81ff) and IEA (2000)). This relationship holds with the assumption that relative expansion in the region in focus (Germany) is equal to the relative expansion globally. In order to have a nonzero denominator, a virtual initial capacity  $k_j^{(0)}$  for options not presently at the market is set at 2 PJ in this paper, whereas actual initial capacities are set to zero. As the starting capacity for these options is relatively small, the capacities multiply relatively quickly in case of investments and thus can experience substantial learning.<sup>2</sup>

$$I_j^{(t)} = \frac{I_j^{(0)} i (1+i)^T}{C_{f,j} (1+i)^T - 1} \left( \frac{k_j^{(t)}}{k_j^{(0)}} \right)^{-\log_2(1-LR_j)} \quad (1)$$

$$MC_j^{(t)} = c_{om,j}^{(t)} + \frac{p_{f_2}^{(t)}}{e_f \eta_j^{(t)}} + p_{f_2}^{(t)} \dot{m}_{f_2,j} + p_{el}^{(t)} \dot{m}_{el,j} + p_{th}^{(t)} \dot{m}_{th,j} + c_{log,j}^{(t)} - p_{bp,j}^{(t)} \dot{m}_{bp,j} + p_{CO_2}^{(t)} \dot{m}_{CO_2,j} \quad (2)$$

Eq. (2) shows the marginal cost  $MC_j^{(t)}$  [€ GJ<sub>fuel</sub><sup>-1</sup>] for technology  $j$  at timepoint  $t$  as a sum of operation and maintenance costs and personnel costs  $c_{om,j}^{(t)}$ , costs for main feedstock ( $p_{DM}^{(t)}$  [€ t<sub>DM</sub><sup>-1</sup>] divided by feedstock specific energy content  $e_f$  [GJ t<sub>DM</sub><sup>-1</sup>] and conversion efficiency  $\eta_j^{(t)}$ ), secondary inputs  $p_{f_2}^{(t)}$  [€ t<sup>-1</sup>], electricity ( $p_{el}^{(t)}$  [€ kWh<sup>-1</sup>] multiplied by amount required,  $\dot{m}_{el,j}$  [kWh GJ<sup>-1</sup>]), process heat ( $p_{th}^{(t)}$  [€ kWh<sup>-1</sup>] multiplied by amount required,  $\dot{m}_{th,j}$ ), logistic cost  $c_{log,j}^{(t)}$ , a credit for by-products  $p_{bp,j}^{(t)}$  and a cost of GHG-emissions (the price of emissions  $p_{CO_2}^{(t)}$  multiplied by amount emitted  $\dot{m}_{CO_2,j}$ ).

Eq. (3) shows the constitution of total costs as a sum of investment and marginal costs.

(footnote continued)

an assumption which enables a competition on equal terms. Typical plant sizes for the included options range between 7–250 MW (Ponitka et al., 2016) and thus the model units do not correspond to whole plants, but in some cases more and in some less. However, as the additional demand to be fulfilled surpasses at least 8 PJ a<sup>-1</sup>, options with typically large plants may reach realistic capacity increments, especially when taking the development over time into account. Similarly, for options with typically small plant sizes the model unit corresponds to several plants.

<sup>2</sup> The set biofuel target influences the amount of expansion possible, thus limiting the possible cost reductions through technological learning. If the final biofuel target of 400 PJ is met by one of these technologies, about 9 virtual capacity doublings are possible, translating into a ca. 60% investment cost reduction with a 10% learning rate, which may be seen as a rather high reduction but in line with some estimates for future costs (see e.g. Haarlemmer et al. (2012) and Hamelinck et al. (2005)).

<sup>1</sup> Investments take place in units of 1 PJ<sub>cap</sub> a<sup>-1</sup> (ca 35MW<sub>cap</sub> at 8000 full-load hours),

$$TC_j^{(t)} = I_j^{(t)} + MC_j^{(t)} \quad (3)$$

Technologies are assumed to improve their efficiencies linearly, with the end-point being set as a technical limit, to be reached in 2050. Initial plant investment costs are set per unit output in the starting year with further investment cost developments being independent of the efficiency improvements (*ceteris paribus*, this would mean that plant prices per input feedstock increase in line with the efficiency improvement, the sum being zero).

Economies of scale are applicable to biofuel plants, with larger plants having lower relative investment costs (see e.g. Lange, 2001; Bridgwater, 2009). However, the counteracting effect of feedstock availability and supply-chains affects the optimal sizing of a plant and is site specific, for which a more spatially detailed model would be appropriate. Thus, costs for relatively large-scale plants are assumed from the beginning of the simulation and economies of scale are not explicitly highlighted in the modelling.

In principle, other flows can be included, one notable example being life-cycle emission data. These can be coupled with a GHG-cost to indicate the competitiveness including such effects. A thorough analysis of GHG abatement potentials of the biofuel options (which are highly uncertain due to their sensitivity to highly varying assumptions along the pathway) is beyond the scope of this paper, and therefore greenhouse gases are only considered tentatively in one sensitivity run. Future extensions and applications of the model will have to cover this crucial aspect more in detail, as greenhouse gas abatement is the main objective of introducing biofuels in Germany.

## 2.2. Data

Techno-economic data for advanced biofuel options are presented in detail, with a summary of all data used at the end of this section.

### 2.3. Initial ligno-cellulosic feedstock cost

Short-rotation coppice (SRC) is a promising and potentially high-yielding source of ligneous biomass. Faasch and Patenaude (2012) estimate production costs for SRCs in Germany of  $58\text{€ t}_{DM}^{-1}$ , which would set a minimum, break-even selling price. For a farmer to decide to grow SRCs however, the profit per hectare would need to at least match that of other possible options. For instance, at wheat prices of  $140\text{€ t}^{-1}$ , the minimum selling price for wood chips from SRCs would be around  $100\text{€ t}_{DM}^{-1}$  in order for it to be the more profitable alternative (Schaeff, 2007). Wheat cost  $203\text{€ t}^{-1}$  on average on the world market in 2014 (World Bank, 2016), which would increase the minimum selling price of SRCs further. In 2015, SRC wood chips cost  $131\text{€ t}_{DM}^{-1}$  ( $122\text{€}_{2010} \text{ t}_{DM}^{-1}$ ), lower than forest wood chips, at  $153\text{€ t}_{DM}^{-1}$  (CARMEN, 2015).

Thus, an initial wood chip price of  $122\text{€ t}_{DM}^{-1}$  ( $6.6\text{€ GJ}^{-1}$ ) is assumed. This can be compared to assumptions between  $2\text{€ GJ}^{-1}$  and  $5\text{€ GJ}^{-1}$  in other biofuel studies reviewed by Sunde et al. (2011).

#### 2.3.1. Investment costs for advanced biofuels

Haarlemmer et al. (2012) reviewed 14 studies on thermochemical FT-diesel production from biomass published between 2000 and 2011, concluding that the depreciable investment cost is likely to be toward the upper limit of a range of between  $1.25$  and  $2.5\text{M€}_{2011} \text{ MW}_{cap}^{-1}$ . Bridgwater (2009) analysed 23 data sets for BtL plants and came up with a relationship according to plant size (Eq. (4)), which renders the investment costs in Table 1, where the costs for the  $400\text{MW}_{cap}$  plant are comparable to those in Haarlemmer et al. (2012). Bridgwater (2009, p.24.) also contends that the investment costs for new technologies are invariably underestimated.

$$I_c = 0.535 \cdot (\dot{m}_{fuel,out})^{0.574} \quad (4)$$

Lange (2001) has proposed some simple methodologies for esti-

**Table 1**

Investment costs for BtL plants of different sizes according to Bridgwater (2009). For the conversion from  $\text{MW}_{cap}$  to liquid hydrocarbons, a lower heating value of  $42\text{GJ t}^{-1}$  and a capacity factor of 1 have been assumed. Costs have been converted to  $\text{€}_{2010}$ .

$\text{MW}_{cap}$	Hydrocarbon [ $\text{kt a}^{-1}$ ]	Cost (Eq. (4)) [M€]	$\text{M€}_{2010} \text{ MW}_{cap}^{-1}$
20	15	134	6.6
100	75	336	3.3
200	150	501	2.5
400	300	746	1.8
1000	750	1262	1.2

imating investment costs for thermo-chemical plants, one being based on heat of reaction, using the total energy loss of a process<sup>3</sup> (Eq. (5))

$$I_c = 3.0 \cdot (h_{LHV,in,feed} - h_{LHV,out,fuel})^{0.84} \quad (5)$$

In combination with process efficiencies of between  $34.6 - 46.7\%$  (see below), the investment cost of a BtL plant using Eq. (5) would amount to between  $2.0 - 2.4\text{M€ MW}_{cap}^{-1}$ . Similarly, a bio-SNG plant with process efficiencies of between  $57.9 - 72.6\%$  would have an investment cost of  $1.2 - 1.7\text{M€ MW}_{cap}^{-1}$ .

Although the initial costs may be higher for the first commercial plants,  $2.5\text{M€ MW}_{cap}^{-1}$  is used as a conservative base assumption. For bio-SNG plants, the investment cost is set at  $2\text{M€ MW}_{cap}^{-1}$ , due to higher conversion efficiencies.

Initial investment costs of Ligno-EtOH plants have been reviewed and estimated at  $2.1\text{M€}_{2003} \text{ MW}_{cap,HHV}^{-1}$  (Hamelinck et al., 2005), corresponding to  $2.7\text{M€}_{2010} \text{ MW}_{cap,LHV}^{-1}$ .

#### 2.3.2. Technological learning

The rate at which investment costs are reduced with increasing experience is an uncertain and highly sensitive parameter in modelling (Yeh and Rubin, 2012). Lacking historical data, learning rates for plant investments are estimated according to the maturity and complexity of the technologies.

Biomethane, bioethanol and biodiesel are mature and relatively simple technologies, with large installed capacities in Germany and world-wide. Bio-SNG, Ligno-EtOH and BtL on the other hand have not yet been introduced on a commercial scale. The SNG and BtL processes have however been used since the first half of the 20th century, albeit with fossil coal as feedstock (Dry, 2002), and can thus not be said to be new and unproven technologies (Sims and Taylor, 2008). However, as the processes have not been applied on a large scale and as energy companies particularly in Germany have little experience with these technologies, some learning can be expected. As a basis for simulations, learning rates of  $5\%$  for the conventional options are used (in line with Neij, 2008; Chen et al., 2012). With the above reasoning, we assume somewhat higher learning rates for the advanced options, at  $10\%$ .

#### 2.3.3. Conversion efficiencies for advanced biofuels

Conversion efficiencies of advanced biofuels are subject to theoretical limits which are dependent on the feedstock used, but give an orientation for what can be realistically expected. Müller-Langer (2011, p.8 & 166ff) arrives at a theoretical limit of  $49\%$  for BtL,  $90\%$  for bio-SNG and  $66\%$  for Ligno-EtOH, using standard enthalpies of formation with willow as feedstock. Hamelinck et al. (2005) reports a theoretical limit of  $52\%$  for Ligno-EtOH on a HHV basis, corresponding to  $49.7\%$  on a LHV basis.<sup>5</sup> Process simulations give lower estimates, ranging from  $34.6\%$  to  $46.7\%$  for BtL,  $57.9 - 72.6\%$  for bio-SNG and  $36.3 -$

<sup>3</sup> with the addition of a Chemical Engineering Plant Cost Index (CEPCI, 2015) between 1993 and 2010 of  $550.8/359.2 = 1.53$  and a subsequent conversion to  $\text{€}$

<sup>4</sup> Using the CEPCI (2015) for 2003 of 402 (with a previous conversion to  $\text{\$}_{2003}$  and a subsequent conversion back to  $\text{€}_{2010}$ ) as well as  $26.95\text{MJ}_{LHV} \text{ kg}_{DM}^{-1}$  and  $29.85\text{MJ}_{HHV} \text{ kg}_{DM}^{-1}$  for ethanol

<sup>5</sup> Assuming  $18.5\text{MJ}_{LHV} \text{ kg}_{DM}^{-1}$  and  $19.6\text{MJ}_{HHV} \text{ kg}_{DM}^{-1}$  for the lignocellulosic feedstock

**Table 2**

Conversion efficiencies of BtL, bio-SNG and Ligno-EtOH processes from process simulations. The values from Hamelinck et al. (2005) were converted to an LHV basis.

Fuel	$\eta$	Sources
BtL	34.6%, 42.1%, 46.7%	Prins and Ptasiński (2005), Manganaro et al. (2011), Tijmens (2002)
Bio-SNG	57.9%, 70.3%, 72.6%	Duret et al. (2005), van der Meijden et al. (2010), Juraščík et al. (2009)
Ligno-EtOH	36.3–44.0%	Hamelinck et al. (2005)

**Table 3**

Cost, material and energy flow summary for the biofuel options in this study. Data for the conventional biofuels (biomethane, bioethanol and biodiesel) are taken unchanged from Thrän et al. (2015) unless otherwise noted. Equal capacity factors (0.91 or 8000 full-load hours) and plant life times (25 years) have been assumed for all technologies. Maintenance costs are assumed at an annual 4% of the investment cost and operational costs at 15% of maintenance costs, throughout all options. Only byproducts with an assumed significant market value are shown here. Net power input for BtL has been halved compared to Thrän et al. (2015) in order to relativise the effect of this parameter, for Ligno-EtOH the value has been reduced to be the same as for BtL, whereas for bio-SNG the former value has been kept. The advanced options are assumed to be self-sufficient in their heat demand. GHG emissions for conventional biofuels were taken from EU RED values (EU, 2009). For BtL and Ligno-EtOH, a review by Menten et al. (2013) has been used (mean values 19.45 and 19.7 tCO<sub>2eq</sub> GJ<sup>-1</sup>, respectively) and for bio-SNG the value for BtL was used as an approximation and for biomethane Westerkamp et al. (2014) was used. Transport and storage (logistics) costs stem from Cazzola et al. (2013). Unless otherwise noted, the values given are the initial values used in the modelling, per GJ<sub>fuel</sub>.

Fuel		Biomethane	Bioethanol	Biodiesel	BioSNG	Ligno-EtOH	BtL
Feedstock		Maize silage	Sugar beet	Rape seed	Wood	Wood	Wood
Energy content	GJ t <sup>-1</sup> <sub>DM</sub>	17	16.3	26.5	18.5	18.5	18.5
Cost	€ t <sup>-1</sup> <sub>DM</sub>	106	116	366	122	122	122
Conv. eff. (init.)	$\eta$	0.56	0.6	0.59	0.58	0.36	0.35
Conv. eff. (final)	$\eta$	0.70	0.66	0.62	0.73	0.44	0.45
2 <sup>nd</sup> feed.		–	–	Methanol	–	–	–
Amount	GJ <sup>-1</sup>	–	–	3.3 kg <sub>DM</sub>	–	–	–
Cost	€ t <sup>-1</sup>	–	–	250	–	–	–
Net heat input	kWh GJ <sup>-1</sup>	0	69	34.8	0	0	0
Net power input	kWh GJ <sup>-1</sup>	22	17.3	3.1	31	35	35
1 <sup>st</sup> byprod.		–	Vinasse	Rape seed meal	–	–	–
Amount	GJ <sup>-1</sup>	–	23.7 kg <sub>FM</sub>	33 kg <sub>DM</sub>	–	–	–
Credit	€ t <sup>-1</sup>	–	70	211	–	–	–
2 <sup>nd</sup> byprod.		–	–	Pharmaglycerine	–	–	–
Amount	GJ <sup>-1</sup>	–	–	2.5 kg <sub>DM</sub>	–	–	–
Credit	€ t <sup>-1</sup>	–	–	600	–	–	–
Tot. credit	€ GJ <sup>-1</sup>	0	1.7	8.4	0	0	0
GHG emissions	kgCO <sub>2eq</sub> GJ <sup>-1</sup>	23.7	40	52	18.7	26.6	18.7
Investment cost	€ kW <sup>-1</sup> <sub>cap</sub>	1600	900	240	2000	3200	2500
Learning rate	%	5	5	5	10	15	10
Capacity	PJ <sub>cap</sub>	22.4	33.1	195	0	0	0
Staff cost	€ GJ <sup>-1</sup>	0.7	0.6	0.3	1.0	1.1	0.6
Transport cost	€ GJ <sup>-1</sup>	1.7	2.6	1.2	1.7	2.6	2.4
Storage cost	€ GJ <sup>-1</sup>	2.2	0.08	0.06	2.2	0.07	0.05

44.0% for Ligno-EtOH (Table 2). In this study, the lower process simulation results are used for the initial conversion efficiencies, increasing linearly towards the higher ones in 2050.

### 2.3.4. Logistic costs

For logistic costs, the average of the “current” (high) and “mature” (low) cost scenarios for fuel transport, distribution and refuelling infrastructure found in Cazzola et al. (2013) are used. These costs are mostly relevant for methane, as they are much higher than for liquid biofuels in the “current” scenario (which is not Germany specific). As methane as a fuel is relatively widespread in Germany, with 879 fuelling stations (Statista, 2015) of ca 14500 in total (EID, 2015), the needed minimum infrastructure is assumed to be at hand.

### 2.3.5. Data summary

The techno-economic data for all biofuel options in this study are summarized in Table 3.

## 2.4. Scenarios

With the techno-economical data as a basis, two base scenarios are modelled: (i) where all biofuels were considered equal from the

demand side, and (ii) where only liquid biofuels were considered. As methane is neglected as an option in many studies, the comparability to these studies is better in the liquid biofuels only case.

For all scenarios, a continuously increasing amount of biofuels in the transport sector is assumed, rising from current 119PJ (BMWi, 2016) to 400PJ by 2050, corresponding to 16% of the current end energy demand of the German transport sector and in line with sustainable agricultural biofuel potentials (Simon and Wiegmann, 2009) and long-term strategies (Pregger et al., 2013).

The prices of rape seed and wheat in Germany increased by on

average 2.1% a<sup>-1</sup> and 2.4% a<sup>-1</sup>, respectively, between 2009–2015,<sup>6</sup> whereas the prices for wood pellets and wood chips in Germany during the same time period increased by 5.1% a<sup>-1</sup> and 4.9% a<sup>-1</sup>, respectively.<sup>7</sup> SRCs could possibly dampen the steep price increase but are also connected to a counteracting long-term investment risk for the farmer (Ericsson et al., 2009) and are still subject to opportunity costs. The price of maize silage in Germany is set dependent on the wheat price, with an almost identical price development (Toews, 2009, p18ff.). Price setting on the German sugar market is more complicated (Georg, 2008, p8ff.), but as the maize silage and sugar beet yields are rather similar (KTBL, 2012), we assume that similar price developments compared to wheat can be expected as an approximation.

In keeping with the logic of favouring the advanced options where there is data uncertainty, we assume all feedstock costs to increase by 2% a<sup>-1</sup>. An increase is assumed, as this is consistent with the increased demand for biomass as a consequence of the full-scale energy transition which biofuels would likely be part of. Prices for secondary inputs

<sup>6</sup> Using price information from finanznet (2016), which was subsequently inflation adjusted

<sup>7</sup> Using price information from CARMEN (2015), subsequently inflation adjusted



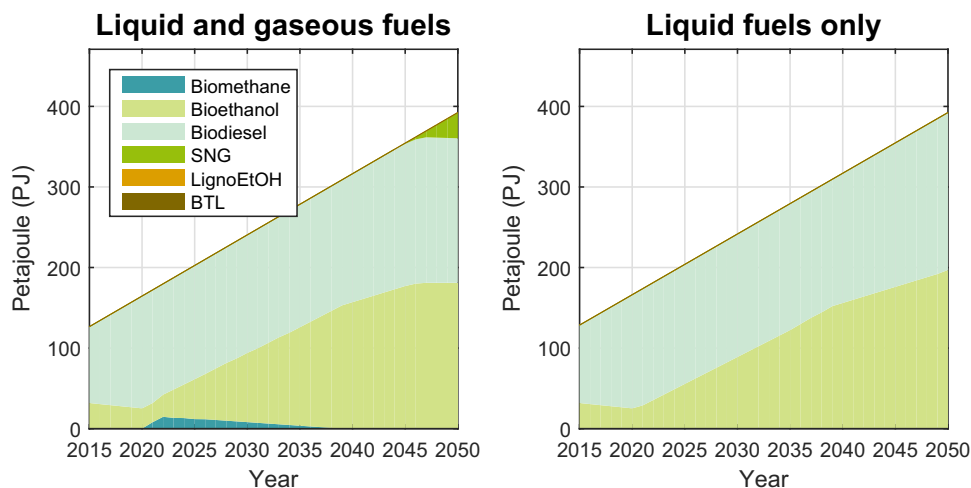

Fig. 1. Resulting production structures of biofuels from the modelling of the two main scenarios.

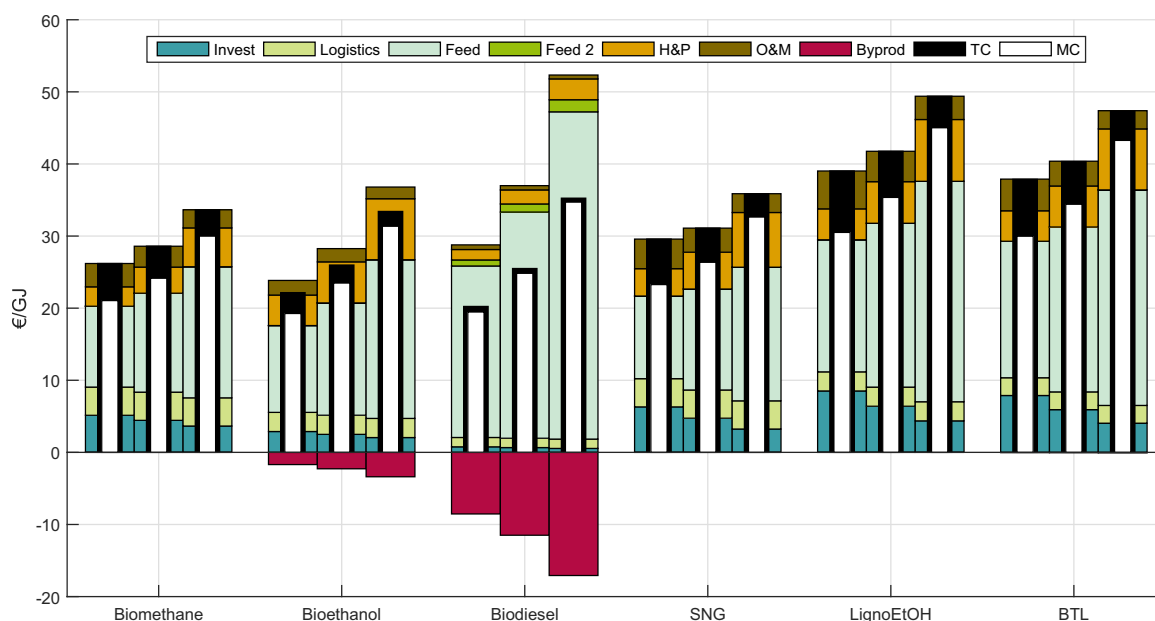

Fig. 2. Cost structures for the different options for the years 2015, 2030 and 2050, respectively. Abbreviations: Invest=investment cost; Logistics=logistic cost; Feed=main (biogenic) feedstock cost; Feed 2=secondary feedstock cost (i.e. methanol for biodiesel); H & P=heat and power; O & M=operation and maintenance; Byprod=by-product credit; TC=total cost; MC=marginal cost.

(including heat and power) and by-products are assumed to develop in parity with the other feedstock prices.

A discount rate of 7% with a payback time of 20 years is used (a medium assumption, see Chum et al., 2011, for a comparison of the effect of different discount rates). One could argue that the advanced options carry more risk and would therefore require higher discount rates than the other options. Also in this case, we choose not to discriminate between the options and thereby favour the advanced options. R & D-learning is set at a rate of one learning rate (technology specific) for each five years. All costs in the modelling are in €<sub>2010</sub> and inflation is excluded. In order for the results for cost-competitiveness to be as transparent as possible, we do not include restrictions and quota from current biofuel policy.

### 3. Results and discussion

The results for the modelling of the two main scenarios can be seen in Fig. 1. Biodiesel starts off as the least-cost fuel (starting at 20.2€ GJ<sup>-1</sup> in 2015, with the costs increasing by 74% until 2050), followed by bioethanol (22.2€, increasing by 51%), biomethane (26.2€,

28%), bio-SNG (29.6€, 21%), ligno-EtOH (39.0€, 27%) and BtL (37.9€, 25%). Fig. 2 shows the cost break-downs and developments over time.

In both scenarios bioethanol and biodiesel virtually share the market, purely due to similar costs (there are no assumed quota for different biofuel options in the scenarios). In the case where gaseous fuels are included, some biomethane and bio-SNG can be seen, but the proportion is small and bio-SNG increases only towards the very end of the time span, resulting in a small total share of gaseous biofuels over the whole time period. In the case where gaseous biofuels are excluded, notably no advanced biofuels show up.

Interestingly, the total costs of the first four options largely converged around 30€ GJ<sup>-1</sup> in the 2040s (Fig. 2). Learning effects can be observed for all options, being largest for the advanced biofuels, the investment cost of which are almost halved over the time period. Despite investment cost reductions and thus O & M cost reductions (due to their coupling), as well as conversion efficiency increases, no price reductions can be seen, due to increased feedstock and power costs.

The large share of power costs may motivate process-internal power

production, especially for the BtL option. In that case, there is a trade-off: fuel conversion efficiency would likely decrease and investment costs relative to the produced fuel would increase. Moreover, one can note that the biodiesel cost is dominated by the cost of rape seed. The increased price is somewhat balanced by increasing credits for the by-products, but still increased by 76% until 2050.

In this paper, economies of scale were omitted in the modelling, and the investment costs were assumed for relatively large-scale plants. The optimal sizing of plants depends on feedstock availability and cost, which are site specific attributes. Furthermore, as the included feedstocks have different energy densities and thus transport costs, the options also have differing optimal sizes, *ceteris paribus*. Economy of scale aspects are therefore mostly relevant for the advanced options, which rely on feedstocks which can potentially be viably transported over longer distances, as well as having a higher absolute investment cost reduction potential. As these options were found rather uncompetitive even with optimistic assumptions, economies of scale are not so central to the results. A spatial extension of the model would be interesting for future research on the optimal sizing of plants considering spatially explicit conditions.

The large range of investment and production cost estimates (Haarlemmer et al., 2012), uncertainties regarding learning rates (Yeh and Rubin, 2012) and the assumptions for initial feedstock costs (Sunde et al., 2011) and their future development generates a large span of possible outcomes for studies such as this one. As an example, the cost of BtL in this paper increased to 40€ GJ<sup>-1</sup> in 2030, comparable with a span of 7–26€<sub>2010</sub> GJ<sup>-1</sup> (8–30\$<sub>2005</sub> GJ<sup>-1</sup>) for 2030 in other studies (Chum et al., 2011, p.282) and 7.1–46€<sub>2010</sub> GJ<sup>-1</sup> (9.4–61\$<sub>2010</sub> GJ<sup>-1</sup>) for developing countries (van Eijck et al., 2014). Wit et al. (2010) assumed costs of lignocellulosic feedstocks to start at 1.8 €<sub>2010</sub> GJ<sup>-1</sup>, compared to 6.6€<sub>2010</sub> GJ<sup>-1</sup> in this paper and initial investment costs for FT-diesel were about half compared to in this paper. As a result, the cost of advanced liquid biofuels started off much lower than in this paper (22€<sub>2010</sub> GJ<sup>-1</sup>, compared to 37.9€ GJ<sup>-1</sup>) and then decreased due to technological learning and feedstock cost reductions, which should explain the large discrepancy in results.

### 3.1. Sensitivity analysis

In the sensitivity analysis, parameters subject to large uncertainty and/or which may affect the costs of biofuels significantly were varied. The parameters were varied in the direction for which the system is more sensitive or in which a change is more likely. The performed sensitivity analyses are summarized in Table 4:

Compared to the base case, it can be seen that the results are in fact relatively sensitive to some parameters when gaseous fuels are included (Fig. 3). However, advanced biofuel options do not appear in any large amounts in 2030, in any of the sensitivity runs, and for most cases in relatively small amounts in 2040, and thus the share over the whole time period remains rather small.

In the case of a constant biofuel target, some dynamics can be observed. Biomethane retains the same amount and biodiesel has a larger share for 2030 compared to the base case. Between 2040 and 2050 no change occurs, whereas in the base case bio-SNG increases, thus covering mainly the increased demand. Thus, as can be expected, a non-increasing biofuel target leads to a slight lock-in effect, keeping new technologies out of the market.

When the initial wood chip costs are decreased by 40%, bio-SNG increases steadily and dominates towards the end, and a similar result emerges when assuming constant wood prices, with a stronger effect towards the end of the time-period. In the case where initial investment costs for advanced biofuels are decreased, some increase of bio-SNG can be observed.

Throughout all cases, only conventional biomethane stands out as having the same absolute amount in 2030, which originates from the initially available capacity. This indicates that high investment costs

**Table 4**  
Sensitivity cases performed.

Abbreviation	Description
NoRise	Constant biofuel demand (121 PJ a <sup>-1</sup> ).
WdLow	Wood prices starting at -40%.
WdCnst	Wood prices constant at 122€ t <sup>-1</sup> <sub>DM</sub> .
Adv-25%	Initial investment costs for advanced biofuel plants - 25%
Bme-25%	Initial investment costs for conventional biomethane plants -25%
i=3%	Discount rate at 3%
LogLow	Storage and logistics costs lower (from the "mature" scenario in Cazzola et al. (2013))
LR20%	Technological learning rate for advanced options 20% (a doubling), which also doubles R & D learning.
NoR & D	No R & D learning.
$\eta_{max}$	Conversion efficiencies constant at the technical limit throughout the time period.
Feed4%	Feedstock price increase of 4% a <sup>-1</sup> .
ByCnst	Price of all byproducts constant over the time period.
GHG	GHG-price of 100€ t <sup>-1</sup> <sub>CO<sub>2</sub>eq</sub> which is added as a cost based on the GHG emissions of each option. The values are assumed constant over time.
H & PAdv	The external heat and electricity inputs to the advanced processes are reduced by half.
Combi	A combination of an initial investment cost reduction of 25%, a 20% learning rate and a constant conversion efficiency at the technical limit, for the advanced options.
Base	Base run.

deter a further break-through, and a reduction of the investment cost for conventional biomethane does in fact lead to a significant increase of the option, interestingly at the cost of mainly bio-SNG.

A decrease of the discount rate to 3% increases the amount of bio-SNG and biomethane somewhat, while decreasing the amount of biodiesel towards the end of the time-period. The initial costs are in this case reduced by 1.1% (2.0%) for biodiesel, 3.8% (6.7%) for bioethanol, 5.7% (10.0%) for biomethane, 6.1% (10.8%) for bio-SNG, 6.3% (11.0%) for Ligno-EtOH and 6.0% (10.6%) for BtL compared to with a 7% (10%) discount rate.

Decreased logistic costs from the beginning increases the amount of both bio-SNG and biomethane, as the cost reduction potential for the logistic costs of gaseous fuels is larger than for the liquid fuels. An increase of the learning rate for advanced biofuels has some effect for bio-SNG, but perhaps not as much as may have been expected. If no investment cost reduction through R & D learning is assumed to take place, bio-SNG and biomethane (apart from already present capacities) do not appear on the market. If the maximum conversion efficiencies are assumed already from the beginning for all options, a negligible increase of bio-SNG can be observed.

A feedstock cost increase of 4% has a large effect on the development towards the end, as all other fuels vanish and biomethane dominates. Holding by-product credits constant has a similar effect for the development of biomethane (the latter two are also the only cases where an unlimited diffusion rate in the modelling has a significant effect compared to a limitation to 50% new capacity per year). Thus, technology investments and improvements are highly sensitive to feedstock and by-product cost developments. As these are uncertain and volatile, this may deter investment efforts and also serve to render policy decisions uncertain.

In the case where GHG emissions are coupled with a 100€ t<sup>-1</sup><sub>CO<sub>2</sub>eq</sub> cost, both bio-SNG and biomethane increase. However, again only moderate effects can be seen until in the 2040 s. Halving the external power input requirement for the advanced biofuel options compared to the base case leads to an increase of bio-SNG, indicating that a trade-off may take place here between internal power production and high conversion efficiencies for bio-SNG. No effect can be observed for the liquid biofuels only case. A combination of investment cost decreases and learning rate and conversion efficiency increases for advanced



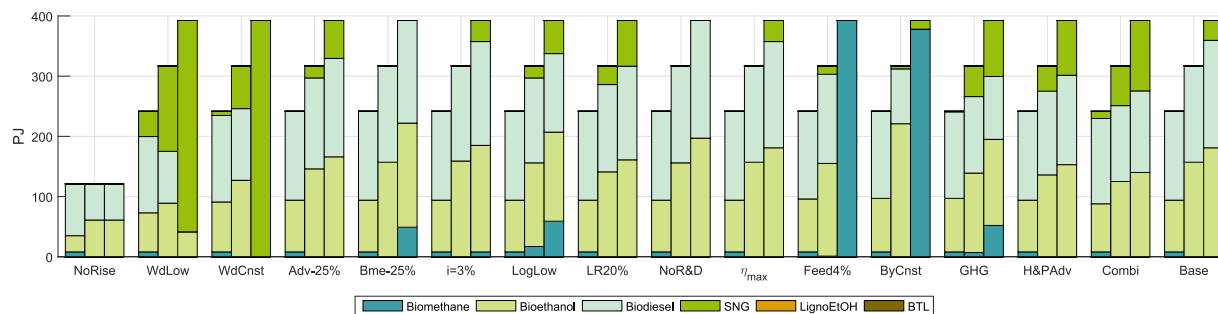

Fig. 3. Sensitivity simulations for the case where methane is included as a fuel. For each sensitivity run, the biofuel production pattern for the years 2030, 2040 and 2050 is shown.

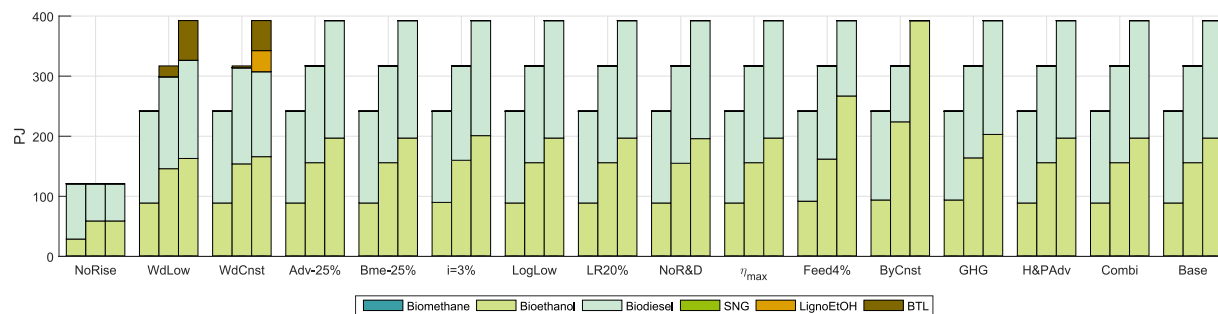

Fig. 4. Sensitivity simulations for the liquid biofuels only case. For each sensitivity run, the biofuel production for the years 2030, 2040 and 2050 is shown. See Table 4 for explanation of abbreviations.

biofuel options has a moderate effect in increasing bio-SNG, but still such R & D efforts do not have the strong effect which may be expected, and the development is still subject to feedstock cost developments which are largely out of the control of investors.

For the case where only liquid biofuels are included, it can be observed that advanced liquid fuels only show up in two of the investigated cases (Fig. 4): where wood chip prices are reduced by 40% (to an initial  $73\text{€ t}_{DM}^{-1}$ ) as well as where wood prices are held constant throughout the simulated time period. In the former case BtL emerges towards the end, and in the latter case both BtL and LignoEtOH emerge towards the end. The effect of a higher learning rate is not enough to bring BtL to the market, not even in combination with lower initial investment costs and higher conversion efficiencies. In the cases where the feedstock costs increase by  $4\% \text{ a}^{-1}$  and especially when the byproduct price is held constant, bioethanol becomes more cost-competitive than biodiesel. Other than this, no significant changes can be seen in the other sensitivity cases and thus the liquid biofuels only system is relatively insensitive to parameter changes.

#### 4. Conclusions and policy implications

In this paper, a sound data basis for techno-economic parameters of advanced biofuels has been investigated and used as a basis for modelling the competitiveness between conventional and advanced biofuels under German conditions. A scrutiny of central techno-economic assumptions for advanced biofuels rendered costs significantly higher than those previously reported and used in similar models, thus highlighting that previous cost assumptions are likely to have been too optimistic, which might also explain why BtL attempts have failed so far.

The most cost-competitive biofuels for most of the time period remained conventional biodiesel and bioethanol, but the costs of these options and biomethane and bio-SNG converged around  $30\text{€ GJ}^{-1}$  in the medium term and thus other factors, such as resource availability, land use, GHG abatement, other emissions and market barriers will play a decisive role for market developments of biofuels. In fact, due to the small cost differences, the options may inhibit the development of

each other as seen in the sensitivity analysis, and thus a technology neutral policy may not be optimal from a long-term perspective. Clear objectives and long-term policies would help, but may be difficult to achieve due to high uncertainties and competition about biomass from other sectors as well as competition from electric mobility.

Feedstock cost developments were found to be the single most relevant factor for the future costs of all biofuels. Assumptions regarding low and/or decreasing feedstock costs (particularly for SRCs) due to increased yields and learning effects in that part of the value chain may explain some of the prevalent optimism regarding the competitiveness of advanced biofuels. Low SRC/lignocellulosic crop costs was in fact seen to be the only case where BtL reached competitiveness towards the end of the time-period, at initial costs of  $73\text{€ t}_{DM}^{-1}$  ( $3.9\text{€ GJ}^{-1}$ ) and below, and then only in the case where gaseous fuels were excluded. However, a switch from annual to perennial crops presents a significant market barrier and the dependence on feedstock cost developments presents a considerable risk and deterrent for investors and developers, as these can counterbalance R & D-efforts.

If advanced biofuels are to be promoted through policy, the results presented in this paper indicate that the more resource and cost efficient strategy would be to go for gaseous biofuels rather than advanced liquid biofuels. For this to happen, the amount of gas powered vehicles (which are more expensive than vehicles powered with liquid fuels (Åhman, 2010), rendering the total well-to-wheel cost advantage lower) needs to increase in order to increase the demand. Thus, a policy promoting gaseous biofuels needs to stimulate both biofuel production and demand (as well as the production of perennial lignocellulosic crops) simultaneously. A technology neutral biofuel policy will likely not result in gaseous fuels due to these path-dependencies, a conclusion further enhanced by the result that cost reductions through R & D are fundamental for these options to reach competitiveness. Starting with niche applications where the usage rate of the vehicles is high (thus reducing the effect of higher-cost vehicles and new infrastructure), such as public transport may be a necessary first step. On the other hand, the produced methane can be used as fuel for combined heat and power plants which may become increasingly important to balance a power system that is foreseen to be dominated

by variable renewable energy sources (wind and photovoltaics). Thus, the risk of investing in a biomethane or bio-SNG plant may be alleviated through the option to serve several markets.

In this paper, an equivalent value of different biofuels was assumed for the end-use stage (with costs for transport and fuelling stations included), but advanced liquid biofuels may become relevant in sectors where gaseous biofuels and electric mobility are no alternative, e.g. in the aviation sector. However, for the short to medium term, the results in this paper indicate that for a specific amount of biomass, the use of gaseous biofuels for land transport would replace more fossil fuels for a lower cost than using advanced liquid biofuels for aviation, due to higher conversion efficiencies. Thus, both GHG abatement and even more so GHG abatement cost are in favour of gaseous fuels as long as the land transport sector is not covered by other non-biogenic renewables.

As a final conclusion, the results and the large sensitivities of biofuel competitiveness highlighted in this paper stress the need for more data and model transparency and for thorough sensitivity analyses of the results in similar system studies.

## Acknowledgements

This work was funded by the Helmholtz Association of German Research Centers and supported by Helmholtz Impulse and Networking Fund through Helmholtz Interdisciplinary Graduate School for Environmental Research (HIGRADE). Thank you to all the colleagues at the DBFZ who contributed with data and expertise for the biofuel options in the project Milestones 2030 (Thrän et al., 2015) and to Philip Tafarte, Sebastian Rauner and Alberto Bezama for comments on the manuscript at different stages. A special thank you to Martin Zeymer (DBFZ) for assistance with cost calculations in the early stages of this work. Valuable comments from the anonymous reviewers are acknowledged. Any remaining alternative facts are nostra culpa.

## References

- Åhman, M., 2010. Biomethane in the transport sector—an appraisal of the forgotten option. *Energy Policy* 38 (1), 208–217.
- BImSchG, 2014. Bundes-Immissionsschutzgesetz in der Fassung der Bekanntmachung vom 17. Mai 2013 (BGBl. i. S. 1274), das zuletzt durch Artikel 1 des Gesetzes vom 20. November 2014 (BGBl. i. S. 1740) geändert worden ist: BImSchGimschg.
- BMWi, 2013. Energie in Deutschland: Trends und Hintergründe zur Energieversorgung. BMWi, 2016. Energiedaten: Gesamtausgabe: Stand: November 2016.
- Börjesson, M., Grahn, M., Ahlgren, E., 2013. Transport biofuel futures in energy-economy modelling - a review: Report no 2013:10. Available at (<http://www.f3centre.se>).
- Bridgwater, A., 2009. Technical and economic assessment of thermal processes for biofuels: Nnfc project 08/018. (<http://www.globalbioenergy.org/uploads/media>).
- CARMEN, 2015. Preisindizes für KUP-Hackschnitzel und Holzhackschnitzel. (<http://www.carmen-ev.de/infotehke/preisindizes>).
- Cazzola, P., Morrison, G., Kaneko, H., Cuenot, F., Ghandi, A., Fulton, L., 2013. Production costs of alternative transportation fuels: Influence of crude oil price and technology maturity.
- CEPCI, 2015. Chemical engineering plant cost index. (<http://www.chemengonline.com/economic-indicators-cepci/>).
- Chen, X., Khanna, M., Yeh, S., 2012. Stimulating learning-by-doing in advanced biofuels: effectiveness of alternative policies. *Environ. Res. Lett.* 7 (4), 045907.
- Cherubini, F., Bird, N.D., Cowie, A., Jungmeier, G., Schlamadinger, B., Woess-Gallasch, S., 2009. Energy- and greenhouse gas-based lca of biofuel and bioenergy systems: key issues, ranges and recommendations. *Resour., Conserv. Recycl.* 53 (8), 434–447.
- Chum, H., Faaij, A., Moreira, J., Berndes, G., Dharmija, P., Dong, H., Gabrielle, B., Goss Eng, A., Lucht, W., Mapako, M., Maserà Cerutti, O., McIntyre, T., Minowa, T., Pingoud, K., 2011. Bioenergy. In: Edenhofer, O., Pichs-Madruga, R., Sokona, Y., Seyboth, K., Matschoss, P., Kadner, S., Zwickel, T., Eickemeier, P., Hansen, G., Schlömer, S., von Stechow C., (Eds.), IPCC Special Report on Renewable Energy Sources and Climate Change Mitigation. Cambridge University Press, Cambridge and United Kingdom and New York and NY and USA.
- Dry, M., 2002. The fisher-tropsch process: 1950–2000. *Catal. Today* 71, 227–241.
- Duret, A., Friedli, C., Maréchal, F., 2005. Process design of synthetic natural gas (SNG) production using wood gasification. *J. Clean. Prod.* 13 (15), 1434–1446.
- Economist, 2016. Uberworld. The Economist September 3rd, 2016.
- EID, 2015. Eid-chronik 2015 - 3. quartal. (<http://www.eid-aktuell.de/>).
- Eisentraut, A., Brown, A., Fulton, L., 2011. Technology roadmap: Biofuels for transport. (<http://www.iea.org/publications/freepublications/publication/>).
- Ericsson, K., Rosenqvist, H., Nilsson, L.J., 2009. Energy crop production costs in the eu. *Biomass- Bioenergy* 33 (11), 1577–1586.
- EU, 2009. Directive 2009/28/ec of the european parliament and of the council of 23 april 2009 on the promotion of the use of energy from renewable sources and amending and subsequently repealing directives 2001/77/ec and 2003/30/ec.
- Faasch, R.J., Patenaude, G., 2012. The economics of short rotation coppice in germany. *Biomass- Bioenergy* 45, 27–40.
- finanzen.net, 2016. Historische kurse Weizen: Isin: Us12492g1040. (<http://www.finanzen.net>).
- Foley, J.A., Ramankutty, N., Brauman, K.A., Cassidy, E.S., Gerber, J.S., Johnston, M., Mueller, N.D., O'Connell, C., Ray, D.K., West, P.C., Balzer, C., Bennett, E.M., Carpenter, S.R., Hill, J., Monfreda, C., Polasky, S., Rockström, J., Sheehan, J., Siebert, S., Tilman, D., Zaks, D.P.M., 2011. Solutions for a cultivated planet. *Nature* 478 (7369), 337–342.
- Georg, T., 2008. Zukünftige regionale Wettbewerbsfähigkeit des Zuckerrübenanbaus und Entwicklungsperspektiven ausgewählter Rübenanbaubetriebe an Standorten Norddeutschlands und Osteuropas: Dissertation zur Erlangung des Doktorgrades der Fakultät für Agrarwissenschaften der Georg-August-Universität Göttingen. (Ph. D. thesis), Georg-August-Universität, Göttingen.
- Grubler, A., 1998. *Technology and Global Change*. Cambridge University Press, Cambridge.
- Haarlemmer, G., Boissonnet, G., Imbach, J., Setier, P.-A., Peduzzi, E., 2012. Second generation BtL type biofuels - a production cost analysis. *Energy Environ. Sci.* 5 (9), 8445.
- Hamelinck, C.N., van Hooijdonk, G., Faaij, A.P.C., 2005. Ethanol from lignocellulosic biomass: techno-economic performance in short-, middle- and long-term. *Biomass- Bioenergy* 28 (4), 384–410.
- Hedenus, F., Johansson, D., Lindgren, K., 2012. A critical assessment of energy-economy-climate models. (<http://publications.lib.chalmers.se/records/fulltext/>).
- Hogan, M., 2011. German biofuel firm choren declares insolvency: 08.07.2011. (<http://af.reuters.com>).
- IEA, 2000. Experience Curves for Energy Technology Policy. IEA Publications, Paris and France.
- IEA, 2008. Energy Technology Perspectives 2008: Scenarios & Strategies to 2050. OECD/IEA, Paris and France.
- IPCC, 2014. Climate Change 2014: Mitigation of Climate Change: Contribution of Working Group III to the Fifth Assessment Report of the Intergovernmental Panel on Climate Change. Cambridge University Press and Cambridge and United Kingdom and New York and NY and USA. (<http://www.cambridge.org/9781107654815>).
- Juraščík, M., Sues, A., Ptasinski, K.J., 2009. Exergetic evaluation and improvement of biomass-to-synthetic natural gas conversion. *Energy Environ. Sci.* 2 (7), 791.
- KTBL, 2012. Energiepflanzen: Daten für die Planung des Energiepflanzenanbaus: KTBL Datensammlung, 2nd Edition. KTBL, Darmstadt.
- Lange, J.-P., 2001. Fuels and chemicals manufacturing: guidelines for understanding and minimizing the production costs. *CatTech* 5, 2.
- Manganaro, J., Chen, B., Adeosun, J., Lakhapatri, S., Favetta, D., Lawal, A., Farrauto, R., Dorazio, L., Rosse, D.J., 2011. Conversion of residual biomass into liquid transportation fuel: an energy analysis. *Energy Fuels* 25 (6), 2711–2720.
- Martinsen, D., Funk, C., Linssen, J., 2010. Biomass for transportation fuels—a cost-effective option for the german energy supply? *Energy Policy* 38 (1), 128–140.
- Menten, F., Chêze, B., Patouillard, L., Bouvart, F., 2013. A review of lca greenhouse gas emissions results for advanced biofuels: the use of meta-regression analysis. *Renew. Sustain. Energy Rev.* 26, 108–134.
- Müller-Langer, F., 2011. Analyse und Bewertung ausgewählter zukünftiger Biokraftstoffoptionen auf der Basis fester Biomasse: DBFZ report nr. 9. (Ph.D. thesis), TU Hamburg, Hamburg.
- Neij, L., 2008. Cost development of future technologies for power generation—a study based on experience curves and complementary bottom-up assessments. *Energy Policy* 36 (6), 2200–2211.
- Ponitka, J., Arendt, O., Lenz, V., Daniel-Gromke, J., Stinner, W., Ortwein, A., Zeymer, M., Gröngroft, A., Müller-Langer, F., Klemm, M., Braun, J., Zeug, W., Thran, D., O'Keeffe, S., Millinger, M., 2016. Focus on: Bioenergy-Technologies: Conversion pathways - towards biomass energy use in the 21st century, 2nd Edition. Leipzig.
- Pregger, T., Nitsch, J., Naegler, T., 2013. Long-term scenarios and strategies for the deployment of renewable energies in germany. *Energy Policy* 59, 350–360.
- Prins, M., Ptasinski, K., 2005. Energy and exergy analyses of the oxidation and gasification of carbon. *Energy* 30 (7), 982–1002.
- Schaerff, A., 2007. Betriebswirtschaftliche Fragen des Anbaus von schnellwachsenden Baumarten auf Ackerland. presentation on april 17, 2007. (<http://www.landwirtschaft.sachsen.de/>).
- Simon, S., Wiegmann, K., 2009. Modelling sustainable bioenergy potentials from agriculture for germany and eastern european countries. *Biomass- Bioenergy* 33 (4), 603–609.
- Sims, R., Taylor, M., 2008. From 1st to 2nd generation biofuel technologies: An overview of current industry and rd & d activities.
- Statista, 2015. Anzahl der Erdgastankstellen in Deutschland. (<http://de.statista.com/statistik/daten/studie/>).
- Sunde, K., Brekke, A., Solberg, B., 2011. Environmental impacts and costs of woody biomass-to-liquid (btL) production and use - a review. *For. Policy Econ.* 13 (8), 591–602.
- Thran, D., Arendt, O., Ponitka, J., Braun, J., Millinger, M., Wolf, V., Banse, M., Schaldach, R., Schüngel, J., Gärtner, S., Rettenmeier, N., Hünecke, K., Hennenberg, K., Wern, B., Baur, F., Fritsche, U., Gress, H.-W., 2015. Meilensteine 2030: Elemente und Meilensteine für die Entwicklung einer tragfähigen und nachhaltigen Bioenergiestrategie. Leipzig.
- Tijmensens, M., 2002. Exploration of the possibilities for production of fisher tropsch

- liquids and power via biomass gasification. *Biomass- Bioenergy* 23 (2), 129–152.
- Toews, T., 2009. Der Preis für Mais: So kalkulieren sie richtig.
- UNFCCC, 2015. Adoption of the paris agreement: Fccc/cp/2015/1.9/rev.1. (<https://unfccc.int/resource/docs/2015/cop21/eng/l09r01.pdf>).
- van Eijck, J., Batidzirai, B., Faaij, A., 2014. Current and future economic performance of first and second generation biofuels in developing countries. *Appl. Energy* 135, 115–141.
- van der Meijden, C.M., Veringa, H.J., Rabou, L.P., 2010. The production of synthetic natural gas (SNG): a comparison of three wood gasification systems for energy balance and overall efficiency. *Biomass- Bioenergy* 34 (3), 302–311.
- Westerkamp, T., Reinelt, T., Oehmichen, K., Ponitka, J., Naumann, K., 2014. KlimaCH4 - Klimateffekte von Biomethan: DBFZ Report Nr. 20. Leipzig.
- Wit, M.d., Junginger, M., Lensink, S., Londo, M., Faaij, A., 2010. Competition between biofuels: modeling technological learning and cost reductions over time. *Biomass- Bioenergy* 34 (2), 203–217.
- World Bank, 2016. Global economic monitor (gem) commodities: Wheat, hrw. (<http://databank.worldbank.org>).
- Yeh, S., Rubin, E.S., 2012. A review of uncertainties in technology experience curves. *Energy Econ.* 34 (3), 762–771.



## Paper 2

# Biomass price developments inhibit biofuel investments and research in Germany: The crucial future role of high yields

Millinger, M. and Thrän, D

*Journal of Cleaner Production (2016), In Press*

*Reproduced with kind permission from Elsevier*





Contents lists available at ScienceDirect

Journal of Cleaner Production

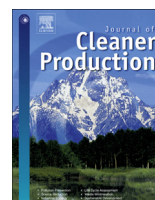
journal homepage: [www.elsevier.com/locate/jclepro](http://www.elsevier.com/locate/jclepro)

## Biomass price developments inhibit biofuel investments and research in Germany: The crucial future role of high yields

M. Millinger <sup>a,\*</sup>, D. Thrän <sup>a,b</sup>

<sup>a</sup> Dep. of Bioenergy, Helmholtz Centre for Environmental Research - UFZ, Permoserstraße 15, 04318 Leipzig, Germany

<sup>b</sup> Dep. of Bioenergy Systems, Deutsches Biomasseforschungszentrum - DBFZ, Torgauer Straße 116, 04347 Leipzig, Germany

### ARTICLE INFO

#### Article history:

Received 27 May 2016

Received in revised form

25 October 2016

Accepted 28 November 2016

Available online xxx

#### Keywords:

Biofuels

Energy crops

Perennials

Biofuel competition

Short-rotation coppice

Miscanthus

### ABSTRACT

The competitiveness of conventional and advanced (second generation) biofuels is a critical issue for the implementation of a sustainable transport strategy. We model biofuel competition under different feedstock cost development scenarios, assessing what costs and cost developments can be expected for energy crops in Germany and how these feedstock cost developments affect the competitiveness between biofuels. Perennial poplar was found to be the least-cost energy crop, with non-perennial silage maize being strongly competitive at increasing feedstock price developments. Assuming increasing feedstock costs for the future, neither conventional biodiesel from rape seed nor advanced biodiesel were found to be competitive in the long run. Feedstock costs were found to overshadow all other factors, leading to costs for advanced biodiesel to be between 27.0 and 53.6€ GJ<sup>-1</sup> in 2030, which is above most expectations. Of the advanced biofuels, only synthetic natural gas was cost-competitive under some circumstances, but biomethane from silage maize and bioethanol from sugar beet were the strongest options, as they combine high yields with high conversion efficiencies while avoiding the high upfront costs of advanced biofuels and the risk of switching to perennial crops. However, such a transition leads to less mobile feedstocks being used than presently and in the case of gaseous fuels requires stimulation of the demand side in order to function. The high dependence on and increasing relevance of feedstock costs is characteristic for the biobased renewables only and is detrimental and inhibiting for investments and research and development efforts, in contrast to for e.g. wind and solar photovoltaics, and must be considered when designing policy for any sector of the bioeconomy.

© 2016 Elsevier Ltd. All rights reserved.

### 1. Introduction

A sustainable transition of the transport sector requires renewable alternatives, where biofuels are one option fitting well into the current system. Advanced biofuels derived from perennial lignocellulosic biomass potentially perform better from an environmental perspective than presently used conventional biofuels and are therefore often put forward as a preferable solution (Tilman et al., 2006; Fargione et al., 2008; Chum et al., 2011). Fast-growing perennial biomass such as short-rotation coppice (SRC) and miscanthus could also potentially act as game-changers for the cost-competitiveness of advanced biofuels, which have yet to experience a market break-through. In this paper, focus lies on assessing the potential and uncertainties regarding the effect of feedstock

costs on biofuel competitiveness in the long term, based on the example of Germany.

The production costs of feedstocks are often used as an approximation to assess the overall cost development potentials of biofuels (Chum et al., 2011). However, production costs alone are not sufficient to estimate the minimum selling price of feedstocks, as opportunity costs from alternative land uses may render other feedstocks more profitable for the farmer. Therefore, a certain market approach is necessary.

Typically, computable general equilibrium (CGE) models are useful for modelling global trade and price developments of the agricultural sector. However, for the case of bioenergy and especially advanced biofuels relying on lignocellulosic feedstock, and in particular perennial biomass, there is an insufficient data basis to date, making these sectors challenging to implement in CGE-models (Kretschmer and Peterson, 2010). Furthermore, for modelling long time-spans the high level of detail in CGE-models is subject to large uncertainties and therefore transparent models

\* Corresponding author.

E-mail address: [markus.millinger@ufz.de](mailto:markus.millinger@ufz.de) (M. Millinger).



taking physical limitations into account are a suitable complement, if not alternative (Bryngelsson and Lindgren, 2013). As a transition away from fossil fuels towards a bioeconomy may have large implications for the economics of biomass, this arguably cannot be captured with top-down models where relationships are based on historical data only (such as in e.g. Festel et al. (2014)).

Estimates of the cost of perennial energy crops taking into account opportunity cost are widespread (Ericsson et al., 2009; Faasch and Patenaude, 2012; James et al., 2010; Khanna et al., 2008; Krasuska and Rosenqvist, 2012; Witzel and Finger, 2016), but - to our knowledge - the effect of the cost of perennials under different circumstances on biofuel costs, competitiveness and sensitivities in an integrated assessment has not been published before. Therefore, in this paper the following research questions are assessed: (i) What costs and cost developments can be expected under different scenarios for energy crops in Germany? and (ii) How do these feedstock cost developments affect the competitiveness of biofuels?

In doing this, we link an existing model for simulating biofuel competition (Millinger et al., 2016) with a crop price estimation module which is elaborated in this paper, and assess the sensitivity of the results through Monte Carlo analysis.

## 2. Materials and methods

Three pathways of conventional biofuels (biomethane produced from maize silage, bioethanol from sugar beet and biodiesel from rape seed) and two pathways as advanced biofuel counterparts (Biomass-to-Liquid (BTL) or Fischer-Tropsch (FT)-diesel and Synthetic Natural Gas (bio-SNG), both produced from biomass with high lignocellulosic content) were included in the simulation (Fig. 1). All biofuels were assumed to be equivalent at the end user stage on an LHV basis (with some differences regarding transport and storage costs of the fuels). The system boundary of this study thus ends at the tank (Well-to-Tank), as the future development of the mobility sector introduces further uncertainties in terms of e.g. assumed vehicle costs, usage rates and average engine efficiencies for the different types of fuel. This presents a theme of its own and is therefore out of scope for this paper. In the following we elaborate on the models, methods and data used in this paper.

### 2.1. Model description

In order to model the competition between different technology options, a simulation model has previously been developed. BENSIM (BioENergy Simulation Model) is a myopic recursive dynamic bottom-up least-cost simulation model with endogenous technological learning, seeking the least-cost mix of biofuel production options on a yearly basis for fulfilling a set demand. Through the recursive elements of learning effects and previously built capacities, path dependencies can be captured by the model.

The existing biofuel plant infrastructure in the region in focus

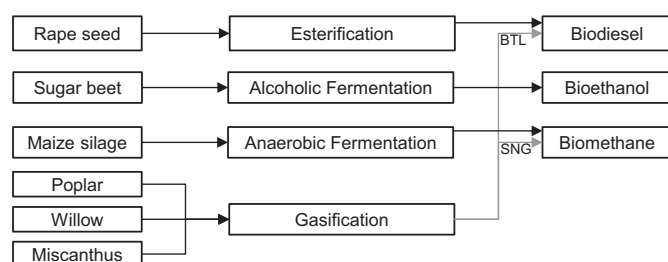

Fig. 1. Feedstocks, conversion pathways and biofuel options included in the modelling.

(here Germany) is the basis at the initial time point of the modelling. For each year of the simulation, BENSIM first removes the plants that have reached the end of their life-time (assumed at 25 years). A minimum market price ( $p_{sys}$ ) is then calculated, defined by the marginal cost (MC) of the most expensive option in the merit order<sup>1</sup> which is put into production to meet the given biofuel demand. If there are options which have total costs ( $TC =$  levelized capital cost + MC) lower than the  $p_{sys}$ , capacity investments take place, beginning with the option with the lowest TC. This continues until the market price adjusts on a level below the TC of still available options and the system reaches a (partial) equilibrium. After the investment phase, biofuel production takes place following the merit order based on marginal costs of production, until the given biofuel target is fulfilled. BENSIM has been more thoroughly described in Millinger et al. (2016) and is here expanded with a feedstock market module for Germany.

Three model parameters were adapted compared to the previous paper. The cost limit differential at which technologies are treated equally in the investment phase (an investment distribution factor due to e.g. market imperfections and regional differences) was set at 15% (from 10% previously). The factor at which the total cost of an emerging technology has to surpass the marginal cost of existing technologies in order to replace them (denoting a path dependency) was set at 20% (up from 15%) and the capacity ramp factor, which sets the limit of annual additional capacity dependent on the available capacity for each option was set to 100% (previously no such limit was set). The reason for these changes is that the differing feedstock cost developments in this paper introduce dynamics which under some circumstances lead to unrealistically swift market changes. These parameters together set the inertia in the model and thus the changes lead to a more balanced result. The effect of varying these parameters is further assessed in the sensitivity analysis.

#### 2.1.1. Feedstock market

A common methodology for estimating the costs of energy crops is to add the per hectare profit of a benchmark crop to the per hectare production cost of the energy crop(s) (Witzel and Finger, 2016). This opportunity cost also serves as the shadow price of land, whereas published land rents may rather be seen as marginal land rents (Ericsson et al., 2009). Common benchmark crops include cereals (Krasuska and Rosenqvist, 2012; Faasch and Patenaude, 2012; Ericsson et al., 2009), corn (James et al., 2010; Khanna et al., 2008), soybeans (Khanna et al., 2008) and rape seed (Faasch and Patenaude, 2012). Usually, the most common crop in the region is selected, but sometimes also the one(s) deemed most likely to be replaced by energy crops. In Germany, by far the most common crop is wheat (Statistisches Bundesamt, 2016), which is therefore used as a benchmark for all other crops in this paper.

The hectare profit for wheat is calculated as the market price  $p_w^{(t)}$  [ $\in t_{FM}^{-1}$ ] times yield  $Y_w^{(t)}$  [ $t_{FM} \text{ ha}^{-1}$ ] minus production costs  $c_w^{(t)}$  [ $\in \text{ha}^{-1}$ ]. Other crops are to achieve this profit per ha, adding production costs  $c_i^{(t)}$  [ $\in \text{ha}^{-1}$ ]. The prices are then divided with the yield  $Y_i^{(t)}$  [ $t_{FM} \text{ ha}^{-1}$ ] to come up with a market price  $p_i^{(t)}$  [ $\in t_{DM}^{-1}$ ] of feedstock  $i$ . Over time, this results in a market price development including opportunity costs for each feedstock (Eqn. (1)).

$$p_i^{(t)} = \left( p_w^{(t)} Y_w^{(t)} - c_w^{(t)} + c_i^{(t)} \right) Y_i^{(t)-1} \quad (1)$$

All perennials are assumed to provide the same and equivalent

<sup>1</sup> All options with existing capacities are sorted by ascending marginal cost, with the capacities brought into use in that order until the given demand is met.



good,<sup>2</sup> "lignocellulosic biomass", for which the least-cost perennial crop sets the price on an annual basis.

## 2.2. Data

Maize, sugar beet, rape seed and wheat are all established crops and thus yield and production cost data from *KTBL (2012)* are used. For yields stemming from *KTBL (2012)*, the average yields are used (an average unit of land in Germany is assumed and thus the highest reported yields are ruled out). For the perennial crops, *KTBL (2012)* states a span for the average yields. In this case, the lower end of the span is used as a starting point with a linear increase towards the higher end in 2050. For non-perennial crops, constant yields are assumed for the whole time-period (bearing in mind that the quality of average land for energetic purposes is likely to decrease with increasing deployment of bio-based commodities).

For poplar and willow, yield data from *KTBL (2012)* is confirmed by peer-reviewed sources (*Faasch and Patenaude, 2012; El Kasmoui and Ceulemans, 2012*). For miscanthus, the yield assumptions are subject to a larger span in literature and therefore yield data for Europe reviewed by *Witzel and Finger (2016)* is used (the data in *KTBL (2012)* is significantly more optimistic). Establishment costs are similarly taken from the average reviewed by *Witzel and Finger (2016)* and annualized over 20 years. As the yields increase, establishment costs are held constant per hectare (but thus not per crop unit).

A summary of all crop data used can be found in *Table 1*. Farm costs for diesel (2015:  $0.9\text{€ l}^{-1}$ ) and labour (2015:  $15\text{€ h}^{-1}$ ) were assumed to increase with the same rate as the wheat price (2015:  $189\text{€}_{2010} t_{FM}^{-1}$ ).<sup>3</sup>

## 2.3. Scenarios

In the scenarios, we consider different feedstock cost developments, based on both projections of historical developments and on possible future developments resulting from the implementation of a large-scale bioeconomy.

Feedstock price developments have been rather moderate and even stagnant seen over long periods of time (with large short-term fluctuations), see *Fig. 2*. However, the average yearly price increase between 1994 and 2014 was about 2.1% (the equivalent 20-year historical average price change for the past ten years averages 1.8% year<sup>-1</sup>) and between 2004 and 2014 it was 3.8% year<sup>-1</sup> (the

equivalent ten-year historical average price change for the past ten years averages 3.8% year<sup>-1</sup>). Therefore, scenarios of stagnant wheat prices are complemented with annual increases of 2% and 4%.

The effect of these price developments is assessed in cases where (i) only liquid biofuels and (ii) both liquid and gaseous biofuels are considered, in order to ease comparison with other studies. The effects are assessed for the medium to long term and thus a time horizon until 2050 is simulated. For all scenarios, a continuously increasing amount of biofuels in the transport sector is assumed, rising from current 119PJ (*BMWi, 2016*) to 400PJ by 2050, corresponding to 16% of the current end energy demand of the German transport sector and in line with sustainable agricultural biofuel potentials (*Simon and Wiegmann, 2009*) and long-term strategies (*Pregger et al., 2013*).

R&D-learning is set at a rate of one learning rate for each five years for options that are not invested in. All costs in the modelling are in real  $\text{€}_{2010}$ .

## 2.4. Sensitivity analysis

The sensitivity analysis is in this paper performed through Monte Carlo analysis, which is a way of mapping out the solution space depending on variance in input variables without calculating all possible combinations. In energy systems modelling, Monte Carlo sensitivity analysis is often not implemented due to long computation times (*Hedenus et al., 2012*). With regard to biofuels, where both crops and conversion technologies of advanced biofuel options are subject to large variances, a thorough sensitivity analysis is necessary for showing the robustness of results and different biofuel options.

In BENSIM, a module for Monte Carlo analysis was developed as follows. Crucial and non-correlated parameters with large parameter variance were identified and ranges of possible values quantified with a connected distribution function (uniform). The parameters are then randomized using the "rand" Matlab function and a simulation run in BENSIM for a 1000 random parameter settings. As the resulting output from the model is a system development, shares of SNG, biomethane and BTL over the whole time-period were chosen as simple indicators to depict the distribution.

The parameters varied in the sensitivity analysis were chosen as follows. Maize, sugar beet, rape seed and wheat are all established crops and are therefore not varied in the sensitivity analysis. The

**Table 1**

Summary of feedstock parameters. For rape seed, the energy content reflects the total energy content and not of the oil share. The conversion efficiency of the plant is suited to the value presented here. Wheat (winter wheat) is not used as an energy crop in this study, but only serves as a comparison for the economics of the other crops.

Feedstock		Silo Maize	Sugar beet	Rape seed	Poplar	Willow	Miscanthus	Wheat
Energy content	CJ $t_{DM}^{-1}$	17	16.3	26.5	17.6	17.6	17.6	17.0
Dry matter content	$t_{DM} t_{FM}^{-1}$	0.35	0.23	0.91	0.45	0.45	0.8	0.86
Yield	$t_{FM} \text{ha}^{-1}$	45–55	65	3.5	18–27	11–20	12–17	7.89
Farm labour demand	hours $\text{ha}^{-1}$	10.8	7.8	5.5	0.3	0.3	4.8	5.4
Diesel demand	liter $\text{ha}^{-1}$	112	111	73	2.1	2.1	37.8	73
Fix machine cost	$\text{€ ha}^{-1}$	292	318	176	5.39	5.45	130	164
Variable machine cost	$\text{€ ha}^{-1}$	248	291	148	7.09	7.12	85.9	146
Direct cost	$\text{€ ha}^{-1}$	406	600	520	86.6	61.3	283	508

<sup>2</sup> i.e. the energy content part in the different lignocellulosic biomass types can be used equivalently, e.g. without needing to adapt the conversion step.

<sup>3</sup> calculated from daily wheat prices for five years 13.04.2011–14.04.2016 (*finanzen.net, 2016*), inflation adjusted to  $\text{€}_{2010}$  with annual HICP data (*Eurostat, 2016*).

parameters for perennial energy crops on the other hand are rather uncertain. This goes in particular for establishment costs (particularly rhizome costs for miscanthus (*Witzel and Finger, 2016*)) and yields.

The cost development of wheat, which here sets the benchmark for the costs of the other crops, is highly uncertain but overshadows

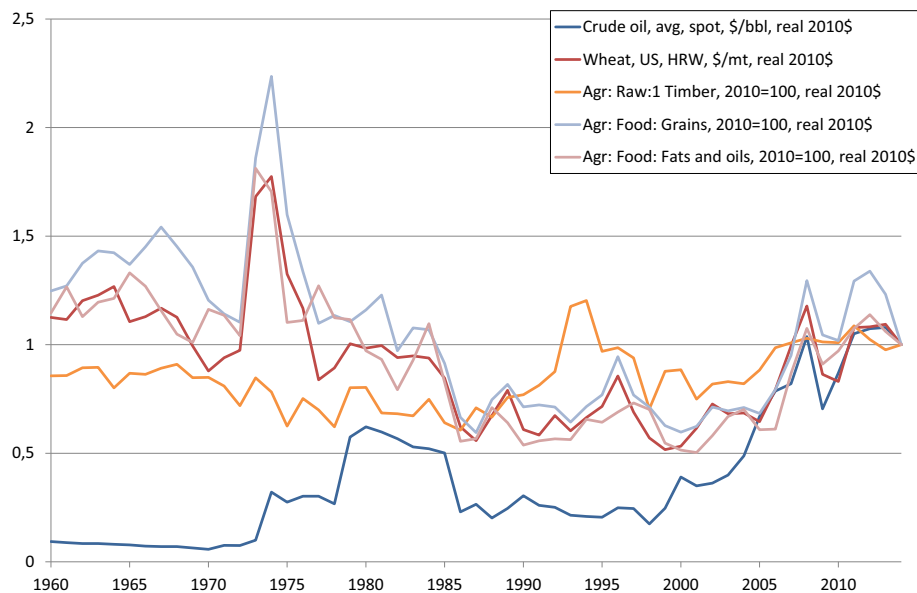

Fig. 2. World market price development of wheat, grains, fats and oils, timber and crude oil 1960–2014, in  $\$_{2010}$  (World Bank, 2016), normalized to 2014.

all other parameters and is therefore held constant in four separate sensitivity runs, at 2% and 4% annual wheat price increases, with or without gaseous fuels.

For the conversion part, the investment costs, discount rate and learning rates affect the competitiveness. However, as the investment cost and learning rate are somewhat correlated (a low assumed initial investment cost is coupled with a low learning rate), only the investment cost is varied. Exogenous learning through R&D was however varied. Conversion efficiencies can also strongly affect the cost and are therefore varied. Three model parameters were varied: the investment distribution factor, the path dependency factor and the capacity ramp factor.

Table 2 summarizes the parameters which were varied in the Monte-Carlo sensitivity analysis.

### 3. Results

The resulting feedstock costs are shown in Fig. 3. It can be seen that the least cost perennial crop is poplar, with miscanthus coming close in the cases where the wheat price is increasing, as high deployment costs are somewhat compensated by land-use efficiency. The resulting lowest price for perennials in 2015 is 4.4–6.8  $\text{€ GJ}^{-1}$  (77–120  $\text{€ t}_{DM}^{-1}$ ), whereas the price spans between 3 and 4.6,

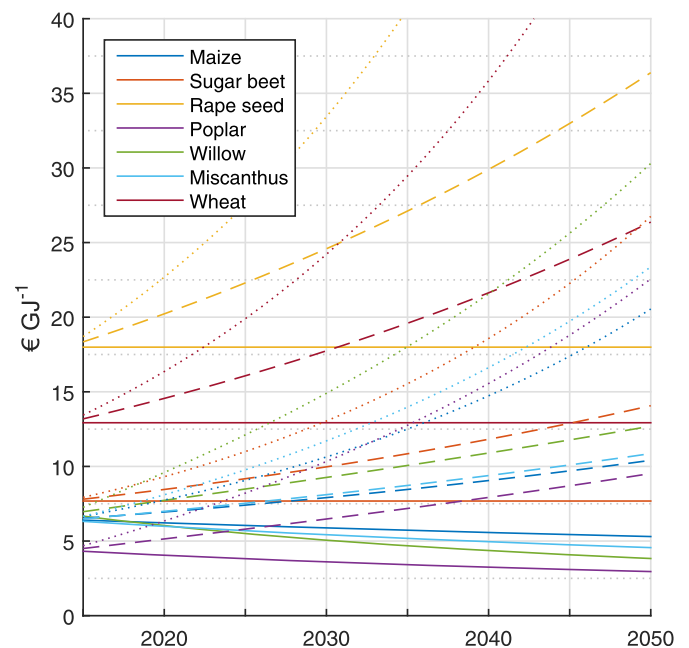

Fig. 3. Feedstock cost developments in the assessed cases. Solid, dashed and dotted lines are for the cases where the wheat price remains constant and increases by 2% and 4% yearly, respectively. In the latter case, the prices of wheat and rape seed continue rising to 53.1 and 72.9  $\text{€ GJ}^{-1}$ , respectively (outside of the graph).

Table 2

Parameters varied in the Monte Carlo sensitivity analysis. All parameters have a uniform distribution over the span. The distributions which vary between the technology specific minimum and maximum values start at a random point along the span and increase linearly to a value randomly between the starting point and the maximum value. The technology-specific values are individually randomized for each technology option.

Parameter	Unit	Span
Conversion plant initial investment cost	$\text{M€ MW}_{cap}^{-1}$	$\pm 25\%$
Exogenous learning	years	3–10
Discount rate	%	5–10
Conversion efficiency	$\eta$	min–max
Yield	$\text{t}_{FM} \text{ ha}^{-1}$	min–max
Establishment cost (perennials)	$\text{€ ha}^{-1}$	$\pm 25\%$
Investment distribution limit	%	10–20
Path dependency factor	%	15–25
Capacity ramp	%	100–200%

9.5–12.7 and 22.6–20–3  $\text{€ GJ}^{-1}$  (53–81, 167–224 and 397–533  $\text{€ t}_{DM}^{-1}$ ) for 2050 in the cases with constant, 2% and 4% increasing wheat prices, respectively. The initial costs are at the higher end of or above the 2–5  $\text{€ GJ}^{-1}$  found in other studies (Sunde et al., 2011).

Of the annual crops, maize fares rather well. In the case of 2% annually increasing wheat prices, maize is only 9% more expensive than poplar on an energy basis towards the end, and less expensive than willow and miscanthus. At a 4% annual increase, maize becomes the least-cost crop in the medium term. However, the competitiveness in this context only becomes clear when considering the conversion step.

Resulting from the feedstock cost developments, the biofuel developments in the six main cases can be seen in Fig. 4. Common for all cases is that biodiesel dominates the market in the beginning, only to disappear in the short to medium term, depending on the level of feedstock cost increase and on the competition. Bioethanol dominates over-all in five scenarios, especially where gaseous fuels are not allowed. In case (a), SNG rapidly expands from 2025 onwards and after 2035 almost exclusively gaseous fuels remain. The reappearance of bioethanol and biomethane is due to existing capacities becoming competitive again for fulfilling the additionally emerging biofuel demand, which gives an idea of the dynamics at hand (whereby in reality such capacities would be decommissioned after some time of no production).

BTL shows up in the medium term in case (b), but overall has a small market share, and in the other cases BTL is not to be seen. Advanced biofuels thus fare a better chance of becoming competitive when gaseous fuels are included. Advanced biofuels retain smaller market shares when wheat prices increase more steeply, as the shadow price of land increases and thus the land use efficiency of fuels becomes a more relevant parameter in the pricing compared to other production costs. Thus, as biomethane from maize and bioethanol from sugar beet have biofuel yields higher than or comparable to SNG and the conversion steps are less expensive, bioethanol retains a large market share for much of the time period and biomethane increases, in order to become the dominant fuel towards the end in case (e).

Total arable land required for biofuels is also shown in Fig. 4 for each scenario. In all cases, land used peaks at about 3 Mha in 2020 and then decreases due to the decrease of biodiesel. In the cases where all fuels are included, land use thereafter stays below 2 Mha until 2050 despite increasing production of biofuels. In fact, in these cases, less or similar areas of land are required to produce more than three times the amount of biofuel. This is due to a switch to

more land efficient fuels with additional yield and conversion efficiency improvements over time. In the liquid fuels only cases, the required land area increases to about 2.5 Mha in 2050.

The cost structures in Fig. 5 show that even at a an annual wheat price increase of only 2%, none of the options achieves decreasing costs with time, despite considerable reductions of investment and O&M costs through technological learning for some of the options. The thin bars show the total costs at an annual wheat price increase of 4% a<sup>-1</sup>. It becomes clear that the biofuel cost is highly dependent on feedstock costs and thus high yields combined with high conversion efficiencies become increasingly relevant. In this case, biomethane is the least-cost option in the long run, with SNG being second, despite actually starting off at a slightly lower cost than biomethane, and bioethanol is third, from being the least-cost option at the start. Biodiesel is rather competitive at the start but the cost rapidly increases due to low yields for rape seed. BTL is only 15% more expensive than biodiesel at the beginning, but due to a low conversion efficiency also increases rather rapidly.

The share of the levelized capital cost of the whole biofuel cost decreases with increasing feedstock costs. For SNG and BTL, this share starts at 25% and decreases to 10–11% and 5–6% in 2050 in cases (c) and (e), respectively. Thus, also the importance of investment cost reductions through technological learning decreases substantially.

### 3.1. Sensitivity analysis

The results of the Monte Carlo sensitivity assessment are shown in Fig. 6. In case (d), BTL predominantly occurs in low quantities. In over 90% of the cases it remains below 10% of the total fuels over the whole time span, and in 8% of the cases between 10 and 20%. Some outliers are spread out, up to a 1/1000 occurrence at up to a 60% share. In case (f), 99.5% of cases remain below 10%.

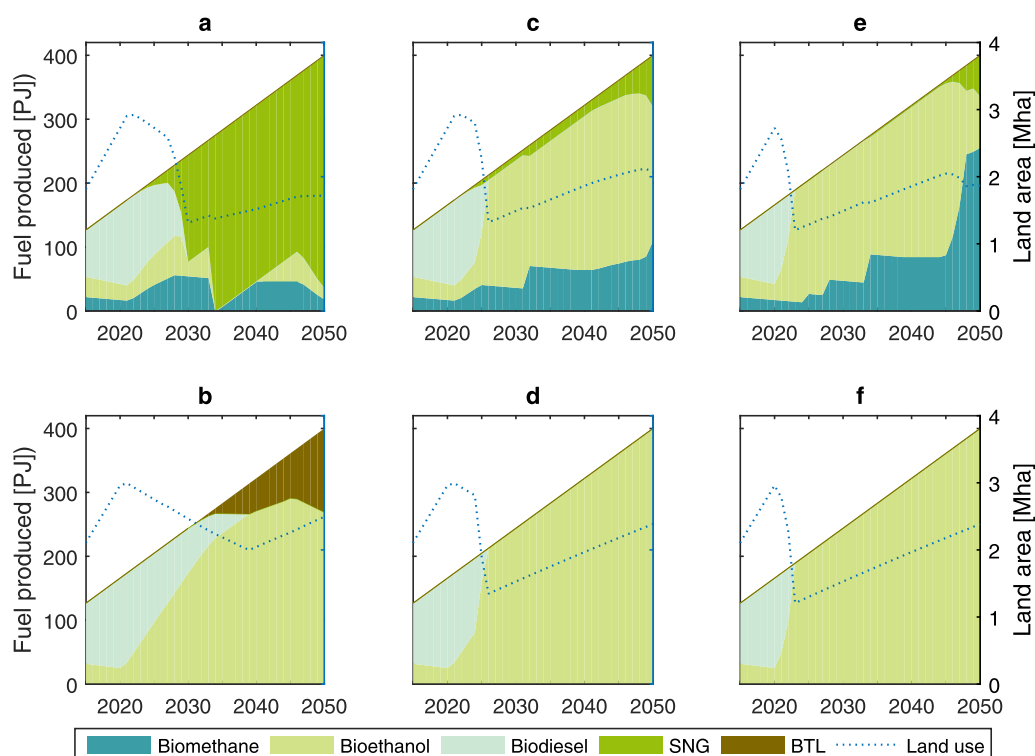

**Fig. 4.** Production structures as well as land use (line, right axis) in the six main scenarios. Cases (a) and (b) with a constant wheat price, cases (c) and (d) with a 2% annual wheat price increase and cases (e) and (f) with a 2% annual wheat price increase. Cases (a), (c) and (e) include all fuels whereas cases (b), (d) and (f) include only liquid fuels. The produced amount of fuels is shown in petajoule [PJ].

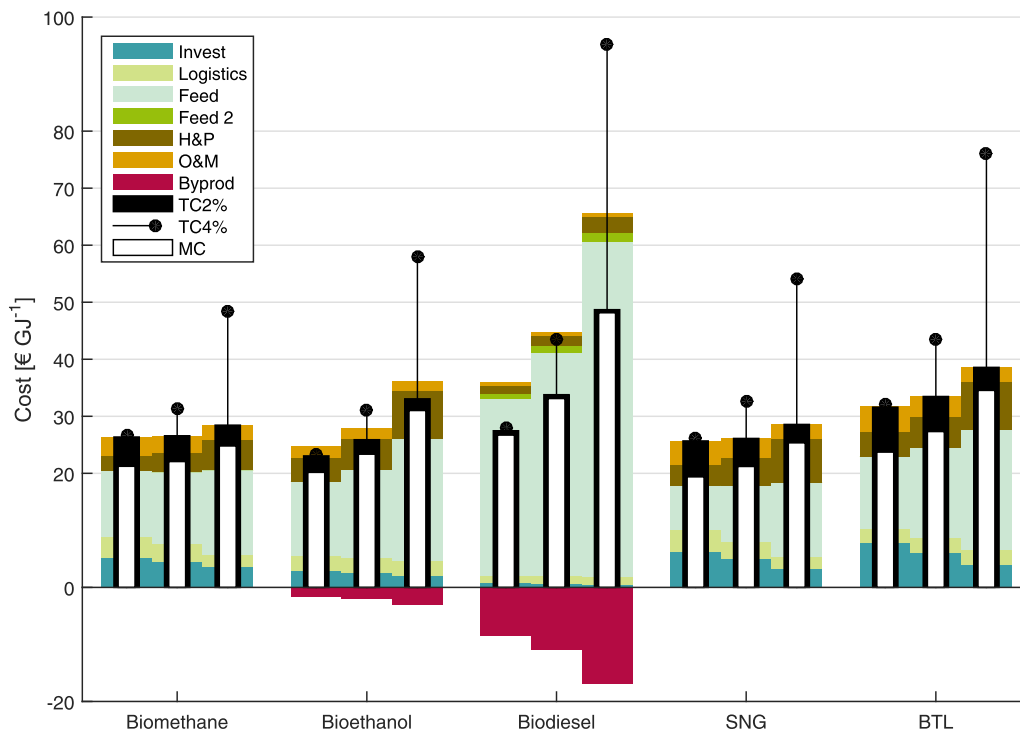

**Fig. 5.** Cost break-down and development for the biofuel options, in the case of a 2% annual wheat price increase, for the years 2015, 2030 and 2050, respectively. Abbreviations: Invest = investment cost; Logistics = logistic cost; Feed = main (biogenic) feedstock cost; Feed 2 = secondary feedstock cost (i.e. methanol for biodiesel); H&P = heat and power; O&M = operation and maintenance; Byprod = by-product credit; TC2% = total cost at an annual wheat price increase of 2%; TC4% = total cost at an annual wheat price increase of 4%; MC = marginal cost.

In case (c), both SNG and biomethane are spread out with significant shares between 0 and 80%. SNG remains below 10% in about a third of the cases and between 50 and 80% in a third of the cases. Biomethane remains below 20% in about half of the cases and rather evenly spread out between 20 and 80% shares. In case (e), SNG performs worse and remains below 10% in two thirds of the cases but still shows a rather even spread at low levels between 20 and 70%. Biomethane is rather evenly spread out between 10 and 80% shares, with some 40% of cases above half of the total produced biofuels. Thus, at less steeply increasing feedstock costs, SNG stands a chance of performing better than biomethane and vice versa. Clearly, BTL stands only a small chance in both cases, and more steeply increasing feedstock costs are to the disadvantage of any advanced biofuel in competition with biomethane from maize and bioethanol from sugar beet.

The biofuel cost variance at a set 2% annual wheat price increase resulting from the sensitivity assessment is shown in Fig. 7. Comparing to Fig. 5, it becomes clear that the feedstock cost development is the by far most important factor in determining future biofuel costs, as in 2050 all spans are larger when only feedstock costs are varied compared to the Monte Carlo assessment.

Biodiesel is the option most strongly determined by feedstock cost developments. Apart from that, biodiesel shows a relatively small cost span, also for the future. The largest cost span at a set feedstock cost development is exhibited by BTL, a product of high investment cost uncertainty, comparably low conversion efficiencies and feedstock yield uncertainties.

The two gaseous fuels show the lowest mean costs for 2030, with SNG being the lower one at 24.5 and biomethane at 26.0 € GJ<sup>-1</sup>. Bioethanol is only slightly above with 26.2 € GJ<sup>-1</sup>. The spans for the gaseous biofuels are larger than for the established liquid biofuels.

The span for BTL in 2030 in the sensitivity analysis for 2% and 4% annual wheat price increases is 27.0–53.6 € GJ<sup>-1</sup> (mean 38.1 € GJ<sup>-1</sup>) and can be compared to a span of 7–26 €<sub>2010</sub> GJ<sup>-1</sup> (8–30 \$<sub>2005</sub> GJ<sup>-1</sup>) for 2030 in other studies (Chum et al., 2011, p.282). The results here, even at a rather moderate 2% annual wheat price increase, are clearly above this span. The cost span of SNG is clearly lower, at 20.2–39.8 € GJ<sup>-1</sup> (mean 28.5 € GJ<sup>-1</sup>).

Due to low-cost perennials these options begin at substantially lower costs than in Millinger et al. (2016), where they started at 37.9 and 29.5 € GJ<sup>-1</sup> and amounted to 40 and 30 € GJ<sup>-1</sup> by 2030, respectively. Thus, the effect of perennial crops can be substantial for the initial costs of advanced biofuels, although it may not be enough to compete economically with some conventional biofuels, and the costs are heavily subjected to future feedstock price developments.

The sensitivities of biofuels produced per hectare are shown in Fig. 8. It can be seen that the gaseous fuels perform the best and about three to four times more biofuels can be produced per land unit compared to biodiesel and also significantly more than compared to BTL. Bioethanol, if produced from sugar beet, is the best liquid fuel in this aspect, not far behind the gaseous alternatives. For the advanced alternatives, the existence of three crops which were individually randomized in the sensitivity analysis increases the likelihood of higher yields (system resilience), but still there are cases where the yields are at the levels of biodiesel or even below.

#### 4. Discussion

In this paper, the trade-off between feedstock energetic density and conversion complexity is tested through a combined assessment of possible future economic developments. The combination of learning effects of conversion options with a plausibly

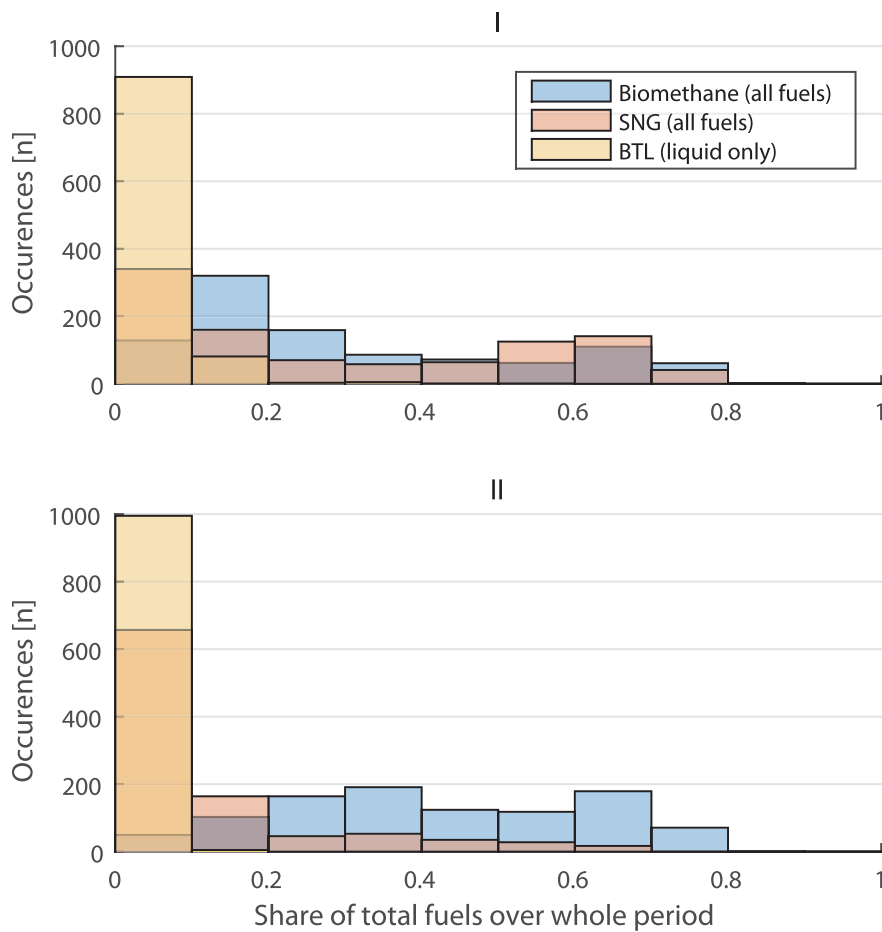

**Fig. 6.** Sensitivity of biofuel production shares, (I) at an annual 2% wheat price increase and (II) at an annual 4% wheat price increase, for the cases where all fuels as well as liquid fuels only were included. Thus, (I) and (II) correspond to the sensitivity in (c–d) and (e–f), respectively. The shares are of total biofuels over the whole time-period. The colour tone of the bars in the histogram is summed where they overlap. (For interpretation of the references to colour in this figure legend, the reader is referred to the web version of this article.)

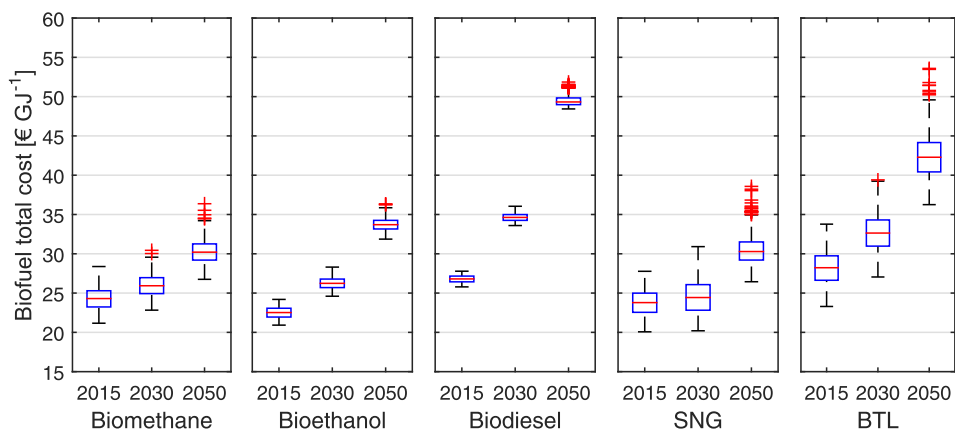

**Fig. 7.** Sensitivity of total cost of biofuels in 2015, 2030 and 2050 in case (c), at an annual 2% wheat price increase with all fuels included. The red lines show the median, the bottom and top edges of the blue box show the 25th and 75th percentiles, respectively, the whiskers extend to a maximum of 1.5 times the length of the box and outside of this interval outliers are plotted with a red cross. (For interpretation of the references to colour in this figure legend, the reader is referred to the web version of this article.)

differentiated feedstock price development leads to some striking results.

First, the currently dominant<sup>4</sup> biofuel in Germany, biodiesel

derived from rape seed, is outcompeted in the short to medium term, showing that the low land use efficiency is not compensated by low-cost conversion. However, the rape seed price estimated with the method used here is ca 12% higher than the actual market price (with the reference rape seed price derived similarly to the base wheat price). Possible reasons for this discrepancy are that the

<sup>4</sup> bioethanol produced from grains (wheat) was sorted out pre-simulation for this paper due to poor economic performance; see Thrän et al. (2015).



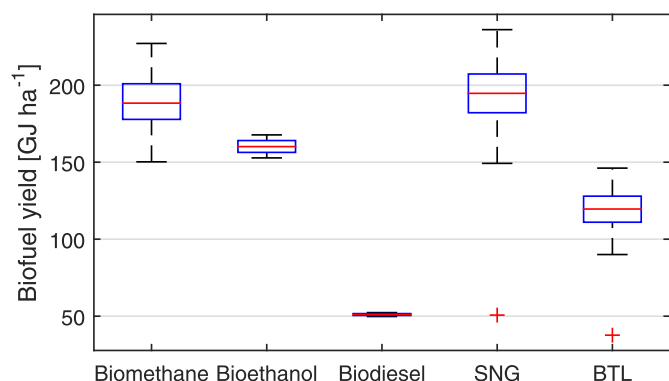

**Fig. 8.** Sensitivity of biofuel yield. The red line shows the median, the bottom and top edges of the blue box show the 25th and 75th percentiles, respectively, the whiskers extend to a maximum of 1.5 times the length of the box and outside of this interval outliers are plotted. (For interpretation of the references to colour in this figure legend, the reader is referred to the web version of this article.)

price of rape seed is heavily influenced by the global market for oil seeds due to the global tradability of the crop, as well as biofuel policies and crop-rotation practices influencing the cultivation of rape seed. Running the same scenarios with 12% lower rape seed prices throughout the whole time-period, biodiesel stays on for a slightly longer period of time, but is still displaced in the medium term in all scenarios except (b), where it remains in rather constant quantities throughout, at the cost of bioethanol. Nevertheless, based on these results and due to the low energetic yields, the shadow cost of growing rape seed for biodiesel production will increase more than for the other options in this assessment, and more complex conversion options using higher-yielding feedstocks are therefore likely to become economically preferable in the future.

Second, however, there is an end to the complexity required for a least-cost development. Advanced fuels may in fact not be required, as biomethane derived from whole-crop maize and bioethanol derived from sugar beet fare rather well even under moderate price development assumptions and even better if assuming increasing shadow costs of land use, as they have comparably high yields with less uncertainty and lower market barriers than perennial crops. This holds even though the prices for perennials are conservative (low) estimates, as farmers' risk considerations for investing land in switching to perennial crops (Ericsson et al., 2009) have not been included.

Third, the results presented here make it clear that stimulating markets for gaseous biofuels would increase the likelihood of a more biomass, land use and cost efficient biofuel development compared to focusing on liquid fuels, and especially if advanced biofuels are strived for. The result from Millinger et al. (2016) is thus further confirmed. The large and even spread of gaseous fuels seen in the sensitivity analysis further indicates the need for directed policy measures if such fuels are to achieve large market shares with a higher certainty.

Fourth, however, a consequence of a transition away from rape seed and grains with high energy density, is that the viable transport distances of feedstocks used for energetic purposes will decrease and thus biofuel conversion would likely need to take place in a nearer vicinity of the used arable areas. There may be a trade-off between the development towards biofuel conversion near the used land plots and the higher efficiency of gaseous fuels. If available land is scarce in the vicinity, increased imports of biofuels may become a necessity, in which case gaseous fuels are less economically transported in the absence of a gas network, such as

is the case for overseas imports. In such a case, liquefaction or other densification is likely necessary, which however decreases the pathway efficiency and increases costs.

In this work, scenarios of either stagnant or different levels of increasing reference feedstock costs have been assessed, but which feedstock cost developments should be expected when designing long-term policy? In the past 20 years, the average annual cost increase was 2.1% and in the past ten years 3.8% (see Section, and this may be expected to continue for the following reasons.

A transition away from fossil resources with a simultaneous global population increase and improved living standards is likely to hugely increase the demand for biomass from many sectors, such as heat, power and materials as well as fuels. Some studies have come to the conclusion that biomass would contribute to more GHG abatement in combined heat and power production (Steubing et al., 2012) and do this more cost-effectively (Grahn et al., 2007; Martinsen et al., 2010) than in the transport sector. Sectors relying on hydrocarbons (e.g. some material use) are bound to rely on biomass as there are no other renewable alternatives (in contrast to for the energy and transport sectors), all the while global demand for more land extensive foodstuffs is increasing.

Land use is also connected with emissions from land use change, further enhanced through forests being converted to arable land due to increased land pressure (indirect land use change), and land use change is also connected to numerous other environmental effects such as biodiversity loss, soil erosion, albedo changes, etc. Furthermore, climate change, freshwater and phosphorous scarcities are likely to decrease the available suitable arable land as well as yields (Foley, 2005).

Therefore, due to an expected increase in biomass demand and simultaneous land use restrictions, it appears sensible to assume increasing prices of established crops, and thus an increasing shadow cost of land, when designing a resilient biofuel policy. In this case, the somewhat unexpected result of this study is that perennial biomass and advanced biofuels are not as competitive as some conventional biofuels under German conditions. This finding should apply to other regions with similar climate and soil characteristics to Germany, whereas the increasing importance of higher yielding biofuel options is globally applicable, with regional differences regarding which biofuels perform best.

Some aspects that have been left out of this study need mentioning. It was assumed that the derived market price applies at the gate of the conversion plant. Transport and storage costs of biomass have thus been omitted for the sake of simplicity and methodological transparency, as they depend on factors which are hardly foreseeable, such as where the energy crops are grown, how sparsely spread out the land plots are, how far away conversion plants are, how large they are and thus how large the catchment area needs to be<sup>5</sup>. For options using the same crop, the difference is bound to be smaller, as it mainly depends on the size of the plants. Still, the spread of biomass has an effect. On the one extreme, a perfect circle of biomass around the conversion plant can be assumed, in which case the transport cost would decrease with increasing plant size (as the area increases with the square of the radius). On the other hand, if biomass is assumed to be more heterogeneously spread out in the landscape, smaller conversion plants may be more economical, depending on the shape of the

<sup>5</sup> As an estimate, transport costs for cellulosic feedstocks typically are estimated at ca 3–16\$/t (Miranowski and Rosburg, 2010; Haque et al., 2014; Wang, 2009), depending largely on the distance, which at 14 GJ t<sup>-1</sup> would translate to ca. 0.16–0.86€ t<sub>DM</sub><sup>-1</sup>. Compared to the costs and cost developments derived in this paper, this does little towards the economical comparison with the conventional biofuel crops.

spread. A spatial extension of the model with landscape data is therefore interesting for future research.

Growing perennials on marginal land for energetic purposes has been proposed as a solution which competes less with food production and displaces less land, thus avoiding indirect land use change (e.g. Tilman et al., 2006; Fargione et al., 2008), but has not been investigated here. Assessing the effect of this would also be an interesting extension of the study in combination with spatial data, as the marginal lands are likely to be even more sparsely spread out than presently used arable land. In combination with lower yields (Searle and Malins, 2014) and thus larger catchment areas, the transport costs are therefore more relevant for such an assessment.

Other future work includes expanding the model with more environmental aspects, widening the spatial scope to a larger area such as the EU, and assessing the role of biofuels in the wider context of the bioeconomy, including also biorefineries. With the cost developments found in this paper, the GHG abatement costs of biofuels compared with other usages of biomass is also an interesting and important topic which grants a further assessment.

## 5. Conclusions

In this paper, future biofuel competitiveness in Germany has been modelled under different feedstock cost development scenarios, leading to some important results and conclusions.

The initial lowest potential price of perennial crops was found to be  $4.4 \text{ € GJ}^{-1}$  ( $77 \text{ € t}_{DM}^{-1}$ ) for poplar, within the range found in other studies. The price of willow was 6.8, and of miscanthus  $6.4 \text{ € GJ}^{-1}$ , the same as for maize, which is not a perennial crop. Considering the development in the past decades and an expected increasing demand for biomass, the scenarios of increasing biomass prices should be considered when designing policy. At the higher feedstock cost developments considered in this paper (corresponding to the development in the last decade), maize emerged as the least-cost feedstock on an energy basis in the medium term.

Combining these price scenarios with a market competition model, some important results emerged. Currently dominant biofuels in Germany, biodiesel from rape seed and bioethanol from grains, were found not to remain cost-competitive in the short to medium term. However, despite current focus in research, advanced biofuels were found not to be the most competitive biofuels even in the long term when considering increasing feedstock costs. For instance, BTL was found to cost between 27.0 and  $53.6 \text{ € GJ}^{-1}$  in 2030, which is above most expectations. Rather, bioethanol from sugar beet and biomethane from maize are strong competitors, with biomethane increasingly so with higher feedstock prices, due to higher yields combined with high conversion efficiencies, all the while avoiding the high upfront costs of advanced biofuels and the risk of switching to perennial crops. However, such a transition leads to less mobile feedstocks being used than presently and in the case of gaseous fuels requires stimulation of the demand side in order to be successful.

The sensitivity analysis further confirmed that feedstock costs are by far the most important determining factor of the future costs of biofuels, which makes investments in biofuels in general and advanced biofuels in particular a highly risky endeavour. The share of levelized capital costs of the total biofuel costs were also seen to substantially decrease with increasing feedstock costs. As feedstock cost developments are out of the control of investors, this inhibits investments and R&D efforts (with the possible exception of conversion efficiency improvements). This is characteristic for any usage of biomass, in stark contrast to other renewable options such as wind and solar photovoltaics which have no operational resource costs, and must be considered when designing policy for any sector of the bioeconomy.

## Acknowledgements

This work was funded by the Helmholtz Association of German Research Centers and supported by Helmholtz Impulse and Networking Fund through Helmholtz Interdisciplinary Graduate School for Environmental Research (HIGRADE). We thank the reviewers for constructive comments leading to improvements of the manuscript.

## References

- BMW, 2016. Energiedaten: Gesamtausgabe: Stand: Januar 2016. URL <http://bmwi.de/DE/Themen/Energie/>.
- Bryngelsson, David K., Lindgren, Kristian, 2013. Why large-scale bioenergy production on marginal land is unfeasible: a conceptual partial equilibrium analysis. *Energy Policy* 55, 454–466. <http://dx.doi.org/10.1016/j.enpol.2012.12.036>. ISSN 0301-4215.
- Chum, H., Faaij, A., Moreira, J., Berndes, G., Dharmija, P., Dong, H., Gabrielle, B., Goss Eng, A., Lucht, W., Mapako, M., Masera Cerutti, O., McIntyre, T., Minowa, T., Pingoud, K., 2011. Bioenergy. In: Edenhofer, O., Pichs-Madruga, R., Sokona, Y., Seyboth, K., Matschoss, P., Kadner, S., Zwickel, T., Eickemeier, P., Hansen, G., Schlömer, S., von Stechow, C. (Eds.), *IPCC Special Report on Renewable Energy Sources and Climate Change Mitigation*. Cambridge University Press, Cambridge and United Kingdom and New York and NY and USA.
- El Kasmioui, O., Ceulemans, R., 2012. Financial analysis of the cultivation of poplar and willow for bioenergy. *Biomass Bioenergy* 43, 52–64. <http://dx.doi.org/10.1016/j.biombioe.2012.04.006>. ISSN 09619534.
- Ericsson, Karin, Rosenqvist, Håkan, Nilsson, Lars J., 2009. Energy crop production costs in the EU. *Biomass Bioenergy* 33 (11), 1577–1586. <http://dx.doi.org/10.1016/j.biombioe.2009.08.002>. ISSN 09619534.
- Eurostat, 2016. Harmonized Index of Consumer Prices (HICP) (URL [ec.europa.eu/eurostat](http://ec.europa.eu/eurostat)).
- Faasch, Rouven Jonas, Patenaude, Genevieve, 2012. The economics of short rotation coppice in Germany. *Biomass Bioenergy* 45, 27–40. <http://dx.doi.org/10.1016/j.biombioe.2012.04.012>. ISSN 09619534.
- Fargione, J., Hill, J., Tilman, D., Polasky, S., Hawthorne, P., 2008. Land clearing and the biofuel carbon debt. *Science* 319 (5867), 1235–1238. <http://dx.doi.org/10.1126/science.1152747>. ISSN 0036-8075.
- Festl, Gunter, Würmseher, Martin, Rammer, Christian, Boles, Eckhard, Bellof, Martin, 2014. Modelling production cost scenarios for biofuels and fossil fuels in Europe. *J. Clean. Prod.* 66, 242–253. <http://dx.doi.org/10.1016/j.jclepro.2013.10.038>. ISSN 09596526.
- finanzen.net. Historische Kurse Weizen: ISIN: US12492C1040, 2016. URL [www.finanzen.net](http://www.finanzen.net).
- Foley, J.A., 2005. Global consequences of land use. *Science* 309 (5734), 570–574. <http://dx.doi.org/10.1126/science.1111772>. ISSN 0036-8075.
- Grahn, Maria, Azar, Christian, Lindgren, Kristian, Berndes, Göran, Gielen, D.J., 2007. Biomass for heat or as transportation fuel? A comparison between two model-based studies. *Biomass Bioenergy* 31 (11–12), 747–758. <http://dx.doi.org/10.1016/j.biombioe.2007.05.001>. ISSN 09619534.
- Haque, Mohua, Epplin, Francis M., Biermacher, Jon T., Holcomb, Rodney B., Kenkel, Philip L., 2014. Marginal cost of delivering switchgrass feedstock and producing cellulosic ethanol at multiple biorefineries. *Biomass Bioenergy* 66, 308–319. <http://dx.doi.org/10.1016/j.biombioe.2014.02.004>. ISSN 09619534.
- Hedenus, Fredrik, Johansson, Daniel, Lindgren, Kristian, 2012. A Critical Assessment of Energy-economy-climate Models. URL <http://publications.lib.chalmers.se/records/fulltext/>.
- James, Laura K., Swinton, Scott M., Thelen, Kurt D., 2010. Profitability analysis of cellulosic energy crops compared with corn. *Agron. J.* 102 (2), 675. <http://dx.doi.org/10.2134/agronj2009.0289>. ISSN 1435-0645.
- Khanna, Madhu, Dhungana, Basanta, Clifton-Brown, John, 2008. Costs of producing miscanthus and switchgrass for bioenergy in Illinois. *Biomass Bioenergy* 32 (6), 482–493. <http://dx.doi.org/10.1016/j.biombioe.2007.11.003>. ISSN 09619534.
- Krasuska, Ewa, Rosenqvist, Håkan, 2012. Economics of energy crops in Poland today and in the future. *Biomass Bioenergy* 38, 23–33. <http://dx.doi.org/10.1016/j.biombioe.2011.09.011>. ISSN 09619534.
- Kretschmer, Bettina, Peterson, Sonja, 2010. Integrating bioenergy into computable general equilibrium models — a survey. *Energy Econ.* 32 (3), 673–686. <http://dx.doi.org/10.1016/j.eneco.2009.09.011>. ISSN 01409883.
- KTBL, 2012. *Energiepflanzen: Daten für die Planung des Energiepflanzenanbaus: KTBL Datensammlung, 2. edition*. KTBL, Darmstadt. ISBN 978-3-941583-65-8.
- Martinsen, Dag, Funk, Carolin, Linssen, Jochen, 2010. Biomass for transportation fuels—a cost-effective option for the German energy supply? *Energy Policy* 38 (1), 128–140. <http://dx.doi.org/10.1016/j.enpol.2009.08.064>. ISSN 0301-4215.
- Millinger, M., Ponitka, Jens, Arendt, Oliver, Thrän, Daniela, 2016. Competitiveness of advanced and conventional biofuels: results from least-cost modelling of biofuel competition in Germany. *Energy Policy* 0301–4215. Submitted. ISSN.
- Miranowski, J., Rosburg, A., 2010. *An Economic Breakeven Model of Cellulosic Feedstock Production and Ethanol Conversion with Implied Carbon Pricing*. Pregger, Thomas, Nitsch, Joachim, Naegler, Tobias, 2013. Long-term scenarios and strategies for the deployment of renewable energies in Germany. *Energy Policy*

- 59, 350–360. <http://dx.doi.org/10.1016/j.enpol.2013.03.049>. ISSN 0301-4215.
- Searle, Stephanie Y., Malins, Christopher J., 2014. Will energy crop yields meet expectations? *Biomass Bioenergy* 65, 3–12. <http://dx.doi.org/10.1016/j.biombioe.2014.01.001>. ISSN 09619534.
- Simon, Sonja, Wiegmann, Kirsten, 2009. Modelling sustainable bioenergy potentials from agriculture for Germany and Eastern European countries. *Biomass Bioenergy* 33 (4), 603–609. <http://dx.doi.org/10.1016/j.biombioe.2008.10.001>. ISSN 09619534.
- Statistisches Bundesamt, 2016. *Anbaufläche ausgewählter Anbaukulturen im Zeitvergleich*.
- Steubing, Bernhard, Zah, Rainer, Ludwig, Christian, 2012. Heat, electricity, or Transportation? The optimal use of residual and waste biomass in Europe from an environmental perspective. *Environ. Sci. Technol.* 46 (1), 164–171. <http://dx.doi.org/10.1021/es202154k>. ISSN 0013-936X.
- Sunde, K., Brekke, A., Solberg, B., 2011. Environmental impacts and costs of woody Biomass-to-Liquid (BTL) production and use — a review. *For. Policy Econ.* 13 (8), 591–602. <http://dx.doi.org/10.1016/j.forpol.2011.05.008>. ISSN 13899341.
- Thrän, Daniela, Arendt, Oliver, Ponitka, Jens, Braun, Julian, Millinger, Markus, Wolf, Verena, Banse, Martin, Schaldach, Rüdiger, Schüngel, Jan, Gärtner, Sven, Rettenmeier, Nils, Hünecke, Katja, Hennenberg, Klaus, Wern, Bernhard, Baur, Frank, Fritsche, Uwe, Gress, Hans-Werner, 2015. *Meilensteine 2030: Elemente und Meilensteine für die Entwicklung einer tragfähigen und nachhaltigen Bioenergiestrategie*. Leipzig, pp. 2199–2762. ISBN.
- Tilman, D., Hill, J., Lehman, C., 2006. Carbon-negative biofuels from low-input high-diversity grassland biomass. *Science* 314 (5805), 1598–1600. <http://dx.doi.org/10.1126/science.1133306>. ISSN 0036-8075.
- Wang, C., 2009. *Economic Analysis of Delivering Switchgrass to a Biorefinery from Both the Farmer's and Processor's Perspectives*. The University of Tennessee, Knoxville and Tennessee. PhD thesis.
- Witzel, Carl-Philipp, Finger, Robert, 2016. Economic evaluation of Miscanthus production — a review. *Renew. Sustain. Energy Rev.* 53, 681–696. <http://dx.doi.org/10.1016/j.rser.2015.08.063>. ISSN 13640321.
- World Bank, 2016. *Global Economic Monitor (GEM) Commodities: Wheat*, HRW (URL [databank.worldbank.org](http://databank.worldbank.org)).



## Paper 3

# Relative greenhouse gas abatement cost competitiveness of biofuels in Germany



Millinger, M., Meisel, K., Budzinski, M. and Thrän, D.

*Preprints (2017), Submitted to Energies*



Article

# Relative greenhouse gas abatement cost competitiveness of biofuels in Germany

Markus Millinger<sup>1\*</sup> , Kathleen Meisel<sup>2</sup>, Maik Budzinski<sup>1</sup>  and Daniela Thrän<sup>1,2</sup>

<sup>1</sup> Dep. of Bioenergy, Helmholtz Centre for Environmental Research - UFZ, Permoserstraße 15, 04318 Leipzig, Germany

<sup>2</sup> Dep. of Bioenergy Systems, Deutsches Biomasseforschungszentrum - DBFZ, Torgauer Straße 116, 04347 Leipzig, Germany

\* Correspondence: markus.millinger@ufz.de; Tel.: +49 341 2434 595

Academic Editor:

Version December 17, 2017 submitted to *Energies*

**Abstract:** Transport biofuels derived from biogenic material are used for substituting fossil fuels, thereby abating greenhouse gas (GHG) emissions. Numerous competing conversion options exist to produce biofuels, with differing GHG emissions and costs. In this paper analysis and modelling of the long-term development of GHG abatement and relative GHG abatement cost competitiveness between crop-based biofuels in Germany is carried out. Presently dominant conventional biofuels and advanced liquid biofuels were found not to be competitive compared to the substantially higher yielding options available: sugar beet based ethanol for the short to medium term least-cost option and Substitute Natural Gas (SNG) for the medium to long term. The competitiveness of SNG was found to depend highly on the emissions development of the power mix. Silage maize based biomethane was found competitive on a land area basis, but not on an energetic basis. Due to land limitations as well as cost and GHG uncertainty, a stronger focus on the land use of crop-based biofuels should be laid in policy.

**Keywords:** biofuels; greenhouse gas; ghg; abatement cost; modelling; competition

## 1. Introduction

Biofuels are one way to reduce the GHG emissions of transport, which in Germany stands for 21% of total societal emissions [1]. Germany has, as the currently only EU country, set a goal of reducing the greenhouse gas (GHG) emissions of land transport through biofuels or other renewable options, instead of an energetic biofuel goal which was previously in place, in common with the other countries.

Currently, both biomass residues as well as dedicated crops are used for biofuels production in Germany. Rape seed based biodiesel (RME) and starch crop based bioethanol, both conventional biofuels, are the most common pathways [2]. However, these have a low overall yield and thus limited potential compared to other available options, which also makes them not competitive in the long run on an energetic basis [3]. The cost-competitiveness on a GHG abatement basis is also in focus [e.g. 4], thus making the GHG abatement cost developments of biofuels highly relevant.

The GHG abatement cost of different biofuels is highly variable between options, time-points and regions. A long-term cost-effective greenhouse gas abatement through the deployment of biofuels requires a thorough analysis on both the highly uncertain future potential costs [3,5] as well as on the uncertain biofuel pathway emissions [6–8], both of which depend on numerous factors, with land use as one combining factor. Particularly for biofuels from dedicated crops, the GHG abatement on a land use basis is an important indicator [7] and the discussion around land use has lead Germany to set a limit for conventional biofuels [9], albeit on an energetic basis.

31 Although both life-cycle emissions [6,7,10,11] as well as costs [3,5,12–15] of different biofuels have  
32 been well covered in literature, a combined detailed assessment of GHG abatement cost relations to  
33 date has not. For instance, Tomaschek *et al.* [16] performed such a study on the case of South Africa  
34 for conventional biofuels and Schmidt *et al.* [17] performed a comparison of different energetic usages  
35 of woody biomass in Austria, both for one single year. However, to our knowledge studies assessing  
36 relative GHG abatement costs and competitiveness developments over time for both conventional and  
37 advanced biofuels have not been published to date.

38 In this paper, these aspects are combined into an investigation on potential relative GHG abatement  
39 cost developments and uncertainties of biofuels from dedicated crops in a German context. The following  
40 research questions are assessed:

- 41 • How may the greenhouse gas abatement of crop based biofuels develop in a German context, and  
42 are there differences between energetic and land use functional units?
- 43 • How may the relative greenhouse gas abatement costs of German crop based biofuels develop in  
44 the future?
- 45 • How would the biofuel deployment develop if GHG abatement costs are the sole deciding factor,  
46 and how sensitive are the results to parameter variations?

## 47 2. Materials and methods

### 48 2.1. Modelling

49 In order to model the competition between different technology options, a simulation model has  
50 previously been developed. BENSIM (BioENERgy SIMulation Model) is a myopic recursive dynamic  
51 bottom-up least-cost simulation model with endogenous technological learning, seeking the least-cost  
52 mix of biofuel production options on a yearly basis for fulfilling a set demand. Through the recursive  
53 elements of learning effects and previously built capacities, path dependencies can be captured by the  
54 model.

55 The existing biofuel plant infrastructure in the region in focus (here Germany) is the basis at  
56 the initial time point of the modelling. For each year of the simulation, BENSIM first removes the  
57 plants that have reached the end of their life-time (assumed at 25 years). A minimum market price  
58 ( $p_{sys}$ ) is then calculated, defined by the marginal cost (MC) of the most expensive option in the merit  
59 order<sup>1</sup> which is put into production to meet the given biofuel demand. If there are options which have  
60 total costs ( $TC = \text{levelised capital cost} + MC$ ) lower than the  $p_{sys}$ , capacity investments take place,  
61 beginning with the option with the lowest TC. This continues until the market price adjusts on a  
62 level below the TC of still available options and the system reaches a (partial) equilibrium. After the  
63 investment phase, biofuel production takes place following the merit order based on marginal costs of  
64 production, until the given biofuel target is fulfilled. It is assumed that the biofuel demand can adapt in  
65 order to accommodate a cost-optimal deployment, and that it is not restricted by quota. BENSIM has  
66 been more thoroughly described in Millinger *et al.* [5]. For the feedstock costs, BENSIM was expanded  
67 with a methodology for estimating the costs of energy crops, through adding the per hectare profit of a  
68 benchmark crop (wheat) to the per hectare production cost of the energy crop [3].

69 The model is here transformed to have relative GHG abatement cost (instead of an energetic cost  
70 used previously) as the deciding factor, with a GHG abatement goal (instead an energetic goal) to be  
71 reached through substituting fossil fuels by the deployment of biofuels. The costs of the options on an  
72 energetic basis [ $\text{€ GJ}^{-1}$ ] are calculated according to [5], with the feedstock costs calculated according  
73 to [3]. The costs are an output of the modelling, as learning effects affect the investment costs of

---

<sup>1</sup> All options with existing capacities are sorted by ascending marginal cost, with the capacities brought into use in that order until the given demand is met.

the options if they expand due to their relative competitiveness. Feedstock costs are exogenous, with scenario differences.

In order to come up with the relative GHG abatement costs, some additional calculations are required. Firstly, the GHG emissions of each biofuel pathway need to be calculated and secondly, the total costs per GHG abatement unit need to be derived.

Equation 1 shows the total GHG emissions  $\varepsilon_{tot,j}^{(t)}$  [kgCO<sub>2eq</sub> GJ<sub>fuel</sub><sup>-1</sup>] of option  $j$  at time-point ( $t$ ) as a sum of all emissions in the different stages of the process:  $F$ , feedstock cultivation;  $T_1$ , transport of the biomass to the conversion facility;  $P_1$ , first process step (with allocation factor  $\alpha_1$ );  $P_2$ , second process step ( $\alpha_2$ ); transport of the fuel to the fuelling station  $T_2$ . The input data is all related to the feedstock input [ $t_{FM}$ ], except for the final fuel transport, whereby a conversion to GJ<sub>fuel</sub> is performed through division by feedstock energy content  $e_j$  [GJ t<sub>FM</sub><sup>-1</sup>] multiplied by fuel conversion efficiency  $\eta_j$ . The inputs for the feedstock cultivation are on a hectare basis, thus a division by yield  $Y_j$  [t<sub>FM</sub> ha<sup>-1</sup>] is necessary. The emissions of all process steps preceding the end of  $P_1$  are allocated to the fuel according to  $\alpha_1$ , whereas those preceding the end of  $P_2$  are additionally allocated according to  $\alpha_2$ .

For each input to any process, for all inputs  $k$  belonging to the respective process steps, the input amount  $\dot{m}_{k,j}^{(t)}$  is multiplied by its emission factor  $\varepsilon_k^{(t)}$ . Byproducts which are not considered in the allocation, but through a credit, are denoted  $cr$ .

$$\begin{aligned} \varepsilon_{tot,j}^{(t)} = & \frac{\alpha_1 \alpha_2}{e_j \eta_j} \left( \frac{1}{Y_j^{(t)}} \sum_{k \in F} \dot{m}_{k,j}^{(t)} \varepsilon_k^{(t)} + \sum_{k \in T_1} \dot{m}_{k,j}^{(t)} \varepsilon_k^{(t)} + \sum_{k \in P_1} \dot{m}_{k,j}^{(t)} \varepsilon_k^{(t)} - \dot{m}_{cr,j}^{(t)} \varepsilon_{cr}^{(t)} \right) \\ & + \frac{\alpha_2}{e_j \eta_j} \left( \sum_{k \in P_2} \dot{m}_{k,j}^{(t)} \varepsilon_k^{(t)} - \dot{m}_{cr,j}^{(t)} \varepsilon_{cr}^{(t)} \right) + \sum_{k \in T_2} \dot{m}_{k,j}^{(t)} \varepsilon_k^{(t)} \end{aligned} \quad (1)$$

The total costs  $TC_{j,e}^{(t)}$  are divided by the avoided fossil GHG emissions minus the biofuel pathway GHG emissions  $\varepsilon_{tot,j}^{(t)}$ , in order to come up with the relative<sup>2</sup> GHG abatement cost  $TC_{j,\Delta\varepsilon}^{(t)}$  [€ kgCO<sub>2eq</sub><sup>-1</sup>] for time point ( $t$ ) of option  $j$  (Equation 2).

$$TC_{j,\Delta\varepsilon}^{(t)} = TC_{j,e}^{(t)} \left( \varepsilon_{ref} - \varepsilon_{tot,k}^{(t)} \right)^{-1} \quad (2)$$

## 2.2. Data and assumptions

The biofuels options included are the same as in Millinger *et al.* [5], where the techno-economic data are described in detail, with the addition of starch based (wheat) bioethanol, data for which is described in Ponitka *et al.* [18, p.40f]. The feedstock data are elaborated in Millinger and Thrän [3].

The GHG emissions are calculated on a well-to-tank (WTT) basis (see Figure 1). Thus, end-use efficiencies are not included, as these developments are dependent on numerous vehicle market factors which are outside of the scope of this paper to assess. It can be noted that specific emissions of average diesel and gasoline driven passenger cars have almost converged in the past decade [19, p.34].

<sup>2</sup> i.e. without the avoided cost of the substituted fossil fuel

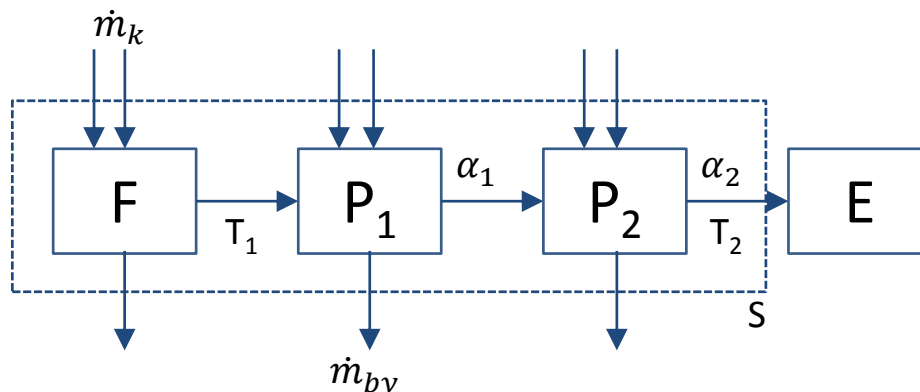

**Figure 1.** System boundaries of the Well-To-Tank (WTT) assessment from feedstock cultivation to tank for each pathway, shown by the dashed line S. The resulting abatement is compared on the basis of different functional units, such as GHG abatement per energy unit, cost per GHG abatement and GHG abatement per land area used. F=feedstock cultivation; T= transport; P<sub>1</sub>= process one; P<sub>2</sub>= process two; E= end use;  $\dot{m}_k$ = process inputs;  $\dot{m}_{by}$ = process by-products;  $\alpha$  = allocation factor. The end use as well as potential indirect land use effects are not included. The biofuel combustion is assumed to be carbon neutral, as the carbon absorbed during plant growth is emitted, thus closing the cycle.

102 For the GHG-emissions of the pathways, detailed references for rape-seed based biodiesel (RME)  
 103 [20], sugar beet based bioethanol [21] and silage maize based biomethane [22] were used as a basis.  
 104 For biofuels based on short-rotation coppice (SRC), data from KTBL [23] and Neeft and Ludwiczek  
 105 [24] were used for poplar, which was used to represent SRCs. For all options, the medium yields were  
 106 assumed, as in Millinger and Thrän [3].

107 In the literature, a byproduct credit is included for liquid CO<sub>2</sub>, which is output from the BeetEtOH  
 108 process. Although this is based on a real plant (from where it is used for beverage carbonation), it  
 109 can be argued that a large scale substitution of liquid fossil CO<sub>2</sub> is not feasible due to small scale uses  
 110 of CO<sub>2</sub> (a large share of which is in the fossil industry) and a potentially large future oversupply [25,  
 111 p.81ff]. Therefore, since the scope of this paper is on a systems level and not on the individual plant  
 112 level, this credit is removed.

113 Switching from natural gas to wood chips for heating provides a significant contribution for heat  
 114 intensive processes (the biomethane process was already in the literature assumed to be heated through  
 115 wood chips). However, the wood chips cannot be assumed to be residual biomass, as the total German  
 116 heat demand alone by far surpasses the wood residue potential<sup>3</sup>. Instead, poplar is assumed to be the  
 117 biomass for the heat source (with an efficiency of  $\eta_{th}=80\%$ ), with price developments from Millinger  
 118 and Thrän [3] consistent with the other biomass types and GHG emissions presented here.

119 For RME, an additional emission source is the methanol input, which can be assumed to be of  
 120 renewable origin, with BeetEtOH as an approximation for the costs, emissions and land requirement.

121 The other main options to reduce the pathway GHG emissions are to swap from fossil diesel  
 122 to biodiesel (or another biofuel) input for farming and transport, swapping to a fertiliser with less  
 123 production emissions, as well as reducing the power emissions. All three options are assumed to rely  
 124 largely on system improvements and not to be within the scope of producers' individual decision, and  
 125 thus for all three an improvement over time is assumed.

126 For the N<sub>2</sub>O emissions, the BioGrace I [28] and II [24] tools were used for the conventional and  
 127 advanced options, respectively. The variation of field N<sub>2</sub>O emissions is both crop specific as well as  
 128 spatially dependent, and is highly variable. Thus, this factor must be included in a sensitivity analysis.

129 Land use change emissions as well as infrastructural emissions for conversion plants were excluded.

<sup>3</sup> The residual wood potential has been estimated to ca. 800 PJ [26]. Total current German heat demand amounts to ca 5000 PJ [27, p.C9]

130 The absolute GHG abatement cost is dependent on the cost development of the substituted fossil  
131 fuel. In this paper modelling, focus lies on the relative GHG abatement costs and competitiveness, i.e.  
132 ignoring the fossil fuel cost. The same fossil fuel reference is used for all biofuels [83.8 kgCO<sub>2eq</sub> GJ<sup>-1</sup>  
133 29]. While the emissions of this reference are relatively foreseeable, the cost developments are not: as a  
134 decoupling of agricultural products and fossil fuels is conceivable under a large global transition away  
135 from fossil fuels, developing consistent scenarios merging these two potentially independent variables is  
136 bound with perverse uncertainties. It is therefore in this paper abstained from assessing the absolute  
137 GHG abatement costs, as the results are likely misleading in the long term.

**Table 1.** Summarised important metrics for the biofuel options included. Some small contributions to the emissions come from other minor sources, which can be found in the respective detailed sources. The heat and power input data has been adapted from [5] for BioCH<sub>4</sub> [22], BeetEtOH [21] and RME [20], in order to fit with the detailed GHG calculation and allocation steps. For BeetEtOH (P1 dried beet pulp; P2 vinasse), StarchEtOH (Distillers Grains with Solubles, DDGS) and RME (P1 rape seed meal; P2 glycerol) co-products are produced, for which the emissions up until that point are allocated according to below. Emissions factors (EF): diesel 3.14 kgCO<sub>2</sub> l<sup>-1</sup>, sinking linearly to 20% of that value in 2050; N fertiliser 5.88 kgCO<sub>2</sub> kgN<sup>-1</sup>, sinking linearly to 20% in 2050; N<sub>2</sub>O 298 kgCO<sub>2</sub> kgN<sub>2</sub>O<sup>-1</sup>; power mix 0.47 kgCO<sub>2eq</sub> kWh<sup>-1</sup> in the beginning, sinking according to [30, p.120]; heat 0.067 kgCO<sub>2</sub> MJ<sub>NG</sub><sup>-1</sup> or wood chips calculated internally with  $\eta=0.8$ . For the transport of the biomass, 24 t<sub>FM</sub> are transported, with 80 km loaded and 20 km empty, with fuel a consumption of 0.41 and 0.24 l km<sup>-1</sup>, respectively. For the transport of the fuel, 50 t are transported, with 150 km loaded and 50 km empty and the same fuel consumption. For the gaseous fuels, 4.625 kWh<sub>el</sub> GJ<sup>-1</sup> and 1.6 MJ<sub>th</sub> GJ<sup>-1</sup> are assumed to be required for the injection into the gas grid. The transport assumptions were all used from Majer *et al.* [20], Meisel *et al.* [21], Oehmichen *et al.* [22]

Fuel		BioCH <sub>4</sub>	BeetEtOH	StarchEtOH	RME	BioSNG	LignoEtOH	FT
Feedstock		Maize silage	Sugar beet	Wheat	Rape seed	Poplar	Poplar	Poplar
Yield medium	GJ <sub>feed</sub> ha <sup>-1</sup>	268-327	254	115	84	143-214	143-214	143-214
Yield low	GJ <sub>feed</sub> ha <sup>-1</sup>	208-268	176-215					
N fertilizer	kgN (ha-a) <sup>-1</sup>	63.2	119.7	109.3	137.4			
Diesel equivalent	l (ha-a) <sup>-1</sup>	96	175.9	106	82.6	2.1	2.1	2.1
N <sub>2</sub> O field emis avg	kgN <sub>2</sub> O (ha-a) <sup>-1</sup>	4.66	4.59	2.92	4.19	1.28	1.28	1.28
N <sub>2</sub> O field emis low	kgN <sub>2</sub> O (ha-a) <sup>-1</sup>	1.06	1.11	0.71	1.0	0.28	0.28	0.28
N <sub>2</sub> O field emis high	kgN <sub>2</sub> O (ha-a) <sup>-1</sup>	23.37	20.78	13.27	19.45	6.72	6.72	6.72
Alloc. factor P1	[frac]		0.94	0.595	0.65			
Alloc. factor P2	[frac]		0.7		0.96			
Conv. eff. tot	$\eta$	0.56-0.70	0.6-0.66	0.48-0.53	0.59-0.62	0.58-0.73	0.36-0.44	0.35-0.45
2 <sup>nd</sup> feedstock	kg GJ <sup>-1</sup>				3.3 (MeOH)			
Net heat input	kWh GJ <sup>-1</sup>	65	134	123	22	0	0	0
Net power input	kWh GJ <sup>-1</sup>	14	10	17	1.6	31	35	35



### 138 2.3. Scenarios

139 For all scenarios, the GHG abatement target for crop-based biofuels is set at 4 MtCO<sub>2eq</sub> for the  
 140 beginning<sup>4</sup>, or 2.5% of the current 160 MtCO<sub>2eq</sub> total German transport emissions [31], increasing  
 141 linearly by a factor of five to 20 MtCO<sub>2eq</sub> in 2050 (or about 12.5% of current fuel demand). The mostly  
 142 relevant GHG inputs (fertiliser, process heat) are assumed to be optimised already in the base case, as  
 143 compared to literature.

144 All scenarios include all biofuels, both liquid and gaseous. Cases including only liquid fuels are  
 145 assessed in the sensitivity analysis, in order to assess the competitiveness if gaseous fuels are not a  
 146 large-scale solution. A 4% a<sup>-1</sup> reference feedstock price increase is assumed as a basis, in line with  
 147 developments in the past decade [3].

148 The power mix contributes significantly to the GHG emissions of biofuels. Within the goals of the  
 149 German energy transition, different pathways can be taken in order to achieve the set GHG reductions  
 150 and renewables targets. A near linear development [30, p.123] can be contrasted to one where coal power  
 151 is quickly decommissioned [30, p.120], leading to earlier reductions despite the end point goal being the  
 152 same. The effect of this is assessed, with a moderate power mix in scenario a, and a progressive power  
 153 mix in scenarios b-c.

154 Silage maize and sugar beet have a high humus requirement, which in the long run may be  
 155 detrimental to the land fertility if not curbed, through reducing yields and a combination with other  
 156 crops which have a net negative humus requirement [23, p.272ff.]. With the medium yields assumed,  
 157 this can to some extent be assured, but it is still interesting to assess the effect on the competitiveness  
 158 if low yield spans are assumed for these two crops (see Table 1). Lower yields are assumed in scenario c.

159 Table 2 summarises the main scenarios.

**Table 2.** Scenario summary. The base case (a) includes both liquid and gaseous fuels and assumes a moderate power mix development according to [30, p.123], a wheat price increase of 4% a<sup>-1</sup>, GHG optimised process heat and medium yields for all crops. Scenario variations compared to base case are listed.

Description	
a	Base - all fuels, moderate power mix
b	Progressive power mix development [30, p.120]
c	Prog. power mix, low yields for sugar beet and maize

### 160 2.4. Sensitivity analysis

161 The sensitivity analysis is in this paper performed through Monte Carlo simulation, which is a way  
 162 of mapping out the solution space depending on variance in input variables without calculating all  
 163 possible combinations. The method used here is elaborated in Millinger and Thrän [3].

164 Table 3 summarises the parameters which are varied in the sensitivity analysis. The first nine  
 165 parameters are the same as in Millinger and Thrän [3], and are motivated there. Additionally, some  
 166 parameters relevant for the GHG emissions are necessary. The soil N<sub>2</sub>O emissions [8] are varied between  
 167 the low and high values (Table 1), with a uniform probability distribution. All parameters in Table 3  
 168 are varied simultaneously, in a random fashion.

169 As the power mix and feedstock cost increases as well as the inclusion of gaseous biofuels have a  
 170 significant impact on the competitiveness, the results are shown over these three dimensions, independent  
 171 of the main scenarios in Section 2.3: moderate and progressive power mix developments; reference  
 172 feedstock price increases of 3% and 4% a<sup>-1</sup>; including all fuels or only liquid fuels. Four main sensitivity

<sup>4</sup> Corresponding to the average for crop-based biofuels used in Germany 2014-2016 [2], with assumed GHG abatement values for the crop shares of 63% for EtOH and 55% for RME, compared to a reference of 83.8 kgCO<sub>2eq</sub> GJ<sup>-1</sup>.

173 cases result, for which the developments of key options are shown, with and without gaseous fuels  
174 included.

**Table 3.** Parameters varied in the Monte Carlo sensitivity analysis. All parameters have a uniform distribution over the span. The distributions which vary between the technology specific minimum and maximum values start at a random point along the span and increase linearly to a value randomly between the starting point and the maximum value. The technology-specific values are individually randomised for each technology option. The yields are varied within the medium ranges for all crops.

Parameter	Unit	Span
Initial investment cost	M€ MW <sub>cap</sub> <sup>-1</sup>	±25%
Exogenous learning	years	3-10
Discount rate	%	5-10
Conversion efficiency	$\eta$	min-max
Yield	t <sub>FM</sub> ha <sup>-1</sup>	min-max
Establishment cost (perennials)	€ ha <sup>-1</sup>	±25%
Investment distribution limit	%	10-20
Path dependency factor	%	15-25
Capacity ramp	%	100-200%
Soil N <sub>2</sub> O emissions	%	low-high

### 175 3. Results

176 The results are shown first for the biofuel GHG emissions, then for the relative GHG abatement costs,  
177 followed by the scenario modelling and finally sensitivity analysis.

#### 178 3.1. Biofuel GHG emissions

179 The resulting GHG emissions are shown in Figure 2. For each biofuel option, the far left bar is the  
180 standard literature case (for reference; not used in the scenarios). The second bar shows the present  
181 pathway emissions in the base case when correcting for practises that can be sustained on a larger  
182 scale and assuming biomass from dedicated crops for the heat and secondary feedstocks. The third bar  
183 shows the pathway emissions in the last year of the base scenario (a), where the power mix is nearly  
184 fully renewable, and renewable fuels and fertiliser are used as inputs.

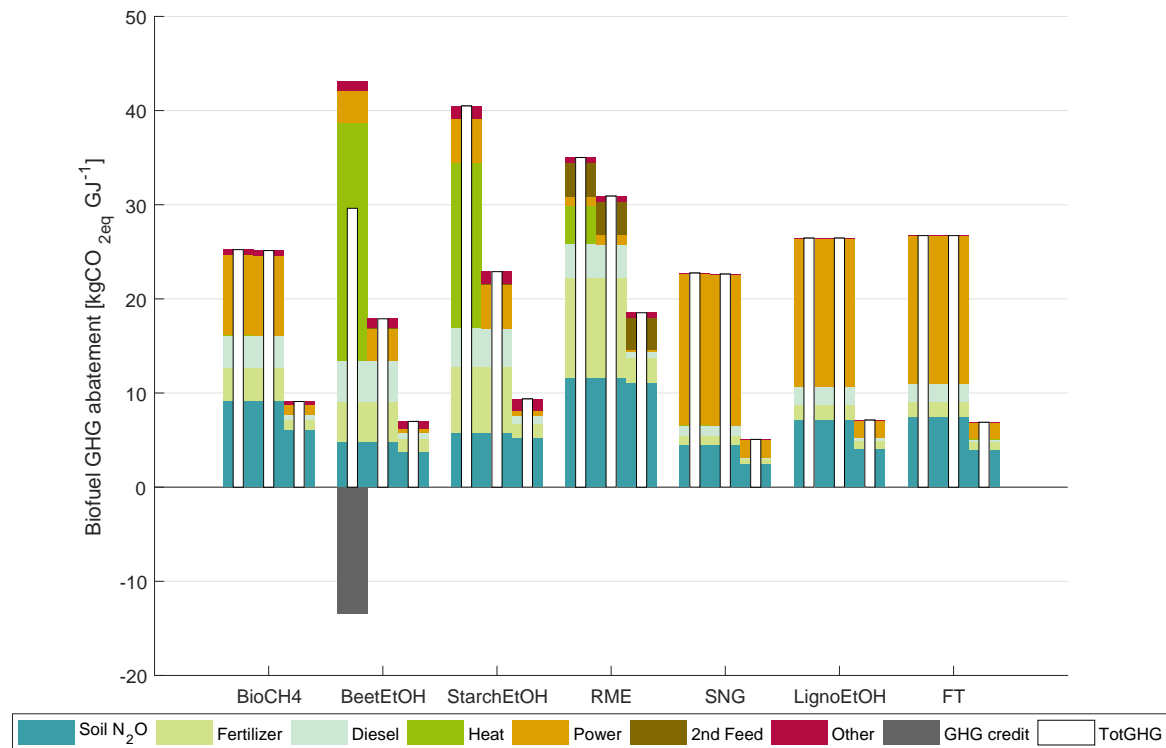

**Figure 2.** GHG emissions for the biofuel options, broken down to their sources [ $\text{kgCO}_{2\text{eq}} \text{GJ}^{-1}$ ]. The leftmost bar for each option is the reference literature case; the middle bar shows the results for the start year of the base case, with renewable heat input; the rightmost bar shows the results for the last year of the base case, where the power mix is cleaner, yields and conversions efficiencies improved, and renewable fuel and fertiliser inputs assumed.

185 In the beginning, thus BeetEtOH is the better performing option in terms of GHG abatement  
 186 per energy unit, with SNG second and StarchEtOH third best. Currently dominant RME is in fact  
 187 the worst option. Through the system improvements, the advanced options gradually improve and  
 188 overtake BeetEtOH (Figures 2 & 3). Assuming a fast power mix emission improvement through coal  
 189 decommissioning as in scenarios (b) and (c), SNG is fast the best option, whereas at moderate power mix  
 190 developments this takes considerably longer. Of the advanced options, SNG performs clearly better due  
 191 to higher conversion efficiencies and lower power demand, whereas LignoEtOH and FT-diesel perform  
 192 similarly to each other. It should however be noted that the options, with the exception of RME,  
 193 achieve between 67-79% GHG abatement in the beginning, and again excepting RME, between 88-96%  
 194 GHG abatement in the end. Thus, the differences are relatively small, leaving ample room for cost  
 195 developments to change the priority order when comparing relative GHG abatement costs.

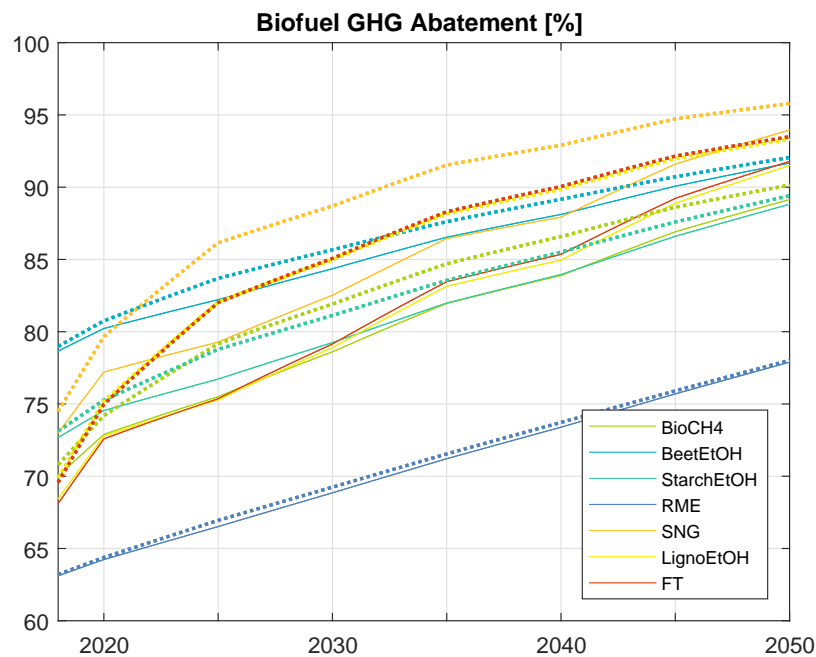

**Figure 3.** Biofuel GHG abatement development, compared on an energetic basis with the fossil reference. The solid lines show the development at a moderate power mix development, whereas the dotted lines show the development at a more progressive power mix development.

196 It can be noted that the "other" factors are relatively marginal in comparison to the other sources  
 197 (Figure 2). Thus, simplified calculations excluding the other inputs where data are not available (such  
 198 as for the advanced options) provide a sufficient estimate for the total GHG emissions.

199 As a consequence of switching from natural gas to wood chips from dedicated crops for the heat  
 200 input, the land required for the options increases corresponding to the heat requirement (Figure 4).  
 201 For BeetEtOH, the land requirement increases by 49% while at the same time increasing the GHG  
 202 abatement by 22%; for StarchEtOH the land required increases by 36% with a 41% GHG abatement  
 203 increase; for BioCH<sub>4</sub> land use increases by 24% (the reference already assumed renewable heat). For  
 204 RME, the land use increases by 9% through a renewable heat input, with an additional 3% through the  
 205 methanol input, while increasing GHG abatement by 8%.

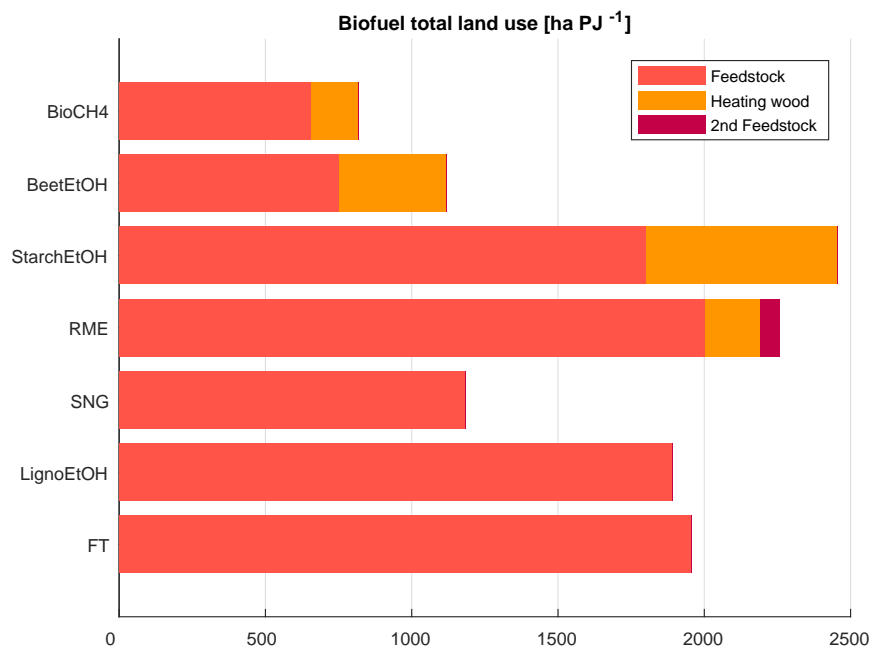

**Figure 4.** Biofuel land requirement by source in the first year of the base case.

206 The GHG abatement per hectare is shown for the base case in Figure 5. RME and StarchEtOH can  
 207 abate 2-3 tCO<sub>2eq</sub> ha<sup>-1</sup>, whereas BioCH<sub>4</sub> and BeetEtOH are the present day best, with 6-7 tCO<sub>2eq</sub> ha<sup>-1</sup>.  
 208 With a clean power mix and renewable input fertiliser and fuel, in addition to yield and conversion  
 209 efficiency improvements, BioCH<sub>4</sub> and SNG can potentially achieve over 12 tCO<sub>2eq</sub> ha<sup>-1</sup>. BeetEtOH  
 210 can achieve a maximal 8 tCO<sub>2eq</sub> ha<sup>-1</sup>, somewhat more than the liquid advanced biofuel options.

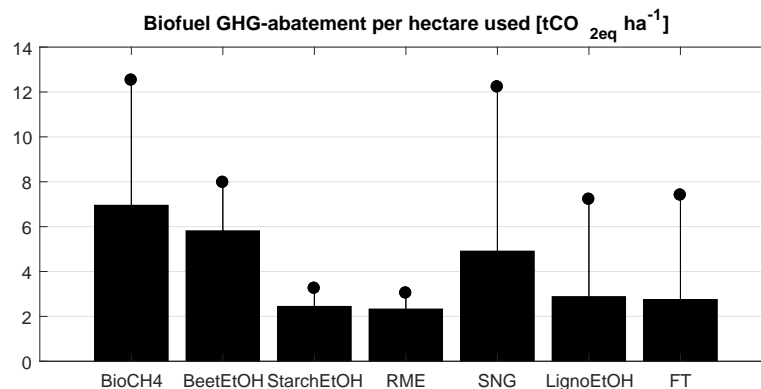
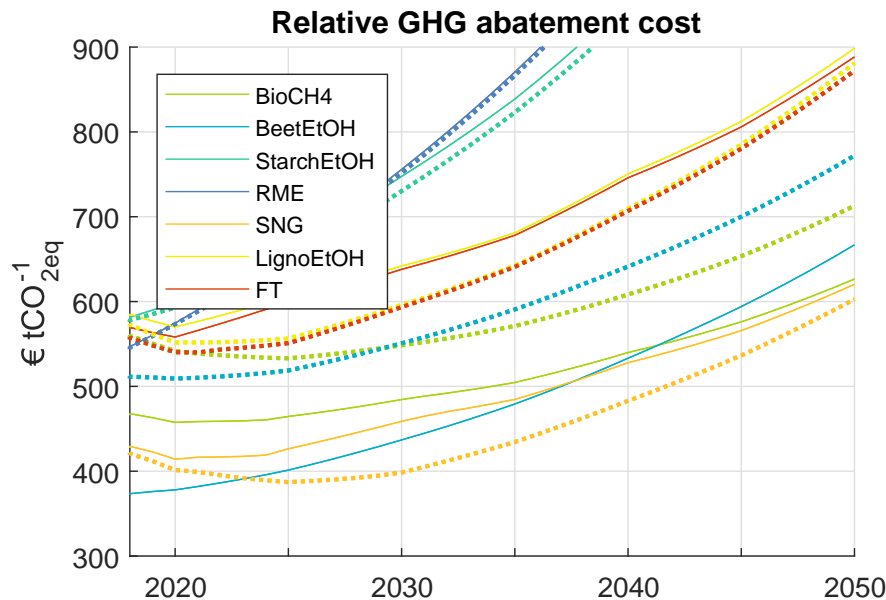

**Figure 5.** Biofuel GHG abatement per hectare in the base case with medium yields for all crops. The bar shows the initial GHG abatement, whereas the whisker extends to the GHG abatement in the last year.

211 Notably, the merit order of the fuels differs when compared on a hectare basis and an energetic  
 212 basis. Whereas BioCH<sub>4</sub> is the best both for the beginning of the simulation in the base scenario in  
 213 terms of GHG abatement per hectare as well as in the long run (Figure 5), it is only fourth best in  
 214 terms of GHG abatement on an energetic basis for the beginning (Figure 3) - even after StarchEtOH -  
 215 and it is only fifth best in the long run.

216 *3.2. Biofuel relative GHG abatement cost*

217 From the competition modelling, relative GHG abatement cost developments emerge, which are  
 218 highly different between scenarios. In Figure 6, the extreme span of possible outcomes in the scenarios  
 219 is sketched between scenarios (a) and (c), with a more progressive power mix development and lower  
 220 sugar beet and silage maize yields in the latter case.



**Figure 6.** Biofuel relative GHG abatement cost developments [ $\text{€ tCO}_{2eq}^{-1}$ ] in scenarios (a, solid lines) and (c, dotted lines). Some developments are outside of the plot: the cost of RME increases to ca.  $1350 \text{ € tCO}_{2eq}^{-1}$  and the cost of StarchEtOH increases to ca.  $1230 \text{ € tCO}_{2eq}^{-1}$  in both cases.

221 In scenario (a), BeetEtOH is the least cost option until 2037, when it is overtaken by SNG due  
 222 to the combined effects of input emission improvements, conversion efficiency and yield increases and  
 223 technological learning. SNG remains the least-cost option, slowly diverging with, but never surpassed  
 224 by BioCH<sub>4</sub>. Due to the annual 4% reference feedstock price increase, the minimum selling prices of all  
 225 options generally increase. The exception to this are all advanced fuels in the first few years, when  
 226 mainly the power mix emission reductions lead to slight overall relative GHG abatement cost reductions.

227 The least cost option over time increases from ca  $370 \text{ € tCO}_{2eq}^{-1}$  to  $620 \text{ € tCO}_{2eq}^{-1}$ . The two liquid advanced  
 228 biofuel options start from ca.  $570 \text{ €}$  and increase towards  $900 \text{ €}$ , while the currently dominant biofuels  
 229 RME and StarchEtOH increase from around  $550$  and  $580 \text{ €}$  to over  $1300$  and  $1200 \text{ € tCO}_{2eq}^{-1}$ , respectively.  
 230 The advanced liquid fuels remain at an around 50% higher cost than the least-cost fuel, whereas for  
 231 RME and StarchEtOH, the difference increases substantially over time.

232 In scenario (c), significant differences compared to (a) can be seen. Primarily, SNG starts off as  
 233 the least cost option, or compared to with medium sugar beet yields, quickly surpasses BeetEtOH. Due  
 234 to a combination of more rapid input GHG emission decreases and technological learning, minimum  
 235 selling prices remain around  $400 \text{ € tCO}_{2eq}^{-1}$  until 2030, with a subsequent increase to  $600 \text{ € tCO}_{2eq}^{-1}$   
 236 towards the end.

237 The two liquid advanced biofuel options increase towards  $870 \text{ €}$ , while RME and StarchEtOH  
 238 develop similarly to in scenario (a). The advanced liquid fuels also in this case remain at an around 50%  
 239 higher cost than the least-cost fuel, while the difference increases over time for RME and StarchEtOH.  
 240 For the advanced liquid fuels, it can be observed (Figure 6) that they remain at higher cost than  
 241 BeetEtOH even in scenario (c).

242 Notably, between diesel fuels, FT-diesel is quickly competitive with RME in any case, and thus  
 243 sub-quota for diesel and petrol would favour advanced options, albeit at a higher cost than without  
 244 sub-quota.

### 245 3.3. Scenario modelling

246 From the GHG abatement cost competition, the resulting production developments can be seen  
 247 in Figure 7. In all cases, both StarchEtOH and RME fall out of the market rather quickly. Instead  
 248 BeetEtOH, as well as in the scenarios where all fuels are included SNG and BioCH<sub>4</sub>, gain market shares  
 249 in differing proportions between the scenarios. The advanced liquid options do not achieve significant  
 250 market shares in any scenario.

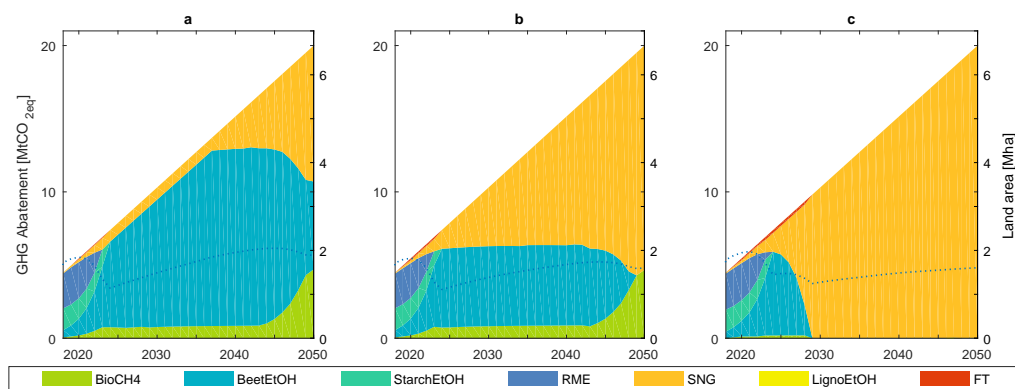

**Figure 7.** Biofuel competitiveness based on relative GHG abatement cost in the scenarios. The areas show the total performed GHG abatement through each option (left axis), whereas the dotted line shows the total arable land required (right axis). The base scenario (a) includes both liquid and gaseous fuels and assumes a moderate power mix development according to [30, p.123], a wheat price increase of 4% a<sup>-1</sup>, GHG optimised process heat and medium yields for all crops. In scenario (b), the power mix is more progressive and in scenario (c), additionally the sugar beet and silage maize yields are assumed within the low range in Table 1.

251 In the base case (a), BeetEtOH dominates in the medium term, with SNG and BioCH<sub>4</sub> both  
 252 gaining market shares, respectively from ca. 2035 and 2040 onwards. At a more progressive power mix  
 253 (b), SNG starts gaining market shares more rapidly, while BioCH<sub>4</sub> remains almost the same as in the  
 254 base case. Gaseous fuels dominate fully towards the end. If additionally low yields for silage maize and  
 255 sugar beet are assumed (c), SNG fully dominates the market within a decade.

256 The resulting required total arable land (including for heating purposes and secondary feedstocks)  
 257 differs marginally between the scenarios, with an almost constant ca. 2 Mha used once RME and  
 258 StarchEtOH are displaced (Figure 7). Thus, yield and conversion efficiency improvements compensate  
 259 for the GHG abatement target increase.

### 260 3.4. Sensitivity analysis

261 From the sensitivity analysis, the resulting occurrences at different total market shares are shown  
 262 for four cases (Figure 8), where the reference feedstock costs increase by 3% ("1") and 4% ("2") a<sup>-1</sup>,  
 263 while the power mix is either moderate (A) or progressive (B). At moderate power developments,  
 264 BeetEtOH dominates, with BioCH<sub>4</sub> more often emerging at slightly higher cumulative market shares  
 265 at higher feedstock cost increases. SNG remains at below 10% total market share in around 80% of the  
 266 cases, with a slightly higher occurrence of market shares of over 10%. For SNG, there is a jump in  
 267 the amount of occurrences at over 50% cumulative market shares, indicating that under favourable  
 268 conditions, a threshold is surpassed early, leading to learning effects and increasing returns.

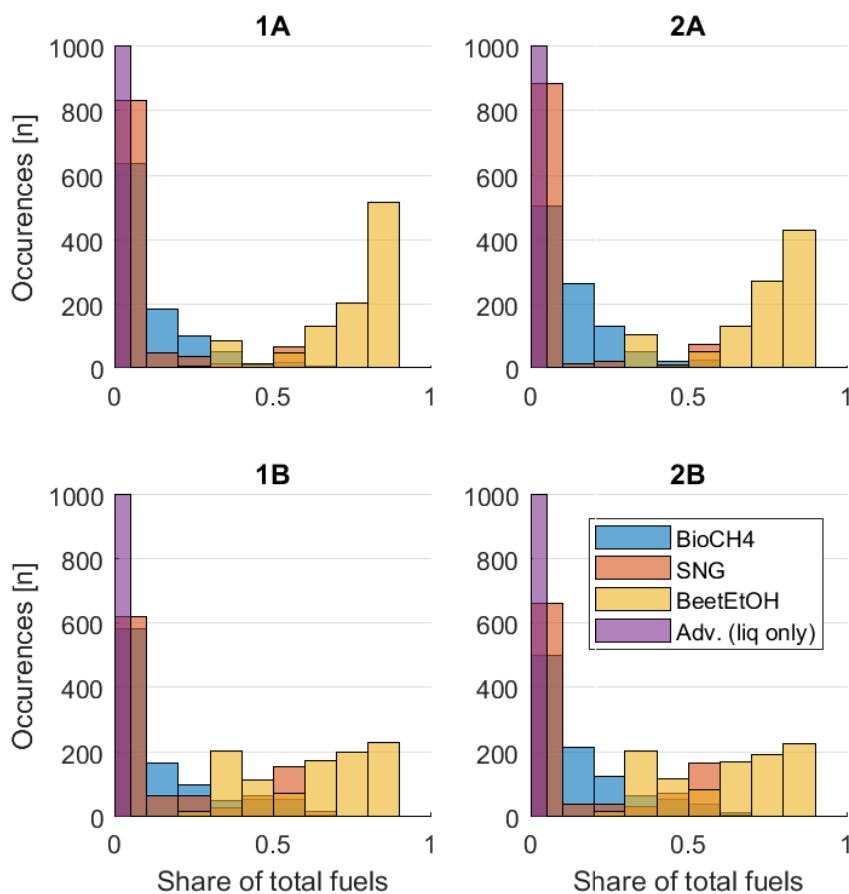

**Figure 8.** Sensitivity of biofuel production shares, at annual 3% (1) and 4% (2) wheat price increases, with moderate (A) and more progressive (B) power mix developments. 2A and 2B correspond to the sensitivities within scenarios (a) and (b). The number of occurrences among the 1000 runs at total cumulative biofuel shares (on an energetic basis) of between 0-10%, 10-20% etc. are shown in the histogram. The shares are of the total cumulative biofuel deployment over the whole time span. The colour tone of the bars in the histogram is summed where they overlap. In each sub-plot, the emergence of BioCH<sub>4</sub>, SNG and BeetEtOH for runs with all fuels included is shown, as well as is the emergence of advanced liquid fuels (LignoEtOH and FT-diesel summed together) for runs with only liquid fuels. Thus, each sub-plot shows two separate sets of sensitivity runs with 1000 runs each, totalling 4000 runs for all subplots.

269 At more progressive power mix developments, BeetEtOH still dominates in most cases, but the  
 270 occurrences between 30-90% market share are more uniformly distributed. BioCH<sub>4</sub> behaves similarly  
 271 to in the case of a moderate power mix development, while the effect on the competitiveness of SNG is  
 272 substantial, with substantially more occurrences between 10-60% cumulative market shares.

273 In very few of the cases do the gaseous fuels arrive at cumulative market shares of above 60%, and  
 274 BeetEtOH achieves cumulative market shares of above 30% in almost all cases.

275 For the advanced liquid biofuels, the share remains at below 5% in all of the observed cases, despite  
 276 the fact that only liquid fuels were included.

277 The biofuel cost sensitivity is shown in Figure 9. In contrast to on an energetic basis [3], the  
 278 sensitivity of the relative GHG abatement cost of RME is high, due mainly to the uncertain soil  
 279 emissions. The relative GHG abatement costs of the advanced liquid biofuels are also highly uncertain,  
 280 with more than a factor of three difference for the low and high end even at the beginning. In contrast,  
 281 SNG shows clearly less uncertainty, despite stemming from the same feedstock. BeetEtOH, followed by  
 282 BioCH<sub>4</sub> show the lowest spans, across time-points.



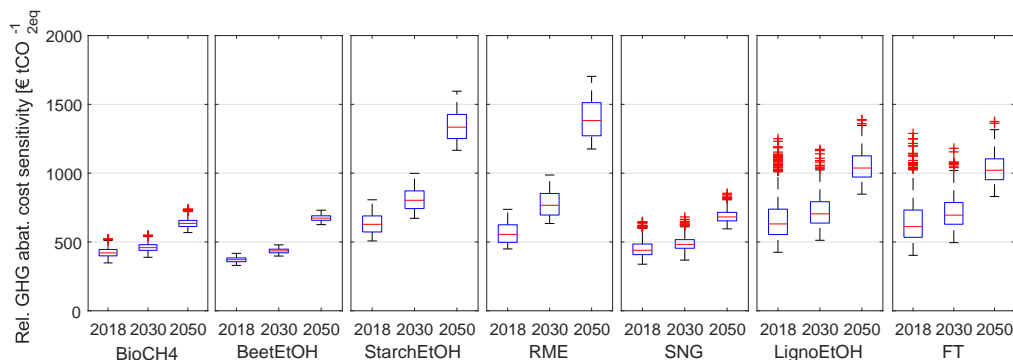

**Figure 9.** Sensitivity of total cost of the GHG abatement of biofuels in 2018, 2030 and 2050 in sensitivity case 1B (corresponding to the base scenario (a)), at a constant annual 4% wheat price increase and the other variables randomly varied according to Section 2.4. The red lines show the median, the bottom and top edges of the blue box show the 25th and 75th percentiles, respectively, the whiskers extend to a maximum of 1.5 times the length of the box and outside of this interval outliers are plotted with a red cross.

#### 283 4. Discussion

284 In this paper, feedstock cost developments of biofuels have been combined with GHG abatement  
 285 developments in order to estimate future spans of relative GHG abatement costs for the different  
 286 options, and their competitiveness. From the point of view of a cost-optimal GHG abatement through  
 287 the deployment of biofuels, the current practise emerged as increasingly divergent to the best options.

288 Whereas advanced biofuels were found to be competitive only at low feedstock price increases  
 289 when comparing the fuels on an energetic basis [3], especially SNG was found to be competitive even at  
 290 higher feedstock price increases on a GHG abatement basis. Furthermore, the power mix development  
 291 is in fact more important for the competitiveness of advanced biofuels than are feedstock cost increase  
 292 differences. This is due to the fact that the power mix emissions have a substantially different impact  
 293 on the various biofuel options, as the power input requirements differ. Differing soil emissions result  
 294 in additionally divergent GHG abatement and especially GHG abatement and thus relative GHG  
 295 abatement cost uncertainty.

296 Liquid advanced biofuels were competitive only when gaseous fuels were not included, and even  
 297 then only at very favourable conditions. In the sensitivity analysis, all relevant factors except lower  
 298 sugar beet yields were varied, resulting in an almost complete absence of advanced liquid biofuels.  
 299 Thus, the competitiveness of advanced liquid biofuels requires low sugar beet yields to be enforced, in  
 300 addition to other favourable circumstances working together, as well as gaseous fuels being excluded.

301 The biofuel amounts required towards the end of the time span correspond to about 13% of  
 302 current fuel demand (or in the case of large expansion of e.g. electric vehicles, a correspondingly higher  
 303 market share). A continuation of the present quota would require marginally more, due to the slightly  
 304 lower GHG abatement of advanced FT-diesel, but at an at least 50% higher cost compared to without  
 305 sub-quota for diesel and gasoline fuels. The resulting least-cost practises would imply mixing BeetEtOH  
 306 into petrol at higher shares than today, requiring some modifications to the vehicles [32, p.21], and for  
 307 gaseous fuels, the current demand needs to increase manifold in order to accommodate the least-cost  
 308 developments. If this is not possible, BeetEtOH is a possible long-term second-best option, albeit with  
 309 significantly lower GHG abatement potential per unit of arable land compared to the gaseous options.

310 A slight trade-off was found between optimising the GHG emissions from the input heat and the  
 311 resulting additional land required for the lignocellulosic crops used for this purpose, which in the case  
 312 of BeetEtOH amounted to 49%, while increasing the GHG abatement by 22%. Thus, this additional  
 313 land is motivated, but the benefits may be somewhat reduced through emissions related to land use.

314 Indirect Land use change (iLUC) emissions have been highlighted as a problem with crop cultivation.  
 315 If applied for the attribution to the GHG abatement of the biofuel options, these emissions are a function

316 of yield, as well as are to some extent direct soil emissions<sup>5</sup>. Thus, both are arguments for increasing  
317 the hectare GHG abatement of biofuels, through swapping from the presently used low-yielding crops  
318 to higher yielding options. The highest yielding options included here are BioCH<sub>4</sub> and SNG, both  
319 gaseous fuels. The former is based on silage maize, which (similarly to sugar beet) consumes soil  
320 humus [23, p.272ff.] and in the worst case has relatively high soil N<sub>2</sub>O emissions. Soil erosion and N<sub>2</sub>O  
321 emission need to be monitored and curbed in order to ensure sustainable biofuel practises. A more  
322 holistic approach including all relevant environmental factors is necessary in order to avoid sub-optimal  
323 practises, and the risk of high soil emissions needs to be taken into account and assessed.

324 GHG abatement cost in terms of € tCO<sub>2eq</sub><sup>-1</sup> does not give the full picture, as the GHG abatement  
325 in energetic terms deviates from that in terms of required arable land, which sets a hard limit for  
326 biofuels from dedicated crops. For BioCH<sub>4</sub>, the difference between the GHG abatement on an energetic  
327 basis compared to on a land use basis is particularly large (cf. Figures 3 and 5). The GHG abatement  
328 cost difference between BioCH<sub>4</sub> and BeetEtOH as well as SNG was also found to be large (Figure 6)  
329 compared to the GHG abatement per land used.

330 The total possible GHG abatement is limited by available arable land and residual biomass, and  
331 thus for an overall optimal GHG abatement, total yields need to be taken into account. A GHG  
332 abatement cost also ignores other relevant environmental metrics [see e.g. 34], such as biodiversity, soil  
333 erosion, pesticide use, freshwater use and land use change. In such a comparison, it would be beneficial  
334 to compare biofuel options according to land area, as some biofuels may perform worse in some metrics  
335 but through higher yields would free land which can be for instance conserved [cf. 35], thus potentially  
336 rendering the overall impact better.

337 Thus, in terms of several both direct and indirect environmental aspects, as well as in terms  
338 of economic [3] and social aspects (e.g. food competition), a switch to higher yielding fuels would  
339 be beneficial, especially if at the same time other relevant environmental effects are monitored and  
340 curbed. In order to achieve such a shift, presently used biofuels need to be exchanged with either  
341 bioethanol or gaseous fuels if the least-cost target and highest GHG abatement are to be achieved, or  
342 if this is proven to be infeasible, replacing RME with FT-diesel would be necessary in terms of both  
343 GHG abatement cost as well as absolute GHG abatement. For the advanced options, especially liquid  
344 ones, both unpredictable feedstock costs and highly uncertain investment costs may inhibit such a  
345 development [3]. However, in terms of GHG abatement, the benefits are more clear than in energetic  
346 terms.

347 As noted in Millinger and Thrän [3], perennials currently have a higher market price than those  
348 resulting with the method used, which can be at least partly explained by small markets as well as farmer  
349 risk considerations. Until the market demand for perennial lignocellulosic biomass is stable enough for  
350 the investment risk to be reduced, higher prices should be expected, thus potentially postponing the  
351 deployment of biofuels based on such crops.

352 The use of so called degraded or marginal lands has been suggested in order to avoid land use  
353 change emissions and food competition [36]. Although yields would be strongly affected compared to  
354 currently used arable land [37], the competitiveness compared to non-perennials is obvious, as the latter  
355 would likely not be cultivated on such lands.

## 356 5. Conclusions

357 In this paper, a thorough assessment of long term relative GHG abatement cost developments of biofuel  
358 options in Germany has been carried out. The better performing of the included biofuel options in  
359 terms of GHG abatement cost was sugar beet based ethanol for the short to medium term, and SNG  
360 for the medium to long term.

---

<sup>5</sup> the latter is also related to agricultural practises, which can be substantially improved [33]

361 The currently most common biofuels were found to have over 40% higher relative GHG abatement  
362 costs than the least cost option for the beginning, and increasing substantially over time, due to higher  
363 relative feedstock cost increases.

364 Liquid advanced biofuel options were only found to be competitive at a combination of favourable  
365 circumstances, and were in normal circumstances about 50% more expensive than the least-cost option  
366 throughout the whole time span.

367 The competitiveness of advanced biofuels was found to be more sensitive to the emissions  
368 development of the power mix than on feedstock costs, as this factor is more differentiated between the  
369 high-performing fuels.

370 Through switching from currently most common biofuels RME and StarchEtOH to BioCH<sub>4</sub> and  
371 SNG, the GHG abatement per land area can potentially be increased by a factor of five. For the  
372 present day, a switch to BioCH<sub>4</sub> and BeetEtOH with renewable heat sources trebles the spatial GHG  
373 abatement, despite the fact that the heat source requires substantial amounts of land.

374 A discrepancy between GHG abatement in relation to energetic output compared to land output  
375 was found, having important consequences especially for the competitiveness of BioCH<sub>4</sub>. BioCH<sub>4</sub>  
376 was mostly not GHG abatement cost competitive and did not achieve high market shares in any  
377 scenario, while on a land use basis it was the best already in the beginning as well as in the long term.  
378 Although the land use was reflected to some extent in the cost competitiveness, larger differences and a  
379 substantially switched merit order resulted when comparing them on an area basis.

380 Due to the large spread of possible pathway emissions as well as cost developments, measures to  
381 quantify and curb emissions in each section of the pathway are called for in order to reduce uncertainties,  
382 starting from the specific field used, through the conversion as well as in the end use.

383 Finally, there are strong arguments, both social, economic and environmental, for including  
384 the required arable land for biofuels into policy and functional units, instead of merely energy or  
385 GHG abatement [cf. 9]. Such a differentiation between crop-based biofuels can potentially lead to a  
386 substantially higher GHG abatement from the same arable land area, through incentives to switch to  
387 higher yielding gaseous options.

388 **Supplementary Materials:** The following are available online at [www.mdpi.com/link](http://www.mdpi.com/link), Figure S1: title, Table  
389 S1: title, Video S1: title.

390 **Acknowledgments:** This work was funded by the Helmholtz Association of German Research Centers and  
391 supported by Helmholtz Impulse and Networking Fund through Helmholtz Interdisciplinary Graduate School  
392 for Environmental Research (HIGRADE).

393 **Author Contributions:** Millinger had the idea with contributions from Meisel, Millinger developed the model  
394 and performed the modelling; Millinger, Meisel and Budzinski analyzed the data and results; Millinger wrote  
395 the paper with contributions from Meisel, Budzinski and Thrän.

396 **Conflicts of Interest:** The authors declare no conflict of interest. The founding sponsors had no role in the  
397 design of the study; in the collection, analyses, or interpretation of data; in the writing of the manuscript, and  
398 in the decision to publish the results.

## 399 Abbreviations

400 The following abbreviations are used in this manuscript:

401

BENSIM	Bioenergy simulation model
BeetEtOH	Sugar beet based bioethanol
BioCH <sub>4</sub>	Silage maize based biomethane
DM	Dry matter
EF	Emission factor
FM	Fresh matter
FT	Woody biomass (poplar) based Fischer-Tropsch-diesel
GHG	Greenhouse gas
iLUC	Indirect land use change
402 LignoEtOH	Woody biomass (poplar) based bioethanol
LUC	Land use change
MC	Marginal cost
NG	Natural gas
RME	Rape seed methylester - biodiesel
SNG	Substitute natural gas
SRC	Short rotation coppice
StarchEtOH	Starch crop based bioethanol
TC	Total cost
WTT	Well to tank

## 403 References

- 404 1. EEA. European Environment Agency Greenhouse Gas Data Viewer:  
405 [www.eea.europa.eu/data-and-maps/data/data-viewers/greenhouse-gases-viewer](http://www.eea.europa.eu/data-and-maps/data/data-viewers/greenhouse-gases-viewer), 2017.
- 406 2. BLE. *Hintergrunddaten zum Evaluations- und Erfahrungsbericht 2016*; Bundesanstalt für Landwirtschaft  
407 und Ernährung: Bonn, 2017.
- 408 3. Millinger, M.; Thrän, D. Biomass price developments inhibit biofuel investments and research in  
409 Germany: the crucial future role of high yields. *Journal of Cleaner Production* **2016**.
- 410 4. Fraunhofer ISI.; Consentec.; IFEU. Langfristszenarien für die Transformation des Energiesystems in  
411 Deutschland: Modul 1: Hintergrund, Szenarioarchitektur und übergeordnete Rahmenparameter: Studie  
412 im Auftrag des Bundesministeriums für Wirtschaft und Energie, 2017.
- 413 5. Millinger, M.; Ponitka, J.; Arendt, O.; Thrän, D. Competitiveness of advanced and conventional biofuels:  
414 Results from least-cost modelling of biofuel competition in Germany. *Energy Policy* **2017**, *2017*, 394–402.
- 415 6. Menten, F.; Chèze, B.; Patouillard, L.; Bouvart, F. A review of LCA greenhouse gas emissions results  
416 for advanced biofuels: The use of meta-regression analysis. *Renewable and Sustainable Energy Reviews*  
417 **2013**, *26*, 108–134.
- 418 7. Cherubini, F.; Strømman, A.H. Life cycle assessment of bioenergy systems: State of the art and future  
419 challenges. *Bioresource Technology* **2011**, *102*, 437–451.
- 420 8. Crutzen, P.J.; Mosier, A.R.; Smith, K.A.; Winiwarter, W. N<sub>2</sub>O release from agro-biofuel production  
421 negates global warming reduction by replacing fossil fuels. *Atmospheric Chemistry and Physics* **2008**,  
422 *8*, 389–395.
- 423 9. BImSchV. Achtunddreißigste Verordnung zur Durchführung des Bundes-Immissionsschutzgesetzes  
424 (Verordnung zur Festlegung weiterer Bestimmungen zur Treibhausgasminderung bei Kraftstoffen): 38.  
425 BImSchV. *Bundesgesetzblatt Teil 1 In press*.
- 426 10. Yan, X.; Inderwildi, O.R.; King, D.A. Biofuels and synthetic fuels in the US and China: A review of  
427 Well-to-Wheel energy use and greenhouse gas emissions with the impact of land-use change. *Energy &*  
428 *Environmental Science* **2010**, *3*, 190.
- 429 11. Malça, J.; Freire, F. Life-cycle studies of biodiesel in Europe: A review addressing the variability of  
430 results and modeling issues. *Renewable and Sustainable Energy Reviews* **2011**, *15*, 338–351.
- 431 12. Festel, G.; Würmseher, M.; Rammer, C.; Boles, E.; Bellof, M. Modelling production cost scenarios for  
432 biofuels and fossil fuels in Europe. *Journal of Cleaner Production* **2014**, *66*, 242–253.
- 433 13. Haarlemmer, G.; Boissonnet, G.; Imbach, J.; Setier, P.A.; Peduzzi, E. Second generation BtL type  
434 biofuels – a production cost analysis. *Energy & Environmental Science* **2012**, *5*, 8445.

- 435 14. Haarlemmer, G.; Boissonnet, G.; Peduzzi, E.; Setier, P.A. Investment and production costs of synthetic  
436 fuels – A literature survey. *Energy* **2014**, *66*, 667–676.
- 437 15. Browne, J.; Nizami, A.S.; Thamsiriroj, T.; Murphy, J.D. Assessing the cost of biofuel production with  
438 increasing penetration of the transport fuel market: A case study of gaseous biomethane in Ireland.  
439 *Renewable and Sustainable Energy Reviews* **2011**, *15*, 4537–4547.
- 440 16. Tomaschek, J.; Özdemir, E.D.; Fahl, U.; Eltrop, L. Greenhouse gas emissions and abatement costs of  
441 biofuel production in South Africa. *GCB Bioenergy* **2012**, *4*, 799–810.
- 442 17. Schmidt, J.; Leduc, S.; Dotzauer, E.; Kindermann, G.; Schmid, E. Cost-effective CO<sub>2</sub> emission reduction  
443 through heat, power and biofuel production from woody biomass: A spatially explicit comparison of  
444 conversion technologies. *Applied Energy* **2010**, *87*, 2128–2141.
- 445 18. Ponitka, J.; Arendt, O.; Lenz, V.; Daniel-Gromke, J.; Stinner, W.; Ortwein, A.; Zeymer, M.; Gröngröft,  
446 A.; Müller-Langer, F.; Klemm, M.; Braun, J.; Zeug, W.; Thrän, D.; O’Keeffe, S.; Millinger, M. *Focus  
447 on: Bioenergy-Technologies: Conversion pathways - towards biomass energy use in the 21st century*, 2  
448 ed.; DBFZ: Leipzig, 2016.
- 449 19. ICCT. *European vehicle market statistics: Pocketbook 2016/2017*; International Council on Clean  
450 Transportation Europe, 2016.
- 451 20. Majer, S.; Gröngröft, A.; Drache, C.; Braune, M.; Meisel, K.; Müller-Langer, F.; Naumann, K.;  
452 Oehmichen, K. *Technical principles and methodology for calculating GHG balances of biodiesel: Guidance  
453 document: Version 1.0*; DBFZ: Leipzig, 2016.
- 454 21. Meisel, K.; Braune, M.; Gröngröft, A.; Majer, S.; Müller-Langer, F.; Naumann, K.; Oehmichen, K.  
455 *Technical principles and methodology for calculating GHG balances of Bioethanol: Guidance Document:  
456 Version 1.0*; DBFZ: Leipzig, 2016.
- 457 22. Oehmichen, K.; Naumann, K.; Postel, J.; Drache, C.; Braune, M.; Gröngröft, A.; Majer, S.; Meisel, K.;  
458 Müller-Langer, F. *Technical principles and methodology for calculating GHG balances of Biomethane:  
459 Guidance document: Version 1.0*; DBFZ: Leipzig, 2016.
- 460 23. KTBL. *Energiepflanzen: Daten für die Planung des Energiepflanzenanbaus: KTBL Datensammlung*, 2  
461 ed.; KTBL: Darmstadt, 2012.
- 462 24. Neeft, J.; Ludwiczek, N. BioGrace II - harmonized greenhouse gas calculations for electricity, heating  
463 and cooling from biomass: [www.biograce.net](http://www.biograce.net), 2015.
- 464 25. Parsons Brinckerhoff. *Accelerating the uptake of CCS: Industrial use of captured carbon dioxide*; Global  
465 CCS Institute, 2011.
- 466 26. Brosowski, A.; Thrän, D.; Mantau, U.; Mahro, B.; Erdmann, G.; Adler, P.; Stinner, W.; Reinhold, G.;  
467 Hering, T.; Blanke, C. A review of biomass potential and current utilisation – Status quo for 93 biogenic  
468 wastes and residues in Germany. *Biomass and Bioenergy* **2016**, *95*, 257–272.
- 469 27. BMWi. *Energiedaten: Gesamtausgabe: Stand: Oktober 2017*; Bundesministerium für Wirtschaft und  
470 Energie, 2017.
- 471 28. Neeft, J.; te Buch, S.; Gerlagh, T.; Gagnepain, B.; Bacovsky, D.; Ludwiczek, N.; Lavelle, P.; Thonier,  
472 G.; Lechon, Y.; Lago, C.; Herrera, I.; Georgakopoulos, K.; Komioti, N.; Fehrenbach, H.; Hennecke,  
473 A.; Parikka, M.; Kinning, L.; Wollin, P. BioGrace -harmonized calculations of biofuel greenhouse gas  
474 abatement: Publishable final report for grant agreement IEE/09/736: [www.biograce.net](http://www.biograce.net), 2012.
- 475 29. EU. Directive 2009/28/EC of the European Parliament and of the Council of 23 April 2009 on the  
476 promotion of the use of energy from renewable sources and amending and subsequently repealing  
477 Directives 2001/77/EC and 2003/30/EC, 2009.
- 478 30. WWF. *Zukunft Stromsystem: Kohleausstieg 2035 - vom Ziel her denken*; World Wildlife Foundation:  
479 Berlin, 2017.
- 480 31. BMUB. *Klimaschutzplan 2050 – Klimaschutzpolitische Grundsätze und Ziele der Bundesregierung*:  
481 [www.bmub.bund.de](http://www.bmub.bund.de), 2016.
- 482 32. IPCC. *Climate Change 2014: Mitigation of Climate Change: Chapter 8 - Transport*. In *Climate Change  
483 2014: Mitigation of Climate Change*; IPCC., Ed.; IPCC: Cambridge University Press, Cambridge, United  
484 Kingdom and New York, NY, USA, 2014.
- 485 33. Skenhall, S.A.; Berndes, G.; Woods, J. Integration of bioenergy systems into UK agriculture—New  
486 options for management of nitrogen flows. *Biomass and Bioenergy* **2013**, *54*, 219–226.

- 487 34. Rockstrom, J.; Steffen, W.; Noone, K.; Persson, A.; Chapin, F. Stuart.; Lambin, E.F.; Lenton, T.M.;  
488 Scheffer, M.; Folke, C.; Schellnhuber, H.J.; Nykvist, B.; de Wit, Cynthia A.; Hughes, T.; van der Leeuw,  
489 Sander.; Rodhe, H.; Sorlin, S.; Snyder, P.K.; Costanza, R.; Svedin, U.; Falkenmark, M.; Karlberg, L.;  
490 Corell, R.W.; Fabry, V.J.; Hansen, J.; Walker, B.; Liverman, D.; Richardson, K.; Crutzen, P.; Foley, J.A.  
491 A safe operating space for humanity. *Nature* **2009**, *461*, 472–475.
- 492 35. Vadenbo, C.; Tonini, D.; Astrup, T.F. Environmental Multiobjective Optimization of the Use of Biomass  
493 Resources for Energy. *Environmental Science & Technology* **2017**.
- 494 36. Tilman, D.; Hill, J.; Lehman, C. Carbon-Negative Biofuels from Low-Input High-Diversity Grassland  
495 Biomass. *Science* **2006**, *314*, 1598–1600.
- 496 37. Searle, S.Y.; Malins, C.J. Will energy crop yields meet expectations? *Biomass and Bioenergy* **2014**,  
497 *65*, 3–12.

498 © 2017 by the authors. Submitted to *Energies* for possible open access publication  
499 under the terms and conditions of the Creative Commons Attribution (CC BY) license  
500 (<http://creativecommons.org/licenses/by/4.0/>).

## Paper 4

# Climate optimal deployment of biofuels from crops in Germany

Millinger, M., Meisel, K. and Thrän, D.

*Submitted*





# Climate optimal deployment of biofuels from crops in Germany

M. Millinger<sup>a,\*</sup>, K.Meisel<sup>b</sup>, D. Thrän<sup>a,b</sup>

<sup>a</sup>Dep. of Bioenergy, Helmholtz Centre for Environmental Research - UFZ, Permoserstraße 15, 04318 Leipzig, Germany

<sup>b</sup>Dep. of Bioenergy Systems, Deutsches Biomasseforschungszentrum - DBFZ, Torgauer Straße 116, 04347 Leipzig, Germany

---

## Abstract

The optimal role of biofuels from energy crops for greenhouse gas (GHG) abatement in the German transport sectors is investigated under different progressive long-term scenarios, from a set arable land area corresponding to current use. The sectors included are land passenger and goods transport, shipping and aviation. The GHG abatement from the same land area can be increased by a factor of five through switching to higher yielding biofuel options. Silage maize based biomethane and wood based Synthetic Natural Gas (SNG), in either gaseous or liquefied form are the options with the highest GHG abatement potential per arable land unit, and thus markets where such fuels are an option should be prioritised. Sector fuel restrictions combined with fuel yields resulted in the land passenger sector to be the first priority for maximising GHG abatement, followed by land goods transport, shipping and finally aviation. Only when the previous sectors have been covered by renewable options do the following become relevant and thus a large transition is required before aviation biofuels or any liquid advanced biofuel become the climate optimal use of biomass. Applying admixture quotas to sub-sectors yields a lower GHG abatement than an optimal strategy.

*Keywords:* biofuels, greenhouse gas abatement, GHG, optimization, transport, land use

---

## 1. Introduction

The Paris Agreement goal of staying below 1.5°C of global warming (UNFCCC, 2015) requires rapid global efforts of decarbonisation (Rockström et al., 2017). Beside a goal of complete decarbonisation until 2050, the path leading there is crucial, with early system shifts potentially significantly reducing the cumulative carbon emissions over the time period.

A complete decarbonisation of the transport sector relies heavily on power based solutions, such as electric vehicles (EVs), hydrogen (H<sub>2</sub>) and other electrofuels (Power-to-X, PtX) (Armaroli and Balzani, 2011; Sandy Thomas, 2009; Dunn, 2002; Sterner, 2009; König et al., 2015). However, the deployment of these alternatives requires some time and the environmental advantage is dependent on the renewables development in the power mix, which determines the GHG emissions of power based transport solutions. Also, some sectors, such as shipping, goods transport and aviation may be slower than personal transport in adapting to renewable modes and fuels, due to less available options (IPCC, 2014, p.19).

Biofuels are another option to reduce the climate impact of transport, which are already being used. However, potential and sustainability constraints set limits for their deployment and thus biofuels may play an important role as an intermediate decarbonisation solution until other renewable options can take over.

In this paper, the optimal role of biofuels from energy crops for greenhouse gas (GHG) abatement in the German transport sectors is investigated under different long-term scenarios. The following research questions are assessed:

- How would biofuels from energy crops be deployed in order to maximise GHG abatement under progressive decarbonisation scenarios?
- How do biofuel deployment, GHG abatement and costs differ under different scenarios?

---

\*Corresponding author. Tel: +49(0)3412434595

Email address: markus.millinger@ufz.de (M. Millinger)

## 2. Materials and methods

### 2.1. Modelling

For optimising the GHG abatement of biofuels, a model has been developed, building on the model BENSIM (Millinger et al., 2017b; Millinger and Thrän, 2016; Millinger et al., 2017a). Instead of simulating the biofuel development, an optimisation module has been developed in GAMS. The technology and scenario data are imported and generated in BENSIM/Matlab, and then exported to GAMS. Using the Cplex solver, the optimal GHG abatement under the given restrictions is calculated and the results sent back to Matlab, where plotting is performed.

The model is fully deterministic, bottom-up and uses perfect foresight. The objective function used here is maximising the GHG abatement  $\varepsilon_{tot}$  [tCO<sub>2eq</sub>] over the whole time period  $t$ , as a sum of all produced biofuels  $\pi_{i,t}$  [PJ] multiplied by their net GHG abatement  $\varepsilon_{i,t} - \varepsilon_{sub,t}$ , with  $\varepsilon_{sub,t} = 83.8$  [ktCO<sub>2eq</sub> PJ<sup>-1</sup>], for all options  $i$  and time points  $t$ .

The model restrictions are as follows: the biofuel production  $\pi_{i,t}$  for option  $i$  in time  $t$  is the sum of production in all sectors  $s$ , with a total demand  $\delta_{s,t}$  [PJ] for each sector which sets an upper limit for the total production of all options for each sector in each time point. The production cannot surpass the capacity available  $\kappa_{i,t}$ .

The capacity is the sum of the capacity in the previous year,  $\kappa_{i,t}$  [PJ] and new capacities  $\kappa_{i,t+1}^+$ , minus the capacities  $\kappa_{i,t-\hat{t}_i}^+$  which have reached the end of their life time  $\hat{t}_i = 25$  [a]. Capacities available at the beginning  $\kappa_0$  are decommissioned linearly over their life time. Capacity expansion is subject to the sum of a constant ramp factor  $r_{min} = 0.1$  [PJ a<sup>-1</sup>] and the product of standing capacity and  $r_f = 0.5$ , and cannot surpass  $r_{max} = 25$  [PJ a<sup>-1</sup>]. This sets a system inertia and ensures that capacities cannot expand suddenly, resulting in S-curve shaped market share increases (cf. Grubler, 1998).

The required land for each option is given by the production, divided by yield  $Y_{i,t}$  times conversion efficiency  $\eta_{i,t}$ . The total land use cannot surpass  $\Lambda_t = 1.5$  [Mha] (in most scenarios in this paper) for each time point.

If a biofuel quota is in place, the quota  $q_t = 0.5$  is the fraction of diesel fuels  $i \in I_{di}$  to ethanol  $i \in I_{pe}$ .

$$\max_{\varepsilon} \quad \varepsilon_{tot} = \sum_{i,t} (\varepsilon_{i,t} - \varepsilon_{sub,t}) \cdot \pi_{i,t} \quad (1a)$$

s.t.

$$\pi_{i,t} = \sum_s \pi_{i,t,s}, \quad \forall (i, t, s) \in (I, S, T), \quad (1b)$$

$$\delta_{s,t} \geq \sum_{i \in s} \pi_{i,s,t}, \quad \forall (i, s, t) \in (I, S, T), \quad (1c)$$

$$\pi_{i,t} \leq \kappa_{i,t}, \quad \forall (i, t) \in (I, T), \quad (1d)$$

$$\kappa_{i,t+1} \leq \kappa_{i,t} + \kappa_{i,t+1}^+ - \kappa_{i,t-\hat{t}_i}^+, \quad \forall (i, t) \in (I, T), \quad (1e)$$

$$\kappa_{i,t+1}^+ \leq r_{min} + r_f \cdot \kappa_{i,t}, \quad \forall (i, t) \in (I, T), \quad (1f)$$

$$\kappa_{i,t+1}^+ \geq r_{max}, \quad \forall (i, t) \in (I, T), \quad (1g)$$

$$\Lambda_t \geq \sum_{i,s} \pi_{i,s,t} (Y_{i,t} \eta_{i,t})^{-1}, \quad \forall (i, s, t) \in (I, S, T), \quad (1h)$$

$$q_t \sum_{i \in I_{pe}} \pi_{i,s_{pl},t} = \sum_{i \in I_{di}} \pi_{i,s_{pl},t}, \quad \forall (i, s, t) \in (I, S, T) \quad (1i)$$

The costs are calculated ex-post, according to Millinger et al. (2017b), including technological learning effects based on the resulting expansion of the technologies in each scenario. The feedstock costs were calculated according to (Millinger and Thrän, 2016), with an annual reference feedstock cost increase of 4%.

## 2.2. Data and assumptions

The biofuel options included are the same as in Millinger et al. (2017b), with some additions: grain based ethanol (Ponitka et al., 2016, p.40f); biokerosene (KER), with the same characteristics assumed as for FT-diesel; and the biomethane and SNG pathways can be liquefied (LBM and LSNG). For the liquefied options, a gas loss of 2% and an additional power requirement of  $12 \text{ kWh GJ}_{fuel}^{-1}$  was assumed (Birgen and Garcia, 2013, p.39 & p.43). The GHG abatement data and background system developments (power mix, fertiliser, heat input and fuel input emission factors) are elaborated in (Millinger et al., 2017a). The reference emission for the transport sector is set at  $83.8 \text{ kgCO}_{2eq} \text{ GJ}^{-1}$ .

The land use attributable to biofuels used in Germany can be estimated to ca.  $1.5 \text{ Mha}^1$ . This is assumed to continue to be available for biofuels production and thus an upper allowable limit is set to  $1.5 \text{ Mha}$ .

Table 1: Sector permitted fuels and relative size in terms of GHG emissions (total  $228 \text{ MtCO}_2$ ) in 2010, assumed for the start year. Land individual and public transport is combined to one sector ("Passenger"). Apart from international shipping, absolute emissions stem from Hütter (2013). International shipping emissions were weighted for Germany by ton shipped using Hütter (2013, p.12) and UNCTAD (2017, p.5), with emissions from IMO (2015). The energy used has been estimated using  $83.8 \text{ kgCO}_{2eq} \text{ GJ}^{-1}$  (sum total  $2725 \text{ PJ}$ ). The passenger sector is normed for the first year to the resulting energy use. Abbreviations:  $\text{CH}_4$ =methane (Bio $\text{CH}_4$  or SNG); EtOH=ethanol (BeetEtOH, StarchEtOH or LignoEtOH); Dsl=diesel (RME or FT-diesel);  $\text{LCH}_4$ =liquid methane (LBM or LSNG); Ker=kerosene.

	$\text{CH}_4$	EtOH	Dsl	$\text{LCH}_4$	Ker	Share	PJ
Passenger	×	×	×			57.1%	1546
Goods	×		×	×		20.4%	555
Shipping			×	×		12.9%	351
Aviation					×	10%	273

For the transport sector, some basic data are assumed and used throughout all scenarios, unless explicitly otherwise specified. Passenger land transport demand (person-kilometres) until 2030 is assumed according to BMVI (2014), with the demand between 2030-2050 assumed to level out and remain constant. Ca. 45 million passenger cars were registered as of 2017 (KBA, 2017a), with ca. 3 million new registrations each year (ICCT, 2017, p.15). The individual and public passenger sectors are grouped together for the modelling.

For the specific emissions of the current vehicle fleet, the average specific emissions of new personal internal combustion engine vehicles (ICEVs) in Germany for the years 2001-2015 were used from ICCT (2017). Targets<sup>2</sup> of 95 (EU, 2009), 70 and 50  $\text{gCO}_2 \text{ km}^{-1}$  are assumed for the years 2021, 2030 and 2040, respectively, with linear interpolation in between and a levelling out after 2040. The annual specific emissions are approximated as the average taken over the past 15 years.

The specific emissions of average diesel and gasoline driven passenger cars have almost converged in the past decade (ICCT, 2016, p.34) and are therefore assumed to be the same. The diesel share of new passenger cars in Germany was slightly below 50% for years, but has significantly reduced since 2015 (Dieselgate) (ICCT, 2017, p.3). Of the current total passenger vehicle fleet, 65% are petrol driven, 33% diesel driven, 1.2% gas driven, 0.36% hybrids and 0.07% EVs (KBA, 2017a).

For EVs, an initial average power consumption of  $0.2 \text{ kWh km}^{-1}$  is assumed, with a linear decrease to  $10 \text{ kWh km}^{-1}$  in 2050. A yearly 50% increase of EVs is assumed in line with the average development in the past five years (KBA, 2017b). A maximum of 3 million new EVs  $\text{a}^{-1}$  can be deployed annually, in which case no new ICEVs are deployed. A life-time of 15 years is assumed for all vehicles, and each EV is assumed to be driven equivalently to one ICEV.

The fuel demand of the land goods sector is assumed to decrease to a tenth of current demand by 2050, through a combination of modal shift to rail transport, electrification and possibly a shift to hydrogen, as well as transport and logistics efficiency improvements, in line with possible options (IPCC, 2014, p.17&28).

<sup>1</sup> Average for the years 2014-2016, based on own calculations. Crop use statistics were used from German biofuels monitoring (BLE, 2017), combined with yields from KTBL (2012) and IPCC (2011) and conversion efficiencies from Millinger et al. (2017b).

<sup>2</sup> Between 2001-2015, passenger cars in the EU reduced their specific  $\text{CO}_2$ -emissions by on average 30%, at the same time as increasing engine power by ca. 25% and weight by ca. 10% (ICCT, 2016). At least  $65 \text{ gCO}_2 \text{ km}^{-1}$  can be achieved until 2025 through vehicle mass reduction only (Meszler et al., 2013).

Allowed biofuels are either diesel as well as gaseous and liquefied methane, in line with expectations for heavy goods transport, which is less easily electrified than e.g. light-duty vehicles (IEA, 2017).

Fuel demand for shipping is assumed to decrease to half of current demand by 2050, through efficiency improvements, in line with projections (IPCC, 2014, p.18&62). Allowed biofuels are diesel and liquefied methane, according to expectations by IMO (2015).

The fuel demand for the aviation sector is expected to increase or at best remain at the same level, despite efficiency improvements (IATA, 2015; IPCC, 2014, p.62f.). Bioerosene is assumed to be the only option for aviation in this paper.

An optimistic development for the power system is assumed according to a fast coal decommission scenario (WWF, 2017, p.120). Infrastructure emissions from the construction of the conversion facilities are set at  $3 \text{ kgCO}_{2eq} \text{ GJ}_{cap}^{-1}$ , independent of conversion route, which is in line with values for ethanol (Ecoinvent, 2016) and biodiesel (Ecoinvent, 2010) plants. These emissions are almost negligible compared to operative emissions, but the assumption prevents over-capacities in the model.

### 2.3. Scenarios

Under these conditions, several scenarios of biofuel deployment are assessed (Table 2), with varying degree of electrification, yields, quota, land available and other important parameters: scenario i assesses the effect of adding biofuels from energy crops from 1.5 Mha of arable land to the system, with all fuels allowed according to Table 1. Scenario ii restricts all gaseous biofuels, as well as introducing biofuel admixture quotas in the land passenger sector for Otto and diesel fuels according to current shares of petrol and diesel fuelled vehicles. Scenario iii reduces the yields of sugar beet and silage maize to the lower span stated in Millinger et al. (2017a). Scenario iv assesses the effect of a higher average usage of electric passenger cars, equivalent to 1.5 ICEVs for each EV (e.g. through self-driving cars). Scenario v reduces the annual EV increase to 30%. Scenario vi assesses the effect of no EVs in the passenger transport sector. Scenario vii reduces the land goods transport fuel demand linearly to zero (e.g. through a combination of modal shift and electrification) and the ship freight linearly to one fourth (e.g. through demand reduction and efficiency improvements). Scenario viii doubles the available arable land linearly to 3 Mha in 2050. Scenario ix assumes a less progressive power mix improvement according to the fourth scenario in WWF (2017, p.123).

Table 2: Scenarios summary. The base scenario assumes developments as described in Section 2.2. The other scenarios are variations on the base scenario according to the description. Abbreviations: EV= electric vehicle; ICEV= internal combustion engine vehicle.

Scenario	Description
i	Base
ii	No gaseous fuels + diesel/gasoline quota
iii	Lower yields: sugar beet and silage maize
iv	EVs = 1.5 ICEVs
v	EV growth rate of $30\% \text{ a}^{-1}$
vi	No passenger EVs
vii	Goods & shipping fuel demand reduction
viii	Arable land linearly increasing to 3 Mha
ix	Moderate power mix (WWF, 2017, p.123)

The fuel demand in all scenarios surpasses the potential biofuel supply from the available arable land area for the beginning, with differing reduction rates for the sectors, dependent on the scenarios.

## 3. Results

The resulting EV deployment resembles an S-curve (cf. Grubler, 1998, p.50f.), with 172000 EVs in 2020 (0.38% of current fleet), 9.6 million (21%) in 2030, 38 million (85%) in 2040 and a fully electrified passenger car fleet by 2044. Under the given circumstances, from 2030 onwards, only EVs are deployed. Figure 1 shows some relevant metric developments for passenger cars.

The resulting GHG optimal biofuel developments in the scenarios are shown in Figure 2. In the base scenario (i), the presently common RME and StarchEtOH are phased out within a few years, with BeetEtOH

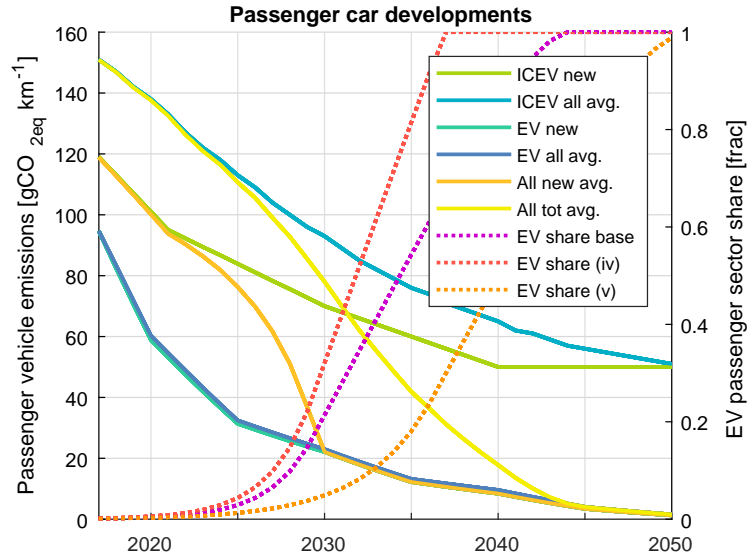

Figure 1: Passenger car sector developments. Average vehicle and fleet emissions are shown in solid lines [gCO<sub>2eq</sub> km<sup>-1</sup>, left axis]. The passenger sector market shares of EVs are shown in dotted lines [frac, right axis], for the base case as well as for scenarios (iv) where EVs have a 50% higher usage rate and (v) where the EV growth rate is at 30% a<sup>-1</sup>. From 2030 onwards, EVs make up all new passenger cars. The fleet emissions including EVs compared to with only ICEVs diverge at higher shares of EVs, combined with a cleaner power system and the fact that also older EVs improve their driving emissions according to the changing power system.

gaining market shares during a decade. Then, BioCH<sub>4</sub> as well as LBM, both of silage maize origin, together with SNG come strong for another decade. BioCH<sub>4</sub> fully dominates for a few years and is then gradually replaced by LBM as the sectors using gaseous fuels become increasingly renewable. SNG and LSNG as well as biokerosene start coming towards the end.

If biofuel quotas for land passenger transport are in place and gaseous fuels are not permitted (scenario ii), RME stays on for a decade longer but is replaced by FT-diesel for a short while until the passenger land transport fuel demand drops to zero. Instead of gaseous fuels, liquefied gaseous fuels (mainly LBM) dominate in the long term, making goods transport and shipping the priority sectors. This scenario achieves the lowest GHG abatement, as well as having the highest total GHG abatement cost (Figure 3).

If low yields are assumed for sugar beet and silage maize (scenario iii), BeetEtOH still dominates the passenger land transport sector, while BioCH<sub>4</sub> does not achieve substantial market shares. Instead, SNG and when the land goods sector fuel demand drops, LSNG for shipping come strongly.

If EVs take over a larger share of total passenger land transports through higher usage of each EV (scenario iv), only marginal differences to the base scenario can be observed, as BioCH<sub>4</sub> is used also in land goods transport. If the EV development is slower than in the base case (scenario v), BioCH<sub>4</sub> dominates for a longer period and aviation is not supplied with biofuels. If EVs are assumed not to break through (scenario vi), BioCH<sub>4</sub> dominates until the end, and shipping as well as aviation are not supplied with biofuels. In this scenario, the highest cumulative emissions for transport are achieved (Figure 5), and transport remains at ca 80 MtCO<sub>2eq</sub> in the end (Figure 6), more than twice as much as in all other scenarios, which include EVs. This is the result despite the assumed substantial improvements to the ICEV vehicle park emissions, with only a third of the relative emissions in the end compared to at the start (Figure 1).

If on the other hand the fuel demand in land goods transport and shipping is reduced more progressively (scenario vii), biokerosene comes strongly towards the end, as all other sectors are met by other means to a sufficient extent. The same effect occurs if more arable land is available (scenario viii), as more fossil fuels can be replaced. These two scenarios are the ones with the lowest cumulative emissions (Figure 5), as well

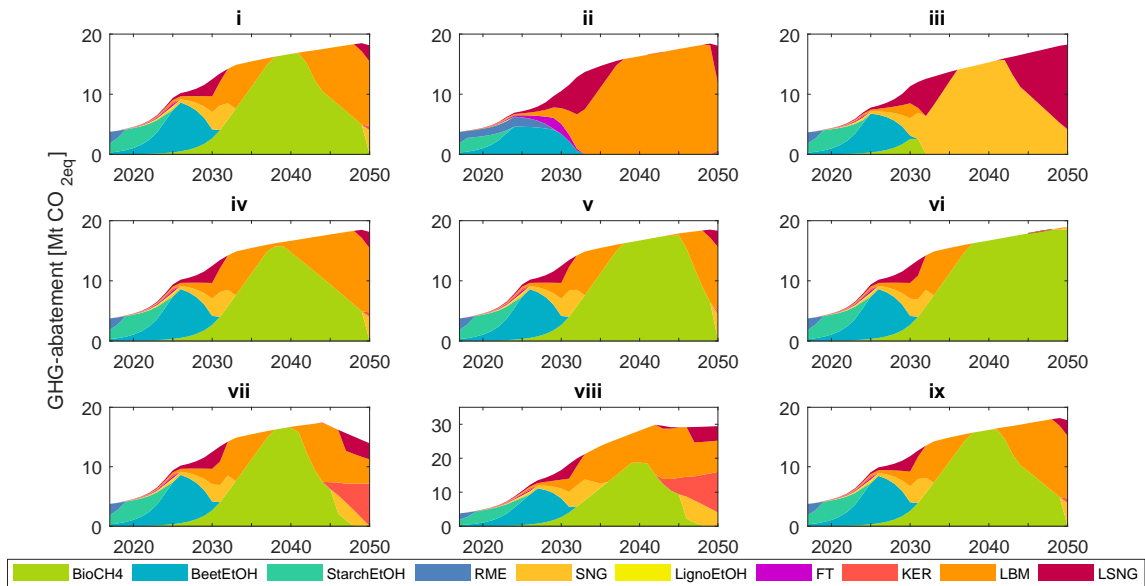

Figure 2: Total biofuel GHG abatement mix development in scenarios. The base scenario i assumes developments as described in Section 2.2, with the other scenarios being variations of the base scenario. Scenario ii: exclusion of gaseous fuels and quota for diesel and gasoline; iii: lower yields for sugar beet and silage maize; iv: a higher usage of EVs; v: a lower EV market growth rate; vi: no EVs; vii: more progressive developments in the goods and shipping sectors; viii: doubling of arable land over time; ix: less progressive power mix development. Abbreviations: BioCH<sub>4</sub>: silage maize based methane; BeetEtOH: sugar beet based ethanol; StarchEtOH: starch crop based ethanol; RME: rape seed methyl ester; SNG: poplar based synthetic natural gas; LignoEtOH: poplar based ethanol; FT: poplar based Fischer-Tropsch-diesel; KER: poplar based Fischer-Tropsch kerosene; LBM: silage maize based liquefied biomethane; LSNG: poplar based liquefied SNG. The GHG abatement through other renewable options such as electric vehicles (EVs) are not shown in this figure.

as the lowest emissions at the end of the time span (Figure 6).

A more moderate power mix development has only minor consequences for the types of fuels produced, with a slight reduction in BioCH<sub>4</sub>. However, the increased cumulative emissions are substantial (Figure 5), indicating the need for prioritising early emission reductions in the power system.

The total biofuel costs in all 1.5 Mha scenarios amount to around 200 billion € (Figure 3), or an annual 0.2% of current German GDP of 3.1 trillion € (Destatis, 2017), excluding the avoided cost of the substituted fossil fuels.

Figure 4 shows the development of GHG abatement per land unit. The most promising options are BioCH<sub>4</sub> and LBM, throughout the time span. BeetEtOH is the best liquid option and is never surpassed by advanced liquid options. SNG and LSNG surpass BeetEtOH within a few years and slowly converge with the silage maize based options, as the power mix becomes increasingly renewable. The reason for the best options not dominating directly is system inertia, with ramp factors setting expansion limits.

#### 4. Discussion

In all scenarios, one can observe a general trend: the order in which biofuels are optimally deployed is first land passenger transport, followed by land goods transport, shipping and finally aviation.

Aviation biofuels from dedicated crops in Germany only perform a climate benefit when other biofuel usages with higher pathway climate efficiencies have been displaced. This displacement requires substantial changes in all sectors, through efficiency improvements and EVs (or for that matter PtX) in the passenger transport sector; modal shift, efficiency and logistics improvements as well as demand reduction and possibly PtX in the land goods transport and shipping sectors. Only in the most progressive scenarios where all

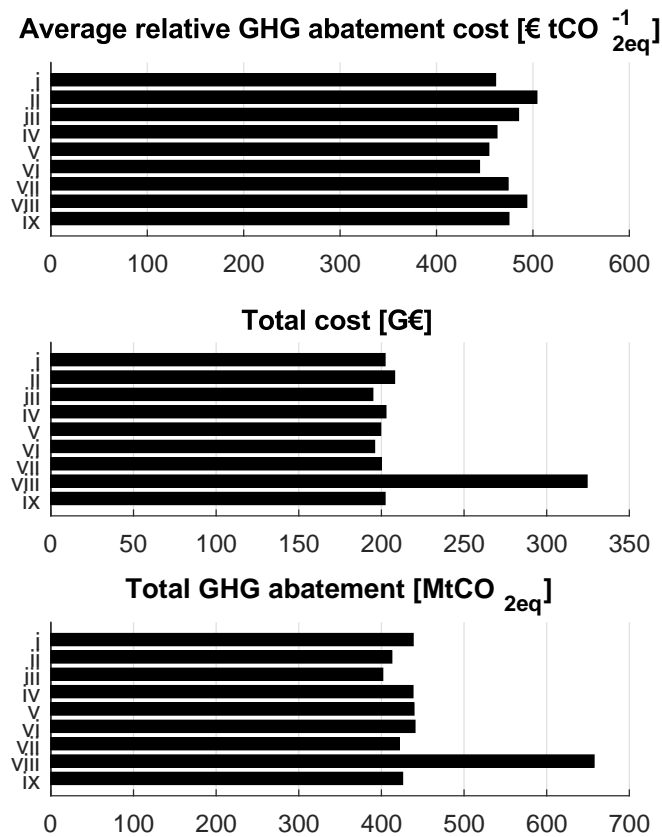

Figure 3: Average biofuel GHG abatement cost, total cumulative biofuel cost (excluding the avoided cost of the substituted fossil fuels) and total cumulative GHG abatement through fossil fuel substitution by biofuels, summed for all transport sectors in each scenario.

improvements come together were aviation biofuels found to achieve any substantial shares, and even then only towards the end. Keeping in mind that biomass may potentially render a higher GHG abatement in the sectors which were not included here, in sum a large transition is required before aviation biofuels become relevant from the perspective of optimising GHG abatement.

Alcohol-to-jet options were not included, but may play a role in the long term. If so, the conversion efficiency from ethanol to jet fuel needs to be >70% in order to compete with KER in terms of GHG abatement per hectare. Direct alcohol applications and gaseous alternatives are still better performing, and thus an addition of such options would not change the overall priority conclusions.

Even though engine efficiency scenarios were not included, the possible GHG abatement per hectare of arable land (Figure 4) shows large enough GHG abatement differences to favour Otto engine options (ethanol and methane) in those sectors where such fuels are permissible. For the goods transport sector this is particularly clear, where a stronger focus on ethanol than presently would be beneficial. It can also be observed that, compared to current practise, the GHG abatement per hectare can be potentially enhanced by a factor five or more, through a combination of yield and conversion efficiency improvements as well as renewable input streams (Millinger et al., 2017a). The potentially best performing fuels in this regard are maize silage based BioCH<sub>4</sub> and LBM.

The total cost differences between the 1.5 Mha scenarios were found to be small, despite costs not being

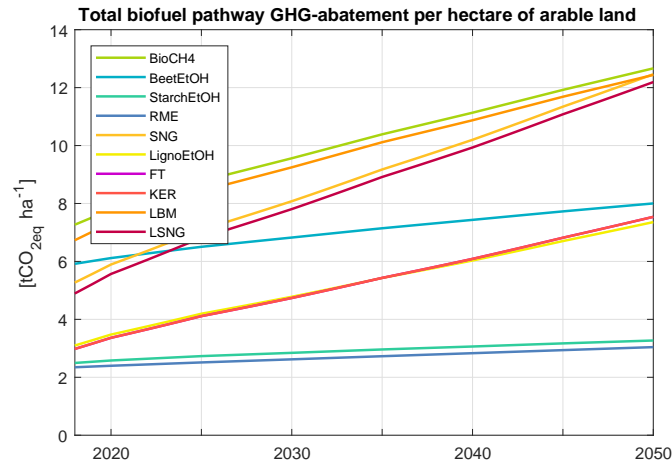

Figure 4: Development of greenhouse gas abatement per hectare [ $\text{tCO}_{2eq} \text{ha}^{-1}$ ] for the biofuels included over the modelled time span, in the base scenario. Fischer-Tropsch-diesel shows exactly the same development as KER, and is therefore not visible in the graph.

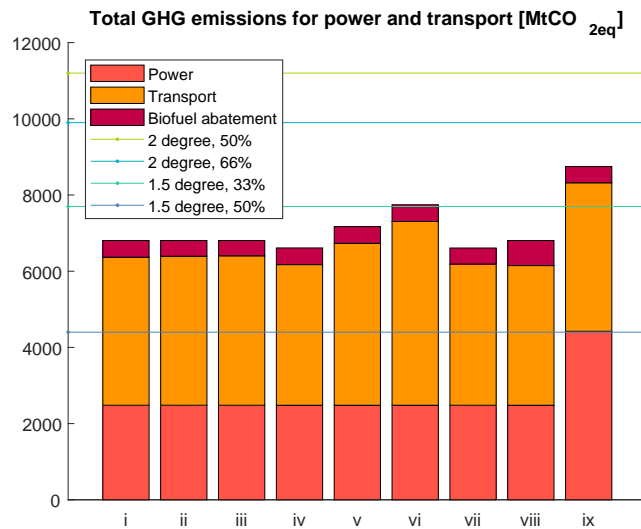

Figure 5: Total greenhouse gas (GHG) emissions for the power and transport sectors in the scenarios, including the GHG abatement through biofuels. The lines show permissible German GHG budgets at different likelihoods of reaching 1.5°C and 2°C climate targets, if the global GHG budgets are allocated per capita (WWF, 2017).

in the goal function and only calculated ex-post. It can be argued that a focus on land use efficiency to some extent implies cost efficiency in the long run (Millinger and Thrän, 2016; Millinger et al., 2017a), which is confirmed by this result.

Biomass residues may play an important role in increasing the resource basis for producing biofuels. Some 1000 PJ of biomass residues of different types have been estimated to be available (Brosowski et al., 2016). As no emissions for cultivation as well as no arable land would be attributed to biofuels using such resources, there are strong advantages and therefore this is already being implemented in Germany to some extent (BLE, 2017). If an average conversion efficiency of 65% and an average GHG abatement of  $60 \text{ kgCO}_{2eq} \text{ GJ}^{-1}$  are assumed, some 40 Mton  $\text{CO}_{2eq} \text{ a}^{-1}$  could be abated, or over the whole time span a



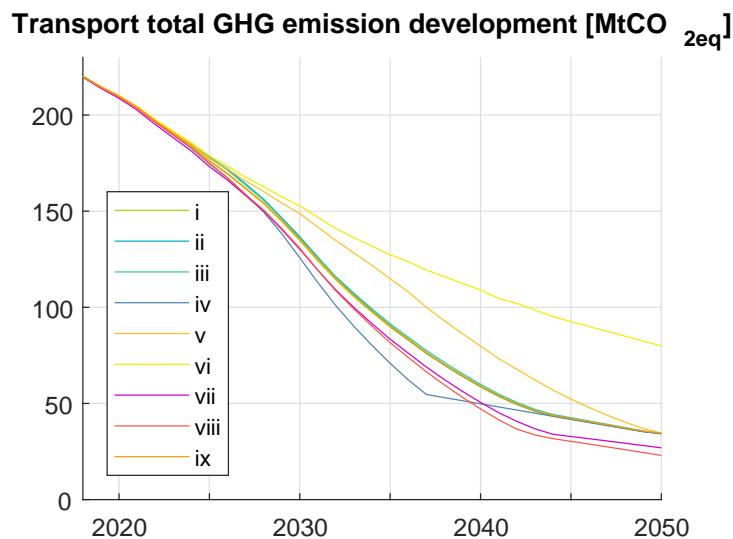

Figure 6: Total GHG emission development [MtCO<sub>2eq</sub> a<sup>-1</sup>] for transport over the modelled time span in the scenarios.

cumulative 1.3 Gton; more than three times the GHG abatement in the 1.5 Mha scenarios. In such a case, the resource basis sets which options are produced. The domination of wood residues thus would require advanced biofuel options, but this resource may yield a higher GHG abatement in other sectors, such as power, heat and industry. Thus, the optimal usage of biomass residues across sectors should be further assessed.

BioCH<sub>4</sub> is advantageous already in the beginning, but due to system inertia, the initial development is relatively slow. A higher ramp factor leads to an earlier deployment of BioCH<sub>4</sub>, whereas a lower ramp factor has the opposite effect. Further research as to the possibility of large-scale deployment of vehicles using gaseous fuels is necessary considering the current small size of the gaseous vehicle market.

The notable fuel shifts taking place across all scenarios obviously have consequences for the landscape, as crops are shifting from rape seed and wheat in the beginning, to a full sugar beet domination, replaced by a full domination of maize, which under some circumstances was replaced by a large share of lignocellulosic perennials. Whereas the conventional crops can rotate between different areas (potentially restricted by transportability), the perennials would remain in the same spot for a longer time span.

As a benchmark, the permissible carbon budget in order to achieve certain climate goals can be allocated per capita (WWF, 2017). For example, in order to achieve a 2°C target with a 66% likelihood, 9.9 Gton CO<sub>2eq</sub> (on average 291 Mton CO<sub>2eq</sub> a<sup>-1</sup>, assuming carbon neutrality after 2050) would be permissible for Germany (Figure 5), in which case the GHG reduction through biofuels from 1.5 Mha amounts to around 4% of the total carbon budget. The relative importance of biofuels increases with higher climate ambition (as long as land use change effects can be curbed), but so does the competition from other sectors where biomass may perform a higher climate benefit. For the allocation of biomass across all relevant sectors, more research is called for.

Other environmental factors than GHG emissions have not been assessed here. Yields of silage maize were found to be of strong importance for the competition between BioCH<sub>4</sub> and SNG. Thus possible soil management schemes reducing silage maize yields would render poplar based SNG a better option.

Land use change emissions have not been assessed here, with the reasoning that currently required arable land for production of biofuels used in Germany is not extended. However, this is a question of what the assumed reference is, as the required arable land has reduced in the past few years through the use of more residual biomass (BLE, 2017). In the scenario where the available arable land is assumed to increase, in order to avoid land use change issues, the additional land would need to be offset through reducing the

demand from other sectors, such as (ruminant) meat production (Bryngelsson et al., 2017; Foley et al., 2011; Tilman et al., 2009). If this is not done, a land area extension for energy purposes beside possibly marginal lands (Tilman et al., 2006) risks leading to more emissions than are offset through replacing fossil fuels (Fargione et al., 2008; Searchinger et al., 2008).

## 5. Conclusions

In this paper, progressive scenarios for the transport sectors have been assessed in order to investigate the resulting biofuel deployment for an optimal GHG abatement from the arable land currently used for biofuels. The GHG abatement per land area can potentially be increased by a factor of five, by switching to more promising biofuel options with higher yield and conversion efficiencies while the background system (power mix, fertiliser, renewable heat) becomes increasingly renewable. In order for this to be realised, the use of gaseous or liquefied gaseous fuels needs to increase substantially compared to today. If a substantial market for gaseous fuels should not be realisable, sectors which can use liquefied gaseous fuels, i.e. goods transport and shipping, are the climate best usage of biomass.

Under German conditions, the priority of sectors resulting from fuel suitability restrictions and GHG abatement potential of the individual biofuel options was found to be as follows: land passenger transport, land goods transport, shipping and finally aviation. Only after all other sectors of higher priority have been supplied or reduced by other means do the subsequent ones become relevant. Sectors and scenarios where ethanol and gaseous fuels are allowed yield the highest GHG abatement.

The current practise of applying biofuel admixture quotas to sub-sectors of land transport renders a significantly lower climate benefit compared to an overall optimal usage. Ethanol based on sugar beet was found to dominate in all scenarios for land transport in the short term, with biomethane dominating in the medium term.

Aviation biofuels from dedicated crops in Germany only perform an optimal climate benefit when other biofuel usages with higher pathway climate efficiencies have been displaced, or if a substantially higher usage of arable land for biofuel production were to be permitted, which would require other demands - e.g. meat - to decrease. Including other sectors such as power, heat and industry, may postpone the relevance of aviation biofuel even further and in sum a large societal transition is required before aviation biofuels become the best biomass usage for mitigating climate change. Nevertheless, due to the lack of alternatives for aviation, such fuels do remain of importance for the longer term.

## Acknowledgements

This work was funded by the Helmholtz Association of German Research Centers and supported by Helmholtz Impulse and Networking Fund through Helmholtz Interdisciplinary Graduate School for Environmental Research (HIGRADE). Thank you to Matthias Jordan for help with linking GAMS and Matlab. Declarations of interest: none.

## References

- Nicola Armaroli and Vincenzo Balzani. Towards an electricity-powered world. *Energy & Environmental Science*, 4(9):3193, 2011. ISSN 1754-5692. doi: \url{10.1039/c1ee01249e}.
- Cansu Birgen and Silvia Garcia. *Liquefied Synthetic Natural Gas from Woody Biomass: Investigation of Cryogenic Technique for Gas Upgrading*. Master Thesis, Chalmers University of Technology, Göteborg, Sweden, 2013.
- BLE. *Hintergrunddaten zum Evaluations- und Erfahrungsbericht 2016*. Bundesanstalt für Landwirtschaft und Ernährung, Bonn, 2017.
- BMVI. *Verkehrsvorhersage 2030: Zusammenfassung der Ergebnisse*. Bundesministerium für Verkehr und digitale Infrastruktur, 2014.
- André Brosowski, Daniela Thrän, Udo Mantau, Bernd Mahro, Georgia Erdmann, Philipp Adler, Walter Stinner, Gerd Reinhold, Thomas Hering, and Christian Blanke. A review of biomass potential and current utilisation – Status quo for 93 biogenic wastes and residues in Germany. *Biomass and Bioenergy*, 95:257–272, 2016. ISSN 09619534. doi: \url{10.1016/j.biombioe.2016.10.017}.

- David Bryngelsson, Fredrik Hedenus, Daniel Johansson, Christian Azar, and Stefan Wirsenius. How Do Dietary Choices Influence the Energy-System Cost of Stabilizing the Climate? *Energies*, 10(2):182, 2017. ISSN 1996-1073. doi: \url{10.3390/en10020182}.
- Destatis. *Statistisches Jahrbuch 2017: Deutschland und Internationales*. Statistisches Bundesamt, Wiesbaden, 1 edition, 2017. ISBN 978-3-8246-1057-0.
- S. Dunn. Hydrogen futures: toward a sustainable energy system. *International Journal of Hydrogen Energy*, 2002(27):235–264, 2002. ISSN 03603199.
- Ecoinvent. *Vegetable oil esterification plant: Ecoinvent database v.2.2 - www.ecoinvent.org*. Swiss Centre for life cycle inventories, Zürich, 2010.
- Ecoinvent. *Ethanol fermentation plant: Ecoinvent database v.3.3 - www.ecoinvent.org*. Swiss Centre for life cycle inventories, Zürich, 2016.
- EU. Directive 2009/28/EC of the European Parliament and of the Council of 23 April 2009 on the promotion of the use of energy from renewable sources and amending and subsequently repealing Directives 2001/77/EC and 2003/30/EC, 2009.
- J. Fargione, J. Hill, D. Tilman, S. Polasky, and P. Hawthorne. Land Clearing and the Biofuel Carbon Debt. *Science*, 319(5867):1235–1238, 2008. ISSN 0036-8075. doi: \url{10.1126/science.1152747}.
- Jonathan A. Foley, Navin Ramankutty, Kate A. Brauman, Emily S. Cassidy, James S. Gerber, Matt Johnston, Nathaniel D. Mueller, Christine O’Connell, Deepak K. Ray, Paul C. West, Christian Balzer, Elena M. Bennett, Stephen R. Carpenter, Jason Hill, Chad Monfreda, Stephen Polasky, Johan Rockström, John Sheehan, Stefan Siebert, David Tilman, and David P. M. Zaks. Solutions for a cultivated planet. *Nature*, 478(7369):337–342, 2011. ISSN 0028-0836. doi: \url{10.1038/nature10452}.
- A. Grubler. *Technology and global change*. Cambridge University Press, Cambridge, 1998. ISBN 0521543320.
- Andrea Hütter. *Verkehr auf einen Blick*. Statistisches Bundesamt, Wiesbaden, 2013.
- IATA. *IATA Sustainable Aviation Fuel Roadmap*. International Air Transport Association, Montreal and Geneva, 2015. ISBN 978-92-9252-704-4.
- ICCT. *European vehicle market statistics: Pocketbook 2016/2017*. International Council on Clean Transportation Europe, 2016.
- ICCT. *European Vehicle Market Statistics: Pocketbook 2017/2018*. International Council on Clean Transportation Europe, 2017.
- IEA. *The Future of Trucks - Implications for Energy and the Environment*. International Energy Agency, France, 2017.
- IMO. *Third IMO GHG Study 2014: Executive Summary and Final Report*. International Maritime Organization, London, 2015.
- IPCC. *Renewable Energy Sources and Climate Change Mitigation: Special Report of the Intergovernmental Panel on Climate Change*. Cambridge University Press, Cambridge, United Kingdom and New York, NY, USA., 2011.
- IPCC. Climate Change 2014: Mitigation of Climate Change: Chapter 8 - Transport. In IPCC, editor, *Climate Change 2014: Mitigation of Climate Change*. IPCC, Cambridge University Press, Cambridge, United Kingdom and New York, NY, USA, 2014. ISBN 978-1-107-05821-7.
- KBA. *Fahrzeuge - Neuzulassungen, Bestand: www.kba.de*. Kraftfahrtbundesamt, 2017a.
- KBA. *Umwelt - Bestand an Pkw in den Jahren 2008 bis 2017 nach ausgewählten Kraftstoffarten: www.kba.de*. Kraftfahrtbundesamt, 2017b.
- Daniel H. König, Marcel Freiberg, Ralph-Uwe Dietrich, and Antje Wörner. Techno-economic study of the storage of fluctuating renewable energy in liquid hydrocarbons. *Fuel*, 159:289–297, 2015. ISSN 00162361. doi: \url{10.1016/j.fuel.2015.06.085}.
- KTBL. *Energiepflanzen: Daten für die Planung des Energiepflanzenanbaus: KTBL Datensammlung*. KTBL, Darmstadt, 2 edition, 2012. ISBN 978-3-941583-65-8.
- Dan Meszler, John German, Peter Mock, and Anup Bandivadekar. *Summary of mass reduction impacts on EU cost curves: ICCT working paper 2013-1*, volume 1. International Council on Clean Transportation Europe, 2013. doi: \url{10.1002/9781118170229.ch1}.
- Markus Millinger and Daniela Thrän. Biomass price developments inhibit biofuel investments and research in Germany: The crucial future role of high yields. *Journal of Cleaner Production*, 2016. ISSN 09596526. doi: \url{10.1016/j.jclepro.2016.11.175}.
- Markus Millinger, Kathleen Meisel, Maik Budzinski, and Daniela Thrän. Relative greenhouse gas abatement cost competitiveness of biofuels in Germany. *Preprints*, 2017a. doi: \url{10.20944/preprints201712.0122.v1}.
- Markus Millinger, Jens Ponitka, Oliver Arendt, and Daniela Thrän. Competitiveness of advanced and conventional biofuels: Results from least-cost modelling of biofuel competition in Germany. *Energy Policy*, 2017(107):394–402, 2017b. ISSN 0301-4215.
- Jens Ponitka, Oliver Arendt, Volker Lenz, Jaqueline Daniel-Gromke, Walter Stinner, Andreas Ortwein, Martin Zeymer, Arne Gröngroft, Franziska Müller-Langer, Marco Klemm, Julian Braun, Walther Zeug, Daniela Thrän, Sinéad O’Keeffe, and Markus Millinger. *Focus on: Bioenergy-Technologies: Conversion pathways - towards biomass energy use in the 21st century*. DBFZ, Leipzig, 2 edition, 2016. ISBN 2192-1156.
- Johan Rockström, Owen Gaffney, Joeri Rogelj, Malte Meinshausen, Nebojsa Nakicenovic, and Hans Joachim Schellnhuber. A roadmap for rapid decarbonization. *Science*, 355(6331):1269–1271, 2017. ISSN 0036-8075. doi: \url{10.1126/science.aah3443}.
- C.E. Sandy Thomas. Transportation options in a carbon-constrained world: Hybrids, plug-in hybrids, biofuels, fuel cell electric vehicles, and battery electric vehicles. *International Journal of Hydrogen Energy*, 34(23):9279–9296, 2009. ISSN 03603199. doi: \url{10.1016/j.ijhydene.2009.09.058}.
- T. Searchinger, R. Heimlich, R. A. Houghton, F. Dong, A. Elobeid, J. Fabiosa, S. Tokgoz, D. Hayes, and T.-H. Yu. Use of

- U.S. Croplands for Biofuels Increases Greenhouse Gases Through Emissions from Land-Use Change. *Science*, 319(5867): 1238–1240, 2008. ISSN 0036-8075. doi: \url{10.1126/science.1151861}.
- Michael Sterner. *Bioenergy and renewable power methane in integrated 100% renewable energy systems: Limiting global warming by transforming energy systems: Zugl.: Kassel, Univ., Diss., 2009*. Kassel Univ. Press, Kassel, 2009.
- D. Tilman, J. Hill, and C. Lehman. Carbon-Negative Biofuels from Low-Input High-Diversity Grassland Biomass. *Science*, 314(5805):1598–1600, 2006. ISSN 0036-8075. doi: \url{10.1126/science.1133306}.
- D. Tilman, R. Socolow, J. A. Foley, J. Hill, E. Larson, L. Lynd, S. Pacala, J. Reilly, T. Searchinger, C. Somerville, and R. Williams. Beneficial Biofuels—The Food, Energy, and Environment Trilemma. *Science*, 325(5938):270–271, 2009. ISSN 0036-8075. doi: \url{10.1126/science.1177970}.
- UNCTAD. *Review of maritime transport 2017*. United Nations Conference on Trade and Development, Geneva, 2017. ISBN 978-92-1-112922-9.
- UNFCCC. *Adoption of the Paris Agreement: FCCC/CP/2015/L.9/Rev.1*. United Nations Framework Convention on Climate Change, 2015.
- WWF. *Zukunft Stromsystem: Kohleausstieg 2035 - vom Ziel her denken*. World Wildlife Foundation, Berlin, 2017. ISBN 978-3-946211-07-5.

Helmholtz Centre for  
Environmental Research – UFZ  
Permoserstraße 15  
04318 Leipzig | Germany  
[www.ufz.de](http://www.ufz.de)

NOT FOR SALE.