

University of Northern Iowa
UNI ScholarWorks

Graduate Research Papers

Student Work

2007

Tree identification and age project

Mark Jensen
University of Northern Iowa

Copyright ©2007 Mark Jensen

Follow this and additional works at: <https://scholarworks.uni.edu/grp>

 Part of the [Curriculum and Instruction Commons](#), and the [Forest Biology Commons](#)

Let us know how access to this document benefits you

Recommended Citation

Jensen, Mark, "Tree identification and age project" (2007). *Graduate Research Papers*. 914.
<https://scholarworks.uni.edu/grp/914>

This Open Access Graduate Research Paper is brought to you for free and open access by the Student Work at UNI ScholarWorks. It has been accepted for inclusion in Graduate Research Papers by an authorized administrator of UNI ScholarWorks. For more information, please contact scholarworks@uni.edu.

Tree identification and age project

Abstract

The purpose of the *Tree Identification and Age Project* is to use authentic learning activities to extend the current curriculum to include learning that takes place at high levels of cognition. The methods employed integrate higher-order thinking into learning through a hands-on, problem-based approach to authentic scientific investigation. Using a problem-based approach, the learners apply knowledge and skills to solve real problems. The process involves focusing on the problem, identifying relative information, categorizing, critically analyzing, synthesizing that information and effectively communicating the results.

TREE IDENTIFICATION AND AGE PROJECT

A Graduate Project

Submitted to the

Division of Educational Technology

Department of Curriculum and Instruction

In Partial Fulfillment

Of the Requirements for the Degree

Master of Arts in Education

UNIVERSITY OF NORTHERN IOWA

By

Mark Jensen

March, 2007

This Project by: Mark Jensen

Titled: TREE IDENTIFICATION AND AGE PROJECT

has been approved as meeting the research requirements for the
Degree of Master of Arts

6/4/07
Date Approved

Leigh E. Zeitz

Graduate Faculty Reader

6-4-07
Date Approved

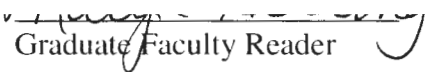
Mary C. Herring

Graduate Faculty Reader

6/6/07
Date Approved

William P. Callahan

Head, Department of Curriculum and Instruction

TABLE OF CONTENTS

I. Introduction	
Description	1
Rationale	3
Purpose of the Project	5
Importance of the Project	6
Terminology	9
II. Methodology	10
Literature Review	10
Project Development	12
III. The Project	25
IV. Conclusion	35
Insights Gained From Project Development	35
Future Projects/Research	40
V. References	43
VI. Appendix	
Student Training Manual	47

INTRODUCTION

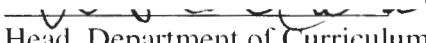
Description

The project described in this paper is the culmination of work that has grown from a final project in the class *Using Databases in Education* from the summer term of classes at the University of Northern Iowa in 1999. The scope, target audience, and methods used in the project have changed several times during its development. The educational research cited will show that the *Tree Identification and Age Project* is a valuable educational tool. The project will also be a valuable scientific tool in providing an available database in which further research can be conducted.

The *Tree Identification and Age Project* is a learning project in which small groups of students collect and record specific data about individual trees in a wooded area. The information collected by the students is used to determine if the area of study is reclaimed woodland or an old growth forest.

Before the project begins, the learners complete a training program for a simulated company called the Kennedy Forestry Corporation. This training program teaches techniques needed to accurately collect and record data when the learners begin the project. The training program replaces traditional teaching methods and develops a sense of purpose for learning the new skills.

The first phase of the *Tree Identification and Age Project* is completed in a wooded area. The students select and mark an area to study. Using an orienteering compass and pacing the students collect data to be used to produce a map of the area. This data includes the location of all the trees in the selected area. The exact location of

the area is found by using a Global Positioning Satellite (GPS) receiver to record the latitude, longitude and elevation of each corner of the area.

Each tree is identified by its species and the circumference of each tree is measured. If a tree is growing on or near a slope, the location of where the tree is growing on the slope is recorded with the species and circumference data. Core samples are taken from three trees in the area to allow the number of annual rings to be counted and age of the trees determined. The age of each of the three trees is also recorded.

The second phase of the project involves learners compiling the data collected in the field. Each group creates a map indicating the position of each tree and the species of each tree in their area. All of the maps produced by the groups are combined to create a large map of the area. The large map that is created is used in the third phase of this project.

The data tree species, trunk circumference, tree age and position each tree is growing on a slope are entered into a spreadsheet program. The data from each group is combined to form a large body of data. The data is sorted by tree species and used in the third phase of this project.

The third phase of the *Tree Identification and Age Project* is an analysis of the data collected in the wooded area. The large map is analyzed by looking for patterns in the positions of trees that would indicate that the area was once settled. The spreadsheet program allows the data to be sorted by any field. The trees are sorted by species and each group is assigned a tree species to analyze.

The spreadsheet program is used to produce graphs of the appropriate data for each tree species. The graphs are analyzed using the trendline functions of the

spreadsheet program. Each group is responsible for producing a graph that describes the relationship between tree age and the appropriate field of the acquired data of the assigned species. The equation is used to closely approximate the age of any tree based upon species, circumference, and position growing on a slope data.

The final phase of the project involves students researching the history of their area. This research will determine if their area of study is an old growth forest or reclaimed woodland. The ages of the oldest trees in their area are used as a starting point to begin the research. Students use county and newspaper records as references to research the area of study at the time it became forested.

Groups present their findings to the class in a twenty-minute multimedia presentation. This presentation includes information about the data collected, a description of the methods used to analyze the data, the graphs developed to estimate tree age, their conclusion about the history of the area, and documentation to support the conclusion.

Rationale

There are several reasons for the development of the *Tree Identification and Age Project*. The reasons include increasing student interest in science by involving them in doing real science, using technology to link science to other areas of the curriculum, improving communication skills used in collaboration, preparing students for the real world, and building a body of scientific data to be used by other researchers.

Current classroom methods place heavy emphasis on general scientific knowledge as it relates to the curriculum. Unfortunately, the curriculum is based upon memorization

and there is little application. The application of knowledge in authentic situations encourages learning at high cognitive levels (Renzulli, Gentry, and Reis, 2004).

The *Tree Identification and Age Project* brings an authentic, problem-based approach to the same curriculum. Learners are more engaged when instructional programs include authentic learning experiences and are provided with challenging activities (Certo, Cauley, and Chafin, 2003). Increasing student interest in science will increase their intrinsic motivation to learn (Scraw, Flowerday, and Lehman, 2001). Students with a high level of interest in an activity are more likely to put forth efforts that will complete a task successfully (Palmer, 2004a).

The *Tree Identification and Age Project* provides an opportunity for technology to integrate the areas of mathematics, science and local history. The use of technology across these subject areas provides continuity and relevance between what is usually seen as separate educational components (Clark and Ernst, 2007).

Improving students' collaboration skills gives learners an opportunity to process information at higher cognitive levels. Students will encounter different points of view from group members and the process of accommodating the conflicting ideas will promote greater insight (Bostock, 1998).

The use of authentic projects, such as the *Tree Identification and Age Project*, supports learning skills that are required to be successful later in life. Authentic projects help learners use knowledge, skills and attitudes necessary for effective task performance, and transfer what they have learned to their lives (Van Merriënboer, Kirschner, and Liesbeth, 2003).

Purpose

The purpose of the *Tree Identification and Age Project* is to use authentic learning activities to extend the current curriculum to include learning that takes place at high levels of cognition. The current classroom methods place a heavy emphasis on learning that falls into the knowledge category of Bloom's taxonomy.

Bloom's Taxonomy (Bloom, 1956) is composed of six cognitive levels: knowledge, comprehension, application, analysis, synthesis, and evaluation. These levels of cognition of Bloom's taxonomy progress from simple to complex with knowledge being the simplest, (memorization) and evaluation as the most complex. The most important goals of education include understanding and using knowledge at the higher-order levels of comprehension to synthesis (Krathwohl, 2002). The higher-order thinking skills of analysis, synthesis, and evaluation are essential in critical thinking (Paul, 1985).

The methods employed by the *Tree Identification and Age Project* integrate higher-order thinking into learning through a hands-on, problem-based approach to authentic scientific investigation. Using a problem-based approach, the learners apply knowledge and skills to solve real problems. The process involves focusing on the problem, identifying relative information, categorizing, critically analyzing, synthesizing that information and effectively communicating the results (Renzulli, 2004). Such student-centered learning environments provide activities that enable students to address their unique learning interests and needs, examine content at multiple levels of complexity, and deepen understanding (Hannafin, 1992)

The skills mastered in the training manual are the fundamental skills required to begin the *Tree Identification and Age Project*. The framework of knowledge and skills

provide the bases to focus their attention on the more meaningful aspects on the *Tree Identification and Age Project*. The comprehension level is demonstrated by the comparisons and interpretations involved in identifying the trees by species. The second phase of the project involves the students thinking at the application, analysis and synthesis levels as they produce the graphs used to determine the age of a tree. The presentation phase of the project requires the learners to present and defend their conclusions, demonstrating the highest level of Bloom's Taxonomy of evaluation.

Importance

The importance of the *Tree Identification and Age Project* is found in its educational value for the students and the value of the database for the scientific community-at-large. The educational value of the *Tree Identification and Age Project* is derived from requiring the students to think and reason in a variety of situations and levels of complexity. The approach of the project is to use a hands-on, problem-based pedagogy of an authentic learning experience.

In problem-based experiences the learners are actively engaged in working at tasks and activities, which are authentic to the environment in which they would be used in the real world (Savery and Duffy, 1995). The use of authentic learning situations allows learners to develop an understanding of scientific content while learning the practices valued by the scientific community (Lee and Songer, 2003). The traditional science classroom methods of lecture, demonstration and laboratory experiments stress content, not the methods used by scientists in their professions. By participating in authentic science students learn content as they learn the culture of the scientific community.

As neophytes of scientific culture, the differences that separate students from professionals are knowledge and experience (Perry, 2004). Their research will give context to their knowledge of science, and mathematics by using these skills to create meaningful products such as maps and graphs from data they collect. The students will be linked to professionals through sharing their data and they will behave as professionals using the skills of communication and presenting a final product.

The approach taken with the *Tree Identification and Age Project* is to use the authentic problem of determining the history of a local woodland. Authentic problems allow students to take ownership of their solutions, develop deep, rich knowledge structures, require more systematic problem solving methods, and are more likely to benefit collaborative efforts (Slavin, 1991).

The *Tree Identification and Age Project* recognizes a wide range of talents and abilities and allows individuals to contribute their strengths to the project. A classroom is a collection of individuals and not all the phases of the project will appeal to all individuals. An authentic problem allows learners to engage all of their abilities and talents to impact their learning. The different phases of the project allow individuals to use their interests and strengths where they are most comfortable. Authentic learning recognizes a range of abilities, and talents and deliberately seeks to foster them across a variety of contexts (Hill and Smith, 1998).

An authentic learning project provides another pathway for using technology in science education. The use of problem-based and authentic learning provides a basis for the purpose and value for purpose and for the study of technology in secondary school education (Hill and Smith, 2005).

The *Tree Identification and Age Project* provides an opportunity for learners to experience authentic scientific experiences in their own communities. By enrolling in the high school Field Biology class, the students have indicated that they are interested in this course of study. Working on the *Tree Identification and Age Project* enables learners to become scientists and historians. The process of becoming a scientist may start with an authentic science experience. Students begin the practice of scientific investigation by using the methods, techniques, tools, and vocabulary that are essential to function as a scientist. As the data and results of the student work are made available to the public, the students will be held to the same scientific scrutiny of their work as any research scientist would be. The learners will be called upon to explain their techniques and defend the methods used to collect their data, how the data was analyzed, and their final conclusions. Participation by students in neighboring schools allows cooperation between schools in compiling, analyzing, and manipulating data in the database. As the body of data grows the database itself becomes a valuable tool for others who are doing research on tree species growth, distribution, populations and population dynamics.

The database and the analysis of the data will be valuable to local organizations as well as the scientific community. A method of relating the circumference to the age of different tree species would benefit local parks departments by allowing them to identify mature trees for harvest before the trees start to succumb to old age or disease.

A census of the woodlands of a community provides the Department of Natural Resources with data that describes the relative number of each tree species in an area. This information could be used to inform local nurseries about tree species to cultivate

for sale to the local community. An overpopulation of one tree species in a community could be disastrous if a species-specific disease infected the local tree population.

Terminology

Authentic learning - An instructional method that includes the investigation of real-life problems involving an emotional commitment and a cognitive interest by the learner (Renzulli, Gentry, and Reis, 2004)

Dendrochronology - A method of determining tree age by counting the annual growth rings (Stokes and Smiley, 1996).

Hands-on learning - A method of teaching and learning where students learn by doing (Clark and Ernst, 2007).

Problem-based learning - An educational pedagogy in which students formulate and pursue learning objectives by researching a situation and developing their own solutions (Maxwell, Mergendoller and Bellisimo, 2005).

Swedish Increment Borer – An instrument that is drilled into the trunk of a tree allowing a cross section of the trees growth rings to be removed and analyzed (Stokes and Smiley, 1996).

METHODOLOGY

The *Tree Identification and Age Project* provides an entry point for learners to use technology and problem-based learning to improve their scientific skills and knowledge. The technology available in the classrooms of today provides a valuable tool for that change to take place.

The call to change traditional classroom methods was sounded by the 1993 American Association for the Advancement of Science's Project 2061. The reforms were echoed in the National Science Education Standards of 1996 and are supported by the literature of related educational methodologies (Chang, 2002). The American Association of Science, National Science Education Standards and the literature reviewed by the writer call for these reforms. The literature supports the ideas of using inquiry as a learning method supplemented by the use of technology.

Project 2061 suggests as students graduate from high school they should have designed and carried out at least one major scientific investigation. The learners should frame the question, design the approach, and estimate the time and costs involved, calibrate the instruments, conduct trial runs, write a report and finally respond to criticism. The investigations do not have to be exact. If students participate in scientific investigations that approximate good science, then the picture they come away with will be reasonably accurate (American Association for the Advancement of Science, 1993).

Problem-based learning promotes learners acquiring knowledge while simultaneously solving a problem (Uyeda, Madden, Brigham, Luft, and Washburne, 2002). Problem-based learning consists of learners formulating and pursuing their own learning objectives by researching, questioning, and producing solutions to the problem

(Maxwell, Mergendoller, Bellisimo, and Kennedy, 2005). Learner engagement is increased by problem-based learning through the through the exercises of choosing and developing without abandoning lower cognitive skills (Cruickshank and Olander, 2002).

One factor that makes problem-based learning successful is the increased motivation of the learners. Problem-based learning gives learners the opportunity to analyze real life data from laboratory investigations, enables students to learn in interesting ways outside the usual walls of the classroom as well as acquire knowledge beyond the given syllabus (Chin and Chia 2004). There exists a positive link between problem-based learning and a range of attitudes including motivation, self concept, enjoyment, perceptions of science and reduction of anxiety (Palmer, 2004b). This motivation in the classroom is fueled by activities that occur outside the classroom. The answer to recaptivating students' interest in science and enthusiasm for science in the classroom lies in experiences outside the classroom (Partridge, 2003).

Analyzing data in a problem-based environment allows students to process and represent data. Learners turn the raw data into usable information that helps solve a problem. Students also interpret, discuss, and synthesize the information they collect (Holmes, 2002). This is important as society expects graduates to collaborate, work in teams, teach others, lead and negotiate. They are expected to acquire, interpret, and evaluate data and to have the capacity to learn, reason, and solve problems. Learning in a problem-based environment nurtures all of these skills (Rice and Wilson 1999).

Problem-based learning provides a scaffolding to achieve the goals of making student scientists focus on metacognitive skills (Gallagher and Stepien 1995). Problem-based exercises require students to apply scientific knowledge and reasoning to situations

similar to encountered in the real world, as well as situations that approximate how scientists do their work (National Resource Council, 1996). Engaging students in science by challenging them with problems provides their science a sense of purpose (Yager, 2000).

Technology serves as a valuable tool in problem-based learning. Computers have become invaluable in science because they speed up and extend people's ability to collect, store, compile, and analyze data, prepare research reports, and share data and ideas with investigators all over the world (AAAS, 1993). Using technology allows students to communicate with others outside of their school, work with students at different locations and easily communicate with students who are working at different times (Batane, 2002). Computer-aided instruction combined with problem solving encourages learners to identify scientific facts associated with each particular problem, to collect necessary data, and information, and elaborate on their solutions (Chang, 2002).

Telecommunications; including email, discussion groups, student-to-student projects, class-to-class projects, and school to school projects are all possible through the use of technology. Technology allows students to communicate with people all over the world to conduct research, work and work cooperatively (Rice and Wilson, 1999).

Project Development

The instructional design process, as outlined by Dick and Carey (1996), was used in developing this project. The instructional design process is divided into nine steps. The nine steps of the instructional design process are as follows:

1. Assess needs in order to identify instructional goals,
2. Analyze learners and contexts,

3. Conduct an instructional analysis,
4. Write performance objectives,
5. Develop assessment instruments,
6. Develop an instructional strategy,
7. Develop and select instructional materials,
8. Design and conduct formative evaluation of instruction, and
9. Design and conduct a summative evaluation of instruction.

The first step in the development of the *Tree Identification and Age Project* was conducting a needs assessment. The purpose of a needs assessment is to identify the goals of instruction and the necessary steps to achieve these goals. The needs assessment indicated a need for improvement of the current instructional methods. Item analysis of aggregate data of Iowa Test of Educational Development scores indicated improvement of student learning was needed in the following areas; applying the scientific method by doing real science, and using graphs to analyze and interpret data.

Interviews with the science staff indicated a need for improving skills in the areas of observation, measurement, and data recording, as well as the use of practical computer skills such as using the graphing function of a spreadsheet to analyze data. These skills are necessary for a student to be successful in more advanced science classes and lab science environments.

The goal of the *Tree Identification and Age Project* is to use problem-based learning of an authentic task to improve the scientific knowledge and skills of the learners in the Field Biology class. Improving the scientific knowledge of learners results in a deeper understanding of scientific content, and prepares them to participate in the social

practices valued by the scientific community (Lee & Songer, 2003). The problem-based learning environment also fosters improvement in the areas of cooperation, communications, measurement, and data recording (Batane, 2002).

The learners and the learning contexts were examined and performance objectives written. The performance objectives for the goal of the *Tree Identification and Age Project* are as follows:

1. The learners will produce graphs using the graphing functions of a spreadsheet program and analyzed data collected in the field with an accuracy of 100%
2. The learners will use the graphs they produced to identify the age of a tree from data which includes tree species and circumference within a range of ten years.
3. The learners will successfully complete all of the activities required to create a 20 minute electronic presentation of their results, and the methods used to formulate these results

The target audience for this project is the Field Biology Class of a medium-sized high school in a Midwestern state which consists of students ranging from tenth to twelfth grade. The analysis of previous knowledge and skills possessed by the students involved reviewing the curriculum content of science and technology courses that the students completed in the ninth grade. The middle school science curriculum contains activities that teach accurate measurement techniques. In ninth grade the students complete a computer overview course where they learn how to use Microsoft Excel to enter data and use formulas to organize and sort data. The ninth grade Environmental Science class teaches the skills of using an orienteering compass and pacing to create a map. The majority of the students in the class have successfully completed the ninth

grade *Computer Overview* and *Environmental Science* classes. The exceptions are students who have recently moved to the district, and students who were enrolled in *Biology* instead of *Environmental Science* as ninth graders. All students are familiar with the fact that as a tree grows it produces annual rings, and by counting the annual rings the age of the tree can be determined. The target audience does not have any prior experience using a Global Positioning Satellite (GPS) Receiver, Swedish Increment Borer, or identifying tree species by leaf and growth characteristics. The skills necessary for the learners to start the project are presented to the learners in a training manual used in the instruction before the beginning of the problem-based activity, as found in the learner analysis.

To provide learners with an authentic problem-based learning experience the *Tree Identification and Age Project* was developed. A real world work environment is simulated by the activities presented in the training manual, and the skills taught and reviewed in the training manual are used to complete *The Tree Identification and Age Project*. As students work on the activities in the simulated employee training they will be in a traditional classroom to learn the skills and outside the classroom to practice these skills. The activities included in the training manual can take place on campus. The fieldwork of the project portion of *The Tree Identification and Age Project*, where students will be mapping, identifying, and measuring trees, will take place in a wooded area. The data analysis takes place in a lab setting. These locations simulate the experiences new employees encounter starting a job in the forestry industry.

The social contexts of the project include the students working in large and small groups. In the field the learners work in groups of three. In the lab groups students may

combine to form larger groups to analyze the data. The number of groups is dependent upon the number of tree species in the area. The students will remain in the groups formed to do data analysis for the electronic presentations.

The following procedures are identified as the required steps for the learners to achieve the instructional goal:

1. Students will create an accurate map of an area by using a GPS receiver, orienteering compass and measured pacing.
2. The learners will use a field guide to correctly identify tree species by leaf, twig, and bud types.
3. In the field the learners accurately collect and record all data that is required for analysis in the lab.
4. Learners will use the graphing and trendline functions of a spreadsheet program to create a graph that is used to closely estimate the age of a tree when given tree species, trunk circumference, and position where the tree is growing on a slope.
5. Learners will determine whether the area of study is an old growth forest or reclaimed woodland.

Analysis of the goals allows the subordinate skills to be identified. These subordinate skills are defined in the psychomotor and cognitive domains (Dick and Carey, 1996). Psychomotor skills require both physical and mental activity. The subordinate skills in the psychomotor domain of the first goal, which involves creating a map of the area, include: (a) finding and recording the location of the area by using the appropriate function of a GPS receiver, (b) measuring and recording the length of average

pace, (c) measuring and recording distances using pacing (d) converting distance measurement from paces to meters, (e) using an orienteering compass to take bearing measurements, (f) illustrating bearing measurements on paper, (g) converting distances in meters to appropriate map scale, and (h) using a ruler and protractor to accurately place items on a map. Determining the appropriate scale for a map of the area is a cognitive skill, requiring the learner to solve a problem without any physical tools.

The subordinate skills of the second goal, using a field guide to identify trees by species, are dominated by intellectual skills. Students must be able to define and identify the differences in leaf type, growth characteristics of leaves, buds, and twigs, parts of a leaf and use a dichotomous key. The psychomotor skill of this goal is using proper measurement techniques.

The subordinate skills of the psychomotor domain involved in the third goal, where the students will use a spreadsheet to estimate the age of a tree, include: (a) using correct measurement techniques to measure the circumference of a tree, (b) entering data into a spreadsheet program, and (c) entering formulas into a spreadsheet program.

Cognitive domain skills are as follows: (a) identifying trees by species, (b) observing and recording the position where a tree is growing on a slope, (c) using a spreadsheet to sort data, (d) creating trendlines to analyze data, and (e) properly titling and labeling a graph.

The final goal consists entirely of skills in the cognitive domain. The subordinate skills are: (a) determining the existence of patterns in tree location using the large map, (b) determining the ages of the oldest trees in the area by using the graphs produced, and (c) conducting research to determine the history of the area.

The performance goals and the related objectives for the project are as follows:

1. Students will create an accurate map of an area by using an orienteering compass and pacing.
 - a. Using a GPS receiver learners accurately describe the location of the corners of the study area using latitude and longitude coordinates with an accuracy of 100%
 - b. Students use the correct format of position (UTM) using the GPS receiver 100% of the time.
 - c. Using concepts learned in the training manual and latitude and longitude measurements the learners find the correct UTM zone of the area of study with 100% accuracy.
 - d. Using measured pacing students find the distance between two points with an accuracy level of 95%.
 - e. If a strong GPS signal cannot be obtained learners will use an offset location, pacing and compass bearings to determine the coordinates of latitude and longitude of the corners of the study area with an accuracy of 95%.
 - f. Using an orienteering compass the students will take, and record, bearing measurements of the trees in the area of study with an accuracy determined by the quality of the compass.
 - g. Using data collected in the field, a protractor, and a straight edge the learners will create an accurate map of the location of the trees in their selected area with an accuracy of 95%.

- h. The learners will create a map legend which accurately includes all necessary information to use the map.
2. The learners will use a field guide to correctly identify tree species by leaf, twig, and bud types.
 - a. Using the diagrams and list of terms included in the training manual the students correctly identify the parts of a leaf, and stem with 100% accuracy.
 - b. The learners will identify all of the trees in their assigned areas by species using the provided tree identification keys and/or other media resources with 100% accuracy.
 3. In the field the learners accurately collect and record all data that is required for analysis in the lab.
 - a. Learners will accurately and precisely measure the circumference of every tree in their area using a flexible tape with an accuracy of 100%.
 - b. Learners record the measurements on an appropriate data table with an accuracy of 100%.
 - c. By observing the elevation changes of the area learners will determine and record the position on a slope where each tree is growing with 100% accuracy.
 - d. Using a Swedish Increment Borer the learners will take core samples from three trees and determine the age of the trees with an accuracy of 95%

4. Learners will use the graphing and trendline functions of a spreadsheet program to create a graph that is used to closely estimate the age of a tree when given tree species, trunk circumference, and position where the tree is growing on a slope.
 - a. Using a computer spreadsheet program the learners will create a spreadsheet that includes fields to include all of the data collected in the field.
 - b. Using a computer and spreadsheet software, learners will enter the data collected into the spreadsheet with 100% accuracy.
 - c. Learners will use the sort function of the spreadsheet to group trees according to slope and species data with an accuracy of 100%.
 - d. Learners will create graphs from the class data to find the age of a tree from the species, circumference, and slope data that is accurate to within the limits presented by the data.

5. Learners will determine if the area studied is an old growth forest or reclaimed woodland.
 - a. Using analyzed data and graphs the learners will determine the age of the woodland with an accuracy of 95%.
 - b. Learners will determine if any patterns of tree growth are present by analyzing the large map with an accuracy of 95%.
 - c. Students will use county records to determine the use of the land when it became a woodland to an accuracy of 95%.

The assessment instruments used for the *Tree Identification and Age Project* are sets of rating systems developed by the writer. Rating systems exist for each instructional goal of the *Tree Identification and Age Project* and the final presentation. These rating systems for each goal match the objectives for the specific goal. The rating system is a four-level rating system ranging from zero points if the objective has not been completed, to three points for excellent work fulfilling the objective.

As learners progress through the training manual, a formative assessment takes place after each concept. The formative assessments are made by the instructor. Assessments from other groups may take place before the assessments by the instructor and these peer assessments have no bearing on the learner's grade. The formative evaluation from the instructor determines if the learner is ready to progress to the next level of training. The formative assessments provide feedback which helps the learners master the required skills before working in the field.

While learners are in the field, the teacher provides the only assessment. It is not the students' measurements and observations that are graded, but the techniques and skills used to make those observations and measurements. The assessment that takes place in the field is the rating system developed by the instructor. The teacher's role of assessor is to ensure the transfer of skills learned in the training portion to the fieldwork. The instructor may choose to have students assess each other's work.

As groups finish collecting data in their areas they are allowed to move to another group's area to check the data collected. The groups would come together and discuss differences in data, and correct any mistakes that were made. Groups would receive feedback on their data collection methods, and the quality of the data collected will be

improved. A subject matter expert, such as an employee of the Department of Natural Resources or the Forestry Service, may also observe and rate the students as they collect data in the field.

In the lab, students are assessed through the rating system, described in the formative assessment that is based on the different ways the data is analyzed. The learners are encouraged to develop different ways of analyzing the data and choose the one that provides the best way to predict tree age. The types and number of sources of information used in the research of the area are included in this rating system.

At the end of the project, each group presents their results to the rest of the class. The instructor-created rating system for the presentation assesses students on the presentation itself, the materials produced for the presentation, as well as the quality of the analysis of the evidence used to support their conclusion.

The instructional strategy for the *Tree Identification and Age Project* is an authentic problem-based learning exercise. The problem is presented to the students as an industrial simulation. The learners are put in the position of being newly hired employees of the fictional Kennedy Forestry Corporation. The learners start the *Tree Identification and Age Project* by working through a new employee training manual.

The training manual acts as a framework for the learner to learn the skills necessary to successfully complete the project and satisfy the goals of instruction. The students work cooperatively to complete this manual. The purpose of the training manual is to review and teach new skills needed for the completion of the project. Open environments have positive effects on learning outcomes among those students who have good prior knowledge and specialized expertise (Hakkinen, 2002). The review and

teaching of these skills ensures all of the groups completing the project are using homogeneous techniques to collect data in the field.

The training manual contains instruction on techniques and methods the learners will use while they are completing the *Tree Identification and Age Project*. The skills included in the manual include techniques in measurement, using a compass, map making, identifying trees by species, and using a spreadsheet program to create graphs.

Upon completion of the training manual the learners begin the authentic problem-based aspect of the *Tree Identification and Age Project*. The goal of the students is to identify if the area they select to study is an old growth, or reclaimed woodland. To complete this goal successfully the learners are required to use all of the knowledge and skills learned in the training manual to provide information to support their answer and reasoning.

The instructional materials needed by each student to complete the *Tree Identification and Age Project* are the Kennedy Forestry Training Manual, a clipboard, paper and a pencil. The items required by each group include; Orienteering compass, a two meter flexible tape measure, enough string to mark the area of study, a tree identification manual, and a meter stick. The learners will need access to computers, a spreadsheet program with graphing capabilities, and a Global Positioning Satellite Receiver.

The role of the instructor is a guide, supporting the learners when they experience difficulty and approving the student work as they complete each section of the training. As the instructor assesses student work through the training manual, the instructor may

feel that supplemental materials are needed. The specific needs of different audiences will dictate the amount of additional material needed to be produced by the instructor.

Once the learners complete the training manual, no additional instructional materials are required. The only materials the students will need after this point are the required forms from the simulated Kennedy Forestry Corporation, a tree identification guide, tools to use in the field, computers with a spreadsheet program, computers with access to the World Wide Web, and access to historical documents. The problem-based learning aspect of the project limits the number of instructional materials, but requires resources to aid in student inquiry.

Formative evaluations of the *Tree Identification and Age project* will be made as the learners progress through the training manual. The formative assessments of student learning, during the training phase provide the instructor with information about the strengths and weaknesses of the instruction and the target audience. At each evaluation the instructor should decide if supplemental materials are necessary.

Formative evaluations of the transfer of learning take place by the instructor as students complete the authentic problem-based aspect of the *Tree Identification and Age Project*. If knowledge and skills are not being transferred from the activities of the training manual to the field work the instructor may choose to halt the work in the field and have the learners complete some remedial materials. The formative evaluation that takes place in the field provides the instructor with an opportunity to observe the transfer of skills to a real world environment. Normally no instruction would take place at this stage; students are using the skills they mastered in the training.

The summative evaluation will have a phase that examines the educational benefits of instruction. The evaluation of educational benefits is conducted by observing the learners throughout the remainder of the school year.

THE PROJECT

The *Tree Identification and Age Project* is written as an industrial simulation for the fictional Kennedy Forestry Corporation. The project begins with the target audience in the position of recently hired workers in the forestry industry. The curricular focus of the *Tree Identification and Age Project* is that of a Field Biology Class. The curriculum of the class includes activities in measurement and tree identification. The *Tree Identification and Age Project* allows the learners in the class to experience an authentic problem-based activity to learn these concepts while using them to conduct scientific research. The primary materials developed for this authentic problem-based approach consist of a training manual which simulates a set of materials a person in the forestry industry would have to complete on starting a new job.

The first phase of the project consists of the learners completing a period of training. The training takes place in the form of a training manual. The skills reviewed in the training manual are skills the learners may have previously experienced in their academic careers. These skills include proper measuring techniques, map making, and using a spreadsheet program. These skills are reviewed to ensure the data collected in the project is done so in a consistent manner.

The skills in the training manual that are new to the learners include using a Global Positioning Satellite receiver and identifying trees by leaf, twig and bud characteristics. The skills are introduced to the learner in the order the learners will use

the skills in the field. With the exception of tree identification, practice exercises are provided to the learners to master the skill before moving on. As formative evaluations of the learning take place the instructor may choose to supplement the training manual with traditional classroom methods as well as more materials.

Upon completion of the training manual, the learners move into the field to simulate a real world work experience. A nearby wooded area is selected by the instructor for the learners to collect their data.

When a suitable location has been found, the instructor will contact the land manager of the area to get permission to work in the area. It is vitally important to get permission before starting the project.

The size of the area in which each individual group of students works is dependent on the number of trees to be identified by each group and the size of the trees in the area. An area dominated by large adult trees produces a canopy that limits the number of young trees that can grow. In forests of the Pacific Northwest the height of mature trees produces a canopy that provides enough shade that only three to six trees grow per acre. It is suggested that an area is selected with twenty adult trees to be identified.

The learners use a long piece of string to mark their research area. The length of the string is dependent on the size of the area of study. An area of study of four hundred square meters requires a piece of string eighty meters in length. The marked areas do not overlap, and each area is adjacent to the area of another group. The string boundary is used to ensure that no trees in an area are omitted, or recorded twice in the data collection.

Learners use a GPS receiver to locate and record the latitude, longitude, and altitude of each corner and center of their area. The latitude, longitude, and altitude coordinates are used when data is compiled at a later time in the project. Offset GPS readings, compass coordinates, and measured pacing are used to locate the required coordinates if a clear view of the sky is unavailable.

Using measured pacing and an orienteering compass, students collect and record data describing the locations of the trees in their area of study. A map of the area is sketched at this time to be used as a reference when creating the final map. A tree is defined as a woody plant with an erect perennial trunk at least 24 centimeters in circumference at breast height (1.3 meters), a definitely formed crown of foliage, and a height of at least four meters (Little, 1998).

A field guide is used to identify each individual tree by species. Trees are identified by both common and Latin names. Common names aid students in learning the tree species common to the area. Latin names are used to ensure correct identification of tree species in the data. If a tree is not positively identified in the field, a leaf, twig and fruit samples are collected to aid in properly identify the tree species at a later time. A photograph of unidentified trees is taken and used at a later time in species identification.

The circumference of a tree is measured and recorded at a height of 1.3 meters above the ground. A 1.3 meter long stick is used to easily reproduce a consistent measuring height. The stick is held firmly against the ground as a flexible tape is wrapped around the tree at the height of the top of the stick. The height of the circumference measurement of the trunk is read and recorded. The circumference measurement for trees

growing on a slope is taken on the uphill side of the slope to ensure consistency of the data collection.

The position the tree is growing on a slope is recorded at this time. This information describes the position of the tree as at the top of a hill, on a slope, or at the bottom of a hill. The most important factor in the rate of a tree's growth is the availability of water. Trees located on lakesides, riversides, roadside ditches, and the bottom of slopes will have a more consistent supply of water than a tree on a hill top or a slope (Stokes & Smiley, 1996).

The learners select three trees in the area for coring with a Swedish Increment Borer. The core sample taken with the increment borer allows the number of annual rings of the tree to be counted, and the age of the tree found. Learners have the option of counting the annual rings in the field, or preserving the cores and aging the tree at a later time. The age of the tree is recorded as the number of annual rings are counted. Three trees are cored in each area to minimize damage to the trees. A subject matter expert, such as a State Forestry Officer, is a valuable resource at this stage of the project with expertise in boring trees and caring for core samples.

To find tree age with one hundred percent accuracy the tree must be cut down at ground level and the number of annual rings counted. The age is then cross-dated with other mature trees that have been cut down in the area (Gutsell and Johnson, 2002). This method to find tree age would cause the *Tree Identification and Age Project* to be very short lived. The difficulty in boring a tree at ground level prevents the core samples from being taken at that height. The consistency of taking core samples at a height of 1.3

meters provides a very close estimation of the age of the tree, while ensuring the tree is twenty for centimeters in circumference at this height.

Data analysis takes place in a lab setting when the fieldwork is completed. The first task required of the learners is to meet as a class and determine an appropriate scale to use for creating their maps. Each group creates a map of their area of study. The map includes the locations and species of all the trees in their area.

Each group's map is combined to form a large map of the area. The large map is used by the entire class. The large map creates a large-scale view of the area of study. This large-scale view will show patterns of tree position that may not be noticeable in the field. A line of trees that are of similar age will show where structures such as fence lines or windbreaks were present at one time.

The second phase of data analysis consists of the learners entering their data into a spreadsheet program. At this time the learners meet as a class to determine the format of the fields in the spreadsheet. All groups agree to enter data into the spreadsheet using the decided upon format. Each group's data is combined to form a large body of data for sorting and analysis.

Before the sorting and analysis take place, the cells of the spreadsheet are locked to ensure that no data is changed. The spreadsheet program is used to sort data by fields such as tree species and the position the tree is growing in relation to any slope of the surrounding terrain.

Each group selects, or is assigned, a different tree species for analysis. Graphing the data is the most effective form of analysis. Each group produces several types of graphs. Comparisons depicted in graphs include: circumference vs. age, diameter vs. age,

and cross sectional area vs. age. The graphs are first created by hand to ensure that the students understand how to create the graphs. The instructor approves the handmade graphs before the spreadsheet program is used to create electronic versions of the same graphs. The electronic versions of the graphs are compared to the hand made versions of the graphs to ensure the electronic versions have been made correctly. The electronic versions of the graphs allow the learners to use functions such as linear regression to reveal trends in the data. Graphs are produced to represent all data collected.

The student-produced graphs are used to determine the ages of the oldest trees in the area. The ages of the oldest trees are used to determine the time in history in which the area became forested. The time determined when the area became forested is used as a starting point for the learners to research the history of the area. Patterns of tree growth from the large area map are also used in determining if the area was previously settled.

The ages of the oldest trees in the area provide a starting point for the students in researching county records to learn about the history of their area. Patterns on the combined student map are an aid in determining if the area was settled at one time.

The history of the area is found by researching county records. Historical land record information available on the World Wide Web is used for this example. The learners access the research materials using computers in the classroom. Newspapers also provide a valuable source of historical information of cataclysmic events such as fires or storms that would have affected the area during the time in question.

Upon the conclusion of the research learners create an electronic multimedia presentation of their results. An electronic form of the media presentation is stored to allow it to be easily shared. The presentation includes an explanation of the techniques

used to do research in the field, a map of the area, data used in analysis, graphs used in data analysis, age of the oldest trees in the area, the conclusion of the history of the area, and the research supporting the conclusion.

Training Manual

Many skills are necessary for students to complete the *Tree Identification and Age Project*. As part of the simulation, each student must complete the accompanying Employee Training Manual. The Employee Training Manual was organized to provide the step-by-step instruction for learning these skills as well as periodic activities to provide an on-going formative evaluation of their skills.

The training manual is introduced to the learners as a manual of skills required to work for the Kennedy Forestry Corporation. A brief introduction and job description launches the learners into the first activity.

The first lesson the learners encounter is making accurate and precise measurements. A brief lesson on accuracy and precision is read by the learners followed by practice exercises. Upon completion of the practice exercises the learners submit their work to the instructor for approval. Throughout the training manual the instructor must approve the student work before the student can go on to the next lesson. If a student is struggling with a particular concept the instructor may find it necessary to include remedial materials to guide the learner toward mastering each concept.

The second lesson encountered by the learners is the units of measurement, and the mathematical operations involved to obtain derived units, such as cross-sectional area. The learners are to read the lesson, complete the accompanying practice exercises, and be approved to move on to the next lesson by the instructor.

The following lesson on latitude and longitude introduces the learners to how the earth is divided into horizontal and vertical segments, and introduces the concept of the Universal Transverse Mercator (UTM) system of describing a position on the surface of the earth. The UTM coordinate system describes positions on the Earth in distances from the equator and a central meridian, rather than using degree measurements. The UTM coordinate system streamlines the mathematics required by the learners to create and identify locations on maps. By using UTM coordinates the learners can use plane geometry to locate items on a map, rather than trying to relate coordinates through advanced Euclidean Geometry.

The learners are introduced to the function and use of a Global Positioning Satellite (GPS) receiver. The students use the GPS receiver to locate the UTM positions of objects at three locations. The three objects are given to the learners by the instructor, allowing the instructor to compare the UTM coordinates of the learners to the readings known to be correct.

GPS receivers are valuable tools, but are of little use without a clear view of the sky, as is the case in wooded areas. The next part of the training manual provides a lesson and exercises with an alternative method used to measure the distance between two points. This alternate method is the use of measured pacing and converting the number of paces to a linear distance in meters. Like previous lessons the learners complete the provided practice exercises and submit them to the instructor for approval.

In areas where the GPS receiver is unable to be used, the learners need a second method to find the position of trees in their selected area of study. This portion of the manual describes how using compass coordinates combined with measured pacing can be

accurately collect data to place items on a map. The learners are presented with instruction on using an orienteering compass, including taking bearing measurements. Exercises for the learners to practice these skills are completed and submitted for instructor approval.

At this point in the training manual the learners have all of the necessary skills to collect data and create an accurate map of an area. The instructor provides an area for the learners to map. Making a map of a known area allows the students to combine and practice all of the skills they have completed to this point. Upon completion of the map the learners submit it to the instructor for approval.

The next section of the training manual provides materials for the learners to identify trees by leaf types and growth characteristics. The materials included for the learner to use are a list of terms describing the growth and leaf characteristics of trees. Diagrams and illustrations are also included to provide graphic examples of the terms. The instructor is required to develop and provide materials for the learner to use during this segment of the training lessons. The flora of the area of study dictates which species and growth characteristics should be emphasized by the instructor. Information required to identify tree species by leaf type and growth characteristics would be very different for learners in Florida than learners in Oregon.

A lesson about using a dichotomous key is included in this segment. Most tree identification guides are based on the use of dichotomous keys in identifying trees by species. No activities are included in this segment. It is the intent of the writer that lessons in using a dichotomous key would be included in the lessons of identifying trees

by species. The lessons in tree identification would be specific to the flora of the area of study.

Collecting data in the field is the next topic discussed in the manual. The learners are introduced to the form that is used in the field to record data about each specific tree in their area. An example of the form is provided with an explanation of the specific data that is expected to be collected in the field.

A description of how core samples are taken from trees to determine tree age is also included in this section. It is suggested by the writer that students are allowed to practice this technique on a log rather than on a living tree. While coring a tree is not necessarily harmful to a tree, it is not necessarily good for it either. The instructor may wish to have a section of a tree trunk in the classroom for students to practice this skill.

A brief and optional activity included in the training manual requires students to research and discuss factors that affect tree growth. The purpose of this activity is for students to realize that the position a tree is growing on a slope determines how much water a tree has available to it. This activity also provides an entry point for learners to hypothesize on further topics of study.

The remaining section of the manual discusses how to use a spreadsheet program to analyze data and create graphs. Specific methods of data analysis are not discussed. Sample data is included for students to practice making graphs.

CONCLUSIONS AND RECOMMENDATIONS

Insights Gained from Project Development

The *Tree Identification and Age Project* has been in various stages of development since 1999. The scope of the project and the target audience has changed several times during development of the project. The original project did not include any training before the learners collected data in the field. The students were required to master the necessary skills needed to complete the project as the project was being completed. Using this approach allowed the project to meet its educational goals, but data collected did not have scientific value.

The industrial simulation approach to the *Tree Identification and Age Project* was adapted late in the project development. The fictional company of the Kennedy Forestry Corporation is used to give the learners a taste of a real world environment and provides a sense of purpose for the project. A new employee-training manual was developed as an instructional tool.

The training manual provides instruction on the techniques used collecting data in the field. The skills reviewed and learned in the training manual can be taught using traditional classroom methods. Traditional classroom instruction is not the intent of the *Tree Identification and Age Project*. The training manual gives the instructor a resource to use as a guideline through the beginning of the project, but is intended for student use. As the learners use the training manual it remains a work in progress. The learners are encouraged to question each other and create their own supplemental activities and problems.

The training manual ensures all learners involved in the project are using consistent techniques throughout the data collection portion of the activity. Consistent techniques improve the quality of the data collected during the project. The data integrity of the project creates a valuable database for other scientific investigations.

The area selected by the instructor for the *fieldwork* to take place is dependent upon several factors. The most important factor is permission of the group to take core samples from the trees. If core samples cannot be taken, tree age cannot be found, and the research never gets started. Coring does not harm trees, but many land managers do not want to take that chance.

The amount of undergrowth in the wooded area is another item to consider. If the brush is thick enough, it will be hard to see or walk through. It will be difficult to make a map of the area. A forest filled with Multiflora Rose bushes would greatly reduce learner enthusiasm for the data collection part of the project.

The size of area that each group is assigned is also considered. A stand of mature trees produces a thick canopy that does not allow enough sunlight to reach the forest floor to allow young trees to grow. Experimentation during development of this project has shown that one twenty meter by twenty meter area produced only three trees that were large enough to be included in the data.

The instructor determines the number of trees for each group is to identify, and assigns an area of appropriate size. The tree identification part of the project is the most difficult part of the project. The learners are required to apply their knowledge of leaf, twig, and bud types to determine tree species. The judgments that are needed to identify one species from another are not always easy.

It is possible to create a map of each student area using the spreadsheet program. The mathematic principles involved in creating an electronic version of the map are beyond the abilities of the target audience. An electronic version of the map does not add significant value to the *Tree Identification and Age Project*. The training manual includes instructions for using the spreadsheet program to create a map, but can be omitted from the project.

Personal experience has demonstrated it is important for learners to know how to create a graph with paper and pencil before creating a graph using a spreadsheet program. Hand drawn graphs are produced before electronic versions to review the skills necessary for producing a graph.

Research in the area of dendrochronology has identified factors important in determining the growth rate of trees. The factors include genetics, soil nutrients, availability of sunlight, and availability of water. The greatest environmental factor is the availability of water. A tree growing at the bottom of a slope will have access to a greater supply of water than a tree growing at the top of the hill. The position each tree is growing in relation to a slope is an important piece of data.

This project assumes that the genetic makeup of a group of trees studied by a single class will not vary greatly. With the exception of Cottonwood seeds, tree seeds do not have the ability to travel far before they reach the ground. The area in which this original research is intended is not on a migratory route for any animals large enough to transport seeds a long distance. An extension of the research done in this project would explore the assumption that all trees of a single species are genetically linked.

It is also assumed that the soil nutrients in an area the size used by a single class will not vary greatly. An extension of this research is encouraged. Soil testing from the area could be done at the time of the initial research, or at a later time. The student-produced maps of the area are to be used to identify specific locations for the samples to be taken. The soil nutrient data is easily be added to the database. Soil nutrient data provides another field for which to data to be sorted and analyzed.

Available sunlight is an important factor that should not be overlooked. A tree growing under a thick canopy will experience slow growth until it reaches the canopy and receives more light. Many of these shaded trees do not reach adulthood because they starve before reaching the canopy. Young trees growing on the edge of the canopy receive more light and have a better chance of becoming mature trees. Examining the ages and species of the trees on the large student map allows the learners to study the succession of their area.

The data collected by each group will be shared with others doing the same research. The graphs used to predict tree age from the data will improve as the body of data grows. A large amount of data is preferred to a small group in any statistical analysis. As the body of data grows, the accuracy of the graphs predicting tree will improve.

As the data is analyzed, students are encouraged to hypothesize about similarities and discrepancies in the data. These hypotheses and their experimental results are the means by which the body of data will be improved as well as provide valuable questions for the learners to research. As the number of variables affecting tree growth examined by this research increase simple graphs will no longer be useful in determining tree age.

The learners' presentations of their results provide closure to the training program of the Kennedy Forestry Corporation. The presentations will be saved and made available to other classes doing the same research. The learners will be encouraged to question and comment other group's results. If time allows further scientific inquiry is encouraged.

Future Projects/Research

This project will be implemented by the Field Biology classes of Kennedy High School during the 2006-2007 academic year. In the ensuing years it may be implemented by all of the Field Biology classes of the Cedar Rapids Community School District. Increased implementation requires more items to be entered into the database. Soil fertility is an example of a data field that will have to be included to allow sharing of data between two areas which are in close proximity.

As implementation of this project grows across a broad geographic area the data fields will be expanded to include information such as the type of biome the area is located in and length of growing season. Including data from different geographical areas will require communication between the different locations. Learners will be required to communicate through space and time to discuss research methods and debate database fields. Through this communication the learners develop skills involved in presenting information through a variety of forms of telecommunications. The types of media used in this communication include telephone, email, or video.

Recommendations

Eventual product development of The *Tree Identification and Age Project* will include an entire inquiry-based science course growing from the project and its extensions. Learners will develop their own course of study from the questions developed

during data analysis. The questions the students' research and test will not be limited to a localized area of study. The size of the geographic area of the research will only be limited by the larger geographic area represented by all of the schools involved in the project.

The learners will be required to develop their own standardized research procedures, and produce a training manual of these techniques. All parts of the learners' research will be made available on the World Wide Web. The student-produced training manuals will provide a starting point for others wanting to conduct the same research. Learners developing hypotheses, conducting research, collaborating with others through space and time, and making the results of their research available to others will allow the learners to become scientists.

To increase learner attention the project needs to be presented to the learners as new employees of a forestry company, and the skills needed to successfully complete the project are part of the new employee-training course. While the students work in small groups within specific areas, the entire class will still work as a team to solve the problem.

Climate and soil type will be the largest factors affecting trees from different regions. Areas studied that are in the same biome should have very similar climates. A simple biome map of North America, used with GPS latitude and longitude data is a simple way to ensure trees from similar climates were being studied. The soil nutrients in a forest will be very similar throughout. Soil nutrients will vary from area to area. As the project is developed while it is implemented, soil testing may also be conducted, and included in the data.

Because of the limited amount of data available during the first year of the project students may not have any concrete answers in relating tree circumference to age.

Implementation by one school for several years, on the same piece of land would provide enough data about individual trees to develop equations that relate tree diameter to tree growth. If patterns in growth rates are not found in the first year of the project the data collected may include data such as heights of surrounding trees and location of the tree in the wooded area. These items may play a role in yearly growth limiting the amount of available light to the tree.

In a localized area, this information on tree age and diameter, would be important to anyone who is interested in tree age, such as historians, the Department of Natural Resources, and members of the lumber industry. The large body of data that will be produced by this project will be valuable to other researchers that are working in related fields.

A large number of schools in a localized area (i.e. Cedar Rapids, Marion, Iowa City) may want to implement this project in a collaborative manner. They may find no correlation between their data during the first years of implementation. These findings would carry the same importance as closely matched data raising questions about the differences in tree growth. The questions would develop avenues such as how growth is affected by soil type, and soil nutrient content. These questions could be developed as hypotheses for further research.

REFERENCES

- American Association for the Advancement of Science. (1993). *Benchmarks for Science Literacy*. New York, New York; Oxford University Press.
- Batane, T., (2002) Technology and student collaboration. *T.H.E. Journal*, 30(3), 16-20.
- Bloom, B.S., (1956). *Taxonomy of educational objectives: The classification of educational goals. Handbook 1: Cognitive domain*. New York; Addison Wesley.
- Bostock, S.J., (1998). Constructivism in mass higher education: A case study. *British Journal of Educational Technology*. 29(3), 225-240.
- Certo, J.L., Cauley, K.M., & Chafin, C. (2003) Student's perspectives on their high school experience. *Adolescence*, 38(152), 705-724.
- Chang, C.Y. (2002). Does computer assisted instruction + problem solving = improved science outcomes?: A pioneer study. *The Journal of Educational Research*, 95(3), 143-151.
- Chin, C., & Chia, L. (2004). Implementing project work in biology through problem-based learning. *Journal of Biological Education*, 38(2), 69-75.
- Clark, A.C. & Ernst, J.V., (2007). A model for the integration of science, technology, engineering, and mathematics. *The Technology Teacher*, 66(4), 24-26.
- Cruickshank, B.J., & Olander, J. (2002). Can problem-based instruction stimulate higher order thinking?. *Journal of College Science Teaching*, 31(6), 374-373.
- Dick, W., & Carey, L. (1996). *The Systematic Design of Instruction*. (4th ed.). New York: Longman.
- Gallagher, S. A., & Stepien, W. J., (1995) Implementing problem-based learning in science classrooms. *School Science & Mathematics*, 95(3) 136-146.

- Gutsell, S.L., & Johnson, E.A. (2002). Accurately ageing trees and examining their height-growth rates: implications for interpreting forest dynamics. *Journal of Ecology*, 90, 153-166.
- Hakkinen, P., (2002), Challenges for design of computer-based learning environments. *British Journal of Educational Technology*. 33(4). 461-469.
- Hannafin, M.J., (1992), Emerging Technologies, ISD and learning environments: Critical Perspectives. *Educational Technology Research and Development*, 40(1), 49-63.
- Hill, A.M., & Smith, H.A., (1998), Practice Meets Theory in Technology Education: A case of Authentic Learning in the High School Setting. *Journal of Technology Education*. 9(1), 29-41.
- Hill, A.M., & Smith, H.A., (2005), Research in purpose and value for the study of technology in secondary schools: A theory of authentic learning. *International Journal of Technology and Design Education*. 15(1), 19-32.
- Holmes, P., (2002), New ways of pupil evaluation using real data. *Teaching Statistics*, 24(3), 87-89.
- Krathwohl, D.R., (2002), A revision of Bloom's Taxonomy: An overview. *Theory Into Practice*, 41(4). 212-218.
- Lee, H.S., & Songer, N.B., (2003). Making authentic science accessible to students. *International Journal of Science Education*, 25(8) 923-948.
- Little, E.L., *National Audubon Society Field Guide to North American Trees. Eastern Region*. New York: Knopf.

- Maxwell, N. L., Mergendoller, J. R., Bellisimo, Y., & Kennedy, P. (2005). Problem-based learning and high school macroeconomics: A comparative study of instructional methods. *Journal of Economic Education*, 36(4), 315-331.
- National Research Council. 1996. *National Science Education Standards*. Washington, D.C.; National Academy Press.
- Palmer, D., (2004a) Theory to practice: Ideas for arousing student interest in science classes. *Teaching Science*. 50(2), 51-53.
- Palmer, D., (2004b) Situational interest and the attitudes towards science of primary teacher education students. *International Journal of Science Education*, 26(7), 895-908.
- Partridge, N., (2003), Science out of the classroom, *Journal of Biological Education*, 37(2), 56-57.
- Paul, R. (1985), Bloom's taxonomy and critical thinking instruction. *Educational Leadership*, 42(8), 36-39.
- Perry, J.E., (2004) Authentic learning in field schools: Preparing future members of the archaeological community. *World Archaeology*, 36(2), 236-260.
- Renzulli, J.S., Gentry, M. & Reis, S.M.. (2004) A time and a place for authentic learning. *Educational Leadership* 62(1), 73-77.
- Rice, M.L., & Wilson, E.K., (1999). How technology aids constructivism in the social studies classroom. *The Social Studies*, 90(1), 28-34.
- Savery, J.R. & Duffy, T.M., (1995) Problem Based Learning: An instructional model and its constructivist framework. *Educational Technology*, 35(5), 31-38.

- Schraw , G., Flowerday, T.,& Lehman, S. (2001) Increasing situational interest in the classroom. *Educational Psychology Review*, 13(3), 211-224.
- Slavin, R.E.,(1991), Synthesis of Research on Cooperative Learning., *Educational Leadership*, 48(5), 71-81.
- Stokes, M.A. & Smiley, T.L. (1996). *An introduction to tree ring dating*. Chicago: University of Chicago Press.
- Uyeda, S., Madden, J., Brigham, L.A., Luft, J.A. & Washburne, J. (2002). Solving authentic science problems. *The Science Teacher*, 69(1), 24-30.
- Van Merriënboer, J.G., Kirschner, P.A., & Liesbeth, K., (2003). Taking the load off a learner's mind: Instructional design for complex learning. *Educational Psychologist*, 38(1), 5-13.
- Yager, Robert E., (2000). A vision for what science education should be like for the first 25 years of a new millennium. *School Science and Mathematics*, 100(6), 327-342.



Kennedy Forestry Corporation

Employee Training Manual

Table of Contents

Introduction and History	1
Job Description	1
Making Accurate Measurements	2
Measurement Practice	3
Units of Measurement and Position	4
Latitude and Longitude	6
Units of Position	7
Determining Universal Transverse Mercator Latitude Zone	8
Determining Coordinates Within a Zone	10
The Global Positioning Satellite Receiver	11
Using a GPS	14
GPS Receiver Practice	15
Using Measured Pacing to Find Distance	17
Factor Dimensional Analysis	18
Using a Compass	20
Reading the Compass	21
Taking Bearing or Heading Measurements	23
Combining Measured Pacing and Bearing Measurements to Make a Map	24
Mapping an Area	26
Finding location when GPS Satellite Signals are not Available	30
Finding location when GPS Satellite Signals are not Available Worksheet	32
Tree Identification Terms	33
Leaf Types	35
Simple Leaf Blade	36
Compound Leaf and Twig	37
Types of Leaf Growth	38
Using a Dichotomous Key	39
Collecting Tree Data	40
Data Collection Table	41
Extracting Core Samples Using an Increment Borer	42
Finding Tree Age From Core Samples	43
Factors Affecting Tree Growth	44
Data Analysis with Graphs	45
Creating Graphs with Microsoft Excel	46
Producing Maps Using Spreadsheet Data	50
Trigonometry Functions	51
Example Problems	53

Introduction

Formed in the summer of 2006, the Kennedy Forestry Corporation is a scientifically based company specializing woodland research. The Kennedy Corporation collects data about the size, type and location of trees in the surrounding forests. Analysis of these data provides estimates of the woodlands' ages. The data collected by our employees is used for in-house research, and made available to other researchers studying a wide variety of forestry related topics.

Job Description

As the Kennedy Forestry Corporation expands, workers from across North America will be enlisted to provide data for this research. It is important that all workers use the same techniques when collecting data for this research. The purpose of this manual is to provide training in the skills required in the forestry industry.

The following lists of skills are required of your position at the Kennedy Forestry Corporation. You must be able to:

- Use the correct techniques to accurately measure the circumference of a tree.
- Use a Global Positioning Satellite receiver to record altitude, Universal Transverse Mercator zone, easting, and northing coordinates as well as altitude for a specific area.
- Use pacing to accurately measure distance.
- Use an orienteering compass to take bearing and heading readings.
- Collect data and create a map of an area.
- Accurately record data
- Create an accurate map from pacing distances and compass coordinates.
- Identify tree species from leaf, twig, and bud characteristics and a field guide.
- Use a Swedish Increment Borer to take core samples from trees.
- Determine tree age by counting the annual rings from core samples.
- Use a spreadsheet program to sort data by appropriate fields.
- Use the graphing function of a spreadsheet program to create tools that will be used by yourself and other researchers.

Making Accurate and Precise Measurements

It is important to minimize error while making measurements to ensure accurate data. The best way to avoid error is to take repeated measurements of the same object to ensure consistency of the use of proper technique. The purpose of this section of the training manual is to teach proper measurement techniques to minimize the possibility of error.

Poor accuracy involves errors in technique that can be corrected. Precision describes how exact a measurement can be. The precision of a measurement is determined by the limitations of the measuring instrument.

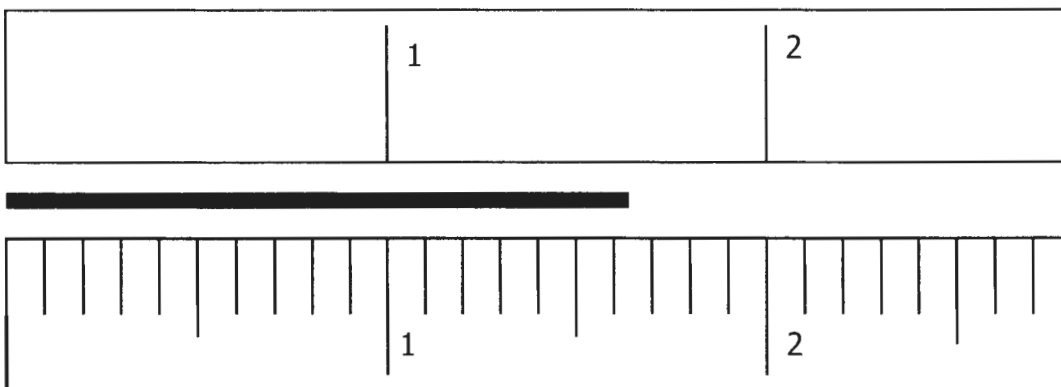

The diagram above shows how limitations of a measuring device determine the precision of the instrument. A reasonable estimation of a measurement is allowed. If the top ruler is used, it is easy to see that the length of the line is between 1 and 2 units. Measuring the line using the top measuring device, it can be estimated the line is 1.6 units long.

If the lower measuring device is used, a much more precise measurement can be made. The lower measuring device has each unit divided into $1/10^{\text{th}}$ of a unit. The length of the line is between 1.6 and 1.7 units. The measurement can be estimated to be 1.63 units.

The number of significant digits included with a measurement describes the degree of precision in which the measurement was made. A measurement of 57 cm is less precise than a measurement of 57.00 cm.

The instructor will provide you with measurement instruments that have reasonable limits of precision related to their use. The care in which the measurements are taken will determine the quality of the data collected.

Measurement practice

Directions: Use the measuring device provided by your instructor to make the following measurements. Record your answers in the spaces provided.

Height of a lab table. _____

Length of a lab table _____

Width of a lab table _____

Circumference of the top of the wastebasket _____

Circumference of the bottom of the wastebasket _____

Height of the wastebasket _____

Height of the doorway _____

Width of the doorway _____

Compare the above answers to the correct measurements made by the instructor. Upon approval of the instructor, you may move on to the next exercise.

Units of Measurement and Position

The units of measurement used by the Kennedy Forestry Corporation are the International system of units. The International System of units is commonly known as the metric system. The metric system is the standard used by all countries of the world, with the exception of the United States.

The metric system is based on a decimal system. It is much easier to make conversions between units in the metric system than the standard English system used in the United States.

The base unit of length in the metric system is the meter. The meter can be divided into 100 equal parts each equaling 1 centimeter. To convert from centimeters to meters you simply divide the length in centimeters by 100 to get a length in meters. For example $156 \text{ cm} / 100 = 1.56 \text{ meters}$. All of your measurements in your work with the Kennedy Forestry Corporation should be converted to meters.

A derived unit that you may find necessary to use in your work is the unit of area. To find the area of an object the length of the object is multiplied by the width of the object. Both of the measurements will be in meters resulting in a unit of m^2 .

Find the area of the following:

The E-W length of your research plot is 30 m, and the N-S length is 35 m. What is the total area of your research area in meters?

For your research, a tree trunk is considered a nearly circular object.

The circumference of a circle is a length measurement of the line that makes up the circle. Circumference measurements are just a length measurement that is not in a straight line. The radius of a circle can be found by the circumference. The equation to find the circumference of a circle is $L = 2\pi r$. Solving this equation for radius (r); gives the equation to find the radius of the circle. $r = L/2\pi$.

Find the radius of the following.

A 20 m tall Red Oak tree has a circumference of 3.46 m at a height of 1 m from the ground. What is the radius of the trunk?

It may be necessary to find the cross sectional area of a tree trunk. The equation to find the area of a circle is; $\text{Area} = \pi * \text{radius}^2$ ($A = \pi r^2$).

Find the cross sectional area of the following:

A 15 m tall Shagbark Hickory tree has a radius of 30 cm at a height of 1 m from the ground. What is the cross sectional area of the tree at a height of 1 m?

A 24 m tall Northern Catalpa has a circumference of 1.34 m at a height of 1 m from the ground. What is the cross sectional area of the tree at a height of 1 m from the ground?

Solve the following:

A tree of unidentified species has a circumference of 1.28 m. To what depth should the boring instrument be inserted to ensure all annual rings are included?

Latitude and Longitude

Latitude is a measure of degrees north or south of the equator up to 90° North, or -90° South at the Poles. The latitude lines that encircle the globe are parallel to each other. One degree of latitude is equal to 11,320 kilometers.

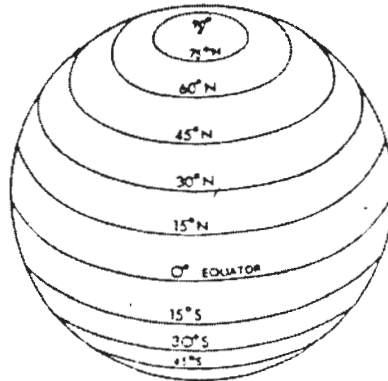

FIGURE 2.2. Parallels on the earth.

Longitude is a measure of degrees east or west of the Prime meridian up to 180° East or -180° West at the International Date Line.

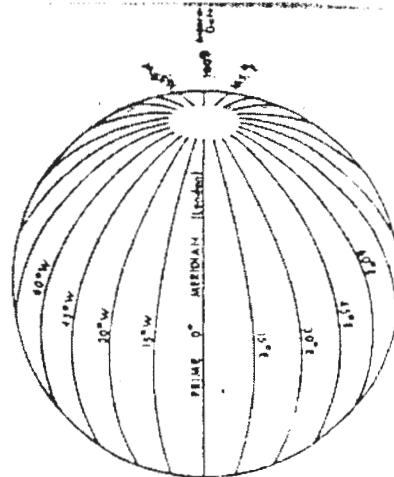

FIGURE 2.3. Meridians on the earth.

Altitude is the height in meters above or below sea level.

Units of Position

The positioning format used by the Kennedy Forestry Corporation is the Universal Transverse Mercator System (UTM)/Universal Polar Stereographic (UPS) system. The UTM system is advantageous to use in small areas, such as a research area. The coordinate numbering system of UTM directly corresponds to the metric measuring system for distance. All UTM coordinates are measured in meters and kilometers.

The UPS system deals with measurements in Polar Regions. No trees grow in these polar regions (below 80° S latitude, 84° N latitude).

All UTM coordinates consist of three pieces of data. The first number and letter describe the specific zone the area is located. The UTM system divides the earth into 60 evenly spaced 6° wide zones. The zone numbering starts at the 180° meridian and moves easterly to the 174° meridian. The 177° meridian bisects the first zone.

Find the grid zone of the area you wish to study from longitude degree measurements is as follows:

- West longitude readings are negative and east longitudes are positive.
- Add 180° to the longitude to get a number between 0 and 360°.
- Divide this total by 6 and round up to the next highest whole number.

For example Cedar Rapids, Iowa is at 91.681° W longitude.

$$-91.681^{\circ} + 180^{\circ} = 88.319^{\circ}$$

$$88.319^{\circ} / 6 = 14.71$$

14.71 rounds up to 15.

Finding the zone of the latitude is a little more complicated. The zones of latitude are lettered starting from A at the South Pole, to Z at the North Pole. Zone M is the first zone south of the equator, and Zone N is the first zone north of the equator. Zones A,B,Y, & Z designate Polar regions that are too cold for trees to grow. The letters I and O are omitted to avoid confusing them for the numbers one and zero. The 22 zones designated by the remaining letters of the alphabet are each divided into 8° segments.

Latitude Degree Measurement	Designated letter	Latitude Degree Measurement	Designated letter	Latitude Degree Measurement	Designated letter
5-10	B	58-66	J	114-122	R
10-18	C	66-74	K	122-130	S
18-26	D	74-82	L	130-138	T
26-34	E	82-90	M	138-146	U
34-42	F	90-98	N	146-154	V
42-50	G	98-106	P	154-162	W
50-58	H	106-114	Q	162-174	X

Determining UTM zone letter from latitude coordinates:

- Northern latitudes are positive and southern latitudes are negative.
- Add 90° to the latitude measurement..
- Use Table-1 to determine the letter of the latitude zone. Notice in Table-1 that the letters A, I, O, X, Y and Z are omitted.

Find the UTM zone letter of the following locations.

Brainard, MN (Latitude = 46.35697° N)

Dallas, TX (Latitude = 32.79000° N)

Salem, OR (Latitude = 44.95041° N)

Salem, MA (Latitude = 42.52809° N)

Salem, FL (Latitude = 29.89496° N)

The instructor should approve your answers before moving on to the next activity.

Find the correct UTM zone (letter and number) for the following locations.

Boston, MA
42.378° N
-71.058° W

Los Angeles, CA
34.062° N
-118.248° W

Chicago, IL
41.849° N
-87.643° W

Determining Coordinates Within the Grid Zone.

The following is an example of UTM coordinates as they appear on a GPS receiver.

15T 0598249
4664252

The notation is written as 15T 598249 E. 4282182 N.

The digits following the zone represent the distance in meters from the central longitude meridian of the zone (Easting measurement).

The central meridian of the zone is arbitrarily assigned the value of 500,000 meters. The widest zones are the zones closest to the equator. The widest this six degree zone can be is 674,000 m. The minimum and maximum values of any easting measurement are 163,000 m and 837,000 m.

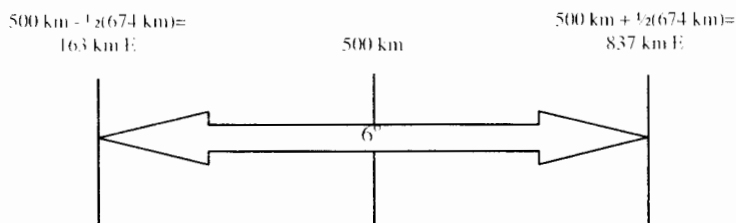

The final set of numbers (Northing measurement) represent the distance north of the equator in meters. For measurements north of the equator the equator is assigned the value zero. Measurements south of the equator originate from the south pole. The equator is arbitrarily assigned the value of 10,000,000 m or 10,000 km for southern measurements.

Zone Number (Latitude)	Zone Letter (Longitude)		10^6 (m)	10^5 (m)	10^4 (m)	10^3 (m)	10^2 (m)	10^1 (m)	10^0 (m)
T	15	Easting	0	5	9	8	2	4	9
		Northing	4	6	6	4	2	5	2

Shorthand representation of UTM coordinates omits the digits representing coordinates of 10^6 and 10^5 . For most maps used in the field these digits are repetitive and just stated in the map legend. On standard topographic maps the 10^2 and 10^1 are most commonly used.

98 64	Describes a 10^3 m * 10^3 m area
982 642	Describes a 10^2 m * 10^2 m area
9824 6425	Describes a 10^1 m * 10^1 m area
98429 64252	Describes a 10^0 m * 10^0 m area.

The Global Positioning Satellite Receiver

GPS is an acronym for Global Positioning System. The Global Positioning System is owned and operated by the United States government. The GPS system was originally developed for military applications, but now is available to anyone worldwide.

At least 24 GPS satellites are orbiting the earth at all times. These GPS satellites transmit signals to receivers on the ground. A clear view of four satellites is required for the receiver to find positions of latitude, longitude and altitude.

Average GPS receivers are accurate to within 15 meters. The newest receivers are equipped with a Wide Area Augmentations System (WAAS) that allows for accuracies up to 3 meters.

Not all GPS receivers are the same; the receiver described here will be the Garmin etrex Legend. If a different receiver unit is supplied the instructor will provide directions for the specific unit, or the instructions may be found on the manufacturer's web site on the World Wide Web.

It is important that the settings on the GPS receiver are the same for all employees of the Kennedy Forestry Corporation. The first setting of importance is the Map Datum. A datum is a mathematical model used to describe positions on the Earth. All maps are created by starting with the locations of some (usually three) known points. The locations of all other points on the map are given in reference to these known points. The known positions are the information that the map datum is based. Many United States Topographic maps are based on the North American Datum of 1927 (NAD27).

The most commonly used datum is WGS 84, (World Geodetic Survey 1984). This datum is based on the center of the Earth as the reference point to base all measurements. WGS 84 was accepted as the standard after the completion of the North American Datum of 1983. WGS 84 map datum is the new standard to make paper maps and other geographical resources. The NAD83 and WGS84 datum are virtually the same. The WGS84 datum and NAD27 datum can vary by up to 200 meters.

- Set the positions format of the GPS receiver to Universal Transverse Mercator (UTM) This format is the easiest to use in spreadsheets programs, and can be easily converted to different formats such as hours and decimal minutes (hddd^omm.mmm'), decimal hours (hddd.dddd^o) or hours minutes and seconds (hddd^omm'ss.s").
- Set the distance and vertical speed options to the metric base unit of meters.

GPS receivers are used to find an exact location on earth with a very high degree of accuracy. In the UTM/UPS positions format locations are given in

terms of zone, easting and northing coordinates. Other position formats provide data in terms of latitude, longitude, and altitude measurements.

Figure 1 is an example of a GPS receiver showing the UTM coordinates and altitude of a highly reproducible location (lane 1 finish line of the track behind Kennedy High School).

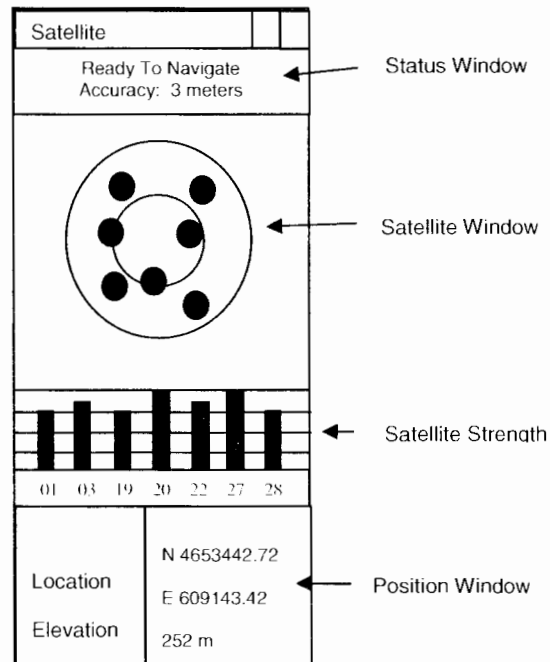

Figure 1

Using a GPS Receiver

1. Go to a reproducible outdoor location that has an unobstructed view of the sky.
2. Turn on the GPS receiver hold it parallel to the ground at arms length in front of your body.
3. After an introduction message, the receiver will start to search for satellites.
4. Wait for the receiver to indicate at least four satellites have been acquired and a good measurement is available. In many receivers this is noted by a measurement accuracy message.
5. Check the system and units settings of the GPS. Change any necessary settings to the correct format of UTM/UPS.
6. At one-minute intervals without moving the GPS make three readings of the following information.

Description of Reproducible Location =				
	Reading #1	Reading #2	Reading #3	Average
Time				
Zone				
Easting				
Northing				
Elevation				
Degree of accuracy				
Number of tracked satellites				
Number of WAAS satellites				

7. Average the three easting, northing, and elevation readings.
8. Follow the same techniques for every GPS measurement you make.

If the location of the position does not have a clear view of the sky a GPS offset location must be used. Locating an area using GPS offsets will be discussed later in this training.

GPS Receiver Practice

Your instructor will provide you with a lists of three permanent, reproducible locations. Use the GPS receiver unit to find the UTM coordinates of these locations.

Description of Reproducible Location =				
	Reading #1	Reading #2	Reading #3	Average
Time				
Zone				
Easting				
Northing				
Elevation				
Degree of accuracy				
Number of tracked satellites				
Number of WAAS satellites				

Description of Reproducible Location =				
	Reading #1	Reading #2	Reading #3	Average
Time				
Zone				
Easting				
Northing				
Elevation				
Degree of accuracy				
Number of tracked satellites				
Number of WAAS satellites				

Description of Reproducible Location =				
	Reading #1	Reading #2	Reading #3	Average
Time				
Zone				
Easting				
Northing				
Elevation				
Degree of accuracy				
Number of tracked satellites				
Number of WAAS satellites				

Compare your results to the results from another group.
Are there any differences in your data?

What are the possible reasons for the differences?

Check your answers with the instructors. When the instructor approves your answers you may move onto the next exercise.

Using Measured Pacing to Find Distance

A technique required to measure long distances is measured pacing. Using pacing to measure distance is one of the oldest measuring techniques known to man. The ancient Romans used this technique, and our own current distance system is based on its use. The ancient Roman mile was 1000 one foot paces.

Pacing can involve either a one-foot or two-foot pacing technique. The preferred method by many is to use one-foot pacing because it involves less counting. The one foot pacing method defines one pace as each time the same foot strikes the ground. If the first pace is made by stepping with your left foot, one pace is when the right foot strikes the ground. It is helpful to be consistent by using the same foot as the starting foot each time.

To measure your pace:

1. Measure out a known distance in meters with a metal tape measure. Mark the starting and ending points of the distance.
2. From the starting point count the number of one-foot paces it takes to get to the ending point. Use a pace that is comfortable and always start with the same foot.
3. Record the number of paces needed to cover the distance in the table provided.
4. Repeat the procedure 5 times and record the values in the table provided.
5. Divide the number of paces by the distance covered.
6. Divide the distance covered by the number of paces.
7. Find the average of the number of paces per distance.
8. Find the average of the distance per pace

Trial #	# of paces	Distance (meters) (m)	(# of paces)/(Distance) (paces/m)	Distance/# of paces (m/pace)
1				
2				
3				
4				
5				
Average				

Record the average pace distance for the other members of your group.

Name	Average pace Length

Factor Dimensional Analysis

You now have two valuable conversions that can be used to measure distances by pacing (paces/m and m/pace). The recommended way to make the conversions is factor dimensional analysis. Factor dimensional analysis uses fractions that are equal to one. For example 24 hours in one day can be expressed as $24 \text{ hours} / 1 \text{ day} = 1$ and $1 \text{ day} / 24 \text{ hours} = 1$.

How many hours are in six days is expressed as:

$$6 \text{ days} * 24 \text{ hours}/1 \text{ day} = 144 \text{ hours}$$

Use the two following examples as a model to figure distance from paces, or number of paces from distance.

Example 1: How far have you traveled if your average pace distance is 2.23 meters after you have paced 13 paces?

$$13 \text{ paces} * 2.23 \text{ meters}/1 \text{ pace} = 29 \text{ meters}$$

Example 2: How many paces will it take you to cover 35 meters if your average pace length is 2.23 meters?

$$35 \text{ meters} * 1 \text{ pace} / 2.23 \text{ meters} = 15.7 \text{ paces}$$

Complete the following conversions using an average pace distance of 2.23 meters.

$$17 \text{ paces} = \underline{\hspace{2cm}} \text{ meters}$$

$$24 \text{ paces} = \underline{\hspace{2cm}} \text{ meters}$$

$$9 \text{ paces} = \underline{\hspace{2cm}} \text{ meters}$$

$$31 \text{ meters} = \underline{\hspace{2cm}} \text{ paces}$$

$$54 \text{ meters} = \underline{\hspace{2cm}} \text{ paces}$$

$$16 \text{ paces} = \underline{\hspace{2cm}} \text{ meters}$$

Using a Compass

A GPS receiver with a clear view of the sky can be used to make an accurate map of an area. In a forested area a clear view of the sky is rare. Measured pacing and reading a compass are useful skills for making maps when GPS signals are unavailable.

A compass is a simple device which consists of a small piece of metal balanced on a nearly frictionless pivot. The small piece of metal is magnetic and always points to the earth's magnetic pole.

The earth's magnetic pole is not the same as the true North Pole. The true North Pole is at the very top of the planet. The magnetic north pole is slightly different because of a large underground mass of metal located in northern Canada. For the mapping purposes of this research, true north will be used as a reference. It is important that the compass is held away from metal objects such as belt buckles or keys because the magnetic needle is sensitive to metal.

An orienteering compass consists of a dial labeled with degree measurements, a base plate, and a magnetic needle. This type of compass is the type of compass used by the Kennedy Forestry Corporation for research. The base plate consists of a sighting arrow and an orienteering arrow.

Remember that the magnetic pointer always points toward the magnetic poles. The red half of the arrow points toward the north. It is always a good idea to double check an unfamiliar compass to be sure the red arrow points to the north. An easy way to remember the red half point to the north is put the "red in the shed".

The graduated markings on the dial of the compass represent degree measurements. Zero degrees represents North, 90° represents East, 180° represents south, and 270° represents West.

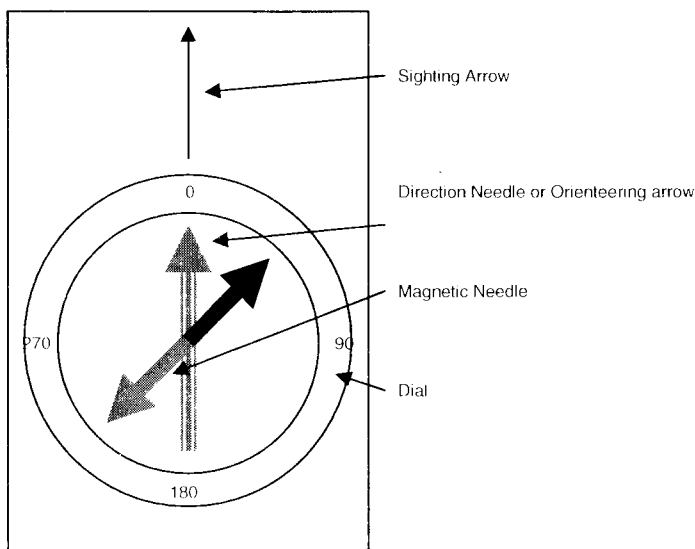

Take the compass outside and hold it parallel to the ground in front of you. The magnetic needle will point toward magnetic north. An easy way to remember which part of the arrow is pointing north is the phrase "Keep the red in the shed." If the black part of the needle is used all of the directions will be backwards.

Reading the Compass

- Turn the dial on your compass so that 0° is aligned with the sighting arrow.
- Hold the compass parallel to the ground with the sighting arrow pointing away from you. The compass should be held horizontally to prevent the needle of the compass from rubbing against the bottom or the top of the base plate.
- Look down at the compass to see where the magnetic arrow is pointing.
- Turn your body and notice that the magnetic arrow continues to point toward the magnetic north pole, no matter what direction you are facing.
- Turn your body so the magnetic arrow point directly to the right as shown in the diagram below.

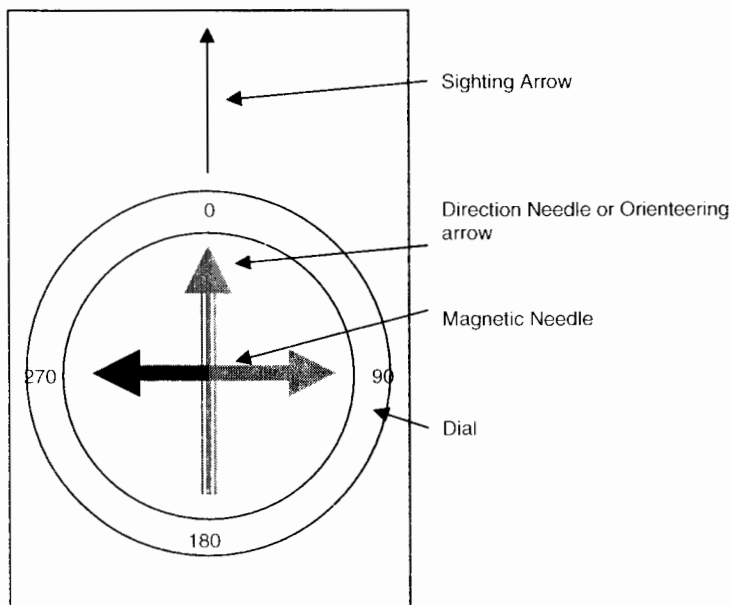

The magnetic arrow still points to the magnetic North Pole, your direction of travel is to the west. Turn the graduated dial on the compass until the Orienteering arrow is aligned with the magnetic needle to find your true bearing.

The diagram below shows the compass with the orienteering arrow matching the magnetic needle and shows the true direction of travel. The current direction of travel is 270° , or West.

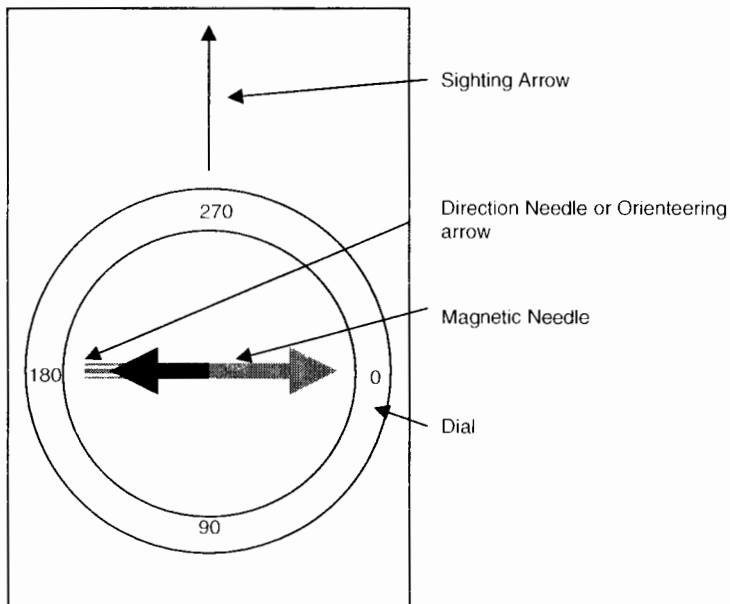

What is the direction of travel in the following example?

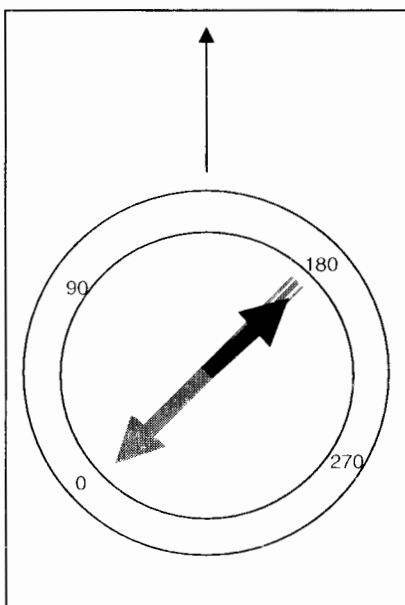

Taking a Bearing or Heading measurement

Bearing and heading measurements are basically the same thing. They indicate the direction of travel needed to get to a different location. The markings on the graduated dial represent the degrees of a circle that surround you at all times. These markings are used to find the bearing or heading to a distant object.

Take a bearing measurement by following the following steps:

1. Use the proper techniques for holding the compass.
2. Aim the line of travel arrow at the object.
3. Keep the "red in the shed".
4. Read the bearing at the direction of travel arrow.

It is a good idea to take a bearing measurement to the location in which the bearing is found (forward bearing) as well as a bearing measurement from which the object to be found (backward bearing).

The instructor will provide two reproducible locations (Points A & B), and three reproducible objects (Objects 1, 2 & 3), to practice taking bearing measurements. All locations and objects should be within 50 m of each other.

Point A _____

Point B _____

Object 1 _____

Object 2 _____

Object 3 _____

Forward Bearing from Point A to Point B			
Backward Bearing from Point B to Point A			
Bearing from A to	Obj. 1)	Obj. 2)	Obj. 3)
Bearing from B to	Obj. 1)	Obj. 2)	Obj. 3)

Compare the bearing measurements in the table with the accepted values for the bearing measurements made by the instructor. If any of the values do not agree, the bearing measurements must be made again. Repeat this activity until all of the measurements are in agreement.

Combining Measuring by Pace and Bearing Measurements to Make a Map

A map of the area can be made by combining the bearing measurements with distance measurements. Bearings have already been taken for Points A & B, and Objects 1,2, and 3. The distance measurements for each of these now can be found.

Use measured pacing and the length of an average pace to complete the following.

Length of average pace = _____

Distance in paces from Point A to B = _____

Distance in paces from Point A to: Obj. 1 = _____

Obj. 2 = _____

Obj. 3 = _____

Distance in meters from Point A to B = _____

Distance in meters from Point A to: Obj. 1 = _____

Obj. 2 = _____

Obj. 3 = _____

In the space below make a simple sketch of the locations and distances of each of the five objects. Include the following items in the sketch; an arrow showing North, and the objects surveyed.

Mapping the Area.

Combine the bearing, and distance data to the table below.

Distance From Point A to Point B in meters			
Foresight bearing to Point B			
Backsight bearing to Point A			
Bearing from Point A to	Obj. 1	Obj. 2	Obj. 3
Bearing from Point B to	Obj. 1	Obj. 2	Obj. 3

Get enough 1.0 cm graph paper from the instructor to draw the map. Several pieces may be needed to be taped together depending on the size of the area. A 360° protractor, ruler and straight edge will also be needed. Each person is responsible for completing their own map.

1. Draw an arrow indicating North is the top of the page.
2. The scale for the map is 1.0 cm = 1.0 meter, or 1:100.
3. Convert all of the distances to scale.
4. Use the sketch of the area to determine where the best place to start the map will be on the piece of graph paper. Select an area that will ensure the map fits on the graph paper.
5. Draw the baseline of the map between Points A and B using the correct scaled length of line. Label this distance on your map.
6. Distance from Point A to Point B in m _____ in cm _____.
7. Objects one, two, and three can now be placed on the map by triangulation.
8. Place the center of the protractor on Point A with zero degrees pointing north. The degree measurements on the protractor correspond with the degree measurements on the compass. Make a light mark on the map at each bearing point from Point A.
9. After all three bearings are marked use a straight edge to draw a light line from Point A to each of the marks.
10. Place the center of the protractor on Point B with zero degrees pointing north. The degree measurements on the protractor correspond with the degree measurements on the compass. Make a light mark on the map at each bearing point from Point B.
11. After all three bearings are marked use a straight edge to draw a light line from Point B to each of the marks.

12. Each object is placed at the intersections of the lines from Points A and B.
Mark each location in Pirate fashion with a small X.
13. Determine the distances from Point A to objects one, two, and three.
Label these distances on your map.
 - a. Point A to object 1 in cm _____ in meters _____.
 - b. Point A to object 2 in cm _____ in meters _____.
 - c. Point A to object 3 in cm _____ in meters _____.
14. Determine the distances from Point A to objects one, two, and three.
Label these distances on your map.
 - a. Point B to object 1 in cm _____ in meters _____.
 - b. Point B to object 2 in cm _____ in meters _____.
 - c. Point B to object 3 in cm _____ in meters _____.
15. Include the following on your map:
 - a. Scale
 - b. Title
 - c. Group members
 - d. UTM zone and coordinates
16. Compare the map with the instructors map. If your map is improved by the instructor you may move on to the next training module.

Finding location when GPS signal is not available.

GPS alone is not always the best tool to find exact position. When a clear overhead view of the sky is unavailable, like in a wooded area, a GPS reading from a position that has a clear view of the sky can be used as a starting point. The unknown position can be found by compass and pacing.

Procedure

1. Go to the point of the unknown location.
2. Attempt to find latitude, longitude and altitude information using the GPS receiver.

If a strong signal can be obtained with the GPS receiver clearly mark the location, and record the coordinates. If a strong signal cannot be obtained with the GPS receiver clearly mark the location and proceed using the following instructions.

3. Go to a permanent reproducible location where the GPS signal is strong and the mark the location so it can be easily seen.
4. Use the GPS unit to find the easting, northing and altitude position of the location that has good GPS reception.
 - a. Zone
 - b. Easting
 - c. Northing
 - d. Altitude
5. Use the compass to determine a bearing to the clearly marked unknown location.
 - a. Forward Bearing
6. Use pacing to determine the distance to the unknown location.
 - a. Number of paces
 - b. Distance of each pace in meters
 - c. Total distance in meters

Adjustment of Easting Position

1. Take a bearing measurement from the location in which a strong GPS signal can be received to the point of the unknown location.
2. Count number of paces from the known location (where the bearing measurement was taken from) to the unknown location (where a strong GPS signal could not be obtained). Convert the number of paces to a distance in meters.

The easting coordinate of the unknown area can be computed using trigonometry.

1. Multiply the sine of the bearing angle and the distance in meters to the unknown location.
2. Add this number to the Easting coordinate of the known location.

Adjustment of the Northing Position

The bearing measurement of the unknown location is also used to calculate the adjustment of the northing coordinate.

1. Multiply the cosine of the bearing angle and the distance in meters to the unknown location.
2. Add this number to the Northing coordinate of the known location.

Finding location when a GPS signal is not available.

The following example shows the process using real data.

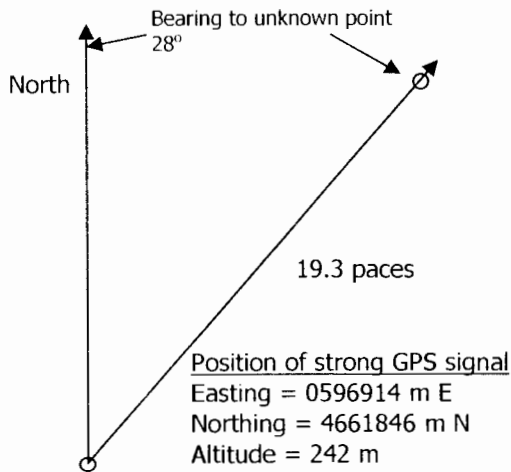

Procedure

1. Go to the point of the unknown location.
2. Attempt to find latitude, longitude and altitude information using the GPS receiver.

If a strong signal can be obtained with the GPS receiver mark the location, and record the coordinates. If a strong signal cannot be obtained with the GPS receiver clearly mark the location and proceed using the following instructions.

3. Go to a permanent reproducible location where the GPS signal is strong and the mark the location so it can be easily seen.
4. Use the GPS unit to find the easting, northing and altitude position of the location that has good GPS reception.
 - d. Zone (T15)
 - e. Easting (0596914 m E)
 - f. Northing (4661846 m N)
 - g. Altitude (242 m)
5. Use the compass to determine a bearing to the clearly marked unknown location.
 - h. Forward Bearing (28°)
6. Pacing is used to determine the distance to the unknown location.
 - i. Number of paces (19.3 paces)
 - j. Distance of each pace in meters (2.33 m/pace)
 - k. Total distance in meters (19.3 paces * 2.33 m/pace = 45 m)

Adjustment of Easting Position

The easting coordinate of the unknown area is computed using trigonometry.

3. Multiply the sine of the bearing angle and the distance in meters to the unknown location.
 - a. $\text{Sine } 28^\circ = 0.46947$
 - b. Distance in meters in the easterly direction = $0.46947 * 45 \text{ m}$
 - c. Distance in meters in the easterly direction = 21 m
4. Add this number to the Easting coordinate of the known location.
 - a. Northing coordinate of the unknown area = $0596914 \text{ m E} + 21 \text{ m} = 0596935 \text{ m E}$

Adjustment of the Northing Position

The bearing measurement of the unknown location is also used to calculate the adjustment of the northing coordinate.

5. Multiply the cosine of the bearing angle and the distance in meters to the unknown location.
 - a. $\text{Cosine } 28^\circ = 0.88295$
 - b. Distance in meters in the northerly direction = $0.88295 * 45 \text{ m}$
 - c. Distance in meters in the northerly direction = 40 m
6. Add this number to the Northing coordinate of the known location.
 - d. Northing coordinate of the unknown location = $4661846 \text{ m N} + 40 \text{ m} = 4661886 \text{ m N}$

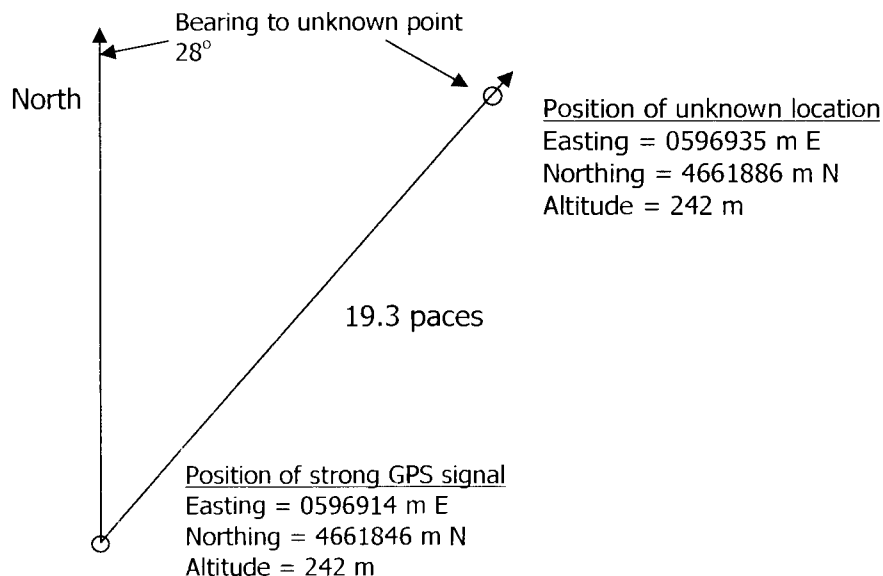

Finding location when GPS signal is not available Worksheet

7. Use the GPS unit to find the UTM zone, easting, northing and altitude of the position of the location that has good GPS reception.
 - a. UTM zone _____
 - b. Easting _____
 - c. Northing _____
 - d. Altitude _____
8. Use the compass to determine a bearing to the clearly marked unknown location.
 - a. Forward Bearing _____
9. Use pacing to determine the distance to the unknown location.
 - a. Number of paces _____
 - b. Distance of each pace in meters _____
 - c. Total distance in meters _____

Easting Adjustment

10. Find the easting component of the length found by pacing and the bearing measurements.
 - a. (Sine θ _____) x _____ m = _____ m
11. Add the easting component (4a) to the distance in meters of the known easting location(1b).
 - a. _____ m + _____ m = _____ m E total.

Northing Adjustment

12. Find the northing component of the length found by pacing and the bearing measurements.
 - a. (Cosine θ _____) x _____ m = _____ m
13. Add the northing component (6a) to the distance in meters from the equator (1c).
 - a. _____ m + _____ m = _____ m N total

Tree Identification Terms

Alternate	Arranged singly along a twig or shoot, and not in whorls or opposite pairs.
Axis	The central stalk of a compound leaf or flower cluster.
Bark	The outer covering of the trunk and branches of a tree, usually corky, papery, and leathery.
Bipinnate	Leaflets arranged on side branches off of a main axis; twice pinnate, bipinnately compound
Blade	The broad flat part of a leaf.
Bud	A young and undeveloped leaf, flower, or shoot, usually covered tightly with scales.
Compound leaf	A leaf whose blade is divided into 3 or more smaller leaflets.
Cone	A conical fruit consisting of seedbearing, overlapping scales around a central axis.
Cone-scale	One of the scales of a cone.
Conifer	A cone bearing tree of the Pine family, usually evergreen.
Deciduous	Shedding leaves seasonally
Elliptical	Elongated oval, about twice as long as wide, and broadest on the middle; like an ellipse.
End bud (twig)	True end bud or sometimes several, clustered, located at the precise end of the twig. False end buds occurs in some species when the end bud is shed and a nearby side bud acts as end bud.
Entire	Smooth edged, not lobed or toothed.
Fleshy fruit	A fruit with juicy or mealy pulp.
Four lined	With 4 more or less equidistant lines running lengthwise along a twig.
Fruit	The mature, fully developed ovary of a flower, containing 1 or more seeds.
Lanceolate	Shaped like a lance, several times longer than wide, pointed at the tip and broadest near the base.
Lateral (bud)	To the side rather than at the end of twig or branchlet.
Leaf scar	The mark left on the twig at the point of attachment of a leaf stalk when the leaf falls.
Leaflet	One of the leaflike subdivisions of a compound leaf.
Linear	Long narrow and parallel sided.
Lobed	With the edge of the leaf deeply but not completely divided.
Midvein	The prominent, central vein or rib in the blade of a leaf; midrib.
Needle	The very long and narrow leaf of pines and related trees.
Oblong	Nearly parallel edges
Opposite	Arranged along a twig or shoot in pairs, with 1 on each side, and not alternate or in whorls.
Palmate	Leaflets attached directly to the end of the leafstalk and not alternate or in whorls.
Palmate-veined	Principal veins arise from the end of the leaf stalk and radiating toward the edge of the leaf, and not branching from a single midvein.
Parallel veined	Veins run more or less parallel toward the tip of the leaf.

Tree Identification Terms

Pinnate	With leaflets arranged in two rows along an axis; pinnately compound
Pinnate-veined	Principal vein branching from a single midvein, and not arising from the end of the leafstalk and radiating toward the edge of the leaf.
Pith	The spongy or hollow center of twig or some stems.
Scale	One of the very short, pointed and overlapping leaves of some conifers.
Simple Leaf	Only a single blade, joined by a stalk to a twig that is woody.
Toothed	An edge finely divided into short, toothlike projections.
Tree	Woody plant at least 4 meters tall with a single trunk at least 8 centimeters in diameter at a height of 150 centimeters.
Vein	One of the riblike vessels in the blade of a leaf.
Whorled	Arranged along a twig or shoot in groups of three or more at each node.
Wing	A thin, flat, dry shelflike projection on a fruit or seed, or along the side of a twig.

Leaf Types

Scales



Needles in Cluster



Needles in Bundle



Linear



Oblong

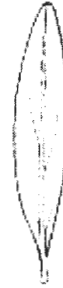

Lanceolate



Oblanceolate



Spatulate



Obovate



Ovate



Rounded



Cordate

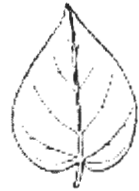

Elliptical



Pinnately

Lobed

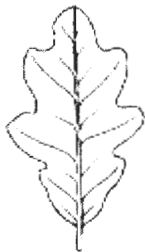

Palmately

Lobed



Palmately

Compound

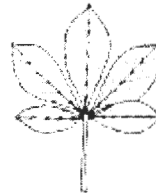

Pinnately

Compound



Bipinnately

Compound



Simple Leaf Blade

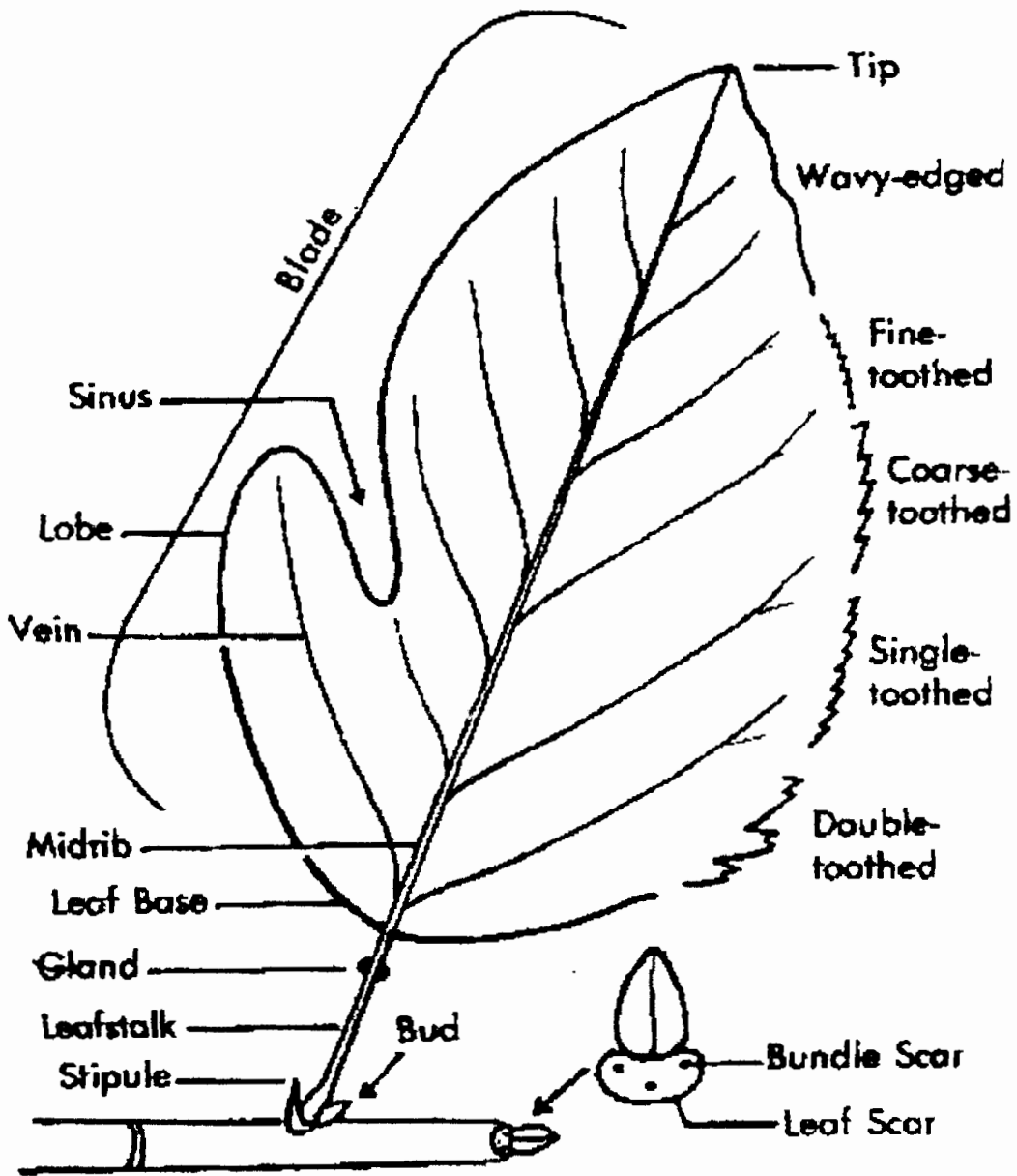

Compound Leaf and Twig

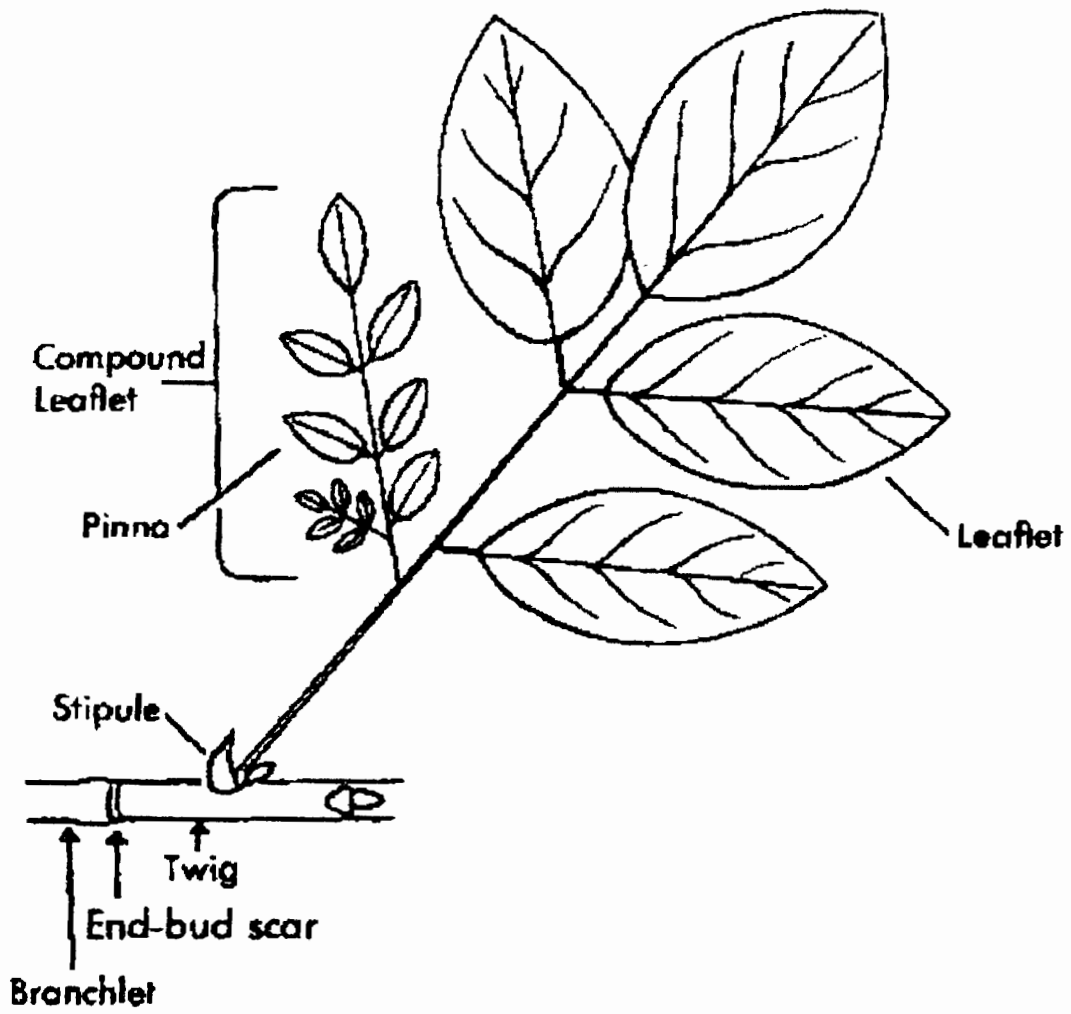

Types of Leaf Growth

Needles and Scale Like Leaves

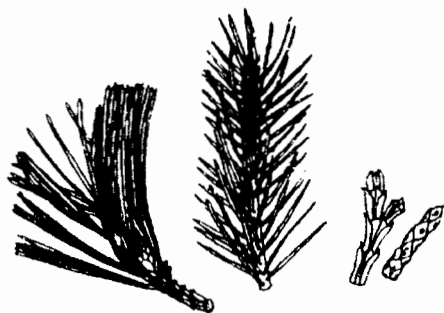

Opposite Compound Leaves

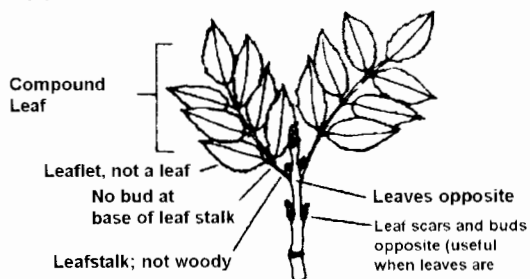

Alternate Compound Leaves

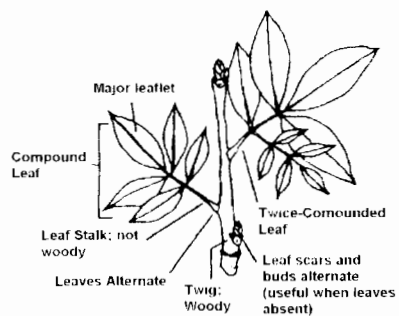

Alternate Simple Leaves

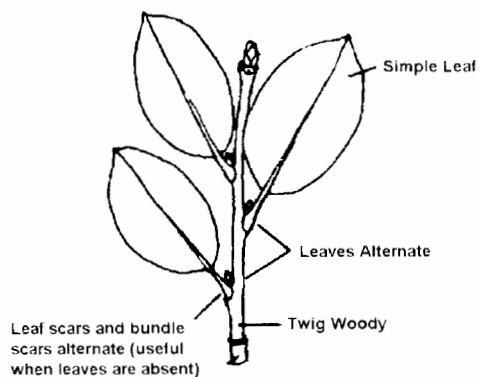

Opposite Simple Leaves

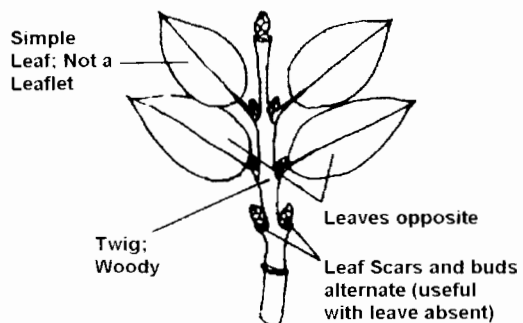

Using a Dichotomous Key

Identifying trees by species is another important part of data collection for the Kennedy Forestry Corporation. One of the most effective way to identify trees is by using a dichotomous key. Tree identification manuals vary in the order the keys are arranged, but they all operate the same way.

A dichotomous key is a valuable tool used in identification. A dichotomous key offers a choice of two possible descriptions of an item. A decision is made by the user of the choice that best describes the item. A set of instructions or the identity of the item is listed after the choice. The users continues until the item is identified.

The key consists of a set of numbered lines, two or more choices, and directions. The characteristics of the plant are matched with the choice that best describes it, and the instructions are followed.

The following dichotomous key can be used to identify the coins in a pocket full of change.

- 1A. Silver colored go to 2
- 1B. Not silver colored go to 4
 - 2A. Rough edges go to 3
 - 2B. Smooth edges = Nickel
 - 3A. Picture of Eagle on back = Quarter
 - 3B. No picture of Eagle on back = Dime
 - 4A. Picture of Lincoln printed on front = Penny
 - 4B. No picture of Lincoln = Dollar coin

This example is rather simple. To be able to identify tree species, a long list of choices will need to be examined. Included in this training manual are a list of terms used to describe plant growth, illustrations showing types of plant growth, and leaf shape. The chosen field guide will also have these terms and illustrations, but it will be helpful to familiarize yourself with them before you go into the field.

It is necessary to use the Latin name of each species of tree that is identified. The dichotomous key must be used to identify each tree species. If you know the difference between a Red Oak and a White Oak is that the Red Oak has pointed leaves, while the White Oak has rounded leaves, you should realize that there are 11 species of Oak Trees that have pointed leaves.

If you are having difficulty positively identifying a tree in the field it may be helpful to take a picture of one of the branches, and collect leaf and fruit samples to be examined later in the lab. These samples should be clearly labeled to aid in later identification.

Collecting Tree Data

- Find the tree you are going to identify on your map and locate it's number on the data collection sheet.
- Note whether your tree is on flat land(F), a hilltop (H), on a slope (S), or bottom (B) of a hill. The location of a tree on a slope will have an affect on its growth rate.
- By observing the characteristics of the tree and using the dichotomous keys identify each tree by its genus and species name on your data collection sheet.
- Collect any leaf and/or fruit samples and place them in a plastic bag labeled with the tree number.
- If a camera is available take a picture of a representative branch of the tree. Record the photo number on the data sheet.
- Measure the circumference of each tree at a height of 1.5 m above the ground and record the data on the data collection sheet.

Data Collection Table

Tree #
Slope (F)lat (S)lope (B)ottom (H)illtop
Circumference (m)
Species
Core Sample (years)
Photograph #
Notes

Extracting Core Samples Using an Increment Borer

An increment borer is a hollow auger-like instrument that is used for taking a core from a tree to study the annual growth rings and find the age of a tree.

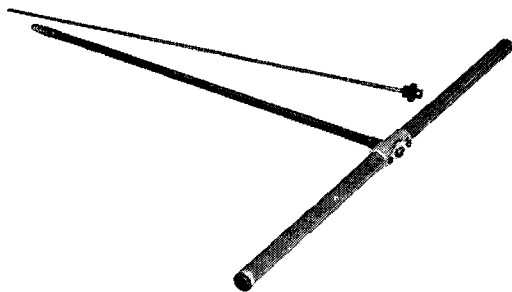

The increment borer has three parts.
 (1) The handle – the thick rod in the picture.
 (2) The auger – which is a hardened steel tube with a cutting tip at one end. In the picture above it is connected to the handle.
 (3) The extractor – A metal rod which slides into the auger to remove the core.

Using the increment borer is a simple task. Using the increment borer well is very difficult. It will take a lot of practice and a little luck to get quality samples to age the trees in the study area.

- Select a tree to take a core sample from.
- Important considerations in picking out a tree.
 - Avoid areas where ring pattern may be distorted such as branches, the uphill or downhill side of a trunk.
 - The best area to bore is below the first branch on the side of the tree perpendicular to the slope.
- Pick out a place 1.3 m from the ground where a good sample can be taken. It is important that the drill is perpendicular to the trunk.
- Press the tip of the borer against the tree at a right angle, aiming at the center of the tree, and turn the handle clockwise to bore into the tree.
 - If the borer suddenly becomes hard to turn immediately stop and remove the borer. A pitch pocket has been contacted and may damage the borer.
 - If the borer suddenly becomes very easy to turn immediately stop and remove the borer. A decayed area in the tree has been contacted and may damage the borer.
- Continue to turn the borer clockwise until you have reached the center of the tree.
- Insert the extractor spoon through the handle of the borer allowing it to slide between the wood core and the metal sides of the borer.
- When the extractor is inserted the full length turn the borer 1 full turn counter clockwise to break the core loose from the tree.
- Carefully extract the core from the borer with the extractor.
- Remove the borer from the tree by turning it counter clockwise until it is removed from the tree.
- Fill the hole left by the borer with bees wax.

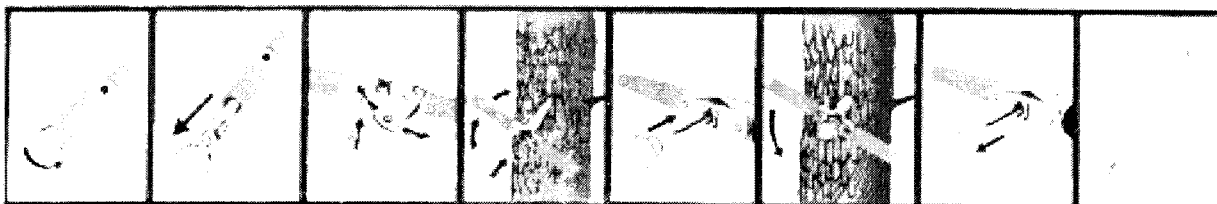

Finding Tree Age From Core Samples.

Every year a tree grows it adds new cells in the form of annual rings. The annual rings show how much wood the tree produces during that growing season. Every year a tree adds an annual ring to its diameter. Counting the number of rings tells the age of the tree.

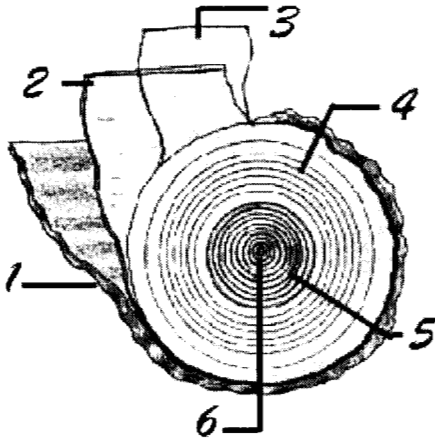

Describe the function of each of the labeled layers in the above diagram.

- 1) Bark
- 2) Phloem
- 3) Cambium
- 4) Sapwood
- 5) Heartwood

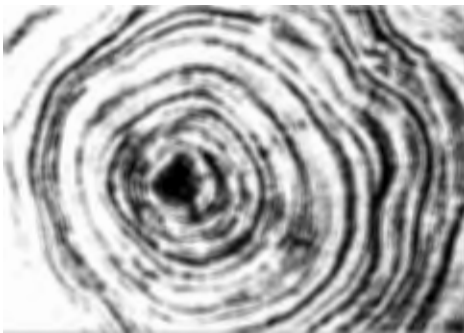

Notice in this photograph the annual rings of a tree do not form perfect concentric circles like the illustration above.

Factors Affecting Tree Growth

The rate of tree growth is affected by genetics and environmental factors. These environmental factors include the soil in which the tree is growing, available water, and available sunlight.

Research one of the factors listed above and describe how the factor affects the rate of tree growth.

What hypothesis can you make about how the factor researched affects the data collected by the Kennedy Forestry Corporation?

Data Analysis Using Graphs

Line graphs are the method of data analysis by the Kennedy Forestry Corporation. Line graphs are used to reveal data trends clearly.

A line graph compares two variables to show how the data relates or varies. Related information is shown by drawing a continuous line between all the points on the graph.

Line graphs compare two variables: one is plotted along the x-axis (horizontal) and the other along the y-axis (vertical). In the basic plots involved in this research the y-axis in the graph indicates a length measurement, while the horizontal x-axis units of time. As a result, the line graph is viewed as a time series graph. Line graphs show relationships very clearly. Line graphs also allow multiple series to be shown.

Consider the following data.

Time (days)	Height in centimeters		
	A	B	C
0	1	1.5	1
2	1.5	2	2.2
4	2.2	2.7	3.7
6	3.2	3.2	5.4
8	4.3	3.5	7
10	5.2	3.7	8.7
12	5.6	3.8	10.3

Create a graph using traditional methods with time as the independent variable in the x-axis, and height in centimeters as the dependent variable in the y-axis. Title the graph, and label each axis.

Compare the graphs with the graphs created by another group.

What differences exist between the graphs?

How are these differences explained?

Show the graph to the instructor for approval.

Creating Graphs with Microsoft Excel

The data collected in the research conducted by the Kennedy Forestry Corporation is compiled in Microsoft Excel. This spreadsheet program allows data to be sorted easily, and analyzed by the graphing functions of the program.

When the data has been entered and sorted a graph can be produced. Start by clicking on the icon for the chart wizard. The screen pictured below will appear.

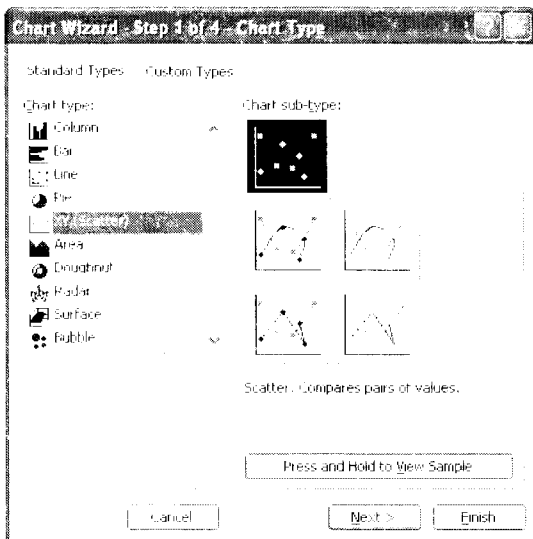

Notice the chart type selected is XY (Scatter) and the sub-type does not have any lines on the graph.

Clicking the next button will produce the following screen.

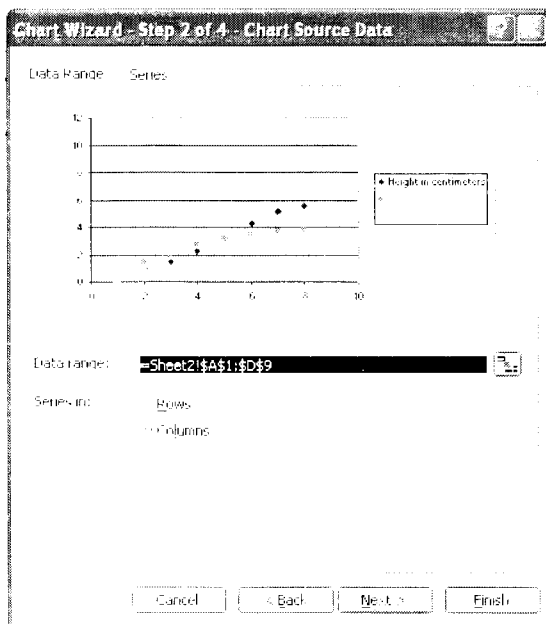

It's a graph, but not the graph needed. The appropriate graph will have the values for time as the x axis, and height for the y axis. Fix this by clicking on the series tab and deleting the series currently being used.

The chart wizard looks like this.

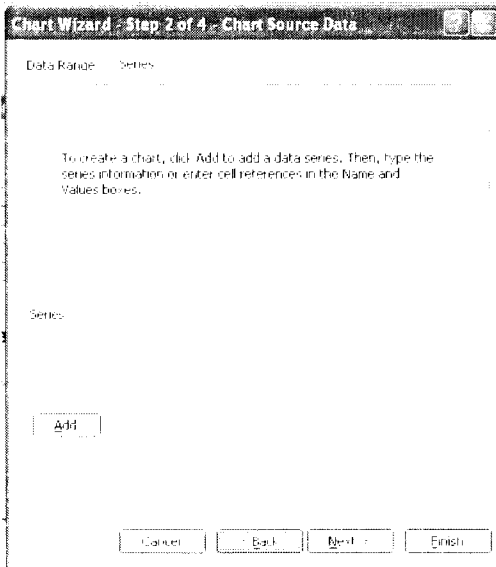

Click on the add button to insert the correct data into the graph. The information needed to create the graph are values for the x-axis, values for the y-axis, and a series name. Highlight the appropriate data on the spreadsheet to fill these blanks.

The chart wizard will look like the following.

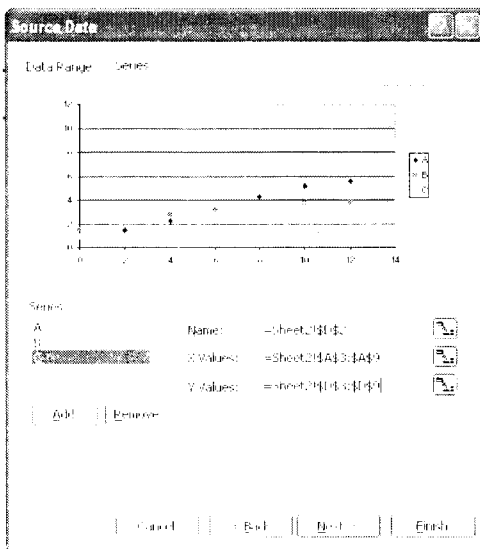

All of the necessary data has been included on the graph. Click next to continue.

Label the axis and title the graph.

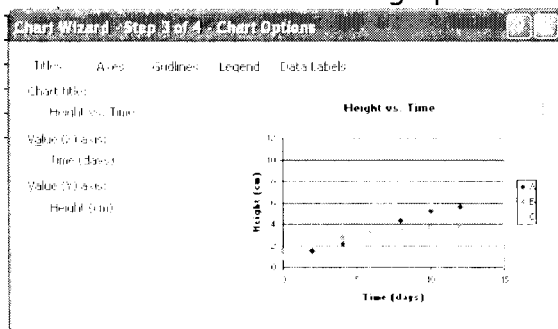

The graph is now complete and ready for data analysis. Click next to continue. Save the graph as a new sheet.

The analysis of the graphed data is done by the trendline functions of the spreadsheet.

Your completed graph should look like the following.

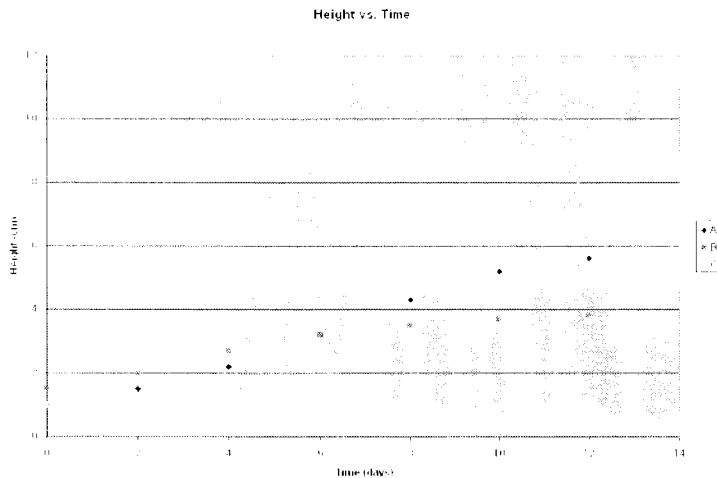

By clicking on the chart menu at the top of the page a trendline can be used to analyze the data. Clicking on the add trendline functions takes you to the following screen.

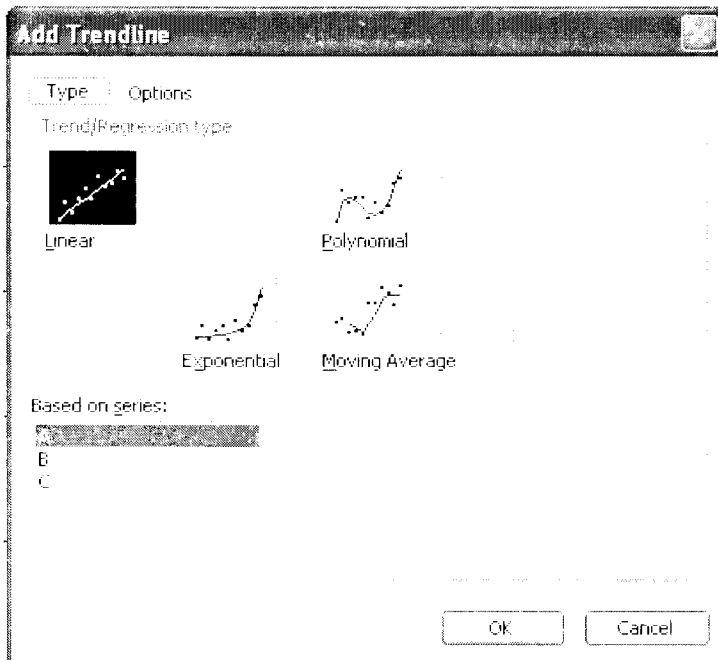

Select the type of trendline needed to best analyze the data. In this case a linear regression is used to analyze the data from series A. Click OK to continue.

The final graph with data analysis looks like this.

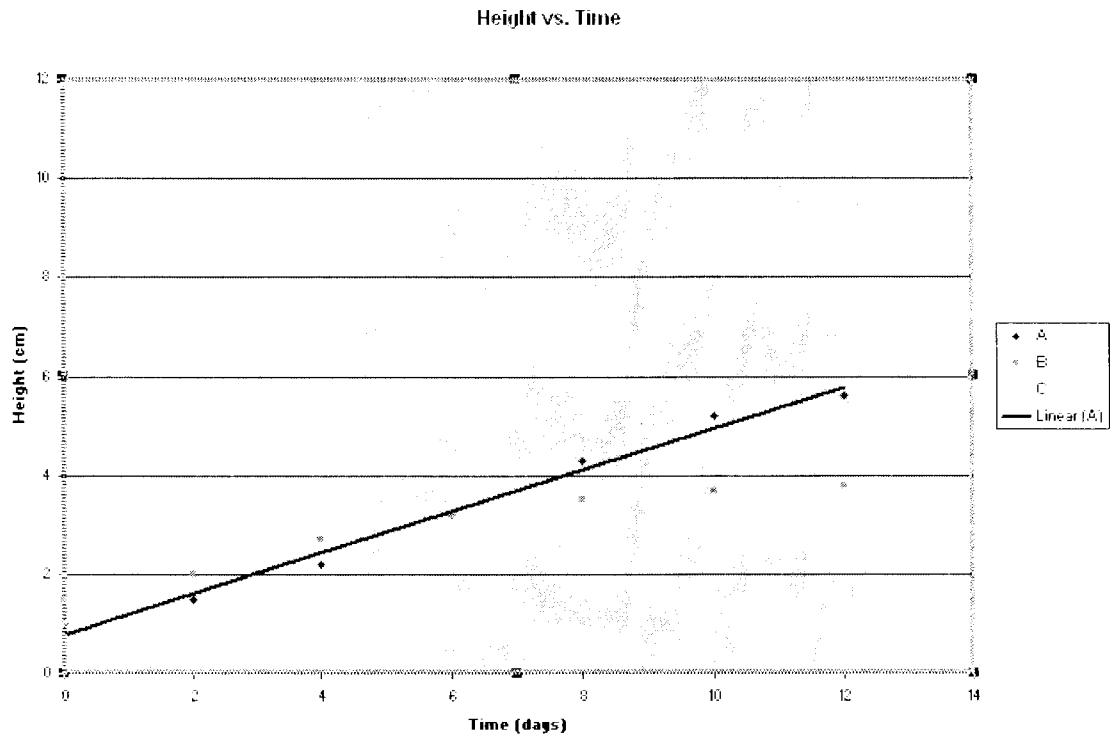

The linear regression trend line produces a line of best fit for all of the data points. The trend line produced is helpful in analyzing data.

Producing Maps Using Spreadsheet Data

The same spreadsheet program used to analyze data may also be used to produce a map of the trees in the area of study. The UTM coordinates of each corner of the study area are known. The bearing measurements from two of the corners to each tree have also been known. This data can be used by the software to draw a map.

The Law of Sines is the principle of trigonometry that this task is based. The law of sines is illustrated below.

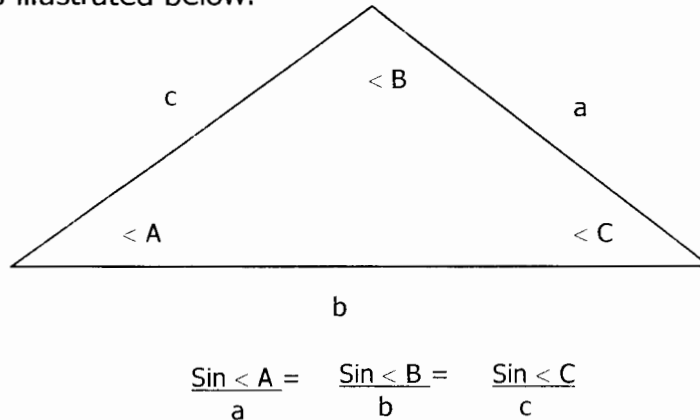

The UTM coordinates and the bearing measurements are related to the above diagram and equation as follows:

- The locations of angles A and C correspond to the two corners the bearing measurements were shot from.
- The location of angle B corresponds to the location of the tree that is to be mapped.
- The angle measurements to position B from positions A and C are the bearing measurements to the tree that will be mapped.
- The length of line b is the distance between the two corners.
 - The Pythagorean theorem is used with the UTM northing and easting components.
 - $a^2 + b^2 = c^2$
 - $(\text{easting}_1 - \text{easting}_2)^2 + (\text{northing}_1 - \text{northing}_2)^2 = c^2$
 - Length of a-b = square root of c^2 .
- The Law of Sines equation is solved for either the length of line a or c.
 - Length of side a = $(\sin \angle A / \sin \angle B) \times \text{length of side b}$; or
 - Length of side c = $(\sin \angle C / \sin \angle B) \times \text{length of side b}$
- The angle measurements are relative to absolute north.
- The formulas you create and enter into the spreadsheet are lengthy, a hand drawn graph should be produced to compare to the electronic version until you are confident all of the formulas are correct.

Trigonometry Functions

Equal Angles

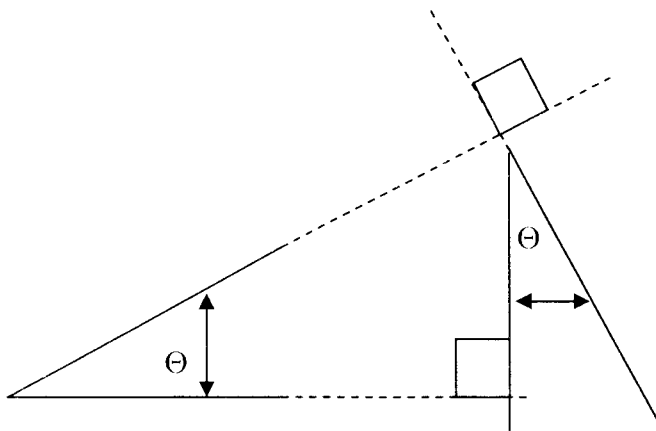
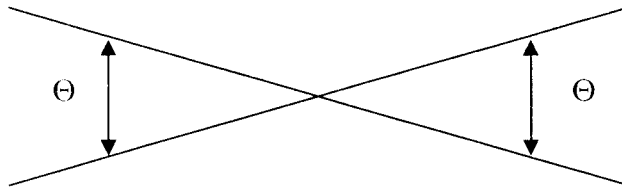

Law of Sines

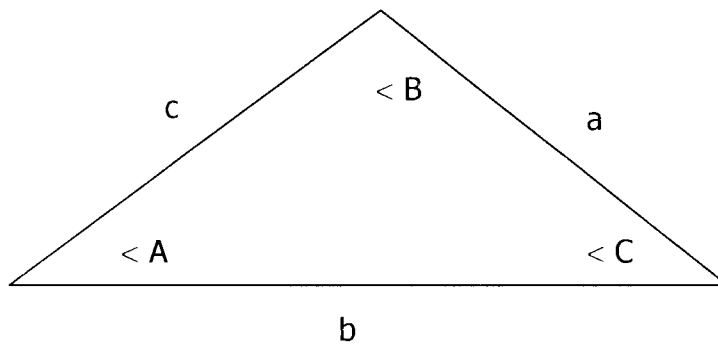

$$\frac{\sin \angle A}{a} = \frac{\sin \angle B}{b} = \frac{\sin \angle C}{c}$$

Trigonometric Functions

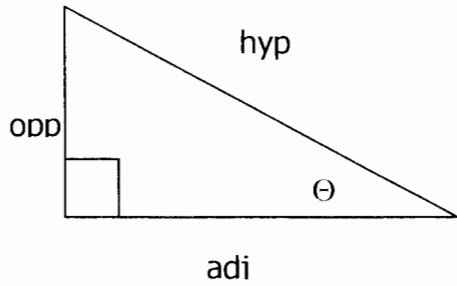

$$\sin \Theta = \text{opp} / \text{hyp}$$

$$\cos \Theta = \text{adj} / \text{hyp}$$

$$\tan \Theta = \text{opp} / \text{adj}$$

$$\text{hyp}^2 = \text{opp}^2 + \text{adj}^2$$

Compass Coordinates

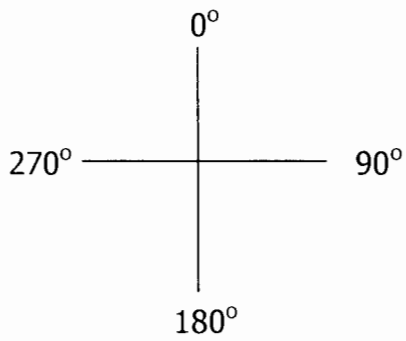

Example Problems for Mapping

1# This example uses the information above to solve for all unknowns (A,B,C,a,b,c).

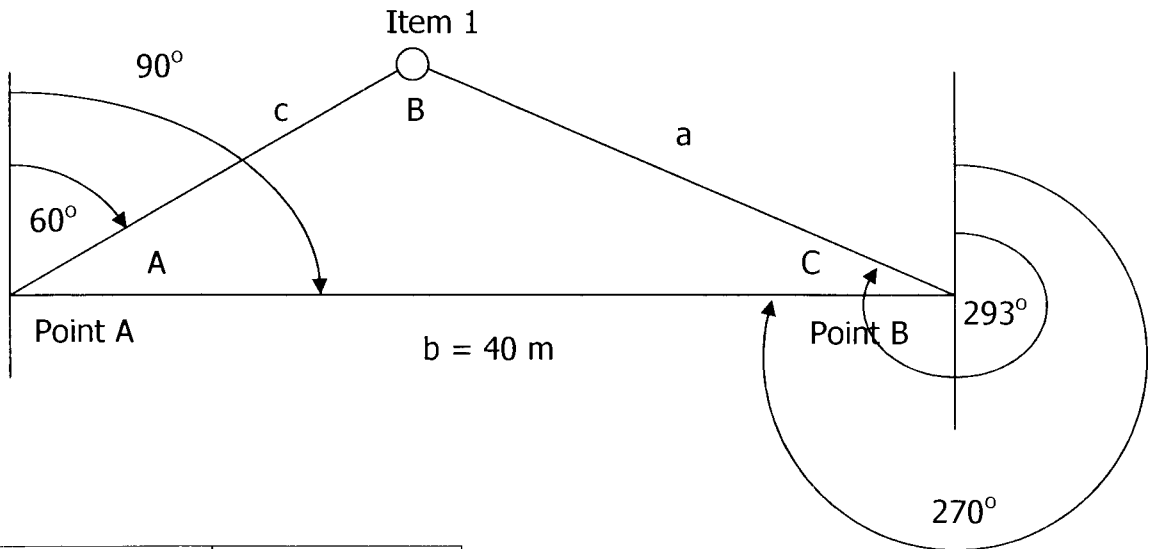

Angle A	
Angle B	
Angle C	
Length of side a	
Length of side b	40 m
Length of side c	
Horizontal component of side c	
Vertical component of side c	

To calculate $\angle A$

Bearing to Point B from Point A – Bearing to Item #1 from Point A =

To calculate $\angle C$

Bearing to Item #1 from Point B – Bearing to Point A from B =

To calculate $\angle B$

Number of degrees in a triangle - $\angle A$ - $\angle C$ =

To calculate the length of side c

$$c = l / (\sin \angle C) * h / (\sin \angle B)$$

To calculate the horizontal component of side c

Find the difference in bearing between 90 degrees and the bearing to item one. In this example it is easy because the bearing from Point A to Point B is 90 degrees. As you will see in the next two problems it is not always the case.

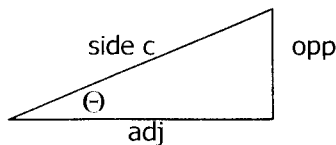

$$\text{adj} = (\cos \theta) * \text{hyp}$$

To calculate the vertical component of side c

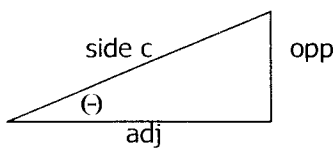

$$\text{opp} = (\sin \theta) * \text{hyp}$$

#2 Solve for all unknowns A,B,C,a,b,c.

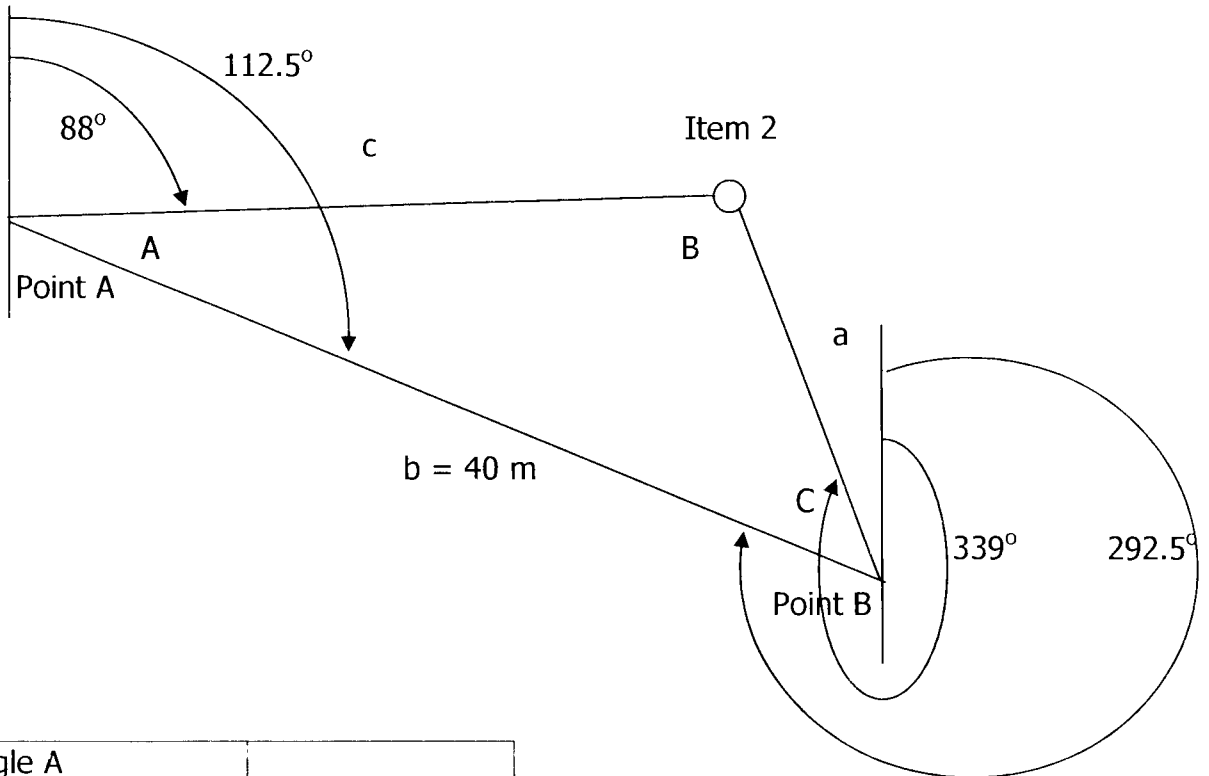

Angle A	
Angle B	
Angle C	
Length of side a	
Length of side b	40 m
Length of side c	
Horizontal component of side c	
Vertical component of side c	

3. Solve for all unknowns A,B,C,a,b,c.

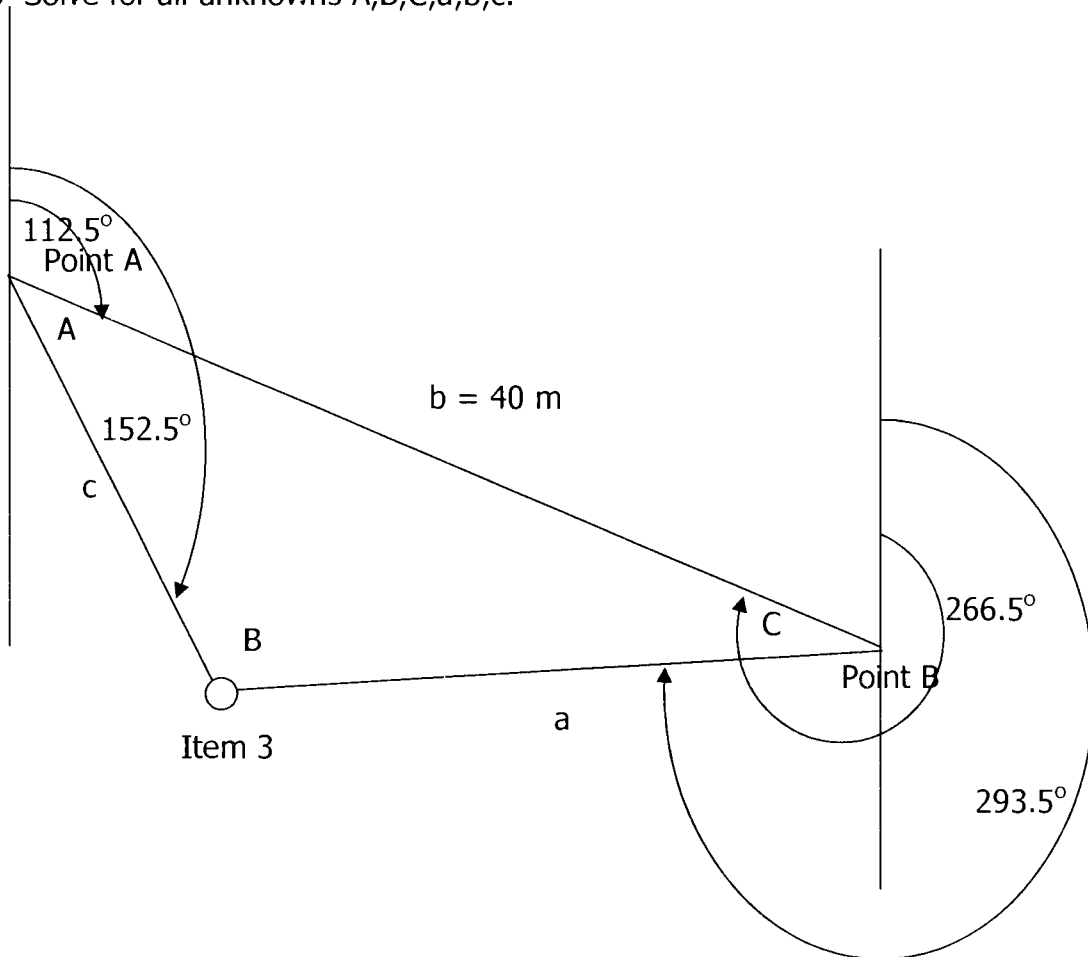

Angle A	
Angle B	
Angle C	
Length of side a	
Length of side b	40 m
Length of side c	
Horizontal component of side c	
Vertical component of side c	

