

South Dakota State University

# Open PRAIRIE: Open Public Research Access Institutional Repository and Information Exchange

---

Electronic Theses and Dissertations

---

2019

## A Study of the Effect of Heat Treatment on 3D Printed PLA Impact Strength

Suresh Thota

*South Dakota State University*

Follow this and additional works at: <https://openprairie.sdstate.edu/etd>

 Part of the [Civil and Environmental Engineering Commons](#), and the [Polymer and Organic Materials Commons](#)

---

### Recommended Citation

Thota, Suresh, "A Study of the Effect of Heat Treatment on 3D Printed PLA Impact Strength" (2019). *Electronic Theses and Dissertations*. 3395.  
<https://openprairie.sdstate.edu/etd/3395>

This Thesis - Open Access is brought to you for free and open access by Open PRAIRIE: Open Public Research Access Institutional Repository and Information Exchange. It has been accepted for inclusion in Electronic Theses and Dissertations by an authorized administrator of Open PRAIRIE: Open Public Research Access Institutional Repository and Information Exchange. For more information, please contact [michael.biondo@sdstate.edu](mailto:michael.biondo@sdstate.edu).

A STUDY OF THE EFFECT OF HEAT TREATMENT ON 3D PRINTED PLA  
IMPACT STRENGTH

BY

SURESH THOTA

A thesis submitted in the partial fulfillment of the requirements for the

Master of Science

Major in Civil Engineering

South Dakota State University

2019

A STUDY OF THE EFFECT OF HEAT TREATMENT ON 3D PRINTED PLA  
IMPACT STRENGTH

SURESH THOTA

This thesis is approved as a creditable and independent investigation by a candidate for the Master of Science in Civil and Environmental Engineering degree and is acceptable for meeting the thesis requirements for this degree. Acceptance of this thesis does not imply that the conclusions reached by the candidate are necessarily the conclusions of the major department.

Suzette Burckhard, Ph.D., PE  
Thesis Advisor

Date

Nadim Wehbe, Ph.D., PE  
Head, Department of Civil & Environmental Eng.

Date

Dean, Graduate School

Date

I dedicate this work to my parents Mr. and Mrs. Chakra Rao Thota and Suryachandra and my sibling Gowthami for their unconditional love and support throughout my education and life.

## ACKNOWLEDGEMENTS

I would like to extend my sincere thanks to **Dr. Suzette Burckhard**, my thesis advisor, for her continuous support and guidance throughout my thesis work. I feel very much blessed for getting an opportunity to work with her. I am very thankful to her for accepting me into research in 3D printing. Her support during my tough days motivated me in moving further in my work. I would be very glad to work under her guidance in the future. I would also like to thank **Dr. Todd Letcher**, my co-advisor, for his valuable time and guidance throughout my thesis work. I am very thankful to him for providing all required equipment for experimental testing.

I would like to thank my department head, **Dr. Nadim Wehbe**, for all departmental help and support and all professors who taught different courses in my Master of Civil Engineering program. I would like to thank the Department of Civil and Environmental Engineering for all the support and help.

I thank the Structural engineering Lab for all experimental thesis work. I would like to thank South Dakota State University for everything it has provided me to complete a Master of Science with a major in Civil and Environmental Engineering.

Finally, I thank my family, relatives, teachers, friends, and everyone who directly or indirectly helped me reach this stage of my life. I was able to pursue this degree with the aid of them. It wouldn't have been possible without their help.

## CONTENTS

ABBREVIATIONS .....	vii
LIST OF FIGURES .....	ix
LIST OF TABLES .....	xi
ABSTRACT .....	xiii
Chapter 1: Introduction .....	1
1.1 Overview of Thesis .....	3
Chapter 2: Literature Review .....	4
2.1 3D Printing .....	4
2.2 Fused Deposition Modeling (FDM) .....	4
2.3 3D Printing in Civil Engineering .....	5
2.4 Polylactic Acid .....	5
2.5 Effect of Heat Treatment on Mechanical Properties of PLA .....	6
Chapter 3: Methodology and Materials .....	8
3.1 Design of Impact Testing Model .....	8
3.2 PLA Filament .....	11
3.3 Print Settings .....	12
3.4 Impact Testing Parameters .....	12
3.5 Properties of PLA .....	14
3.6 Experiments .....	15

3.6.1 100% Humidity Test Series .....	16
3.6.2 Non-Vacuum Oven Test Series .....	19
3.6.3 Heating and Aging Effect on Impact Strength of PLA .....	20
3.7 Quality Control.....	20
Chapter 4: Research Results .....	21
4.1 Non Heat Treatment Test .....	21
4.2 100% Humidity Test .....	23
4.3 Non- Vacuum Oven Test.....	29
4.4 Heating and Aging Effect on Impact Strength of PLA .....	34
Chapter 5: Discussion of results .....	38
5.1 Optimization of Print Process .....	38
5.2 Effect of temperature and time on impact strength of PLA .....	40
5.3 Ductile vs Brittle (Break Characteristic).....	41
Chapter 6: Conclusion.....	47
Chapter 7: Recommendations of Future Research.....	48
References.....	49

## ABBREVIATIONS

3DP	Three-Dimensional Printing
3D	Three-Dimensional
$\alpha$	Initial angle of the pendulum
$\beta$	Final angle of the pendulum
ABS	Acrylonitrile butadiene styrene
AM	Additive Manufacturing
ASTM	American Society for Testing and Materials
ASA	Acrylonitrile Styrene
CAD	Computer Aided Design
CF	Nylon and Carbon Fiber
DLP	Digital Light Processing
DSC	Differential Scanning Calorimetry
EBM	Electron- Beam Melting
EVA	Ethylene-vinyl acetate
FDM	Fused Deposition Modeling
FFF	Fused Filament Fabrication
FLM	Fused Layer Modeling
FTIR	Fourier transform infrared spectrograph
g	Acceleration of gravity
HIPS	High Impact Polystyrene
IE	Impact Energy
L	Length of the pendulum (0.327m)



LOM	Laminated Object Manufacturing
$M_w$	Molecular weight
PBAT	Polybutyrate adipate co-terephthalate
PBAX	Polyether block amide
PC	Polycarbonate
PETG	Polyethylene Terephthalate
PLA	Polylactic Acid
POM	Polarized Optical Microscope
PP	Polypropylene
PVA	Poly Vinyl Alcohol
RH	Relative Humidity
S#	Sample, where # designates the sample number 1, 2, etc.
SEM	Scanning Electron Microscopy
SEC	Size Exclusion Chromatography
SLA	Stereolithography
SLS	Selective Laser Sintering
STL	Standard Tessellation Language
TPU	Thermoplastic Polyurethane
TPU	Thermoplastic Polyurethane
$T_g$	Glass transition temperature
UV	Ultra-violet
W	Weight of the pendulum mass

## LIST OF FIGURES

Figure 1. Test specimen dimensions as defined by ASTM D256-10. ....	8
Figure 3. This Figure shows the location of Nozzle and Platform in the Flash Forged Creator Pro 3D Printer. ....	9
Figure 2. Screen shot of Flash print software showing internal view of STL file of impact specimen. ....	10
Figure 4. The figure shows the yellow color 3D printed PLA filament .....	11
Figure 5. Izod impact test apparatus .....	13
Figure 6. Shows the batch of six samples edited in the Flash print software .....	16
Figure 7. Shows printed samples and thermometer immersed in a water bath.....	18
Figure 8. 100% Humidity experimental set up .....	18
Figure 9. Non-vacuum electric oven with thermometer and knob locations .....	19
Figure 10. Graph shows the impact strength of 6 samples tested immediately after printing .....	22
Figure 11. Graphical representation of all impacted specimens at eight different temperatures under 100% Humidity .....	28
Figure 12. Graphical representation of all impacted specimens at seven different temperatures under Oven heating .....	33
Figure 13. Graphical representation of sample's impact strength under 100% humidity at $95\pm 5^{\circ}$ C and aging under room temperature .....	34
Figure 14. Graphical representation of sample's impact strength under 100% humidity at $85\pm 5^{\circ}$ C and aging under room temperature .....	36

Figure 15. Graphical representation of sample's impact strength under 100% humidity at 75±5° C and aging under room temperature .....	37
Figure 16. Stress and strain behavior of polymers retrieved from polymer properties database (2015) .....	42
Figure 17. Shows ductility vs brittle failure behavior under increase in temperature and impact energy .....	43
Figure 18. Arrangement of impact specimen between the vices (left) and a hinge failure (right) of specimen .....	44
Figure 19. Types of failure of twelve impacted specimens .....	45

## LIST OF TABLES

Table 1. Flash print software different parameter settings .....	12
Table 2. Mechanical and thermal properties of PLA (Makeitfrom 2015) .....	14
Table 3. Impact strength of samples tested immediately after printing without subjecting to heat treatment.....	21
Table 4. Effect of 100% humidity on impact properties of PLA at room temperature ....	23
Table 5. Effect of 100% humidity on impact properties of PLA at 35±5°C .....	23
Table 6. Effect of 100% humidity on impact properties of PLA at 45±5°C .....	24
Table 7. Effect of 100% humidity on impact properties of PLA at 55±5°C .....	24
Table 8. Effect of 100% humidity on impact properties of PLA at 65±5°C .....	25
Table 9. Effect of 100% humidity on impact properties of PLA at 75±5°C .....	25
Table 10. Effect of 100% humidity on impact properties of PLA at 85±5°C .....	26
Table 11. Effect of 100% humidity on impact properties of PLA at 95±5°C .....	26
Table 12. Effect of 100% humidity on impact properties of PLA under different environmental temperatures .....	28
Table 13. Effect of temperature on impact properties of PLA at 35±5°C .....	29
Table 14. Effect of temperature on impact properties of PLA at 45±5°C .....	29
Table 15. Effect of temperature on impact properties of PLA at 55±5°C .....	30
Table 16. Effect of temperature on impact properties of PLA at 65±5°C .....	30
Table 17. Effect of temperature on impact properties of PLA at 75±5°C .....	31
Table 18. Effect of temperature on impact properties of PLA at 85±5°C .....	31
Table 19. Effect of temperature on impact properties of PLA at 95±5°C .....	32
Table 20. Effect of temperatures on impact properties of PLA using oven test.....	33

Table 21. Effect of 100% humidity and aging on impact properties of PLA at $95\pm 5^{\circ}\text{C}$ ..	34
Table 22. Effect of 100% humidity and aging on impact properties of PLA at $85\pm 5^{\circ}\text{C}$ ..	35
Table 23. Effect of 100% humidity and aging on impact properties of PLA at $75\pm 5^{\circ}\text{C}$ ..	37
Table 24. Shows the severity of voids at different nozzle and platform temperatures. ....	39
Table 25. Sample and type of failure .....	45

## ABSTRACT

A STUDY OF THE EFFECT OF HEAT TREATMENT ON 3D PRINTED PLA  
IMPACT STRENGTH

SURESH THOTA

2019

Environmental conditions have a significant effect on the mechanical properties of various materials. Environmental parameters such as temperature and humidity have a major impact on mechanical properties of materials such as compressive strength, tensile strength, bending strength and impact strength. The purpose of this research is to study how temperature and humidity affect the impact strength of 3D printed PLA plastic. Impact strength is the ability of a material to absorb energy subjected to an impact load by a pendulum. In this research, 3D printing was employed to produce PLA specimens which were later used for different experimental testings. For 100% humidity, six pairs of PLA specimens were heated in a water bath to reach a desired temperature, within the range 25° C ( $\pm 5^\circ\text{C}$ ) to 95° C. For each different test, the temperature in the water bath was incremented by 10° C to reach a maximum of 95°C. Thus, eight different temperature experiments were performed. Two PLA specimens were impact tested in time increments of two hours. Temperature effects were studied by heating six PLA specimens in a non-vacuum oven, at eight different temperatures as mentioned above. The specimens were later impact tested following ASTM D256 standards test methods for *Determining Izod Pendulum Impact Toughness of Plastic Materials*. The test results show impact strength of the PLA increased with an increase in temperature treatment. The PLA samples had the highest impact strength at higher temperature treatment but only for short heat treatment

times. At low temperature treatment, the impact strength of PLA samples increased with an increase in treatment time. The samples impact tested after aging at room temperature post heat treatment have considerably shown low impact strength. This concludes, the impact strength of PLA is not sustaining with aging of samples. So, heat treatment can change the strength of 3D printed PLA but it was verified upon testing that the initial strength tested right after the heat treatment was not sustained over time as the impact strength of the samples decreased although not to the initial strength prior to heat treatment.

## Chapter 1: Introduction

In civil engineering structures, concrete is a highly used construction material and is exposed to different environmental conditions such as changes in temperature and humidity (Shoukry et al. 2011). In service, the effects are mechanical (dynamic or static), physical or both (Jiao et al. 2014). Mechanical properties such compressive strength, splitting tensile strength, impact energy and modulus of elasticity are affected by changes in temperature.

Impact strength is the capability of the material to withstand a suddenly applied load which is expressed in energy (J/m). Materials with high impact strength absorb more energy and are more ductile in nature. Ductile materials are considered tough and resist fracture. Low impact strength materials are typically brittle in nature. Generally, samples prepared from thermoplastics show low impact strength at low temperatures and higher impact strength at higher temperatures.

The use of plastics in daily life brings many benefits but has an adverse effect on the environment. Due to the excess usage of plastic, without proper disposal, plastic waste has resulted in eight million tons of waste (plastic) entering the oceans every year and contaminating drinking water which not only affect humans and animals but also causes serious problems in the environment (Daily Sabah, 2018). If plastic was able to be used in infrastructure, there would be a large market for recycled plastic. In order to reuse plastic, the long-term material properties need to be studied.

This research utilizes a thermoplastic material called polylactic acid (PLA), which is cost effective, to study the environmental effect on its impact strength. The purpose of this research is to study how temperature and humidity affect the impact strength of 3D printed



PLA plastic. In this study, 3D printing was employed to create the test specimens. The specimens were 3D printed using a Flash Forge Creator Pro and later they were impact tested at different temperatures under low and 100% humidity. The impact test was performed in accordance with ASTM D256 standards test methods for *determining Izod pendulum impact toughness of plastic materials*.

## **1.1 Overview of Thesis**

This thesis is arranged by chapters of specific information. Chapter 2 presents information on the background of the study and literature review. Chapter 3 includes information on the methods and materials used to perform the study and various procedures followed to meet the objective of the research. Chapter 4 includes the results obtained from experimental testing. Chapter 5 includes discussion of results obtained during the study and compares the observed results of this study with other study results. Chapter 6 includes major conclusions. Chapter 7 includes suggestions for future studies related to this research.

## Chapter 2: Literature Review

3D printing has been around since 1987 (Vialva et al. 2019). Its use is increasing in many areas especially in Civil Engineering.

### **2.1 3D Printing**

3D printing is a method used to make the 3-dimensional advanced models, ordinarily by setting down numerous progressive thin layers of material. Many conventional methods have been used to design a product with given specifications for real-time applications. The drawbacks with those methods included not cost-effective and utilizing more time and energy. 3D printing is a technique which can replace the previous conventional methods. Polylactic acid (PLA), Acrylonitrile Butadiene Styrene (ABS) and Nylon are some of the materials used to print the objects. Printing techniques were broadly classified into seven types; Stereolithography (SLA), Selective Laser Sintering (SLS), Selective Laser Melting (SLM), Fused Deposition Modeling (FDM), Digital Light Processing (DLP), Electron-Beam Melting (EBM) and Laminated Object Manufacturing (LOM) (Sandeep and Chhabra 2017). In the current research, we used FDM technique to print the samples.

### **2.2 Fused Deposition Modeling (FDM)**

Fused deposition modeling (Weiner 2019), also known as fused filament fabrication, is used to fabricate an object with the support of a filament coil connected to a heated extruder. The extruder will move in the x and y directions on the building platform to mold the object. The filament material which was fed into the extruder will be heated up in the nozzle and solidifies quickly after deposition. After completion of each layer, the building platform moves down so the nozzle can print the next layer on top of the prior. The process continues by adding layers until the sample is completed. Some of the benefits of FDM

are; it can be used to print complex objects using different materials, it is easy to replace filament materials in a short time, and it is possible print with cheaper materials.

### **2.3 3D Printing in Civil Engineering**

In 2015, a Shanghai-based Winsun decoration design engineering company and a Russian based design engineering company called Apis Cor built 10 3D printed houses in 24 hours (Honrubia 2018) by spraying down quick-drying cement and recycled raw materials with the support of massive 3D Printer. In Spain in 2016, the world's first and largest 3D pedestrian bridge was constructed. It was made in several phases. The bridge is located in the Castilla-La Mancha urban park in Alcobendas and was designed by a company called Acciona (Honrubia 2018). Initially, an architectural design was created and later a 3D printer was manufactured to print the design. In 2017, a French company called XtreeE, which specializes in 3D concrete printing, prefabricated a 7'×7'×8' stormwater drain in a warehouse and then placed it directly on the site. These drains were printed and placed in just 9 hours (Kidwell 2017). In 2014 in Amsterdam, a specially designed 3D printer arm that looks like a giant crane was employed to print a canal with plastic. Each of these projects used 3D printing as part of the construction process and incorporated civil engineering principles in their design. Plastics, although not a traditional civil engineering are seeing more usage. This research study uses PLA as the material.

### **2.4 Polylactic Acid**

Polylactic acid (PLA) is a thermoplastic polymer that was first invented in the 1920s by Wallace Carothers, who was working on creating an environmentally friendly plastic. PLA is made from renewable resources such as corn and sugarcane (Polymerdatabase, 2015). Because of biodegradability and biocompatibility behavior, PLA can be used in medical

applications for wound healing (Mogosanu & Grumezescu 2014). Some natural polymers like Polysaccharides, Proteins, and Proteoglycans can be obtained by an electrospinning process of synthetic polymers such as Polylactic acid.

### **2.5 Effect of Heat Treatment on Mechanical Properties of PLA**

Alain Copinet et al. (2004) studied the effect of temperature, ultra-violet light (315nm) and relative humidity (RH) on the degradation of PLA. Samples were prepared by placing PLA in Erlenmeyer flasks containing a universal stopper and a chloroform solution and then dried on glass to produce PLA films. Fourier transform infrared spectrograph (FTIR) technique was used to identify the degradation process in samples. The paper concluded that UV light has a larger impact on the degradation of PLA films compared to temperature or humidity. An increase of temperature and RH accelerated the degradation process and decreased polymer properties such as molecular weight (Mw) and glass transition temperature (Tg). The reasons given for this decrease included absorption of water which resulted in the hydrolysis process occurring within the samples. Hydrolysis is a process that when a substance reacts with water it breaks down large macromolecules into smaller components and this process increases with the increase of temperature. By using FTIR technique, it was observed that an increase of temperature and degradation the sample increased its crystallinity behavior in polymer chains.

Kai-Lai G. Ho et al. (1999) studied the degradation of three high molecular weight PLA films. They investigated films at different environmental parameters such as temperature (28, 40 and 55°C) and relative humidity (10%, 50%, and 100%). Chronopol (Ch-I) and Cargill Dow polymers such as GII and Ca-I were chosen and tested. The results show a decrease in tensile properties of PLA films when their average Mw was in the range of

50k-75k g mol<sup>-1</sup>. From all testing results, Ca-I reported the lowest degradation rate when compared to Ch-II and GII. GII recorded the fastest degradation rate of 27,361 Mw/week. They also observed that the degradation rate of plastic increased with the increase of temperature and relative humidity (RH).

Niaounakis et al. (2010) sought to investigate the behavior of environmental parameters such as temperature and relative humidity in the aging of PLA. The tested temperature conditions were 20, 40 and 50°C (below T<sub>g</sub>) and relative humidity of 80%. The samples were exposed to two heating runs of each of the environmental conditions at different aging periods (30, 60, 80, 100, and 130 days). The PLA samples were tested with various techniques, including size exclusion chromatography (SEC), dynamic mechanical analysis (DMA), and differential scanning calorimetry (DSC). They observed that reduction of properties happened to samples exposed at 20°C for 30 days but no further loss was seen at 40°C. An intense decrease in properties occurred to the samples at 50°C for 100 days. They concluded that the rate of degradation was slow for samples exposed under or equal to 40°C, but the rate increases when the temperature was above 50°C.

## Chapter 3: Methodology and Materials

### 3.1 Design of Impact Testing Model

The specimens for this experiment were printed with fused filament fabrication (FFF) method with PLA filament as the printing material. The specimens were modeled with SolidWorks Computer Aided Design (CAD) software (Solid works 2016, Dassault Systems, Waltham, MA USA). The geometry of the specimen was defined by ASTM D256 standard test methods for determining the Izod pendulum impact resistance of plastics. Geometry and dimensions were shown in the Figure 1. This model was later exported as a Standard Tessellation Language (STL) file and uploaded into the Flash print software. Flash print software is used at the time of printing the samples. A Flash Forge Creator Pro 3D printer (Figure 2) was used to print the impact specimens analyzed in this study.

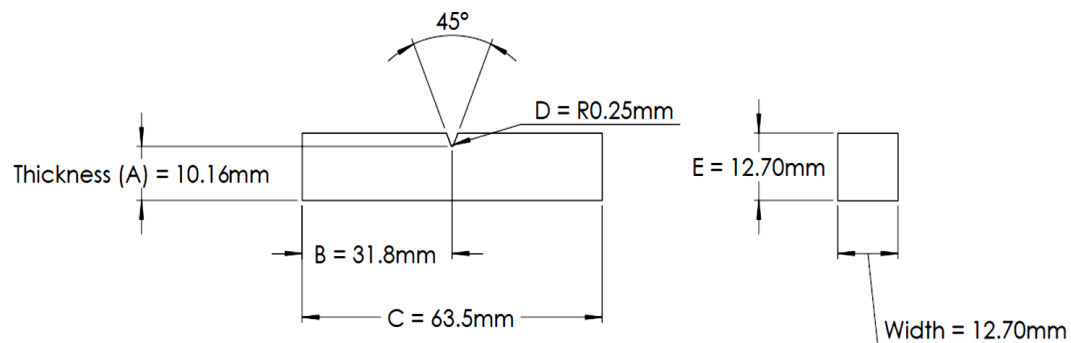

Figure 1. Test specimen dimensions as defined by ASTM D256-10.

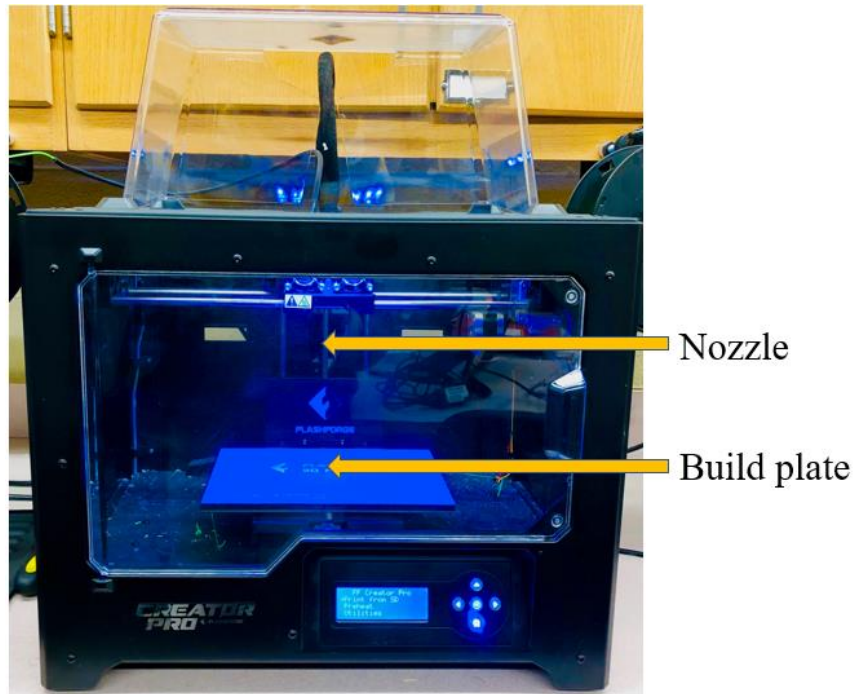

Figure 2. This Figure shows the location of Nozzle and Platform in the Flash Forged Creator Pro 3D Printer.

To overcome the limitation in clearance between the sample holdings the thickness and width of the sample were restricted to 12.5mm. Flash print is very simple and user-friendly software. It has many available options to modify the STL file. The screenshot image of Flash print software with the Izod impact test sample is shown in the Figure 3.



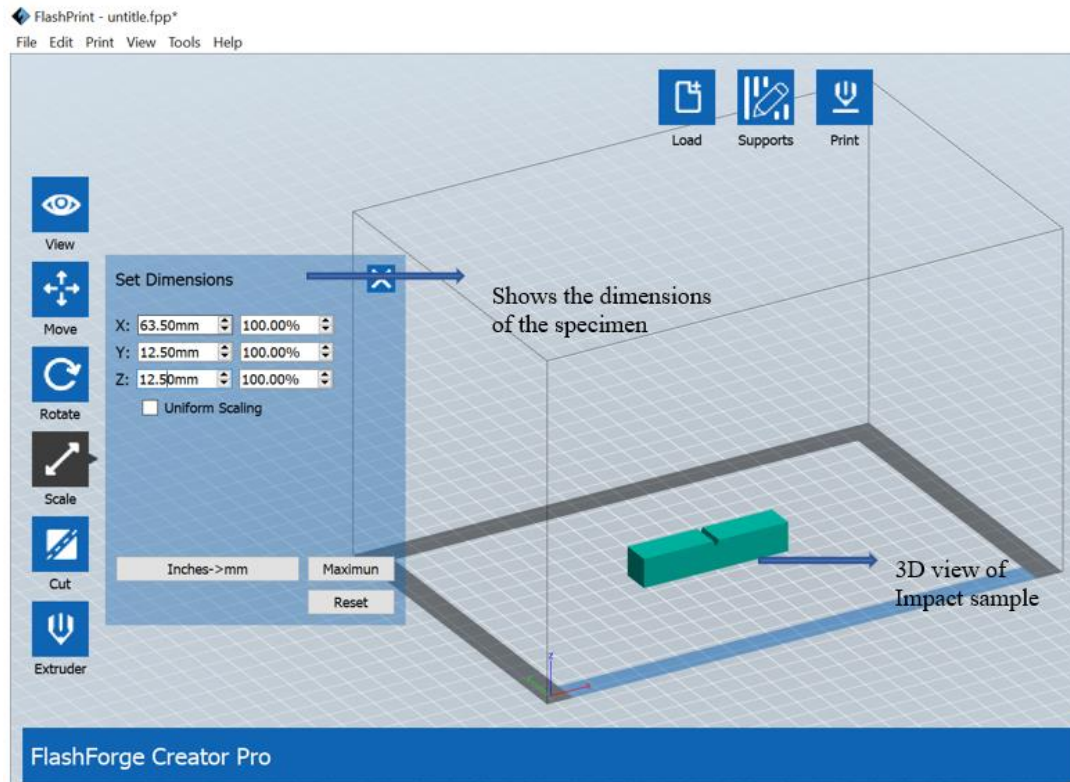

Figure 3. Screen shot of Flash print software showing internal view of STL file of impact specimen.

The technical specifications of Flash Forged Creator Pro 3D Printer (Creator Pro 3D printer 2016) are as follows:

- Build volume:  $227 \times 148 \times 150\text{mm}$
- Layer resolution: 100~500 microns
- Machine dimensions:  $526 \times 360 \times 550\text{mm}$
- Layer thickness: 0.1mm to 0.3mm
- Diameter of nozzle: 0.4mm
- Filament diameter: 1.75mm
- Product weight: 14.8 kg

- Filament compatibility: PLA, ABS, TPU, TPE, PVA, Wood Filled Filament, ABS Pro, Flexible Filament, Pearl and PP.

### 3.2 PLA Filament

In this research, Melca 3D printer PLA filament of diameter 1.75mm with a tolerance of  $\pm 0.03\text{mm}$  was used to print the samples. In this study, we used a total of 4 spools of yellow PLA to print all samples used for the experiments. Figure 4 shows the 3D printer PLA filament.

The benefits of this product included the following.

- 1) It was more affordable.
- 2) It required low nozzle temperatures to melt the PLA filament with required print settings of: Melt temperature:  $180^{\circ}\text{C}$ - $220^{\circ}\text{C}$  and Build plate temperature:  $0$ - $60^{\circ}\text{C}$ .



Figure 4. The figure shows the yellow color 3D printed  
PLA filament

### 3.3 Print Settings

The following settings in the Flash print software were used for all PLA samples (Table 1).

Table 1. Flash print software different parameter settings

<b>Layer height</b>	Layer height	0.18mm
	First layer height	0.27mm
<b>Shells</b>	Perimeter shells	2
	Top solid layers	3
	Bottom solid layers	3
<b>Infill</b>	Fill density	100%
	Fill pattern	Hexagon
	Combine infill	Every two layers
<b>Speed</b>	Print speed	60mm/s
	Travel speed	80mm/s
<b>Temperature</b>	Extruder	215°C
	Build plate	50°C

### 3.4 Impact Testing Parameters

The impact specimens were tested on an Izod pendulum impact apparatus, shown in Figure 5. In this test, the notched specimen was fixed between the vices at one end of the sample which resulted in the sample being held in a cantilever position. The pendulum carrying the striker strikes the sample on the unsecured end with a load. If the sample does not break, a heavier hammer is used until the failure occurs. Before starting the test, the arm of the

pendulum is set to  $0^\circ$  and then it was released. The angle of the pendulum is noted from the digital meter, a custom Arduino and rotary encoder, which was connected to the apparatus. This apparatus displays the angle more accurately when compared to the traditional needle scale attached to the equipment. The amount of energy absorbed by the sample in the failure process is known as the impact energy and its units are reported in Joules. There are three different hammer weights available, large, medium and small.

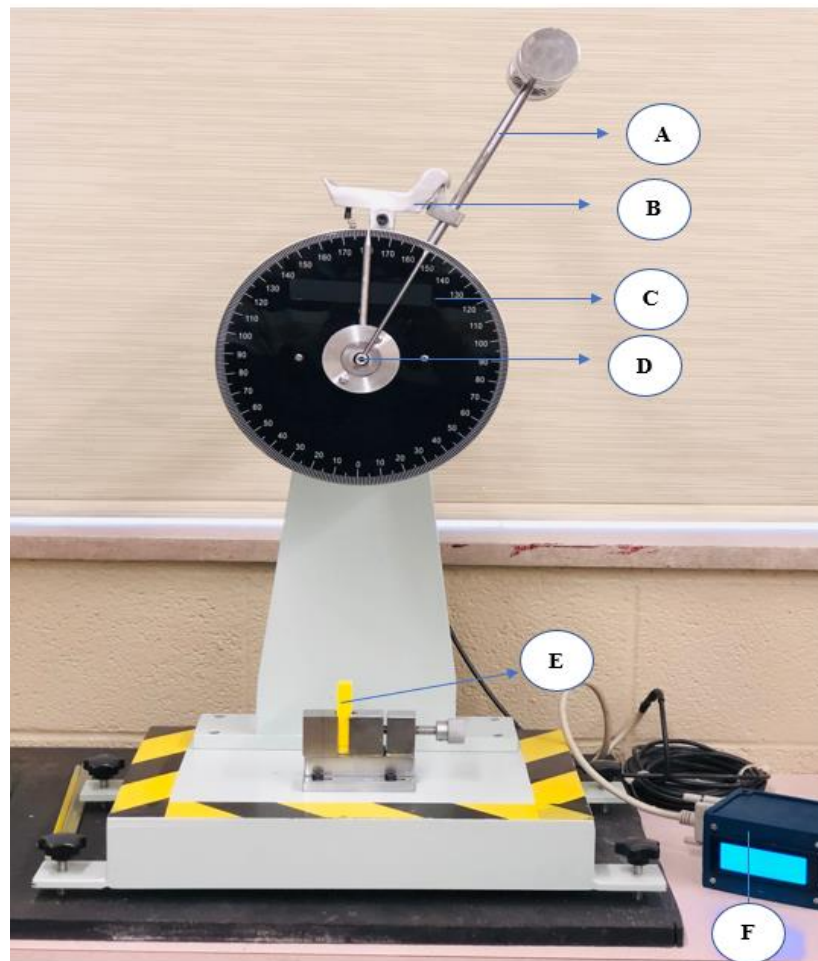

Figure 5. Izod impact test apparatus

Where, A = Pendulum

B = Pendulum control lever

C = Scale

D = Axis of rotation

E = Test specimen

F = Custom Arduino and rotary encoder

The impact energy was determined by using following equation,

$$\text{Impact energy (IE)} = (W \times g \times L (\cos \beta - \cos \alpha)) - \text{Frictional loss}$$

Where,

W = Weight of the pendulum mass in kg

g = Acceleration of gravity (9.81 m/s<sup>2</sup>)

L = Length of the pendulum (0.327m)

$\beta$  = Final angle of the pendulum

$\alpha$  = Initial angle of the pendulum

Frictional loss = large hammer (0.244634), medium hammer (0.15378), and small hammer (0.11112)

### 3.5 Properties of PLA

The research study uses PLA, the mechanical and thermal properties of PLA are provided in Table 2.

Table 2. Mechanical and thermal properties of PLA (Makeitfrom 2015)

Elastic (Young's, Tensile) Modulus	3.5 GPa
Flexural Strength	80 MPa
Shear Modulus	2.4 GPa
Ultimate Tensile Strength (UTS)	50 MPa
Elongation at Break	6.0%

Flexural Modulus	4.0 GPa
Density	13 g/cm <sup>3</sup>
Glass Transition Temperature	60° C
Melting Onset	160° C
Thermal Conductivity	0.13 W/ m-K
Specific Heat Capacity	1800 J/ kg K
Maximum Temperature	50° C
Thermal Diffusivity	0.058 m <sup>2</sup> /s

### 3.6 Experiments

In the Flash print software, six samples of dimensions (63.5mm × 12.5mm × 12.5mm) were arranged on the platform as shown in the Figure 6, due to the uneven distribution in bed temperatures. The temperature of the nozzle and platform were set to 215°C and 50°C respectively. The print parameters such as fill density, layer height, and shell were shown in the Table 1 previously.

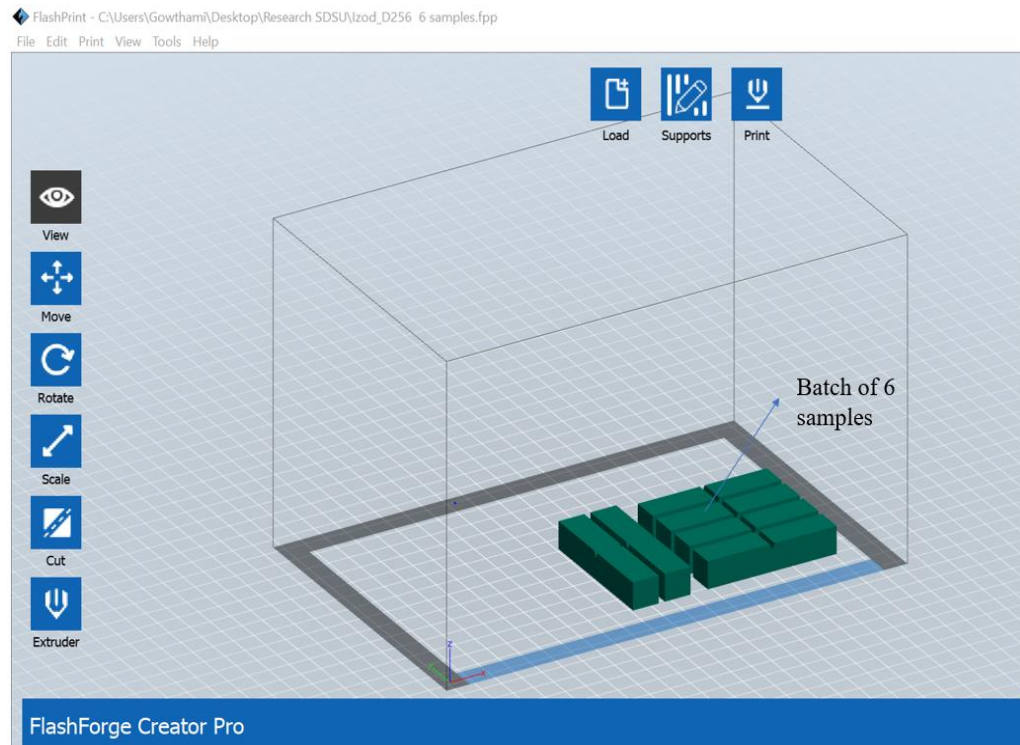

Figure 6. Shows the batch of six samples edited in the Flash print software

The individual experiment performed as part of study were as follows; a relative humidity series of tests that subjected samples to 100% humidity for various temperatures and times, and a low humidity series of tests that subjected samples to various temperature and times but in a dry oven (non-vacuum oven test).

### 3.6.1 100% Humidity Test Series

The aim of 100% humidity test is to understand the variation of impact strength of 3D printed PLA samples by Izod test under different heat treatments at 100% humidity. In this experiment, 6 samples were 3D printed for every batch. A sum of ninety-six samples were printed for this test. An electric stove was used to maintain the required temperature in a water bath with the water bath being at the required temperature 30 minutes prior to the completion of sample printing. The samples were then immediately placed into the heated

water bath, after the completion of printing. The samples were held in the heated ( $25\pm 5^{\circ}\text{C}$  -  $95\pm 5^{\circ}\text{C}$ ) bath for a specified length of time. The experimental arrangement and the samples immersed in the water bath are as shown in the Figures 7 & 8. The mercury thermometer was used to record the temperature, with its bulb completely dipped in the water. In this test, samples were impact tested, at eight different temperatures, beginning with room temperature ( $25\pm 5^{\circ}\text{C}$ ) to  $95\pm 5^{\circ}\text{C}$  with an increment of  $10^{\circ}\text{C}$  for each subsequent test. The temperatures were  $25\pm 5^{\circ}\text{C}$ ,  $35\pm 5^{\circ}\text{C}$ ,  $45\pm 5^{\circ}\text{C}$ ,  $55\pm 5^{\circ}\text{C}$ ,  $65\pm 5^{\circ}\text{C}$ ,  $75\pm 5^{\circ}\text{C}$ ,  $85\pm 5^{\circ}\text{C}$ , and  $95\pm 5^{\circ}\text{C}$ . At every temperature, six pairs of samples were used for heat treatment and then impact tested at the conclusion of their designated time. Samples were impact tested immediately after two hours of heat heating in the water bath. Similarly, from the remaining samples, a different pair was tested after every two hours of heat treatment up to twelve hours. The impact test of water heat treated (100% humidity) samples was conducted immediately by removing them from the water bath. The angle of the pendulum was recorded from the digital meter. The average angle of the two specimens was calculated after every test. The test results from the experiments were later analyzed by plotting graphs showing the time and the Impact strength for the different treatments.



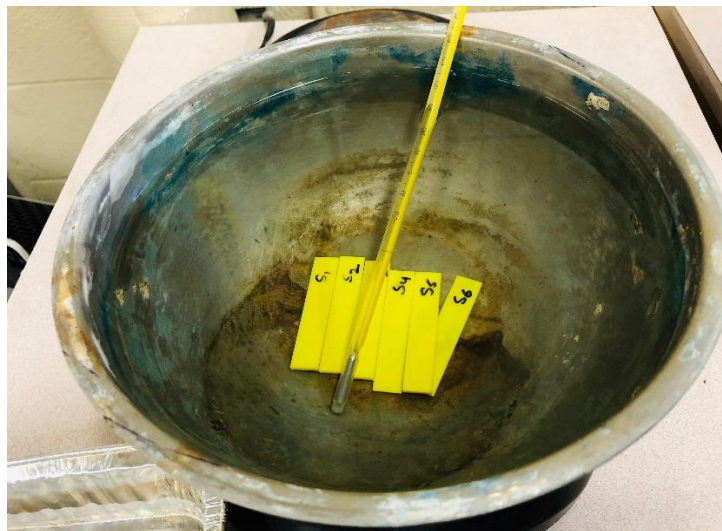

Figure 7. Shows printed samples and thermometer immersed in a water bath



Figure 8. 100% Humidity experimental set up

### 3.6.2 Non-Vacuum Oven Test Series

The non-vacuum oven test series was conducted to study the variations of impact 3D printed samples under different heat treatments at low humidity. In this test, an oven, shown in Figure 9, was used for heating PLA samples. The mercury thermometer was inserted into the oven to measure the temperature. The oven grill was covered with aluminum foil to place the samples. The same experimental procedure was followed as described earlier in the relative humidity test. In this test series, the samples were impact tested only for seven different temperatures with the initial temperature of  $35 \pm 5^\circ\text{C}$ . The test results from the experiments were later analyzed by plotting graphs of temperature, time of treatment and the impact strength.



Figure 9. Non-vacuum electric oven with thermometer and knob locations

### **3.6.3 Heating and Aging Effect on Impact Strength of PLA**

In this experiment, six samples were tested after heating for a certain temperature for a specific time under 100% humidity condition and cooling the specimen under room temperature. Series of experiments were carried out at different temperatures such as  $95\pm 5^\circ\text{C}$ ,  $85\pm 5^\circ\text{C}$ , and  $75\pm 5^\circ\text{C}$  to check whether the samples were maintaining the impact strength. In this process, the initial test was carried out at  $95\pm 5^\circ\text{C}$  with the procedure explained below.

For  $95\pm 5^\circ\text{C}$ , six samples were printed and named as S0, S1, S2, S3, S4, and S5.

The sample S0 was impact tested immediately after printing. The samples S1 and S2 were tested after heating at  $95\pm 5^\circ\text{C}$  under 100% humidity for 1 hour and 2 hours respectively. The specimen S3 was tested after heating it for 2 hours under 100% humidity condition and cooling for 2 hours at room temperature. Similarly, S4 and S5 were heat treated for 2 hours under 100% humidity whereas the testing was done after 4 hours and 6 hours cooling under room temperature. The same experiment was conducted for different temperatures  $85\pm 5^\circ\text{C}$  and  $75\pm 5^\circ\text{C}$  but the samples were heat treated under 100% for 4 hours before cooling. The test results from the experiments were later analyzed by plotting graph between the time and the Impact strength.

### **3.7 Quality Control**

For quality control, two samples were printed, and impact tested for every specific heat treatment time for both the experiments. Initially, to check printing accuracy 12 samples were printed, and their dimensions were measured. It was declared that specimen dimensions were almost identical and matched with the actual dimensions with an error of 0.01mm.

## Chapter 4: Research Results

### 4.1 Non Heat Treatment Test

Six samples were 3D printed and tested one after the other under room temperature. The main aim of this test was to study the impact properties of a 3D printed specimen without subjecting to any treatment. In this test, the samples were immediately tested after 3D printing. The test results from the experiment are shown in the Table 3 and Figure 10.

Table 3 shows six samples tested at respective times. The impact strength of the samples decreased gradually from 26.1 J/m to 20.6 J/m and reached a constant value after 8 minutes.

Table 3. Impact strength of samples tested immediately after printing without subjecting to heat treatment

S (deg)	Friction Loss (J)	wt. (kg)	wt. type	Thickness (mm)	t (min.)	IE (J)	IE (J/m)
126.9	0.11112	0.449	S	10.36	1.40	0.3	26.1
127.7	0.11112	0.449	S	10.36	2.96	0.3	24.6
128.3	0.11112	0.449	S	10.36	4.70	0.2	23.4
129.0	0.11112	0.449	S	10.36	6.40	0.2	22.2
129.8	0.11112	0.449	S	10.36	8.20	0.2	20.6
129.8	0.11112	0.449	S	10.36	10.0	0.2	20.6

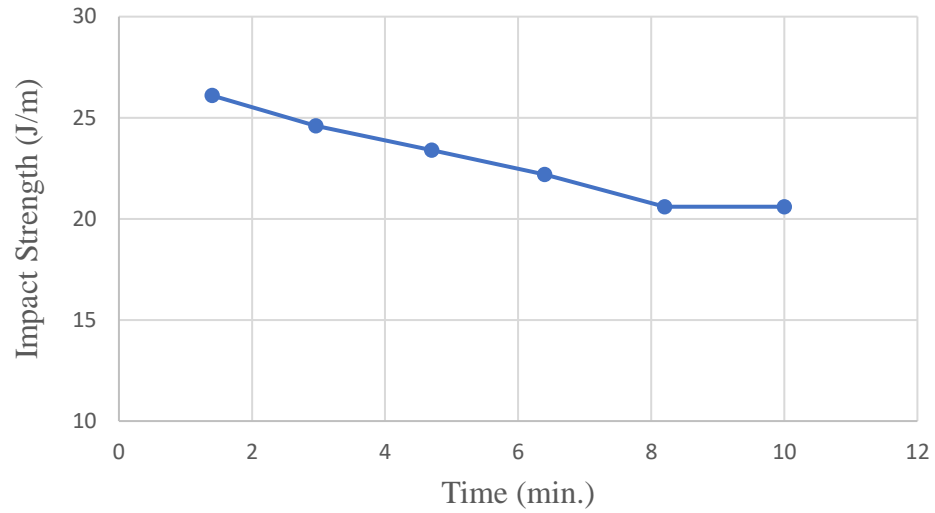

Figure 10. Graph shows the impact strength of 6 samples tested immediately after printing

From Figure 10, it can be observed that there is a linear decrease in impact strength of PLA with the increase of time from 1.4 min. to 8.2 min. until it reached a constant value.

## 4.2 100% Humidity Test

Table 4 shows twelve samples tested at 2-hour intervals between 2 hours and 12 hours. The average impact strength of the samples remained 26.7 J/m.

Table 4. Effect of 100% humidity on impact properties of PLA at room temperature

S1 (deg)	S2 (deg)	Avg Max Angle (deg)	Friction Loss (J)	wt. (kg)	wt. type	Thickness (mm)	t (hrs.)	IE (J)	IE (J/m)
135.8	135.8	135.8	0.15378	0.898	M	10.36	2	0.3	26.7
135.8	135.8	135.8	0.15378	0.898	M	10.36	4	0.3	26.7
135.8	135.8	135.8	0.15378	0.898	M	10.36	6	0.3	26.7
135.8	135.8	135.8	0.15378	0.898	M	10.36	8	0.3	26.7
135.8	135.8	135.8	0.15378	0.898	M	10.36	10	0.3	26.7
135.8	135.8	135.8	0.15378	0.898	M	10.36	12	0.3	26.7

\*IE = Average impact strength of samples S1 and S2 at time t

Table 5 shows twelve samples tested at 2-hour intervals between 2 hours and 12 hours. The average impact strength of the samples increased gradually from 48 J/m to 57 J/m.

Table 5. Effect of 100% humidity on impact properties of PLA at 35±5°C

S1 (deg)	S2 (deg)	Avg Max Angle (deg)	Friction Loss (J)	wt. (kg)	wt. type	Thickness (mm)	t (hrs.)	IE (J)	IE (J/m)
137.6	137.5	137.5	0.24463	1.797	L	10.36	2	0.5	48
136.9	137.6	137.2	0.24463	1.797	L	10.36	4	0.5	50
137.1	136.9	137.0	0.24463	1.797	L	10.36	6	0.5	51
136.1	136.9	136.5	0.24463	1.797	L	10.36	8	0.6	55
136.9	136.1	136.5	0.24463	1.797	L	10.36	10	0.6	55
136.1	136.1	136.1	0.24463	1.797	L	10.36	12	0.6	57

\*IE = Average impact strength of samples S1 and S2 at time t

Table 6 shows twelve samples tested at 2-hour intervals between 2 hours and 12 hours. The average impact strength of the samples increased gradually from 55 J/m to 77 J/m until 10 hours and later decreased to 71 J/m at 12 hours.

Table 6. Effect of 100% humidity on impact properties of PLA at 45±5°C

S1 (deg)	S2 (deg)	Avg Max Angle (deg)	Friction Loss (J)	wt. (kg)	wt. type	Thickness (mm)	t (hrs.)	IE (J)	IE (J/m)
135.6	137.5	136.5	0.24463	1.797	L	10.36	2	0.6	55
134.0	136.1	135.1	0.24463	1.797	L	10.36	4	0.7	64
135.4	134.0	134.7	0.24463	1.797	L	10.36	6	0.7	67
135.4	132.6	134.0	0.24463	1.797	L	10.36	8	0.7	72
134.0	132.6	133.3	0.24463	1.797	L	10.36	10	0.8	77
134.2	134.2	134.2	0.24463	1.797	L	10.36	12	0.7	71

\*IE = Average impact strength of samples S1 and S2 at time t

Table 7 shows twelve samples tested at 2-hour intervals between 2 hours and 12 hours. The average impact strength of the samples increased gradually from 342 J/m to 440 J/m until 8 hours and later decreased, over the treatment time from 8 hours to 12 hours, to 335 J/m.

Table 7. Effect of 100% humidity on impact properties of PLA at 55±5°C

S1 (deg)	S2 (deg)	Avg Max Angle (deg)	Friction Loss (J)	wt. (kg)	wt. type	Thickness (mm)	t (hrs.)	IE (J)	IE (J/m)
98.3	105.9	102.1	0.24463	1.797	L	10.36	2	3.5	342
96.2	92.6	94.4	0.24463	1.797	L	10.36	4	4.3	416
91.2	101.1	96.1	0.24463	1.797	L	10.36	6	4.1	399
91.9	91.9	91.9	0.24463	1.797	L	10.36	8	4.6	440
88.5	96.2	92.3	0.24463	1.797	L	10.36	10	4.5	436
88.5	117.1	102.8	0.24463	1.797	L	10.36	12	3.5	335

\*IE = Average impact strength of samples S1 and S2 at time t

Table 8 shows twelve samples tested at 2-hour intervals between 2 hours and 12 hours. The average impact strength of the samples increased gradually from 505 J/m to 558 J/m until 8 hours and later decreased, over the treatment time from 8 hours to 12 hours, to 493 J/m.

Table 8. Effect of 100% humidity on impact properties of PLA at 65±5°C

S1 (deg)	S2 (deg)	Avg Max Angle (deg)	Friction Loss (J)	wt. (kg)	wt. type	Thickness (mm)	t (hrs.)	IE (J)	IE (J/m)
77.8	92.6	85.2	0.24463	1.797	L	10.36	2	5.2	505
82.1	85.6	83.9	0.24463	1.797	L	10.36	4	5.4	518
82.1	83.5	82.8	0.24463	1.797	L	10.36	6	5.5	528
79.3	80.0	79.6	0.24463	1.797	L	10.36	8	5.8	558
89.1	83.5	86.3	0.24463	1.797	L	10.36	10	5.1	494
83.8	89.1	86.5	0.24463	1.797	L	10.36	12	5.1	493

\*IE = Average impact strength of samples S1 and S2 at time t

Table 9 shows twelve samples tested at 2-hour intervals between 2 hours and 12 hours. The average impact strength of the samples increased from 691 J/m to 745 J/m until 4 hours and later decreased, over the treatment time from 4 hours to 12 hours, to 340 J/m.

Table 9. Effect of 100% humidity on impact properties of PLA at 75±5°C

S1 (deg)	S2 (deg)	Avg Max Angle (deg)	Friction Loss (J)	wt. (kg)	wt. type	Thickness (mm)	t (hrs.)	IE (J)	IE (J/m)
62.4	68.1	65.3	0.24463	1.797	L	10.36	2	7.2	691
55.5	62.4	59.0	0.24463	1.797	L	10.36	4	7.7	745
77.9	73.6	75.8	0.24463	1.797	L	10.36	6	6.2	595
75.8	88.5	82.1	0.24463	1.797	L	10.36	8	5.5	534
98.2	95.4	96.8	0.24463	1.797	L	10.36	10	4.1	393
104.5	100.0	102.3	0.24463	1.797	L	10.36	12	3.5	340

\*IE = Average impact strength of samples S1 and S2 at time t



Table 10 shows twelve samples tested at 2-hour intervals between 2 hours and 12 hours. The average impact strength of the samples increased from 672 J/m to 728 J/m until 4 hours and later decreased, over the treatment time from 4 hours to 12 hours, to 121 J/m.

Table 10. Effect of 100% humidity on impact properties of PLA at 85±5°C

S1 (deg)	S2 (deg)	Avg Max Angle (deg)	Friction Loss (J)	wt. (kg)	wt. type	Thicknes s (mm)	t (hrs.)	IE (J)	IE (J/m)
62.4	72.3	67.4	0.24463	1.797	L	10.36	2	7.0	672
54.1	68.0	61.1	0.24463	1.797	L	10.36	4	7.5	728
75.8	78.0	76.9	0.24463	1.797	L	10.36	6	6.1	584
90.6	106.7	98.6	0.24463	1.797	L	10.36	8	3.9	375
112.3	105.3	108.8	0.24463	1.797	L	10.36	10	2.9	279
128.4	126.2	127.3	0.24463	1.797	L	10.36	12	1.3	121

\*IE = Average impact strength of samples S1 and S2 at time t

Table 11 shows twelve samples tested at 2-hour intervals between 2 hours and 12 hours. The average impact strength of samples decreased from 730 J/m to 8 J/m over the treatment time.

Table 11. Effect of 100% humidity on impact properties of PLA at 95±5°C

S1 (deg)	S2 (deg)	Avg Max Angle (deg)	Friction Loss (J)	wt. (kg)	wt. type	Thickness (mm)	t (hrs.)	IE (J)	IE (J/m)
59.7	61.8	60.8	0.24463	1.797	L	10.36	2	7.6	730
82.1	80.0	81.1	0.24463	1.797	L	10.36	4	5.6	544
107.5	97.5	102.5	0.24463	1.797	L	10.36	6	3.5	338
128.3	131.2	129.7	0.24463	1.797	L	10.36	8	1.1	102
143.8	143.8	143.8	0.24463	1.797	L	10.36	10	0.1	9
144.4	143.8	144.1	0.24463	1.797	L	10.36	12	0.1	8

\*IE = Average impact strength of samples S1 and S2 at time t

From test results in Table 12 and the Figure 11, a reverse trend was observed in the impact strength of PLA samples as the temperature increased. At  $35 \pm 5$  °C, the impact strength of PLA specimens increased with the increase of water heat treatment time. A minimum strength of 48 J/m was obtained after the first two hours and a maximum of 57 J/m was obtained after 12 hours. In contrast, samples showed decreasing impact strengths when treated at  $95 \pm 5$  °C, with a maximum of 730 J/m after the first two hours and a minimum of 8 J/m after 12 hours. Thus, 100% humidity heat treatment time has a significant effect on the impact strength of PLA samples. As the temperature increased, high impact strength was obtained for lesser heating times, whereas at lower temperatures high strength was obtained with an increase in heating times. At  $45 \pm 5$  °C the impact strength increased up to 10 hours of 100 % humidity treatment with a maximum strength of 77 J/m and decreased after further heating whereas at  $55 \pm 5$  °C and  $65 \pm 5$  °C impact strength increased up to 8 hours of 100% humidity treatment with a maximum strengths of 440 J/m and 558 J/m respectively and the impact strength decreased after further heating. Similarly, at  $75 \pm 5$  °C and  $85 \pm 5$  °C, impact strength increased up to 4 hours of heat treatment and it significantly decreased after further heating. However, impact strength remained constant at room temperature even after soaking samples for different times.

Table 12. Effect of 100% humidity on impact properties of PLA under different environmental temperatures

Time t (hrs.)	25±5°C (J/m)	35±5°C (J/m)	45±5°C (J/m)	55±5°C (J/m)	65±5°C (J/m)	75±5°C (J/m)	85±5°C (J/m)	95±5°C (J/m)
2	26.7	48	55	342	505	691	672	730
4	26.7	50	64	416	518	745	728	544
6	26.7	51	67	399	528	595	584	338
8	26.7	55	72	440	558	534	375	102
10	26.7	55	77	436	494	393	279	9
12	26.7	57	71	335	493	340	121	8

\*IE = Average impact strength of samples S1 and S2 at time t

In the Table 12, the numbers in red represent highest impact strength at a specific temperature.

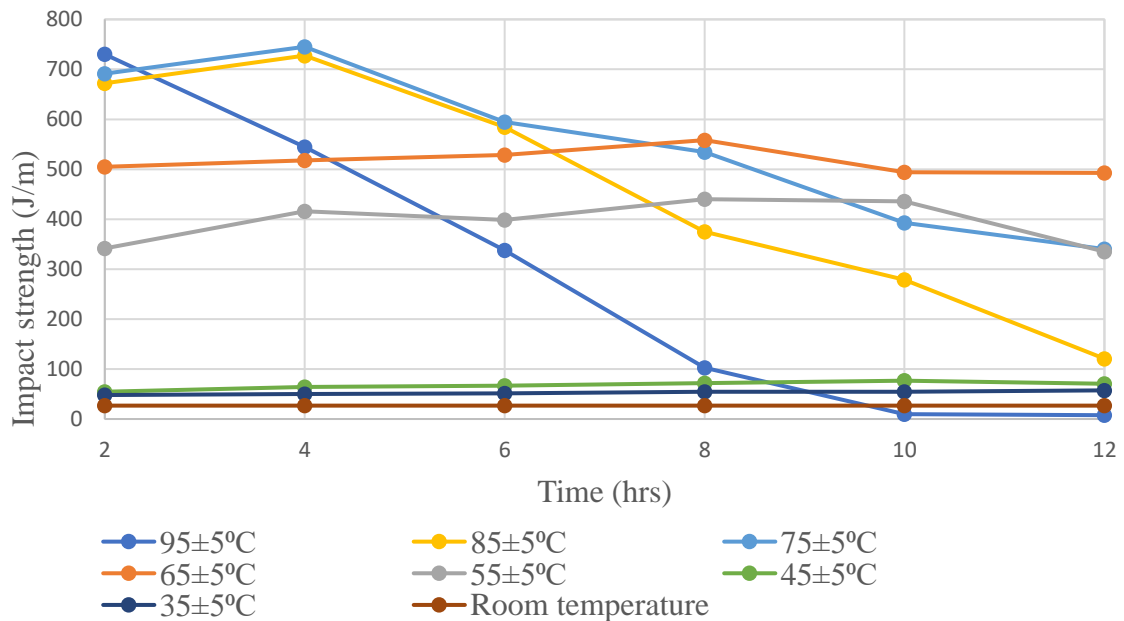

Figure 11. Graphical representation of all impacted specimens at eight different temperatures under 100% Humidity

### 4.3 Non- Vacuum Oven Test

Table 13 shows twelve samples tested at 2-hour intervals between 2 hours and 12 hours.

The average impact strength of samples at 2 hours was 25.4 J/m and the strength of samples increased from 23.5 J/m to 25.9 J/m.

Table 13. Effect of temperature on impact properties of PLA at 35±5°C

S1 (deg)	S2 (deg)	Avg Max Angle (deg)	Friction Loss (J)	wt. (kg)	wt. type	Thickness (mm)	t (hrs.)	IE (J)	IE (J/m)
128.3	126.2	127.3	0.11112	0.449	S	10.36	2	0.3	25.4
128.6	128.0	128.3	0.11112	0.449	S	10.36	4	0.2	23.5
128.4	127.6	128.0	0.11112	0.449	S	10.36	6	0.2	24.0
127.7	127.7	127.7	0.11112	0.449	S	10.36	8	0.3	24.6
127.6	127.6	127.6	0.11112	0.449	S	10.36	10	0.3	24.8
127.0	127.0	127.0	0.11112	0.449	S	10.36	12	0.3	25.9

\*IE = Average impact strength of samples S1 and S2 at time t

Table 14 shows twelve samples tested at 2-hour intervals between 2 hours and 12 hours.

The average impact strength of the samples increased gradually from 25.4 J/m to 28.8 J/m until 10 hours and later strength decreased from 8 hours to 12 hours to 23.3 J/m.

Table 14. Effect of temperature on impact properties of PLA at 45±5°C

S1 (deg)	S2 (deg)	Avg Max Angle (deg)	Friction Loss (J)	wt. (kg)	wt. type	Thickness (mm)	t (hrs.)	IE (J)	IE (J/m)
126.9	127.7	127.3	0.11112	0.449	S	10.36	2	0.3	25.4
125.6	126.3	126.0	0.11112	0.449	S	10.36	4	0.3	28.0
124.3	127.0	125.7	0.11112	0.449	S	10.36	6	0.3	28.6
124.8	126.3	125.6	0.11112	0.449	S	10.36	8	0.3	28.8
125.5	126.3	125.9	0.11112	0.449	S	10.36	10	0.3	28.1
128.4	128.4	128.4	0.11112	0.449	S	10.36	12	0.2	23.3

\*IE = Average impact strength of samples S1 and S2 at time t

Table 15 shows twelve samples tested at 2-hour intervals between 2 hours and 12 hours. The average impact strength of the samples increased gradually from 69 J/m to 157 J/m until 8 hours and later strength decreased from 8 hours to 12 hours to 79 J/m.

Table 15. Effect of temperature on impact properties of PLA at 55±5°C

S1 (deg)	S2 (deg)	Avg Max Angle (deg)	Friction Loss (J)	wt. (kg)	wt. type	Thickness (mm)	t (hrs.)	IE (J)	IE (J/m)
136.1	132.6	134.4	0.24463	1.797	L	10.36	2	0.7	69
111.5	99.0	105.2	0.11112	0.449	S	10.36	4	0.8	73.12
136.1	129.1	132.6	0.24463	1.797	L	10.36	6	0.8	82
125.5	120.0	122.8	0.24463	1.797	L	10.36	8	1.6	157
133.3	131.2	132.2	0.24463	1.797	L	10.36	10	0.9	84
133.3	132.6	133.0	0.24463	1.797	L	10.36	12	0.8	79

\*IE = Average impact strength of samples S1 and S2 at time t

Table 16 shows twelve samples tested at 2-hour intervals between 2 hours and 12 hours. The average impact strength of samples decreased from 608 J/m to 324 J/m.

Table 16. Effect of temperature on impact properties of PLA at 65±5°C

S1 (deg)	S2 (deg)	Avg Max Angle (deg)	Friction Loss (J)	wt. (kg)	wt. type	Thickness (mm)	t (hrs.)	IE (J)	IE (J/m)
75.8	72.9	74.4	0.24463	1.797	L	10.36	2	6.3	608
81.7	93.3	87.5	0.24463	1.797	L	10.36	4	5.0	483
95.5	100.3	97.9	0.24463	1.797	L	10.36	6	4.0	382
101.8	87.7	94.7	0.24463	1.797	L	10.36	8	4.3	412
97.6	104.5	101.0	0.24463	1.797	L	10.36	10	3.6	352
102.4	105.6	104.0	0.24463	1.797	L	10.36	12	3.4	324

\*IE = Average impact strength of samples S1 and S2 at time t

Table 17 shows twelve samples tested at 2-hour intervals between 2 hours and 12 hours. The average impact strength of the samples increased gradually from 487 J/m to 521 J/m.

Table 17. Effect of temperature on impact properties of PLA at  $75\pm 5^\circ\text{C}$

S1 (deg)	S2 (deg)	Avg Max Angle (deg)	Friction Loss (J)	wt. (kg)	wt. type	Thickness (mm)	t (hrs.)	IE (J)	IE (J/m)
87.8	86.4	87.1	0.24463	1.797	L	10.36	2	5.0	487
92.7	85.0	88.8	0.24463	1.797	L	10.36	4	4.9	470
87.0	89.1	88.0	0.24463	1.797	L	10.36	6	4.9	477
88.8	88.4	88.6	0.24463	1.797	L	10.36	8	4.9	472
86.7	82.8	84.7	0.24463	1.797	L	10.36	10	5.3	509
86.4	80.7	83.5	0.24463	1.797	L	10.36	12	5.4	521

\*IE = Average impact strength of samples S1 and S2 at time t

Table 18 shows twelve samples tested at 2-hour intervals between 2 hours and 12 hours. The average impact strength of the samples increased gradually from 703 J/m to 722 J/m until 6 hours and later strength decreased to 706 J/m at 8 hours. The maximum impact strength of 745 J/m was observed at 10 hours of heat treatment.

Table 18. Effect of temperature on impact properties of PLA at  $85\pm 5^\circ\text{C}$

S1 (deg)	S2 (deg)	Avg Max Angle (deg)	Friction Loss (J)	wt. (kg)	wt. type	Thickness (mm)	t (hrs.)	IE (J)	IE (J/m)
63.2	64.6	63.9	0.24463	1.797	L	10.36	2	7.3	703
62.4	65.2	63.8	0.24463	1.797	L	10.36	4	7.3	704
62.4	61.0	61.7	0.24463	1.797	L	10.36	6	7.5	722
66.0	61.0	63.5	0.24463	1.797	L	10.36	8	7.3	706
61.1	56.8	59.0	0.24463	1.797	L	10.36	10	7.7	745
65.9	65.9	65.9	0.24463	1.797	L	10.36	12	7.1	685

\*IE = Average impact strength of samples S1 and S2 at time t

Table 19 shows twelve samples tested at 2-hour intervals between 2 hours and 12 hours. The average impact strength of the samples increased gradually from 669 J/m to 697 J/m until 6 hours and later strength decreased from 6 hours to 12 hours to 676 J/m.

Table 19. Effect of temperature on impact properties of PLA at  $95\pm 5^\circ\text{C}$

S1 (deg)	S2 (deg)	Avg Max Angle (deg)	Friction Loss (J)	wt. (kg)	wt. type	Thickness (mm)	t (hrs.)	IE (J)	IE (J/m)
66.7	68.7	67.7	0.24463	1.797	L	10.36	2	6.9	669
65.3	68.7	67.0	0.24463	1.797	L	10.36	4	7.0	675
61.7	67.4	64.6	0.24463	1.797	L	10.36	6	7.2	697
64.5	66.6	65.6	0.24463	1.797	L	10.36	8	7.1	688
68.0	68.7	68.4	0.24463	1.797	L	10.36	10	6.9	663
68.0	65.9	67.0	0.24463	1.797	L	10.36	12	7.0	676

\*IE = Average impact strength of samples S1 and S2 at time t

From Table 20 and Figure 12, it can be observed that PLA samples have shown nearly similar impact strengths for different heating times for the same temperature. PLA samples exhibited the highest impact strength at  $65\pm 5^\circ\text{C}$  for 2 hours of oven heating and later strength decreased with the increase of heating time. At  $35\pm 5^\circ\text{C}$ , the maximum impact strength of PLA specimens was obtained for 12 hours of oven heating. At  $45\pm 5^\circ\text{C}$  and  $55\pm 5^\circ\text{C}$ , the impact strength increased up to 8 hours of oven heating with a maximum strength of 28.8 J/m and 157 J/m respectively and decreased after further heating, whereas at  $75\pm 5^\circ\text{C}$  maximum impact strength of 521 J/m was observed for 12 hours of oven heating. At  $85\pm 5^\circ\text{C}$  and  $95\pm 5^\circ\text{C}$  maximum impact strength of 745 J/m and 697, J/m was observed for 10 hours and 6 hours of oven heating.

Table 20. Effect of temperatures on impact properties of PLA using oven test

Time t (hrs.)	35±5°C (J/m)	45±5°C (J/m)	55±5°C (J/m)	65±5°C (J/m)	75±5°C (J/m)	85±5°C (J/m)	95±5°C (J/m)
2	25.4	25.4	69	608	487	703	669
4	23.5	28.0	73.12	483	470	704	675
6	24.0	28.6	82	382	477	722	697
8	24.6	28.8	157	412	472	706	688
10	24.8	28.1	84	352	509	745	663
12	25.9	23.3	79	324	521	685	676

\*IE = Average impact strength of samples S1 and S2 at time t

In the Table 20, the numbers in red represent highest impact strength at a specific temperature. Unlike the 100% humidity treated samples, the test results from low humidity heat treatment do not follow a recognized pattern.

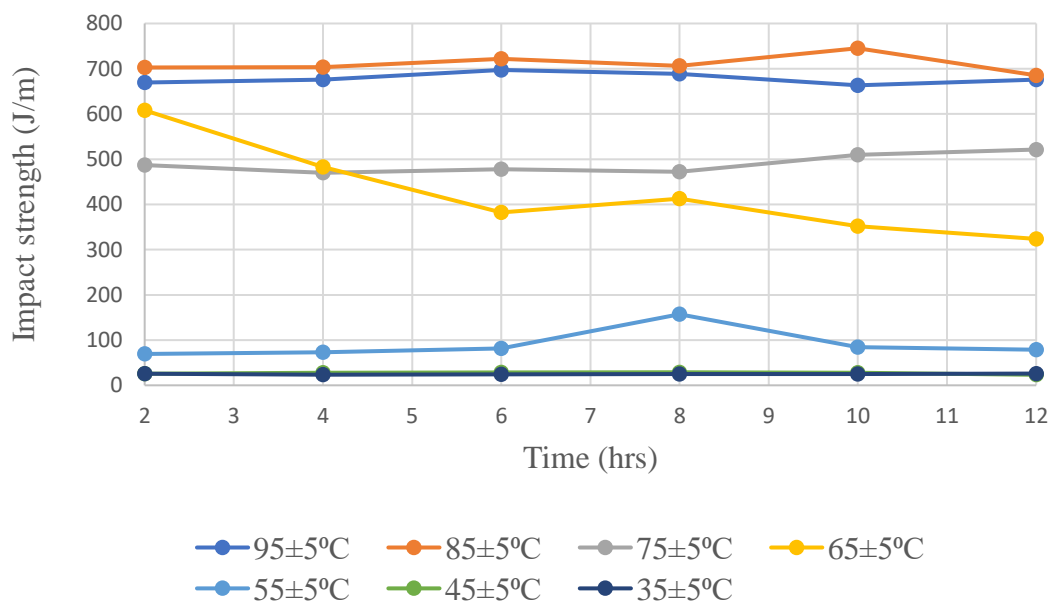

Figure 12. Graphical representation of all impacted specimens at seven different temperatures under Oven heating



#### 4.4 Heating and Aging Effect on Impact Strength of PLA

##### 95±5°C

The sample S0 had an impact strength of 48 J/m at 0.05 hours. The impact strength of samples S0 through S5 are shown in the Table 21. As heat treatment time increased from 1 hours to 2 hours, the impact strength of the samples tested immediately after heat treatment increased with increase in heat treatment time. Whereas, the impact strength of samples aged after heat treatment decreased with an increase in aging time.

Table 21. Effect of 100% humidity and aging on impact properties of PLA at 95±5°C

No.	S (deg)	Friction Loss (J)	wt. (kg)	wt. type	Thickness (mm)	t (hrs.)	IE (J)	IE (J/m)
S0	137.551	0.244634	1.797	L	10.36	0.05	0.494	48
S1	66.715	0.244634	1.797	L	10.36	1	7.026	678
S2	63.115	0.244634	1.797	L	10.36	2	7.354	710
S3	129.135	0.244634	1.797	L	10.36	4	1.109	107
S4	129.749	0.244634	1.797	L	10.36	6	1.062	102
S5	129.749	0.244634	1.797	L	10.36	8	1.062	102

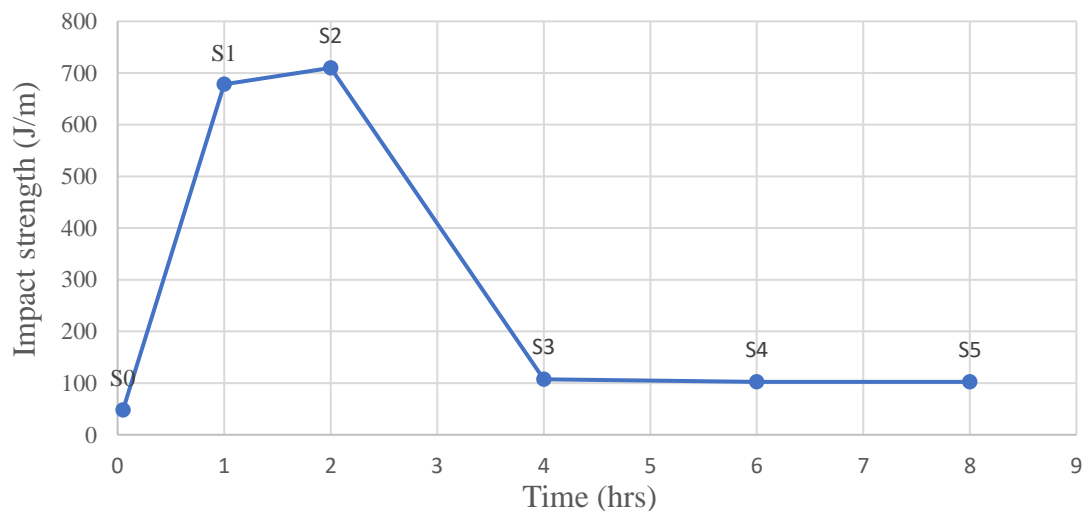

Figure 13. Graphical representation of sample's impact strength under 100% humidity at

95±5° C and aging under room temperature

From the Figure 13, it is observed that an increase in heat treatment time results in a sharp increase in impact strength between S0 and S1 and gradual increase between S1 and S2. Whereas the samples left for aging i.e. S3, S4 and S5 shown relatively low impact strength.

### 85±5°C

The sample S0 had an impact strength of 48 J/m at 0.05 hours. The impact strength of samples S0 through S5 are shown in the Table 22. As heat treatment time increased from 1 hours to 4 hours the impact strength of the samples tested immediately after heat treatment increased with an increase in heat treatment time. Whereas, the impact strength of samples left for aging after heat treatment decreased with an increase in aging time.

Table 22. Effect of 100% humidity and aging on impact properties of PLA at 85±5°C

No.	S (deg)	Friction		wt. type	Thickness (mm)	t (hrs.)	IE (J)	IE (J/m)
		Loss (J)	wt. (kg)					
S0	137.551	0.244634	1.797	L	10.36	0.05	0.494	48
S1	75.131	0.244634	1.797	L	10.36	1	6.227	601
S2	68.446	0.244634	1.797	L	10.36	3	6.865	663
S3	65.141	0.244634	1.797	L	10.36	4	7.171	692
S4	130.45	0.244634	1.797	L	10.36	6	1.008	97
S5	131.239	0.244634	1.797	L	10.36	8	0.948	91

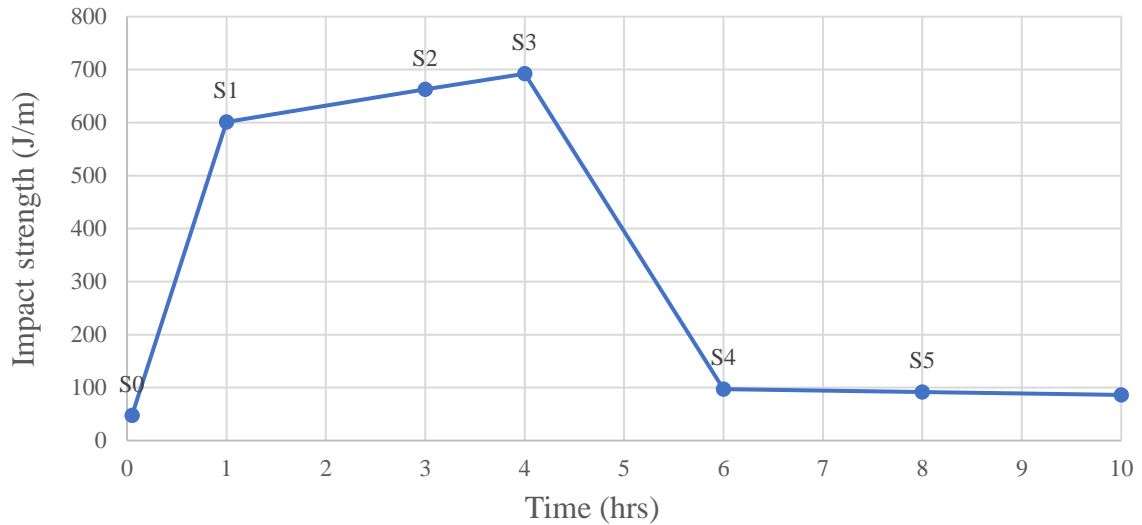

Figure 14. Graphical representation of sample's impact strength under 100% humidity at  $85 \pm 5^\circ \text{C}$  and aging under room temperature

From the Figure 14, it is observed that with an increase in heat treatment time, there is a sharp increase in impact strength between S0 and S1 and a gradual increase between S1 and S3. Whereas the samples left for aging i.e. S4 and S5 show a relatively low impact strength.

#### **$75 \pm 5^\circ \text{C}$**

The sample S0 had an impact strength of 48 J/m at 0.05 hours. The impact strength of samples S0 through S5 are shown in Table 23. As heat treatment time increased from 1 hours to 4 hours the impact strength of the samples tested immediately after heat treatment increased with an increase in heat treatment time. Whereas, the impact strength of samples left for aging after heat treatment decreased with an increase in aging time.

Table 23. Effect of 100% humidity and aging on impact properties of PLA at  $75\pm 5^{\circ}\text{C}$ 

No.	S (deg)	Friction Loss (J)	wt. (kg)	wt. type	Thickness (mm)	t (hrs.)	IE (J)	IE (J/m )
S0	137.551	0.244634	1.797	L	10.36	0.05	0.494	48
S1	70.836	0.244634	1.797	L	10.36	1	6.640	641
S2	63.131	0.244634	1.797	L	10.36	3	7.353	710
S3	59.957	0.244634	1.797	L	10.36	4	7.634	737
S4	129.135	0.244634	1.797	L	10.36	6	1.109	107
S5	130.239	0.244634	1.797	L	10.36	8	1.024	99

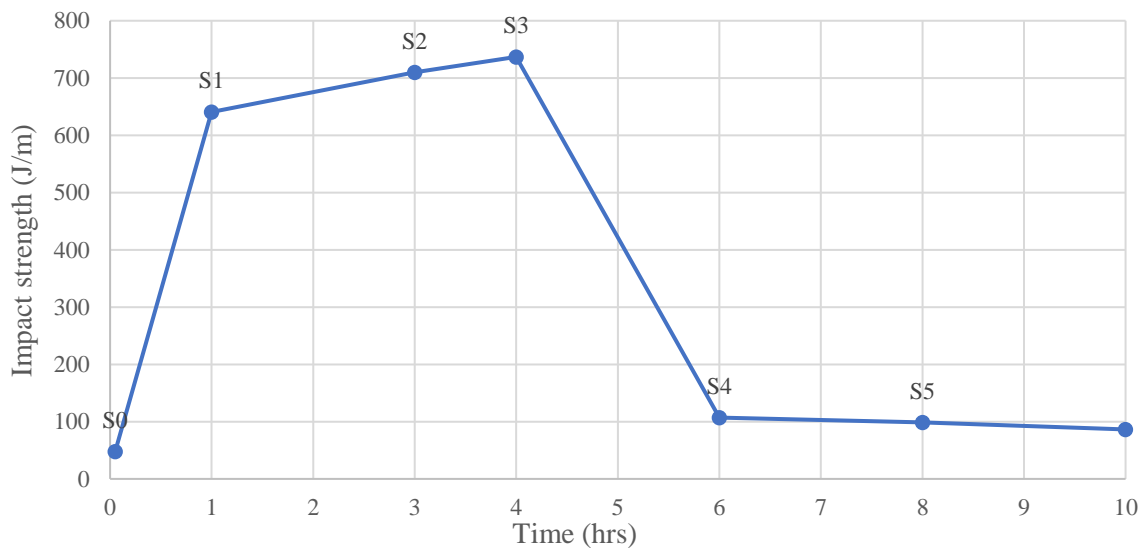

Figure 15. Graphical representation of sample's impact strength under 100% humidity at  $75\pm 5^{\circ}\text{C}$  and aging under room temperature

From Figure 15, it is observed that an increase in heat treatment time results in a sharp increase in impact strength between S0 and S1 and gradual increase between S1 and S3. Whereas the samples left for aging i.e. S4 and S5 showed relatively low impact strength

## Chapter 5: Discussion of results

### 5.1 Optimization of Print Process

Generally, PLA filament was printed with the optimal printing temperature range from 185°C- 215°C and bed temperature between 40-50°C (PLA 3D Printing Filament - Everything You Need to Know 2019). To better understand the optimal temperature of the nozzle and bed, initially PLA samples were printed with the nozzle temperature of 185°C and the platform (Bed) temperature of 40°C. The sample were printed at a room temperature of 23°C ± 2°C. The end parts of sample did not have a smooth finish. Voids and surface warping were observed in the 3D printed PLA parts. The 3D printer was located below a cooling vent and hence this could be the reason for warping of printed parts. The surface irregularity was eliminated by changing the position of the printer. Voids in the end of samples were eliminated by changing the nozzle temperature and bed temperature. With the increase of nozzle temperature from 185°C to 215°C and bed temperature from 40°C to 50°C, the number of voids was reduced considerably (Table 1). Samples printed with the nozzle temperature of 215°C and bed temperature of 50°C completed printing without visible voids. The same temperature specifications were used for 3D printing of all the test samples.

Benwood et al. (2018) investigated the effect on mechanical properties of PLA by changing the thermal conditions of the printing process. In his study, samples were printed with different bed and melting temperatures and later impact tested for strength. Surprisingly, they reported that samples printed with high bed and melting temperatures showed a low porosity but improved density characteristics and crystallinity changes. The impact strength of the samples printed with high melt and bed temperatures showed high impact

strengths. So, this confirms print parameters also play an important role in optimization of mechanical properties of PLA

Table 24. Shows the severity of voids at different nozzle and platform temperatures.

Trial	Nozzle Temperature (185°C-215°C)	Platform temperature (40°C-50°C)	Severity of Voids
1	185°C	40°C	
2	190°C	45°C	
3	195°C	45°C	
4	200°C	45°C	
5	205°C	45°C	
6	210°C	50°C	
7	215°C	50°C	

Some studies focusing on improving the impact strength of PLA by optimization of print parameters are as follows. A study was done by Lu Wang et al. (2017) to improve the impact strength of PLA in Fused deposition modeling (FDM). In that study, two printing parameters, layer height (0.2mm and 0.4mm) and platform temperature (30 and 160 °C) were investigated for their effect on the impact strength of printed PLA. According to their fused layer model, a proper selection of printing parameters can produce a high impact

strength when compared to conventional molding processes. Scanning electron Microscopy (SEM) showed a layer height of 0.2mm and platform temperature of 160°C produced fewer voids and large impact resistance. Additionally, Size exclusion Chromatography (SEC) was applied to study the molecular weight change of PLA observed from different processes. It was shown that degradation as evidenced by molecular weight changes is higher in injected molded PLA when compared with printed PLA.

Tahseen. F.D and Farhad M.H (Abbas and Othman 2018) investigated the effect of layer thickness on the impact properties of 3D printed PLA. In that research, samples were printed with fused deposition technique and different layer thicknesses; 0.1mm, 0.15mm, 0.2mm, 0.25mm, and 0.3mm. These samples were tested for impact properties by the standard Izod method. They reported that the smaller the layer thickness, the higher the impact strength with the lowest impact strength being recorded for the sample with the highest layer thickness i.e., 0.3mm. The time taken to build the sample with 0.1mm layer thickness was higher when compared to the sample printed with 0.3mm thickness.

## **5.2 Effect of temperature and time on impact strength of PLA**

Niaoukis et al. (2010) studied the tensile strength of PLA at 80% humidity at different temperatures and found that there is a decrease in tensile strength with an increase in temperature or time. In the current study, several PLA samples were impacted tested at 100% humidity for different temperatures ranging from 25°C to 95°C and these results correlated with those obtained by Niaoukis et al. (2010). There is a good correlation between that study and the results obtained in the current study, i.e., at higher temperatures (75, 85 and 95±5°C) a similar trend was observed. The impact strength of PLA samples

decreased with an increase in time from 2 hours to 12 hours except for those samples treated for 2 hours of time at  $75\pm 5^{\circ}\text{C}$  and  $85\pm 5^{\circ}\text{C}$ . At lower temperatures  $35\pm 5^{\circ}\text{C}$  and  $45\pm 5^{\circ}\text{C}$ , an opposite trend was observed, i.e., the impact strength of PLA samples increased with time from 2 hours to 12 hours except for samples tested at  $45^{\circ}\text{C}$  after 12 hours. For the temperatures  $55$  and  $65^{\circ}\text{C}$ , the impact strength increased up to 8 hours and then decreased. At room temperature, the impact strength remains constant from 2 to 12 hours. In the Niaoukis et al. (2010) study, the tensile tested samples were left for aging for a minimum of 30 days to a maximum of 130 days at different temperatures. However, in the current study, the impact tested samples were left for aging for a maximum period of 12 hours under 100% humidity.

### **5.3 Ductile vs Brittle (Break Characteristic)**

The stress-strain behavior of a polymer greatly depends on the temperature. At very low temperatures especially those well below the glass transition temperature, brittle failure is observed as a break at low strain rate at the maximum stress (Polymerdatabase 2015). If the temperature is increased, a polymeric material changes from brittle (crazing) to ductile (yielding) behavior in deformation and fracture. This temperature is called the brittle-ductile transition temperature.



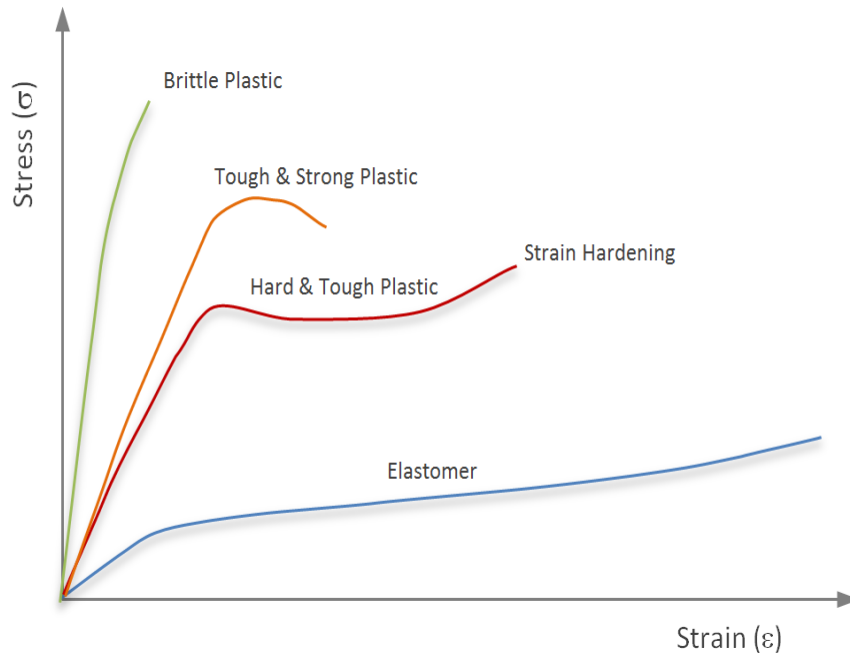

Figure 16. Stress and strain behavior of polymers retrieved from polymer properties database (2015)

Plastic material changes its mechanical behavior suddenly with temperature exceeding glass transition temperature. In this region, the ultimate ductility can be very high at low loads and the sample can elongate several hundred percent before failure occurs. The behavior before the break will depend on crosslinking and entanglement density. Materials will undergo elastic deformation before breaking when lightly cross linked and polymers without substantial cross linking will undergo viscoelastic deformation.

Niaoungis et al. (2010) studied the effect of temperature and aging on ductility and brittleness of PLA samples at 80% humidity at different temperatures. Sample showing the highest strain % at break had maximum ductile behavior and the samples which exhibited the lowest strain % at break had shown maximum brittle nature and this can be observed from the stress-strain curve in Figure 16.

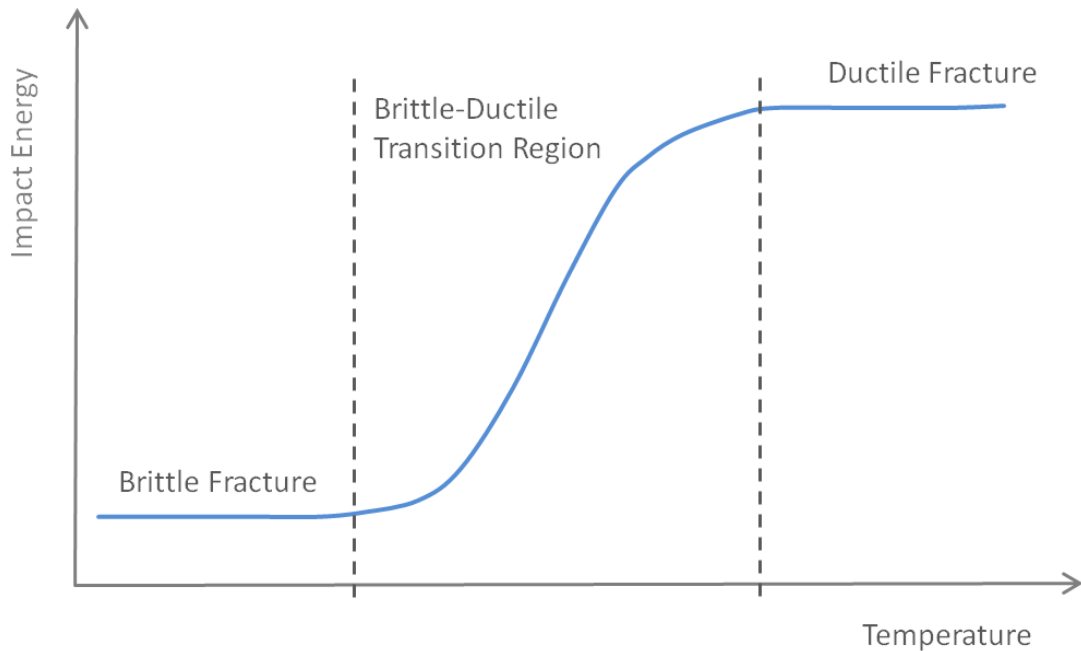

Figure 17. Shows ductility vs brittle failure behavior under increase in temperature and impact energy

The impact energy of a ductile fracture is much larger than the energy of a brittle fracture because ductile materials undergo strong plastic deformation before and during fracture which absorbs much more impact energy. (Polymer database 2015).

From Figure 17, we can observe at high temperatures, the impact energy is high, and samples show ductile nature. Whereas, brittle samples require less impact energy to break at low temperatures.

From the 100% humidity test results at  $95 \pm 5^\circ\text{C}$ , the samples which were impact tested for two hours of heat treatment showed a high impact strength and high ductility. Whereas the samples which were tested after twelve hours of heat treatment showed considerably lower impact strength and high brittleness.

In the current research, the samples ductile and brittle transition can be observed by fracture failure surfaces. A ductile sample has a fibrous failure surface whereas the brittle samples had granular fracture surfaces (Polymerdatabase 2015). The samples fracture failure surfaces were divided into 4 types by visual observation.

1. Complete failure (CF)
2. Hinge failure (HF)
3. Partial failure (PF)
4. Unbroken (UB)

Figure 18 shows the arrangement of an impact specimen between the vices and the failure of an impact specimen. Figure 19 shows an image of all the impact tested samples together shows different types of failure surfaces. The sample and type of failure is shown in the Table 25.

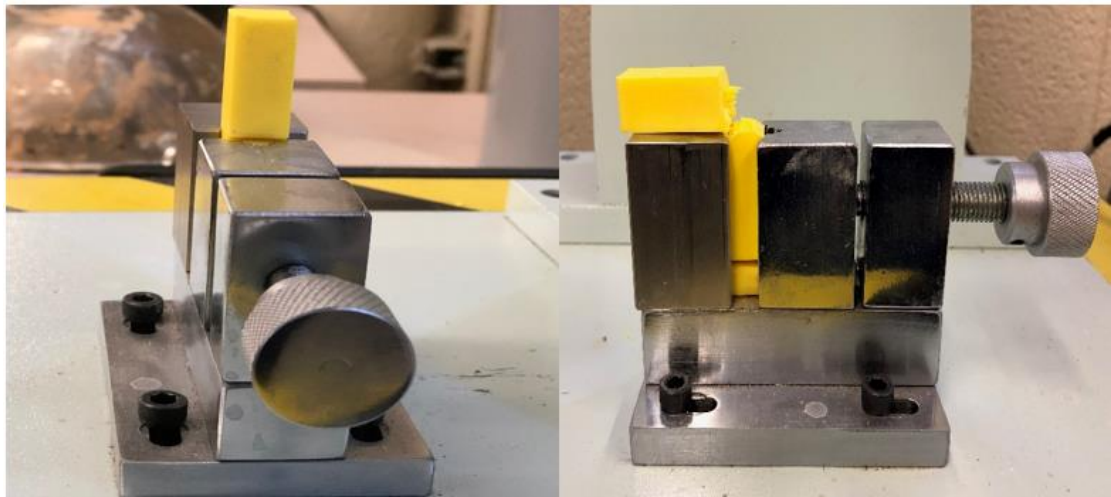

Figure 18. Arrangement of impact specimen between the vices (left) and a hinge failure (right) of specimen



Figure 19.Types of failure of twelve impacted specimens

Table 25. Sample and type of failure

SAMPLE	FAILURE TYPE
S1	UB
S2	UB
S3	PF
S4	CF
S5	HF
S6	UB
S7	CF
S8	CF
S9	CF
S10	HF
S11	HF
S12	CF

From chapter 4.4 results, the samples tested at  $95\pm 5^{\circ}\text{C}$  temperature for 2 hours exhibited the highest impact strength and the type of failure surface was UB. The specimens which were tested after heating for 2 hours under 100% humidity condition and cooling for 2 hours at room temperature showed hinge failure. Samples that were tested at high aging times, showed low impact strength and exhibited complete failures. From this, we can conclude that, at  $95\pm 5^{\circ}\text{C}$ , the samples ductile behavior is decreasing with the increase of aging time and becoming brittle as aging time increases until it reaches constant. At  $75\pm 5^{\circ}\text{C}$  and  $85\pm 5^{\circ}\text{C}$  temperatures, the same trend was observed, with an increase in aging time.

## Chapter 6: Conclusion

This study presents an experimental investigation and analysis of impact properties of 3D printed PLA samples at various environmental conditions. Based on the experimental and analytical results the following conclusions were drawn

From the non- heat treatment test, a linear decrease in impact strength was observed with the increase of time for the time tested.

From the 100% humidity test, the impact strength of the PLA samples increased with an increase in treatment temperature. The impact strength of the PLA samples increased with an increase in heat treatment time at low temperature. At high temperatures, the PLA samples achieved the highest impact strength within a short span of heat treatment time and the impact strength of the sample decreased with an increase in heat treatment time.

From the low humidity test, it was observed that PLA samples have shown nearly similar impact strengths for the same temperature for different heating times. Samples exhibited relatively high impact strength when heat treated at temperatures above the glass transition temperature (60°C).

From heating and aging effects testing, the samples which were tested immediately after heat treatment showed high impact strength, whereas the samples impact tested after aging at room temperature post heat treatment have shown considerably lower impact strength. This concludes, the impact strength of PLA is not sustained at the elevated levels with aging of samples although the ultimate strength is higher than non-heat-treated samples.

## Chapter 7: Recommendations of Future Research

The following recommendation for future research is made based on the results of this study.

Heat treating PLA specimens made with the addition of reinforcing fibers, micro or nanofillers, or selected additives.

The impact strength of PLA can be further studied by changing the printing parameters such as infill density and printing orientation.

Annealing the heat-treated samples in a water bath instead of room temperature air.

## References

ASTM D256-10. Standard Test Methods for Determining the Izod Pendulum Impact Resistance of Plastics. 2010.

Abbas, T., and Othman, F.M. (2018). Influence of Layer Thickness on Impact Property of 3D-Printed PLA. *International Research Journal of Engineering and Technology*, 05(02). <https://www.irjet.net/archives/V5/i2/IRJET-V5I201.pdf>

Benwood, C., Anstey, A., Andrzejewski, J., Misra, M., & Mohanty, A. K. (2018). Improving the Impact Strength and Heat Resistance of 3D Printed Models: Structure, Property, and Processing Correlation ships during Fused Deposition Modeling (FDM) of Poly (Lactic Acid). *ACS Omega*, 3(4), 4400-4411. doi:10.1021/acsomega.8b00129

Copinnet, A., Bertrand, C., Govindin, S., Coma, V., & Couturier, Y. (2004). Effects of ultraviolet light (315 nm), temperature and relative humidity on the degradation of polylactic acid plastic films. *Chemosphere*, 55(5), 763-773. <https://dx.doi.org/10.1016/j.chemosphere.2003.11.038>

Crow. Polymer Properties Database. Retrieved from <https://polymerdatabase.com/polymer-physics/Stress-Strain-Behavior.html> (accessed on March 02, 2019).

Classification of Polymers: The 5 Distinct Classes of Polymers. (2018, March 23). Retrieved from <https://www.toppr.com/bytes/classification-of-polymers/>

Creator Pro 3D Printer. (n.d.). Retrieved from <http://www.flashforge.com/creator-pro-3d-printer/> (accessed on October 15, 2019).

Es-Said, O. S., Foyos, J., Noorani, R., Mendelson, M., Marloth, R., & Pregger, B. A. (2000). Effect of Layer Orientation on Mechanical Properties of Rapid Prototyped Samples. *Materials and Manufacturing Processes*, 15(1), 107-122. <http://dx.doi.org/10.1080/10426910008912976>

Ho, K.L.G., Pometto, A.L. & Hinz, P.N. (1999) Effects of Temperature and Relative Humidity on Polylactic Acid Plastic Degradation. *Journal of Polymers and the Environment*. 7(2), 83-92. <https://doi.org/10.1023/A:1021808317416>

Honrubia, M. (2018). 3D printing and its application in the construction industry. Retrieved from <https://www.ennomotive.com/3d-printing-and-its-application-in-the-construction-industry>

History of 3D Printing. (2018, April 19). Retrieved from <http://me3d.com.au/2018/history-of-3d-printing/> (accessed on February 15, 2019).



Jiao, Y., Liu, H., Wang, X., Zhang, Y., Luo, G., & Gong, Y. (2014). "Temperature Effect on Mechanical Properties and Damage Identification of Concrete Structure." *Advances in Materials Science and Engineering*, 1-10 <http://dx.doi:10.1155/2014/191360>.

Kidwell, J. (n.d.). Best Practices and Applications of 3D Printing in the Construction Industry. Retrieved from <https://digitalcommons.calpoly.edu/cmsp/79/> (accessed on February 15, 2019).

Liu, H., & Zhang, J. (2011). Research progress in toughening modification of poly (lactic acid). *Journal of Polymer Science Part B: Polymer Physics*, 49(15), 1051-1083. <http://dx.doi:10.1002/polb.22283>

Likittanaprasong, N., Seadan, M., & Suttiruengwong, S. (2015). Impact property enhancement of poly (lactic acid) with different flexible copolymers. *IOP Conference Series: Materials Science and Engineering*, 87, 012069. <http://dx.doi:10.1088/1757-899x/87/1/012069>

Make It From (2015) Polylactic Acid (PLA, Polylactide), from: <http://www.makeitfrom.com/materialproperties/PolylacticAcidPLAPolylactide> (Accessed on July 2018).

Mohamed, S.H. (2013). Impact resistance and the effect of temperature. Retrieved From <https://www.scribd.com/document/220429322/Impact-Resistance-and-the-Effect-of-Temperature>

Marr, B. (2018, August 23). 7 Amazing Real-World Examples Of 3D Printing In 2018. Retrieved from <https://www.forbes.com/sites/bernardmarr/2018/08/22/7-amazing-real-world-examples-of-3d-printing-in-2018/#272b84f16585>

Mogoşanu, G. D., & Grumezescu, A. M. (2014). Natural and synthetic polymers for wounds and burns dressing. *International Journal of Pharmaceutics*, 463(2), 127-136. <http://dx.doi:10.1016/j.ijpharm.2013.12.015>

Niaounakis, M., Kontou, E., & Xanthis, M. (2010). Effects of aging on the thermomechanical properties of poly (lactic acid). *Journal of Applied Polymer Science*, 119(1), 472-481. <https://dx.doi:10.1002/app.32644>

Narendra, A., & Ramesh, D., R. (2015). "Studies on Impact Strength of Concrete with Nano-Materials at Elevated Temperatures." *International Journal for Scientific and Research & Development*, 3(09).

Oksman, K., Skrifvars, M., & Selin, J. (2003). Natural fibres as reinforcement in polylactic acid (PLA) composites. *Composites Science and Technology*, 63(9), 1317-1324. [http://dx.doi:10.1016/s0266-3538\(03\)00103-9](http://dx.doi:10.1016/s0266-3538(03)00103-9)

PLA 3D Printing Filament - Everything You Need to Know (2019). Retrieved September 5, 2017, from: <https://rigid.ink/blogs/news/3d-printing-basics-how-to-get-the-best-results-with-pla-filament>

PLA Fibers. (2015). Retrieved from <http://polymerdatabase.com/Fibers/PLA.html> (accessed on March 02, 2019).

Shoukry, S. N., William, G. W., Downie, B., & Riad, M. Y. (2011). "Effect of moisture and temperature on the mechanical properties of concrete." *Construction and Building Materials*, 25(2), 688-696. <http://dx.doi:10.1016/j.conbuildmat.2010.07.020>

Sandeep., & Chhabra Deepak. "Comparison and Analysis of different 3D printing techniques." *International Journal of Latest Trends in Engineering and Technology* Vol 8: pp.264-272. DOI <http://dx.doi.org/10.21172/1.841.44>

Vialva, T., Iftikhar, U., & Jackson, B. (2019, March 13). The Free Beginner's Guide. Retrieved from <https://3dprintingindustry.com/3d-printing-basics-free-beginners-guide#02-history>

[www.dailysabah.com](http://www.dailysabah.com). (2018, June 04). 10 suggestions to reduce plastic use. Retrieved from <https://www.dailysabah.com/environment/2018/06/05/10-suggestions-to-reduce-plastic-use> (accessed on February 20, 2019).

Wang, L., Gramlich, W. M., & Gardner, D. J. (2017). Improving the impact strength of Poly (lactic acid) (PLA) in fused layer modeling (FLM). *Polymer*, 114, 242-248. <http://dx.doi:10.1016/j.polymer.2017.03.011>

Weiner, H. (2019). Fused Filament Fabrication/FFF – 3D Printing Simply Explained. Retrieved from <https://all3dp.com/2/fused-filament-fabrication-fff-3d-printing-simply-explained/> (accessed on November 15, 2018).

3D Printing Materials Guide - Comparing the 13 Best Filaments. Retrieved from <https://www.simplify3d.com/support/materials-guide/> (accessed on October 12, 2018).