

## Pre-print

# Analysis of the efficiency of wind turbine gearboxes using the temperature variable

Sequeira, C.<sup>1\*</sup>, Pacheco, A.<sup>1</sup>, Galego, Pedro M.<sup>2</sup>, Gorbeña, E.<sup>1</sup>

<sup>1</sup>MORE-CIMA/Universidade do Algarve, Edifício 7, Campus de Gambelas Faro, 8005-139, Portugal,  
[cdsequeira@ualg.pt](mailto:cdsequeira@ualg.pt), [ampacheco@ualg.pt](mailto:ampacheco@ualg.pt), [egeisenmann@ualg.pt](mailto:egeisenmann@ualg.pt)

<sup>2</sup>Instituto Superior de Engenharia, Universidade do Algarve, Campus da Penha, 8005-139 Portugal,  
[pedromiguelgalego@hotmail.com](mailto:pedromiguelgalego@hotmail.com)

Doi: <https://doi.org/10.1016/j.renene.2018.12.040>

## Abstract

The aim of this paper is to evaluate how lubricant selection affects gearbox efficiency and overall energy production by analysing real data from wind farms, monitored and controlled by a Supervisory Control and Data Acquisition (SCADA system). The turbines analysed worked with two or more oil types for the same amount of hours, which allowed to establish relations between the active power curves and wind velocity; oil temperature inside gearboxes and wind velocity; and oil temperature inside gearboxes and active power production. The results of this study evidenced a direct relation between oil characteristics and energy efficiency i.e. gearboxes working with mineral oil perform better than gearboxes working with synthetic oils. Those differences can be significant in terms of active power production. Also, it was observed oil degradation as function of temperature increase, with changes on viscosity, which reveals that temperature behaviour along the active power curve is strongly related to oil' characteristics.

**Keywords:** Wind Turbine, Gearbox, Oil temperature, SCADA

25 **1. Introduction**

26 The rapid growth in wind power needs fast improvements in technology. Up until now,  
27 the industry has seen steady growth and it can be expected that growth show similartrend  
28 in the future. The market forecasts that by 2018 the wind energy cumulative gigawatts  
29 (GW) will be 43% higher than of 2015 's GW [1]. Given these numbers and the high  
30 initial investment needed to build a wind farm, we ask ourselves: "Can we not produce  
31 more energy with the same amount of wind turbines?"; "it is possible to increase the  
32 efficiency and performance of each wind turbine within an existent wind farm?"

33 Monitoring the state of any industrial process is nowadays an indispensable tool. Early  
34 failure detection prevents major faults from occurring, allowing operation and  
35 maintenance departments to have accurate information about the machine's operating  
36 state. Also, performance improvement is significant when there are efficient maintenance  
37 and adequate repair strategies. It is today acknowledge that improvement of the  
38 operations and maintenance (O&M) practices can lead to a reduction of 21% and 11% of  
39 the life-cycle costs of offshore and inland wind farms [2]. Therefore, studies of novel  
40 methods serving the wind farm O&M procedures are extremely important and valuable.

41 With the development of technology wind turbines have increased in size. Consequently,  
42 this has also led to a situation where components failures result in high costs. The most  
43 important components, which will define the effective production of energy from a wind  
44 turbine, are the gearbox and electrical generator. Wind turbine gearboxes handle several  
45 megawatt of power, which means that a small efficiency increase can produce energy  
46 useful for several more households [3]. Thus, to make wind energy competitive is  
47 fundamental to increase gearbox efficiency, availability and reliability, for which is  
48 important to quantify the main sources of power loss. Lubrication is a significant issue in  
49 gearbox operation since the main power losses sources are friction loss between the  
50 meshing teeth [4-6]. As such, monitoring the gearbox oil temperature can be the most  
51 effective way to reduce the operational and maintenance costs of these systems and  
52 increase their reliability. With good data acquisition (i.e. vibrations and temperature)  
53 faults can be detected while components are operating which can lead to the  
54 implementation of appropriate and timely actions to prevent damage or failure of the  
55 turbine' components [7].

56 Moreover, in order to reduce friction it is fundamental the oil selection to minimize wear  
57 on the gear teeth and bearings, allowing optimized behaviour under the external  
58 environmental conditions in which the turbine will operate [8]. As such, the selection of  
59 a lubricant with appropriate physical properties promotes small no-load losses, which also  
60 contributes to decrease the lubricant operating temperature [3,9]. No-load losses are  
61 directly related to lubricant viscosity and density, as well as immersion depth of the  
62 components on a sump-lubricated gearbox; while no-load rolling bearing losses depends  
63 on type and size, arrangement, lubricant viscosity and immersion depth [4]. In addition,  
64 transmission losses are primarily due to viscous friction of the gears and bearings turning  
65 in oil [10].

66 Intermittent operation, a common situation with wind turbines, can also have a significant  
67 impact on the life of a gearbox. When the turbine is not running, oil may drain away from  
68 the gears and bearings, resulting in insufficient lubrication when the turbine starts [10-  
69 12]. As well, under cold weather, the oil may have too high viscosity until the gearbox  
70 has warmed up. Turbines in such environments may benefit by having gearbox oil heaters  
71 since condensation of moisture may accelerate corrosion [13-17]. Over the last 2 decades  
72 many lessons have been learnt by the industry with the main goal of improving gearboxes  
73 reliability, since is one of the most expensive wind turbine sub-assemblies [18-23].

74 The gearbox reached thermal equilibrium when the operating temperature stabilizes, i.e.  
75 when the power dissipated inside the gearbox is equal to the heat evacuated from gearbox  
76 to the nacelle. The equilibrium temperature is dependent of the gearbox characteristics  
77 and of the lubricant properties. A lower stabilization temperature means higher efficiency,  
78 lower friction coefficient, smaller oil oxidation and longer oil life [24-25].

79 In general, and for wind industry practitioners, it is important to pay great attention to  
80 data farming issues. This means that more precise fault definition and more advanced  
81 fault-labelling systems need to be developed so that more informative and useful data can  
82 be collected. As result, producers will have access to better and more accurate diagnoses  
83 to evaluate the health status of their machines and it productivity [26]. The present paper  
84 is focus on the analysis of real data from 12 different wind farms, which are monitored  
85 and controlled by a Supervisory Control and Data Acquisition – the SCADA system. The  
86 system is composed 93 by sensors or actuators that enable the monitoring and control of  
87 geographically dispersed processes. It also allows communication between remote

88 stations and a control centre, providing important data and information for controlling the  
89 operating process of the power electrical system. The occurrence of disturbances triggers  
90 alarms, which warn operators that the system is in an anomalous situation, permitting  
91 operators to intervene from the control centre. The SCADA data analysis methods has  
92 been used recently to assess the importance of how wind turbines align in patterns to the  
93 wind direction. Revealing itself as useful tool to evaluate wake effects in a wind farm  
94 [27]. In present study, the SCADA data is analysed to assess the influence of the oil  
95 formulation on energy production, by analysing oil temperatures inside gearboxes (i.e.  
96 oil sump). The aim of the paper is to evaluate how lubricant selection affects gearbox  
97 efficiency, and its influence on energy production losses.

98

## 99 **2. Methods**

100 Gearbox oil pressure and oil filter status are related to the gearbox oil pump, the pressure,  
101 temperature and lubrication filters. Since temperature is a fundamental parameter in the  
102 dynamic behaviour of the oil, conditioning gearbox efficiency and overall wind turbine  
103 performance, the SCADA system is programmed to acquire data every 10 minutes of the  
104 following parameters: outdoor temperature, temperature of the nacelle, main bearing  
105 temperature, gearbox bearing temperature and gearbox oil temperature. The optimum  
106 temperature for gearbox oil ranges between 45° C and 65° C. This optimum is ensured by  
107 the cooling system (Figure 1). The temperature sensors work as follows: (i) if the  
108 temperature at the opening of the thermostatic valve is ~45° C the oil circulates through  
109 the heat exchangers, but the fans are not working; (ii) if temperature reaches 62° C both  
110 fans of the two exchangers start working; (iii) the fans will turn off when the temperature  
111 falls 5° C (i.e. 57° C at the opening of the thermostatic valve); (iv) the temperature to drive  
112 the 2nd 120 speed of the mechanical pump is 58° C; and (v) the 2nd 121 pump shuts off  
113 when oil temperature reaches again the 48° C. Periodic oil samples are collected on wind  
114 turbine gearboxes (i.e. every six months) to assess the state of the oil, as well as to check  
115 for signs of internal wear. Thus, if a value is over a certain maximum, the sampling  
116 strategy is changed to monitor a given component preventing its failure.

117 Data such as rotational speed, power output, temperature 126 and efficiency from the last  
118 6 years was analysed in which regards oil changes and its effect on performance. The  
119 three types of oils (A, B and C, hereafter) are within the same viscosity grade (e.g. ISO

120 VG 320), and expected to have a viscosity of  $\sim 320$  cSt at  $40^\circ\text{C}$  (Table 1). In order to  
121 compare the influence of using different oils inside gearboxes, the SCADA data was first  
122 filter to select turbines which: (1) worked with more than 1 or 2 types of oils inside the  
123 gearbox; (2) the same amount of working hours; and (3) never had it gearbox replaced.  
124 After these restrictions, the sample data reports to four wind turbines located in the Freita  
125 Wind Park, North of Portugal (Figure 2, Table 2). The park has 18.4 MW of installed  
126 power distributed for 8 Nordex N90/2300 turbines and is property of Iberwind  
127 ([www.iberwind.com](http://www.iberwind.com)). The annual estimated energy production of these devices is 40  
128 GWh, traducing on a reduction of 26.637 ton CO<sub>2</sub> emissions. The collected data was  
129 cleaned to ensure that only data obtained during normal operation of the turbine was used  
130 i.e. values were excluded from the database under the following circumstances: (1) wind  
131 speed is out of the operating range; (2) wind turbine cannot operate because of a fault  
132 condition; and (3) turbine is manually shut down or in a test or maintenance operating  
133 mode. The filtered datasets were than analysed to evaluate wind energy production  
134 efficiency depending of the type of oil used for different periods, applying bins method  
135 [28]. The method is a data reduction procedure that groups test data for a certain  
136 parameter into wind speed intervals (bins). These interval values are created on the x-  
137 axis, y-axis, or both axis (e.g. wind speed versus oil temperature; oil temperature versus  
138 active power), by calculating the mean of these intervals for both x and y values. For each  
139 bin the number of data sets or samples and their sum are recorded, and the average  
140 parameter value within each bin is calculated. In particular, the mean values of the  
141 normalized wind speed, gearbox oil temperature and active power were determined using  
142 interval bins of 0.5 m/s,  $1^\circ\text{C}$  and 1 kW, respectively.

143

### 144 3. Results

145 Figure 3 shows the oil temperatures changes as function of wind speed for the three  
146 analysed oil types before applying the bin method. It can be observed the high number of  
147 observations from the SCADA dataset before applying the bin method. Figure 4 shows  
148 the results of the bin method for the four analysed wind turbine gearboxes (Wtg) and for  
149 the three different oil types (Table 1) i.e. active 159 power curves as a function of velocity  
150 (A); oil temperature inside gearboxes as a function of velocity (B); and oil temperature  
151 inside gearboxes as a function of active power production (C). As it can be observed,

152 several changes occur on each pair of analyse parameters: as the wind turbine rotate  
153 different powers curve are obtained using different oils types (Figure 4A), affecting  
154 temperature inside the gearbox which tend to increase as turbine spins faster (Figure 4B).  
155 The best lubricant supply is when the gear mesh achieve the lower temperature (Figure  
156 4C).

157 In general, what Figure 4 shows is that for the same wind turbine at the same velocity  
158 there are different power/efficiency behaviours with similar oil types (B and C, both  
159 synthetic) and between an oil of different nature (type A, mineral). For a more detail  
160 analysis of the results, each turbine is then analysed independently having into  
161 consideration the type of oil and number of oil changes at the four wind turbine gearboxes  
162 (Table 2). This is done because two turbines had two oil changes (i.e. Wtg#3, Wtg#7),  
163 while the other two (i.e. Wtg#4, Wtg#6) were subjected to an additional one.

164 On Figure 5A it can be observed significant differences in the use of different types of  
165 oils on wind turbine gearbox 3 (Wtg#3). The gearbox oil was changed from type A to C  
166 i.e. mineral to synthetic. For the same wind turbine input speed, type C (synthetic) oil  
167 achieves higher temperatures than type A (mineral). The greatest differences in  
168 temperature are recorded within velocity range 5 to 12 m/s (Figure 5B). This corresponds  
169 to the beginning of the turbine's power curve, for which relates the largest number of  
170 observations. Analysing the active power produced in the higher temperature range  
171 (Figure 5C), i.e. between 50° C and 64° C, is observed that at an oil temperature of 58° C,  
172 gearbox with type C produces 1700 kW, while type A records approximately 1900 kW.  
173 It is also observed that, since the bins are "1° C", the range of values between 57 and 59°  
174 C corresponds to the highest number of observations i.e. approximately 5700 data for  
175 2000 kW of recorded power. Figure 5D shows differences of wind energy production  
176 within the range of speeds between 12 and 15 m/s, since the largest differences are within  
177 this range. It is observed that for an input velocity of 14 m/s, power differences between  
178 oil types are close to 20 kW.

179 The gearbox of turbine number 4 (Wtg#4, Figure 6) experienced three different oils types.  
180 Observing Figure 6A, it is possible to verify significant differences in temperature for the  
181 same input speed. Again, oil type C registered the higher temperatures confirming the  
182 results 192 obtained in turbine 3. Also, it is within the velocity range between 5 and 12  
183 m/s that the largest temperature differences are recorded (Figure 6B), which corresponds

184 to the largest number of observations. All registers are found to be above 45° C, which  
185 means that the oil is circulating in the heat exchanger and fans are not working. The data  
186 also shows large differences in temperature at low speeds, reaching a maximum of 8° C  
187 difference between two types of synthetic oils from different suppliers. Analysing the  
188 active power produced in the higher temperature range (Figure 6C), i.e. between 50° C  
189 and 62° C, results differ from turbine 3. At 54° C large differences in production can be  
190 observed between the three types, but with increasing temperatures, those differences  
191 disappear (i.e. 56.5° C bin). However, the continuous increase of temperature after this  
192 point leads again to changes on active power production, with deficits of 150 kW between  
193 oil type C and B and 200 kW between C and A, confirming that C type oil adversely  
194 affects energy production. The active power difference is then analysed within the 12 and  
195 24 m/s range (Figure 6D) where is observed that oil B presents the worst behaviour. This  
196 is particular evident for velocities over 19 m/s, despite presenting lower temperatures  
197 inside gearbox than type C. The major differences between type A and C on active power  
198 production are recorded around ~18 m/s (~40 kW difference), with type A registering  
199 better behaviour. However, at the maximum load area (i.e. input velocity ~20 m/s), the  
200 two oils present a very similar performance.

201 The gearbox of turbine number 6 (Wtg#6, Figure 7) also experienced three different oils  
202 types. Observing Figure 7A it is possible to verify significant differences in temperature  
203 for the same input wind velocity. But this time, on contrary to turbine 4, type A presents  
204 the higher temperatures inside gearbox for velocities over 10 m/s i.e. the beginning of  
205 nominal wind speed. For lower velocities type C presents higher temperatures (Figure  
206 7B). The largest production differences are recorded in the temperature range between  
207 52° C and 56° C i.e. before the exchanger fans are turned on. For example, for a  
208 production of 1500 kW, type B oil registers 52.5° C, type C ~54° C and type A ~56° C  
209 (Figure 7C). The oil temperature increase at ~58.5° C shows a production difference of  
210 500 kW, comparing oils type A and B; whereas differences between types A and C are  
211 ~50 kW. When analysing the active power difference within the 12 and 24 m/s range  
212 (Figure 7D) it can be observed that oil B presents again the worst overall behaviour.

213 Again, a very similar performance to Wtg#4 is registered 224 by comparing type A and  
214 C oils at the maximum load area of the turbine (i.e. 20 m/s). The gearbox of turbine 7  
215 experienced the use of two oils as turbine 3 (Figure 8). However, on the contrary of

216 turbine 3, type A achieves higher temperatures (Figure 8A), although those differences  
217 are only noticeable over 9 m/s (Figure 8B). In terms of production, the largest differences  
218 were recorded between 52° C and 57° C i.e. before the exchanger fans are turned on. For  
219 example, for a production of 1500 kW, oil type C registers 56° C, while type A oil  
220 registers 56,2° C. Highest differences of ~1° C are observed at 1000 kW. The increase of  
221 oil temperature over ~60° C has negligible effect on production. It is within the 12 and 24  
222 m/s range that highest differences are recorded on active power production, registering a  
223 maximum of plus 80 kW using type A oil at 18.2 m/s. But, overall, it is observed a very  
224 random behaviour between the two types. Once more, a very similar performance is  
225 registered at the maximum load area of the turbine (i.e. 20 m/s).

226 The analyses of oil samples collected on the different gearboxes confirm the above results  
227 (Table 3). The reference values of viscosity at 40° C (Table 1) for the three analysed oils  
228 are 320 cSt (type A), 320 cSt (type B) and 325 cSt (type C). Table 3 shows oil viscosity  
229 analysis after use, where it can be observed that the main changes on viscosity occur for  
230 type B and C oils. A maximum drop from 320 to 306.93 cSt is verified in oil type B on  
231 turbine 4. Because oil type A registers, in general, lower temperatures, it positively  
232 influences the non-change of viscosity at 40 °C.

233 The analysis of viscosity at 100° C reveals similar trends. The reference values of  
234 viscosity at 100° C (Table 1) for the three analysed oils are 24.1 cSt (type A), 35.1 cSt  
235 (type B) and 34.9 cSt (type C). Again, oil types B and C show increase degradation, with  
236 maximum changes occurring once again on type B oil, dropping from 35.1 to 31.38 cSt  
237 on turbine 6. Turbine 4 using type B oil also show a significant decrease (e.g. drop to  
238 32.14 cSt). Gearboxes using type C oil also show average decreases in the order of 3 cSt  
239 for all the turbines, except in turbine 7. However, turbine 7 was the one registering smaller  
240 differences of temperatures within all power operation range, but also smaller active  
241 power productions. Finally, the reference values of viscosity index (ASTM D 2270, Table  
242 1) for the three analysed oils are 96 (type A), 155 (type B) and 152 (type C). Major  
243 changes occur on gearbox of turbine 4 (Table 3) when using type B oil (drop from 155 to  
244 145) and type C oil (dr 256 op from 152 to 147). Negligible variations are showed on  
245 gearboxes using type A oil.

246

247



248 **4. Discussion**

249 Conditioning monitoring of gearbox systems is essential for mechanical system reliability  
250 management [29]. The today use of control systems such as SCADA able the access to a  
251 large amount of real time sensor data that can be used to prevent turbine failures and loss  
252 of efficiencies. Wind industry has been attempting to integrate SCADA and Conditioning  
253 Monitoring Systems (CMS) data to detect, diagnose and predict gearbox failures [30]. In  
254 that sense, oil and lubrication analysis is one among many important condition-  
255 monitoring approaches. Oil cleanness, viscosity and temperature give insight onto how  
256 the gearbox of any wind turbine is performing [31].

257 As an example, the today understanding of the mechanisms involved in pitting damage is  
258 still incomplete. This is partly due to large number of influencing factors that must be  
259 taken into account when studying Rolling Contact Fatigue. Indeed, literature underlines  
260 the impact of tribological parameters (loading, contact conditions and lubricant viscosity  
261 [32]) together with material parameters (steel composition, thermo-chemical treatment,  
262 surface roughness and residual stresses) and environmental parameters (temperature,  
263 humidity and lubricant chemistry [33]). But, amongst all these parameters, it is today well  
264 known that lubrication has a significant influence on Rolling Contact Fatigue and on  
265 pitting, in particular [34].

266 The results presented within this study are based on relations established between the  
267 active power curves and wind velocity; oil temperature inside gearboxes and wind  
268 velocity; and oil temperature inside gearboxes and active power production. The propose  
269 was to analyse how lubricant selection affects gearbox efficiency and overall energy  
270 production by analysing real data from wind farms.

271 Overall, results show that, most of the time, the temperature of mineral oil (type A) was  
272 lower than synthetic type oils (type B and C) for the same input velocities. Moreover,  
273 gearboxes working with type A oil performed better than gearboxes with type B or C oils.  
274 In some cases, performance differences achieved maximum of 200 kW in active  
275 production (e.g. #Wtg3 at 50° C, Figure 4 between Type A and C oils). There is a direct  
276 relation between oil quality inside gearboxes with energy efficiency. A maximum  
277 viscosity drop from 320 to 306.93 cSt was verified 288 in oil type B on turbine number  
278 4. Also, it is within the velocity range between 5 and 12 m/s that the largest temperature  
279 differences are recorded (Figure 6B), which corresponds to the largest number of

280 observations, meaning that this particular turbine has worked most of the time within this  
281 velocity range.

282 This is an important result since the most common gear failures (e.g. wear, scuffing,  
283 micropitting, pitting, etc) are influenced by the oil temperature in the lubrication system  
284 [35]. As a direct result of viscosity and additives decrease, several studies recorded pitting  
285 initiation, suggesting that lubricant additives can promote crack initiation by creating  
286 corrosion pits on steel surfaces [36, 37]. This because high temperatures are linked with  
287 a decrease of oil viscosity, producing thin lubricant films in the gear mesh which can  
288 affect performance. For example, the formation of a tribofilm from Zinc Dialkyl Dithio  
289 Phosphate (ZDDP), an anti-wear additive, can also promote crack initiation by preventing  
290 surfaces roughness reduction during running-in [38].

291 Higher temperatures can also lead to higher stress on the material composing the gearbox  
292 system e.g. for gear oils with additives higher temperatures correspond with higher  
293 chemical activity [35]. As an example, Nutakor et al [39] studied how the design  
294 parameters of planetary gear sets, bearings and lubricant properties influence the wind  
295 turbine performance. The authors concluded that decreasing oil viscosity by increasing  
296 oil temperature results in significant increase of bearing mechanical power losses inside  
297 of the gearbox on a planetary gear.

298 A gearbox is the component with more operational complexity and unit cost [40] and  
299 therefore vibration data and oil condition data has been used as the main input in  
300 behavioural models, neural networks, finite element modelling and statistical methods to  
301 predict gearbox failures. As an example, an approach for utilization of SCADA data for  
302 conditioning monitoring by means of artificial neural networks (ANN) was recently  
303 developed [41]. The approach was based on creating normal behaviour models for critical  
304 components by closely monitoring gearbox oil temperature, enabling to detect anomalous  
305 operations.

306 The present paper results add to the literature by presenting a clear case study of the  
307 relation between oil temperature and viscosity inside gearboxes with energy efficiency,  
308 which can be further use on ANN training to detect and prevent gearbox failures and  
309 optimize oil changing procedures. What appears clear from the results is that oil  
310 characteristics play a significant role on efficiency losses, strongly highlighted by the  
311 analysis of gearboxes that experienced the usage of the three different oil types. It is also

312 evident that mineral type A presents better performance than synthetic B and C types. An  
313 interesting fact is that although type B shows lower temperatures than type A, there is no  
314 positive effect on production. In fact, gearboxes working with oil type B show a drop on  
315 production between the 12 and 24 m/s range (e.g. #Wtg4, Figure 6). This type B oil is  
316 currently being withdrawn by the promotor from several turbines of different wind farms  
317 due to its poor performance; and because of the change in the viscosity index after 1 year  
318 of operation. The type C oil is the one presenting worse results, both in terms of  
319 temperature and active power production. This is a general trend at all the turbines that  
320 use this oil on their gearbox.

321 Another interesting aspect relates with the behavioural of the temperature using different  
322 oil types along the active power curve. Within the maximum turbine load area, comprised  
323 between the achievement of the rated output and cut-off speeds (i.e. wind over ~14 m/s),  
324 type A and C register a very similar behaviour. In fact, and observing gearbox of turbine  
325 6 (#Wtg6, Figure 7) working with oil type A, higher temperatures are recorded, which  
326 adversely affects performance. However, this result is not pronounced and is particular to  
327 this area of the power curve, restricted to fewer observations when compared to the data  
328 collected between the cut-in and rated power speed curve area, where type A oils always  
329 performs better.

330 Finally, the papers shows the capability of the proposed method on identifying different  
331 out-put power behaviours linked to oil temperature; and how to identify possible failures  
332 through temperature patterns. Oil temperature indicator can be used as a complement in  
333 Condition Monitoring Systems (CMS), which have been primarily focused on measuring  
334 the particle contamination in the lubricant fluid [42]. The close monitoring of this  
335 parameter by O&M managers will allow them to have sufficient time to plan up-tower  
336 repairs, by enabling them to reduce downtime, heavy equipment and logistics costs and,  
337 most important, preventing consequential failures in the entire gearbox system.

338

## 339 **5. Conclusions**

340 This paper analysed time-series of active power production and its relation to oil  
341 temperature inside gearboxes using SCADA 354 data, supported by regular viscosity oil  
342 analysis. The main conclusion from the result analysis are: (i) temperature inside  
343 gearboxes working with mineral oils were lower than synthetic oil types; (ii) there is a

344 direct relation between oil characteristics and energy efficiency i.e. gearboxes working  
345 with mineral oil perform better than gearboxes working with synthetic oils. Those  
346 differences are significant, achieving maximums of 200 kW differences on active power  
347 production; (iii) oils of similar nature (i.e. synthetic) present significant differences on  
348 performance, and even oils that resist to a temperature increase can show worst  
349 performance on active power production; and (iv) finally, degradation of oil was  
350 influenced by the temperature rise and viscosity decrease, showing that temperature  
351 behaviour along the active power curve is strongly related to oil type characteristics.

352 The close monitoring of these parameters inside the gearbox reveal vital in order to  
353 evaluate performance drops and can be used to detect mechanical faults as well as to  
354 extend the lifetime of the components. In order to increase the gearbox reliability it would  
355 be necessary to complement the above analysis with the study of the particle count (i.e.  
356 oil debris) and evaluate its effect on the overall energy production.

### 357 **Notation**

358  $T_{oil}$  - oil sump temperature (°C)

359

### 360 **Acknowledgements**

361 The paper is a contribution to the SCORE project, funded by the Portuguese Foundation  
362 for Science and Technology (FCT – PTDC/AAG-TEC/1710/2014) and MONITOR  
363 project, funded by the Atlantic Area (EAPA\_333/2016). André Pacheco was supported  
364 by the Portuguese Foundation for Science and Technology under the Portuguese  
365 Researchers' Programme 2014 entitled "Exploring new concepts for extracting energy  
366 from tides" (IF/00286/2014/CP1234). Eduardo G-Gorbeña has received funding for the  
367 OpTiCA project from the Marie Skłodowska-Curie Actions of the European Union's  
368 H2020-MSCA-IF-EF-RI-2016 / under REA grant agreement n° [748747]. The authors  
369 acknowledge IberWind for supplying all data measurements.

370

371

372

373 **References**

- 374 [1] WWEA - World Wind Energy Association, “WWEA half-year report: world wind  
375 capacity reached 456 GW,” 10 Outubro 2016. [Online]. Available:  
376 <http://www.wwindea.org/>. [Accessed 15.12.2017].
- 377 [2] Sheng, S. Prognostics and Health Management of Wind Turbines: Current Status  
378 and Future Opportunities, National Renewable Energy Laboratory, Golden, CO; 2015.  
379 <https://www.nrel.gov/docs/fy16osti/65605.pdf> [Accessed 31.08.2018].
- 380 [3] Fernandes, C. M., Blazquez, L., Sanesteban, J., Martins, R., Seabra, J. Energy  
381 efficiency tests in a full scale wind turbine gearbox. Tribology International, 2016.  
382 <https://doi.org/10.1016/j.triboint.2016.05.001>
- 383 [4] Fernandes CM., Marques PM., Martins RC., Seabra JH. Gearbox power loss. Part  
384 III: application to a parallel axis and a planetary gearbox. Tribol Int 2015;88 (0):317–  
385 26. <http://dx.doi.org/10.1016/j.triboint.2015.03.029>
- 386 [5] Marques, P.M., Camacho, R., Martins R.C., Seabra, J.H. Efficiency of a planetary  
387 multiplier gearbox: Influence of operating conditions and gear oil formulation.  
388 Tribology International 2015; 92: 272–280.  
389 <https://doi.org/10.1016/j.triboint.2015.06.018>
- 390 [6] Wang, Y., Song, G., Niu, W., Chen, Y. Influence of oil injection methods on the  
391 lubrication process of high speed spur gears. Tribology International 2018; 121: 180–  
392 189. <https://doi.org/10.1016/j.triboint.2018.01.062>
- 393 [7] Shanbra, S., Elashab, F., Elforjanic, M. Teixeira, J. Detection of natural crack in  
394 wind turbine gearbox. Renewable Energy, 2018; 118: 172-179.  
395 <https://doi.org/10.1016/j.renene.2017.10.104>
- 396 [8] Zhang, Y., Lu, W., Chu, F. Planet gear fault localization for wind turbine gearbox  
397 using acoustic emission signals. Renewable Energy 2017; 109: 449-460.  
398 <https://doi.org/10.1016/j.renene.2017.03.035>
- 399 [9] Lapira, E., Brisset, D., ardakani, H.D., Siegel, D., Lee, J. Wind turbine performance  
400 assessment using multi-regime modelling approach. Renewable Energy 2012; 45: 86-  
401 95. <https://doi:10.1016/j.renene.2012.02.018>

- 402 [10] Magalhães, L., Martins, R., Locateli, C., Seabra, J. Influence of tooth profile and  
403 oil formulation on gear power loss. *Tribology international*, 36th Leeds–Lyon  
404 symposium, vol. 43(10); 2010. p. 1861–71. Special issue: multi-facets of tribology.  
405 <http://dx.doi.org/10.1016/j.triboint.2009.10.001>
- 406 [11] Eschmann P, Hasbargen L, Weigand K. *Ball and roller bearings—theory, design,*  
407 *and application.* John Wiley and Sons; 1985.
- 408 [12] Marques PM, Fernandes CM, Martins RC, Seabra JH. Efficiency of a gearbox  
409 lubricated with wind turbine gear oils. *Tribology International* 2014; 71:7–16,  
410 <https://doi.org/10.1016/j.triboint.2013.10.017>
- 411 [13] Lin, Y., Tu, L., Liu, H., Li, W. Fault analysis of wind turbines in China. *Renewable*  
412 *and Sustainable Energy Reviews* 2016; 55: 482–490.  
413 <http://dx.doi.org/10.1016/j.rser.2015.10.149>
- 414 [14] Zhou KP. Research and design of fault diagnosis system for direct-driven  
415 synchronous wind turbine [Master's thesis]. Changsha: Central South Univ.; 2010.
- 416 [15] Ma HZ, Shi WJ, Han JD, Chen JN, Chen TT. Double-fed induction generator  
417 rotor fault diagnosis considering control strategies of rotor-side converters. *Proc CSEE*  
418 2013;33:1–7.
- 419 [16] Li R, Gao, QS, Liu, W. Characteristics of direct-driven permanent magnet syn-  
420 chronous wind power generator under symmetrical three-phase short-circuit fault.  
421 *Power System Technology*, 2011; 35:153–8.
- 422 [17] Entezami M, Hillmansen S, Weston P, Papaalias MP. Fault detection and diagnosis  
423 within a wind turbine mechanical braking system using condition monitoring.  
424 *Renewable Energy* 2012; 47:175–82. <https://doi.org/10.1016/j.renene.2012.04.031>
- 425 [18] Rose J, Hiskens IA. Estimating wind turbine parameters and quantifying their  
426 effects on dynamic behavior. *IEEE Power & Energy Society General Meeting*; Jul.  
427 2008:1-7. <https://doi.org/10.1109/PES.2008.4596862>
- 428 [19] Spinato, F., Tavner, P.J., van Bussel, G.J.W., Koutoulakos, E. Reliability of wind  
429 turbine subassemblies. *IET Renew Power Gen* 2009; 3:387–401.  
430 <http://dx.doi.org/10.1049/iet-rpg.2008.0060>

- 431 [20] Ziegler, L., Gonzalez, H., Rubert, T., Smolka, U., Melero, J. Lifetime extension of  
432 onshore wind turbines: A review covering Germany, Spain, Denmark, and the UK.  
433 Renewable and Sustainable Energy Reviews, 2018; 82:1261–1271.  
434 <http://dx.doi.org/10.1016/j.rser.2017.09.100>
- 435 [21] H. Arabian-Hoseynabadi, H. Oraee, P.J. Tavner. Failure Modes and Effects  
436 Analysis (FMEA) for Wind Turbines, Int. J. Electrical Power Energy System, 2010;  
437 32(7):817-824. <https://doi.org/10.1016/j.ijepes.2010.01.019>
- 438 [22] RELIAWIND project. European Union's Seventh Framework Programme for  
439 RTD (FP7). [http://windpower.sandia.gov/2009Reliability/PDFs/Day2-13-  
440 MichaelWilkinson.pdf](http://windpower.sandia.gov/2009Reliability/PDFs/Day2-13-MichaelWilkinson.pdf) (accessed 22.01.2018)
- 441 [23] Tavner P. Offshore Wind Turbines: Reliability, Availability and Maintenance.  
442 London: Institution of Engineering and Technology; 2012.
- 443 [24] Touret, T., Changenet, C., Ville, F., Lalmi, M., Becquerelle, S. On the use of  
444 temperature for online condition monitoring of geared systems – A review, Mechanical  
445 Systems and Signal Processing 2018; 101:197–210.  
446 <http://dx.doi.org/10.1016/j.ymsp.2017.07.044>
- 447 [25] Marques, P.M., Fernandes, C.M., Martins, R.C., Seabra, J.H. Power losses at low  
448 speed in a gearbox lubricated with wind turbine gear oils with special focus on churning  
449 losses. Tribology International 2013; 62:186–97. <http://dx.doi.org/10.1016/j.triboint.2013.02.026>.
- 451 [26] Song, Z., Zhang, Z., Jiang, Zhu, J. Wind turbine health state monitoring based on a  
452 Bayesian data-driven approach. Renewable Energy, 2018; 125:172-181.  
453 <https://doi.org/10.1016/j.renene.2018.02.096>
- 454 [27] Castellani, F., Astolfi, D., Sdringola, P., Proietti, S., Terzi, L. Analyzing wind turbine  
455 directional behavior: SCADA data mining techniques for efficiency and power  
456 assessment. Applied Energy, 2017; 185:1076-1086.  
457 <http://dx.doi.org/10.1016/j.apenergy.2015.12.049>
- 458 [28] Wind Turbine Power Performance IEC 61400-12-1, Power performance  
459 measurements according to the international guidelines, IEC 61400-12-1.

- 460 [29] T. Toureta, C. Changenetb, F. Villea, M. Lalmic, S. Becquerellec. On the use of  
461 temperature for online condition monitoring of geared systems. *Mechanical Systems and*  
462 *Signal Processing* 2018; 101:197-210. <http://dx.doi.org/10.1016/j.ymssp.2017.07.044>
- 463 [30] Feng, Y., Qiu, Y., Crabtree, C., Long, H. Tavner, P. Monitoring Wind Turbine  
464 Gearboxes. *Wind Energy* 2013; 16:728-740. <https://doi.org/10.1002/we.1521>
- 465 [31] Salameh, J., Cauet, S., Etien, E., Sakout, A., Rambault, L. Gearbox condition  
466 monitoring in wind turbines: A review. *Mechanical Systems and Signal Processing* 2018;  
467 111:251–264. <https://doi.org/10.1016/j.ymssp.2018.03.052>
- 468 [32] Nélias, D., Dumont, M.L., Champiot, F., Vincent, A., Flamand, L., Role of  
469 inclusions, surface roughness and operating conditions on rolling contact fatigue, *Journal*  
470 *of Tribology.*, 1999; 121:240-250. <https://doi.org/10.1115/1.2833927>
- 471 [33] Littmann, W.E., Kelley, B., Anderson, W.J., Fein, R.S., Klaus, E., Sibley, L.B.,  
472 Winer, W., Chemical effects of lubrication in contact fatigue – 3. load-life exponent, life  
473 scatter, and overall analysis, *Journal of Lubrication Technology*, ASME,1976; 98:308-  
474 318. <https://doi.org/10.1115/1.3452832>
- 475 [34] Hostis, B., Minfraya, C., Frégonèse, M., Verdub, C., Ter-Ovanessian, B., Vachera,  
476 B., Le Mognea, T., Jarnias, F., D’Ambrose, A., Influence of lubricant formulation on  
477 rolling contact fatigue of gears – interaction of lubricant additives with fatigue cracks,  
478 *Wear*, 2017; 382-383: 113-122. <https://doi.org/10.1016/j.wear.2017.04.025>
- 479 [35] B.R. Höhn , K. Michaelis. Influence of oil temperature on gear failures. *Tribology*  
480 *International* 37, 2004; 103–109. [https://doi.org/10.1016/S0301-679X\(03\)00047-1](https://doi.org/10.1016/S0301-679X(03)00047-1)
- 481 [36] Cardis, A.B. Gear oil micropitting evaluation, *Gear Technology*; 2000; 17: 30-35.
- 482 [37] L’Hostis, B., Minfraya, C., Frégonèse, M., Verdub, C., Ter-Ovanessian, B., Vacher,  
483 B., Le Mogne, T., Jarnias, F., D’Ambros, A. Influence of lubricant formulation on rolling  
484 contact fatigue of gears – interaction of lubricant additives with fatigue cracks, *Wear*,  
485 2017; Volumes 382–383:113-122. <https://doi.org/10.1016/j.wear.2017.04.025>
- 486 [38] Lainé, A., Olver, A., Lekstrom, M., Shollock, B., Beveridge, T., Hua, D. The effect  
487 of a friction modifier additive on micropitting; *Tribology Transactions*, 2009; 52:526-  
488 533. <https://doi.org/10.1080/10402000902745507>



489 [39] Nutakor, C., Kłodowski, A., Sapanen, J., Mikkola, A., Pedrero, J. Planetary gear sets  
490 power loss modeling: Application to wind turbines. *Tribology International*, 2017;  
491 105:42–54. <http://dx.doi.org/10.1016/j.triboint.2016.09.029>

492 [40] Leite, G., Araújo, A., Rosas, P. Prognostic techniques applied to maintenance of  
493 wind turbines: a concise and specific review. *Renewable and Sustainable Energy*  
494 *Reviews*, 2018; 81:1917–1925. <http://dx.doi.org/10.1016/j.rser.2017.06.002>

495 [41] Bangalore, P., Patriksson, M. Analysis of SCADA data for early fault detection, with  
496 application to the maintenance management of wind turbines. *Renewable Energy*, 2018;  
497 115: 521-532. <http://dx.doi.org/10.1016/j.renene.2017.08.073>

498 [42] Willis, D, Niezrecki, C., Kuchma, D., Hines, E., Arwade, S., Barthelmie, R.,  
499 DiPaola, M., Drane, P., Hansen, C., Inalpolat, M., Mack, J., Myers, A., Rotea, M. Wind  
500 energy research: State-of-the-art and future research directions, *Renewable Energy*, 2018;  
501 125:133-154. <https://doi.org/10.1016/j.renene.2018.02.049>

502

503

504

505

506

507

508

509

510

511

512

513

514

515

## 516 FIGURE CAPTIONS

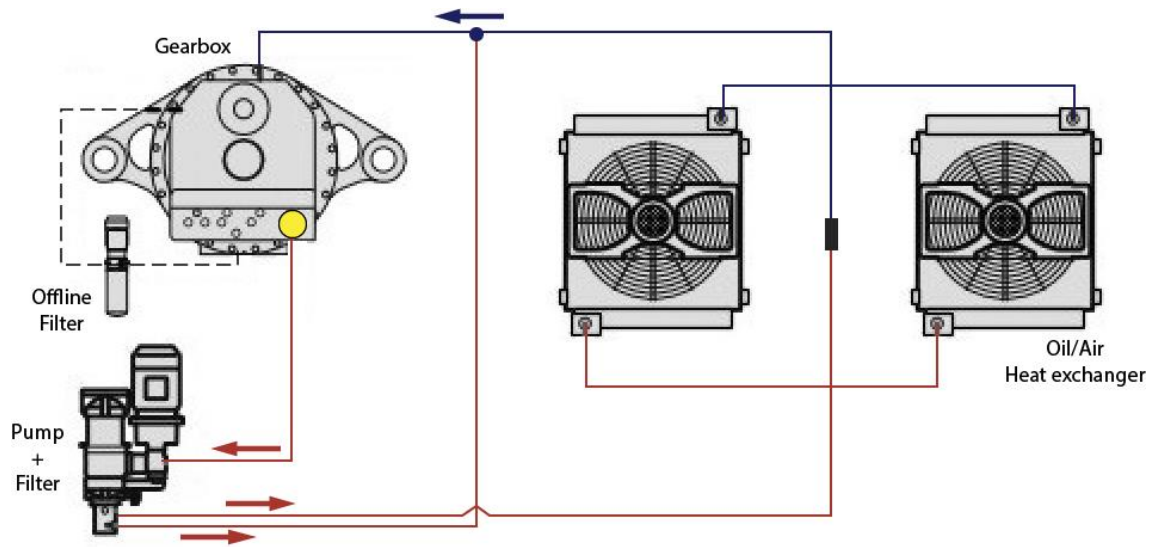

517

518 **Figure 1.** Gearbox cooling circuit. The gearbox is provided with a combined splash / circulatory lubricating  
 519 system. The cooled and filtered oil is fed to the gearbox through a distributor (blue point) which distributes  
 520 it to the bearings through internal pipes and the borings (blue arrow). The oil pressure is approx. 2.5 – 3  
 521 bar at an oil sump temperature of 60°C. The gear case of the helical gearbox is fitted, below the oil level,  
 522 with the screw-in heaters with replaceable heating rods (yellow circle on gearbox). The heaters must be  
 523 switched on when the oil sump temperature drops below +5°C (red lines and arrows), cooling the oil. The  
 524 switch-off point lies between +10°C and +15°C. Monitoring is ensured by the above mentioned resistance  
 525 thermometers.

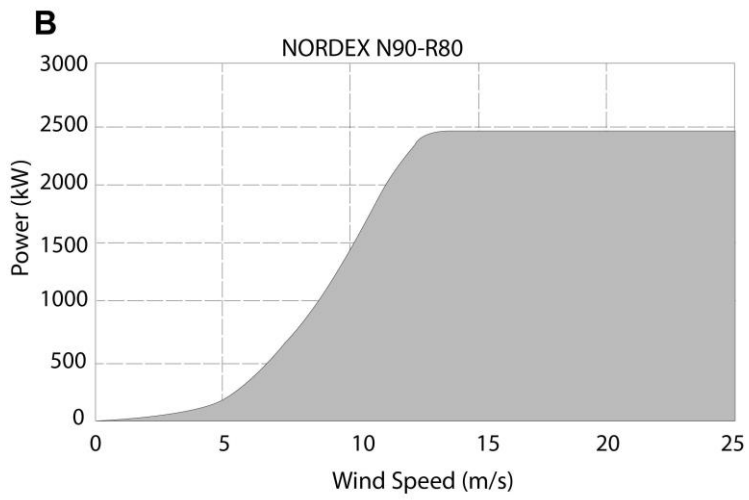
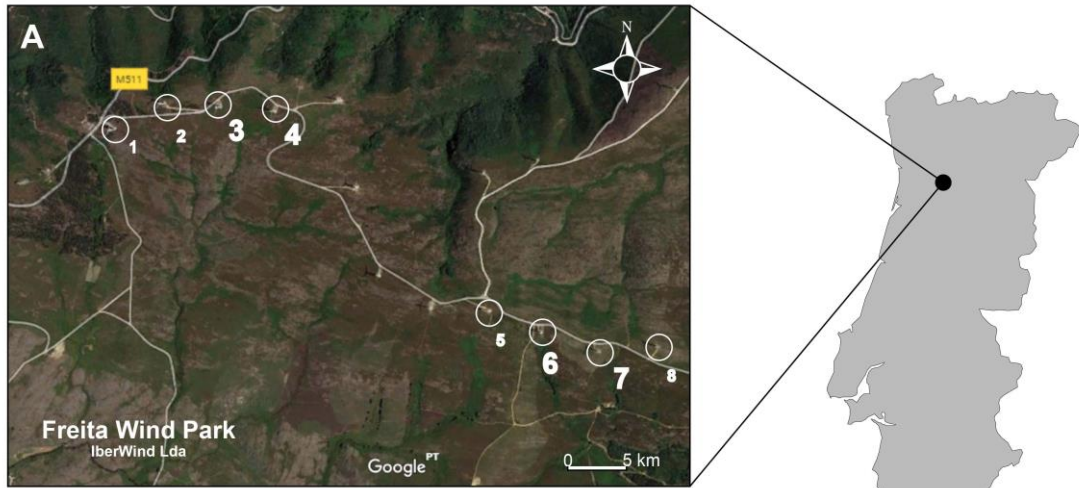

Rating of each turbine: 2300 kW  
Tower height | Tower Weight: 80m | 179t  
Rotor diameter | Rotor Weight: 90m | 52t  
Nacelle weight: 97t  
Turbine rotation speed: 9.6-16.9 rpm  
Blade length: 45m

526

PRE-PRINT

527 **Figure 2.** (A) Freita' Wind Park, Arouca (Portugal). On the image in white are represented the four turbines  
528 operating since 2006 and without gearboxes replacements; (B) Power curve of the NORDEX N90-R80  
529 turbines and characteristics.

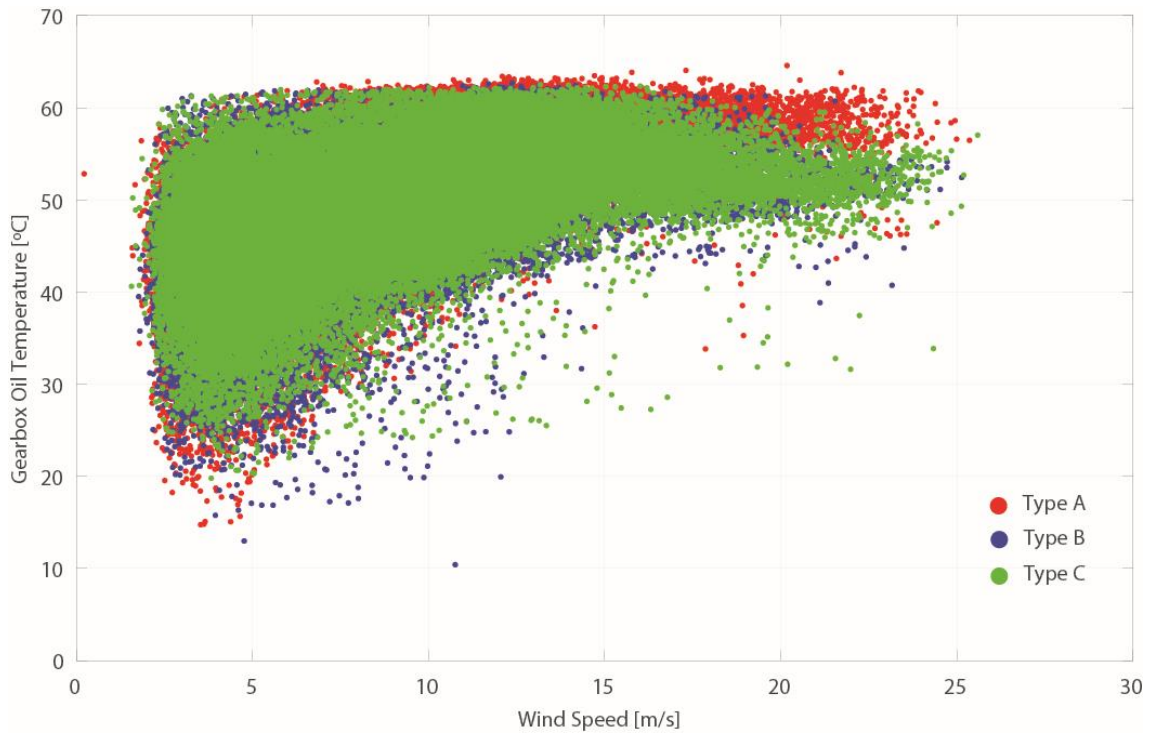

530  
531 **Figure 3.** Example of the pre filter raw data from the SCADA system showing the relation between the  
532 gearbox temperature (°C) and wind speed (m/s) for different oil types. Example is from the wind turbine 3  
533 of the Freita' Wind Park, Arouca (Portugal).

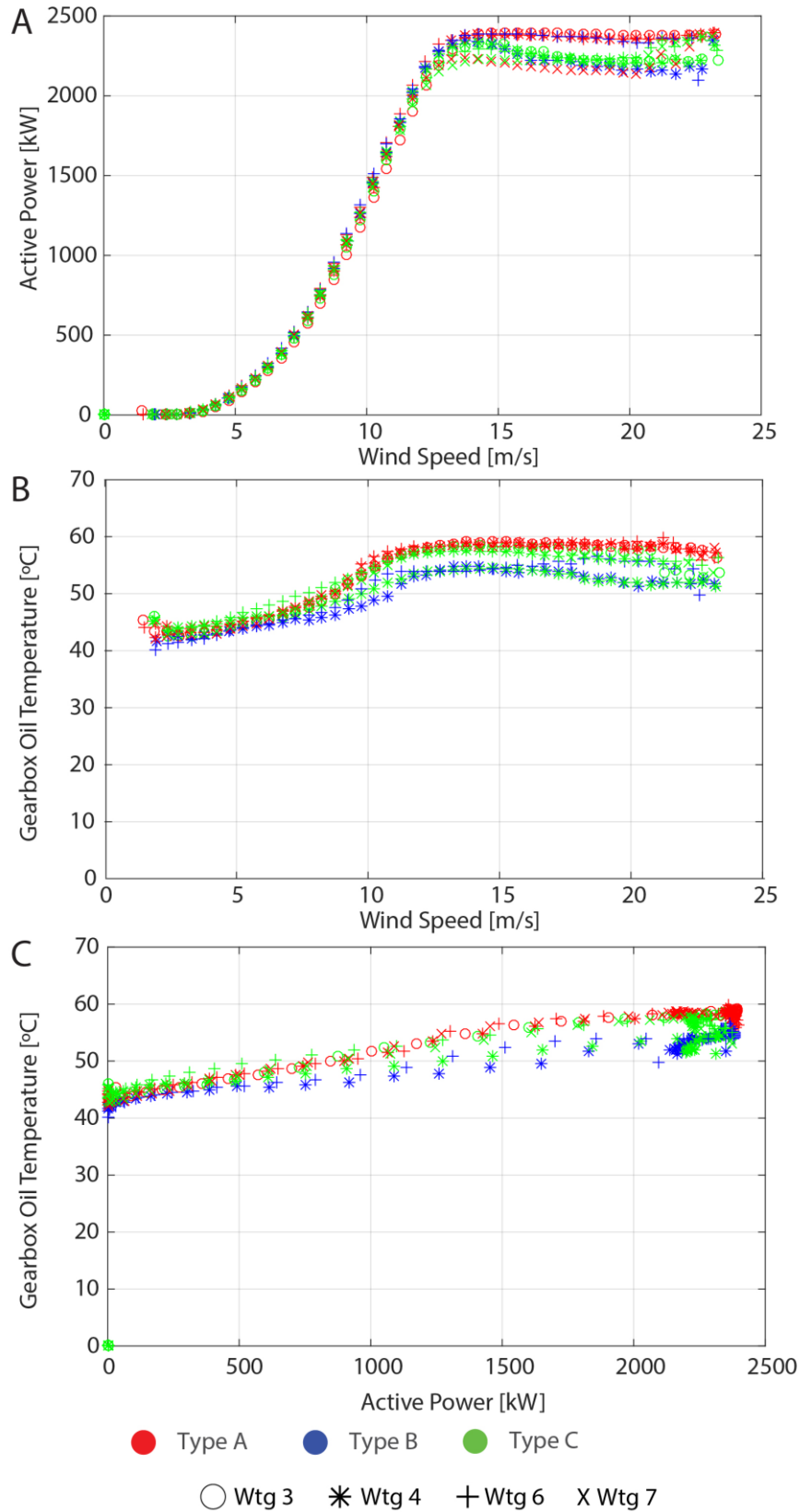

534

535 **Figure 4.** Bin method results for the four analysed wind turbine gearboxes (Wtg) and for the three different  
 536 oil types: (A) active power curves as a function of wind speed; (B) oil temperature inside gearboxes as a  
 537 function of wind speed; (C) oil temperature inside gearboxes as a function of active power production.

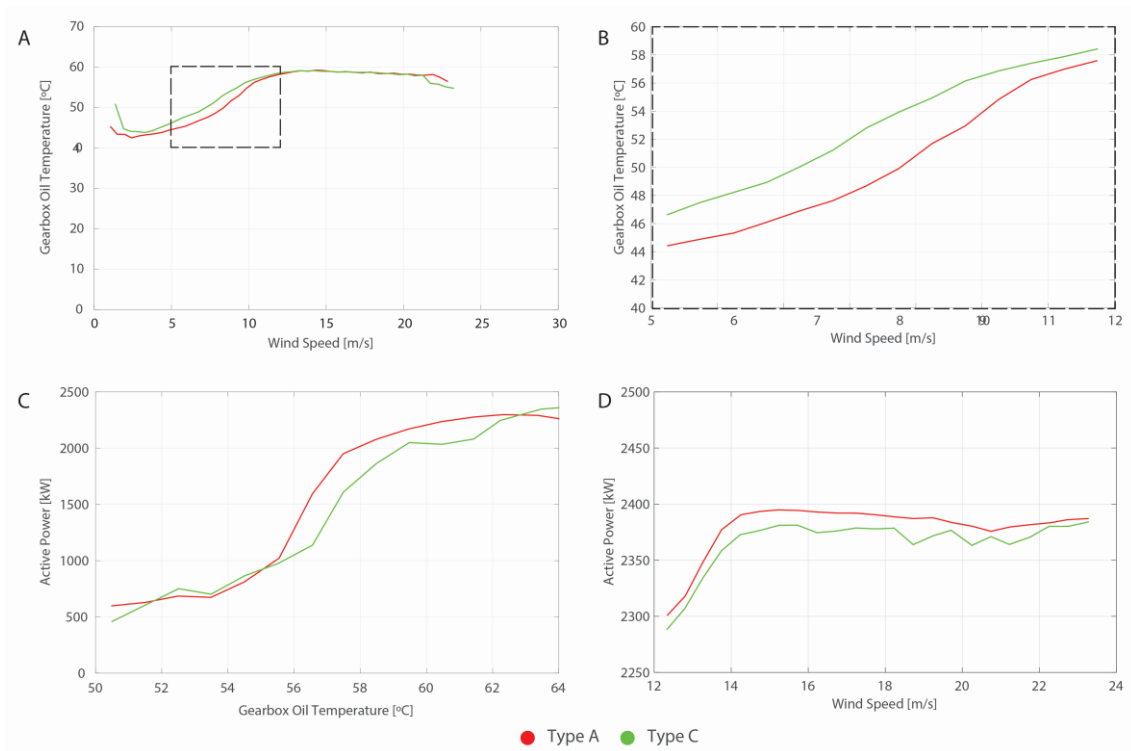

538

539 **Figure 5.** (A) Relation between gearbox oil temperature and wind speed velocity after oil replacement from  
 540 type A to C on turbine 3; (B) zoom in to the velocity range where most measurements were registered and  
 541 where the highest temperature differences were observed; (C) active power produced in the higher  
 542 temperature range, showing significant differences at an oil temperature of 58° C; and (D) differences of  
 543 wind energy production within the range of speeds between 12 and 15 m/s, registering the largest  
 544 differences (~20 kW).

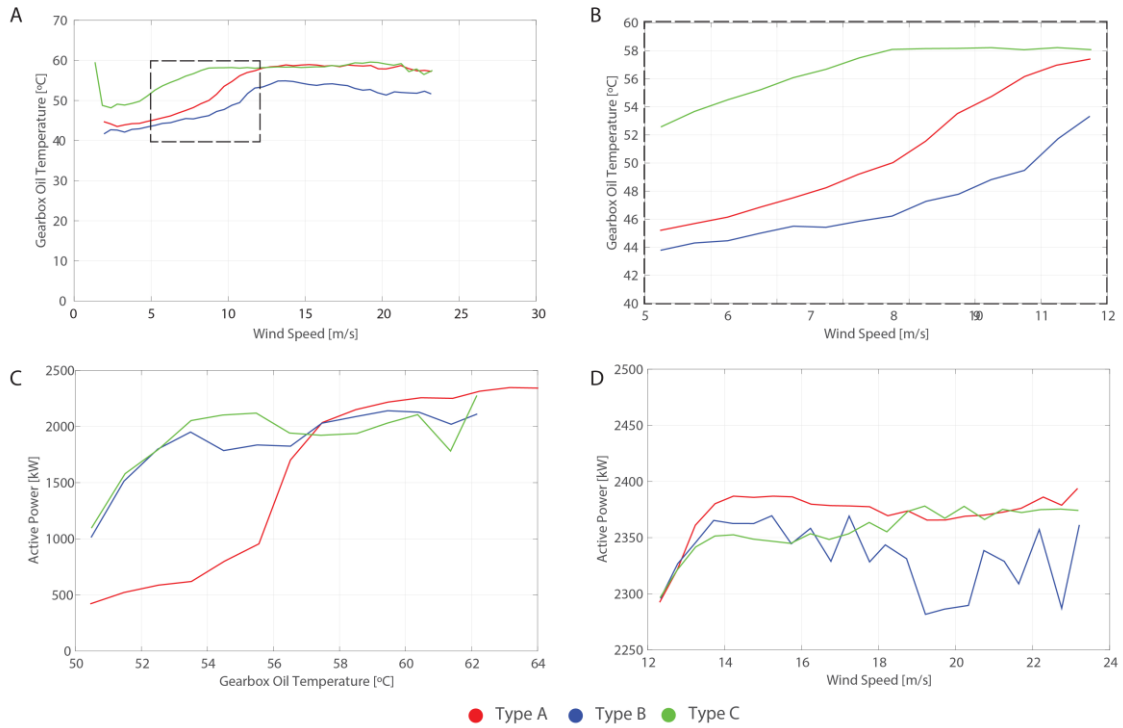

545

546 **Figure 6.** (A) Relation between gearbox oil temperature and wind speed velocity after oil replacements on  
 547 turbine 4 which experienced the three different oils types; (B) zoom in to the velocity range where most  
 548 measurements were registered and where the highest temperature differences were observed; (C) active  
 549 power produced in the higher temperature range, showing that the largest production differences are  
 550 recorded in the temperature range between 52° C and 56° C; and (D) differences of wind energy production  
 551 within the range of speeds between 12 and 24 m/s, where it is observed the poorest performance when using  
 552 oil B.

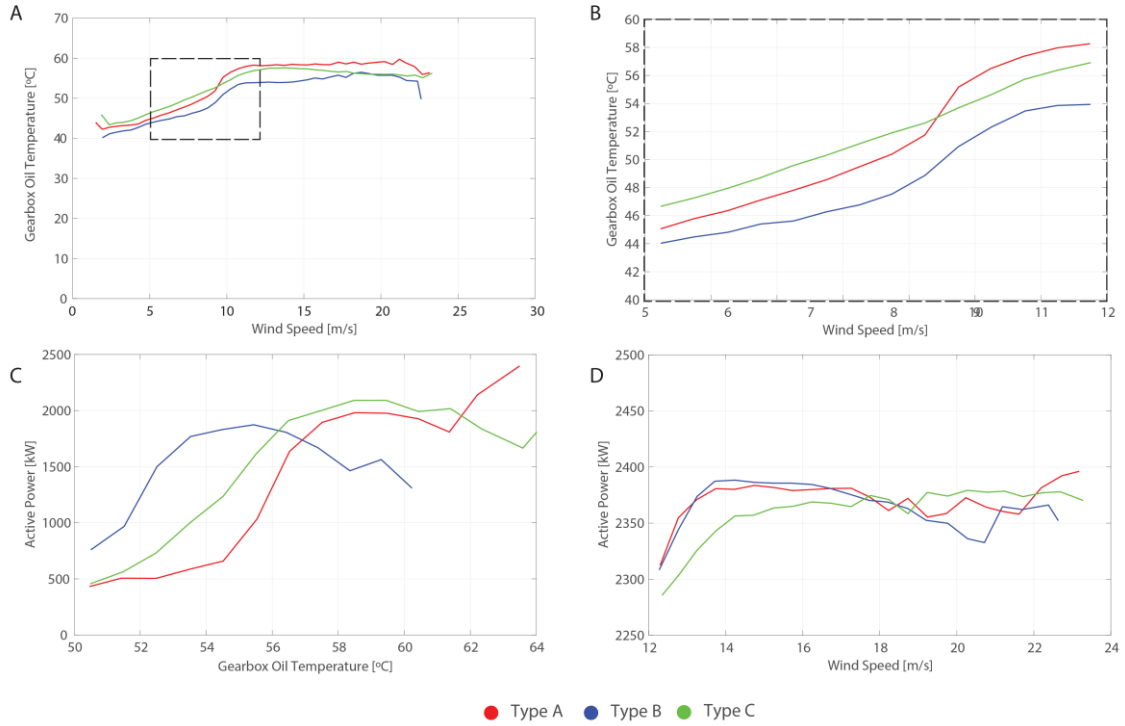

553

554 **Figure 7.** (A) Relation between gearbox oil temperature and wind speed velocity after oil replacements on  
 555 turbine 6 which experienced the three different oils types; (B) zoom in to the velocity range where most  
 556 measurements were registered, where is observed that type A presents the higher temperatures inside  
 557 gearbox for velocities over 10 m/s i.e. the beginning of nominal wind speed; (C) active power produced in  
 558 the higher temperature range, showing that the largest production differences are recorded in the  
 559 temperature range between 52° C and 56° C; and (D) differences of wind energy production within the  
 560 range of speeds between 12 and 24 m/s, where it is observed again the poorest performance when using oil  
 561 B.



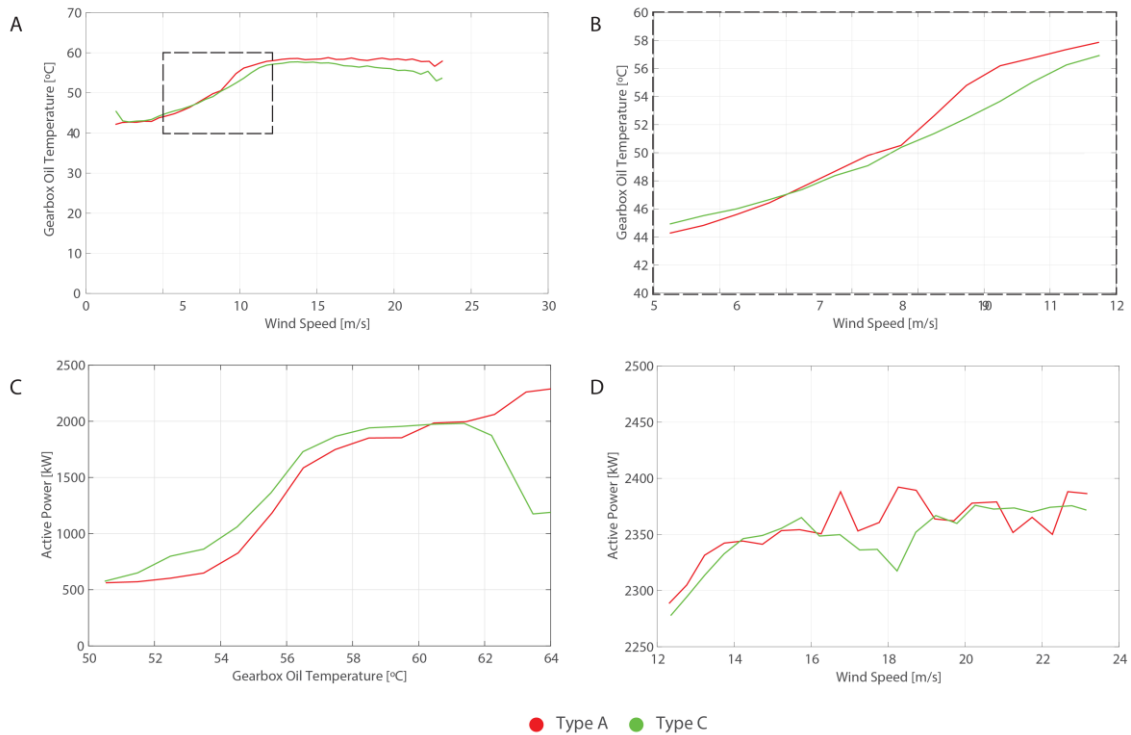

562

563 **Figure 8.** (A) Relation between gearbox oil temperature and wind speed velocity after oil replacements on  
 564 turbine 7 which experienced two different oils types; (B) zoom in to the velocity range where most  
 565 measurements were registered. In this case temperature differences are only noticeable over 9 m/s; (C) the  
 566 largest differences on active power production occur between 52° C and 57° C i.e. before the exchanger  
 567 fans are turned on; and (D) overall negligible differences of wind energy production within the range of  
 568 speeds between 12 and 24 m/s, registering a maximum of plus 80 kW using type A oil at 18.2 m/s.

569

570

571

572

573 **TABLE CAPTIONS**574 **Table 1.** Types of oil and characteristics used on the NORDEX N90 gearboxes.

	<b>A</b>	<b>B</b>	<b>C</b>
<b>Type</b>	Mineral (MINR)	Synthetic polyalphaolefin (PAO)	
<b>ISO Viscosity Grade</b>	320	320	320
<b>Viscosity, ASTM D 445, cSt @ 40°C</b>	320	320	325
<b>Viscosity, ASTM D 445, cSt @ 100°C</b>	24.1	35.1	34.9
<b>Viscosity Index, ASTM D 2270</b>	96	155	152
<b>Density @15 °C</b>	0.903	0.943	0.854
<b>Flash Point (° C)</b>	268	280	250
<b>Fusion Point (° C)</b>	-18	-33	-33
<b>Chemical Properties</b>			
<b>Calcium (Ca mg/kg)</b>	7	5	1511
<b>Magnesium (Mg mg/kg)</b>	0	0	3
<b>Boron (B mg/kg)</b>	0	0	0
<b>Zinc (Zn mg/kg)</b>	51	29	4
<b>Phosphorus (P mg/kg)</b>	203	200	311
<b>Barium (Ba mg/kg)</b>	0	0	0
<b>Molybdenum (Mo mg/kg)</b>	2	0	808
<b>Sulphur (S mg/kg)</b>	13258	3013	2586
	<b>A</b>	<b>B</b>	<b>C</b>
<b>Type</b>	Mineral (MINR)	Synthetic polyalphaolefin (PAO)	
<b>ISO Viscosity Grade</b>	320	320	320
<b>Viscosity, ASTM D 445, cSt @ 40°C</b>	320	320	325
<b>Viscosity, ASTM D 445, cSt @ 100°C</b>	24.1	35.1	34.9
<b>Viscosity Index, ASTM D 2270</b>	96	155	152
<b>Density @15 °C</b>	0.903	0.943	0.854
<b>Flash Point (° C)</b>	268	280	250
<b>Fusion Point (° C)</b>	-18	-33	-33
<b>Chemical Properties</b>			
<b>Calcium (Ca mg/kg)</b>	7	5	1511
<b>Magnesium (Mg mg/kg)</b>	0	0	3
<b>Boron (B mg/kg)</b>	0	0	0
<b>Zinc (Zn mg/kg)</b>	51	29	4
<b>Phosphorus (P mg/kg)</b>	203	200	311
<b>Barium (Ba mg/kg)</b>	0	0	0
<b>Molybdenum (Mo mg/kg)</b>	2	0	808
<b>Sulphur (S mg/kg)</b>	13258	3013	2586

575

576 **Table 2.** Wind turbine gearbox (WTG) exchange dates and used oils types on the NORDEX N90 gearboxes.

<b>WTG Number</b>	<b>Type A</b>	<b>Type B</b>	<b>Type C</b>
<b>Wtg#3</b>	05/04/2011		24/05/2013
<b>Wtg#4</b>	10/05/2011	23/01/2012	30/01/2013
<b>Wtg#6</b>	05/04/2011	23/01/2012	30/01/2013
<b>Wtg#7</b>	02/04/2012		19/03/2013

577

578 **Table 3.** Sampling results on oil viscosity for the different turbine gearboxes.

<b>Wind Gearbox (#Wtg)</b>	<b>#Wtg3</b>		<b>#Wtg4</b>			<b>#Wtg6</b>			<b>#Wtg7</b>	
<b>Oil Type</b>	A	C	A	B	C	A	B	C	A	C
<b>Viscosity, ASTM D 445, cSt @ 40°C</b>	315.96	313.16	314.28	306.93	307.78	309.58	308.85	304.77	316.17	312.48
<b>Viscosity, ASTM D 445, cSt @ 100°C</b>	23.54	32.00	23.56	32.14	32.51	23.50	31.38	32.78	23.60	34.22
<b>Viscosity Index, ASTM D 2270</b>	94	142	93	145	147	95	140	149	94	154

579

580

PRE-PRINT

**Highlights**

- Analysis of real data from wind farms monitored and controlled by SCADA system
- Relations established between lubricant selection and the active power production
- Direct relation observed between oil characteristics and energy efficiency
- Gearboxes working with oils of similar nature result in differences on performance
- Noted oil degradation as a function of temperature increase, affecting production

PRE-PRINT