



Escola d'Enginyeria de Telecomunicació i
Aeroespacial de Castelldefels

UNIVERSITAT POLITÈCNICA DE CATALUNYA

TREBALL FINAL DE GRAU

TÍTOL DEL TFG: Scheduler design for a satellite simulator and other software improvements

TITULACIÓ: Grau en Enginyeria en Sistemes Aeroespacials

AUTOR: Pablo Sanz Fernández

DIRECTORS: Hyuk Park, Jordi Castellví

DATA: 01 de juny del 2019

RESUM

L'objectiu principal d'aquest treball és contribuir al desenvolupament d'un simulador de missions per satèl·lit. En concret, la part principal a treballar és el planificador, el gestor de tasques que decideix com ha de comportar-se el simulador durant la missió completa. També es faran altres millores en el programari.

El planificador és la lògica interna que han de seguir els ordinadors de bord d'un satèl·lit per satisfer els objectius de la missió. Té en compte els requisits i limitacions dels pressupostos d'energia, de calor i de dades. Depenent de l'estat dels pressupostos, avalua si els diferents subsistemes de satèl·lit han de ser: actius, inactius o han de canviar la manera en què funcionen. Per tant, pot actuar fent servir ordres si cal, perquè funciona de manera totalment independent.

Aquest treball millorarà el planificador actual d'un simulador de satèl·lits, fent-lo més eficient, resistent i personalitzable. S'implementaran diferents modes de funcionament al simulador per evitar el col·lapse dels pressupostos. La lògica dels canvis de mode i les capacitats de cadascun dels modes de treball seran la clau per millorar el planificador.

Prèviament a la implementació del codi, es farà una investigació teòrica per entendre els diferents components que apareixen els diferents pressupostos.

Les altres millores de programari són funcionalitats afegides al simulador per fer-lo més realista i útil per a una àmplia gamma de missions espacials. Per exemple, s'implementa un "submode" de precisió. També s'estudien alguns paràmetres de satèl·lit per veure la seva afectació als tres pressupostos. Alguns exemples podrien ser l'afectació de la pintura de xassis o la sobretensió dels subsistemes.

Durant l'informe, es mostraran al lector moltes gràfiques i mapes obtinguts del simulador per veure com afecten les diferents millores. Finalment, es farà una simulació de missió de 90 dies per comentar els resultats obtinguts.

TITLE: Scheduler design for a satellite simulator and other software improvements

TITULATION: Grau en Enginyeria en Sistemes Aeroespacials

AUTHOR: Pablo Sanz Fernández

DIRECTORS: Hyuk Park, Jordi Castellví

DATE: 01 of june del 2019

OVERVIEW

The main objective of this work is contributing into the development of one satellite missions' simulator. Specifically, the main part to work in is the scheduler, the task manager that decides how the simulator must behave during the full mission. Other software improvements will be done too.

The scheduler is the internal logic that the on-board computer/s of a satellite must follow in order to satisfy the mission objectives. It takes into account the requirements and constrains of the power, thermal and data budgets. Depending on the state of the budgets it evaluates if the different satellite subsystems must be: active, inactive or must change the way that they are operating. So it can take action using commands if is needed because it works in a fully-independent-way.

This work will improve the current scheduler of a satellite simulator, making him more efficient, resistant and customizable. Different working modes will be implemented in the simulator in order to avoid the collapse of the budgets. The mode changes logic and the capabilities of each one of the working modes will be the key of improving the scheduler.

Previous to the code implementation, a theoretical research will be done in order to understand the different components that play a roll into the different budgets.

The other software improvements are functionalities added to the simulator to make him more realistic and useful for a huger range of space mission. A precision "submode" is implemented for example. Also some satellite parameters are studied in order to see its affectation to the three budgets. Examples could be the chassis paint affectation or the overvoltage of the subsystems.

During the report, lots of plots and maps obtained from the simulator will be showed to the reader to see how the different improvements affect. Finally, a 90 days mission simulation will be done in order to comment the obtained results.

INDEX

INTRODUCTION	1
CHAPTER 1. MOTIVATION AND THEORETICAL RESEARCH	4
1.1. Student motivation	4
1.2. Satellite Scheduler Concept	4
1.3. POWER BUDGET	5
1.3.1. Introduction	5
1.3.2. Power system elements	7
1.3.3. Solar Arrays	7
1.3.4. Fuel Cells	11
1.3.5. Radioisotope thermoelectric generators (RTG)	12
1.3.6. Other primary power systems	14
1.3.7. Secondary power systems: batteries	14
1.3.8. Power management, distribution and control	15
1.3.9. Power budget	16
1.4. THERMAL BUDGET	17
1.4.1. Introduction	17
1.4.2. Thermal environment	18
1.4.3. Direct solar radiation and albedo radiation	19
1.4.4. Planetary radiation	20
1.4.5. Thermal Balance	21
1.4.6. Thermal Analysis	22
1.4.7. Passive control	23
1.4.8. Active control	24
1.5. DATA BUDGET	24
1.5.1. Introduction	24
1.5.2. System architecture	25
1.5.3. On-board computer	26
1.5.4. Telemetry	27
1.5.5. Command	28
CHAPTER 2. CODE IMPLEMENTATION	29
2.1. Simulator	29
2.1.1. Definition	29
2.1.2. Structure	30
2.1.3. Project Contribution	33
2.2. Scheduler	33
2.2.1. Inputs	33
2.2.2. Internal algorithm	34
2.3. Satellite Subsystems	42
2.3.1. Definition of the subsystems	42
2.3.2. Important parameters of the subsystems	43
2.3.3. Activation conditions	45
2.4. Working modes	47
2.4.1. Definition of the modes	47
2.4.2. DOD constraint	50

2.4.3. Mode changes	52
2.4.4. Comparison of modes combinations.....	72
2.5. Other Software improvements.....	74
2.5.1. Precision.....	74
2.5.2. All-photos.....	81
2.5.3. All-Transmission	86
2.5.4. Overvoltage	89
2.5.5. Paint affectation	90
2.6. Specific Mission.....	91
2.7. Conclusions	99
CHAPTER 3. REFERENCES	102

INTRODUCTION

The main objective of this work is contributing into the development of one satellite missions' simulator. Specifically, the main part to work in is the scheduler, the task manager that decides how the simulator must to behave during the full mission. Other software improvements will be done too.

The realization of a space mission means a big money expenses not only during the mission. The previous to the mission tests, the people working on it, the time needed... For all these reasons is needed the development of a software capable of emulating the reality of the behaviour of the satellite and its environment to see if the mission objectives are reached.

The original version of the code was capable or realising missions. The problem that it had was that the satellite was not able to self-manage the adverse situations. In the simulations it entered in collapse talking about the power, temperature and data budgets. The satellite lost the control of the battery charge maintenance, the temperature of the satellite, and the managing of the memory space. For all this reasons, it was needed to implement a better scheduler to deal with these problems.

In order to develop a useful scheduler an information research about the power, thermal and data budget has been done. It is important to be aware of the elements that play a role in each one. This information will be located in the first chapter of the report.

In chapter two the simulator is presented. At the beginning is showed how it works and which the outputs that can be obtained are. Next is explained how the scheduler works. Basically it updates the state of the budgets components like the battery charge, the temperature and the memory and takes action deciding which satellite subsystems must be activated and which not.

The solution for solving the collapse of the budgets is the implementations of working modes. Each mode will have different capabilities and objectives. The selection of which mode is the proper one for each situation depends on the scheduler. The logic of the mode changes also depends on state of the different budgets.

In addition to the scheduler, various functionalities have been added to the simulator. An example is the incorporation of a precision "submode". The objective is making the simulator useful software for the more huge range of mission types possible.

To test how the new version of the simulator works, a long mission is simulated. The results obtained are presented to take conclusions. During the work, also shorter simulations have been also performed to show the reader the different improvements at the time they are explained.

Finally, at the end of the work, the main conclusions are presented. Furthermore some ideas for still improving are commented. The last things that appear in the report are the references.

CHAPTER 1. MOTIVATION AND THEORETICAL RESEARCH

1.1. Student motivation

The small satellite mission analysis is one of the main topics into the aerospace research. As a student of aerospace engineering I feel that the space topic has not been really developed during the degree. For this reason, orientate the TFG to a growing market area is a really good decision. It gives the opportunity of learning something that can orientate my next academic or professional step after finish the degree.

This is not a full-theoretical research work. It has a really important practice weight. The implementation of the theoretical research into something useful was one of my objectives at the time of deciding which type work I would like to do. In that case, if the work is well done, this TFG will help in the contribution of the developing of professional software. As a student this is something that has never happened with the works that I have done.

Programming is one of the things that I have enjoyed more during the full career, and probably is the most important skill that I have learned. The fact that the simulator is programmed in a language that I used, has permitted me to centre my efforts in learning about the space topics and not loose time in another things.

Finally, the monitoring by the part of the coordinator and tutor was an important factor at the time of deciding which topic chose. At the time of select this TFG, I knew that this collaboration by part of the coordinator and tutor would be done. About that I can be grateful. Work in a new and unknown topic is really difficult. Have somebody with more experience to ask doubts, share the progress done and consult the ideas to implement is a key factor.

1.2. Satellite Scheduler Concept

The scheduler is the internal logic that the on-board computer/s of a spacecraft must follow in order to satisfy the mission objectives taking into account the requirements and constrains of the power, thermal and data budgets. It is the "intelligence on-board" that warranties the safe performance of the operations. The scheduler analyses the situation of the spacecraft during the flight thanks to the telemetry data and evaluates if the different systems must be: active, inactive or must change the way that they are operating. So it can take action using commands if is needed because it works in a fully-independent-way.

Each of these budgets will be explained in the next sections. The objective is to understand which elements and devices affect to each one. To design a simulator is imperative be aware of the systems that must be "recreated",

having clear its utilities and its limitations. Also the environment conditions must be known, and how affect to the spacecraft subsystems operation. Understanding al this information is the only way of programming a realistic scheduler.

A well-designed scheduler optimizes the resources on-board and allows realising more efficient missions. The autonomous decision-making of the scheduler allow taking action faster and don't require a constant link between the spacecraft and a controller on-ground. Thus a human constant monitoring it is not needed which means a simplification on the operation and a cost reduction of the mission development.

The scheduler actually is composed by code lines, so it can be used for more than one mission. Of course the full code will depend on the mission objectives and spacecraft characteristics, but the main structure could be used.

1.3. POWER BUDGET

1.3.1. Introduction

As it is logic to think, the provision of electrical power is probably the most fundamental requirement in order to realise a space mission. A power-system failure results always in a loss of the mission. A lot of space missions haven't succeeded because they had a trouble in the systems in charge of this electrical power management. The power budget is the balance between the incoming electrical energy on the satellite and the consumed one.

From the earliest satellites, the electrical power demand has increased. The main reasons of that tendency are the increase of the sophistication and complexity of the functionalities that are equipped in the satellite systems including the telecommunication and information broadcast systems.

Is important to notify that in the 1980's decade, there was a great interest in the large space systems that have manned and unmanned elements. To have manned element involve an increase in the electrical power demand. The tendency has changed, even though large satellites are still being built, there is a big focus pointing to small satellites. Obviously these systems have different electrical power demand necessities; they haven't manned systems for example. At this point, it can be assumed that depending on the type of satellite mission the alimentation source will vary. Figure 1.1 is a graph that represents what are the best electrical power sources depending on two parameters: the electrical output and the mission duration.

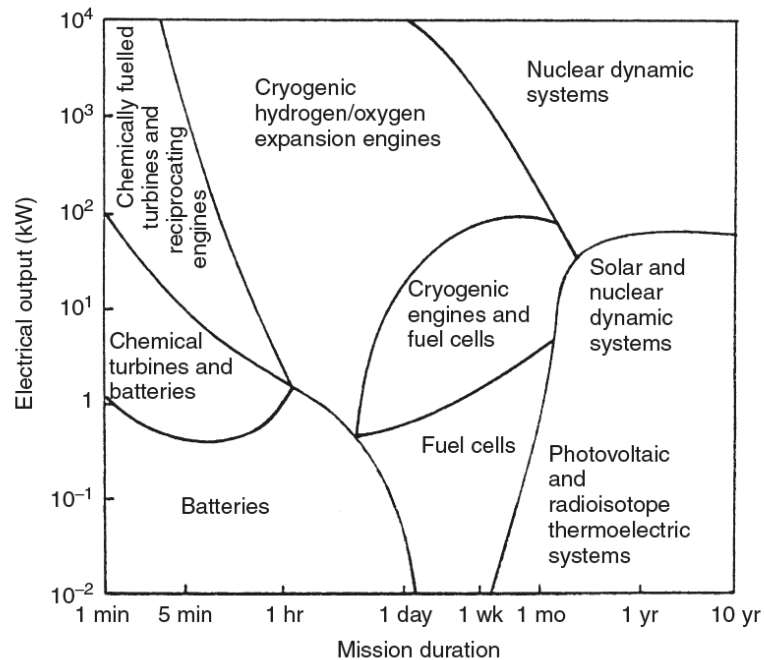


Fig. 1.1 Power outputs: mission duration relationship between energy source and appropriate operational scenario

According to the graph, the classical satellite missions that must have a duration of several years, taking into account an electrical power demand between 10KW and 100KW, should feed with solar and nuclear dynamic systems or photovoltaic and radioisotope thermoelectric systems. For shorter periods, fuel cells are advantageous, and for periods of less than a few days, batteries are the best option. Table 1.1 shows the functionality of the most used alimentation sources of the graph

Table 1.1 Functionalities of the main alimentation sources

Alimentation Source	Functionality
Batteries	Launch vehicles as a primary energy source
Fuel cells	Short duration missions (few days)
Solar and nuclear dynamics systems	General spacecraft operation (large systems)
Nuclear sources	Military applications

It is relevant to know that a satellite could have more than one electrical source. Actually, it is the most habitual scenario. The power budget takes into account the different sources and the satellite subsystems consumptions always trying to have more power available than the one that is demanded.

1.3.2. Power system elements

The electrical power systems of a satellite system are divided in three main elements: the primary energy source, the secondary energy source and the control/ distribution network.

A primary source converts fuel into electrical power. This "fuel" in the present-day spacecrafts, which are based on solar arrays, is the solar energy. Thanks to the photovoltaic effect, this solar energy conversion to electrical energy is possible. As it has said, there are more ways to obtain energy, for example batteries. Actually this devices store energy rather than generate it. The combination that small unmanned satellites usually have is a primary source based on solar arrays and a battery as a secondary source. Furthermore on manned mission with large spacecrafts, the primary source is usually a combination of fuel cells. In the case of a long duration mission, where sometimes there is implication of space stations, the satellite uses fuel cells and also solar arrays.

The secondary source is a backup system in case the first one was not enough or in case of a failure in the primary source. It can also be used to develop functionalities that the first one can't realise due to its limited range of action. The main example is the part if the orbit when the position of the earth is between the satellite and the sun so an eclipse happens. In that case the solar panels don't "absorb" the same amount of solar radiation and to keep the main satellite subsystems working a power saver device that store enough energy is needed for this phase the orbit.

Finally, the power control and distribution network is in charge of controlling the voltage and current levels that arrive to all spacecraft subsystems in each phase of the flight. In addition, takes into account the energy sources degradation, which is an effect caused by possible failures, change in the illumination conditions, limited lifetime of the devices... and adapt their actuations to always guarantee the well performance of the subsystems. This network must have a dissipation system to discharge energy when necessary. A resistive load external to the main spacecraft, called ancillary load, is used to realize this function.

1.3.3. Solar Arrays

A solar array is an assembly of a lot of individual solar cells. Each solar cell has a p-n junction that is a combination of two types of semiconductor materials, p-type and n-type which are inside a crystal of a semiconductor. The "p" (positive) side contains an excess of holes, while the "n" (negative) side contains an excess of electrons in the outer shells of the electrically neutral atoms there. This allows electrical current to pass through the junction only in one direction. Knowing that, if the solar cells are connected properly in the array they provide dc power levels going from a few watts to tens of kilowatts. See figure 1.2.

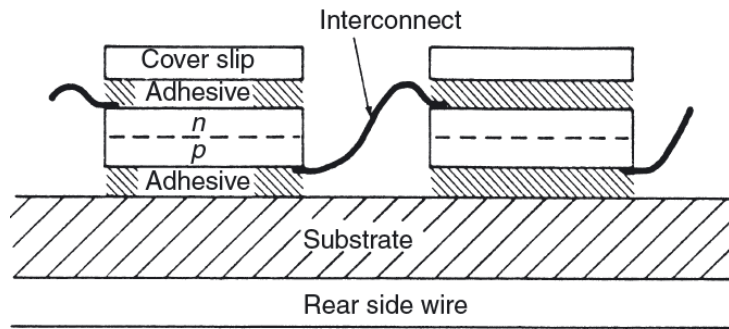


Fig. 1.2 Schematic of a typical solar cell assembly [2]

To be able to generate electrical power, a solar array must receive incident photon energy higher than a band gap that depends on the material of the cells. There is also a maximum energy of the photons that the array can convert into electrical power, if this maximum is overpassed; the energy is dissipated as heat in the cell in what mean a loss of efficiency. Table 1.2 has some of the band gap (minimum energy of the photon to “activate” the solar cell) and its associated maximum wavelength of some of the typical materials that are used to build solar cells.

Table 1.2. Properties of semiconductors materials [2]

Material	Band gap (eV)	Maximum wavelength(μm)
Si	1.12	1.12
CdS	1.2	1.03
GaAs	1.35	0.92
GaP	2.24	0.554
CdTe	2.1	0.59

The equation that relates the energy of photon E and the wavelength λ of the photon is defined as:

$$E = \frac{hc}{\lambda} \quad (1.1)$$

Where h is the Plank’s constant and c is the light speed in the vacuum. As h and c are both constants, the energy of the photons changes inversely proportional to the wavelength following the next expression:

$$E(eV) = \frac{1.2398}{\lambda(\mu\text{m})} \quad (1.2)$$

When there is an eclipse, this minimum energy of the photon is not achieved because there is not enough illumination so the junction achieves an equilibrium state in which no current flows. But when it is illuminated with suitable radiation, photons with sufficient energy will create electron–hole pairs, and the radiation

is converted to a potential with the electrons movement what generates usable electrical power.

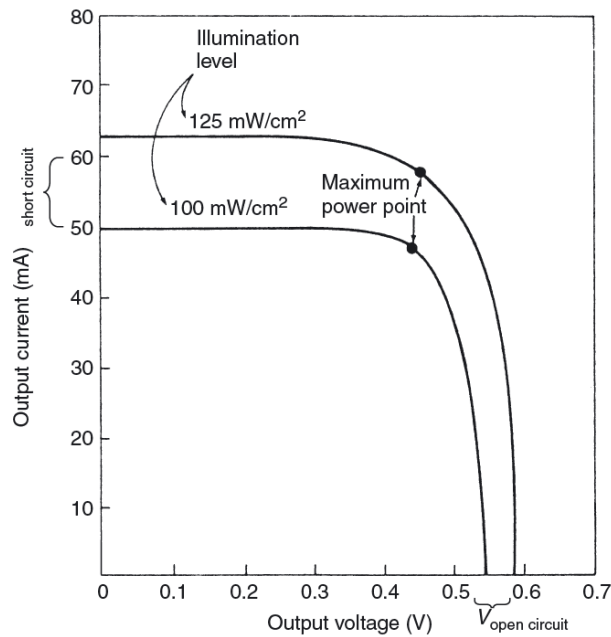


Fig. 1.3 Current-voltage curve for a typical solar cell. [2]

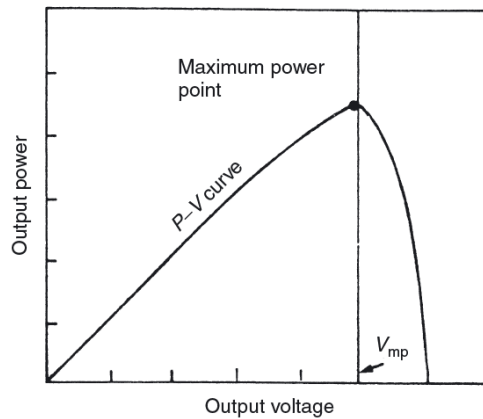


Fig. 1.4 Power-voltage curve for a typical solar cell. [2]

As it has said, the main functionality of a solar array is to produce electrical energy. To achieve the maximum levels of obtained power is really important to be aware of the output voltage and current of the solar cells. Figures 1.3 and 1.4 shows how there is a clear maximum electrical power production point taking into account the output voltage and the output current from a typical solar cell. In the first figure, 1.3, two illumination levels curves are showed where the maximum points make reference to the better current-voltage combinations. Figure 1.4 allows seeing how the power output increases when the output voltage does it too until arrive to the maximum power point where the curve starts to decrease.

The impact of temperature affects directly to the efficiency of the solar array. Figure 1.5 shows how the efficiency decreases until arrive to one point where no electrical power is produced. As it has been explained in this chapter, not

only there is minimum energy of the photon in which the solar cell can't produce electrical power, there is also an upper power maximum. From this same image, Figure 1.5, it can be also be seen the low efficiencies of the solar arrays. In the graph, in any point, the efficiency is higher than 30%.

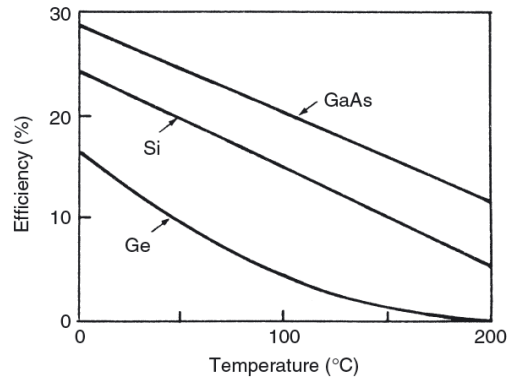


Fig. 1.5 Affectation of the temperature in the solar cell [2]

Another important aspect to be aware of the solar cells is the radiation damage. At this point, the selection of the materials is a crucial decision at the time to design a spacecraft and will be a mission type dependent. The selection of which material of the p-n junction is located in the upper face of the spacecraft will determine a better radiation damage protection. It has been tested that n-type materials must be in the upper face. Another consideration is that thin cells suffer less than thicker ones, but at present they have a lower conversion efficiency. GaAs cells are more radiation tolerant than Si and for this reason there is considerable interest and effort in their development.

Sometimes solar array has a cover glass that provides environmental and radiation protection. To summarize, in each mission the designer must have clear that must be a balance between the efficiency of the system and how protected it is. Depending on the conditions of the mission, the satellite will be designed in one way or another.

Another fact that can suppose a failure hazard is the interconnections between cells. When the satellite enters in a the part of the orbit where there is an eclipse or when it is in the eclipse zone and goes out of it, the strength of the temperature variation ($\sim 100^{\circ}\text{C}$ in a few minutes) is as abrupt that can provoke fracture between the different materials of the array. Some stress-relieving procedures exist to reduce the impact but it is still being an issue to be aware of.

To finish with the solar array chapter, it is time to talk about the interactions between the solar array and the vehicle. The relatively low conversion efficiency of an array, lower than 30%, is traduced in the necessity of large surfaces of solar cells to achieve enough solar radiation to deal with the power demand of the different the spacecraft subsystems. There are also more requirements to

take into account at the time to design a solar array, like the affectation of the rotation of a satellite guided by the attitude and control system that can imply, for example, a change in the temperature of the cell or in the angle of impact of the sunrays.

1.3.4. Fuel Cells

It is time to talk about the second type of primary source: fuel cells. They are electromechanical devices whose working principle is based on controlled chemical reaction between oxygen and hydrogen. A fuel cell converts the chemical energy of this oxidation reaction directly into electrical energy, with minimal thermal changes. The result of that process is also water which can be drunk by astronauts. The type of spacecraft that has this type of source is usually manned so the water obtaining is a problem already solved. Figure 1.6 is a schematic of how the internal process of a fuel cell works.

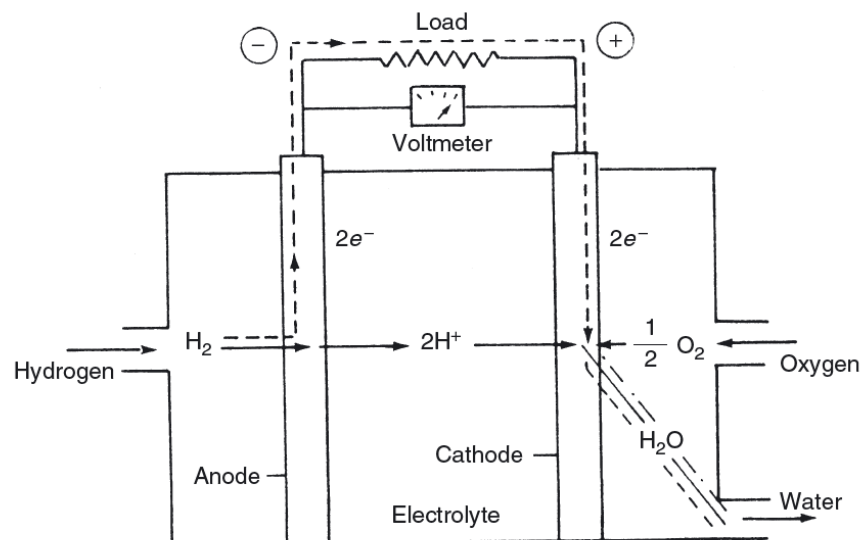


Fig. 1.6 Schematic of a hydrogen/oxygen fuel cell. [1]

The main advantage of using a fuel cell instead of a solar cell is the flexibility of using a source that is less dependent of the environment of the satellite. The eclipse periods doesn't affect to the behaviour of the fuel cell due to will be always working at the same way. Also, the fuel has a high-energy density and thus provides a compact solution compared with a solar array whose efficiency is strongly dependent to the temperature and solar radiation.

The obvious disadvantage is the necessity of carrying fuel on board, what means more weight and less autonomy.

In order to see how this primary source in terms of efficiency improves the performance of a fuel cell, Figure 1.7 is presented.

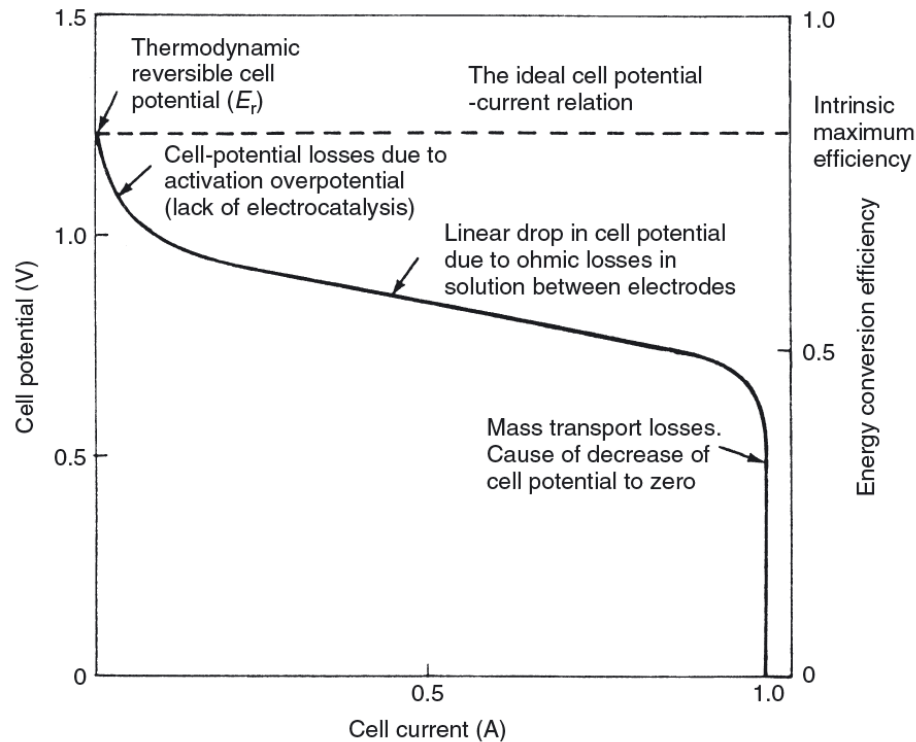


Fig. 1.7 Typical cell potential and efficiency.[2]

In the y axis of the right part of the Figure 1.7 is indicated the efficiency. Remember that in the solar cell chapter it has been said that the efficiency never is higher than 30%. In the fuel cells case, it is over that value in the major part of the graph. The possible overpotential losses are also indicated in the regions where they have affectation. All of these losses are common too in batteries. Their voltage and current characteristics are very similar.

1.3.5. Radioisotope thermoelectric generators (RTG)

The radioisotope thermoelectric generators (RTG) are based on the idea that is possible to generate a voltage if a temperature difference is maintained between two materials, being conductors or semiconductors. This is how a thermocouple works, following the Seebeck effect; there is a direct conversion between a temperature difference and electrical voltage generation and vice versa. See figure 1.8 to visualize the schematic diagram of a RTG.

Practical RTG space systems utilize two semiconductor materials: one p-type, the other n-type in order to exploit the effect and win efficiency. To be able of obtaining the temperature difference a heat source is needed. The result of a decay of a radioactive material is used. As this decay, it emits high energy particles that are used to create this desired temperature difference but not all the energy produced is tapped. Because such devices are relatively inefficient (less than 10%), one major problem in their design is removing waste heat produced in the decay process. The electrical power obtained of an RTG

depends strongly on the external temperature, the temperature difference between the materials and the properties of them.

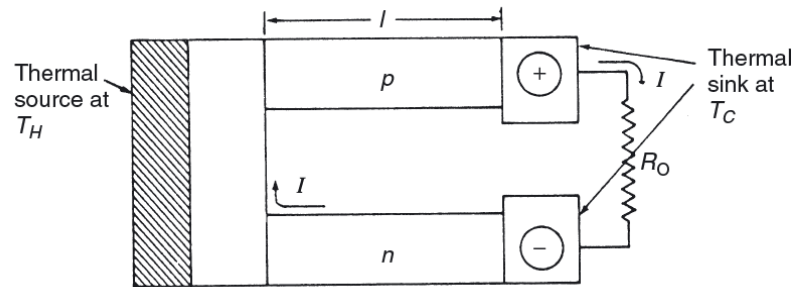


Fig. 1.8 Schematic diagram of a semiconductor radioisotope generator.[1]

RTG sources are implemented in those missions where the solar and fuel cells don't fit well. For a spacecraft whose mission is designed for going further from Jupiter, this source is the best option. A solar array based spacecraft would not receive as much solar radiation as it needs to operate efficiently. It is true that the reduction of temperature helps on delaying a little bit this fault of radiation because as it has said reducing temperature of the solar cells, they become more efficient, but as is logic a solar cell must receive enough levels of solar energy. The fuel cells based spacecraft can't be designed to do deep-space missions because of its strong dependency on fuel consumption, which is limited.

Table 1.3. Main advantages and disadvantages of RTG

Advantages	Disadvantages
Power production is independent of the orientation of the satellite.	As RTG uses a nuclear decay to produce energy, it creates a radiation environment that can be dangerous for the rest of element of the spacecraft.
Power production is independent to the distance to the sun.	More difficult integration of the system in the spacecraft vehicle due to the radiation hazard
Can produce low electrical power supply for long time periods.	High temperature operation is required for efficient energy conversion what can affect in the rest of the parts of the spacecraft
Not affected by Van Allen belts radiation.	Are source of interference for plasma (one of the main states of the matter) diagnostic. The study of plasma could be one of the objective of a mission.
Consistent performance in long eclipse time periods.	Political concern about carrying radioactive materials on board. Fear of a radioactive leak in the atmosphere.

1.3.6. Other primary power systems

In addition to the three sources explained, which are the more commonly used, there are more primary source possibilities. Examples are the nuclear fission systems and solar heat systems.

The nuclear fission system use uranium-235 as heat source to produce electrical power. It works like a typical nuclear power station. In space systems, this is used to drive thermoelectric converter as it has been explained in the RTG section. Is important to notify the high risk that this type of sources because a leak inside the atmosphere could have devastating effects. For this reason is not considered to current space missions, but it is has been used by the former soviet space programme.

The solar heat systems, which are in development, are based in the use of the solar heat, not the radiation for obtaining electrical power. The idea is to take advantage of the solar heat to actuate a heat engine and then a rotary converter. The remaining heat could be also profited to restart the loop. See Figure 1.9 to see a schematic of the process.

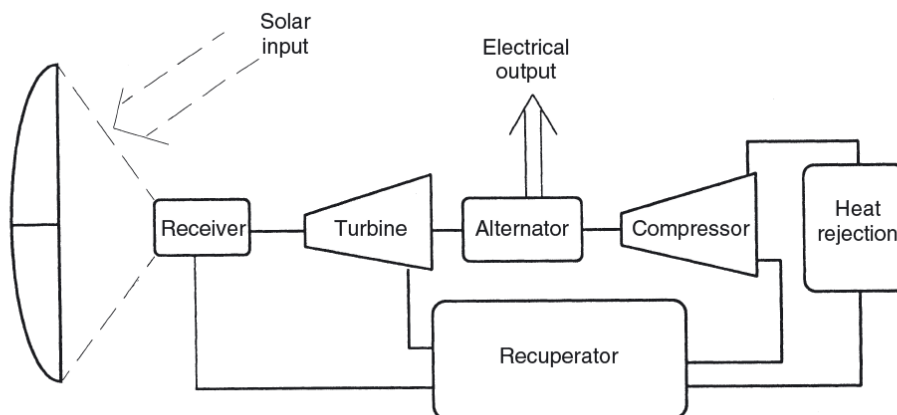


Fig. 1.9 Solar heat system block diagram [2]

This system has a 25% better efficiency than solar arrays so it is one the main investigation focuses in the past years. Also, it does not need as much surface as the solar arrays so the aerodynamic drag for LEO satellites is reduced so the needed fuel to keep a satellite in orbit does it too.

1.3.7. Secondary power systems: batteries

Once the main primary power sources are already explained, it is time to comment the secondary sources.

Batteries have been used extensively for the secondary power system, providing power during periods when the primary one is not available. As a back-up for a solar array this means that the batteries must provide power during eclipses, and that the array must recharge the batteries in sunlight.

Depending on the type of orbit of the performed by the satellite, one type of battery is needed or another. For LEO orbits, where the battery is needed in the 40% of the orbit due to long eclipse periods, large number of low-depth discharges is needed. In the other side, during GEO orbits, a smaller amount of deep discharges are needed because the periods of eclipse are shorter.

Table 1.4. Type of battery depending the type of orbit of the spacecraft

LEO orbits	Geo orbits
nickel–hydrogen (Ni–H ₂)	nickel-cadmium (Ni–Cd) or silver–zinc (Ag–Zn)

There are also two types of batteries that are in development: Li-ion and Li SO₂. The use of Li-Ion battery technology has increased its popularity in the recent years in the scientific and satellites application.

The main reason for choose one type of battery or another is related with the performance characteristics. The objective is to have a good reliability and charge efficiency to have an adequate charge control. The main parameters that allow quantifying these features are the charge and discharge rates, the depth of discharge (DOD), the extent of overcharging and the thermal sensitivity to each of these parameters.

1.3.8. Power management, distribution and control

The power management, distribution and control systems of a spacecraft do the needed functions of linking the electrical energy power sources to the different subsystems, for example: to the attitude and control system or to the payload. It's relevant to notify that the circuits must be compatible with all the power sources at the same time, and also must be ready for reacting to the possible failures of the system. The energy produced by the sources must be treated to arrive in a suitable way to each subsystem in terms of current and voltage.

The current and voltage requirements of the subsystems are variable during the mission, and also the electrical power production of the sources. For that reason there must be a system that “takes decision” with real time data to actuate or not the different subsystems depending on the situation. This is one of the missions of the scheduler. Also must be in charge of deciding if is needed to dissipate energy or not.

The main elements of the power management, distribution and control systems are the following ones:

Table 1.5. Different functionalities of the power management, distribution and control elements

Elements	Functionality
Battery control	Battery management unit (BMU): in charge of the motorization of the battery's and cells temperature, pressure and voltage
	Battery charge regulator (BCR): has the responsibility of charging the battery providing a constant current charge during sunlight operation.
	Battery discharge regulator (BDR): supplies a constant current to the spacecraft bus during eclipse operation.
Power control and distribution unit (PCDU)	It protects the current on the electrical buses, limiting the magnitudes allowed adding fuses to the circuit.
Power conversion unit (PCU)	This unit is in charge of adapting the source output electrical energy into the individual voltage and current characteristics required for subsystems. Also must protect the subsystems in case of over or under voltage levels when the different loads are switched on and off.

1.3.9. Power budget

In the previous sections, have been outlined the different technologies principles behind a power system. Then it is time to talk about the methodology used to design a power system for a space mission.

The first step is to define the different electrical loads or subsystems that must be feed, defining the electrical magnitudes whose performance requires. As it has said several times, the mission conditions will change during the whole flight so the full range of possible scenarios must be taken into account. The initial analysis must be aware of the mission profile and the power demand in each situation.

There are three critical issues that need be considered: the orbit to perform, the nature of the mission and the mission duration.

The orbit selection is really important because the entire radiation environment depends on it: the amount of solar radiation, temperature, eclipses duration... Depending on these parameters, the electrical sources and the rest of devices of the power system will be defined.

The nature of the mission is actually the objective of the mission. A few examples could be: telecommunications, observation or scientific. The subsystems on board will be strongly related with the nature of the mission. For example: telecommunication systems satellite must be transmitting information without stop. They don't have the same working requirements as an earth

observation satellite whose mission doesn't need to be transmitting continuously. Each satellite mission has its own objectives. To satisfy them, the logic at the time to distribute the electrical power must know what systems must be always working and what the most important ones are. This is another function of the scheduler. Furthermore, at the time to design the satellite, knowing the nature of the mission will help a lot at the time to select components and working requirements.

The mission duration information is really important because as it has said, there are different degradation affectations that must be taken into account. With more time of flight, more time of degradation exposition and, as is logical, more degradation in the satellite systems performance. The most important information deduced from the mission duration is the total amount of solar radiation expected and the number of eclipse cycles expected. Both are related with the temperature impact and also the temperature changes impact. As it has explained, the primary sources and the batteries have a temperature dependent performance. To know the duration of the mission will allow the designer to be aware of the number of temperature changes that the system will face and it will help in the choosing decision of which equipment is the most suitable for the spacecraft.

1.4. THERMAL BUDGET

1.4.1. Introduction

As it has already mentioned, the spacecraft thermal control, which involves the temperatures of the equipment and structure, is a key factor at the time of design a satellite. Consequently is really important for the mission analysis. The main reasons that make the thermal control as important are the limited range of temperatures in which the different devices of the spacecraft realise its work with an acceptable level of efficiency and also the distortion that temperature can provoke in the materials. The thermal budget is in charge of controlling the temperature of the satellite.

The major part of the spacecraft equipment is designed to operate at room temperature because were initially designed to work on ground. Also, take into account that is easier and cheaper to realise all the performance tests in that temperature conditions. Adapt this terrestrial use devices to a space functioning ones is not an easy task, the thermal control engineer must add passive and active control elements to the spacecraft when the thermal environment doesn't allow to achieve the desired thermal working conditions. Besides, not all the devices can work at the same range of temperatures.

Studying the thermal environment of the satellite is the first step at the time to design the thermal control system. The environment supply heat to the spacecraft and also the own satellite systems produce heat that can be reused. The heat of the space environment is basically occasioned by the solar radiation. The balance between the amount of heat entering and the amount

departing define a balance that determines the spacecraft temperature. A thermal control engineer must do a deep *analysis* of the mission in order to predict the different spacecraft temperatures during all the phases of the flight. Knowing that information, it must *design* a system capable of adapting to the different situations, providing the adequate temperature to each subsystem. Is here where the passive and active control techniques are added. The final part is *testing* the system in extreme conditions to being able to validate the feasibility of the mission from the point of view of the thermal design.

1.4.2. Thermal environment

The space environment is characterized by its high vacuum. Usually the spacecraft is designed to orbit in regions of the atmosphere where there are small pressures that generates low amount of drag. This means that there is also an absence of aerodynamic heating and indeed any convective interaction with environment. Of course, this is an approximation because even though the amount of pressure is low, it is not zero.

The most important interactions between the spacecraft and it environment are the direct solar radiation, the solar radiation reflected from nearby planets (albedo radiation), the thermal energy radiated from nearby planets (planetary radiation) and the radiation from the spacecraft to deep space. See figure 1.10.

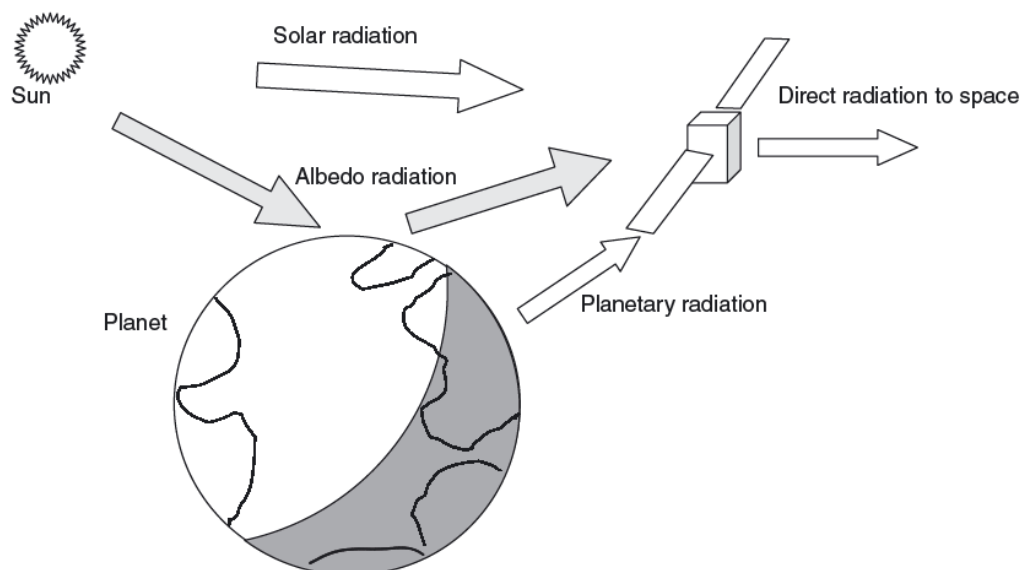


Fig. 1.10 typical spacecraft thermal environment [2]

It is logic to think that there will be a thermal equilibrium when the sum of the direct solar radiation, the albedo radiation, the planetary radiation and any thermal dissipation of the spacecraft, will be equal to the amount of energy radiated to deep space. This balance will determine the physical temperature of the spacecraft.

1.4.3. Direct solar radiation and albedo radiation

The most important parameters about the solar radiation are the spectral distribution, that can be considered constant, and the solar irradiance.

Also the solar radiation intensity is really important. It is defined by the following expression:

$$J_s = \frac{P}{4\pi d^2} \quad (1.3)$$

Where d is the distance to the sun and P the total power output from the sun, 3.856×10^{26} W. See Table 1.6 to see the average values of J_s arriving to the different planets of the solar system.

Further from the direct solar radiation, the fraction of solar radiation reflected by a planet or its atmosphere is really important. It is called planetary albedo. It depends on the material of the surface where the solar radiation impacts, but the full albedo of a planet can be considered constant from the thermal design point of view.

The intensity of albedo can be obtained from the following expression:

$$J_a = J_s a F \quad (1.4)$$

Where J_s is the intensity of the solar radiation, a is the average planetary albedo, see Fig 1.11, and F is the visibility factor, which is obtained from β (angle between the local vertical and the Sun's rays) and the altitude of the satellite.

Table 1.6. Planetary solar constants and albedo values [2]

Planet	Solar radiation intensity, J_s (percentage of solar intensity at 1 AU)	Planetary albedo, a
Mercury	667	0.06–0.10
Venus	191	0.60–0.76
Earth	100	0.31–0.39
Moon	100	0.07
Mars	43.1	0.15
Jupiter	3.69	0.41–0.52
Saturn	1.10	0.42–0.76
Uranus	0.27	0.45–0.66
Neptune	0.11	0.35–0.62
Pluto	0.064	0.16–0.40

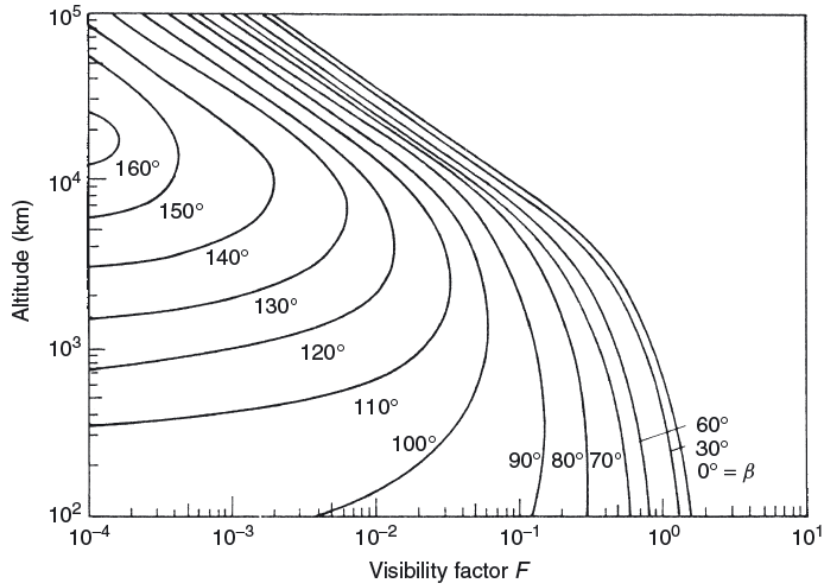


Fig. 1.11 Spacecraft albedo irradiation in function of β and altitude [2]

1.4.4. Planetary radiation

The planets of the solar system radiate heat because anyone of them has a non-zero temperature. Talking about the earth, a good approximation of an average value of its radiation intensity is 237 W/m^2 . Only few errors occur if this average value is used. The intensity of the planetary radiation decreases with the altitude of the orbit following the next expression:

$$J_p = 237 \left(\frac{R_{rad}}{R_{orbit}} \right)^2 \quad (1.5)$$

Where R_{rad} is the radius of the Earth's effective radiating surface (not easy determinate. For most practical purposes it is used the radius of the Earth's surface, R_E). R_{orbit} is the orbit radius.

For other planets, another models must be taken into account to compute J_p .

As it is logic, the incident energy received by the spacecraft is obtained from the following expression:

$$J_{incident} = J_s A_{solar} + J_a A_{albedo} + J_p A_{planetary} \quad (1.6)$$

Where A_{solar} , A_{albedo} and $A_{planetary}$ are the projected areas receiving solar, albedo and planetary radiation.

Truly if internal losses, Q , of the spacecraft are taken into account, the expression should be:

$$J_{incident} = J_s A_{solar} + J_a A_{albedo} + J_p A_{planetary} + Q \quad (1.7)$$

1.4.5. Thermal Balance

The main objective of thermal balance is finding the spacecraft temperature. As it has been commented, the balance between the amounts of heat received from the environment and internal sources and the radiation from the spacecraft to the space defines the spacecraft temperature. So the heat absorbed and the heat radiated are key factors.

The spacecraft is not a black body that absorb all the energy that arrives to him. Only a fraction α of the incident energy is absorbed called absorptance.

$$J_{absorbed} = \alpha J_{incident} \quad (1.8)$$

Also, the spacecraft radiates a fraction ε of the radiation of a black body at the same temperature called emittance.

$$J_{radiated} = \varepsilon \sigma T^4 \quad (1.9)$$

Where σ is the Stefan-Boltzman constant equal to $5,67 \cdot 10^{-8} \text{ Wm}^{-2}\text{K}^{-4}$.

It is relevant to notify that the absorptance and emittance of each material of the spacecraft is variable.

If there are no internal heat dissipations, thermal equilibrium is obtained when the following expression is achieved:

$$A_{\alpha} J_{absorbed} = A_{\varepsilon} J_{radiated} \quad (1.10)$$

Being A_{α} the effective absorbing area, which is the projected area of the spacecraft facing the sun, and A_{ε} the emitting area.

Joining equations (1.9) and (1.10), it can be deduced that:

$$A_{\alpha} \alpha J_{incident} = A_{\varepsilon} \varepsilon \sigma T^4 \quad (1.11)$$

So the equilibrium temperature is given by:

$$T^4 = \frac{A_{\alpha} J_{incident}}{A_{\varepsilon} \sigma} \left(\frac{\alpha}{\varepsilon} \right) \quad (1.12)$$

The final objective of the thermal balance is achieved: the temperature of the spacecraft is known. From the final expression, a big consideration can be obtained. As A_{α} , A_{ε} and σ are fixed values, for a given $J_{incident}$, the temperature can be controlled modifying the value of the $\frac{\alpha}{\varepsilon}$ (absorptance/emittance ratio).

The problem is that α and ε are not independent variables. The laws of thermodynamics imply that $\alpha = \varepsilon$ (Kirchoff's law) If the wavelength in the

absorptance and emittance processes are the same. Fortunately, absorptivity and emissivity generally vary with wavelength and we have already learnt that the radiation environment of a spacecraft is basically composed of radiation either at 'visible' wavelengths or in the infrared. It is this feature that makes spacecraft thermal control possible.

As it has said α and ε are material dependent parameters. Table 1.7 indicates some of the most used materials and its absorptance and emittance values.

Table 1.7. α and ε values for several surfaces and finishes [2]

Surface	Absorptance (α)	Emittance (ε)	α/ε
Polished beryllium	0.44	0.01	44.00
Goldized kapton (gold outside)	0.25	0.02	12.5
Gold	0.25	0.04	6.25
Aluminium tape	0.21	0.04	5.25
Polished aluminium	0.24	0.08	3.00
Aluminized kapton (aluminium outside)	0.14	0.05	2.80
Polished titanium	0.60	0.60	1.00
Black paint (epoxy)	0.95	0.85	1.12
Black paint (polyurethane)	0.95	0.90	1.06
—electrically conducting	0.95	0.80–0.85	1.12–1.19
Silver paint (electrically conducting)	0.37	0.44	0.84
White paint (silicone)	0.26	0.83	0.31
—after 1000 hours UV radiation	0.29	0.83	0.35
White paint (silicate)	0.12	0.90	0.13
—after 1000 hours UV radiation	0.14	0.90	0.16
Solar cells, GaAs (typical values)	0.88	0.80	1.10
Solar cells, silicon (typical values)	0.75	0.82	0.91
Aluminized kapton (kapton outside)	0.40	0.63	0.63
Aluminized FEP	0.16	0.47	0.34
Silver coated FEP (SSM)	0.08	0.78	0.10
OSR	0.07	0.74	0.09

At this point, the external thermal balance comment is finished. On the other side, the internal one is going to be explained in the next chapter. The internal balance is crucial because is in charge of warranting the adequate thermal environment supply to each subsystem of the spacecraft. Of course the internal balance will be conditioned by the external one, because of that, it is explained first.

1.4.6. Thermal Analysis

The internal temperature of a spacecraft is really difficult to compute due the continuous variability to which is exposed. It changes with the location and time. The calculation of these temperature fields for all practical purposes is impossible. The solution is to divide this big problem in different parts to simplify. This is achieved generating a model of the spacecraft amenable to mathematical treatment. Such a representation is known as a thermal mathematical model (TMM).

A TMM is built considering that spacecraft is composed by a number of discrete regions called isothermal nodes (because its temperature gradients can be neglected). Each one of the nodes has a temperature, a thermal capacity, a heat dissipation and radiative and conductive interfaces with the surrounding nodes. The nodes of the spacecraft that can 'see' space directly will also have radiative interfaces with the external environment.

In that TFG the deep analysis of a TTM is far from the main objective so it is not explained. What it is important about TTM is that all the parameters of each isothermal node are take it into account at the time to compute the internal thermal balance. Also as more complex is the spacecraft is, more complex must be the TTM too.

Once the TTM analysis is done, and the expected internal temperatures of the spacecraft are known, the thermal controller starts on designing the passive and active thermal control systems. It is better to design passive devices which will not imply the use of electrical energy, but in most of the cases, actuators are needed. At this point the thermal and power budget crisscross is interests: To be more efficient, the power system must spend a part of its energy on the thermal system to warranty the good performance of the spacecraft subsystems. The scheduler of a spacecraft must control this.

1.4.7. Passive control

The main passive thermal control techniques consist essentially of selecting the adequate surface materials taking into account its properties, the control of conduction paths and thermal capacities and the use of insulation systems.

The main passive control devices are the following ones:

Surface finishes: As it has explained previously, in order to modify the spacecraft temperature, the only that the designer can modify is the emittance and the absorption. This is done selecting one material or other. The paint of the surfaces is also very important. See table 1.7 to see the properties of the most used materials.

Conduction paths: Are used to transfer heat inside the spacecraft structure. Examples are the two-phase heat transport systems such as heat pipes, loops heat pies and capillary-pumped loops. Two-phase transport systems use a volatile working fluid that is circulating in a porous wick structure.

Phase change materials: It consits on materials that do solid-liquid phase changes during the operation. This changes allow the material absorbing or releasing heat depending the situation.

Insulation systems: Are designed to minimize radiative exchanges. Basically, they are built by layers of aluminized plastic film acting as radiation shields, each separated by a low conductance spacer.

1.4.8. Active control

The active thermal control systems are needed when the passive ones are not enough to warranty the adequate thermal conditions that the subsystems require. Active devices are more complex, require more power consumption, sometimes need telemetry resources, less reliable and heavier. The following ones are the most commonly used:

Heaters: Are the simplest ones. A heater is activated when an established minimum temperature is reached. It changes his state when the temperature rises until another established temperature value.

Variable conduction paths: They are more sophisticated devices based in the idea of the two-phase transport systems already commented. They add actuators to block or modify the path of the heat conductor fluid.

Louvres: A louvre is a device that changes the effective emittance of a radiator in in function of the temperature. Usually is mounted on the outside of a radiator panel and typically consists of an array of metallic blades.

The concept is shown schematically in Figure 1.12. When the blades are open (perpendicular to the radiator surface), the radiator has a good view of space and radiates accordingly. Oppositely, when they are closed the radiator sees a low-emittance surface and most of its radiated heat is reflected back.

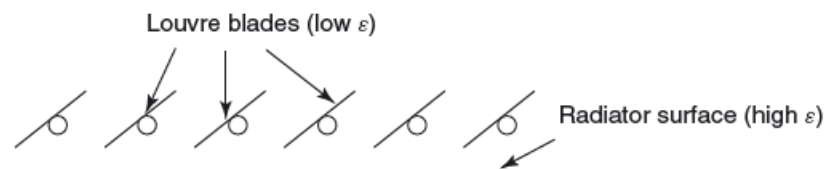


Fig. 1.12 Schematic illustration of a louvre.[2]

Heat pumps and refrigerators: A heat pumps is used to increase the temperature and so on, the radiated heat. It consumes power and mass. Also, heat pumps and refrigerators can be used to cool if the temperature arises more than what is wanted. In some cases a subsystem could require low temperatures.

1.5. DATA BUDGET

1.5.1. Introduction

Once power and thermal budget are already commented, it is time to focus on the data budget. It manages the telemetry, command, data handling and processing functions of the information between a spacecraft and ground control stations.

It exist big differences between the downlink transmission and the uplink reception. Downlink communication is mainly used to monitor the state of the satellite and also to send the data obtained from the payload if there is not a payload communication channel or if it is congested, for example the photos of a camera in an earth observation mission. It is called telemetry downlink. In the other side, the uplink communication is used basically to send modifications to apply in the satellite, for example a thrust activation to modify the trajectory of the orbit. It is called command uplink or telecommand.

Some parameters that affect to the power and thermal budget also do it to the data budget. The type of payload, the mission, the environment of the satellite and the orbit play an important role at the time of designing the telemetry, command data handling and processing functions. Also the ground stations location and characteristics have impact.

The link between ground stations and the spacecraft can be constant or intermittent due to the affectation of all the parameters commented. For this reason, a spacecraft must have different mechanisms and devices to make the data management and transmission efficient, for example: data storage memories, prioritization mechanisms, error prevention techniques... GEO orbits have commonly a constant link while LEO has an intermittent one.

The data treatment and communication is limited not only by the data budget restrictions that will be commented in that chapter, it is also affected by the power and thermal requirements. For example if the spacecraft wants to send a picture obtained from the payload to a ground station when there is a link, maybe the power system can't supply enough power to activate the LBAND transmission because is activating the heater because the spacecraft is in an eclipse. The logic that the spacecraft follows at the time to manage all the processes already commented is incorporated in the scheduler because it has the data of three budgets.

1.5.2. System architecture

The first thing to take into account at the time of understanding how a data system works is have clear that telemetry is mainly referred to data measurements while a command is an order to execute. The subsystems of the satellite produce telemetry that is analysed by the on-board computer, where the scheduler is. Also if there is a link with ground station, the telemetry can be analysed by a human or a computer. With this telemetry, the on board computer analyse if it is necessary to emit a command to modify something in the behaviour of any subsystem, following the logic of the scheduler. Thanks to the uplink command, the subsystems also can be controlled from the ground station.

The system architecture involving the telemetry, command and data-handling with respect to the main subsystems of the spacecraft is expressed in figure 1.13.

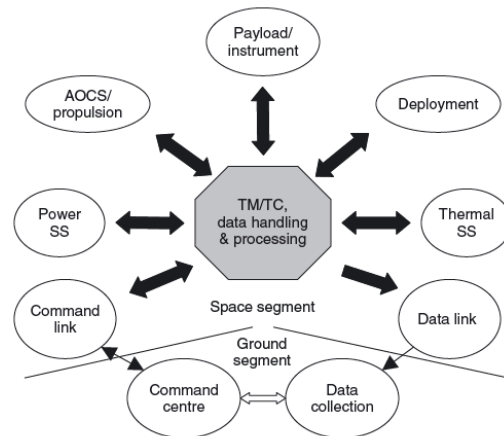


Fig. 1.13 System architecture [2]

As it can be seen in figure 1.13, telemetry, command, data handling and processing affect to each subsystem. This is because all of them at least, must been monitored (telemetry) and controlled (command) from ground stations or from the on board computer (where the data handling and processing is done). The logic of this on board computer is represented in the scheduler because it must take into account thermal and power data. The data handling and processing section is in charge precisely of analysing the data obtained from the different subsystems and actuate if is necessary and of course if it is possible.

Data link and command link in figure 1.13 are in charge of the downlink telemetry and uplink command, but as can be seen, they must pass across the on-board computer before finishing the link between any subsystem and the ground station. This means that the selection of what information is shared depends on the on-board computer. It is logic because it has the information of the power, thermal and data budgets at the same time and knows if the link is possible or not.

1.5.3. On-board computer

As it has said, the on-board computer is in charge of receiving telemetry data from the subsystems, realise the on-board data-handling functions following the scheduler logic and it emit commands if necessary.

The on-board data handling functions depends strongly on the mission type. For example in the case of a telecommunication system, the main function is keeping the health and position of the platform which the payloads are situated. In the rest of the missions, the most important is the data obtained from the payload, for example the photos obtained in an earth-observation mission. This data is sent to the ground station when is needed and when is possible. These missions usually have different working modes that can change according to the mission phase or data product required. Each working mode varies the logic followed by the on-board computer in order to work in one way or in another.

The typical functions that can be required of the on-board data-handling system usually are the following ones:

- Making autonomous decisions following the scheduler logic.
- Monitoring spacecraft subsystems well-behaviour.
- Enabling the flow of telemetry data.
- Receiving, distributing and executing commands.
- Performing telemetry and telecommand protocols (explained in the following sections) performing data compression.
- Providing data storage.

Sometimes data compression is needed at the time of transmitting telemetry or telecommand. It can be achieved by eliminating the redundant or duplicate content of the data. Image compression can be achieved by eliminating, for example, unwanted information or by reducing the resolution.

One of the commented functions is providing data storage. It is an important function for missions in whom the data volume produced is greater than the link capacity and/or availability. An example could be an earth-observation mission whose objective is transmitting images from a camera on-board. The transmission could be if there is an available, link between spacecraft and ground station and the scheduler dictates that is possible realise the communication. In the rest of the situations the image must be stored until the moment that can be able to be sent. The capacity of the storage is not unlimited so controlling the availability of the storage is a function of the on-board computer and therefore of the scheduler.

There can be more than one on-board computer. This allows the system to be less centralized in the case that the different on-board computers realise independent functions. Sometimes a spacecraft have on-board computers as backups in case of failure of the main ones.

1.5.4. Telemetry

Take into account the content of the telemetry data can be divided mainly in three different fields. The first one is attitude data, which are obviously the measurements obtained from the ADCS (attitude determination and control system) system. The second one is the telemetry obtained from the payload. The last one involves the housekeeping telemetry data which is basically the measurements of the rest of subsystems.

About the *housekeeping data*, a few examples of the data included in the telemetry could be the temperature and pressure measurements of the different systems. Also the voltages and currents are included too. Other interesting data are the operational status which indicates if a subsystem is working or not. There are also redundancy status data in order to make the system more resistant. All of this information goes to the scheduler of the on board computer that analyse it and execute commands if it is necessary.

Independently that there are a lot of parameters to be monitored, generally it is not necessary to do it each second so this type of telemetry does not require a big bandwidth. The intervals are usually between 30 and 120 seconds. Taking into account that modern satellites have more or less 1000 parameters to be monitored, with a bit rate of a hundred bits per second should be enough.

The attitude data is basically obtained from the obtained from a variety of sensors such as Sun, Earth and star sensors, gyroscopes and accelerometers. It is an individual telemetry data subsection because during some phases of the flight it requires a lot of bandwidth due to the sampling of the data obtained is done in a different way of the rest of the data. A lot of measurements must be done 4 times per second for example.

The *Payload data* depends strongly in the type of payload. The missions of earth observation require big amount of telemetry data. It is not the same to transmit an image than a few monitoring bits.

Depending the phase of the mission, the telemetry will change a lot. For example in the ground testing and launch phase, the main telemetry data's obtained are the attitude and housekeeping, but during the in-orbit phases, the telemetry rates of the housekeeping data reduces because the intervals of measurements increase. In the In-orbit phase the payload usually starts working and emitting telemetry.

All telemetry data must be formulated in an analogue way or digital by-level or digital serial. Then a standardised word format is filled with the data. The way that this encoding is done is far from the main objective of this TFG so it is not going to be explained.

1.5.5. Command

As it has said, a command is an order that is generated or in the on-board computer or in the ground station to apply a change in the current behaviour of one or more subsystems of the spacecraft. The telecommands, which are the commands generated in a ground station, are received via, typically, an S-band link (2025-2120MHz), decoded and placed in a queue for either internal distribution or distribution to the other subsystems. The on-board computer realise this task.

It exist various standard codifications as it happen with the telemetry data. The format of commands must be efficient and compatible of course with both the ground stations and the spacecraft.

CHAPTER 2. CODE IMPLEMENTATION

2.1. Simulator

2.1.1. Definition

Realise a satellite space mission is a really expensive practice; the price of the components of the satellite are really high for example. But not only economic resources are needed: various professionals spend a lot of time planning and preparing all the details to try to have a successful mission. In order to assure that everything is going to behave well is necessary to perform lots of tests with a simulator before to do the real launch of the satellite.

The objective of this work is improving a simulator capable of realise satellite space missions. The simulator is programmed in Matlab. It is really difficult reflecting the reality conditions into a program but always a good approximation will be better than nothing. Furthermore is important to say that this software is expected to be a professional, solid and reliable simulator for professionals of the sector. There are different areas where it can be improved, also after the contributions of this work, but this is the main objective: make the simulator as much real as possible.

The simulator is very customizable; the user can decide a lot of inputs into the program. This is really important because there are several types of mission and is important to try to suit as many users as possible.

The user can select the shape of the satellite, the on-board components characteristics of the satellite, the characteristic of the orbit, the thermal environment and energetic environment that the satellite will face during the simulation, of course the duration of the mission... and a lot of more which will be better explained in posterior sections.

The software is prepared to realise simulations of missions whose main objective is taking photography's of a group of earth target areas (three as most) and download this images captured into ground stations (three as most). The energy to keep the satellite is obtained from a battery which is filled with the energy obtained from solar panels.

The output of the program is a lot of plots and graphs that show how the satellite has behaved to the mission. As is has said the mission characteristics, depend in the inputs that can be decided by the user. It also indicates how the different subsystems have performed its functions. To put a few examples of the output of the program: it shows how the battery charge evolves, the state of the memory, the position and velocity of the satellite, the consumption of the subsystems, the temperature of the satellite, the number of photos captured

and where this captures have been taken, the places where the downloads are done...

The simulator is designed to add to him improvements in an easy way. The code is structured in functions which realise specific tasks that can be easily substituted by improved ones.

Furthermore the program works using masks. The mask concept is a tool used to be able to add improvement to the coded in a fast way without the need of changing the full code. In that specific case are mainly used to change easily the way that the different subsystem consume. The masks are Boolean vectors in which a 1 in a component means an activation of a subsystem (or other things) and 0 not. In the scheduler function this masks are multiplied by the real consumption of the subsystems. Also a mask can be used to create constraints and other relations. The use of masks allows changing the consumption models without the necessity of changing the full code.

In the next section will be explained how the code is structured, what is the objective of each function and the relation between them.

2.1.2. Structure

The code is structured in a simply way: It has a main script, called MOTS, which has two purposes: Be the part of the code where all the input parameters are introduced and call the rest the main functions.

What MOTS script does first is charging a group of relevant constants needed for doing the different computations. This step is also done in the functions that will be explained after. A mission profile is also charged. The mission profile is not really relevant for this work, is related with the functioning of the camera.

Then, time parameters are defined, for example the elapse time of the simulation or the end of the deadline of the software use. It is important taking special consideration to the seconds between samples parameter which is a key design factor at the time to take results. This parameter defines how many iterations the simulations will have. It is the relation between time and number of iterations. Later will be explained how is used exactly. Consequently the selection of that parameter will be strongly related with the quality of the results and the speed of the software.

The following input parameters are the ones related with satellite platform definition: shape, materials properties, height, weight... After that, some of the orbit parameters are introduced: the height and inclination, the number of orbital planes and the number of satellites per plan, the RAAN and the true anomaly each orbit, if there are more than one...

The ground stations and the target areas are defined at this point, indicating if they are activated or not, their latitude, longitude and altitude and in the case of the target area, the circular radius of influence. The ground station also takes

into account the minimum elevation above the horizon to be able to see the satellite from the ground station. At most three ground stations and three target areas could be defined.

The next parameters to introduce are the payload ones. Basically, the payload is going to be a camera, so parameters like the number of pixels in the crosstrack direction, the number of pixels in the alongtrack direction, the dimension of the pixel, the fps, the characteristics of the lens...will be defined at this part of the code.

The next group of parameters are the ones strongly related with the power budget of the satellite. In this section, the first input parameters are the power radiations that arrive to the satellite originated by the earth and the sun. The albedo is also defined in this section. After that, the different systems parameters that are included in the power budget are defined in an orderly manner: The batteries (including the heater), the EPS, the OBC, the ADCS, the S-Band Transmitter, the solar panels, the payload, the OBC secondary, the VHF/UHF transmitter and the AIS... where is basically indicated the consumption, the voltage allowed, the efficiency and the performance limitations of each section. It is important taking consideration that in the solar panels section, the amount of panels in each side of the satellite and also the size of them can be defined.

The next parameters defined are the absorbance and admittance of the materials of the satellite and the ones for the solar panels. After that, the temperatures which the heater must change its state are defined and also the minimum and maximum temperature to active the too-low-temperature protocol and the too-high-temperature protocol respectively.

Then is time to define the data flow parameters. For example: the compression factor applied to the image due to download process optimization, the percentage of the images that will be overlapped, the traffic generated by the telemetry, the limit of the memory, the transmission velocity of data, the maximum percentage of the memory that can be filled and the digitalization of each pixel.

Finally, when all the parameters are defined, the last functionality of MOTS is executing the main functions of the code.

The first main function is the **payload analysis**. This is not a relevant function for this work. So it is not going to be explained. It has relation with the technical functioning of the camera.

The second one is the **orbital analysis**. What this function does first is computing the beginning and the ending of the simulation. To do that, it creates a vector with all the time instants where a measurement is going to be made. The parameter that defines how many elements this vector will have is the `sec_between_samples` parameter. As smaller this parameter is, more time divisions that array is going to have what means larger vector, and consequently a slower code but more accurate. The different measurements of

the satellite that will be explained later are going to be arrays with the same number of elements (N). Doing that, each measurement can be easily related with the time when happens. Furthermore different measurements can be joined in a graphic that will allow the user of the program to visualize what is happening in every step of the mission.

It arrives the time when the code computes the Keplerian elements: The altitude of the orbit, its eccentricity, the inclination, the obliquity of the ecliptic, the RAAN, the argument of perigee, the true anomaly...

The next step is the computation of the position and the velocity of the satellite in the ECEF coordinates system from the Keplerian elements previously obtained.

The function also does the conversion to the lat/long reference system going by the ECI reference system.

The next function to analyse is the one called **GS AND TA SHOW**. What this function does first is perform the function of an orbital propagator.

How the lat/long coordinates have been computed, so trajectory is already defined. This information is useful to know if the satellite is passing across a target area or a ground station. If this situation happens, the contact mask of GS or the contact mask of TA switches to activated.

The next function to analyse is the **Satellite sun show** one. The first assignment of the function is locate the sun in the simulation and after that determine which faces of the satellite are pointing towards it in each time instant of the simulation. All of that is used to compute vectors with the thermal environment that the satellite will face during the mission. This function also computes the affectation of the albedo and the time of the simulation when an eclipse occurs due to the interposition of the earth between satellite and sun.

PWR TH DADRA BUDGET SHOW is the last function that the code executes; it is where the scheduler is implemented. All the information computed in the commented functions goes to this one: the trajectory vectors, the contact vectors, the eclipse vectors, the thermal environment vectors... With all of this information the scheduler can start working. Iteration after iteration, it uses the data computed in the other functions and other computations realised in whose own function to decide how the satellite must behave. It can activate or deactivate subsystems depending on the necessities of the satellite of each moment. To know what the best action to take is, it analyses the state of the different budgets: power (charge of the battery), thermal (temperature of the satellite) and data (state of the memory). It is the task manager of the satellite. In later sections will be in detailed explained how the scheduler works.

This function also realise most of the plots of the mission. It is obvious because is the last function that the code executes.

2.1.3. Project Contribution

The main objectives, functionalities and structure of the simulator have been already commented. It is time to explain how this work will contribute of improving this software.

The scheduler, the task manager of the satellite is the main field of action. The logic has been modified in order to work in a more optimum way.

The previous version of the scheduler, before the addition of the contributions that will be explained in that work, was designed for running satellite missions, but it was not ready for self-manage in a lot of situations. If the environment conditions, duration, objectives were not the proper ones, the satellite entered in collapse. It didn't manage the undesired situations in a desirable way.

The solution has been the implementation of working modes to the simulator. It is another task added to the scheduler which decide which the optimum mode for each situation is. This work tries to demonstrate the resistance of the new logic of the scheduler and how the improvements convert the simulator in a device useful for a huge range of space missions. Furthermore, the implementation of working modes to a satellite is a realistic approximation because is a common practice done in most of the space missions.

The implementation of the working modes also gives the user the possibility of performing a same mission in different ways. This is something than in previous version was not possible.

As it has said the objective is make the simulator more realistic. In order achieve this objective, some software improvements have been applied. These software improvements are not necessary part of the scheduler, they are functionalities added to make the simulator a device that could be used to plan more types of missions.

2.2. Scheduler

2.2.1. Inputs

It is time of explaining how the scheduler of the simulator behaves. As it has said is part of the **PWR TH DADRA BUDGET SHOW** function. To understand how exactly operates it is precise know what are the inputs to this function. Lots of parameters and vectors arrive to this function.

The first group are the parameters related with time: the time vectors, the duration of the simulation, the seconds between samples parameters, which will be very useful to change between time and samples, and of course the N parameter that determine the length of all the vectors that will be built.

The second group of parameters are the contact masks. As it has told a mask is a Boolean vector. There are three types of vectors: the mask that indicates if there is a contact with a ground station (understanding a contact when the

satellite is over a target area or when the allowed angle of deviation permits the satellite camera pointing to a target area), the mask of contact with ground stations, and the mask that indicates which samples require a deviation of the reaction wheels (this are cases where the camera must deviate to point a target area).

The third group of input parameters are the ones related with the environment the satellite will face during the mission: the vectors indicating when an eclipse will occur, the radiated power of the sun depending during the simulation, the albedo, the earth radiated power and the initial temperature of the satellite. It also arrives the computed projected area of the sun in each side of the satellite.

Then the following input parameters are the ones related with the performance capacities and features of the satellite and his subsystems.

About the satellite; the solar panels characteristics are also inputs: number of them, electric properties, absorptance and emittance (also these same parameters of the chassis of the satellite enter in the function). The battery parameters also are included: number of cells, electrical properties, maximum depth of discharge, and maximum number of cycles before battery death for different battery charge percentages.

The different subsystems and its characteristics will be explained in detail in posterior sections. Meanwhile, is important to know is that the input parameters of the scheduler are the ones that the user decides. They are generally electrical magnitudes (intensity, voltages, resistances, power, efficiencies...) and data magnitudes (memory limit, digitalization, compression, telemetry traffic, overlapping of images, SD card max fulfilment...).

The last group of parameters are the ones related with the improvements realised in this work. They are basically the ones related with the working modes: the initial mode, the parameter that allow mode changes, the parameters that are used as limiting measures of the different budgets to provoke the working modes changes...

Furthermore, the parameters corresponding to the rest of functionalities added to the simulator are also inputs of the scheduler: the precision "submode" parameters, the ones of allPhotos and allTransmission, the overvoltage percentage of the subsystems ... Later it will be explained what exactly these parameters are and for what are used for.

2.2.2. Internal algorithm

The scheduler structure can be summarized in three main blocks: the definition of the vector to fill, the big loop where all the vectors are filled (is where the decisions of how the satellite must behave are taken) and the previous computations to the loop needed to update the state of the budgets.

2.2.2.1. First computations

The first that is going to be explained is the computations that must be done before enter in the big loop.

The first computation is the total power obtained in each one of the faces of the satellite. Of course the computation is done for all the iterations. **See (2.1) formulation.**

$$P_{face1} = P_e \cdot P_a \cdot EPS_e \cdot A_{p1} \cdot n_{p1} \cdot \frac{A_p}{A_1} \cdot S_p (Sr + A_V \cdot Sr) \quad (2.1)$$

Where P_{face1} is the power obtained by each one of the faces of the satellite in [W]. P_e P_a are the solar panels efficiency and the effective area of the panels. EPS_e is the electrical power system efficiency. A_{p1} is the projected area of face 1. n_{p1} , A_p , A_1 are the number of solar panels, the area covered with them and the area of face 1 respectively. S_p is the sun radiated power. Sr is the boolean vector where is indicated if there is an eclipse or not. A 0 means eclipse. Finally, A_V is the average albedo vector.

Basically the computation takes P_e , P_a , EPS_e , A_{p1} , n_{p1} , A_p , A_1 to know which part of the energy that arrives to the satellite face is harnessed by the solar cell. The second part is the energy that really arrives.

Once the same computations are done for all the faces, they are sum to compute the total power received from sun (albedo included).

$$P_{TotalSun} = P_{face1} + P_{face2} + P_{face3} + P_{face4} + P_{face5} + P_{face6} \quad (2.2)$$

This data is really useful because is the power that will feed the battery. Then, the battery charge in [A] can be computed:

$$Batt_{chargeI} = P_{TotalSun} / Batt_V \quad (2.3)$$

Where $Batt_{chargeI}$ is the charge intensity of the battery. $Batt_V$ is the Battery voltage.

Now what is really interesting to compute is the battery charge supply in each iteration of the simulation. It will be the real energy that the solar panels will add to the battery in each iteration.

$$\Delta Charge = \frac{Batt_{chargeI}}{3600} \cdot sec_between_samples \quad (2.4)$$

This delta is really important in the scheduler because is the battery supply of energy that will “fight” against the different subsystems consumptions. The state of the battery in each iteration will depend on the amount of energy subtracted by the subsystems consumptions and the generated by the solar panels

(deltaCharge). So it is time to see how the deltas of the subsystems are computed:

$$\text{deltaSubsystem}_1 = \frac{\text{Subsystem}_1 \text{Intensity}}{3600} \cdot \text{sec_between_samples} \quad (2.5)$$

The different subsystems will be explained in detail in a posterior section. With all the deltas computed, the power budget state will be able to be updated in the big loop, explained later.

It is time to explain the thermal calculus previous to the main loop.

The first computation is the total solar panels area:

$$P_{totalArea} = A_p \cdot P_a \cdot n \quad (2.6)$$

Where $P_{totalArea}$ is the total solar panels area. A_p is the solar panels area of 1 side of the satellite. P_a is the solar panel effective area on 1 side of the satellite. Finally, is n the number of panels (the sum of all sides).

Now is time of computing the heat that the satellite receives from the sun, from the albedo and from the earth. The heat emitted to the vacuum will also be computed.

The sun heat is computed with the next calculus:

$$S_H = S_p \cdot \frac{A_{proj}}{A_s} \cdot (P_{abs} \cdot P_{totalArea} + C_{abs} \cdot C_{totalArea}) \cdot Sr \quad (2.7)$$

Where S_H is the sun heat received by the satellite in [W]. S_p , A_{proj} , A_{proj} are the sun radiated power, the sum of the projected areas and the satellite total surface which is the sum of all the areas. P_{abs} and $P_{totalArea}$ are the panels absorptance and the total panels area. C_{abs} and $C_{totalArea}$ are the chassis absorptance and the total chassis area (Difference between the total area of the satellite and the total area of the panels). Finally, Sr is the boolean vector where is indicated if there is an eclipse or not. A 0 means eclipse.

The albedo heat is computed with the next calculus:

$$A_H = S_p \cdot A_V \cdot (P_{abs} \cdot P_{totalArea} + C_{abs} \cdot C_{totalArea}) \quad (2.8)$$

Where A_H is the sun heat received by the albedo in [W]. S_p is the sun radiated power. A_V is the average albedo vector. P_{abs} and $P_{totalArea}$ are the panels absorptance and the total panels area. C_{abs} and $C_{totalArea}$ are the chassis absorptance and the total chassis area (Difference between the total area of the satellite and the total area of the panels).

The earth heat is computed with the next calculus:

$$E_H = E_p \cdot (P_{emitt} \cdot P_{totalArea} + C_{abs} \cdot C_{emitt}) \quad (2.9)$$

Where E_H is the sun heat received by the earth in [W]. E_p is the earth radiated power. P_{abs} and $P_{totalArea_1face}$ are the panels absorptance and the total panels area of 1 face. C_{abs} and $C_{totalArea_1face}$ are the chassis absorptance and the total chassis area of 1 face.

The constant heat emitted to the vacuum is computed with the following expression:

$$V_H = B \cdot (P_{emitt} \cdot P_{totalArea_1face} + C_{emitt} \cdot C_{totalArea_1face}) \quad (2.10)$$

Where V_H is the constant amount emitted to the vacuum in [W]. B is the Boltzmann constant. P_{emitt} and $P_{totalArea}$ are the panels emittance and the total panels area. C_{emitt} and $C_{totalArea}$ are the chassis emittance and the total chassis area.

In addition to the heats calculated, the last remaining thermal contributions that will be used to compute the temperature in the main loop of the scheduler are the energy dissipations of the different subsystems.

The formulation is the following one:

$$Subsystem_1EDissip = Subsystem_1I \cdot Subsystem_1V(1 - Subsystem_1Eff) \quad (2.11)$$

Where $Subsystem_1EDissip$ is the subsystem dissipation in [W]. $Subsystem_1I$ and $Subsystem_1V$ are the subsystems intensity and voltage. $Subsystem_1Eff$ is the subsystem efficiency.

These heats and dissipations will be used in the main loop to calculate the temperature of the satellite.

Finally the last computations previous to the main loop are the ones related with the data budget. There are the charge of the camera and the charge of telemetry.

$$Cc = P_H \cdot P_V \cdot D \left(1 + \frac{I_h}{100}\right) \cdot 1024 \cdot 1024 \cdot c \quad (2.12)$$

Where Cc is the camera charge in [Mbps]. $P_H \cdot P_V$ are the horizontal and vertical camera pixels. D is the digitalization of the camera. I_h is the image header. c is the compression of the images.

$$TTc = TT_t \cdot \frac{\text{sec_between_samples}}{1000} \quad (2.13)$$

Where TT_c is the telemetry charge $.TT_t$ is the telemetry traffic.

These computations will be used at the time of managing the behaviour of the memory in the main loop.

2.2.2.2. *Vector initialization*

Once the previous computations are done, it is time of defining the different vectors that will be filled. The reason of doing the calculations in first place is because in some cases, the computations are needed to fill the first component before entering in the loop.

The vectors that will be defined will have the same longitude. This length is computed taking into account the `seconds_between_samples` parameter and the duration of the mission. This calculation is done in a previous function. All the vectors created will be filled originally with 0 and in the loop will change its state if necessary. The first component is modified before the loop if needed.

There are a lot of vectors created; Table 2.1. will group the vectors by functions. Also will be explained how the first component is filled.

Table 2.1. Types of vectors created with its meaning, number of them and first component explication.

Type of vector	Meaning	Number of vectors	First component
Working mode related	There are one for each working mode (a 1 indicates that a working mode is operative)	one for each working mode	Initial mode (decided by the user)
DOD related	They are used to compute how many times the battery goes under a certain level. These data will be used to calculate cycles of charge and discharge, which are used for computing the lifecycles)	One for DOD 25, DOD 75 and DOD 90	0
Subsystems MASKS	It indicates if a subsystem is activated or not	1 for each subsystem	depending the subsystem
Drain	It will be fulfilled with the multiplication of the subsystems masks and the deltas of consumption.	1 for each subsystem + a one for totalDrain	depending the subsystem
Total Power	It will be filled with the power available in each iteration.	1	Maximum battery (B_f)*
Temperature	It is filled with the temperature that the satellite will face in each iteration	1	Initial temperate (is a user input)
Payload Temperature	Filled with the current temperature of the satellite payload	1	Initial temperate (is a user input)
Subsystems power dissipation	It will be fulfilled with the multiplication of the subsystems masks and the dissipation of each subsystem	1 for each subsystem + a one for total Power dissipated	depending the subsystem
Memory charge	It will be fulfilled with the multiplication of the subsystems masks and the charge of the camera and telemetry in each iteration.	1	$Mc(1)**$
Memory discharge	It will be fulfilled with the multiplication of the subsystems masks and the discharge of the camera and telemetry in each iteration.	1	$Md(1)***$
Memory budget	Current state of the battery	1	Full memory space

* The maximum battery charge is computed following the next formulation:

$$B_f = B_c \cdot n_{cells} \quad (2.14)$$

Where B_f is the battery full charge in [A·h] . B_c is the battery maximum charge by cell. n_{cells} is the number of cells.

**The memory charge of the first component is acquired with the following formulation:

$$Mc(1) = C_c \cdot CameraMask(1) + TT_t \cdot VHF_UHF_Mask(1) \quad (2.15)$$

Where $Mc(1)$ is the memory charge of the first component in [Mbps]. C_c , TT_t are the camera and telemetries charges, computed in the previous section. The $CameraMask(1)$ and $VHF_UHF_Mask(1)$ are the first component of the camera mask and VHF_UHF mask. They are two example of the subsystems masks. A 1 means that the system is activated. For example these two masks first component are usually started with a 1.

*** The memory discharge of the first component is acquired with the following formulation:

$$Md(1) = SBAND_Mask(1) D_r \cdot sec_between_samples + VHF_UHF_Mask(1) \cdot VHF_r \cdot \frac{sec_between_samples}{1000} \quad (2.16)$$

Where $Md(1)$ is the memory discharge of the first component in [Mbps]. D_r , VHF_r are the data transmission rate and VHF_UHF transmission rate. The $SBAND(1)$ and $VHF_UHF_Mask(1)$ are the first component of the SBAND mask and VHF_UHF mask. They are two example of the subsystems masks. A 1 means that the system is activated. For example these two masks first component are usually started with a 1.

2.2.2.3. Main loop

It is time of fill the vectors already commented. The main loop is divided in 3 parts: activation/deactivation of the subsystems (depending in the state of the power, thermal and data budgets), actualization of the budgets information (battery charge, temperature and memory) and working mode changes.

In each iteration the first that scheduler do is decide if each one of the subsystems must be activated or not. Activation means to put a 1 in the subsystem mask. All the subsystems have constraints to control if the subsystem must be activated or not. These constraints can be occasioned for three facts: budget restrictions, working mode restrictions or new simulator functionalities restrictions. All of this will be explained in posterior sections in detail.

Once the different subsystems masks are filled it is time of actualize the budgets:

The first vectors to fill are the drain ones, following the next expression:

$$\text{SubsystemDrain} = \text{deltaSubsystem} \cdot \text{Subsystem Mask} \quad (2.17)$$

All the subsystems drains are summed in order to fill the *TotalDrain* vector. The information of this vector is the amount of energy consumed by the subsystems in one iteration.

To update the state of the battery charge the next computation is done:

$$\text{TotalPower} = \text{TotalPower}(\text{last iteration}) - \text{TotalDrain} + \text{deltaCharge} \quad (2.18)$$

The *TotalPower* is the current power of the satellite. The *TotalPower(last iteration)* is the power of the last iteration. For this reason in Table 2.1. computes the first component of this vector with the higher amount of battery. Ideally when the satellite start orbiting the battery should be full charged. The *deltaCharge* is the amount of energy obtained from the solar panels in each iteration.

The power budget is already updated, now is the thermal budget turn. The parameter to update is the temperature.

But first is time to fill the subsystems energy dissipations vectors:

$$\text{SubsystemDrain} = \text{SubsystemEDissip} \cdot \text{Subsystem Mask} \quad (2.19)$$

All the subsystems energy dissipations are summed in order to fill the *TotalEDissip* vector. The information of this vector is the amount of energy dissipated by the subsystems in one iteration.

The next computation is the total amount of heat received by the satellite:

$$\text{Heat}_T = \text{TotalEDissip} + S_H + A_H + E_H \quad (2.20)$$

Where *Heat_T* is the total amount of heat received the satellite in one iteration. *S_H*, *A_H*, *E_H* are the sun heat, albedo and earth heat contributions.

To update the temperature, the following equation is used:

$$T = T(\text{last iteration}) + \text{Heat}_T - V_H \cdot T(\text{last iteration})^4 \cdot \text{sec_between_samples} \cdot \frac{1}{M_p \cdot H_c} \quad (2.21)$$

Where *T* is the satellite temperature. *V_H* is the vacuum emitted heat, commuted in the last section. *M_p* and *H_C* are the mass of the platform and the heat capacity respectively. The temperature of the payload is computed using the same formulation.

With the temperature computed, the last remaining thing to update is the state of the memory. First the memory charge and discharge must be computed. In

the previous section the first component formulation was showed. For the rest of components the behaviour is the same.

The memory charge of the first component is acquired with the following formulation:

$$M_c = C_c \cdot CameraMask + TT_t \cdot VHF_UHF_Mask \quad (2.22)$$

Where M_c is the memory charge in [Mbps]. C_c, TT_t are the camera and telemetries charges, computed in the previous section.

The memory discharge of the first component is acquired with the following formulation:

$$M_d = SBAND_Mask \cdot D_r \cdot sec_between_samples + VHF_UHF_Mask \cdot VHF_r \cdot \frac{sec_between_samples}{1000} \quad (2.23)$$

Where M_d is the memory discharge in [Mbps]. D_r, VHF_r are the data transmission rate and VHF_UHF transmission rate.

The computation of the state of the memory is the following one:

$$M_b = M_b(\text{last iteration}) + M_c - M_d \quad (2.24)$$

Where M_b is the memory budget: the current state of the memory. Remember that the first component was filled with the memory empty.

With all the budgets updated, now it is time of changing mode if needed taking into account the state of them and the objectives of the mission. The logic of working mode changes will be explained later in detail.

The scheduler does this process in each iteration until the end of the simulation is achieved.

2.3. Satellite Subsystems

As it has said the scheduler decides which subsystem must be activated in each moment. Now is the time of defining all of them and see the conditions that must be filled to active each one.

2.3.1. Definition of the subsystems

The satellite simulator is composed by 9 subsystems:

The electrical power system (EPS): Quantifies the power management, distribution and control processes.

The payload: Professional satellite camera.

The on-board computer (OBC): Mainly used to realize the functions of information transmission from the satellite to the ground stations.

The secondary on-board computer (OBC sec): Where the scheduler logic resides so is in charge of emitting commands to the rest of the subsystems.

The SBAND system (SBAND): System in charge of the transmission of the photos obtained by the payload, which are stored in the memory, to the ground station.

The very-high-frequency and ultra-high-frequency transmission system (VHF-UHF TX): System in charge of the transmission of information to the ground stations: state of the satellite, navigation data, position...

The reaction wheels of the attitude and control determination system (ADCS RW): First half of the ADCS system; Is In charge of changing the pointing angle of the camera to be able of capture images of desired areas. Also used in the intervals where the precision "submode" is activated.

The magnetorquers of the attitude and control determination system (ADCS magnetorquers): Second half of the ADCS system; this subsystem is in charge of realising the attitude determination and control tasks during all the simulation. It represents the tasks that magnetorquers do in a space mission.

The battery heater: Active control thermal device that warranties the suitable temperature of the satellite.

2.3.2. Important parameters of the subsystems

In order to quantify the impact of the subsystems in the power, thermal and data budgets, it is mandatory knowing the electrical magnitudes and efficiency of each one. Table 2.2 picks up the main inputs of the simulator of each subsystem. The values indicated are the ones used to perform the simulations shown in this project, but can be fully customizable by the user.

Table 2.2. Subsystem parameters and description [3],[4]

SUBSYSTEM	Parameter and current value	Description
EPS	EPS_V=3.3	Input voltage to the EPS in [V]. If you have batteries to self-feed, battery charge voltage.
	EPS_I=0.1	Current entry to the EPS in [A]. If you have batteries to self-feed, battery charging current.
	EPS_eff=0.78	Efficiency of the EPS in the transformation of photo-voltaic energy in load in [% by 1] .
OBC	OBC_V=3.3	Entry voltage to the OBC in [V].
	OBC_W=2	Average consumption in [W].
	OBC_I=0.5	Current input to the OBC in [A] .
	OBC_work_cycle=1	Time that the OBC is fully powered by [% by 1].
OBC sec	OBC_sec_V=5	OBC input voltage at [V] .
	OBC_sec_W=2.5	Average consumption in [W].
	OBC_sec_I=0.5	Current input to the OBC in [A] .
Payload	PAYLOAD_V=5	Input voltage at PAYLOAD in [V] .
	PAYLOAD_I=2	Current entry to PAYLOAD in [A] .
	PAYLOAD_W=2	Power consumed by the payload in [W].
ADCS RW	ADCS_V=5	Input voltage to the ADCS in [V].
	ADCS_I=0.8	Current entry to the ADCS in [A]. Counting reaction wheels + star tracker.
ADCS magnetorquer	ADCS_magnetorquer_P=0.2	Power consumed by the magnetorquers in [W].
	ADCS_magnetorquer_V=5	Input voltage at the magnetorquers in [V] .
SBAND	SBAND_V=5	Input voltage at SBAND in [V] .
	SBAND_I=0.88	Current entry to the SBAND in [A] .
	RF_eff=0.9	Efficiency of power transmission to RF in [% by 1] .
VHF-UHF-TX	UHF_VHF_TX_V=6	Input voltage at SBAND in [V] .
	UHF_VHF_TX_I=0.80	Current entry to the SBAND in [A] .
	UHF_VHF_TX_eff=0.5	Efficiency of power transmission to RF in [% by 1] .
	VHF_UHF_TX_RATE=9.6	Transmission speed of the VHF / UHF card in [Kbps] .
Battery Heater	BATT_heater_resist=20	Resistance of the battery heater in [Ohm].
	BATT_heater_W=5	Consumption of the battery heater [W] .
	BATT_heater_I=0.3	Current heater = sqrt (BATT_heater_W / BATT_heater_resist) in [A].
	Sat_heater_on_temp=8	Temperature below which the heater starts up [C°].
	Sat_heater_off_temp=15	Temperature above which the heater, if it has been switched on, is switched off [C°].
	Sat_min_temp_accepted=5	Minimum satellite temperature to trigger the too-low-temperature protocol [C°].
	Sat_max_temp_accepted=45	Maximum satellite temperature to trigger the too-high-temperature protocol [C°].

Most of them are related with the power and thermal budgets. This is because they are electrical magnitudes that will be used in the computation of the electrical power and temperature (because of the dissipations of heat) of the satellite. In the case of the battery heater, the temperature that activates the subsystem is specified and also the one that switch off it.

In the case of the VHF-UHF-TX subsystem is added the information of the transmission speed which is related with the data budget. The other important parameters related with this budget are the camera ones.

2.3.3. Activation conditions

The main function of the scheduler is switch on or switch off the different subsystems depending in the current situation of the simulation. In each one of the iterations the code evaluates the state of the three budgets and decides what system must be activated and which not.

It is imperative to create logical constraints. In Table 2.3 are indicated the conditions of each subsystem.

Table 2.3. Subsystem Activation requirements

SUBSYSTEM	Activation Requirements
EPS	Always working
OBC	Current Power over the maximum depth of discharge of the battery allowed
	Temperature between maximum and minimum temperatures
	There is a transmission of information
OBC sec	Current Power over the maximum depth of discharge of the battery allowed
	Temperature between maximum and minimum temperatures
	There is a transmission of information and/or a payload activation (photography)
Payload	Current Power over the maximum depth of discharge of the battery allowed
	Temperature between maximum and minimum temperatures
	Enough space in the memory to add a photography more
	No overlapping between images
	Photographs must be done when there is light
	Contact with a TA
ADCS RW	Current Power over the maximum depth of discharge of the battery allowed
	Temperature between maximum and minimum temperatures
	Contact with TA but needing the activation of the RW to do the photo
ADCS magnetorquer	Current Power over the maximum depth of discharge of the battery allowed
	Temperature between maximum and minimum temperatures
SBAND	Current Power over the maximum depth of discharge of the battery allowed
	Temperature between maximum and minimum temperatures
	There must be images captured to transmit
	Contact with a GS
VHF-UHF-TX	Current Power over the maximum depth of discharge of the battery allowed
	Temperature between maximum and minimum temperatures
	There must be images captured to transmit
	Contact with a GS
Battery Heater	Activation: Current Temperature under the Sat_heater_on_temp
	Desactivation: When the Sat_heater_off_temp is reached

In Table 2.3 the different colours of the conditions of activation depend on the budget that affected each one affects to. The red ones are related with the thermal budget, the green ones with the power budget, the blues with the data budget and the white ones depend on the objective of the mission.

In a later section, it will be explained that different working modes will manage the logic of the scheduler. Depending on the current working mode of the satellite a subsystem will be operative or not, but the logic of the Table 2.2 will continue being valid. The introduction of the working modes will only add more constraints to the specified ones.

In later sections, different functionalities will be added to the simulator besides the working modes. These improvements could change, delete or add constraints to the indicated ones in Table 2.2. For example there is a functionality that activate the camera whenever is possible, independently that there is a target area to point to. In that specific case, the condition of the Payload that says that is needed a contact with a target area to activate the camera is deleted.

2.4. Working modes

One of the main improvements that this project supposes is the introduction of the working modes to the scheduler. Each mode has a purpose and more than one can be used in one single mission. The program is fully independent and will change from one mode to another taking into account the current situation in order to make the mission more efficient.

Introduce this functionality means that the satellite will self-manage making the mission more resilient, optimum and safer.

Talking about the working mode impact in the code, the affectation is given by the addition of constraints at the time to activate/deactivate the different subsystems. Remember that the constraints of activation/deactivation of the subsystem don't disappear with the introduction of the working modes.

2.4.1. Definition of the modes

There are five satellite working modes:

Standard: is the most basic one of the working modes. It represents the behaviour of the code before the execution of this project. All the subsystems can be switched on when this mode is operating.

SunSAFE: Is equal to the standard mode when there is not an eclipse. But when there is, most of the subsystems can't be activated. Is a mode designed to save energy in the eclipsed periods while in the not-eclipsed phases performs like the standard mode.

In a mission, the subsystems consumptions in a single iteration could be lower than the battery charge supply in the same period of time when the sunSAFE mode is activated. In this case the battery total charge will increase. In the rest of the cases, the only difference with the standard mode is talking about how fast the battery will discharge. It depends strongly in the quantity of photos to

do, the position of the target areas, the location of the ground stations and other parameters of the mission.

Survival: This mode is equal to the sunsafe mode when there is an eclipse but during all the simulation. It is the mode that only activates the essential subsystems to continue operating. It helps the satellite to recover the full-state of the battery.

Full-acquisition: Is a mode whose main objective is taking photos. So the transmission subsystems will not be activating while this mode is activated.

Download: is the complementary mode to the full-acquisition one. In this case the objective is transmitting images to reduce the memory. Therefore the payload subsystem can't be activated. It is a mode that is also compatible with the standard and sunsafe modes because its behaviour of not taking photos allows consuming less than the modes that download and take photos at the same time. In some situations as it will be shown in posterior section is useful stop taking photos and transmitting at the same time to only transmit.

In Table 2.4 are shown which subsystems could be activated with each working mode.

Table 2.4. Working mode subsystems activation constraints

MODE	PAYLOAD	SBAND	VHF/UHF	ADCS (RW)	ADCS magnetorquer	OBC	OBC-sec	EPS	HEATER
standard	YES	YES	YES	YES	YES	YES	YES	YES	YES
sunsafe	YES/NO (ECLIPSE)	YES/NO (ECLIPSE)	YES/NO (ECLIPSE)	YES/NO (ECLIPSE)	YES/NO (ECLIPSE)	YES/NO (ECLIPSE)	YES	YES	YES
survival	NO	NO	NO	NO	NO	NO	YES	YES	YES
fullacq	YES	NO	NO	YES	YES	NO	YES	YES	YES
download	NO	YES	YES	YES	YES	YES	YES	YES	YES

From Table 2.4 can be seen the three subsystems are working with each mode: the secondary on-board computer, the electric power system and the heater. The secondary on-board-computer must be active because is where the scheduler logic is implemented. It is necessary to have the machine that emits commands active. The electrical power system must be active too because without them no subsystem could be switched on again. Finally the heater must be active because the thermal stability depends on it.

The yellow boxes, all of them related with the sunsafe mode, mean that if there is an eclipse the subsystems couldn't be activated. When there is not, all of the subsystems could be activated.

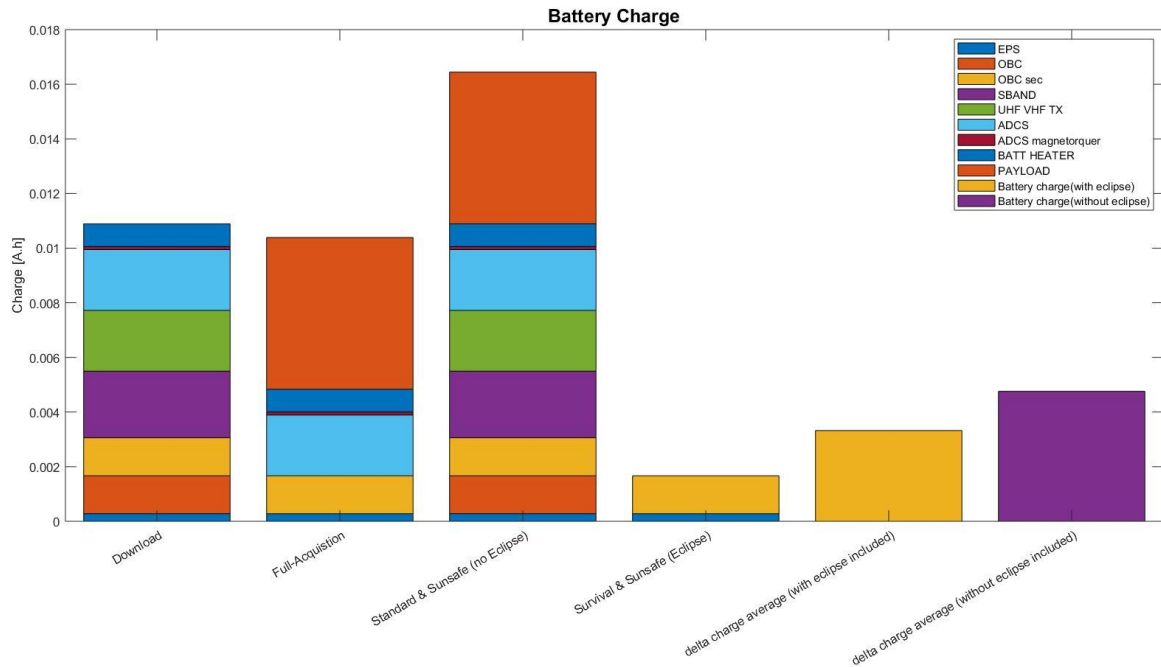


Fig. 2.1 Consumption of each subsystem

Fig. 2.1 shows the hypothetical situation that could occur if all the subsystems were active at the same time in one iteration. The situation of each mode is presented. At the right are computed the average charge supplies of the battery during a simulation. Only the survival mode and the sunsafe (when there is an eclipse) consumptions are always under the average charge. We can take the conclusion that these mode configurations will help the satellite of recover battery.

This scenario is not a realistic situation because only in a few cases all the systems will be operating at the same time. In posteriors sections, a most realistic graph will be presented indicating the average values of consumption of each subsystem depending divided by working mode. In that case it will be comparable with the average charge supply of the battery and it will justify why the battery charge increases or decreases.

In figure 2.2 it can be appreciated the difference in consumption between the different subsystems but is easier to see it in Fig. 2.1.

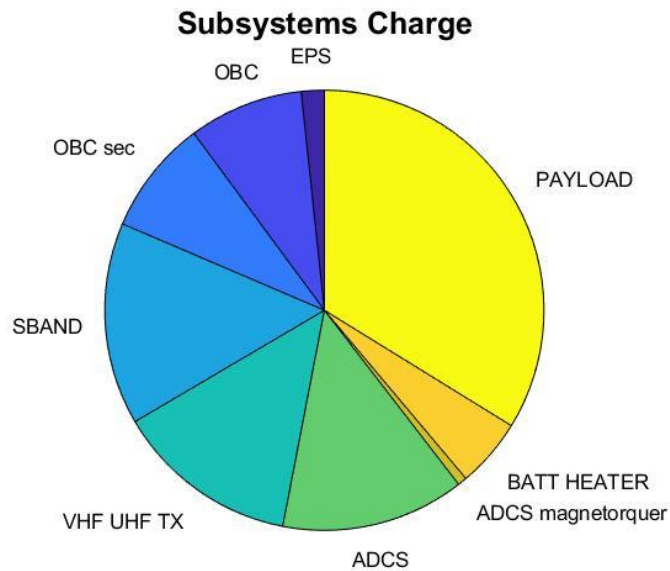


Fig. 2.2 Comparison of the order of magnitude of the subsystems consumptions

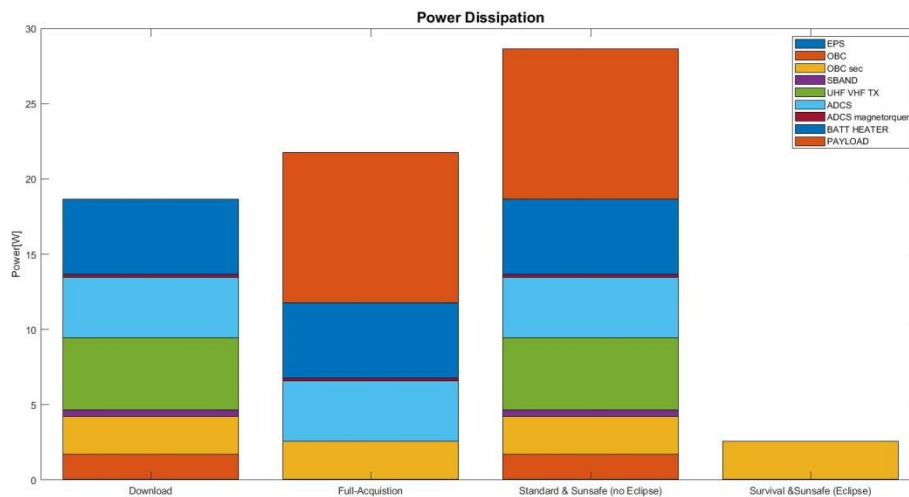


Fig. 2.3 Energy Dissipation of each subsystem

Fig. 2.3 in figure can be seen the energy dissipation of the different subsystems grouped by working mode configurations.

2.4.2. DOD constraint

Once the different working modes are explained, and just before start talking about the mode changes, it is time to talk about one of the limiting factor in the performance of the simulator: the depth of discharge of the battery (DOD). As it has said, there is a limiting DOD below which most of the subsystems can't be activated. 10% of the full charge of the battery is the selected value. The implementation of this limitation is an action take it to avoid the full discharge of the battery.

Furthermore, it is important to study how many times the battery charge goes down a specific percentage of the full charge and then again surpass that level. There is a limited number of cycles (understanding a cycle when the battery level goes down and then goes up again) before the battery death for different battery charge percentages.

Table 2.5. Cycles to Battery Death for different percentages of battery charge

Percentage of the battery	Cycles to battery death
25%	700
75%	1400
90%	1610

In a simulation, the time to battery death can be computed taking into account the number of cycles realised in a period of time for different battery charge percentages. With this data, the number of cycles in a period time, is easy to make an approximation of when will arrive the battery death taking into account the data of the Table 2.5. too.

The simulator does these computations in all the iterations for the three percentages already commented: 25%, 75% and 90%, the lower number of days is the authentic number of days to battery death.

Taking into account the remaining days of the simulation and the obtained days to the battery death, the simulator is programmed to anticipate this situation and it changes the working mode to the survival one (the one that consume less) to protect the battery. It will continue with that mode until the final of the mission.

There is a parameter called `PercentageAllowedToBatteryDeath` that manage at what point the simulator must change to the survival mode. It is the percentage of the days to the battery death that will be compared with the remaining days of the simulation. For example if this parameter is filled with a 50%, if the days to battery death are 20 and the remaining days of simulation are 10, the simulator must change to survival. In that situation if the remaining days would be 11, the simulation wouldn't change yet. With a 100%, the simulator only changes to survival mode if the number of remaining days of the simulation is equal or minor than the number of days to battery death.

Back to the mode changes, this is the first example of mode change procedure that makes the mission safer. There is an option in the simulator in charge of allowing mode changes as it is going to be explained in posterior sections (mix parameter). But this procedure of change to the survival in case of danger of the battery death is independent of this parameter because is not related with the better performance of the satellite like the ones explained in the posterior sections, is an inevitable action for not losing the satellite. Because of all of this, the DOD constraint is explained before the rest of mode changes.

2.4.3. Mode changes

2.4.3.1. Mode changes motivation

It arrives the time of talking about the mode changes. The objective of them is making the simulator more effective. It will help the satellite changing to the most proper mode for the each situation. To know which the best mode change is for a specific moment, the scheduler analyse the simulation checking the state of the budgets: the state of the battery charge (power budget), the state of the memory (data budget). Remember that the thermal budget maintenance depends on the battery heater and can always be operative independently of the mode.

Furthermore there are some modes than can't work independently. It is absurd doing a mission always in full-acquisition (Only makes photos, never download), but is possible. What is impossible is do a missions only in download (Only makes downloads, but never make photos) or survival (don't make photos neither downloads). Only standard and sunsafe modes could make sense individually but they are not optimal if the simulation is long.

To see that working only with one single work mode is not a good decision, a 30 days simulation will be performed with the three modes that can work independently: the standard, the sunsafe and the full-acquisition.

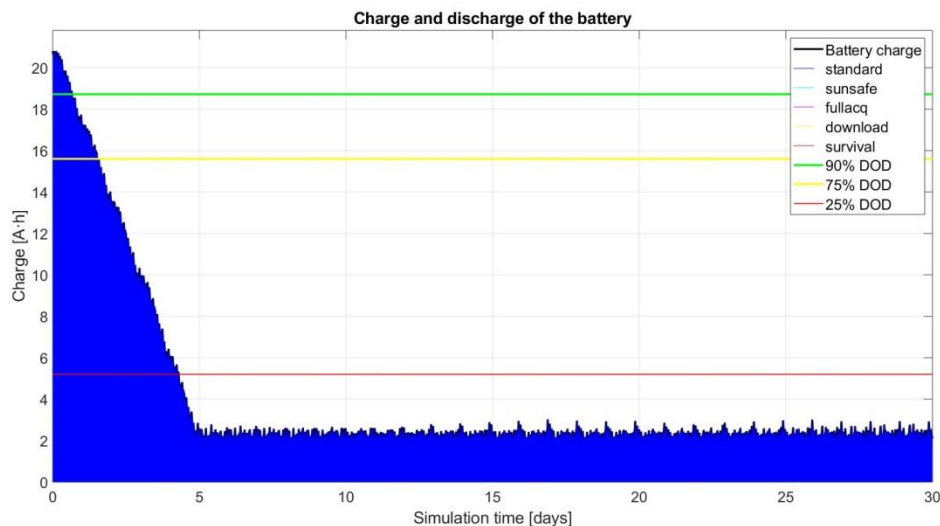


Fig. 2.4 Battery Charge in Standard mode in 30 days simulation

Fig 2.4 represents the state of the battery charge during the 30 days of simulation. At the beginning the battery charge is full, but the standard mode consume a lot because can activate all the subsystems. In five days, the battery arrives to the level of maximum depth of discharge of the battery (in this case fixed at 10%). Since then oscillates in that level, in some iteration has power to

activate the subsystems in other not. It adopts a dangerous way of working because what it does is saving some energy and spends it at the moment. For this reason, the mission analysis is not well planned, it does not have room for manoeuvre if something goes wrong and performs depending on charge or not. There is not a real control of the simulation. The satellite does what it can, not what the designer want.

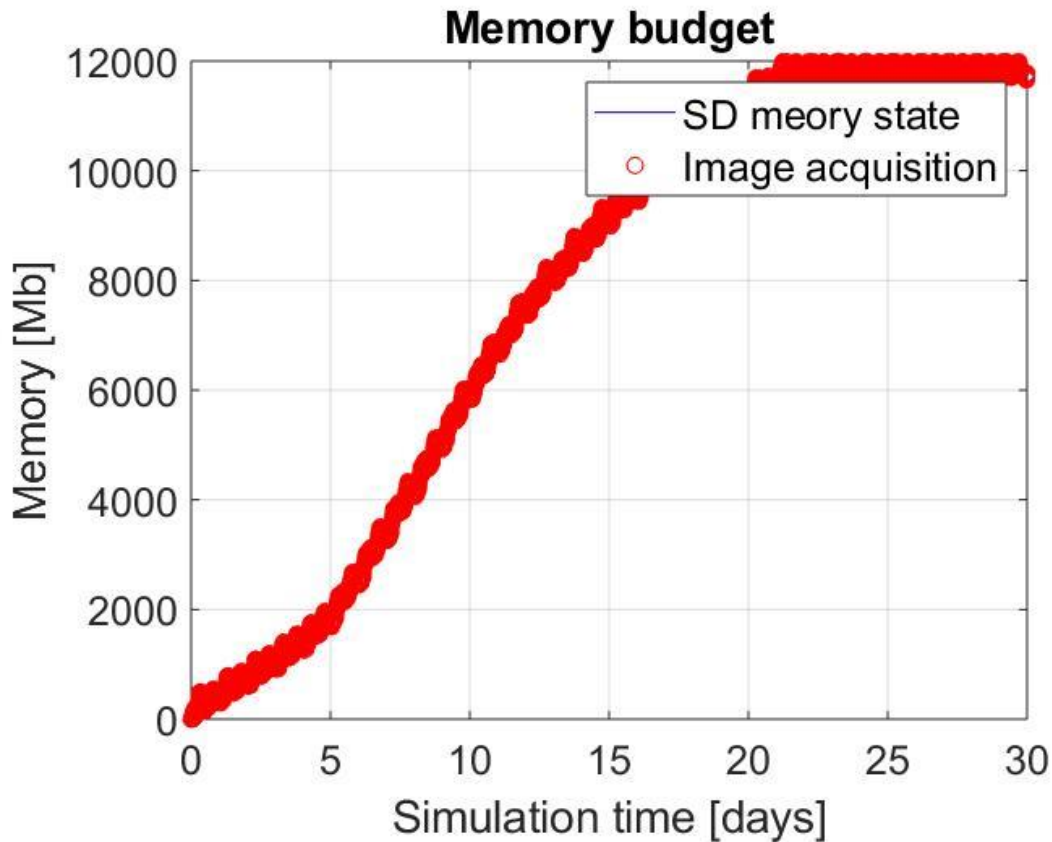


Fig. 2.5 Memory budget of Standard mode in 30 days simulation

The limitation of Fig 2.4 is not the only one. In Fig. 2.5 can be seen the memory estate during the simulation. At the beginning starts at 0, but during the simulation it starts growing because the satellite take photos faster than it downloads (here the simulator has a great dependency on the target areas and ground station). At 1200 Mb arrives to its limit and start working in a similar way than when the battery arrives to its limit: It does photos when there is space in the memory because a download has just done. Another time there is not control, there is not a constant flow of work and the system does what it can, what means working always at the edge.

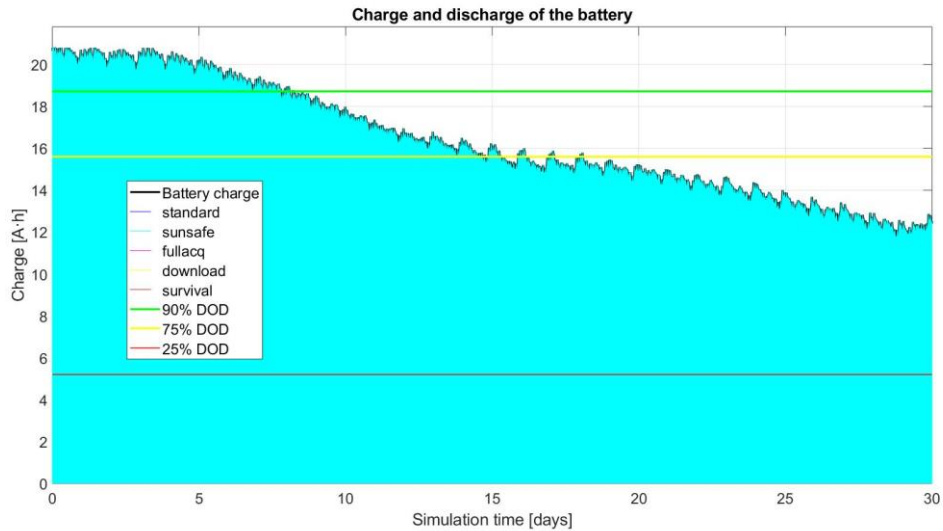


Fig. 2.6 Battery Charge in Sunsafe mode in 30 days simulation

In Fig 2.6 can be appreciated that the Sunsafe mode has a similar behaviour to the standard mode, but the consumption is lower. In that simulation doesn't suffer the problem of arriving to the maximum depth of charge, but is only because the simulation is not long enough. But the same problem of no controlling the situation when the maximum DOD is reached happens when sunsafe works alone without other modes that help him to recover energy.

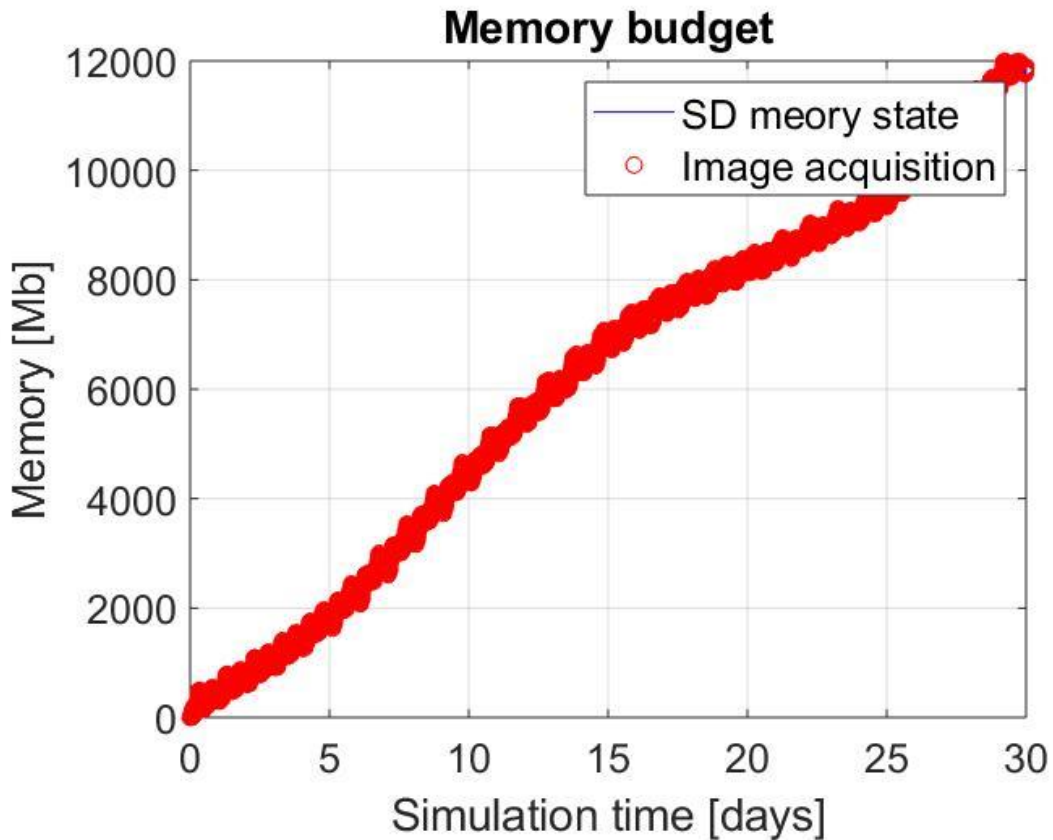


Fig. 2.7 Memory budget of Sunsafe mode in 30 days simulation

The same problem with the memory can be seen in Fig. 2.7. It needs more time than the standard mode to arrive to the limit of the memory, but with sansafe mode arrives too. Again the same problem of be at the edge happens here, the mission has no control, only depends on win a bit of space to download right away. The satellite is collapsed.

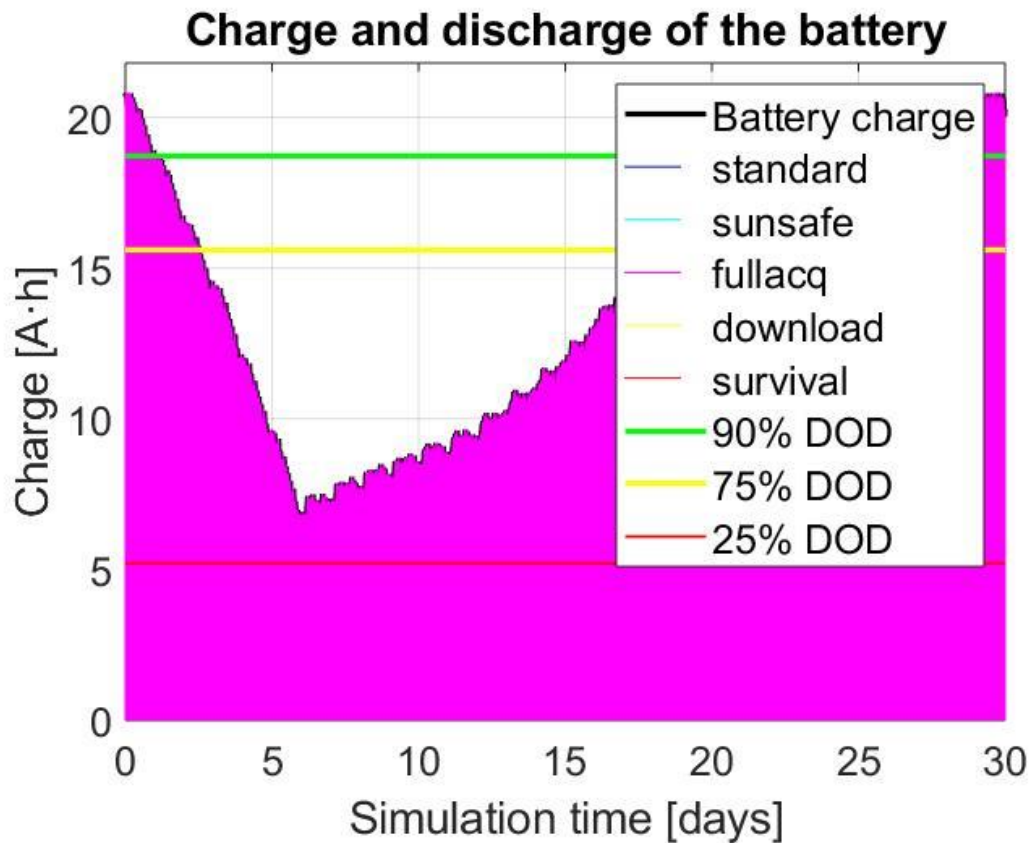


Fig. 2.8 Battery Charge in Full-Acquisition mode in 30 days simulation

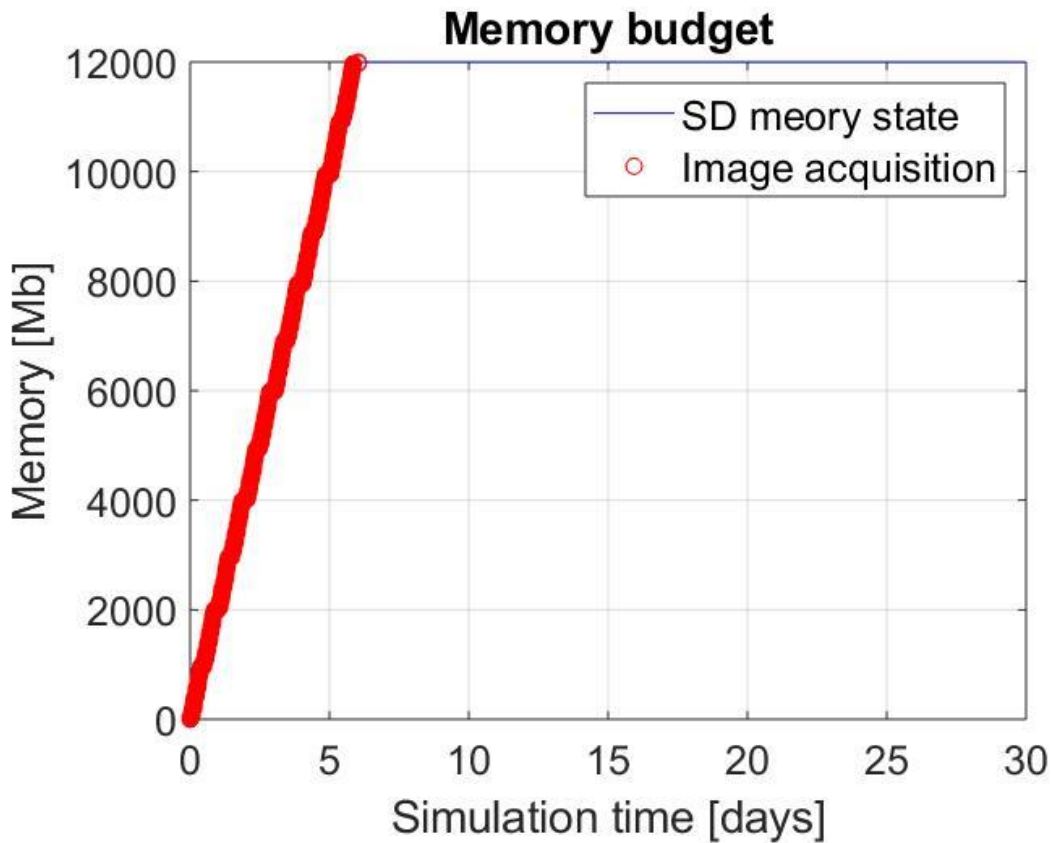


Fig. 2.9 Memory budget of Full-Acquisition mode in 30 days simulation

The last mode that can work individually is the Full-acquisition, this system doesn't do downloads so the only that can do is take photos until the memory is full. This is what happens at the 5 day of the simulation. See Fig. 2.8. After day 5, the satellite doesn't do photos so the battery charge recovers. It cannot take photos again because the memory is still full.

After analysing the three modes that could work individually, the idea that the different modes enter in collapse when the simulation is long enough is conclusive. Anyway, the images showed in Fig. 2.10 represents in cyan the points where a photo is take it, in dark blue the photos take it using the reaction wheels and in red the downloads done. The third photo doesn't have red point because as it has said several times, the full-acquisition mode does not make downloads.

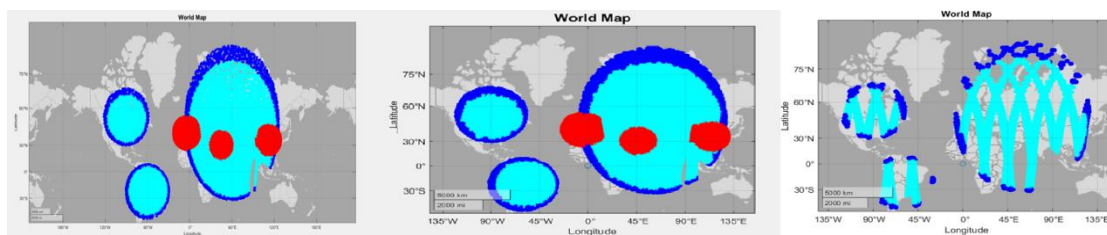


Fig. 2.10 World Coverage of the mission in standard, sunsafe and Full-acquisition modes respectively

Once it became clear that it is necessary to use more than one working mode in a single mission it is time to see the possible combinations depending on the starting mode that the user decide. The download mode can't be the initial one because it needs photos taken before. Start with the survival one also is absurd. Therefore the three possibilities of starting modes are the standard, sunsafe and full-acquisition.

2.4.3.2. *Initial Standard*

If the initial mode selected by the user is the standard mode, the simulator will adopt the policy of trying to make photos and download at the same time. The modes that do this thing are the standard and sunsafe.

To resume how the mode changes work when the standard one is the initial one the different changes can be divided in two types: motivated by battery charge restrictions or by memory restrictions. The battery charge ones are primordial, because the integrity of the simulator depends on them.

Talking about the battery charge changes, the simulator will try to use the standard mode as the main one, but this mode makes the battery charge decrease in most of the cases so change to sunsafe is the initial action when it surpasses an established level (decided by the user). If the sunsafe is enough to recover the full battery charge the simulator will change again to standard. If this is not the case, and the battery charge continues decreasing, the solution is change to survival mode, which for sure, will to recover the battery charge. Once the battery is full recovered it changes again to standard.

The mode changes motivated by memory restrictions are the ones that happen when the memory is filled until a stabilised level (decided by the user). When the simulator is in standard or in sunsafe the simulator can change to download. When the memory is empty again, the simulator returns to the standard mode.

If the simulator is in mode download and the battery charge has surpassed the established level, the simulator must change to survival to recover the full battery charge. After that it changes again to the download mode.

To understand exactly how the different work modes changes can occur, the Table 2.6. joins all the information.

Table 2.6. Possible mode changes when standard is the initial mode.

MODE	Possible Changes	Condition
Standard	To Sunsafe	Total Power under de Percentage of power established to change to Sunsafe. 50 % is a common value.
	To Download	Memory under de Percentage of memory to change to Download. 50 % is a common value.
Sunsafe	To Standard	Total Battery charge recovered.
	To Survival	Total Power under de Percentage of power established to change to Survival. 20 % is a common value.
	To Download	Memory under de Percentage of memory to change to Download. 50 % is a common value.
Survival	To Standard	Previous mode (before entering in survival) different to Download and total Battery charge recovered.
	To Download	Previous mode (before entering in survival) equal to Download and total Battery charge recovered.
Download	To Standard	Full Memory available.
	To Survival	Total Power under de Percentage of power established to change to Survival. 20 % is a common value.

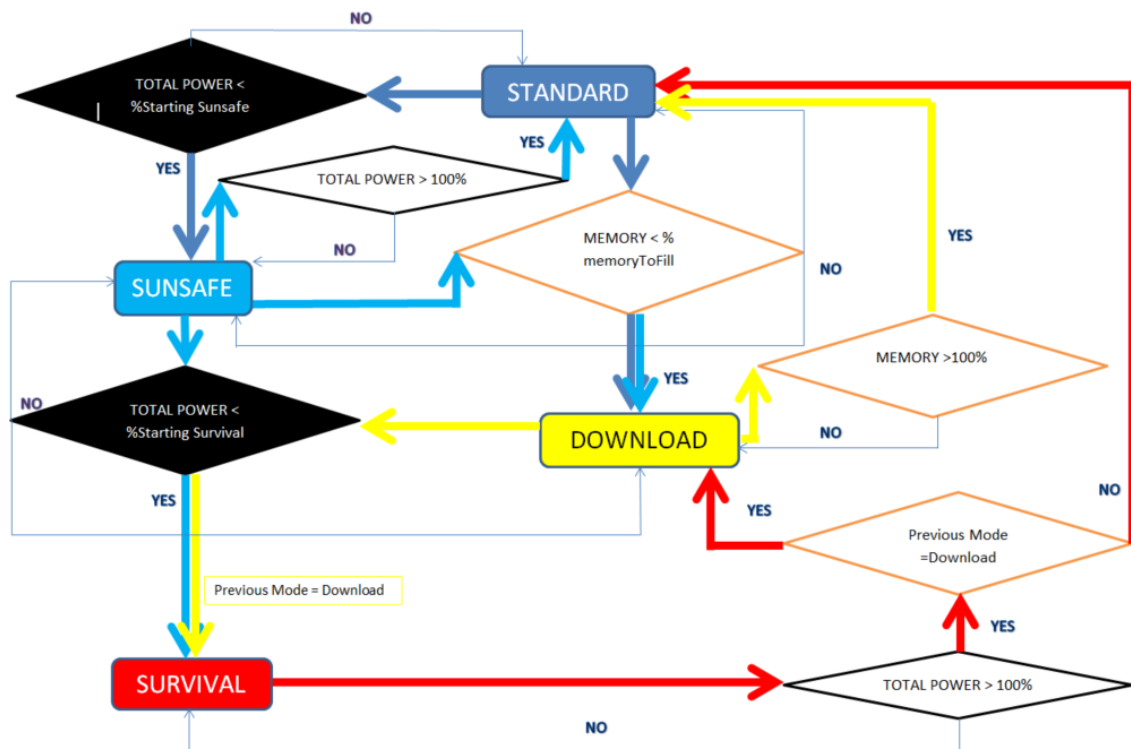
**Fig. 2.11** Diagram of the logic of the mode changes when the initial mode is Standard

Fig. 2.11 is a diagram that shows all the possible “paths” between modes and the conditions that must happen to change from one to another.

Once the logic of the work modes when the starting one is the standard is already explained, it is time of running a simulation of 30 days (the same one done with the modes individually) to see the affectation of them.

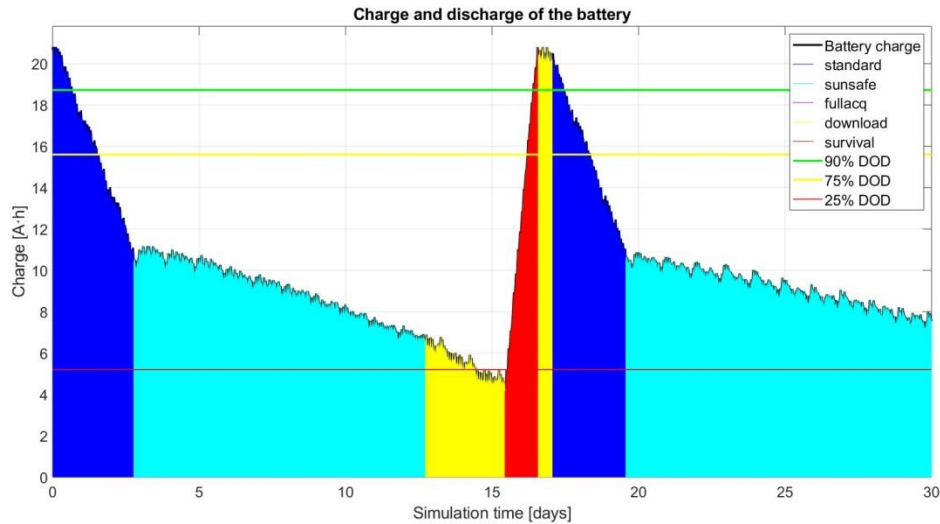


Fig. 2.12 Battery Charge in Standard mode in 30 days simulation with mode changes

Fig. 2.12 shows how the battery charge behaves during the simulation. It starts in standard mode but more or less between day 2 and day 3 it changes to sunsafe mode because the level of changing mode fixed by the user is overpassed (50%). With this mode it can be appreciated that the simulator consumes less and can use it until the day 13 more or less. At this point the memory limit established by the user (50% of the total memory) is reached so the simulator changes to download mode. It starts downloading but it arrives a point, just after day 15 that it changes to survival mode. It does this change because the 20% of the battery level is reached which is the limit established by the user to activate survival mode. With survival mode it recovers the full battery and then changes again to download to finalize the process of empty the memory. Once the memory is full available it changes again to standard mode to restart the cycle (day 19).

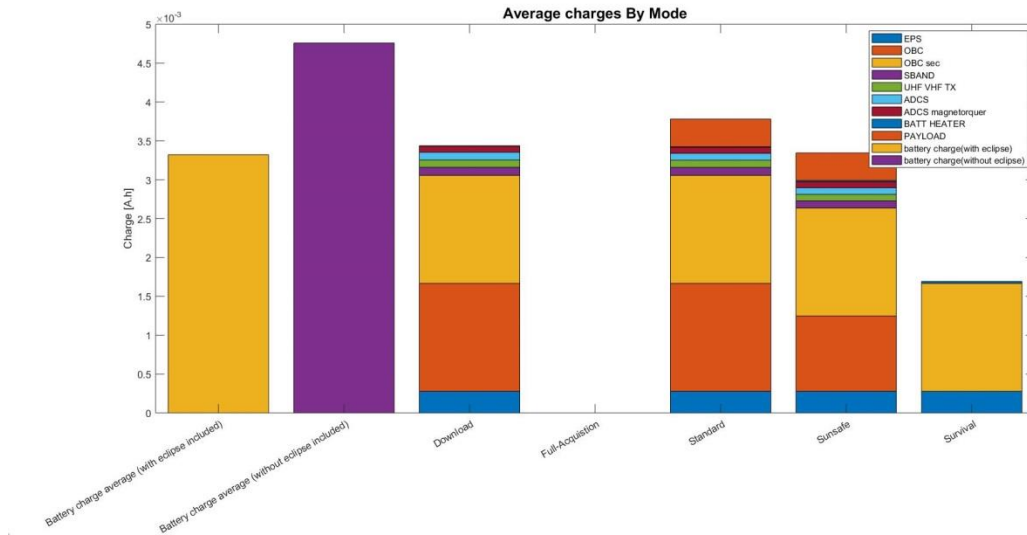


Fig. 2.13 Average battery charge of the subsystems (in one iteration) in Standard mode in 30 days simulation with mode changes

The plots showed in Fig. 2.13 are the average values of consumptions of each subsystem in each mode in one iteration. At the left part of the graph in yellow is specified the battery charge supply in one iteration during the simulation. Comparing this value: 2.5 A.H with the sum achieved by each mode, it can be justified why the battery charge increases or decreases with the different modes.

Only the survival mode when is activated has a lower consume, so is the only one that allow the battery to recover. The consumptions of sunsafe mode and download are a bit higher than the battery supply for this reason reduces the battery charge but slower than the standard mode. It can be seen that is the one that consumes the most.

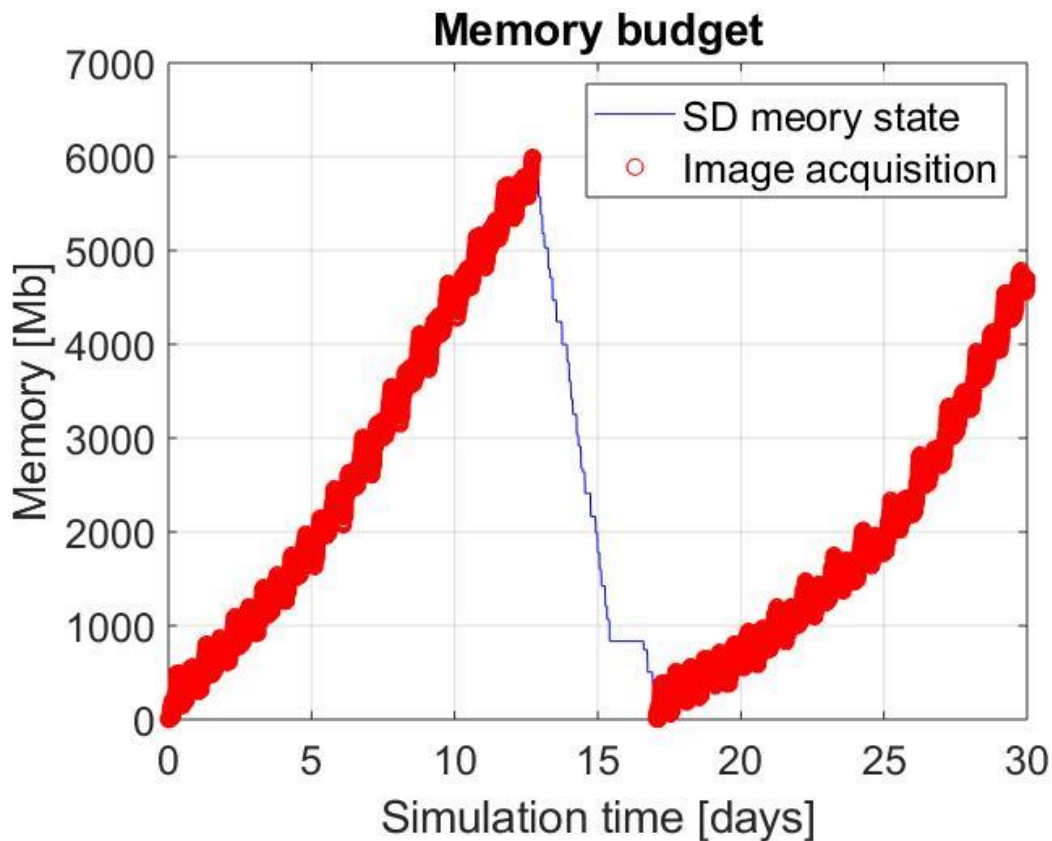


Fig. 2.14 Memory budget of Standard mode in 30 days simulation with mode changes

Fig. 2.14 shows the memory state during the simulation. As it has said the memory limit is 50% of the full battery 1.2 GHZ. When this level is reached, in the day 13, the simulator changes to download mode it and starts downloading but in day 15 it needs to stop because it must change to survival mode (see Fig. 2.12) because the battery charge is under the fixed level. This is why between day 15 and 16 neither photos nor downloads are done. Just after, the simulator changes again to download mode to finish the download and then restart the cycle. When the memory is fully available the simulator changes to standard and start making photos again.

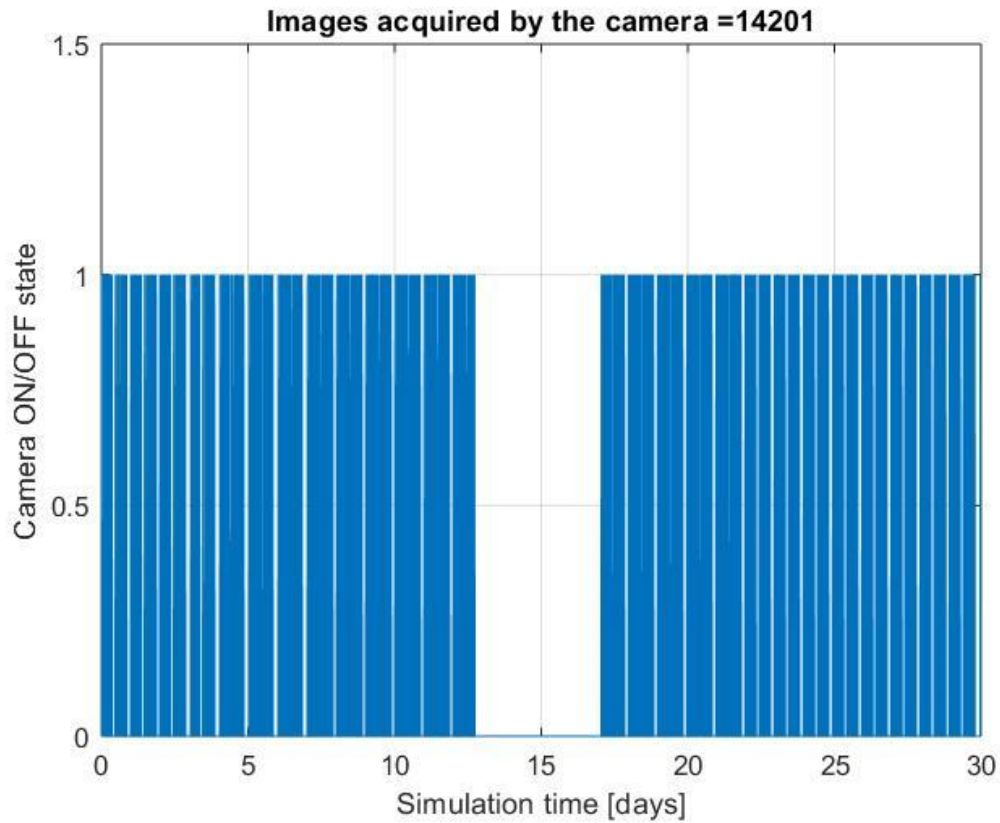


Fig. 2.15 Photos captured in Standard mode in 30 days simulation with mode changes

Fig 2.15 shows the moment when the photos are done. The period when there are no images captured is because the simulator is in the modes of download and survival (see Fig 2.12).

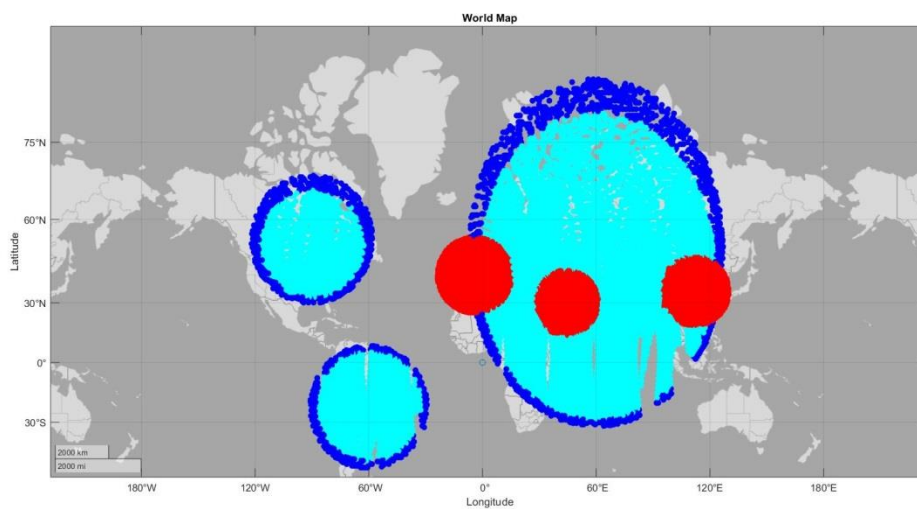


Fig. 2.16 World map coverage of the mission in Standard mode in 30 days simulation with mode changes

Finally in Fig. 2.16 is shown the coverage of the mission.

All the graphs shown have a relation between them, and help understanding why the different modes are necessary in each situation.

2.4.3.3. *Initial Sunsafe*

When the initial mode is Sunsafe the behaviour of the changes is really similar than if the initial one was the Standard one. The Standard mode disappears, but the conditions to enter in mode download or survival are the same.

When the battery or the memory are filled (being the simulator in survival mode and download mode respectively) it changes again to the standard.

If the simulator was in download mode before entering in survival, at the time the battery is charged again, it returns to download mode. This also happens when the start mode is the standard.

Again Table 2.7 shows the possible mode changes.

Table 2.7. Possible mode changes when Sunsafe is the initial mode.

MODE	Possible Changes	Condition
Sunsafe	To Survival	Total Power under de Percentage of power established to change to Survival. 20 % is a common value.
	To Download	Memory under de Percentage of memory to change to Download. 50 % is a common value.
Survival	To Sunsafe	Previous mode (before entering in survival) different to Download and total Battery charge recovered.
	To Dowload	Previous mode (before entering in survival) equal to Download and total Battery charge recovered.
Download	To Sunsafe	Full Memory available.
	To Survival	Total Power under de Percentage of power established to change to Survival. 20 % is a common value.

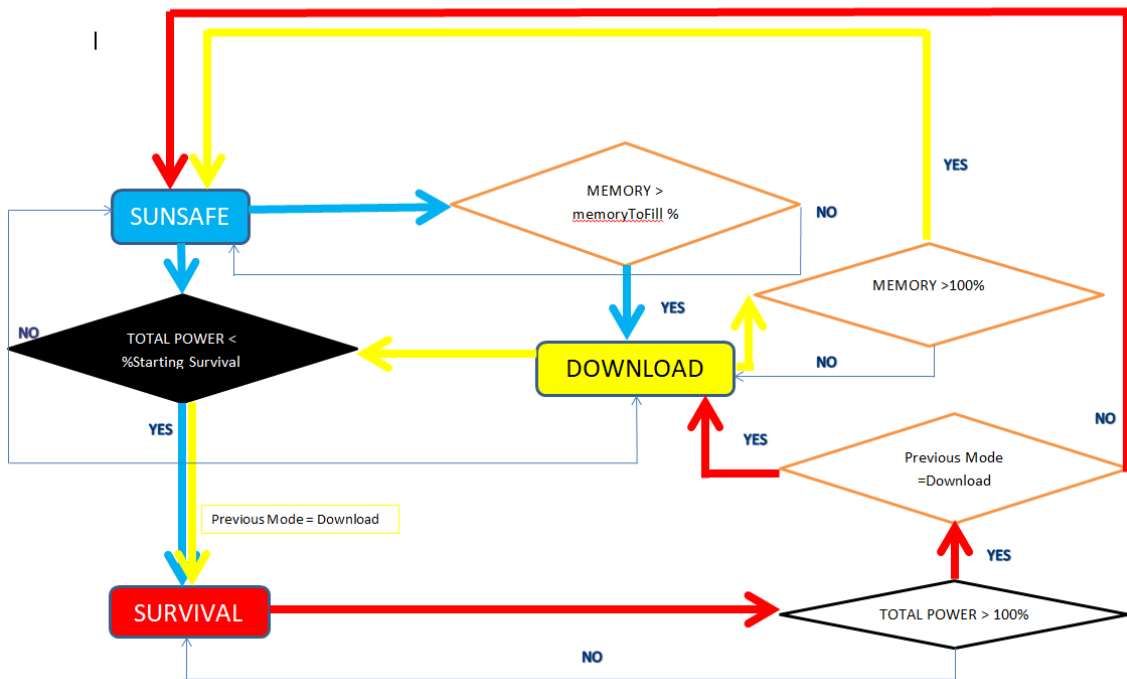


Fig. 2.17 Diagram of the logic of the mode changes when the initial mode is Sunsafe

Fig. 2.17 is a diagram that shows all the possible “paths” between modes and the conditions that must happen to change from one to another. It is really similar to the last schematic seen in Fig. 2.11.

Once the logic of the changes when the starting one is sunsafe is already explained, it’s time to perform a 30 days simulation to see how the simulator behaves with this configuration.

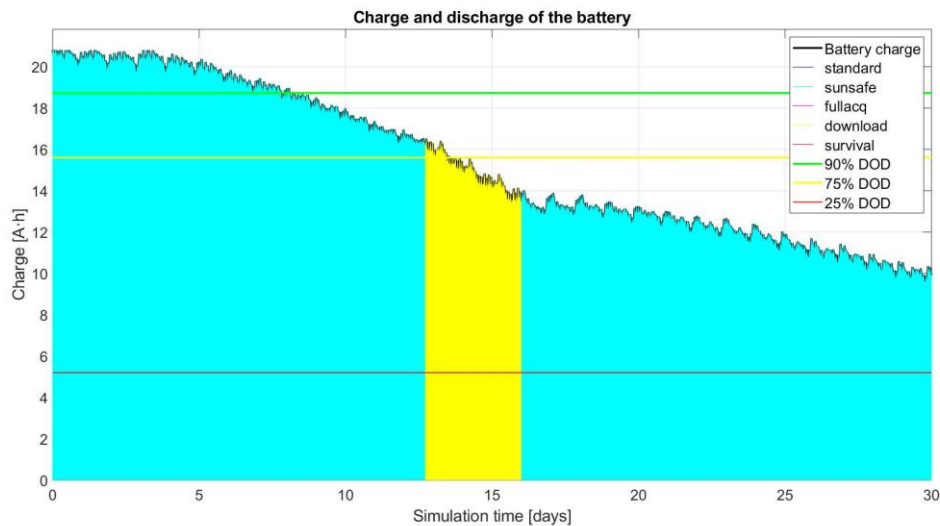


Fig. 2.18 Battery Charge in Sunsafe mode in 30 days simulation with mode changes

About the charge/discharge of the battery, Fig. 2.18 shows that it decreases lower way than one it was with the standard mode. At day 13, it changes to download because the memory limit fixed is reached. When the memory is full again it returns to sunsafe. In this simulation can't be seen because is not long enough but with time survival mode will be needed to recover the full battery.

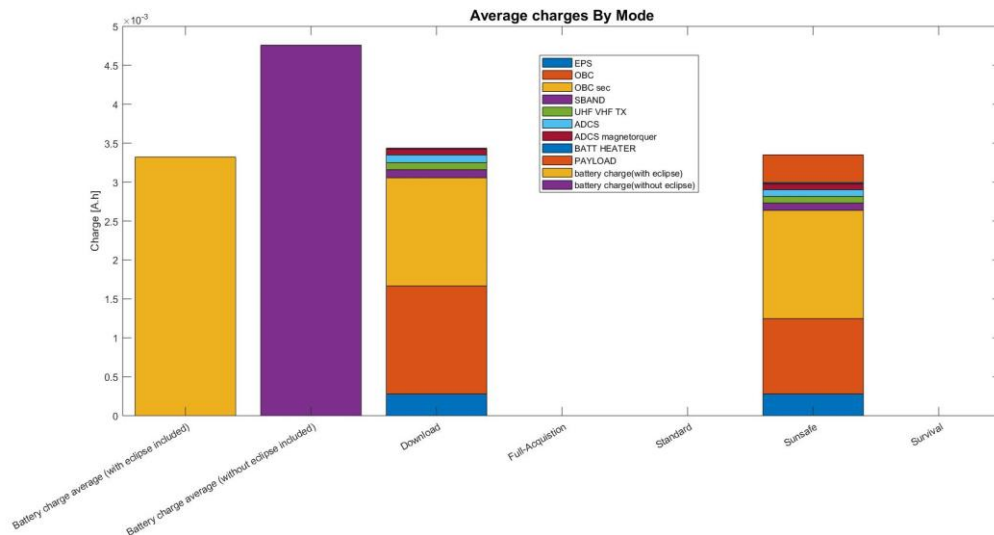


Fig. 2.19 Average battery charge of the subsystems (in one iteration) in Sunsafe mode in 30 days simulation with mode changes

Fig. 2.19 is a really similar plot than the one showed in the section that explains the behaviour when the starting mode is the standard. Download and Sunsafe consume a bit more than the battery charge supply for that reason the battery charges reduces.

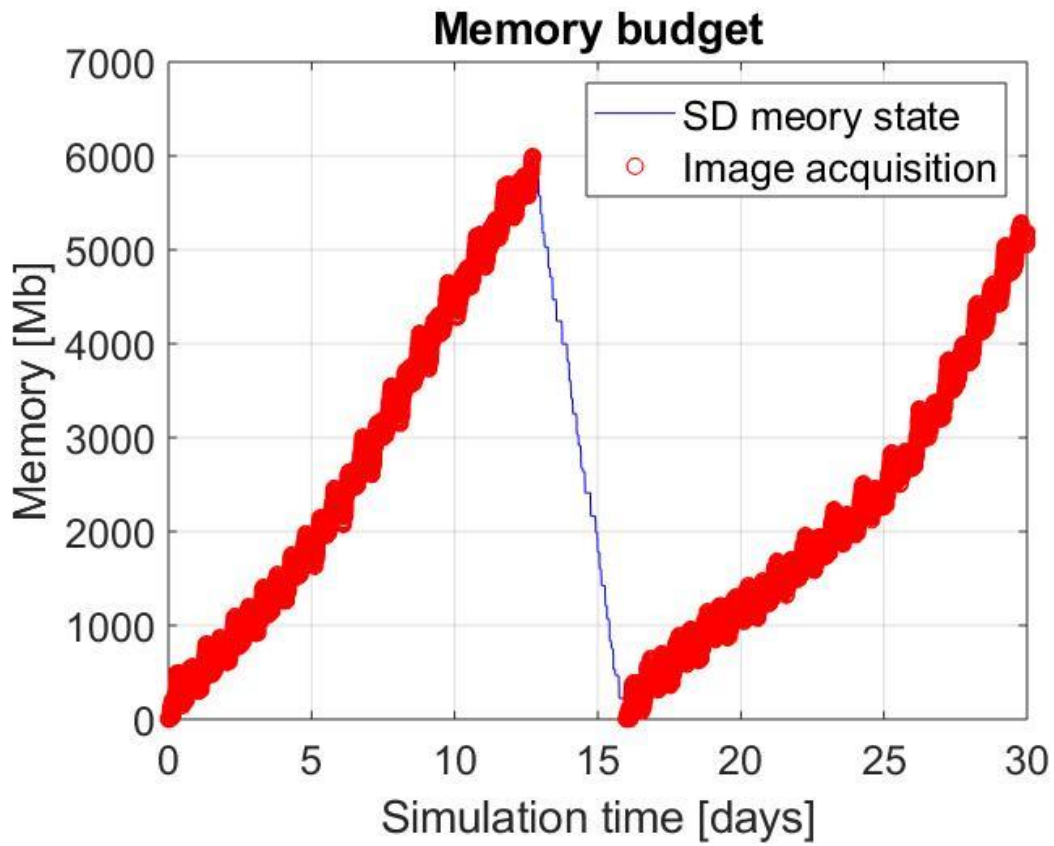


Fig. 2.20 Memory budget of Sunsafe mode in 30 days simulation with mode changes

Fig. 2.20 shows that the simulator stop taking photos in the period of time when download mode is operating and recover the full memory before changes again to sunsafe.

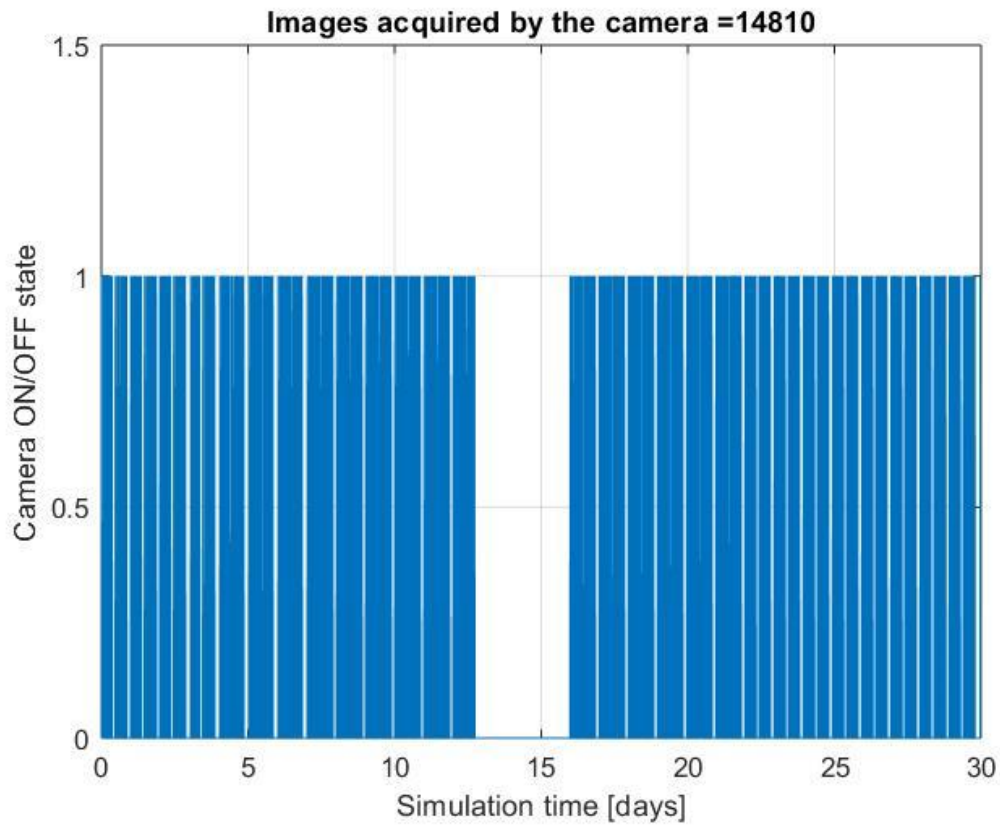


Fig. 2.21 Photos captured in Sunsafe mode in 30 days simulation with mode changes

When the download mode is operative, no photos are taken (See Fig 2.21).

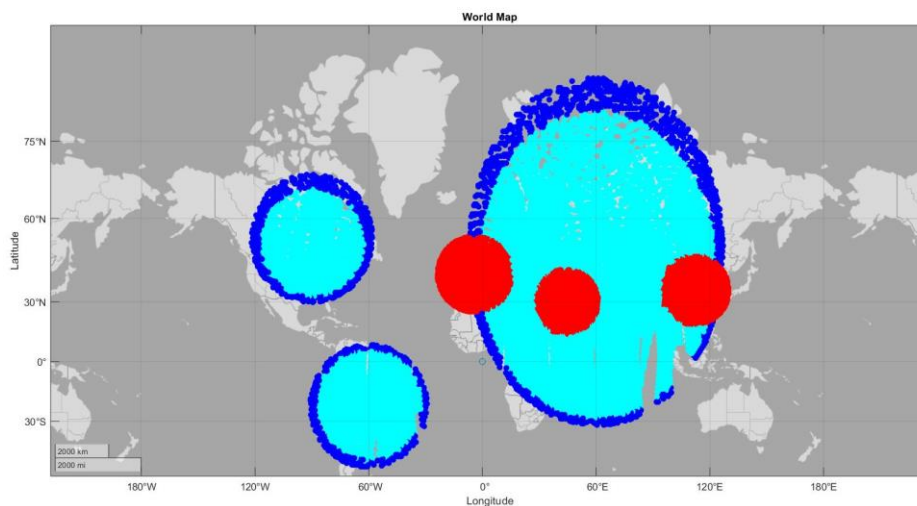


Fig. 2.22 World map coverage of the mission in Sunsafe mode in 30 days simulation with mode changes

The world coverage is really similar (See Fig 2.22).

2.4.3.4. Initial full-acquisition

If the initial mode is the full-acquisition the policy of making photos at the same time than downloads is broken.

In that case the simulator tries to make as many photos as it can until a memory level chosen by the user is surpassed. Then it changes to download mode to start downloading all the photos. It comes back to full-acquisition when the download is finished.

If the battery charge level decreases until the specified level to change to survival mode, the simulator does it, independently of the mode that it was. When the battery charge is recovered, it changes to the previous mode before entering in the survival one.

Table 2.8 shows the possible mode changes.

Table 2.8. Possible mode changes when Full-acquisition is the initial mode.

MODE	Possible Changes	Condition
Full-acquisition	To Survival	Total Power under de Percentage of power established to change to Survival. 20 % is a common value.
	To Download	Memory under de Percentage of memory to change to Download. 50 % is a common value.
Survival	To Full-acquisition	Previous mode (before entering in survival) different to Download and total Battery charge recovered.
	To Dowload	Previous mode (before entering in survival) equal to Download and total Battery charge recovered.
Download	To Full-acquisition	Full Memory available.
	To Survival	Total Power under de Percentage of power established to change to Survival. 20 % is a common value.

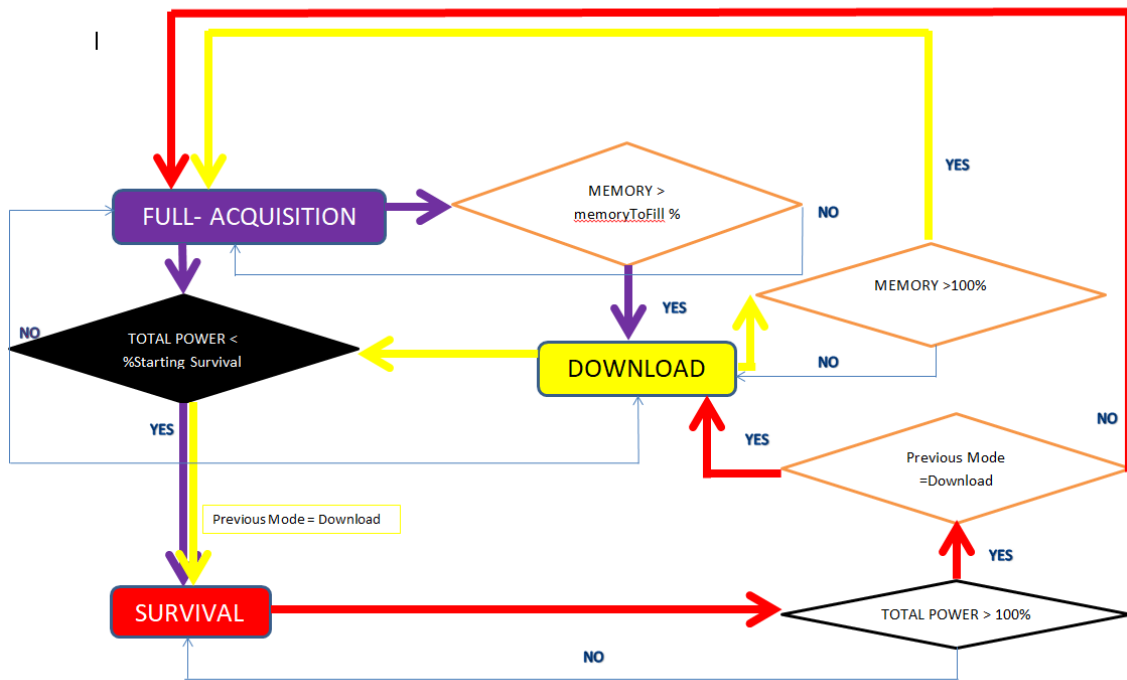


Fig. 2.23 Diagram of the logic of the mode changes when the initial mode is Full-acquisition

Fig. 2.23 is a diagram that shows all the possible “paths” between modes and the conditions that must happen to change from one to another. It is really similar to the last schematic seen in Fig. 2.17, the only that changes is the origin mode.

Now it’s time of performing a 30 days simulation to see how the mode changes explained behave.

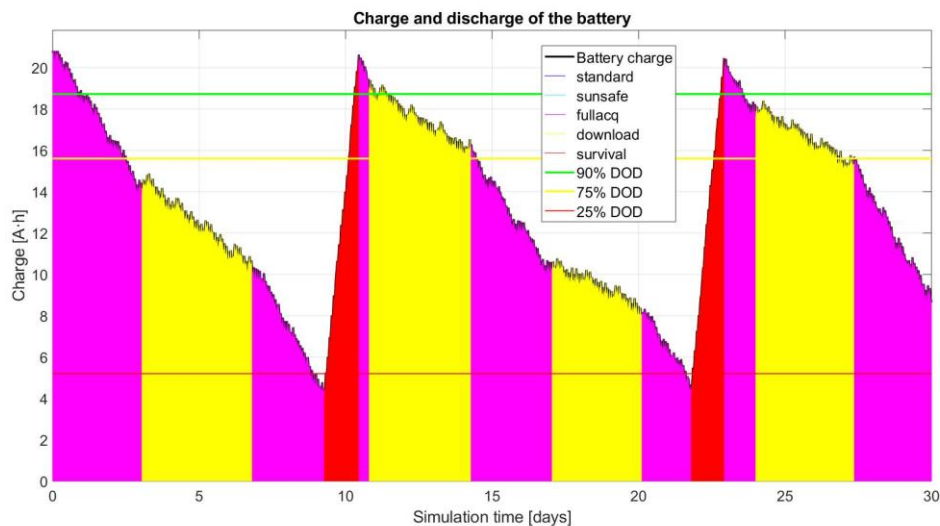


Fig. 2.24 Battery Charge in Full-acquisition mode in 30 days simulation with mode changes

The behaviour is really simple to explain: the satellite does full-acquisition: only takes photos until the memory maximum level is reached. Then it changes to download mode. When the memory is available again it returns to full-acquisition mode. Sometimes like in day 9 it must change to survival mode to recover battery and then return with previous mode. See Fig 2.24.

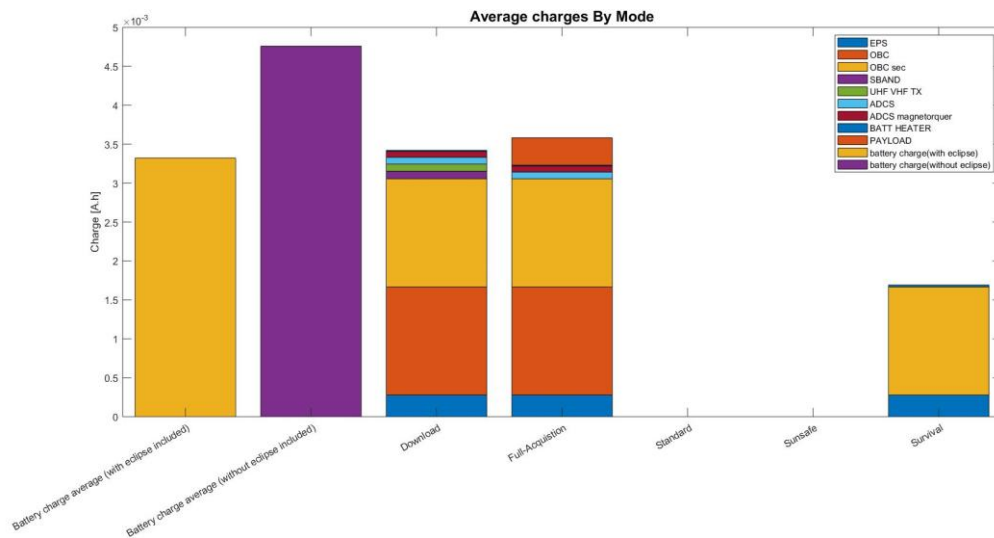


Fig. 2.25 Average battery charge of the subsystems (in one iteration) in Full-acquisition mode in 30 days simulation with mode changes

In Fig 2.25 can be seen that both download and full-acquisition consume more than the average battery supply so the battery charge decreases.

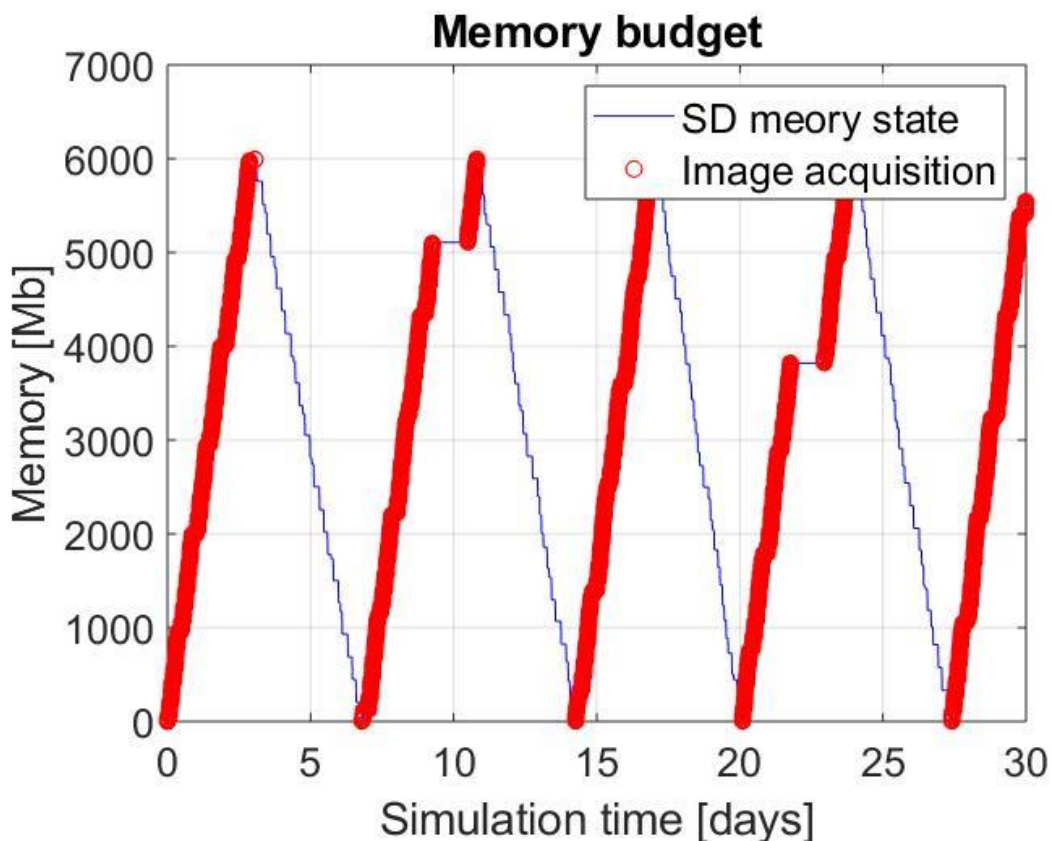


Fig. 2.26 Memory budget of Full-acquisition mode in 30 days simulation with mode changes

In Fig 2.26 can be seen easily how during in full-acquisition images are taken and during download the memory reduces because the photos are being downloaded. In day 9 and in day 22 there are two small stripes where there are neither downloads nor photos. This is because in these stripes the managing mode is the survival one.

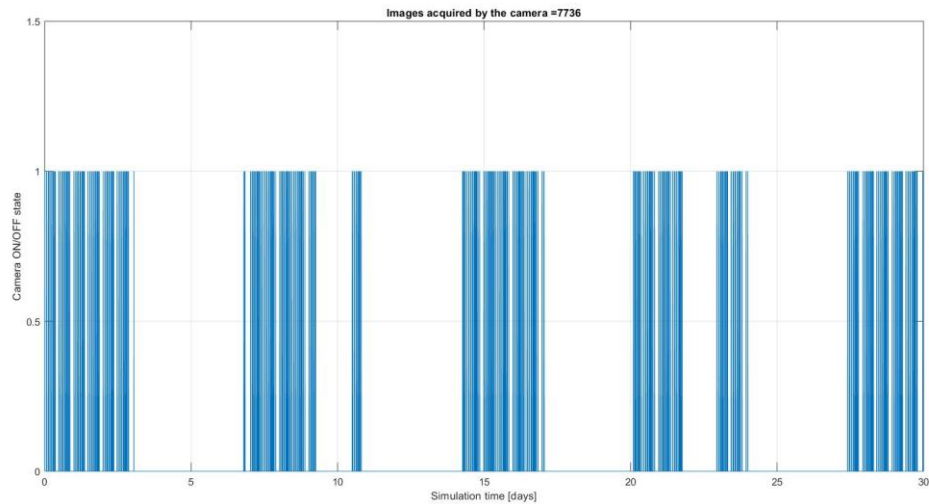


Fig. 2.27 Photos captured in Full-acquisition mode in 30 days simulation with mode changes

Fig 2.27 shows when the photos are taken. Where there are photos match with the full-acquisition periods.

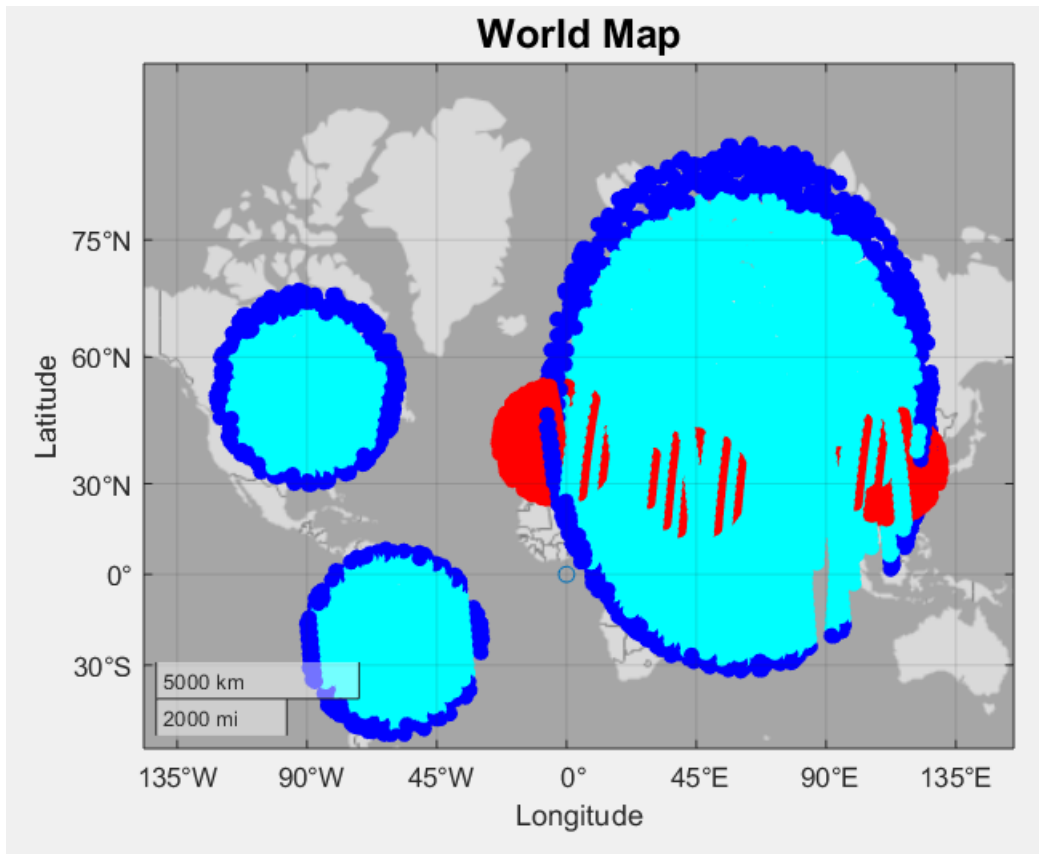


Fig. 2.28 World map coverage of the mission in Full-acquisition mode in 30 days simulation with mode changes

In Fig. 2.28 can be seen the world coverage. The plot is programmed to put the points where the images and downloads are done in each iteration. For this reason there are point over superimposed to another ones. The last mode before finishing this simulation was the full-acquisition mode so the last points added are blue and overlap the red ones.

2.4.4. Comparison of modes combinations

At this point, all the possible combinations are proved. It's time to analyse some key factors to take conclusion of which one is the optimal one.

The main factors to compare are joined in Table 2.9.

Table 2.9. Main Parameters of each mode or mode combinations.

Mode or modes	Number of photos	% of time with the heater	% of time downloading	% of time taking photos	BatteryDeath Remaining days
standard	15486	1.85%	3.59%	5.97%	3000
sunsafe	16532	1.7%	3.88%	6.37%	1166
fullacq	3141	1.6%	0%	1.211%	4830
standard mix	14201	1.6%	3.76%	5.48%	2100
sunsafe mix	14810	1.7%	3.901%	5.73%	3450
fullacq mix	7736	1.58%	1.82%	2.98%	2333

Talking about the amount of photos taken, It can be seen than the greater amount are obtained when the sunsafe mode work independently. But as it has said this happens because the simulations it wasn't too long. It will arrive to a point that the memory and battery will collapse if there are not another modes to manage the situation. So mixing modes is the best solution. At this point is time to decide which ones is the most suitable mode to begin.

The mode to start that give better results is the sunsafe mode, it allow making more photos because it consume less so it need more time to change to survival mode to recover the battery. Indeed in 30 days the simulator does not have the need of entering in survival mode, while when the standard or the full-acquisition were the original ones it was mandatory.

It doesn't mean that always is the best solution; there are lots of factors that affect: the position of the target areas and ground stations, the consumptions of the subsystems, the type of orbit... Work with sunsafe as a main mode could be a problem if the simulation is too short, because most of the subsystems don't work when there is an eclipse.

If the consumes of the subsystems were lower maybe with the standard mode could be enough to do long missions, and taking into account that this mode work in equal way during the entire orbit, it has an advantage in comparison with the sunsafe mode.

The full-acquisition mode for example has the higher dependency on the position of the target areas; because to optimize this working mode, the ideal situation would be make the periods of full-acquisition match with the target areas and the ones with download mode with the ground station. One improvement that could be useful for the simulator will be an algorithm that, given a target areas or a group of them, it locates the best position for the ground stations in order to optimize the periods of capturing and downloading. The information of the orbit is available so it could be possible realise that improvement.

With all of this reasoning, I want to demonstrate that there is not only a solution at the time of deciding which the best working modes configuration is. This is one of the greatest things of this simulator, several combinations can be tested and the user can decide depending on its objective.

In the next section, some functionalities will be added to the simulator. It will be really interesting see how the different modes configurations manage each situation.

2.5. Other Software improvements

The implementation of the working modes is not the only significant improvement of the simulator, some functionalities has been added too. The objective is converting the simulator into a useful professional machine that can realise a big range of space mission.

A precision functionality has been added. Also, the constraint that the original version of the simulator of only capture images from a specific target areas, can be broken due to the new functionality that permit making photos during all the orbit. The same functionality is added with the transmission of information. Furthermore an option of mixing more than one type of paint is added in order to see which combination would be the most suitable. Finally, is added the option of taking into account an overvoltage every time that a subsystem is switched on.

The idea is explain and test the different functionalities using different working modes configurations in order to see which ones behave better.

2.5.1. Precision

The precision functionality is added to the simulator because sometimes the mission could require photos of a higher quality. In order to do these photos the satellite must put some "effort" that, what is most probable, will make any subsystem to consume more. In the case of our simulator the precision mode will suppose the activation of the reaction wheels during all the period that this "subsystem" is activated.

Furthermore this application requires a time of preparation. For the simulations that will be showed the preparation time will be half an hour. During this preparation time the satellite will not take any photography.

The precision mode will be tested in a 30 days simulation between day 10 and day 20.

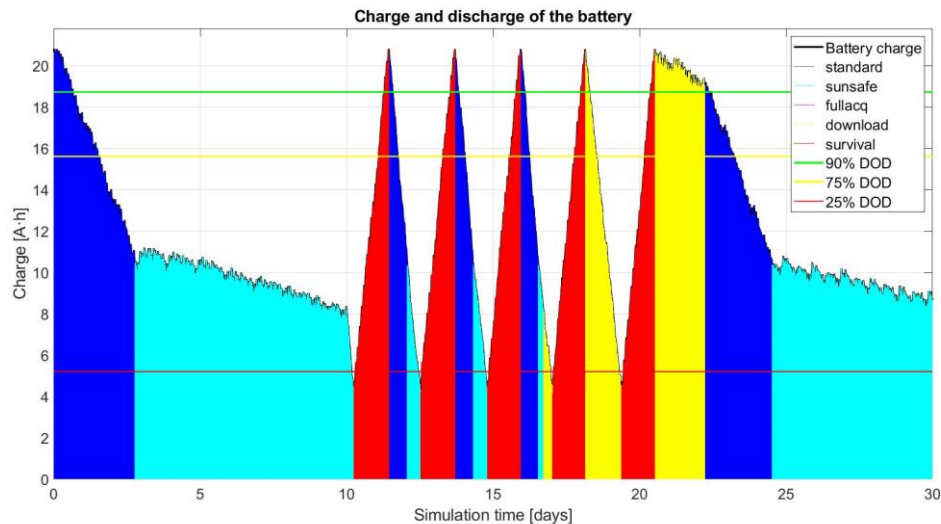


Fig. 2.29 Battery Charge in Standard mode in 30 days simulation with mode changes with precision mode between day 10 and 20

The first simulation is done with the standard mode as initial mode, and mode changes are allowed.

In Fig. 2.29 it can be seen that between days 10 and 20 the consumption increases a lot because is the period of time when the precision “subsystem” is activated. The activation of the reaction wheels are a big impact and the simulator must enter in survival mode 5 times only in ten days.

In this simulation practically all the possible mode changes that could happen appear. The ones related with limitations on the battery charge and the ones related with the memory level. What can be said is that the system is strong and manages the situation in a proper way.

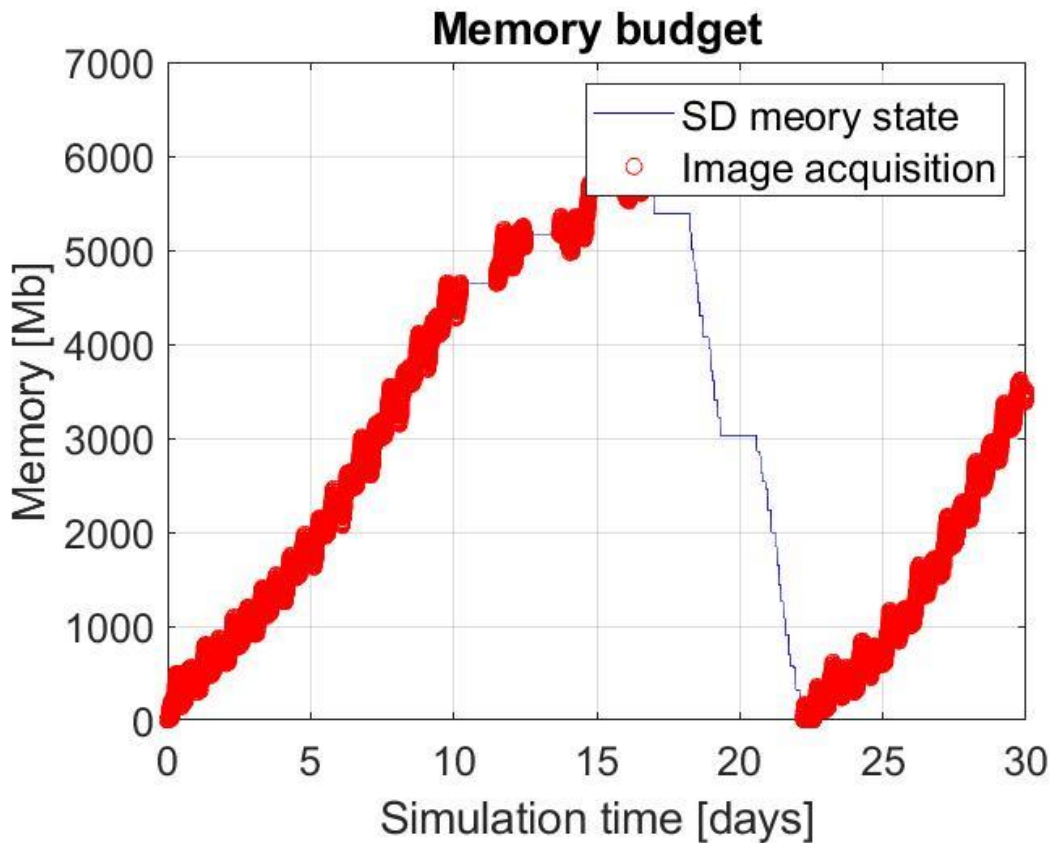


Fig. 2.30 Memory budget of Sunsafe mode in 30 days simulation with mode changes with precision mode between day 10 and 20

In Fig 2.30 is presented the evolution of the memory during the simulation. It can be appreciated that between day 10 and 20 there are a few periods where the state of the memory doesn't change: this is because the simulator is in survival mode.

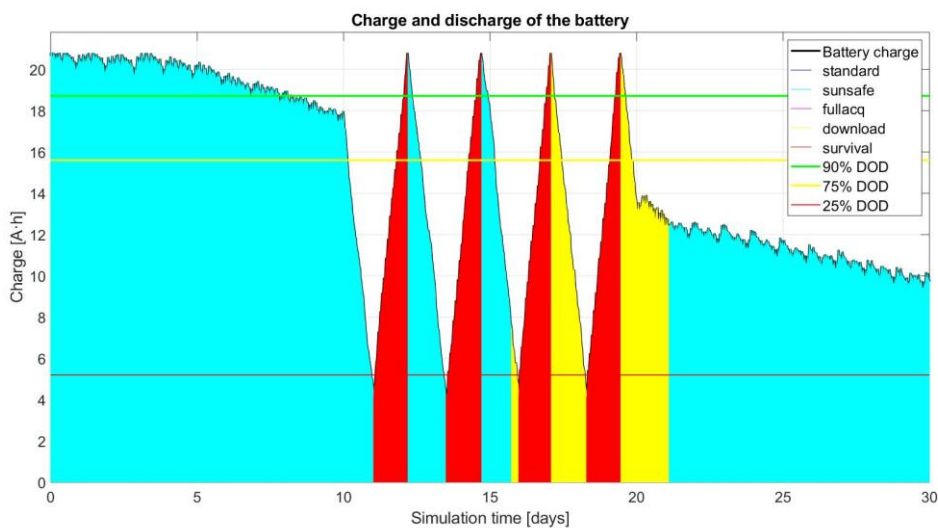


Fig. 2.31 Battery Charge in Sunsafe mode in 30 days simulation with mode changes with precision mode between day 10 and 20

The second simulation is done with the sunsafe mode as initial mode, and mode changes are allowed.

The battery charge evolution plot showed in Fig. 2.31 is really similar to the one when the standard mode is the initial mode. The simulator must use the survival mode in the period time where the precision “submode” is operative. In previous sections the simulation showed with this mode configuration didn’t need the survival mode.

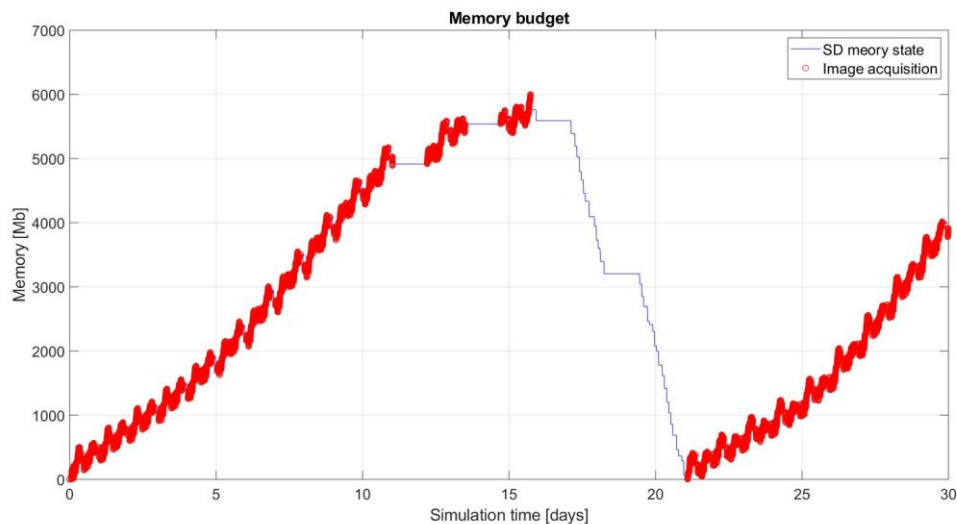


Fig. 2.32 Memory budget of Sunsafe mode in 30 days simulation with mode changes with precision mode between day 10 and 20

In Fig. 2.32 the memory arrives to the limit more or less at the same time than the previous simulation where the standard was the initial mode. Here we can assume that using the standard mode or the initial mode the results are really similar when the precision “submode” is activated in most of the simulation. In fact if the simulation would be with precision at all, the differences are minim.

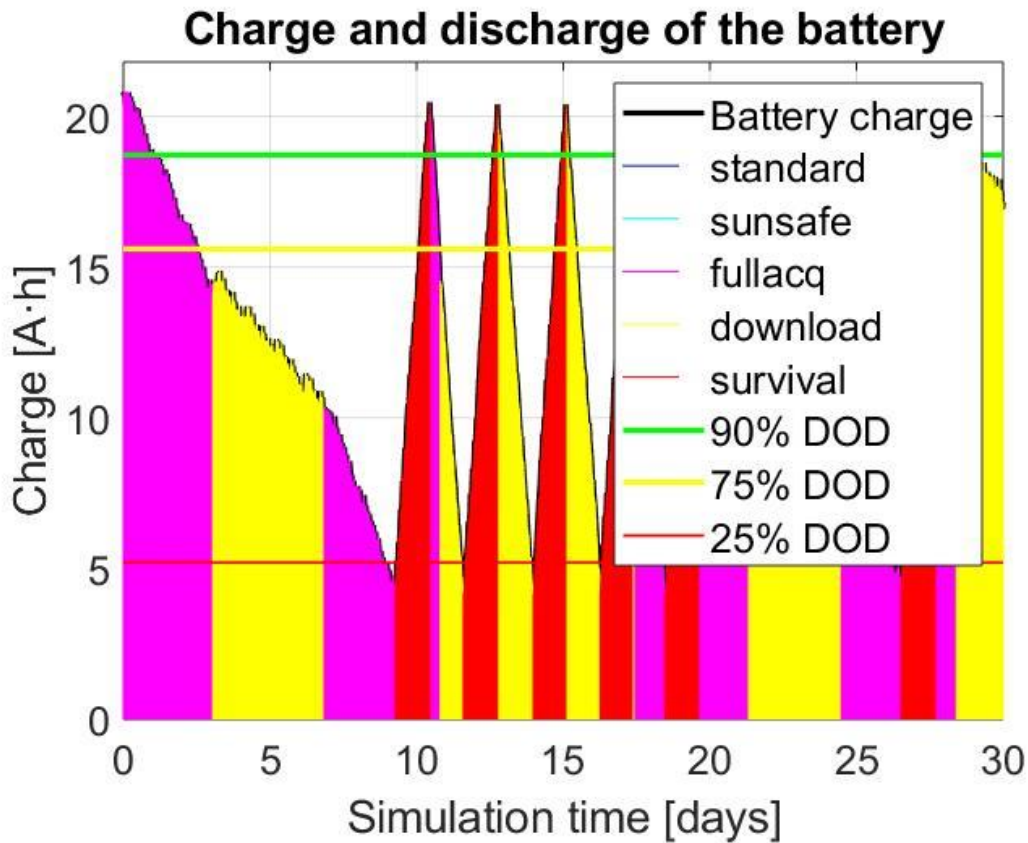


Fig. 2.33 Battery Charge in Full-acquisition mode in 30 days simulation with mode changes with precision mode between day 10 and 20

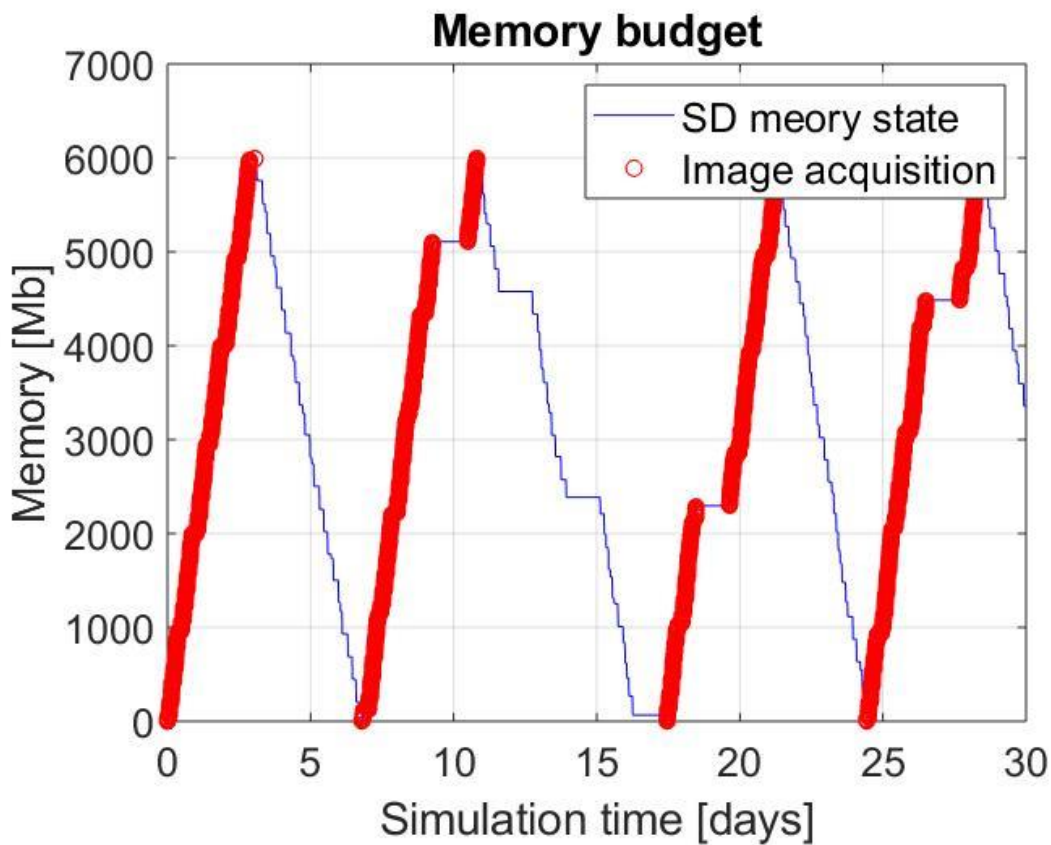


Fig. 2.34 Memory budget of Full-Acquisition mode in 30 days simulation with mode changes with precision mode between day 10 and 20

When the full-acquisition mode is the starter mode, the satellite consumes faster and in the period of time where the precision “submode is activated it needs to enter in survival mode 6 times. See Fig. 2.33 and Fig. 2.34.

These firsts’ simulations with 10 days of precision are showed to see the affectation in comparison with the “normal behaviour” of the simulation. What happen when precision mode is activated during 29 day of the 30 is showed in the next images: (the precision mode starts when the second day and not in the first day because it needs the period of time of preparation already explained).

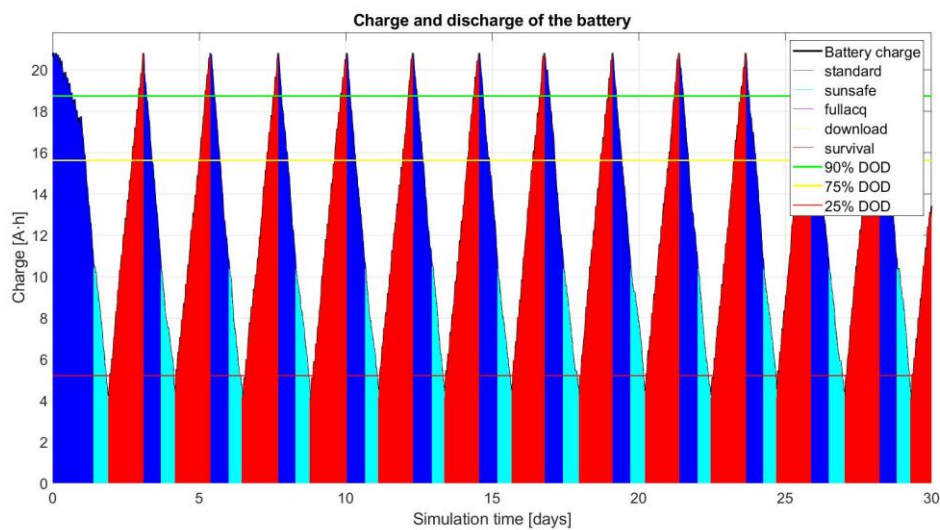


Fig. 2.35 Battery Charge in Standard mode in 30 days simulation with mode changes with precision mode between day 2 and 31

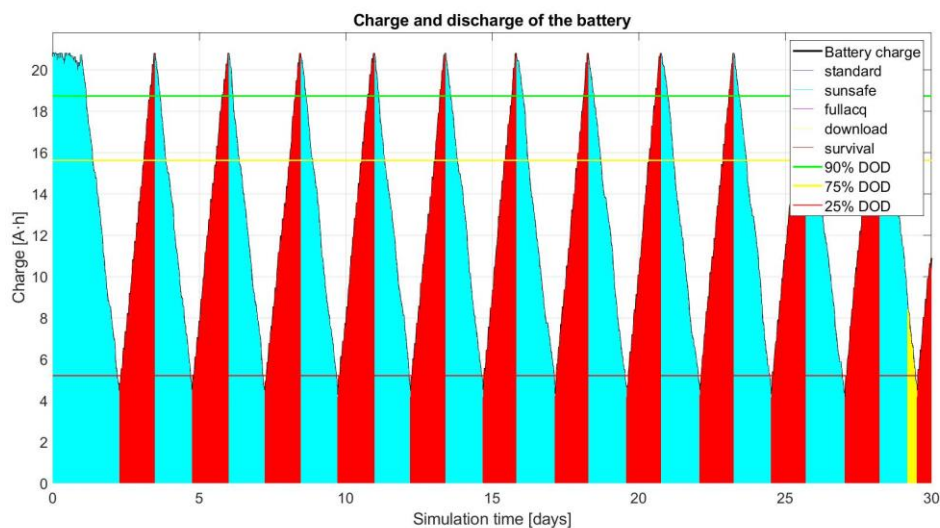


Fig. 2.36 Battery Charge in Sunsafe mode in 30 days simulation with mode changes with precision mode between day 2 and 31

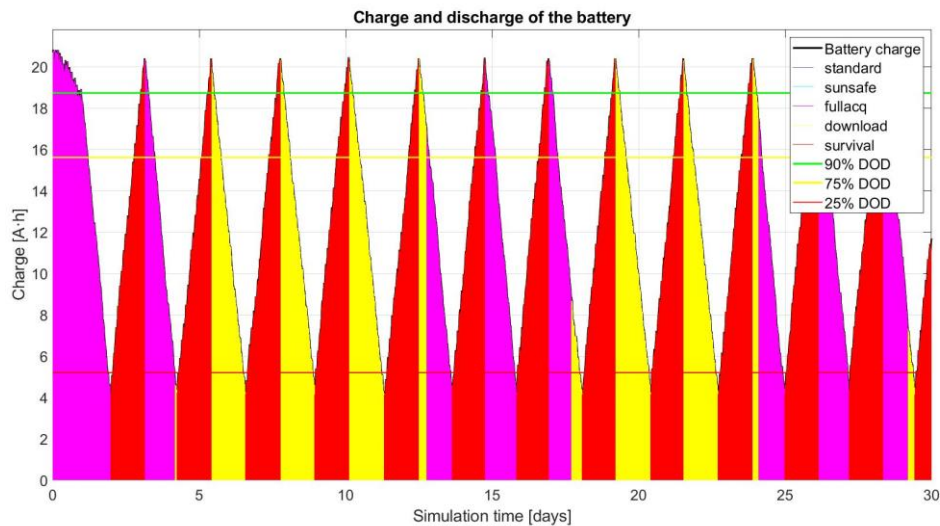


Fig. 2.37 Battery Charge in Full-acquisition mode in 30 days simulation with mode changes with precision mode between day 2 and 31

Fig. 2.35, Fig. 2.36 and Fig. 2.37 confirm the idea that survival mode is needed in most of the simulation due to the precision “submode” activation. Taking into account the number of photos captured, the standard and sunsafe as initials capture more than 8 thousand photos. 8373 photos captured for the standard as initial and 8869 for the sunsafe. So it is a similar performance.

The full-acquisition only captures 4714 photos. This make sense because, looking at the simulation in Fig 2.X can be seen that the simulator is a lot of time in download mode. It is interesting that in 30 days the standard mode can't full the memory until the level specified for entering in download. The sunsafe achieve this goal near the end.

Once the different mode configurations have faced the precision “submode”, it is time of taking conclusions:

The periods of time where the precision “submode” is active the consume increases a lot so the survival mode is needed. The standard and sunsafe mode as initials modes have a similar behaviour. Both modes combination have really better performance than full-acquisition as starter. This because it supposes entering several times in download mode.

An important aspect is that during the precision periods, the battery charges and discharges suffer abrupt changes. Each process of charge and discharge of the battery counts as 1 working cycle. Remember than for different battery change levels there are a limited number of working cycles. This data will help the user knowing when is predicted to be death of the battery. So it is possible to compute the maximum time that the mission can be operative. This behaviour of do a lot of cycles means a reduction in the battery live. For example in the case of the full-acquisition as starter modes, the introduction of

10 days of survival has reduced the expected days to battery death from 2100 days to 1400.

What is absolutely certain is that the mode changes are mandatory to “survive” to the precision “submode”.

2.5.2. All-photos

One of the statements of the previous version of the simulator was that photos only could be captured over the target areas. Now, there is parameter called allPhotos that permits doing photos during the entire orbit. Furthermore can be selected the percentage of the time in which a photography must take it. The parameter is called percentageOrbitPhotos. For example a 100% in this parameter will mean that in each iteration, the simulator will try to capture an image. A 50% means a photo every two iterations, a 25% every four...

To test how this affect to the satellite performance, the same simulation take it with 10 days of precision will be done again but in this case allowing the capture of photos during the full orbit. The percentageOrbitPhotos parameter is putted at 100%.

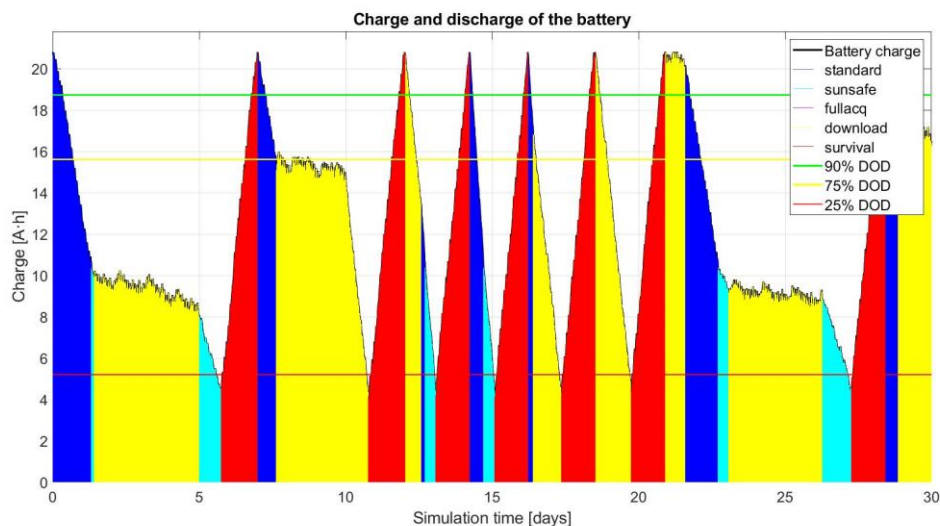


Fig. 2.38 Battery Charge in Standard mode in 30 days simulation with mode changes with precision mode between day 10 and 20 with allPhotos at 100%

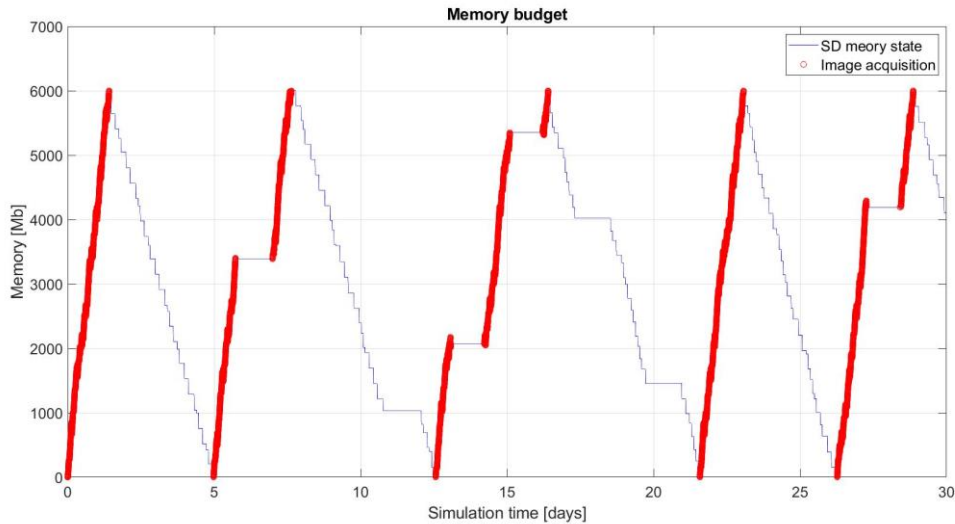


Fig. 2.39 Memory budget of Standard mode in 30 days simulation with mode changes with precision mode between day 10 and 20 and allPhotos at 100%

Fig. 2.38 and Fig. 2.39 show how the periods of time of standard mode and sunsafe are shorter whit the AllPhotos parameter at 100%. This is because the camera is always active with this modes and the consume increases. The memory limit is also reached faster. The download mode and the survival one remain behaving equally because this parameter doesn't affect to them.

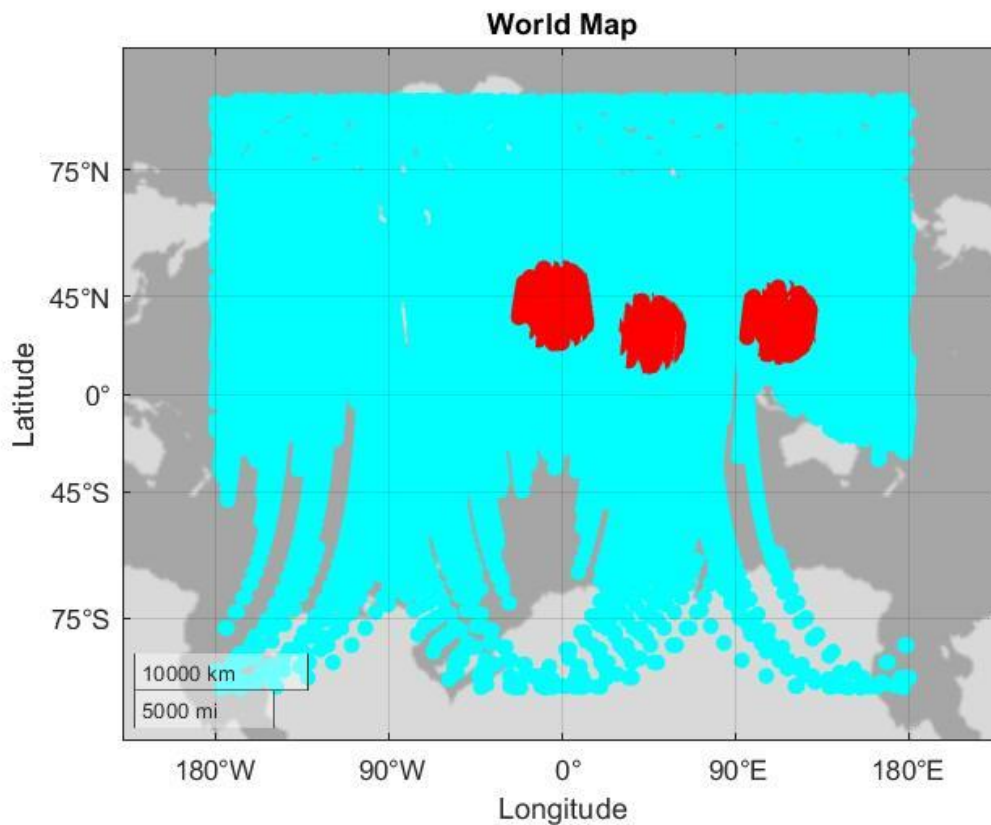


Fig. 2.40 World coverage in standard mode in 30 days simulation with mode changes with precision mode between day 10 and 20 with allPhotos at 100%

In Fig.2.40 a big difference in the world coverage can be appreciated. In that case there are no target areas so the simulator does the photos wherever it can. The reaction wheels are not needed to point to an area. This subsystem only is activated in the period of time of precision.

With this map is easy to see how important the selection of the orbit is. In that case it is pointing more to the northern hemisphere. Furthermore remember the affectation of the eclipse periods, where the camera can't be activated because the camera doesn't do nocturne photos. These concepts should be the reason of why there are areas with more photos than others.

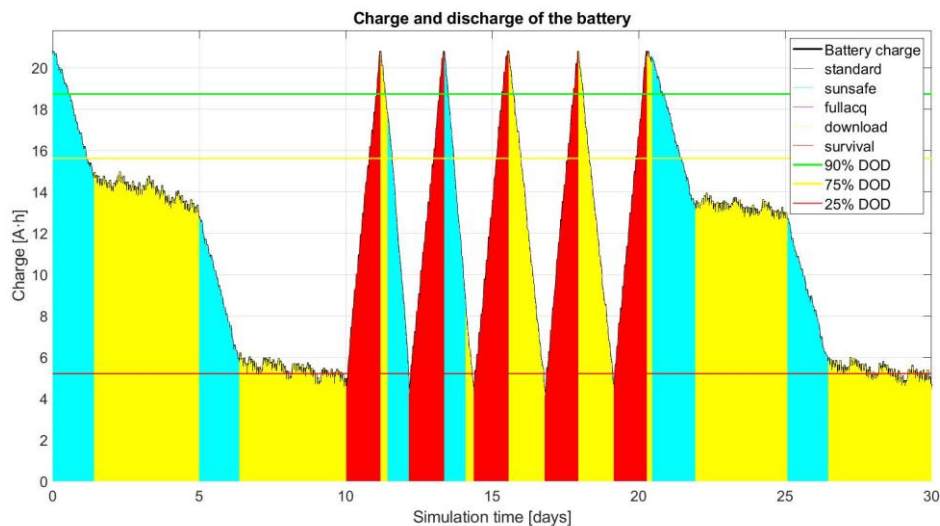


Fig. 2.41 Battery Charge in Sunsafe mode in 30 days simulation with mode changes with precision mode between day 10 and 20 with allPhotos at 100%

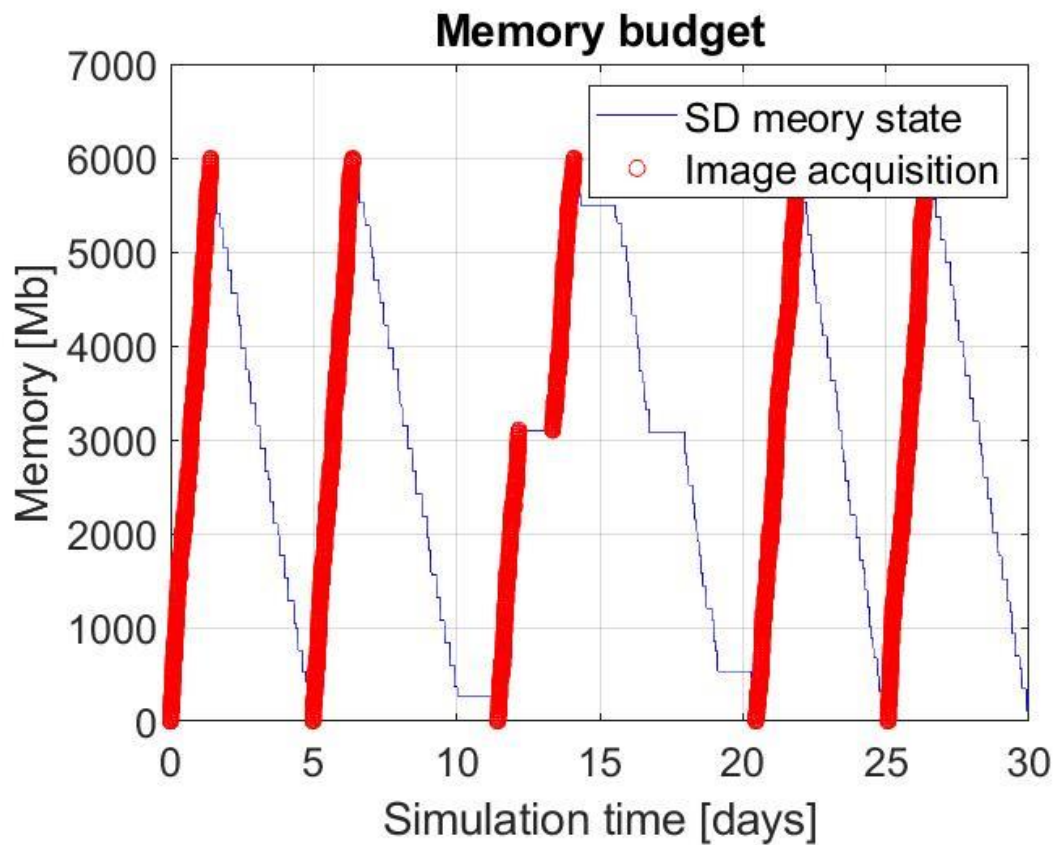


Fig. 2.42 Memory budget of Sunsafe mode in 30 days simulation with mode changes with precision mode between day 10 and 20 and allPhotos at 100%

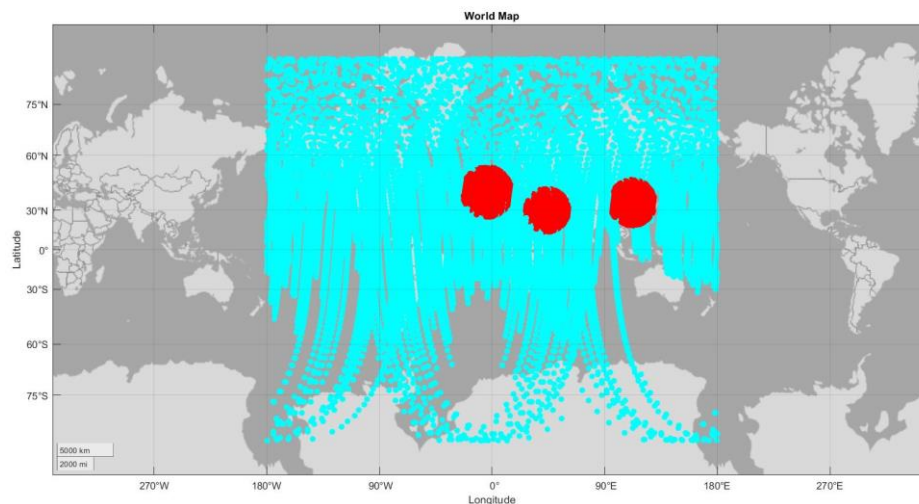


Fig. 2.43 World coverage in sunsafe mode in 30 days simulation with mode changes with precision mode between day 10 and 20 with allPhotos at 100%

When the initial mode is the standard, the behaviour is similar. See Fig.2.41, Fig.2.42 and Fig.2.43.

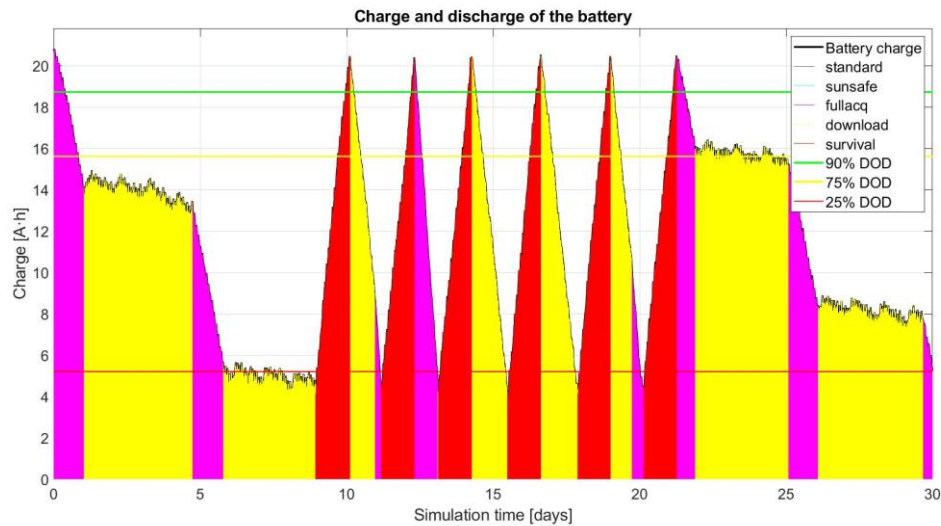


Fig. 2.44 Battery Charge in Full-acquisition mode in 30 days simulation with mode changes with precision mode between day 10 and 20 with allPhotos at 100%

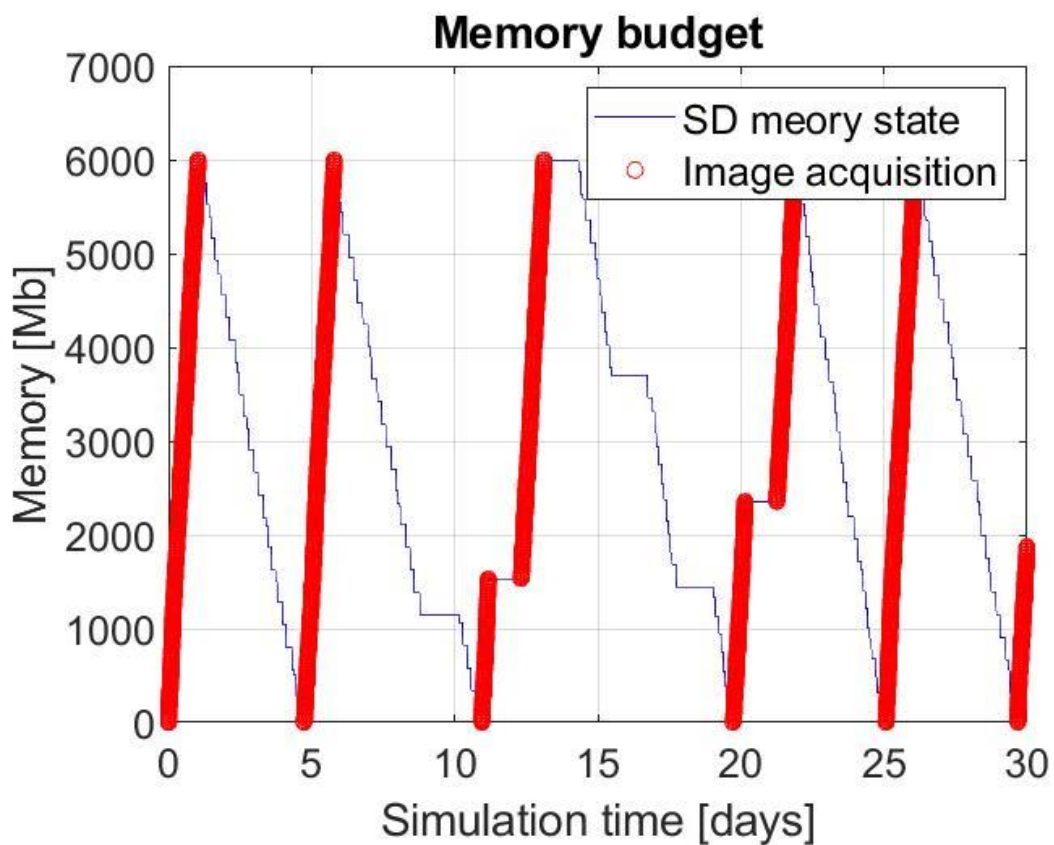


Fig. 2.45 Memory budget of Full-Acquisition mode in 30 days simulation with mode changes with precision mode between day 10 and 20 and allPhotos at 100%

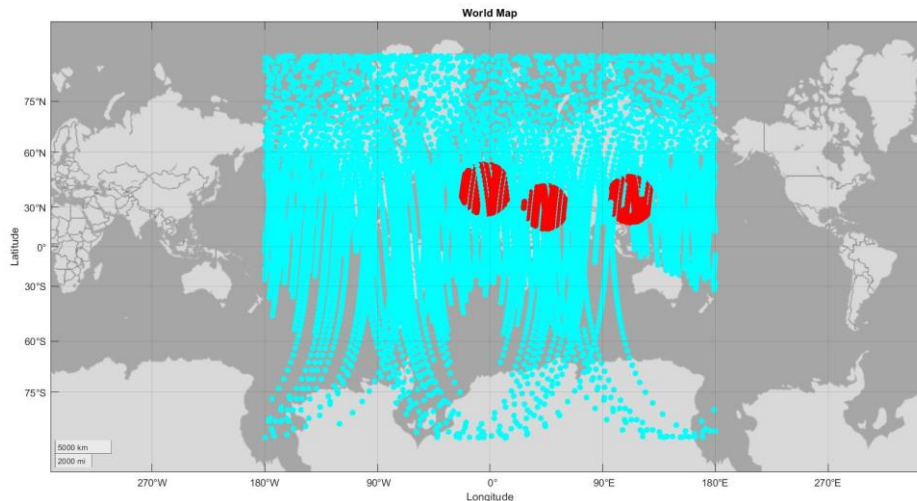


Fig. 2.46 World coverage in full-acquisition mode in 30 days simulation with mode changes with precision mode between day 10 and 20 with allPhotos at 100%

When the initial mode is the full-acquisition, the consumption increases too, memory arrives to its limit faster and the periods of time with this mode are reduced. The download and survival modes remain equally. See Fig.2.44, Fig.2.45 and Fig.2.46.

Finally to conclude that section, the three combinations of working modes, suffer the same problem: the modes that take photos, consume much more which provokes a higher discharge of the battery. Furthermore the memory is filled faster. To solve this situations the simulator must change to download mode and survival more often.

2.5.3. All-Transmission

The same idea of making images in every part of the orbit is taken to apply it with the downloads. The simulator has now a parameter called allTransmission that allows the satellite of realising downloads at any point of the orbit without taking into account the position of the ground stations. Furthermore there is another parameter called percentageOrbitTransmission to control the flow of information. With a 50% in this parameter the satellite realise a transmission every 2 iterations.

This implementation is not realistic because this means that can download photos in the middle of the ocean for example. Anyway a simulation is done with the following characteristics. See Table 2.10.

Table 2.10. Main Parameters of each mode or mode combinations.

Parameter	Value
Initial mode	Standard
mix	Yes (mode changes allowed)
precision	Yes (between day 10 and 20)
allPhotos	Yes (independency of the TA)
percentageAllPhotos	50% (a photo every 2 iteration)
allTransmission	Yes (independency of the GS)
percentageAllPhotos	10%(a transmission every 10 iterations)

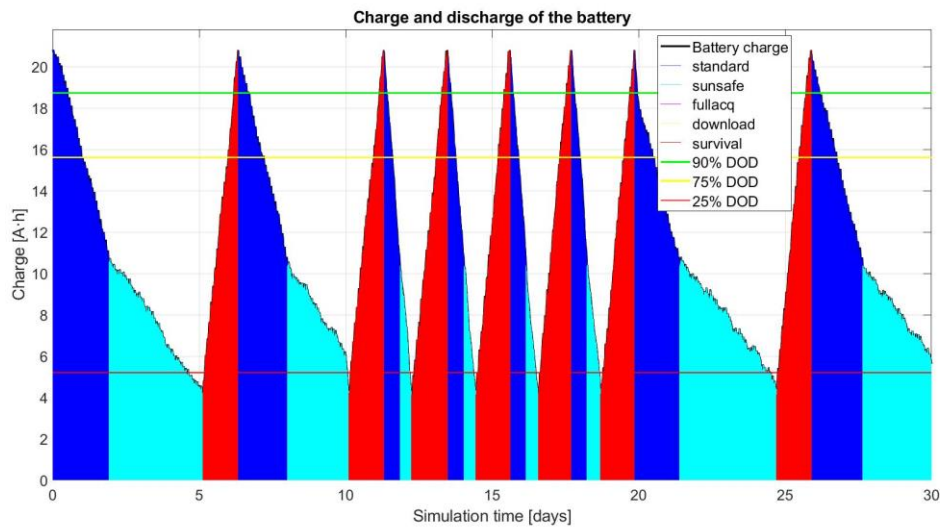


Fig. 2.47 Battery charge in standard mode in 30 days simulation with mode changes with precision mode between day 10 and 20 with allPhotos at 50% and allTransmission 10%

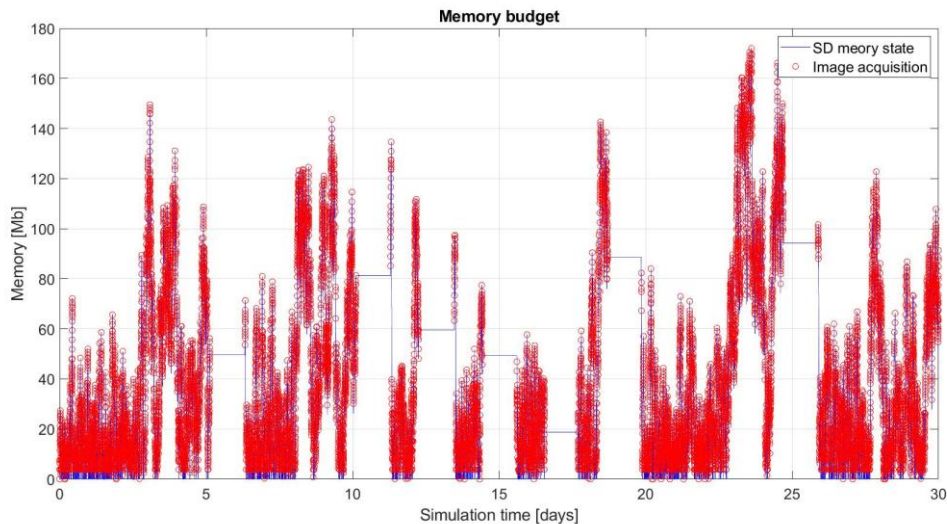


Fig. 2.48 Memory budget in standard mode in 30 days simulation with mode changes with precision mode between day 10 and 20 with allPhotos at 50% and allTransmission 10%

Seeing Fig.2.47 and Fig.2.48 can be seen that the download mode is not needed anymore. The possibility of transmitting in every part of the orbit allows to don't surpass the level of activation (600Mb in this simulation). Only 170 Mb as a maximum is filled in day 24.

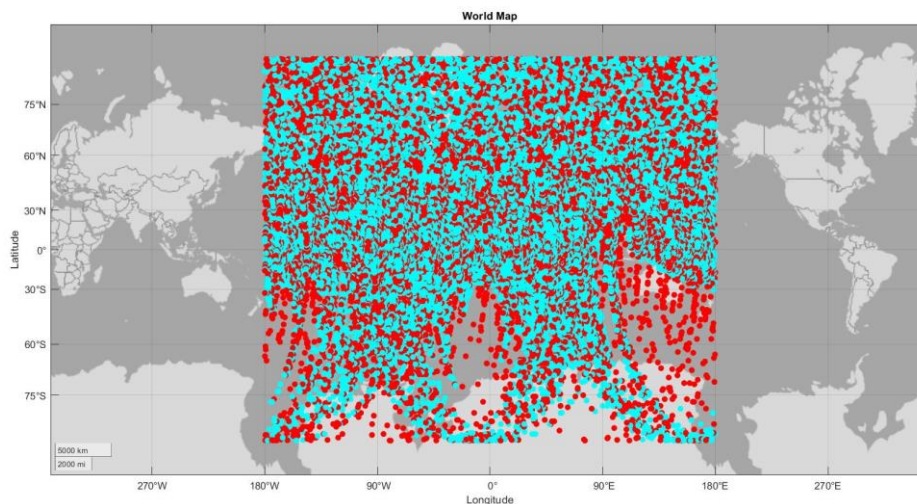


Fig. 2.49 World coverage in standard mode in 30 days simulation with mode changes with precision mode between day 10 and 20 with allPhotos at 50% and allTransmission 10%

In Fig 2.49 can be observed that the world coverage changes a lot. The areas in which there are downloads (in red) and not captures (in blue) are the zones where the satellite is in eclipse and can't make photos (because the camera can't do nocturne photos).

As it has said it is not a useful implementation because it doesn't make sense make downloads if there is not a ground station to receive the images, but this simulation helps for taking some conclusions:

In one hand, if the areas to download are as big as the area to capture images, is very probable that the simulator will not need to enter in download mode to empty the memory.

On the other hand, not all the areas can be captured given a fixed orbit. The satellite could be always in eclipse at the time of capturing these zones.

2.5.4. Overvoltage

An electric device when is switched on by first time can suffer an overvoltage. Now the simulator has an option of modulating this overvoltage for each the subsystems. It has a parameter called `overVoltage` that activates it and another one called `overVoltagePercentage` that controls which percentage of the original consumption of a subsystem is taken into account each time that a subsystem is activated. This is only added each time a subsystem is switched on, it does not count if in the previous iteration was already activated.

It could seem that this improvement is not really important. That can't have a big impact in the performance of the simulator. But doing a simulation of 30 days with various overvoltage percentages the result is surprising. See Table 2.11.

Table 2.11. Affectation of the overvoltage

OverVoltagePercentage	Number of photos
0%	11605
25%	10909
50%	10310
75%	9628
100%	9461

The number of photos do it by the simulator reduces in a notorious way if the with the introduction of an overvoltage. See Table 2.11.

It is important to consider this overvoltage because the results obtained by the simulator could be misleading. Of course it is really complex process to quantify and reflect it in the simulator as it happens in reality. Meanwhile put a value approximated will be better than nothing. It can help of avoiding situations of unexpected battery discharges.

2.5.5. Paint affectation

The last improvement is the possibility of mixing more than one type of paint in the exterior of the satellite. The sun rays contact directly to the solar panels and to the chassis of the satellite. The solar panels can't be removed or painted, but the chassis yes.

The colour of the paint is really important because is a thermal control passive device that can condition a lot the mission. With a good decision in the selection of the colour, the active control device: the heater, can be less used. This means that the power would spend can be used for example for taking photos.

The decision must not be select a type of paint with a colour that don't emit practically heat and absorb a lot because this will mean that the simulator will warm a lot. Some components can't work if the satellite temperature is too high. Ideally the satellite temperature should be around 25 degrees. As it has said most of the component of the satellite have been designed for "ground" use, but have been adapted to work in places with extreme temperatures.

In order to find a colour of paint that helps the satellite to work in a proper way, the simulator allows use a combination of black paint and white paint. Neither of the colours is really useful used individually. The black paint makes the satellite warm a lot and the white one requires the constant use of the heater. This paint colours have really different emittance and absorptance coefficients so a combination of them could be the better solution. See Table 2.12.

Table 2.12. Absorptance and emittance coefficients

Colour of paint	Absorptance	Emittance
Black paint	0.95	0.85
White paint	0.12	0.9

To see which percentage of each type of paint gives a better result, some 30 days simulations will be performed with different combinations.

Table 2.13. Absorptance and emittance coefficients

% of white paint	% of black paint	Average Temperature [°C]	% of heater use
100	0	15.9	25.6
70	30	26.06	1.66
50	50	32.77	0
30	70	39.18	0
0	100	48.21	0

As it has seen in Table 2.13, the best combination is when the percentage of white paint is 70% and the black one 30%. The average temperature is really near to the ground temperature and the percentage of use of the heater is low so is acceptable. With a higher percentage of white paint, the average temperature is a bit low and the use of the heater too high. It would have big impact in the mission. In the other side if the percentage of black paint is more than the 30%, the satellite warms a lot so, some components could melt, which is a catastrophic situation.

2.6. Specific Mission

Once all the improvements have been obtained, a long duration mission of 90 days will be performed to see how the simulator behaves.

The objective of the mission is taking photos of the earth into three target areas: one in south-America, other in the east of North America and a big one that will contain Europe, Africa and a part of Asia. The photos obtained will be downloaded into three ground stations during the flight. The stations are located in: Spain, Saudi Arabia and China.

The satellite will perform the mission using an orbit with a height of 550 km and an orbit inclination of 98° . The rate of ascension RAAN is 0. The True anomaly is 0 too.

Between days 31 and 61, the precision "submode" will be activated. It will need 30 minutes for preparing the satellite. During these 30 minutes the satellite will not be able to take photos.

The satellite used will have a box shape. The dimensions are 300x200x100 (more or less like a shoe box). It is going to be a sun energy based mission. In the external part of the satellite solar panels will be located. The energy obtained from the panels will be stored into a battery. The battery will feed the different subsystems depending the working mode ruling.

The next table summarizes some of the inputs of the mission:

Table 2.14. Some inputs of the missions

Parameter	Data
Duration	90 days
Initial mode	standard
Mix (mode changes)	yes
Battery percentage to enter in sunsafe	50
Battery percentage to enter in survival	70
allPhotos	no
allTransmission	no
Memory percentage to change to download	50
Precision	yes
Precision days	31-61
Overvoltage	yes
Overvoltage percentage	25
Ground stations	3
Target areas	3
Chassis white paint percentage	70
Chassis black paint percentage	30

Once the simulation is done, it is time of analysing the obtained results:

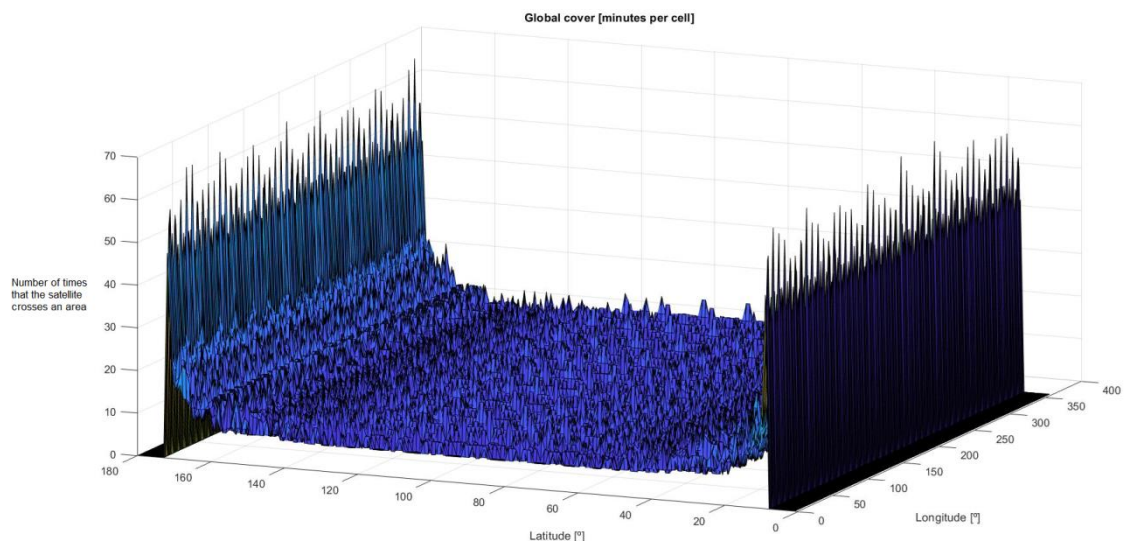
**Fig. 2.50** Map satellite trajectory cover

Fig. 2.50 shows how many times the satellite passes ahead a specific world zone. It is interesting to take into account this type of maps at the time of putting the ground stations. Anyway, a good improvement for the software would be an algorithm capable of locating the ground stations in their optimal positions. It would consider the orbit, the duration of the mission, the position of the target areas...

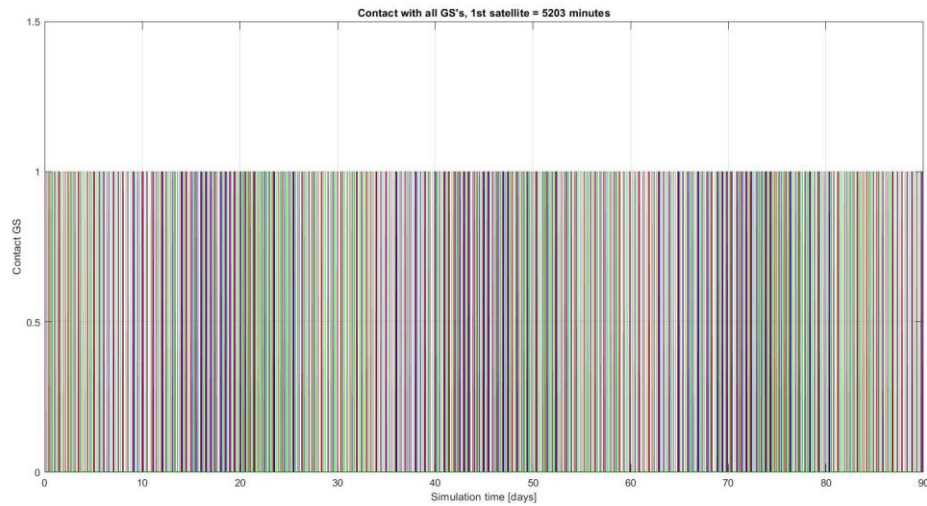


Fig. 2.51 Contact with all ground station

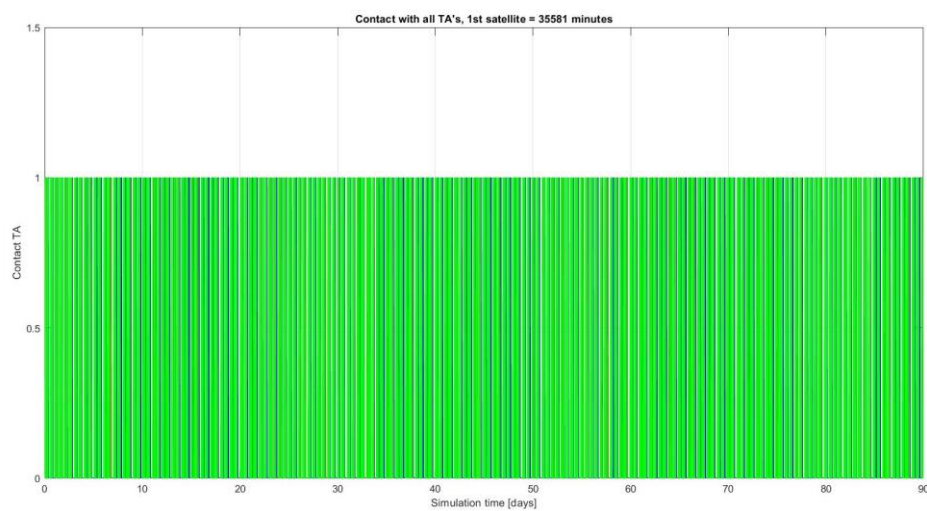


Fig. 2.52 Contact with all target areas

Fig 2.51 and Fig 2.52 shows when a contact with a ground station or a target area is done. These plots also indicate the total amount of time of contact. The different colours try to differentiate between ground stations and target areas. It is difficult to differentiate when the simulation is as long and there are as many contacts as in this mission.

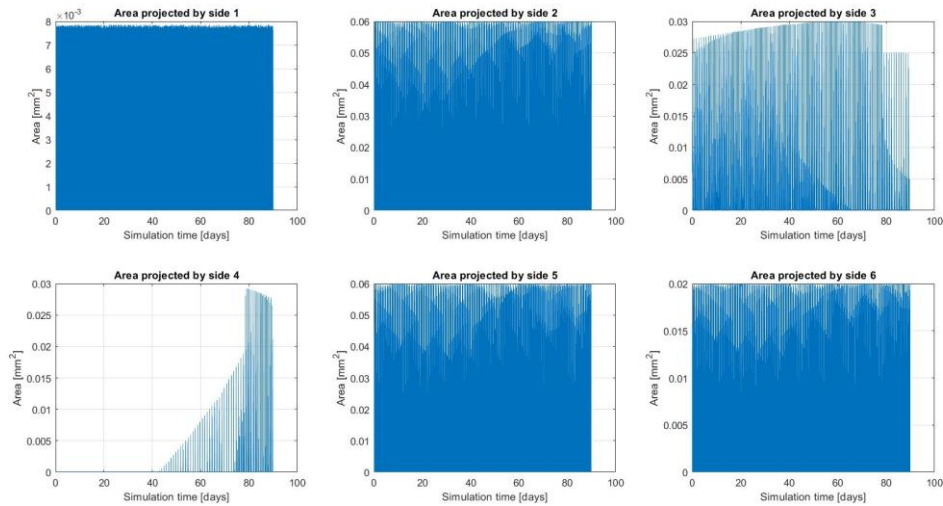


Fig. 2.53 Projected area of the different faces of the satellite

Fig. 2.53 shows the projected area (the area of the satellite that points to the sun) during the simulation. This data is used to compute the amount of power received by the sun.

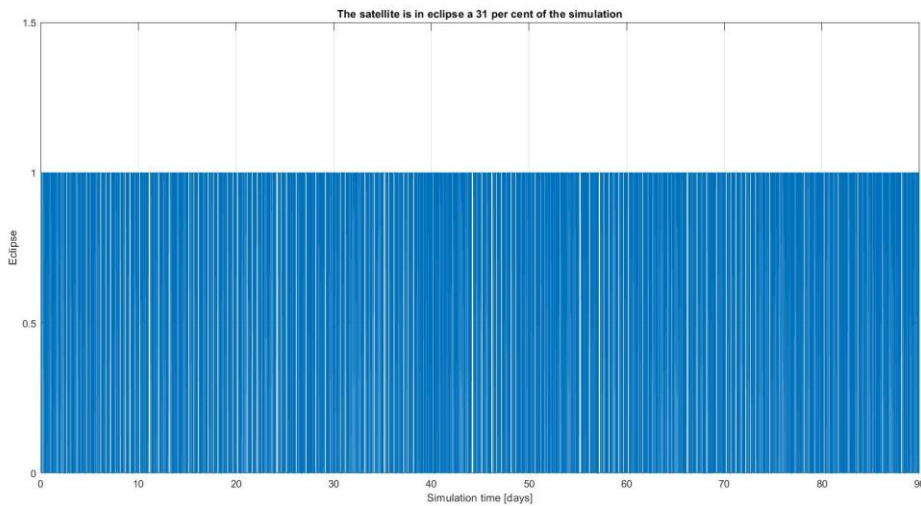


Fig. 2.54 Eclipses

In Fig. 2.54 can be seen the part of the simulation where the satellite is in eclipse. In total it is the 31%.

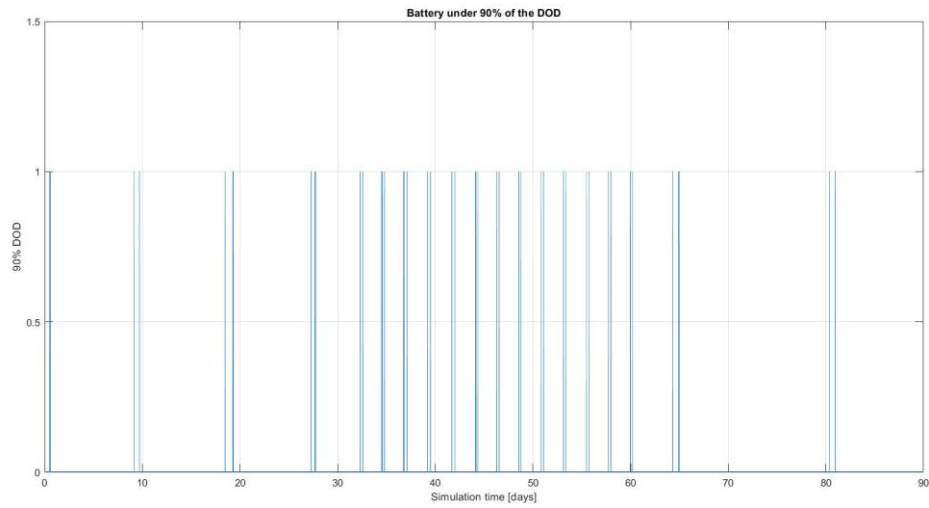


Fig. 2.55 Battery under 90% of the DOD (coming from over 90%)

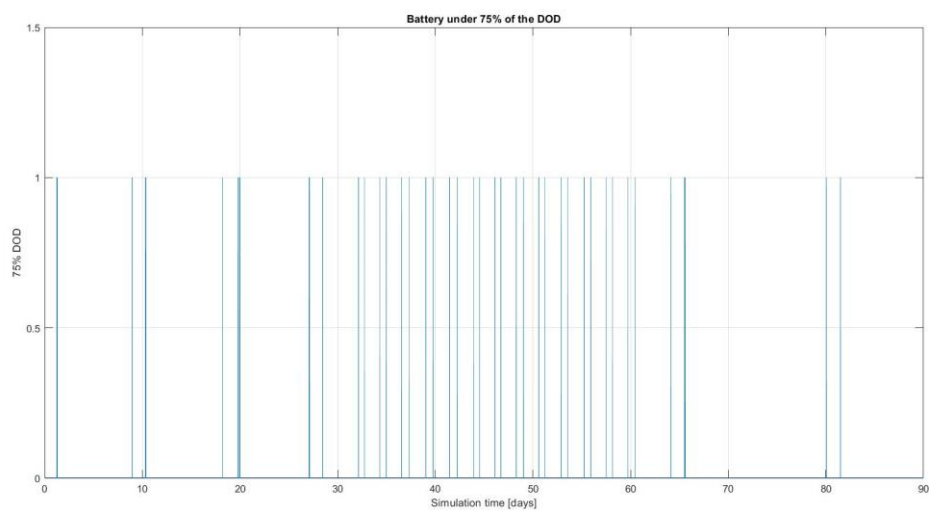


Fig. 2.56 Battery under 75% of the DOD (coming from over 75%)

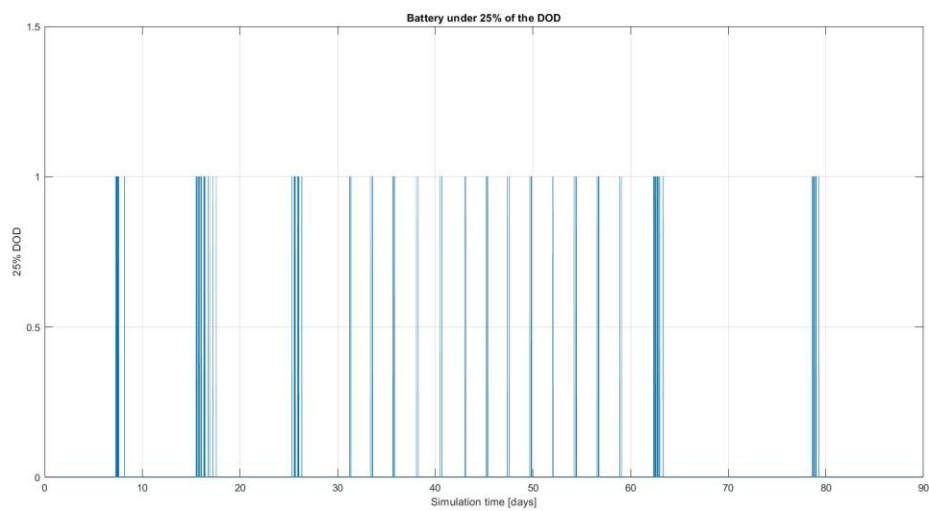


Fig. 2.57 Battery under 25% of the DOD (coming from over 25%)

Fig 2.55, Fig 2.56 and Fig 2.57 shows when the battery has gone under 25, 75 and 90 % of the battery charge. These data are used to compute the number of working cycles and then the days to battery death.

Table 2.15. Number of cycles for different DOD and remaining days to battery death

DOD %battery charge percentage	Work cycles done	Remaining days to battery death
DOD 90	37	3916
DOD 75	32	3937
DOD 25	88	715

The results obtained in Table 2.15. shows that the remaining days to battery death are 715. To do this approximation it has been taken into account the rate of charges and discharges, the number of cycles to battery death and the number of cycles done during the mission.

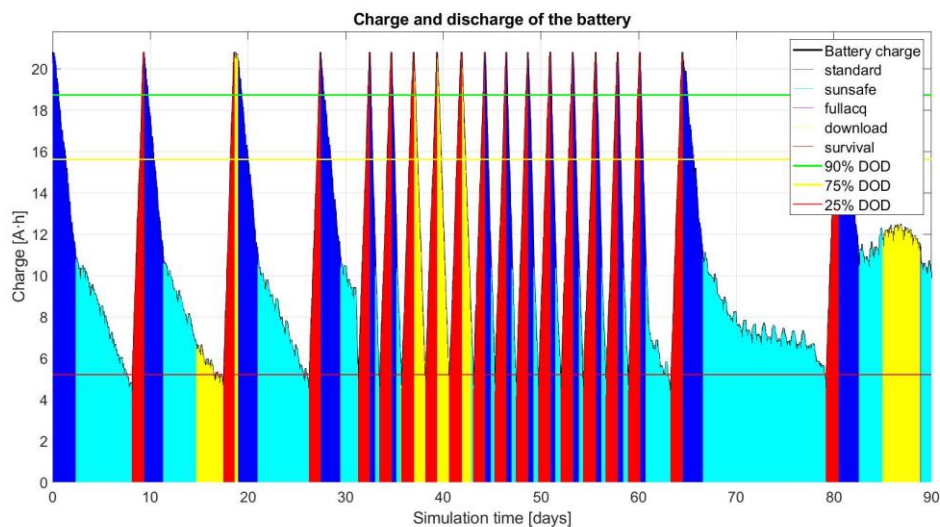


Fig. 2.58 charge and discharge of the battery

Fig. 2.58 shows the evolution of the battery charge. In colours are indicated the operating working mode. It can be appreciated that during the period of time where the precision “submode” is active (day 31 to 61), the consumption of battery increases a lot.

It is interesting how at the end of the simulation, between day 82 and 86, the sunsafe and download modes are capable of recover a small percentage of battery while in the rest of the simulation they could not. This is because during this phase of the mission, there are a lot of eclipse periods. See Fig. 2.X. So with a big time in eclipse, the sunsafe mode behaves more similar to the survival than the standard so it recovers energy.

It is appreciable that the satellite is capable of controlling each situation. The mode change capability avoids the collapse of the power and data budgets. A long mission like that, with a lot of complicated situations to manage is completely safe and the objective of the mission is reached too because a lot of captures have been done.

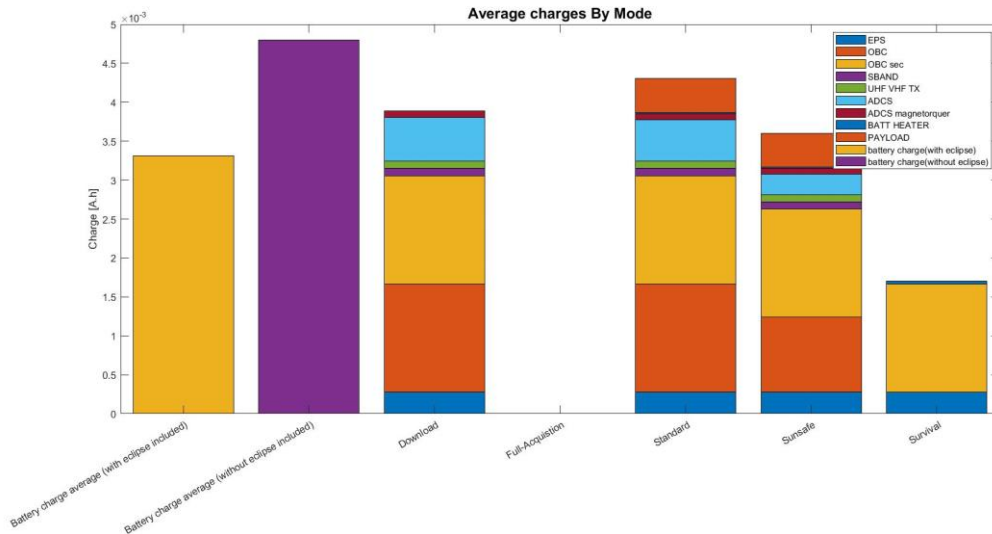


Fig. 2.59 Average subsystems consumptions by submodes

In Fig. 2.59 can be seen the average consumptions of the subsystems when they are operative divided by submodes. Furthermore, at the left part of the plot is indicated the average battery supply during the simulation. The comparison with this charge and the one each submode demonstrates why the battery charge goes up or down.

When the standard, download and sunsafe modes are operative, the battery charge supply is lower than the average consumption of the subsystems. In these situations the battery charge reduces. For this reason is needed the survival mode. For being able of recovering the full charge.

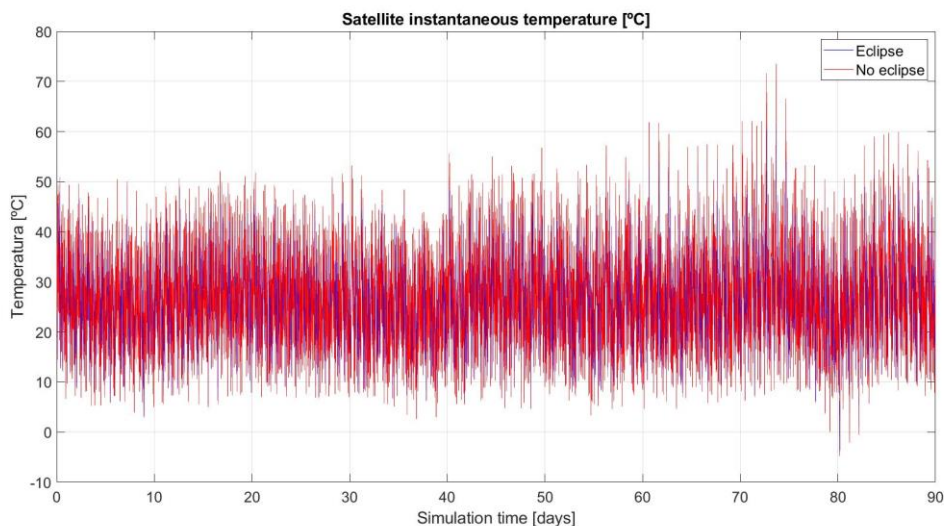


Fig. 2.60 Satellite instantaneous temperature

Fig. 2.60 shows the satellite temperature during the mission. It is difficult to see because of the length of the simulation, but with the colours can be seen when there is an eclipse and when not. The average temperature of the mission is 26.31 °C. It is a good average value. Anyway it would be useful to implement a refrigeration system because in some points the temperature is too high.

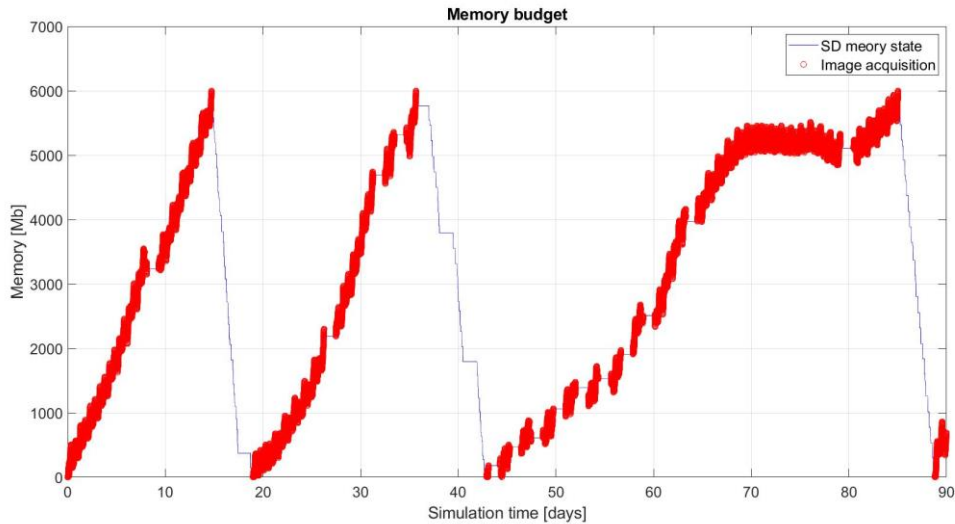


Fig. 2.61 Memory state

Fig. 2.61 presents the evolution of the memory state. It is easy to distinguish when the standard and sunsafe modes are operative: when there are captured images. The periods where the download mode is ruling is where the memory empties. The survival periods are the ones where there are neither image captures nor downloads.

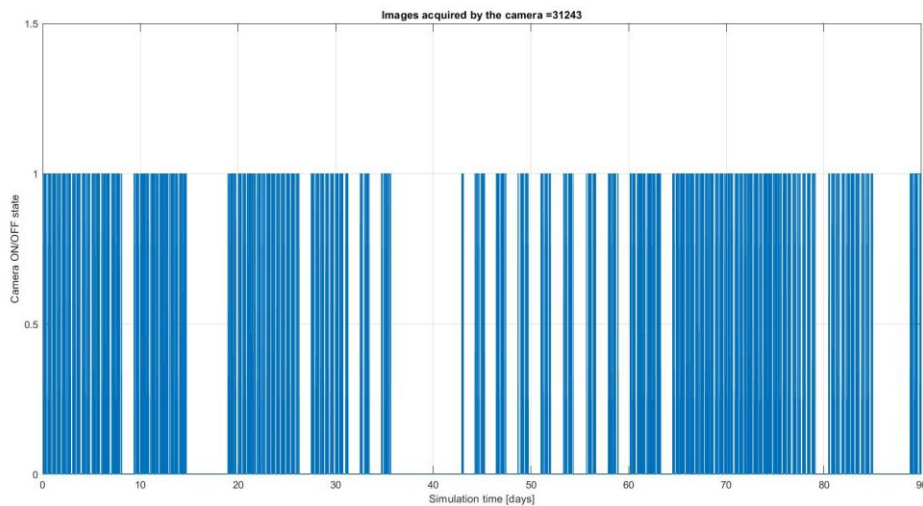


Fig. 2.62 photos

Fig. 2.62 represents when the different images are captured. The camera has done 31243 images.

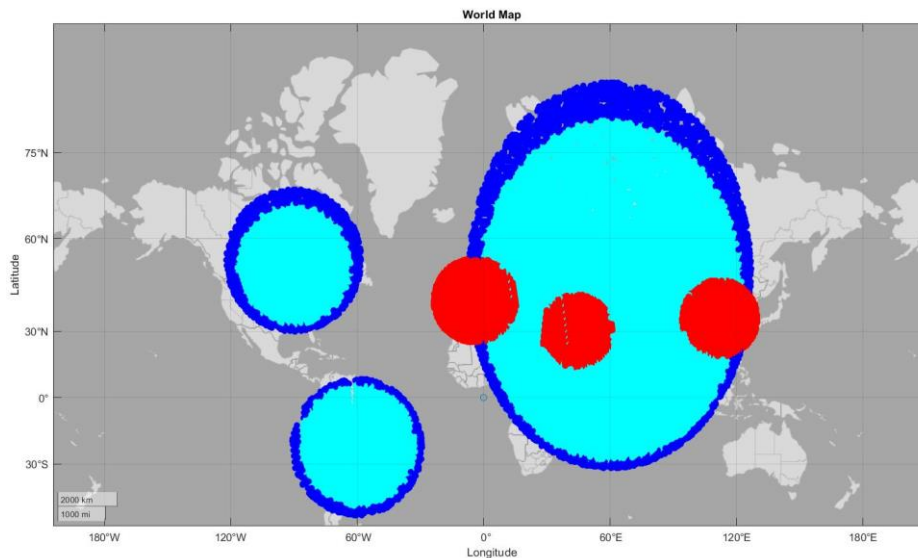


Fig. 2.63 Global cover

Finally, in Fig. 2.63 the position where an image has been captured is located in a world map (In cyan). When the photos are done using the reaction wheels, the position is located in the map in dark blue. Finally in red is the location where a download has been done.

In other simulations presented in this report, the full target area was not fully covered, and in this case it is. This happens because this simulation is longer. If the mission is too short, the area could be not photographed because every time the satellite want to make a photo it is in eclipse and the satellite cannot do photos at night. If the simulation is long, it is really difficult that always there is an eclipse in a specific zone of the target area.

2.7. Conclusions

Once the project is finished, it is time of take general conclusion of the work done. During the execution, in the different sections, it has been tried to put emphasis in the explanation of the results obtained.

One of the objectives of the TFG is explain the relation between the different topics presented. It is important to be aware of the connexions of the different results. Following this way to work, the conclusions of the project will be dependent between them.

About the methodology followed, it has helped the student to achieve the initial goal of the project: contributing in the development of professional software. The first theoretical research has helped understanding the main concepts of how the aerospace mission analysis is. Without them it would be impossible

have understood the original version of the simulator code. Furthermore at the time of simulate the improvements in the code, the theoretical research has helped to expect correct results. So it has helped a lot at the time of finding mistakes.

The contribution into the simulator has been successful. The original version of the code was designed for obtaining results without taking special care of the security of the mission. The new version is able of self-manage the different situation that could occur. It can manage a huge range of space mission without entering in collapse as it used to happen. The scheduler is able of managing the state of the satellite taking care of the different budgets.

The results obtained show that the improvements realised doesn't create problems greater. The introduction of the working modes, not only avoid the collapse of the system if the conditions are not favourable, it optimizes the mission benefits: number of photos, downloads, maintenance of the subsystems...What is true is that the key is giving the possibility of using various working modes in a single mission.

The decision of which working mode combination is the best one is strong dependent of several factors: the position and size of the target areas and ground stations, the duration of the mission, the features of the on-board equipment... So there is not a unique solution.

The precision "submode" introduction means a big impact in terms of power consumption. The simulator must enter into survival mode several times. Anyway, the software is prepared for managing the situation. This submode helps to see the resistance of the new scheduler logic.

The possibility of making photos without the necessity of pointing to a target area, in some cases, if the amount of photos is huge, force the simulator entering in download mode lots of times. This supposes also higher power consumption so the survival mode also must be used.

The scenario of download photos without being over a ground station is not a realistic situation. But it helps to arrive to one conclusion. In some parts of the orbit, if the simulation is not too long the satellite cannot take photos because every times it cross it is an eclipse. With the global coverage plot of the scenario that allows photo's download wherever the satellite can, it can be seen that some areas are only used for download. Without this plot could be thought that the satellite did not cross that area.

The overvoltage introduction has a big impact into the mission execution. If the overvoltage is big enough, the number of photos captured reduces a lot. It is really important to take care of the possible things that could happen. It is the only way of doing a realistic simulator.

Finally the paint selection is a really important decision. The selection must assure not using too much the active control thermal devices like the heater, but

also must not allow overheating the satellite. Again it depends a lot in the type of mission. Mixing different paints is a good solution in order to find equilibrium.

Finally it can be said that the simulator is already far from being perfect. There are different actions that can be done to improve it: the introduction of an algorithm that predict the better position for locating the ground stations, a better thermal keeping system : introducing more a refrigerator for example, a more accurate heat computations... to do all of this and other improvement, is really important continue working on it. This is a world constantly changing so we must be prepared for all the possible situations.

CHAPTER 3. REFERENCES

Books:

[1] (From Angrist, S. W. (1982) *Direct Energy Conversion*, 4th edn, Copyright Allyn and Bacon, New York)

[2] (From Fortescue, Peter, University of Southampton, UK, Swinerd, Graham, University of Southampton, UK, Stark, John, Queen Mary, University of London. UK (2011) *Spacecraft systems engineering*, 4th edn, Copyright Wiley, United Kingdom)

Webs:

[3] GOMspace(2019). *Gomspace*. Recovered 1june2019, from <https://gomspace.com/home.aspx>

[4] ISISspace(2019). *ISIS Innovative solutions in space*. Recovered 1june2019, from <https://www.isispace.nl/>