

Microbial community metabolic concurrence involved in toluene degradation

Effect of oxygen availability on catabolic gene expression
of aerobic and anaerobic toluene degrading bacteria

Dissertation
to obtain the academic grade
doctor rerum naturalium
(Dr. rer. nat.)

Presented to the Faculty of Biology-Pharmacy
Friedrich-Schiller University Jena

by
Paula Martínez Lavanchy

born on 21.03.1978 in Stockholm

Microbial community metabolic concurrence involved in toluene degradation

Effect of oxygen availability on catabolic gene expression
of aerobic and anaerobic toluene degrading bacteria

Dissertation
zur Erlangung des akademischen Grades
doctor rerum naturalium
(Dr. rer. nat.)

vorgelegt dem Rat der Biologisch-Pharmazeutischen Fakultät
der Friedrich-Schiller-Universität Jena

von

Paula Martínez Lavanchy

geboren am 21.03.1978 in Stockholm

Table of contents

ABBREVIATIONS	III
SUMMARY	V
ZUSAMMENFASSUNG	VII
1. INTRODUCTION	1
1.1. ENVIRONMENTAL POLLUTANTS: BTEX COMPOUNDS	1
1.2. REMEDIATION OF CONTAMINANTS: MICROBIAL DEGRADATION	3
1.3. DETECTION OF MICROBIAL ACTIVITY IN THE ENVIRONMENT	4
1.4. OXIC-ANOXIC GRADIENTS IN THE ENVIRONMENT	6
1.5. MICROBIAL TOLUENE DEGRADATION	9
1.5.1. <i>Toluene degradation by Pseudomonas putida mt-2</i>	9
1.5.2. <i>Toluene degradation by Thauera aromatica K172</i>	13
2. GOAL OF THE THESIS	18
3. MATERIALS AND METHODS	19
3.1. SOLUTIONS AND MEDIA	19
3.1.1. <i>P. putida agar plates media</i>	19
3.1.2. <i>Thauera aromatica K172-Medium (TAM media)</i>	20
3.2 BACTERIAL STRAINS AND GROWTH CONDITIONS	21
3.2.1. <i>Pseudomonas putida mt-2</i>	21
3.2.2. <i>Growth of P. putida mt-2 in Fermentor</i>	21
3.2.3. <i>Thauera aromatica K172</i>	23
3.3. ANALYTICAL METHODS	23
3.3.1. <i>Toluene</i>	23
3.3.2. <i>Dissolved Oxygen measurement</i>	24
3.3.3. <i>ATP</i>	25
3.3.4. <i>Nitrate and Nitrite concentrations</i>	27
3.4. MOLECULAR BIOLOGY METHODS	27
3.4.1. <i>Real Time PCR</i>	27
3.4.2. <i>RNA extraction</i>	29
3.4.3. <i>RNA quantification</i>	30
3.4.4. <i>cDNA synthesis</i>	31
3.4.5. <i>Primer optimisation</i>	31
3.4.6. <i>Real Time PCR reaction</i>	33
4. RESULTS	34
4.1. OPTIMISATION OF GROWTH CONDITIONS AND REAL TIME PCR	34
4.1.1. <i>Bacterial growth conditions</i>	34
4.1.2. <i>Primer selection and calibration curves</i>	36
4.2. CATABOLIC GENE EXPRESSION OF P. PUTIDA MT-2 AND T. AROMATICA K172 DURING TOLUENE DEGRADATION	38
4.2.1. <i>Gene expression of xylM and xylE during toluene degradation in aerobic conditions in batch cultures</i>	38
4.2.2. <i>Gene expression of xylM and xylE during a batch fermentation using toluene as carbon source</i>	42
4.2.3. <i>Gene expression of bssA and bcrA during toluene degradation in anaerobic conditions</i>	45

Table of contents

4.3. EFFECT OF OXYGEN AVAILABILITY ON CATABOLIC GENE EXPRESSION OF TOLUENE DEGRADING BACTERIA	50
4.3.1. <i>Pseudomonas putida mt-2</i>	50
4.3.2. <i>Thauera aromatica K172</i>	56
4.4. EFFECT ON CATABOLIC GENE EXPRESSION IN P. PUTIDA MT-2 DURING OXYGEN OSCILLATIONS	59
4.4.1. <i>Batch shaking cultures</i>	60
4.4.2. <i>Continuous Fermentation</i>	64
4.5. EFFECT OF OXYGEN FLUCTUATION ON CATABOLIC GENE EXPRESSION IN A MIXED CULTURE FORMED BY P. PUTIDA MT-2 AND T. AROMATICA K172	68
5. DISCUSSION	75
6. REFERENCES	86
ACKNOWLEDGEMENTS	96
DECLARATION OF INDEPENDENT WORK	98
CURRICULUM VITAE	99

Abbreviations

A	Adenine
ATP	Adenosine triphosphate
(ATP) _{St}	ATP concentration of the standard
bp	basepare(s)
BTEX	Benzene, Toluene, Ethylbenzene, Xylene
°C	degree Celsius
C	concentration
C _{ATP}	ATP concentration of the sample
cDNA	complementary desoxyribonucleic acid
C _t	threshold cycle
D.F.	dilution factor
DNA	desoxyribonucleic acid
dO ₂	dissolved oxygen
D.W.	dry weight
E	efficiency
ENA	enhanced natural attenuation
<i>et al.</i>	<i>et altera</i> (and others)
F	forward primer
Fig.	figure
g	gram
G	Guanine
GC-FID	gas chromatography with flame ionization detector
h	hour
I ₁	light intensity of the sample
I ₂	light intensity of the sample with internal ATP standard
kDa	kilo Dalton
L	litre
M	molar
mg	milligram
mL	millilitre
mM	millimolar
MNA	monitored natural attenuation

Abbreviations

mRNA	messenger ribonucleic acid
mV	millivolt
µg	microgram
µl	microlitre
µM	micromolar
NA	natural attenuation
ng	nanogram
nm	nanometer
OD ₅₆₀	optical density at wavelength 560 nm
PCR	polymerase chain reaction
pH	potentia hydrogenii
pO ₂	partial oxygen pressure
R	ratio relative gene expression
R	reverse primer
RNA	ribonucleic acid
rpm	rounds per minute
rRNA	ribosomal ribonucleic acid
RT	reverse transcription
s	second(s)
T	Thymine
TAM-Medium	<i>Thauera aromatica</i> K172 Medium
T _{ann}	annealing temperature
Taq	polymerase gained from <i>Thermus aquaticus</i>
T _m	melting temperature
UV/VIS	ultraviolet visible
w/v	weight per volume

Summary

Bacteria in the environment are constantly exposed to oxygen variations and gradients as they occur, e.g., in aquifers, in microbial mats and the plant root and the rhizosphere. Microorganisms living in polluted sites have the ability to process these input signals in order to develop adaptive responses to survive fluctuations of external conditions.

The relative expression of catabolic genes under oscillating oxygen conditions, from two toluene degrader bacteria capable of aerobic toluene degradation, *Pseudomonas putida* mt-2 (contains the TOL plasmid pWW0), and an anaerobic toluene degrader, *Thauera aromatica* K172, was studied. The catabolic genes targeted were *xylM* and *xylE* for *P. putida* and *bssA* and *bcrA* for *T. aromatica*.

The main results of this study can be summarised as follows:

1. Real-time PCR primer sets were developed in order to detect and quantify the catabolic genes *xylM*, *xylE*, *bssA* and *bcrA* in pure cultures, as well as in a binary mixed culture of *Pseudomonas putida* mt-2 and *Thauera aromatica* K172.
2. A decrease in the expression level of *xylM* and *xylE* was observed under oxygen limiting conditions when *Pseudomonas putida* mt-2 was grown on toluene as carbon source. Thus, oxygen is needed as a kind of co-inducer for the expression of the catabolic genes of the TOL plasmid.
3. The addition of oxygen to *Thauera aromatica* K172 cultures grown with toluene as the carbon source immediately halted toluene degradation, bacterial growth and denitrification processes. A repression of *bssA* and *bcrA* expression was observed in the presence of oxygen.
4. *Pseudomonas putida* mt-2 is able to modulate the expression of *xylM* and *xylE* according to the oxygen availability in the media. During anoxic periods these bacteria decrease the growth rate and the expression of catabolic genes to a level which allow them to recover the activity when oxygen is present again in the medium.

5. In mixed binary cultures of *P. putida* and *T. aromatica*, submitted to anoxic/oxic cycles, a regulation of catabolic genes depending on the presence of oxygen was observed. After two oxic cycles *T. aromatica* showed an up-regulation of catabolic genes once oxygen was depleted by *P. putida*.

This thesis showed that catabolic gene expression of *T. aromatica* and *P. putida* is affected by the presence or lack of oxygen. Moreover, both aerobic and anaerobic bacteria are able to modulate the expression of catabolic genes depending on the oxygen availability. This fact allows them to react quickly with respect to catabolic gene expression, once the favourable growth conditions are restored regarding oxygen concentration. Additionally, bacteria showed stability and physiological fitness under unfavourable conditions regarding oxygen availability. All these findings give the possibility to think about new approaches for bioremediation, exploiting the idea of cyclic aerobic-anoxic conditions to bioengineer polluted sites in order to accelerate biodegradation processes.

Zusammenfassung

Bakterien sind in ihrer natürlichen Umgebung permanent mit variierenden Sauerstoffgradienten, wie sie z.B. in Grundwasserleitern, mikrobiellen Matten und im Wurzelraum von Pflanzen, der Rhizosphäre, existieren, konfrontiert. Schadstoff-abbauende Mikroorganismen haben zudem die Fähigkeiten entwickelt, sich mit Hilfe adaptiver Mechanismen und der Regulation ihrer katabolen Gene an die sich permanent ändernden Umweltbedingungen kontaminierter Standorte anzupassen.

In dieser Arbeit wurde die relative Expression kataboler Gene unter oszillierenden Sauerstoffkonzentrationen von zwei Schadstoff-abbauenden Bakterien, dem aeroben Toluol-Abbauer, *Pseudomonas putida* mt-2 (der das TOL Plasmid pWW0 enthält), und dem anaeroben Toluol-Abbauer, *Thauera aromatica* K172 untersucht. Die katabolen Gene waren dabei *xylM* und *xylE* für *P. putida*, sowie *bssA* und *bcrA* für *T. aromatica*.

Die innerhalb der Arbeit erzielten Ergebnisse lassen sich wie folgt zusammenfassen:

1. Real-time PCR Primer wurden entwickelt, um die katabolen Gene *xylM*, *xylE*, *bssA* und *bcrA* in Reinkulturen, sowie in Mischkulturen von *Pseudomonas putida* mt-2 und *Thauera aromatica* K172 zu detektieren und zu quantifizieren.
2. Unter Sauerstoff-limitierenden Bedingungen wurde ein Rückgang der Expression von *xylM* und *xylE* beobachtet, wenn *Pseudomonas putida* mt-2 mit Toluol als einziger Kohlenstoffquelle kultiviert wurde. Sauerstoff ist somit als eine Art Co-Inducer für die Expression der katabolen Gene des TOL Plasmids erforderlich.
3. Die Zugabe von Sauerstoff zu anaerob kultivierten Zellen von *Thauera aromatica* K172 führte zu einer unmittelbaren Hemmung des Toluolabbaus und der Denitrifikation, verbunden mit einer Repression der Genexpression von *bssA* und *bcrA* durch Sauerstoff.
4. *Pseudomonas putida* mt-2 ist in der Lage, die Expression von *xylM* und *xylE* an die Verfügbarkeit von Sauerstoff im Medium anzupassen. Unter anoxischen Bedingungen vermindern die Bakterien ihr Wachstum und ihre katabole Genexpression auf ein Niveau, das es ihnen erlaubt, sofort nach

erneuter Zugabe von Sauerstoff wieder aktiv zu werden und Toluol abzubauen.

5. In Mischkulturen von *P. putida* und *T. aromatica*, die anoxischen/oxischen Zyklen ausgesetzt wurden, konnte bei beiden Bakterien eine Regulation der katabolen Gene in Abhängigkeit von der Anwesenheit von Sauerstoff beobachtet werden. So zeigte *T. aromatica* sogar nach zwei oxischen Perioden eine Expression seiner katabolen Gene, sobald der Sauerstoff vollständig durch die Aktivität von *P. putida* verbraucht war.

Die Ergebnisse dieser Arbeit zeigen, dass die Expression kataboler Gene von *T. aromatica* und *P. putida* direkt von der Ab- bzw. Anwesenheit von Sauerstoff abhängig sind. Zudem konnte gezeigt werden, dass sowohl die aeroben als auch die anaeroben Bakterien in der Lage sind, ihre Genexpression sehr schnell an die Verfügbarkeit von Sauerstoff anzupassen. Diese Fähigkeit erlaubt es ihnen kurzfristig auf variierende Sauerstoffkonzentrationen zu reagieren. Darüber hinaus erwiesen sich beide Bakterien als äußerst stabil und physiologisch flexibel, um unvorteilhafte Bedingungen in Bezug auf die Sauerstoffverfügbarkeit zu überleben. Mithilfe dieser Kenntnisse können basierend auf einem gezielten Wechsel von oxischen und anoxischen Umweltbedingungen innovative Methoden zur Optimierung natürlicher Abbaupotenziale für die Sanierung kontaminierter Standorte entwickelt werden.

1. INTRODUCTION

1.1. Environmental pollutants: BTEX compounds

Accelerated industrialization combined with poor management practices has caused widespread contamination of the environment (air, soil, water). Contaminants may accumulate, disrupt soil functions and pollute ground and surface waters, thus threatening drinking water supplies and aquatic ecosystems. According to the European environment agency the main soil contaminants in Europe are hydrocarbons (Fig. 1) (EEA, 2005).

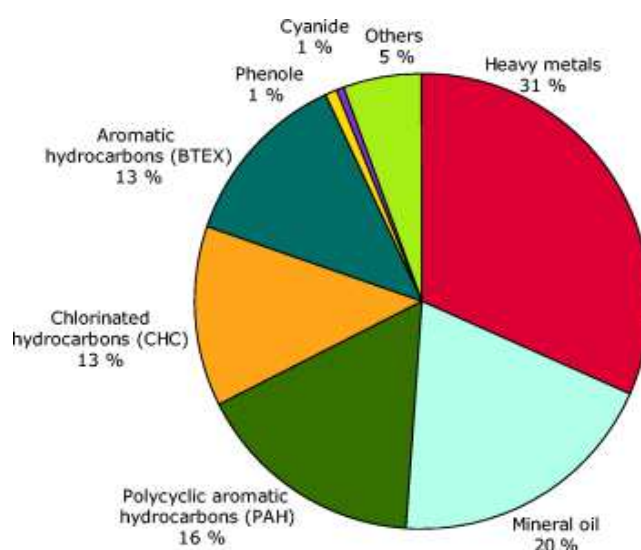

Figure 1. Main contaminants at industrial and commercial sites affecting soil in Europe as % of total. Countries included in the study: Italy, Czech Rep. Austria, Sweden, Netherlands, Belgium-Flanders. Source: European environment agency (2005).

Hydrocarbons are a family of compounds, which include aliphatic and alicyclic alkanes, alkenes, alkynes and mono- and polycyclic aromatic hydrocarbons. The final group, polycyclic aromatic hydrocarbons, include several low-molecular mass aromatic compounds produced in nature e.g. aromatic amino acids (tryptophan, phenylalanine and tyrosine), quinones, flavonoids, phenolic compounds, tannins and lignin (Heider and Fuchs, 1997). However, this group also includes chemically synthesized monoaromatic hydrocarbons, which have been extensively used in industry as a primary energy source.

As a result of their extensive and intensive use, aromatic hydrocarbons have become one of the most common environmental pollutants present in terrestrial and aqueous environments.

Benzene, Toluene, Ethylbenzene and the three isomers of Xylene (Fig. 2), commonly known as BTEX compounds, are normally found in gasoline and they are high volatile substances (Coates et al., 2002). BTEX compounds are water-soluble aromatic hydrocarbons, e.g. the water solubility of benzene, toluene, ethyl benzene and m-xylene at 20°C is 1780, 515, 152, and 200 mg/L, respectively (Van Agteren et al., 1998). For this reason are highly mobile in the environment. These chemicals are used primarily as solvents, or as starting materials in the synthesis of chemicals and drugs. These substituted aromatics are economically important in the chemical, petroleum, pharmaceutical, polymer, paint and dye industries. The large quantities of BTEX compounds produced, stored and used until these days exhibits both high health risks to human and the environment (Low et al., 1988).

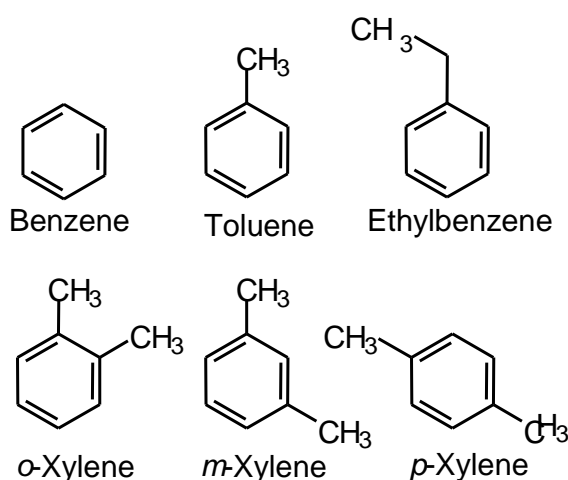

Figure 2. Chemical structure of BTEX compounds group.

Especially benzene and toluene enter the environment through aqueous discharge of industrial effluents (from e.g. metal, paint, textile industries) and processes associated with gasoline and petroleum fuels (Chakraborty and Coates, 2004). Additionally, toluene is released into the atmosphere principally from the volatilization of petroleum fuels, toluene-based solvents and thinners, and from motor vehicle exhaust (US-EPA, 1994). As

consequence of its widespread use and subsequent introduction into the environment, toluene is considered to be a priority pollutant.

1.2. Remediation of contaminants: Microbial degradation

Since the elimination of contaminants is necessary to the continued sustainable development of our society, remediation of contaminated sources has received special attention in recent decades, and different methods have been developed for the removal of pollutants. Treatment of contaminated sites can be classified as biological, physical or chemical, and usually a combination of these treatments results in a more effective overall strategy (Scullion, 2006).

One of the most important processes for the removal of pollutants is biodegradation. Microorganisms, soil invertebrates and plants have been suggested as possible agents for biological remediation, although most applications have focused on microbial degradation (Lovley, 2003). Microbial degradation of aromatic pollutants is essential in detoxification of wastewater and contaminated soils. Additionally, this process contributes to the global carbon cycle. Therefore, different remediation methods have been studied, developed and applied based on bacterial degradation capacities. Natural attenuation (NA) is one of the cost effective methods that has been used to remediate soils and groundwater contaminated with different kind of pollutants (Baun et al., 2003; Schirmer et al., 2006). This is a form of remediation that relies on the natural occurring biodegradation processes together with chemical and physical processes that proceed without human intervention (Scow and Hicks, 2005; Da Silva and Alvarez, 2007). However, removal of pollutants by NA is normally a slow process and therefore, more active bioremediation methods are often favoured (Dua et al., 2002). Enhanced natural attenuation (ENA) and monitored natural attenuation (MNA) are more active methods than NA. ENA differs from MNA, in the sense that environmental conditions are insofar optimised in such a way that microorganisms can oxidize, bind, immobilize, volatilize, or otherwise transform contaminants (Hunkeler et al., 2002; Lovley, 2003; Cavalca et al., 2004; El Fantroussi and Agathos, 2005; Thompson et al., 2005).

Effective bioremediation of BTEX under (natural) aerobic conditions is already established in various systems, at some sites even under relatively low oxygen concentrations (Morgan et al., 1993; Olsen et al., 1995; Schirmer et al., 2003). However, microbial respiration and the accompanying biological processes during aerobic biodegradation cause a decrease in dissolved oxygen concentration in contaminated sites (Olsen et al., 1995). Nevertheless, microorganisms are able to use different strategies for complete degradation of aromatic compounds, depending on the availability of oxygen. Several aerobic and anaerobic microorganisms able to degrade aromatic hydrocarbons have been described (Evans et al., 1991; Anders et al., 1995; Rabus and Widdel, 1995; Beller et al., 1996; Camara et al., 2007). Moreover, aerobic and anaerobic pathways for aromatic compounds degradation and the respectively enzymatic reactions have been extensively studied (Heider and Fuchs, 1997; Chakraborty and Coates, 2004; McLeod and Eltis, 2008; Parales et al., 2008).

Microbial activity is highly site-specific because environmental conditions, concentration of microbial population, concentrations of nutrients, and contaminants differ for each site. Hence, bioremediation strategies should be designed based on knowledge of the microbial population present in the field, their degradation capabilities and their response to different environmental conditions (Díaz, 2004). However, still a lot of information is missing and field studies should be complemented by microcosms or pure culture studies in the laboratories (Lovley, 2003). This makes the use of microorganisms in bioremediation an empirical-based technique and restricts the possibilities of its implementation.

1.3. Detection of microbial activity in the environment

Together with laboratory studies, recent developments of molecular methods, stable isotope techniques and modelling systems are providing some insights in how to monitor biodegradation in the environment (Widada et al., 2002; Scow and Hicks, 2005). However, to date it is estimated that only 1% of environmental microbes have been identified and cultivated (Amann et al., 1995). This is mainly due to the limited capacity of researchers to set up the right conditions to cultivate many environmental organisms in the lab. There has been a continuous development of several molecular methods (culture-

independent methods) targeting specific microbial macromolecules e.g. fatty acids, proteins and nucleic acids in order to gain information about the variety, distribution, and gene regulation of microorganisms involved for example in the process of pollutant biodegradation (Kerkhof and Häggblom, 2008). The use of techniques like denaturing gradient gel electrophoresis (DGGE) (Muyzer and Smalla, 1998), terminal restriction fragment length polymorphism (T-RFLP) or single strand conformation polymorphism (SSCP) (Schwieger and Tebbe, 1998) together with more recent developed techniques such as fluorescence *in situ* hybridization (FISH) (Amann et al., 2001) and stable isotope probing (SIP) (Neufeld et al., 2007) may lead to obtain extended knowledge on the composition and structure of bacterial communities and to the exact determination of organisms that assimilate specific contaminants.

Measurement of distinctive metabolites or stable carbon isotope ratios of residual contaminants can be used to monitor bioremediation of contaminated soils/groundwater and to estimate the efficiency of a specific bioremediation strategy. Recently, the demonstration that the indigenous microbial communities are capable of degrading the contaminants and, that these communities are abundant in the contaminated field has been taken as an alternative method of proof (Pelz et al., 2001; Nijenhuis et al., 2007). Additionally, molecular techniques focussing on catabolic genes that code for specific pollutant degrading enzymes have become a relevant approach to detect and quantify specific degrading microbial communities (Beller et al., 2002; Junca and Pieper, 2004; Hosoda et al., 2005).

The necessity of describing microbial activity has made the use and development of RNA-based techniques an important issue. Both rRNA and mRNA concentrations have been used to correlate bacteria with their *in situ* activity. In particular mRNA concentration is representative for genes that are actively transcribed. Therefore, it is useful in order to monitor the activity of a functional group of microorganisms responsible for a certain process (Kerkhof and Häggblom, 2008). However, detecting and quantifying mRNA is difficult because of its low concentrations and short half-life (Widada et al., 2002). To study gene expression, DNA microarrays and reverse transcription (RT) Real Time PCR have been the most common molecular tools. DNA microarrays can be used for phylogenetic analysis, catabolic gene studies or even community genome arrays (Saleh-Lakhaa et al., 2005; Andreoni and Gianfreda, 2007).

Reverse transcription followed by PCR (RT-PCR) analysis is considered the most sensitive method to detect low abundance mRNA. Real time PCR is based on the processes like a conventional PCR. However, the introduction of fluorescent technology makes it possible to detect and quantify the PCR product during the reaction progress. Some studies for the detection and quantification of catabolic genes in environmental samples have been performed (Widada et al., 2001; Beller, 2002; Hosoda et al., 2005; Cebron et al., 2008).

Numerous environmental factors can activate or repress gene expression and thus modulate microbial activity. The soil, for example, is a very complex environment where conditions such as nutrient concentrations, temperature, water content, pH and oxygen status are constantly varying (Saleh-Lakhaa et al., 2005). Bacteria in soil like environments normally receive a wide range of signals, more than the presence or absence of a substrate, that determine the expression of catabolic pathways and a whole set of enzymes in accordance to the physiological and metabolic status of the cell (Cases and de Lorenzo, 2005). As it was previously stated, an environmental factor that soil microbes must cope with is fluctuating oxygen concentrations. Some studies have monitored the effect of fluctuating oxygen concentrations on gene expression involved in denitrification processes (Baumann et al., 1996). However, there is a lack of knowledge on the effects of oxygen levels on gene expression within soil environments conditions (Saleh-Lakhaa et al., 2005).

1.4. Oxic-anoxic gradients in the environment

In the environment, consumption of resources and formation of metabolic products by spatially separated microbial populations are the driving forces for the formation of gradients. Thus, the biosphere is normally not physicochemically homogenous. In gradients where nutrients are the limiting factor, the microbial activity tends to decrease or cease, whereas limited energy substrates, like oxygen, forces organisms to change their metabolisms or even produces a shift in the community structure. Molecular oxygen is an important reactant in biogeochemical cycles. The solubility of oxygen in water is quite low (10 mg L^{-1} at 15°C) (Wilson and Bouwer, 1997) and this amount is rapidly depleted in areas with high catabolic activity

forming gradients. These oxygen gradients are found at different scales in nature from oceanic environments to the guts of some insects (Brune et al., 2000).

Oxygen gradients can be also formed due to seasonal changes or daytime variation. One example is the formation of oxygen gradients in microbial mats, where the oxygen concentration increases during the day due to photosynthetic activity of cyanobacteria (Grotzschel et al., 2004). Another common example of oxygen gradients is the plant root and the surrounding rhizosphere. Plant roots form a complicated three-dimensional structure within the soil, which helps to fix the plant into the soil matrix and additionally helps the plant acquire essential nutrients. Furthermore, the plant roots exudes several sugars, organic acids, and amino acids that enhance microbial activity in the rhizosphere (Kuiper et al., 2004). Initially, the rhizosphere was defined as the zone of soil immediately adjacent to legume roots, that supports high levels of bacterial activity (Hiltner, 1904). Currently, several definitions of the rhizosphere exist and it has been divided in different zones (Morgan et al., 2005). Oxygen released by the roots of helophytes play an important role in the supply of oxygen to the microorganisms in the rhizosphere (Wießner et al., 2005). Helophytes have developed aeration systems, which allow them to survive in water-saturated soils e.g. wetlands or swamps. These plants develop a porous tissue called aerenchyma, which connects the roots with the emerging parts of the plants allowing the transport of atmospheric oxygen to the plant roots (Drew et al., 2000). The degree of oxygenation depends on different factors, such as the plant species or variety, the reducing power of the soil or sediment, the soil temperature, and also the stages of root development (Brune et al., 2000). A short-term dynamic of the redox potential following the day/night changes in the rhizosphere was observed in a laboratory planted fixed bed reactor treating artificial wastewater using *Juncus effusus* as model plant (Fig. 3) (Wießner et al., 2005). The redox potential fluctuated from -200 mV during the night to oxidised conditions of $+200$ mV during the day (Fig. 3). In addition, variations in pH were observed, which are dependent on the dynamics of organic and inorganic substances caused by light and redox (Wießner et al., 2005).

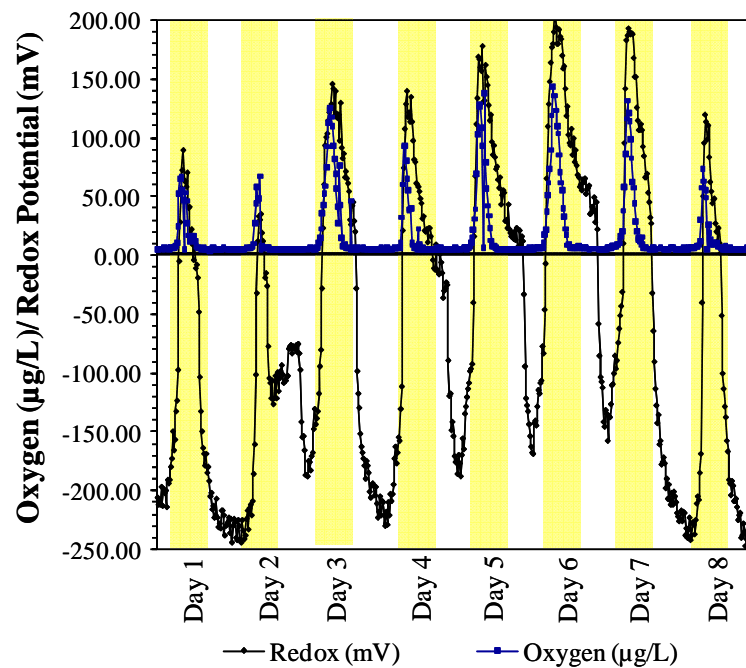

Figure 3. Change in redox condition and oxygen concentration during day/night cycles in a special designed lab-scale reactor for the treatment of artificial wastewater. The bed-reactor was planted with sword-grass (*Juncus effusus*). Source: Modified from Wiessner *et al.*, 2005.

The presence of gradients in the environment forces microbes to develop adaptive responses to survive fluctuations of external conditions, e.g. the relative position of oxic-anoxic boundary. One example of adaptive response is energy taxis, which allows motile microorganisms to rapidly respond to changes in various physico-chemical gradients by directing their motility to more favourable surroundings (Taylor *et al.*, 1999). Furthermore, many oxygen-tolerant anaerobes are well adapted to survive oxygen stress. Even sulphate-reducing bacteria, which were expected to be restricted to anoxic zones, are present in the upper-oxic layer in marine sediments (Sahm *et al.*, 1999). An important field of research in environmental microbiology is therefore the investigation of the effect of temporal oscillations of oxygen on microbial activity and interactions. Due to the high complexity of microbial physiology that allow bacteria to respond and adapt to fluctuations in environmental conditions the use of pure culture experiments to investigate degradation processes in the environment is absolutely necessary (Brune *et al.*, 2000). Here, gene expression studies could help to identify and understand the environmental conditions that influence the growth of microorganisms and their ability to express activities under *in situ* conditions.

1.5. Microbial toluene degradation

As mentioned in section 1.1 above, the BTEX compounds represent a large fraction of the aromatic hydrocarbons in gasoline. Together with the effect on human health, they represent a serious threat to drinking water supplies. For this reason the fate of toluene in the environment, and the contribution of microbial degradation to its removal has been extensively studied (for a review see Parales *et al.*, 2008). Bacteria (aerobic and anaerobic) and fungi have developed different pathways to cope with the mineralization of toluene. One of the most studied aerobic catabolic pathways corresponds to the one encoded by the so called TOL plasmid (pWW0) of *Pseudomonas putida* mt-2 (Williams and Murray, 1974), whereas toluene degradation by *Thauera aromatica* K172 has been the most well studied anaerobic pathway. In this work, these two microorganisms were selected as model bacteria to study the effect of availability and variations of oxygen on catabolic gene expression. A description of the mechanisms and regulation of toluene degradation in both bacteria is described in the next two sections.

1.5.1. Toluene degradation by *Pseudomonas putida* mt-2

Pseudomonas putida mt-2, formerly named as *Pseudomonas putida* (*arvilla*) was originally isolated from a cultivated soil growing on *o*-, *m*-, and *p*-toluate (Nozaki *et al.*, 1963). It corresponds to a Gram-negative bacterium from the *gamma* subclass of *Proteobacteria*. Early studies demonstrated that this bacterium harbours a plasmid, which encodes for the necessary enzymes for toluene degradation, the so called TOL plasmid or pWW0 (Williams and Murray, 1974). pWW0 (117-kb) is a broad-host-range plasmid belonging to the IncP-9 incompatibility group that can be transferred at low frequency to other Gram-negative microorganisms besides pseudomonads (Ramos *et al.*, 1997). The necessary genes for the catabolic pathway and regulation are encoded in approximately 40kb. The genes for toluene degradation on pWW0 are organised into two operons (Fig. 4), the upper pathway operon *xyIUWCMABN*, which encodes the genes for the conversion of toluene to benzoate and the lower pathway operon, *xyWXYZLTEGFJQKIH*, for conversion of benzoate to TCA cycle intermediates (Fig. 5) (Assinder and Williams, 1990; Ramos *et al.*, 1997).

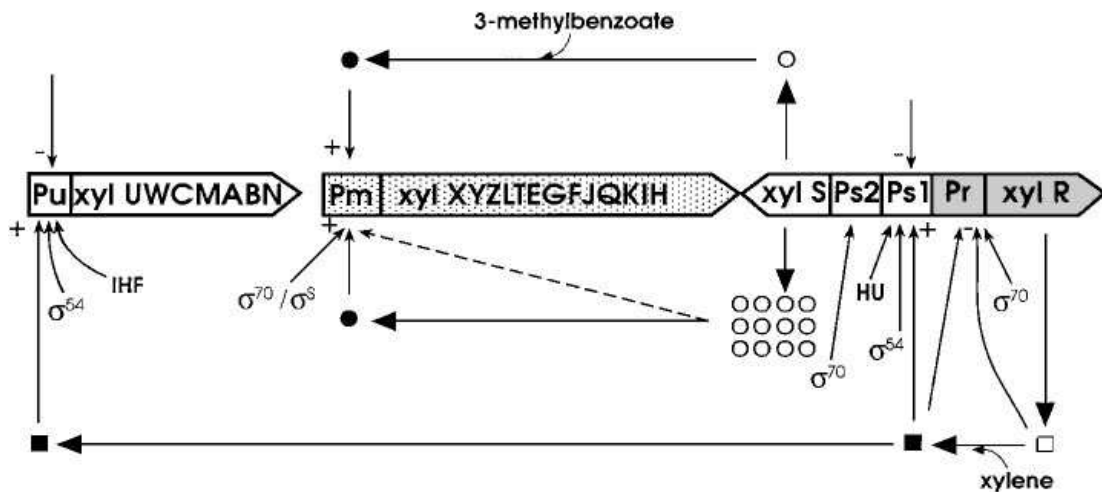

Figure 4. Operon structure and Regulatory circuits controlling expression from the TOL plasmid pWW0. Squares: XylR; circles: XylS; open symbols: transcription regulator forms unable to stimulate transcription; closed symbols: forms able to stimulate transcription; +: stimulation of transcription; -: inhibition of transcription. Source: Ramos *et al.*, 1997.

Due to its chemical stability, the initial activation of the benzene ring in the toluene pathway is a crucial step. In the first steps of aerobic degradation oxygen is used directly as a substrate, destabilising the aromatic ring and preparing the molecule for further metabolism (Fig. 5). The first enzyme in the TOL plasmid is xylene monooxygenase (XylMA), which has a substrate range that includes 1,2,4-trimethylbenzene, 3-ethyltoluene, toluene, and *m*- and *p*-xylene, which all serve as growth substrates for *P. putida* mt-2 (Kunz and Chapman, 1981). Xylene monooxygenase is a two-component enzyme consisting of XylM, a membrane-bound catalytic component with ferrous iron at the active site, and XylA, a NADH ferredoxin reductase (Suzuki *et al.*, 1991; Shaw and Harayama, 1992). Further, toluene degradation results in the first main intermediate of the pathway, benzoate, which is taken by the enzyme toluate dioxygenase (XylXYZ) and transformed to the corresponding aldehyde, which is further transformed to catechol (Fig. 5). Catechol is one of the main intermediates of several aerobic peripheral aromatic pathways. In the case of *P. putida* mt-2 catechol is degraded via the “*meta*-cleavage pathway” (Parales *et al.*, 2008). The *xylE* gene in the TOL plasmid encodes for the catechol-2,3-dioxygenase (C23O), which catalyzes the cleavage of the catechol ring to yield 2-hydroxymuconic semialdehyde (Fig. 5).

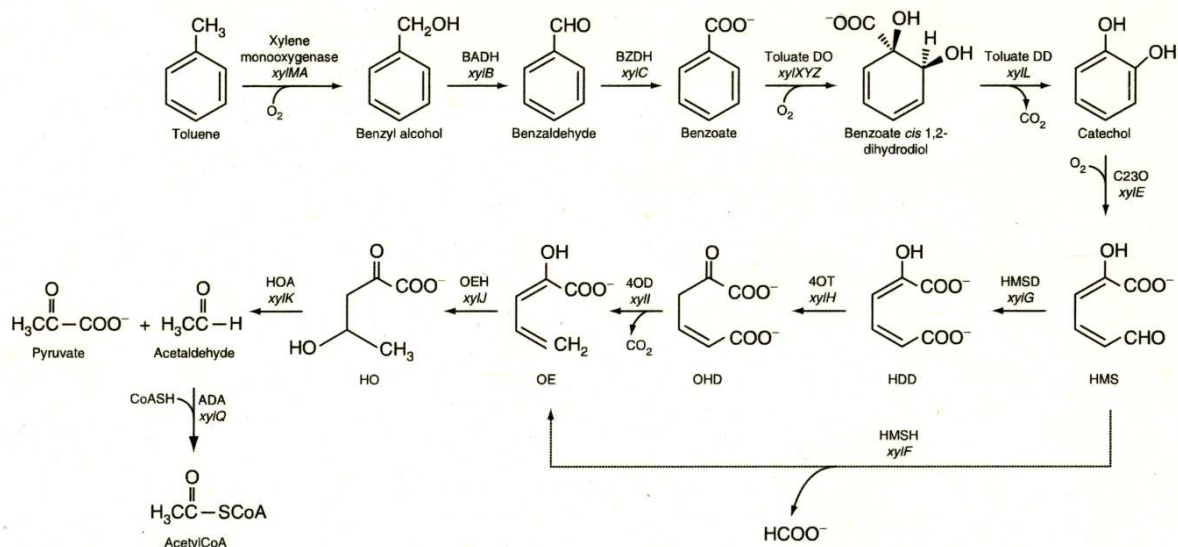

Figure 5. TOL pathway in *P. putida* mt-2. Intermediates: HMS, 2-hydroxymuconic semialdehyde; HDD, 2-hydroxyhexa-2,4-diene-1,6-dioate; OHD, 2-oxohex-4-ene-1,6-dioate; OE, 2-oxopent-4-enoate; HO, 4-hydroxy-2-oxovalerate. **Enzymes:** BADH, benzylalcohol dehydrogenase; BZDH, benzaldehyde dehydrogenase; Toluate DO, toluate dioxygenase; Toluate DD, toluate cis-dihydrodiol dehydrogenase; C23O, catechol 2,3-dioxygenase; HMSH (HODH), 2-hydroxymuconic semialdehyde hydrolase; HMSD, 2-hydroxymuconic semialdehyde dehydrogenase; 4OT, 4-oxalocrotonate tautomerase; 4OD, 4-oxalocrotonate decarboxylase; OEH (HPDH), 2-oxopent-4-enoate hydratase; HOA, 4-hydroxy-2-oxovalerate aldolase; ADA, acetaldehyde dehydrogenase (acylating). **Source:** Parales *et al.*, 2008.

The XylE enzyme is a homotetramer of 35 kDa subunits (Nakai *et al.*, 1983) and is only active when molecular iron is present (Burlage *et al.*, 1989). Its substrate range includes catechol as well as 3- and 4-methylcatechol (Nozaki *et al.*, 1970). After the ring cleavage, the *meta*-pathway is divided in two branches that allow a wider range of substrates (Fig. 5). The cleavage products coming from 3-substituted catechols go through the branch encoded by XylF (2-hydroxymuconic semialdehyde hydrolase), whereas catechol and 4-methylcatechol are mainly metabolised through the 4-oxalocrotonate branch (*xylGHI*) (Harayama *et al.*, 1987). *Pseudomonas putida* mt-2 also has a chromosomally-encoded catechol 1,2-dioxygenase (C12O) for the transformation of catechol via the *ortho*-pathway. C12O is inducible by *cis,cis*-muconate (a product of benzoate degradation), whereas the plasmid-encoded C23O is inducible by benzoate itself, which is an intermediate in toluene metabolism. It has been observed that *P. putida*

mt-2 utilizes preferentially the *meta*-cleavage pathway during toluene degradation (Assinder and Williams, 1990).

Two main putative proteins regulate the gene transcription of the TOL plasmid, XylS and XylR, which activate the promoter of the *meta*-operon (Pm) and the upper-operon (Pu), respectively (Fig. 4). The XylR protein (67-kDa) has significant homology with the NtrC family of transcriptional regulators (Inouye et al., 1985, 1988) and the XylS (36-kDa) is homologous to the AraC family of DNA-binding proteins (Spooner et al., 1987; Ramos et al., 1990). The genes encoding these regulators, *xylS* and *xylR*, are located at the 3' end of the *meta*-operon and are transcribed from physically similar, but functionally different promoters. *xylS* starts to be transcribed from its own promoter Ps (two overlapped sequences Ps1 and Ps2) in the opposite direction of the *meta*-pathway, whereas *xylR* starts to be transcribed from Pr (which is recognised by σ^{70}) in the same direction of the *meta*-pathway (Fig. 4).

The *xylR* gene is constitutively expressed from its promoter in the absence of inducers (Inouye et al., 1985). When effectors are not present, XylR binds in its inactive form to target DNA. However, XylR becomes active in response to the upper pathway substrates toluene, *m*- and *p*-xylene and their respective alcohols (Worsey et al., 1978; Abril et al., 1989). Together with σ^{54} -containing RNA polymerase and the DNA-bending protein integration host factor (IHF) XylR induces the transcription from the upper pathway operon Pu promoter (Ramos et al., 1997) (Fig. 4).

xylS transcripts were found to initiate from two different promoters, Ps1 and Ps2. The expression from Ps1 promoter was induced in the presence of XylR and *m*-xylene or *m*-cresol (Inouye et al., 1987; Marqués et al., 1994; Gallegos et al., 1996). While the expression from Ps2 promoter (a σ^{70} -type promoter) was at a low constitutive level. The expression from Ps2 produces an inactive form of XylS. Transformation to the activated form of XylS occurs through the presence of *meta*-cleavage substrate (Marqués et al., 1994) and after binding with σ^{70} or σ^S , the transcription from Pm promoter starts. One study suggested that Pm is transcribed either by a σ^{70} - or σ^S RNA polymerase depending on the growth phase of the bacteria. In the early exponential phase σ^{70} mediates transcription of *xylS*, but later σ^S acts as a mediator (Marqués et al., 1994).

The XylR protein is considered the master regulator of the TOL pathway because its active form it is also able to stimulate the expression of *xylS* from the Ps1 promoter without affecting the constitutive expression from the Ps2 promoter. Thus, XylR is able to induce the upper and lower pathway in the presence of an effector (Fig. 4). When *xylS* is transcribed from the two promoters (Ps1 and Ps2), equilibrium between the active/inactive forms of XylS induces the expression of the *meta*-pathway even in the absence of an effector. This coordination of induction of the *upper* and the *meta*-cleavage pathways results in an efficient degradation of the aromatic hydrocarbon substrate without accumulation of intermediates (Ramos et al., 1997).

1.5.2. Toluene degradation by *Thauera aromatica* K172

Only in the middle of the 80's degradation of toluene and benzene under anaerobic conditions was conclusively demonstrated (Vogel and Grbic-Galic, 1986; Grbic-Galic and Vogel, 1987). Since then, several bacteria have been identified which have the potential to degrade BTEX compounds anaerobically (Beller et al., 1996; Jahn et al., 2005). One of the most characterised anaerobic toluene degraders is *Thauera aromatica* K172 (Anders et al., 1995). This bacterium was isolated from phenol-grown cultures under denitrifying conditions and it was described as a facultative anaerobic denitrifying bacteria belonging to *Pseudomonas* sp. (Tschech and Fuchs, 1987). Later, the growth of this bacterium on toluene as carbon source and denitrifying conditions was described together with the identification of benzoyl-CoA as metabolite of toluene degradation (Fig. 6) (Altenschmidt and Fuchs, 1992). In 1995, this bacterium was taxonomically re-classified as a member of the *Thauera* genus and re-named as *Thauera aromatica* K172 (Anders et al., 1995).

Thauera aromatica K172 is a Gram-negative bacterium from the *beta* subclass of *Proteobacteria*. *Thauera aromatica* K172 cells are slightly motile rods (between 1.0 and 2.5 μm long and 0.5 to 1.5 μm wide) with rounded ends (Tschech and Fuchs, 1987; Anders et al., 1995). These bacteria can grow using several aromatic and non aromatic compounds as the sole carbon source. The substrate utilization depends on the presence or absence of oxygen (Anders et al., 1995). For example, toluene, phenol, 2-hydroxybenzoate, benzaldehyde and benzylalcohol are only degraded in anaerobic

conditions, while 3- and 4- hydroxybenzoate, 2-aminobenzoate and benzoate can be degraded in both aerobic and anaerobic conditions (Anders et al., 1995).

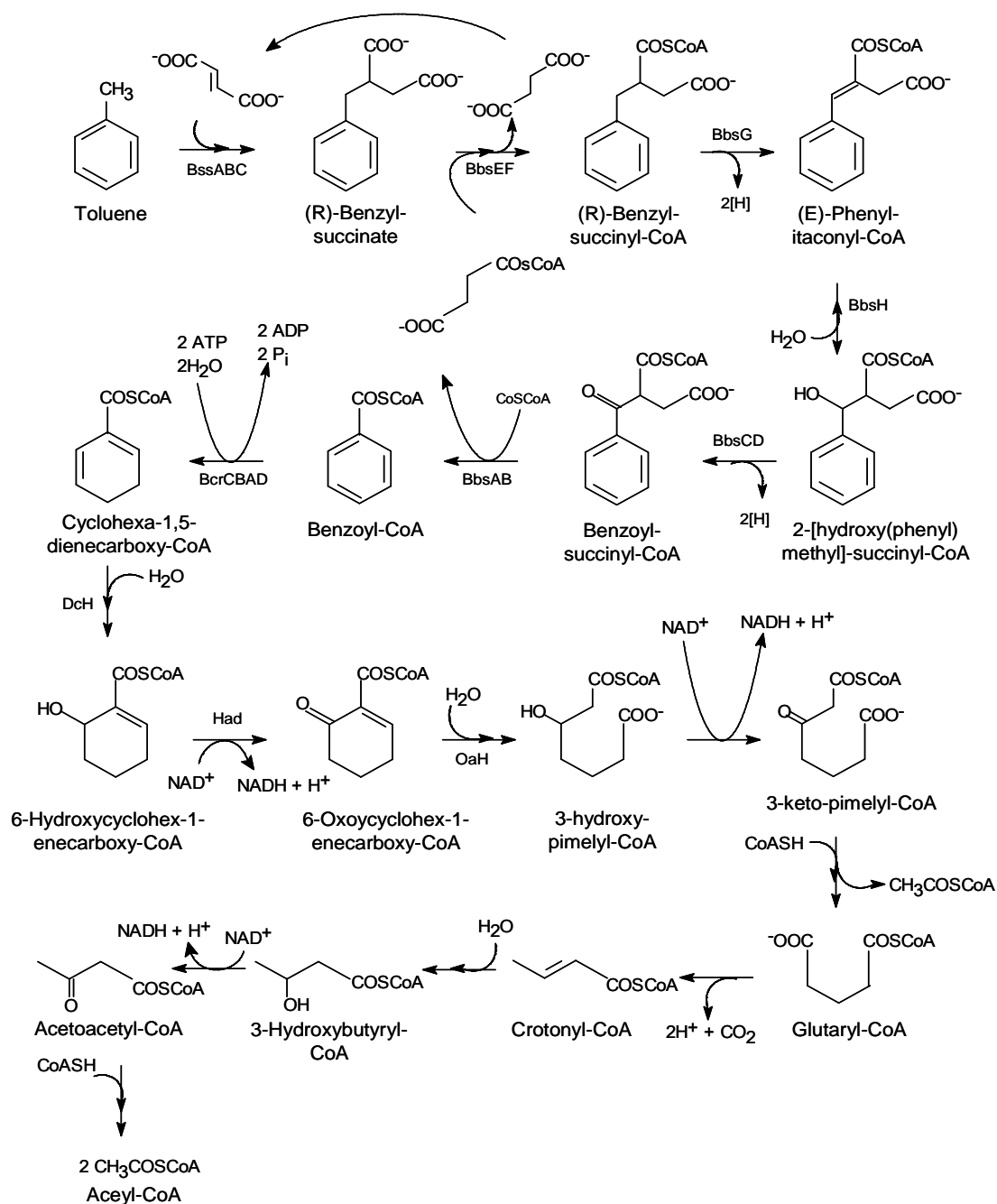

Figure 6. Anaerobic toluene degradation pathway in *T. aromatica* K172. **Enzymes:** BssABC, benzylsuccinate synthase; BbsEF, benzylsuccinate CoA transferase; BbsG, benzylsuccinyl-CoA dehydrogenase; BbsH, phenyl-itaconyl-CoA hydratase; BbsCD, 2-[hydroxyl(phenyl)methyl]-succinyl-CoA dehydrogenase; BbsAB, benzoyl-succinyl-CoA thiolase. BcrCBAD, benzoyl-CoA reductase; Dch, dienoyl-CoA hydratase; Had, 6-hydroxycyclohex-1-enecarboxyl-CoA dehydrogenase; Oah, 6-oxocyclohex-1-enecarboxyl-CoA hydrolase.

Several studies have focused on the elucidation of the metabolic pathway used by *Thauera aromatica* K172 for toluene degradation and the enzymatic reactions involved. After several hypotheses about metabolites formation (Altenschmidt and Fuchs, 1991, 1992; Seyfried et al., 1994), Biegert *et al.* reported that formation of benzylsuccinate from toluene and fumarate is the first step in anaerobic degradation of toluene by *Thauera aromatica* (Fig. 6) (Biegert et al., 1996).

The glycy radical enzyme benzylsuccinate synthase is responsible for the addition of a fumarate molecule to the toluene methyl group in the first step of toluene degradation pathway (Boll et al., 2002). The reaction starts when the activated enzyme-bound radical abstract a hydrogen from the toluene molecule to yield a benzyl radical intermediate. Recombination of this product radical with enzyme-bound hydrogen produces (R)-(+)-benzylsuccinate. The genes encoding the three subunits of the enzyme (BssA 98 kDa, BssB 8.5 kDa and BssC 6.5 kDa) are grouped in an operon structure which include a fourth gene *bssD* encoding the activating enzyme required to introduce the glycy radical group into Bss (Hermuth et al., 2002). Transcription of the *bss* genes is initiated in front of *bssD* in response to the presence of toluene. A two component regulatory system has been described for the *bss* operon called *tdiSR* genes (toluene degradation induction) (Leuthner and Heider, 1998a) but the exact regulatory mechanisms are still unknown (Fig 7a).

Further oxidation of benzylsuccinate proceeds via a modified β -oxidation pathway and produces succinate and benzoyl-CoA as a central intermediate (Leutwein and Heider, 1999, 2002) (Fig 5). A toluene induced operon of nine genes, called *bbs*, encodes the necessary enzymes for the β -oxidation of benzylsuccinate (Leuthner and Heider, 2000) (Fig. 7b). Two of these gene, *bbsA* and *bbsI*, have an unknown function.

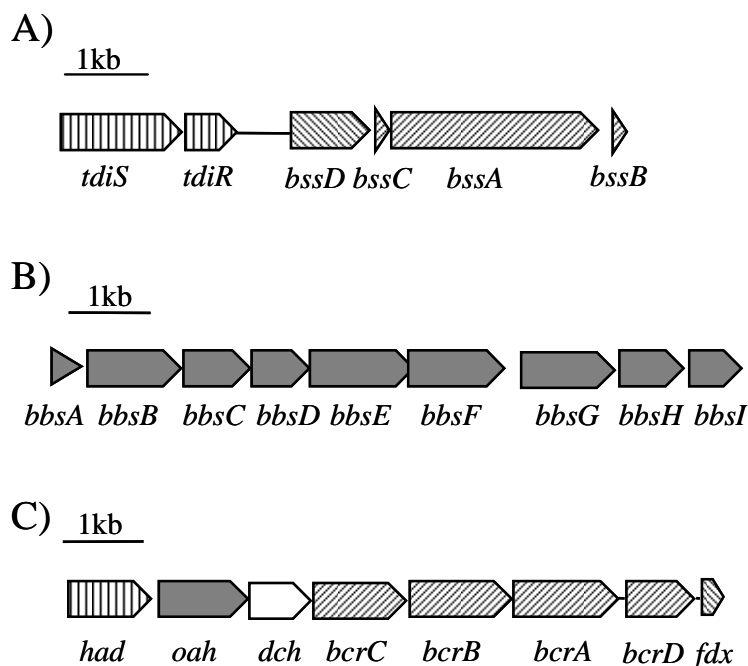

Figure 7. (A) Operon structure containing the genes for benzylsuccinate synthase and toluene regulatory proteins. Source: Leuthner and Heider 1998. (B) Organisation of the *bbs* operon encoding for the β -oxidation of benzylsuccinate. Source: Leuthner and Heider, 2000. (C) Organization of genes involved in benzoyl-CoA pathway in *T. aromatica*. Source: Breese *et al.*, 1998.

The main intermediate benzoyl-CoA is metabolised by *Thauera aromatica* via 3-hydroxypimelyl-CoA by the enzymes of the benzoyl-CoA pathway (Breese *et al.*, 1998). The first enzyme of this pathway, benzoyl-CoA reductase, catalyzes the transfer of two electrons to benzoyl-CoA to form cyclohexa-1,5-diene-1-carbonyl-CoA. The hydrolysis of two ATP molecules to ADP is necessary for this reaction (Boll and Fuchs, 1995; Unciuleac and Boll, 2001). A gene cluster that comprises eight genes transcribed in the same direction and directly adjacent to each other was found to encode the enzymes of the benzoyl-CoA pathway (Breese *et al.*, 1998) (Fig. 7c).

The regulation of anaerobic hydrocarbon degradative pathways is not well understood. More extensive expression studies have been carried out with the bacteria *Aromatoleum aromaticum* Ebn1 (Kühner *et al.*, 2005; Wöhlbrand *et al.*, 2007). In the case of *Thauera aromatica* it has been observed that key enzymes like benzoyl-CoA reductase have a high activity when cells are grown on aromatic compounds, whereas peripheral enzymes respond to the presence of specific substrates (Heider and Fuchs, 1997). Northern blot analysis using *bssC* and *bssB* DNA probes have shown hybridization

exclusively with total RNA of cells grown on toluene (Leuthner et al., 1998b). This result was confirmed later by Heider *et al.* (1998) who observed that benzyl succinate synthase activity was only present on toluene grown cells. In the same study, benzoyl-CoA reductase activity was detected in cells grown on most of the aromatic compounds studied like toluene, benzoate, phenol, 4-hydroxybenzoate and 2-aminobenzoate. However, no activity was detected when cells were grown in the presence of glutarate and acetate (Heider et al., 1998). As enzymes involved in anaerobic toluene degradation are very sensitive to molecular oxygen the existence of at least one oxygen regulatory protein is presumed. At present, this regulatory protein has not been defined in *Thauera aromatica* (Heider and Fuchs, 1997). In *Azoarcus* sp. strain CIB, it was shown that the expression of the cluster *bzd* for anaerobic catabolism of benzoate is under control of a transcriptional repressor BzdR, but also a transcriptional activator AcpR which activates the promoter of the cluster under anoxic conditions (Durante-Rodríguez et al., 2006). In *Thauera aromatica*, it has been observed that general metabolic enzymes are not regulated by oxygen availability. Meanwhile, a down-regulation of protein synthesis of benzoyl-CoA reductase was found as a response to the presence of oxygen (Heider et al., 1998). However, trace amounts of inactive enzyme were still detected by immunological assay in aerobic conditions, suggesting that cells maintain a basal level of enzyme expression probably to rapidly response to changes in the environmental conditions.

2. GOAL OF THE THESIS

Pollutant degrading bacteria are known to possess several gene regulatory systems in order to respond and adapt to environmental changes. However, so far, there is a lack of knowledge on the dynamic regulation of catabolic genes in conditions with changing oxygen concentrations as occurring in many natural environments such as the rhizosphere.

The aim of this thesis was therefore, to study the influence of oxygen availability and oscillations on the expression of catabolic genes of the aerobic and anaerobic toluene degrading bacteria, *Pseudomonas putida* mt-2 and *Thauera aromatica* K172. The expression of the key genes *xylM*, *xylE*, *bssA* and *bcrA* participating in the aerobic and anaerobic toluene degradation pathways, respectively, were the target genes in this study. *xylM* gene encodes one of the subunit of xylene monooxygenase, which catalyses the hydroxylation of the carbon side chain of toluene. The *xylE* gene encodes for catechol 2,3-oxygenase, which catalyses the transformation of catechol, the main intermediate of aromatic aerobic catabolic pathways, to 2-hydroxymuconic semialdehyde. The anaerobic counterpart *bssA* (the large subunit of benzyl-succinate synthase) and *bcrA* (α -subunit of benzoyl-CoA reductase) catalyse the transformation of toluene to benzyl succinate and the transformation of the main intermediate benzoyl-CoA, respectively. Real-time PCR appeared to be the most suitable method to quantify gene expression. With this method, a relative quantification analysis was performed and the gene expression under different oxygen availabilities was monitored.

The experimental work consisted of batch cultures with pure cultures of the investigated bacteria, growing on toluene as carbon source, to study the effect of oxygen availability on gene expression. In order to survey the recovery of catabolic gene expression of *P. putida*, a batch growth where fresh oxygen was injected after a temporal lack of oxygen and a continuous fermentation on a 5 L scale were carried out to simulate the day/night cycle of oxygen depletion as occurring in the rhizosphere. Finally, a binary culture was established in order to study the gene expression oscillation and interaction between aerobic and anaerobic toluene degraders submitted to anoxic/oxic cycles.

3. MATERIALS AND METHODS

3.1. Solutions and Media

3.1.1. *P. putida* agar plates media

100 ml Solution 1

25 ml Solution 2

5 ml Solution 3

18 g Agar

Adjust the volume to 1 L with distilled water

Table 1. Composition of the solutions for *P. putida* agar plates.

Solution 1 ¹		Solution 2 ¹		Solution 3 ¹	
5g	(NH ₄) ₂ SO ₄	70 g	Na ₂ HPO ₄ x 2H ₂ O	800 mg	Na-EDTA
1g	MgCl ₂ x 6H ₂ O	20 g	KH ₂ PO ₄	300 mg	FeCl ₂
0.5 g	Ca(NO ₃) ₂ x 4H ₂ O			4 mg	CoCl ₂ x 6H ₂ O
				10 mg	MnCl ₂ x 4H ₂ O
				1 mg	CuSO ₄
				3 mg	Na ₂ MoO ₄ x 2H ₂ O
				2 mg	ZnCl ₂
				0.5 mg	LiCl
				0.5 mg	SnCl ₂ x 2H ₂ O
				1 mg	H ₃ BO ₃
				2 mg	KBr
				2 mg	KI
				0.5 mg	BaCl ₂

¹The volume of all solutions were adjusted to 1 L using distilled water

3.1.2. *Thauera aromatica* K172-Medium (TAM media)

50 ml	TAM A solution
0.3 ml	TAM B solution
0.36 ml	KNO ₃ Stock solution
0.5 ml	Trace elements solution
0.25 ml	Vitamin solution

Table 2. Composition of solutions for *Thauera aromatica* K172-Medium (TAM media)

TAMA -solution	Trace elements solution SL-10	Vitamin solution
1.632 g KH ₂ PO ₄ 11.840 g K ₂ HPO ₄ Add 1 L with distilled water	5.0 ml HCl (25 %) 0.75 g FeCl ₂ x 4H ₂ O 35 mg ZnCl ₂ 50 mg MnCl ₂ x 4H ₂ O	25 mg Vitamin B12 25 mg Pantothenic acid 25 mg Riboflavin 5 mg Pyridoxamine-HCl
TAM B -solution	3 mg H ₃ BO ₃	10 mg Biotin
35 g NH ₄ Cl 13.2 g MgSO ₄ x 7H ₂ O 1.6 g CaCl ₂ x 2H ₂ Adjust the volume to 0.4 L with distilled water	95 mg CoCl ₂ x 6H ₂ O 1 mg CuCl ₂ x 2H ₂ O 12 mg NiCl ₂ x 6H ₂ O 18 mg Na ₂ MoO ₄ x 2 H ₂ O	10 mg Folic acid 12.5 mg Nicotin acid 12.5 mg Nicotin amide 25 mg α-Lipoic acid 25 mg 4-Aminobenzoic acid
KNO₃-stock solution	Add 495 ml distilled water	25 mg Thiamin-HCl x 2H ₂ O
28 g KNO ₃ Adjust the volume to 0.1 L with distilled water		Add 500 mL distilled water

20 % Di-Sodium Succinate Solution (w/v)

20 g Di-Sodium Succinate

Adjust the volume to 100 ml with distilled water

3.2 Bacterial strains and growth conditions

3.2.1. *Pseudomonas putida* mt-2

For the maintenance of the bacteria, *P. putida* mt-2 was regularly transferred to milieu-agar plates (see section 3.1) and toluene was used as a carbon and energy source. Toluene was provided in the gas phase of anaerobic jars (Anaerocult, Merck). Plates were incubated at 30°C for approximately two days and stored at 4°C until usage.

As inoculum of the kinetic experiments, *P. putida* mt-2 was grown in 250 mL screw cap flasks containing 50 mL TAM media (described for *Thauera aromatica* K172, see section 3.1) and succinate as carbon and energy source. Bacteria were grown in aerobic conditions on a rotary shaker at 30°C and 145 rpm.

For kinetics experiments 120 mL flasks containing 50 mL of TAM media were used. Since defined oxygen concentration were needed all solutions were flushed with nitrogen to make them anaerobic, except for those flasks in completely aerobic conditions. Teflon stoppers and metallic crimps were used to close the flasks. A desired volume of oxygen was injected into the flasks according to each experiment as well as the toluene as carbon source.

3.2.2. Growth of *P. putida* mt-2 in Fermentor

Two kinds of experiments were done using a 5 L fermentor (Labfors small fermenter systems, Infors AG, Switzerland) with controlled oxygen conditions (Fig. 8): Fed-batch experiment and a continuous fermentation. The final volume of the fermentation was 2 L.

The reactor was filled with 1700 mL of TAM media and autoclaved for 30 min at 121 °C. During the fermentations toluene was used as carbon source in concentration a range of 1.1 ± 0.1 mM (measured in the liquid phase). Toluene was constantly added to the fermentor, through the gas phase. For this reason an external Schott flask filled with 200 mL toluene was flushed constantly with N₂ or air (depending on the experiment) in order to saturate the gas phase with toluene. Using a flow-meter allowed a constant flow of toluene entering the reactor (0.6 L/min). The temperature used in all reactor experiments was 30 °C, with stirring at 300 rpm and the pH was fixed at 7.3 (adjusted

with 5 % H₃PO₄). The parameters controlled on line by the reactor were: temperature, pH, dissolved oxygen (pO₂), CO₂, and O₂, using Iris NT software (Infors AG, Switzerland) (Fig. 8).

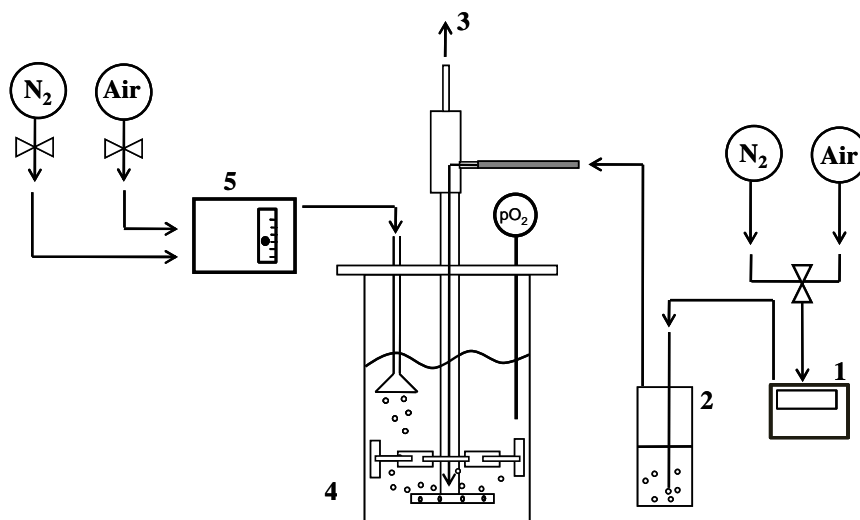

Figure 8. Schematic representation of the experimental set up of Labfors® 5L fermentor. **1:** flow meter to adjust air or nitrogen flow into toluene evaporator (0.6 L/min), **2:** toluene evaporator, **3:** exhausting gas, **4:** Stirred tank reactor, **5:** flow meter to adjust air or nitrogen flow into the fermentor (3 L/min).

As inoculum for the fermentation experiments, *P. putida* mt-2 was grown with succinate as carbon source using a 500 mL Schott flask filled with 150 mL of TAM media. The bacteria were incubated at 30°C and 145 rpm during approximately 30 h to get a culture in stationary phase with optical density (OD), measured at 560 nm, of 1 A (1 x 10⁹ cells mL⁻¹).

Before inoculation, a couple of hour's equilibration was necessary to get temperature constant and to get a homogeneous concentration of toluene in the reactor. During the fermentation experiments samples to monitor OD, toluene concentration, ATP content and RNA extraction were taken. The experiment was started by adding 150 mL of the inoculum with an OD 1 (1 x 10⁹ cells mL⁻¹) through a rubber septum in the reactor. Immediately after inoculation the samples corresponding to zero hour sample was taken.

In the continuous fermentation experiments with a continuous carbon source supply, a feed bottle containing fresh TAM media to keep bacteria growing constantly was additionally prepared. When the bacteria in the fermentor reached an OD (measured

at 560 nm) of 0.3-0.4 (3×10^8 - 4×10^8 cell mL⁻¹) the feeding with fresh sterile TAM media was started at a rate of 0.13 h⁻¹ during the aerobic cycles and 0.0075 h⁻¹ after one hour of anaerobic conditions. The same volume of culture was pumped out with a second pump as waste to keep constant the volume of the reactor.

3.2.3. *Thauera aromatica* K172

For the maintenance of the bacteria, *Thauera aromatica* K172 was regularly transferred to 120 ml anaerobic flasks containing 50 ml of TAM media and benzoate (5 mM) as carbon source and 20 mM KNO₃ as electron acceptor. The bacteria were grown at 30°C and shaken at 145 rpm. Every 72 hours, 1 ml from the growing culture was inoculated in another anaerobic flask containing freshly prepared media, allowing continual bacterial growth and conservation.

For the kinetics experiments using *T. aromatica*, an inoculum in TAM media and acetate as carbon source in anaerobic conditions was used. The cells were incubated at 30°C and shaking at 145 rpm during approximately 24h to get a culture at the beginning of the stationary phase. The experiments started with an initial OD (560 nm) of 0.060 (6×10^7 cells mL⁻¹). Benzoate, acetate or toluene was used as carbon source at concentrations of 5 mM, 6 mM and 0.5 mM, respectively, and 20 mM KNO₃ was used as electron acceptor. The cultures were incubated at 30°C and shaking at 145 rpm until the sample was sacrificed for sampling. To study the effect of oxygen in the gene expression of the catabolic genes, *bssA* and *bcrA*, concentrations of 0.68 or 1.63 mM (1 mL or 2.4 mL, respectively) of oxygen were injected into the cultures after 9 h of anaerobic growth on toluene. After the corresponding incubation time different aliquots were taken for OD (560nm) measurement, toluene concentration measurement, nitrate (NO₃⁻) and nitrite (NO₂⁻) analysis and RNA extraction.

3.3. Analytical methods

3.3.1. Toluene

Toluene concentrations were measured using gas chromatography coupled with a flame ionization detector (GC-FID). For technical reasons the analysis was done in two different gas chromatographs: HP series HP6890 (Agilent technology) and gas

chromatograph Chrompack CP-3800 (Varian, The Netherlands). The injection was automated using an HP 612904 and HP 7694 headspace auto sampler (Hewlett Packard, Palo Alto, Calif.), respectively. For each instrument an adequate calibration curve was prepared. The temperature program used with the HP6890 equipment was as follows: 70 °C, 2 min; 30 °C min⁻¹ until 260 °C, hold 2 min. The program used with the Chrompack CP-3800 instrument was: 100 °C, 1 min; 50 °C min⁻¹ until 225 °C, hold 2.5 min. Other parameters like injection temperature 220 °C, FID-detection temperature 250 °C, and constant pressure 10.0 psi were the same in both cases. The respective columns used were 30-m by 0.32 mm HP-5 column (Hewlett Packard, Palo Alto, California, USA) and 30-m by 0.53-mm GS-Q column (J&W Scientific, Waldbronn, Germany). 1 mL of liquid sample was taken from each culture flask or from the fermentor and injected in headspace vials, which were previously flushed with helium, added 50 µl 50% H₃PO₄ and closed with a Teflon-coated butyl rubber septum. Until the samples were measured with gas chromatography, the vials were stored at 4°C. The concentration (mg/L) of toluene was subsequently plotted against time.

3.3.2. Dissolved Oxygen measurement

The concentration of dissolved oxygen in the medium was measured using planar oxygen sensor spots (Planar Oxygen Sensor Spot, PreSens GmbH; Fibox 3 Oxygen Meter, PreSens GmbH). At each sampling point the dissolved oxygen concentration was registered every second during one minute and the results were displayed using Oxy view-PsT3-V 5.41 software (PreSens GmbH). Each measurement point corresponds to the average of the data collected during one minute.

For the oxygen limited growth studies, the TAM media was first deoxygenated by flushing it with nitrogen and finally autoclaved. Following this, a known volume of oxygen (2.73, 1.63, 0.68 mM) was injected into the individual flasks to achieve the desired dissolved oxygen concentration based on equilibrium between the aqueous solution and the headspace. To estimate the initial amount of dissolved oxygen in the flask when the experiments start, in other words, the amount of oxygen that bacteria have available to start degradation, a calibration curve was prepared (Fig. 9).

For the calibration curve, six different volumes of pure oxygen were injected in anaerobic flasks containing 50 mL of TAM media. The flasks were incubated for 12h at

30°C and shaking at 145 rpm, after that time the dissolved oxygen concentration was measured.

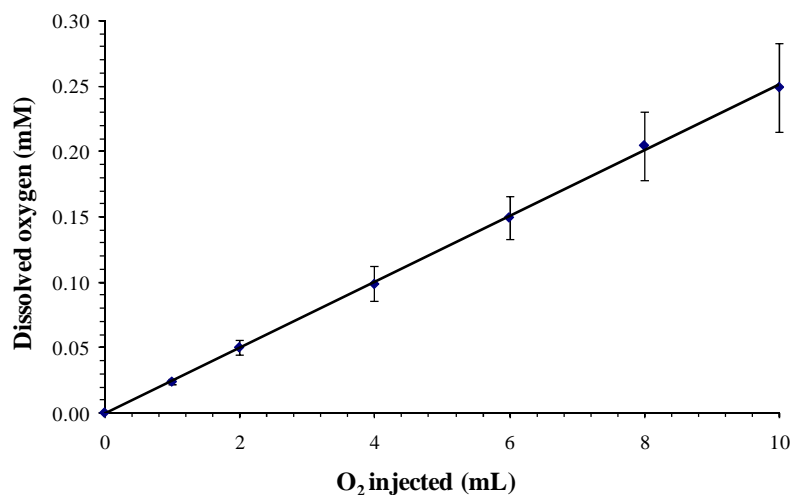

Figure 9. Calibration curve to determine the equivalence of volume injected into dissolved oxygen concentration in equilibrium. Different volumes of pure oxygen were injected in 120 mL flasks containing 50 mL of TAM media. The flasks were incubated at 30°C and shaking at 145 rpm after 12 h incubation dissolved oxygen concentration was measured using planar oxygen sensor spots.

Approximately 4% of the injected oxygen was present in the liquid phase, except for the lowest volume injected (1 mL=0.68 mM) where 3% of the oxygen was dissolved in the media in equilibrium conditions. In fully aerobic conditions the maximum dissolved oxygen measured was 0.26 mM (in these experimental conditions). For the experiments where dissolved oxygen was measured, the zero point value was determined as the amount of dissolved oxygen in equilibrium according to the calibration curve performed.

3.3.3. ATP

To determine the energy state of the cells, an ATP assay was performed. One mL of sample was taken and transferred to a 2.0 mL Eppendorf tube containing 250 μ L ice-cold 1.3 M perchloric acid solution (23 mM EDTA). The sample was immediately vortexed to stop cell metabolism. After incubation for 15 min at 4°C in perchloric acid the samples were centrifuged for 7 min at 13,000 rpm and 0.5 mL of the supernatant was transferred to a pre-cooled tube with 300 μ L ice-cold potassium hydroxide solution (0.72

M KOH and 0.16 M KHCO₃) to adjust the pH of the sample (pH of 7-7.7). Samples were centrifuged for 7 min at 13,000 rpm, and the supernatant was transferred to a new clean tube and stored at -20 °C until ATP measurement was done. If necessary, the pH of the sample was corrected with either potassium hydroxide or perchloric acid.

The concentration of ATP was determined with an ATP kit (BioThema, Sweden). The analysis is based on the reaction catalysed by luciferase (Fig. 10), an enzyme occurring in fire flies. In this reaction free ATP and luciferin is transformed into light, as a result the amount of emitted light is proportional to the amount of free ATP that was present in the original sample.

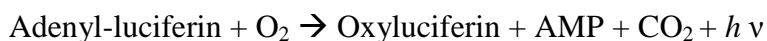
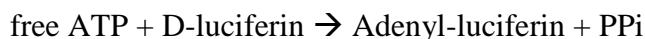

Fig. 10. Scheme of luciferase catalyzed reaction. Free ATP and luciferin are transformed into adenyl-luciferin and pyrophosphate (PPi). Further, adenyl-luciferin reacts with oxygen to form oxyluciferin, light, CO₂ and AMP.

Before analysis the samples were thawed and centrifuged at 10,000 rpm for 10 min. The ATP concentration was measured using a 96-well black-white well microtiter plate. The measurement was carried out by a spectrophotometer (Victor2 Wallac, Perkin Elmer Life Sciences GmbH) that pumped 50 µL D-luciferin in each well containing either buffer or sample. The formed light was measured at 560 nm.

The ATP concentration was calculated using equation 1:

$$C_{\text{ATP}} = \frac{I_1 \cdot (\text{ATP})_{\text{ST}}}{I_2 - I_1} \times \text{D.F} \quad (\text{eq. 1})$$

Where,

C_{ATP}: Concentration of ATP (mol/L)

(ATP)_{ST}: ATP concentration of the standard (mol/L)

I₁: light intensity of the sample

I₂: light intensity of the sample with internal ATP standard

D.F: dilution factor

To standardise between samples the concentration was calculated per dry weight (nmol mg⁻¹ D.W.) of bacteria.

3.3.4. Nitrate and Nitrite concentrations

Nitrate (NO₃⁻) and nitrite (NO₂⁻) concentrations were measured using ion chromatography (DX 500, Dionex). The column used for the analysis was an IonPac AG4A-SC (4x50 mm und AS4A-SC 4x2501). The injection volume was 25 µl and the elution buffer consists of 7 mM NaHCO₂, 1.8 mM Na₂CO₃. The samples were analyzed using an UV-Detector set up at a wavelength of 215 nm. 2 mL of sample was taken from each flask and transferred to an Eppendorf tube. The sample was centrifuge for 15 min at 12,000 rpm. The supernatant was collected in a new clean tube and kept at -20°C until the samples were analyzed.

3.4. Molecular biology methods

3.4.1. Real Time PCR

To monitor the relative expression of *xyIM* and *xyIE* genes of *P. putida* and *bssA* and *bcrA* of *T. aromatica*, real time PCR was used. This method is used for mRNA quantification or to detect small changes in gene expression. Previous to real time PCR reaction it is necessary to perform a total RNA isolation from samples and cDNA synthesis by reverse transcription. The obtained cDNA can be use as template for the real time PCR reaction.

Real time PCR is based on processes like a conventional PCR. However, the introduction of fluorescent technology make possible the detection and quantification of the PCR product while the reaction progresses. There are different fluorescent markers that can be used in real time PCR. In this work the DNA-binding dye SYBR Green I was used, which is a molecule that binds non-specifically to double-stranded DNA (dsDNA) (Sharkey et al., 2004). This molecule has background fluorescence when it is in solution, but the fluorescence increases a 1,000 fold when it binds to dsDNA. During PCR reaction, the amount of DNA product increases exponentially, so will the fluorescence signal of SYBR Green. In the beginning of the reaction, the increase in the fluorescence is not yet detectable because of the background fluorescence. However, when the amplified double stranded DNA product cross the threshold cycle (C_t), during the PCR reaction, the

fluorescence becomes detectable. Lower C_t values (closer to zero) indicate a high amount of template (mRNA in this case) in the sample and vice versa.

When using real time PCR it is necessary to find a valid reference for the normalisation of the obtained data from different samples (Fleige et al., 2006). Different parameters can be used for normalisation, e.g., total RNA concentration, initial cell number or a reference gene. All of them have different disadvantages and a continuous discussion is taking place to define the best reference gene. Housekeeping genes are usually used as reference genes in real time PCR. They are normally expressed in abundance and it is assumed that they have constant expression or at least are minor regulated. For bacteria the most common reference gene is 16SrRNA as internal calibrator of the samples.

In general, there are two methods of quantification analysis: absolute quantification and relative quantification. An absolute quantification is used to quantify unknown samples by interpolating their quantity from a standard curve. It should be based on an external or internal calibration curve, and it is used when values like copy number in the initial sample are needed (Arya et al., 2005). A relative quantification analysis is used to analyze changes in gene expression in a given sample relative to another reference sample, for example, relative increase or decrease compared to baseline level, in gene expression in response to a treatment or in time. The first mathematical model described for relative quantification is also known as the $\Delta\Delta C_t$ method (Livak and Schmittgen, 2001). To use this method is not necessary to perform a quantitative standard curve. The normalised amount of target gene in the sample relative to the normalised calibrator is given by the equation $2^{-\Delta\Delta C_t}$, where $\Delta\Delta C_t = \Delta C_t \text{ target} - \Delta C_t \text{ calibrator}$ and ΔC_t is the difference of C_t values of the target gene and the reference gene. A calibrator is defined as a single reference sample used as the basis for relative fold increase in expression studies. This method supposes equal amplification efficiency between the primers for the reference gene and the target genes, which means that the product is exactly doubled after each cycle. In reality the efficiency of the reaction will be different between the different primer sets. An adaptation of the $\Delta\Delta C_t$ method has been described known as relative-fold method (Pfaffl, 2001) (eq. 2).

$$R = \frac{(E_{\text{target}})^{\Delta\text{Ct, target (calibrator - test)}}}{(E_{\text{ref}})^{\Delta\text{Ct, ref (calibrator - test)}}} \quad (\text{eq. 2})$$

The efficiency (E) of the reaction can be determined using a calibration curve of a dilution series of cDNA (no quantification is needed). The efficiency of one cycle reaction should be calculated in the exponential phase of amplification using the expression $E = 10^{(-1/\text{slope})}$

During this work the 16SrRNA gene was used as a *reference gene* and the expression of four catabolic genes involved in toluene degradation by *Pseudomonas putida* mt-2 and *Thauera aromatica* K172 (*target genes*) were monitored under different redox conditions (*test*). According to the objective of each experiment the best *calibrator* was chosen.

3.4.2. RNA extraction

RNA extraction from *P. putida* and *T. aromatica* was done using RNeasy mini kit (Qiagen, USA). Grown cultures were vacuum filtered using 0.2 μm filters (PALL Corporation, USA) in order to get $\approx 10^{10}$ cells on the filter. The filter with bacteria on it was transferred to a 50 mL falcon tube and washed with 2 mL of RNA protecting reagent (Qiagen, USA). The buffer with the cells was transferred to a 2 mL Eppendorf tube and centrifuged for 10 min at 8,000 rpm. The supernatant was discarded and the pellet was stored at -20°C until RNA isolation took place.

The RNA extraction was done following the manufacturer instructions with some modifications. The pellet was resuspended in 700 μl RLT Buffer (Qiagen, USA) containing 7 μl of β -mercaptoethanol, and transferred to a bead beating tube, chilled on ice for 2 min and lysed using a Fast Prep instrument (FastPrep FP120, Savant Instruments, Inc.) for 20 sec at a speed of 6.0. The tubes were incubated on ice for 2 min and centrifuged for 1 min at 14,000 rpm. The supernatant was transferred to a new tube and 600 μL of ethanol 70% was added. The mixture was transferred in two steps to an RNeasy column (Qiagen, USA) and centrifuged for 15 sec at 12,000 rpm to bind the RNA to the column. 350 μL of RW1 buffer is added and the samples were centrifuged 15 sec at 12,000 rpm. Subsequently 60 μL of DNaseI-master mix (50 μL RDD (Qiagen,

USA) and 10 μL DNaseI (Qiagen, USA) per sample) was added to the column and incubated at room temperature for 15 min. After addition of 350 μL of RW1 buffer, another incubation at room temperature for 5 min followed. Centrifugation for 15 sec at 12,000 rpm and the flow-through was discarded. 500 μL of RPE buffer was added, succeeded by centrifugation for 15 sec at 12,000 rpm and again the flow-through was discarded. The column was centrifuged for 1 min at 12,000 rpm to get rid of all RW1 buffer and transferred to a new collection tube. To resuspend the RNA 35 μL of RNase free water was added to the column and incubated for 1 min at room temperature. Centrifugation for 1 min at 12,000 rpm followed. The resuspended RNA (5 μL) was checked using 1.2% agarose gel. According to the image it was determined whether a second DNA digestion was necessary.

To ensure that RNA was free of DNA contamination, an additional DNase treatment was performed. To a 30 μL sample 3 μL of buffer (10x) and 2 μL of soluble DNase (Ambion, USA) was added. Incubation was done at 37 °C for 30 min. After incubation, the DNase was inactivated by adding 3.5 μL of inactivation reagent and incubation for 2 min at room temperature under continuous shaking followed by centrifugation for 2 min at 10,000 rpm. The final sample containing the RNA corresponds to 25 μL of the supernatant. 2 μL of sample was transferred to another tube for RNA quantification. The samples were stored at -20 °C.

3.4.3. RNA quantification

In order to have an equal amount of total RNA to perform reverse transcription, quantification of the RNA was necessary. RNA quantification was done using Ribogreen as fluorescent dye (Invitrogen, USA) according to manufacturer instructions. 2 μL from the total RNA extraction were diluted 1:100 with 1x TE buffer before to loading them in the microtiter plates. A calibration curve between the ranges of 0 ng/mL to 1,000 ng/mL was performed and loaded together with the samples in the same microtiter plate.

95 μL of each sample was loaded into a 96 well standard opaque plate in duplicates. Background fluorescence was measured and afterwards 100 μL of RiboGreen reagent was added to the wells, mixed and incubated for 3 min. The fluorescence was measured at a wavelength range of 485-525 nm (Spectramax Gemini EM, Molecular

Devices Corporation). The RiboGreen reagent was protected from light throughout the whole procedure.

To calculate the RNA concentration in each sample, fluorescence background was subtracted from the fluorescence measurement. The obtained values were used to calculate the concentration in ng/mL using the calibration curve.

3.4.4. cDNA synthesis

Total RNA (100ng per sample) was used to synthesise cDNA by reverse transcription reaction using the Omniscript kit (Qiagen, USA). Each reaction (20 μ L) contained: 2 μ L 10X Buffer, 2 μ L dNTP mix (5mM each), 1 μ L RNase inhibitor (10U/ μ L), 2 μ L hexamer random primers (100 μ M), 1 μ L Omniscript reverse transcriptase (Qiagen, USA) and the corresponding amount of RNA (100ng). For each sample a control reaction was performed without reverse transcriptase as a control for possible DNA contamination.

The aliquoted RNA samples (100 ng) were incubated for 5 minutes at 65 °C to denature possible secondary structure of the RNA. Afterwards the samples were placed on ice immediately and 7.2 μ L of the corresponding master mix was added. The reverse transcription reaction took place at 37 °C for 60 minutes. Control samples were submitted to the same procedure. Samples were stored at -20 °C until usage.

3.4.5. Primer optimisation

Since real time PCR is a very sensitive technique a previous optimisation of the primer system should be done in order to get reliable results. Several primers were designed using the Primer3 program (http://biotools.umassmed.edu/bioapps/primer3_www.cgi) for the target genes *xylM*, *xylE* and 16SrDNA of *Pseudomonas putida* mt-2 and *bssA*, *bcrA* and 16SrDNA of *Thauera aromatica* K172 (Table 3).

Table 3. Primer sets for optimisation of Real Time PCR method.

Primer name	Gene	Sequence (5' - 3')		Tm (°C)
Tol-912	<i>xylM</i>	gat gcc ttc gct ctt tgt gt	<i>forward</i>	57.3
Tol-F	<i>xylM</i>	tga ggc tga aac ttt acg t	<i>forward</i>	56.5
Tol-R	<i>xylM</i>	ctc acc tgg agt tgc gta c	<i>reverse</i>	58.8
cat-F	<i>xylE</i>	cga cct gat ctc cat gac cga	<i>forward</i>	61.8
XylE-340	<i>xylE</i>	ggg cat cac ttc gag ttg ta	<i>forward</i>	57.3
XylE-691	<i>xylE</i>	ctg atc tcc atg acc gac ac	<i>forward</i>	59.4
cat-R	<i>xylE</i>	tca ggt cag cag ggt ca	<i>reverse</i>	55.2
XylE-536	<i>xylE</i>	tgt tcg gcc aga tag aaa cc	<i>reverse</i>	57.3
XylE-834	<i>xylE</i>	ttt gtg gtc cgg gta gtt gt	<i>reverse</i>	57.3
16Sput-42	16SrRNA	agc ttg ctc ctt gat tca gc	<i>forward</i>	57.3
16Sput-493	16SrRNA	tag aga ggg tgc aag cat ta	<i>forward</i>	57.3
16Sput-411	16SrRNA	caa ggt att aac tta ctg ccc	<i>reverse</i>	55.9
16Sput-606	16SrRNA	gcc agt ttt gga tgc agt tc	<i>reverse</i>	57.3
Bss-276	<i>bssA</i>	gca cgg att gaa gaa cat cc	<i>forward</i>	57.3
Bss-F	<i>bssA</i>	acg acg gcg gca ttt ctc	<i>forward</i>	58.2
Bss-929	<i>bssA</i>	ggt tca cct tcc tga tct gc	<i>forward</i>	59.4
Bss-459	<i>bssA</i>	gat ctc ctg ggc ttc ctt g	<i>reverse</i>	58.8
Bss-R	<i>bssA</i>	gca tga tcg gca ccg aca	<i>reverse</i>	58.2
Bss-1029	<i>bssA</i>	gat cac gct cgc ctt gta gt	<i>reverse</i>	59.4
Bcr-461	<i>bcrA</i>	tgc aga tcg gtg aag aag tg	<i>forward</i>	57.3
Bcr-780	<i>bcrA</i>	gca cct gat gta tcc gaa ga	<i>forward</i>	57.3
Bcr-1111	<i>bcrA</i>	atg tcg atc atc tcg cgt tc	<i>forward</i>	57.3
Bcr-1137	<i>bcrA</i>	ctt cgc cgt agt ttt cct tg	<i>forward</i>	57.3
Bcr-587	<i>bcrA</i>	cgg aac ttg cga ttc atg	<i>reverse</i>	54.5
Bcr-890	<i>bcrA</i>	cggtcgttcactctggaagtt	<i>reverse</i>	57.3
Bcr-1236	<i>bcrA</i>	ctg cac ttc gcc gta gtt tt	<i>reverse</i>	57.3
16Sar-602	16SrRNA	cgt ttg tga ctg caa ggc ta	<i>forward</i>	57.3
16Sar-1279	16SrRNA	gtc tgc aac tcg act acg tga	<i>forward</i>	59.4
16Sar- 785	16SrRNA	gtt tag ggc gtg gac tac ca	<i>reverse</i>	59.4
16Sar-1402	16SrRNA	gtc tgc aac tcg act acg tga	<i>reverse</i>	59.8

3.4.6. Real Time PCR reaction

SYBR Green was used as a fluorescent dye and it was present in a commercial reaction buffer RT² qPCR Master mix (SuperArray). A PCR reaction mix of 25 μ L consisted in: 12.5 μ L RT² qPCR Master mix, 0.5 μ L of each primer (final concentration 0.5 μ M), 10.5 μ L H₂O, and 1 μ L template (cDNA). The used PCR program is described in Table 4.

Table 4. PCR Program used to amplify cDNA using iCycler (BioRad) real time PCR.

Step	Cycle number	Temperature	Time	Process
1	1	95 °C	10 min	Activation of Hot Star Taq Polymerase
2	40	a) 95 °C	15 s	Denaturation of cDNA-double strand
		b) 58 - 63 °C	60 s	Primer annealing/ Data acquisition
3	1	a) 95 °C	60 s	
		b) 55 °C	60 s	
4	80	From 55 °C	10 s	Temperature increasing 0.5 °C/Cycle, Melting curve data acquisition

Triplicates of each sample were loaded in a 96 well plate. As negative control to detect any possible DNA contamination of the used RNA samples, a cDNA reaction without reverse transcriptase as described above was loaded per sample. Six blanks containing only the master mix were also used per experiment. After the real time PCR, 5 μ L of sample was loaded on a 2% agarose gel to check the size of the obtained products and possible contamination present in negative control and blanks. The DNA was visualised using ethidium-bromide staining.

4. RESULTS

4.1. Optimisation of growth conditions and Real time PCR

4.1.1. Bacterial growth conditions

The first step in this study consisted to find the optimal conditions of growth for each bacterium in order to set up a mixed culture which allows toluene degradation and growth of the two model bacteria: *Pseudomonas putida* mt-2 and *Thauera aromatica* K172. The capacities of *P. putida* to degrade high concentrations of this aromatic solvent in optimal grown conditions have been described. It is also known that anaerobic bacteria in general are less resistant to high concentrations of solvents and additionally have more requirements to be cultivated. Therefore, the ability of *P. putida* to grow on the TAM media (originally described for *T. aromatica* (section 3.1)) using toluene as carbon source was tested (Fig. 11).

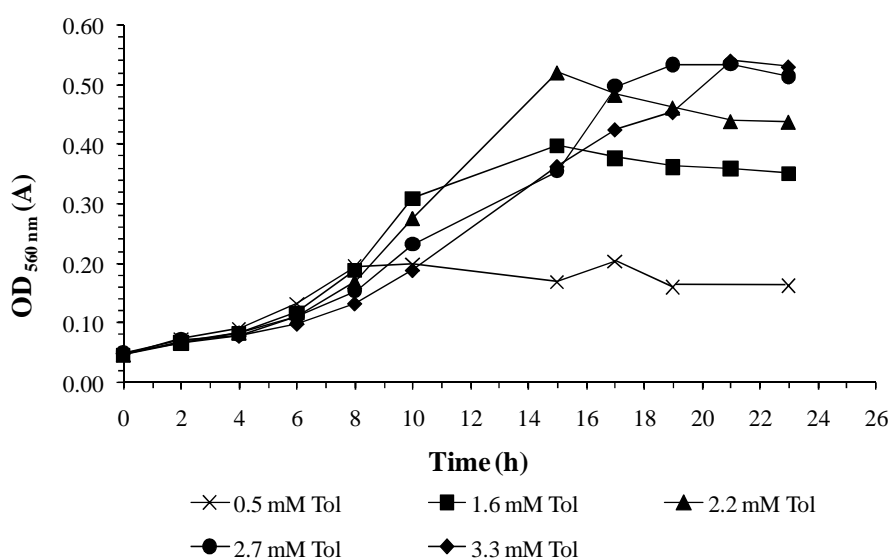

Figure 11. Growth of *P. putida* mt-2 on TAM media using different toluene concentrations as carbon source. Bacteria were grown in 50 mL TAM media at 30°C and shaking at 145 rpm.

The main characteristic of TAM mineral medium is the presence of KNO_3 as alternative electron acceptor. As it is shown in Fig. 11, *P. putida* was able to grow with

all toluene concentrations tested. A growth rate of $\mu=0.19 \text{ h}^{-1}$ was observed with 1.6 mM of toluene but the stationary phase was reached at lower optical density compared to the concentrations 2.2 mM to 3.3 mM where a lower growth rate was obtained ($\mu=0.16$ and 0.12 h^{-1} , respectively). The highest tested toluene concentration was 6.5 mM where no significant growth was detected (data not shown).

In the case of *Thauera aromatica* less tolerance to high toluene concentrations was observed during growth under denitrifying conditions (Fig. 12). In all toluene concentrations tested the growth rate was lower compared to growth on 5 mM benzoate where bacteria had a growth rate of 0.2 h^{-1} (data not shown). With a toluene concentration of 1.6 mM no growth was observed, whereas the highest OD was reached with a toluene concentration of 0.5 mM where the bacteria had a growth rate of $\mu=0.05 \text{ h}^{-1}$.

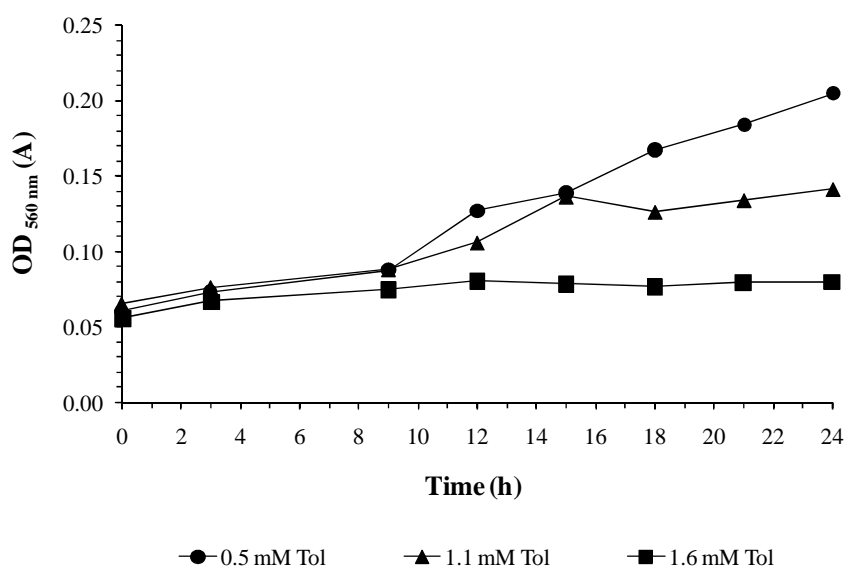

Figure 12. Growth of *T. aromatica* K172 on TAM media and nitrate-reducing conditions using different toluene concentrations as carbon source. Bacteria were grown in 50 mL TAM media at 30°C and shaking at 145 rpm.

These preliminary results showed that TAM media is suitable to perform mixed culture experiments. Moreover, it was determined that for those experiments the concentration of toluene in the media should be limited to 0.5 mM to allow the growth of *Thauera aromatica* as well as *P. putida*. Therefore, most of further experiments using the

model bacteria were performed in TAM media, which contains KNO_3 as alternative electron acceptor and with a toluene concentration of 0.5 mM.

4.1.2. Primer selection and calibration curves

Real-time PCR and relative quantification analysis appeared to be the most suitable method to quantify gene expression. With this method the gene expression under different oxygen availabilities was monitored. Two catabolic genes from each bacterium were selected as target genes: *xylM* and *xylE* from the TOL plasmid of *P. putida* mt-2 and *bssA* and *bcrA* from anaerobic degradation pathway of toluene in *T. aromatica*. Once growth conditions were defined it was necessary to design and optimise the primer sets to be used during this study.

For relative quantification using real time PCR two models have been described until now, the $\Delta\Delta\text{Ct}$ method (Livak and Schmittgen, 2001) and a modification of this described by Pfaffl, known as the relative-fold method (Pfaffl, 2001), which considered the differences in the reaction efficiencies for each primer. Several primer sets were designed for each target genes and the reference genes (see Table 2, section 3.4.5) and tested to get the highest efficiency and specificity. There are several considerations that have to be taken into consideration during the primer design such as primer length, GC content, length of the product to amplify and melting temperatures (T_m). When multiple genes from the same sample are studied, the specificity of the primers for certain product is of crucial importance in order to avoid unspecific binding of the primers and thus a wrong measurement of the gene expression. In this thesis, one of the objectives was to measure gene expression profiles in mixed cultures. Thus, the primer design e.g. for 16S rRNA was more complicated because our two model bacteria have 80% similarity for this gene (data not shown).

First, the optimal annealing temperature for the primers was determined. A temperature gradient experiment was performed with each set of primers using cDNA from *P. putida* and *T. aromatica* grown on toluene as template (data not shown). However, not always the temperature with the optimal amplification curve was the appropriate for the highest specificity of the primers. In those cases, the second or the third optimal temperature had to be tested regarding specificity. Further, a non quantitative calibration curve was made in order to determine the PCR efficiency of a

primer set. Each calibration curve consists in six samples of a dilution series (factor 10) using cDNA from each bacterium grown on toluene. The calibration curves of the four catabolic genes *xylM*, *xylE*, *bssA* and *bcrA* are shown in Fig. 13.

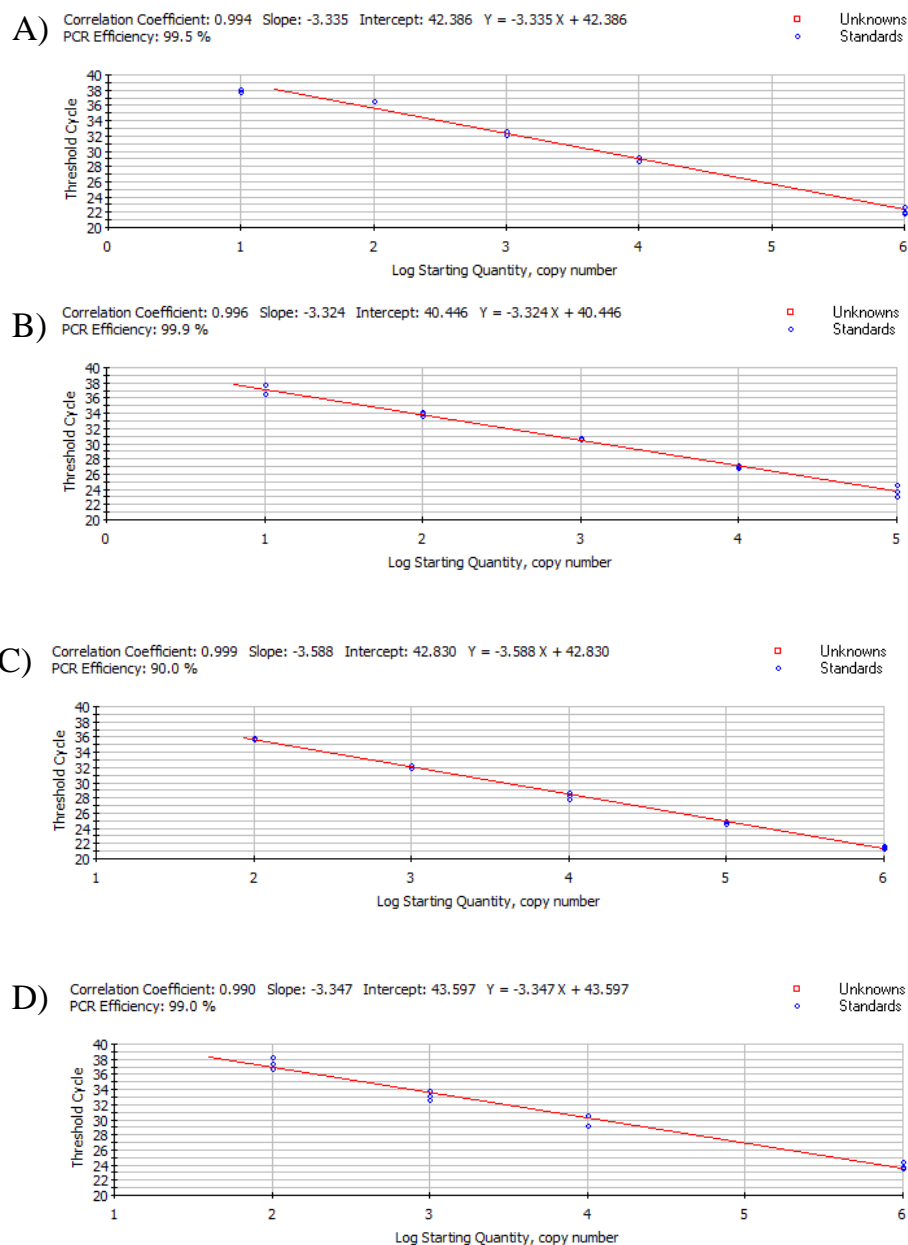

Figure 13. Real Time PCR calibration curves for catabolic target genes. A) *xylM*, B) *xylE* from *P. putida* mt-2, C) *bssA*, D) *bcrA* from *T. aromatica* K172.

The standard curve is obtained plotting Ct (cycle threshold) values against log-transformed concentration serial ten-fold dilutions of the target gene to determine the linear regression. According to literature the efficiency values of a primers set should be between 90% and 105% (Adams, 2006). A summary of the selected set of primers and its efficiencies are shown in Table 5.

Table 5. Primer pairs selected for Real Time PCR experiments. The annealing temperature of each pair of primer and the efficiency of the PCR reaction is indicated.

Prime pair	Gene	Organism	Annealing T (°C)	Efficiency
16s493-16s606	16S rRNA	<i>P.putida</i>	60	95.5%
ToI912-ToIR	<i>xylM</i>	<i>P.putida</i>	58	99.5%
C23OF-xylE834	<i>xylE</i>	<i>P. putida</i>	62	99.9%
16s602-16s785	16S rRNA	<i>T. aromatica</i>	63	91.3%
bss276-bss459	<i>bssA</i>	<i>T. aromatica</i>	60	90.0%
bcr276-bcr459	<i>bcrA</i>	<i>T. aromatica</i>	58	99.0%

4.2. Catabolic gene expression of *P. putida* mt-2 and *T. aromatica* K172 during toluene degradation

In the previous two sections the growth conditions for each model bacterium and the molecular method to perform gene expression studies were described. Batch cultivations were used to perform the first gene expression analysis using the two model bacteria growing on standard conditions. Further, the experimental set up of a continuous fermentation system growing *P. putida* using toluene as carbon source was studied, and the gene expression of bacteria was determined under these growing conditions.

4.2.1. Gene expression of *xylM* and *xylE* during toluene degradation in aerobic conditions in batch cultures

P. putida mt-2 was grown in two different toluene concentrations under aerobic conditions. The toluene concentrations 0.5 mM and 2.7 mM were selected according to the growth curve obtained in the previous section (section 4.1.1).

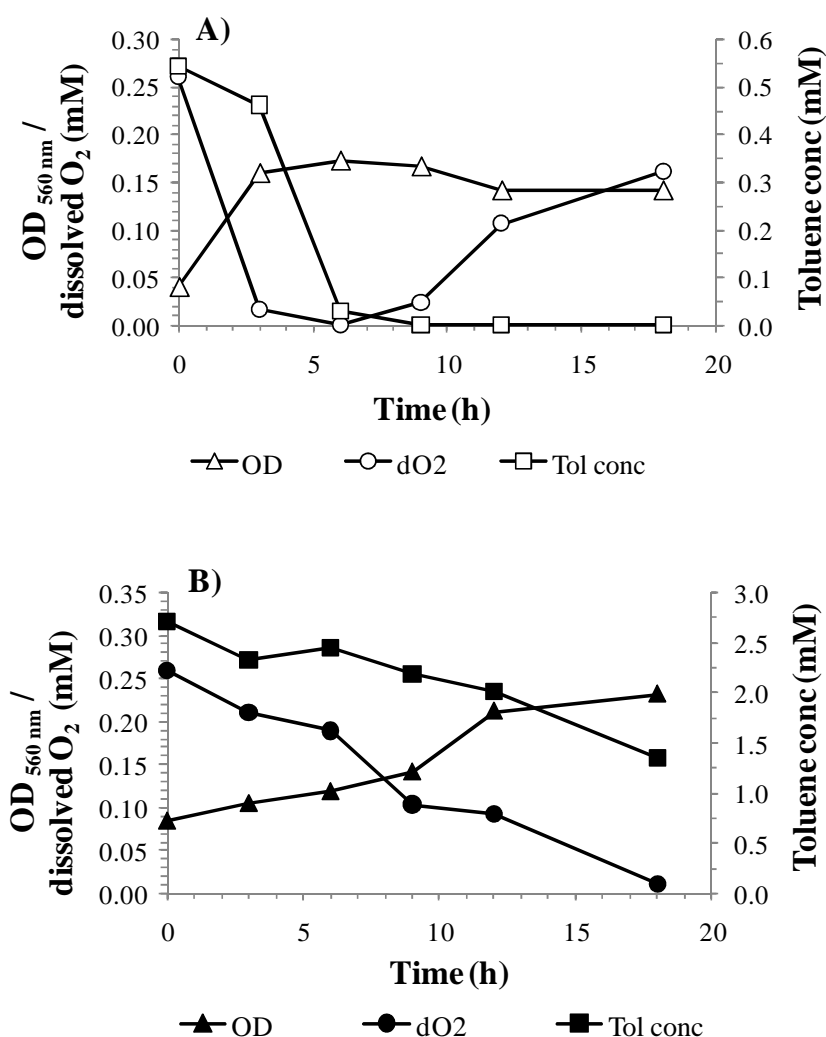

Figure 14. Optical density, toluene degradation and dissolved oxygen in the media during aerobic growth of *P. putida* mt-2 on (A) 0.5 mM (B) 2.7 mM toluene.

P. putida growing on the lowest toluene concentration reached the highest OD and stationary phase already after 6 hours and a growth rate of 0.28 h^{-1} (Fig. 14a). In this set of flasks toluene was almost completely consumed after three hours of incubation (Fig. 14a) and the bacteria were not able to grow anymore. Growth and toluene degradation were slower when the initial toluene concentration was 2.7 mM compare to the lower concentration (Fig. 14b). The growth rate in this condition was approximately 0.08 h^{-1} and after 18h incubation still one third of the toluene initially injected was present in the media. During degradation of 0.5 mM toluene a fast decrease in dissolved oxygen

concentration was observed and at the six hours no more oxygen could be detected in the liquid phase (Fig. 14a). Later, a slow increase in dissolved oxygen concentration was observed. This was probably due to the high degrading activity of bacteria at the beginning of the experiment, when dissolved oxygen in the media was rapidly consumed by the microorganisms. After toluene was completely degraded, the cells would not consume oxygen anymore and the available oxygen in the gas phase continued dissolving in the liquid phase until equilibrium between the two phases was reached. Differently, during degradation of 2.7 mM of toluene the dissolved oxygen concentration decreased gradually in accordance to the slow degradation of the carbon source (Fig. 14b).

Gene expression of the catabolic genes *xyIM* and *xyIE* was monitored at different times of incubation using real time PCR. The relative expression was calculated using the zero hour as calibrator. A strong induction of both genes relative to the expression at the beginning of the experiment was observed in the presence of toluene. Different gene expression profiles were obtained depending on the toluene concentration added initially to the cultures. At a lower initial toluene concentration (0.5 mM) *xyIM* was up-regulated along the complete experiment. However, after three hours of incubation a drop in *xyIM* was observed in accordance with a decrease of the carbon source concentration in the medium (Fig. 15a). For toluene concentration of 2.7 mM the *xyIM* up-regulation values were high through the whole experiment with a highest value reached after nine hours of incubation, when a more significant decrease in toluene concentration started (Fig. 15a). These results showed that *xyIM* expression is highly regulated by the presence of toluene, as has been described previously. When toluene was depleted bacteria decrease the expression of *xyIM*, but bacteria keep this gene up-regulated to a certain extent, as it was observed with a concentration of 0.5 mM, probably to allow a quick reaction in case that the carbon source is available again.

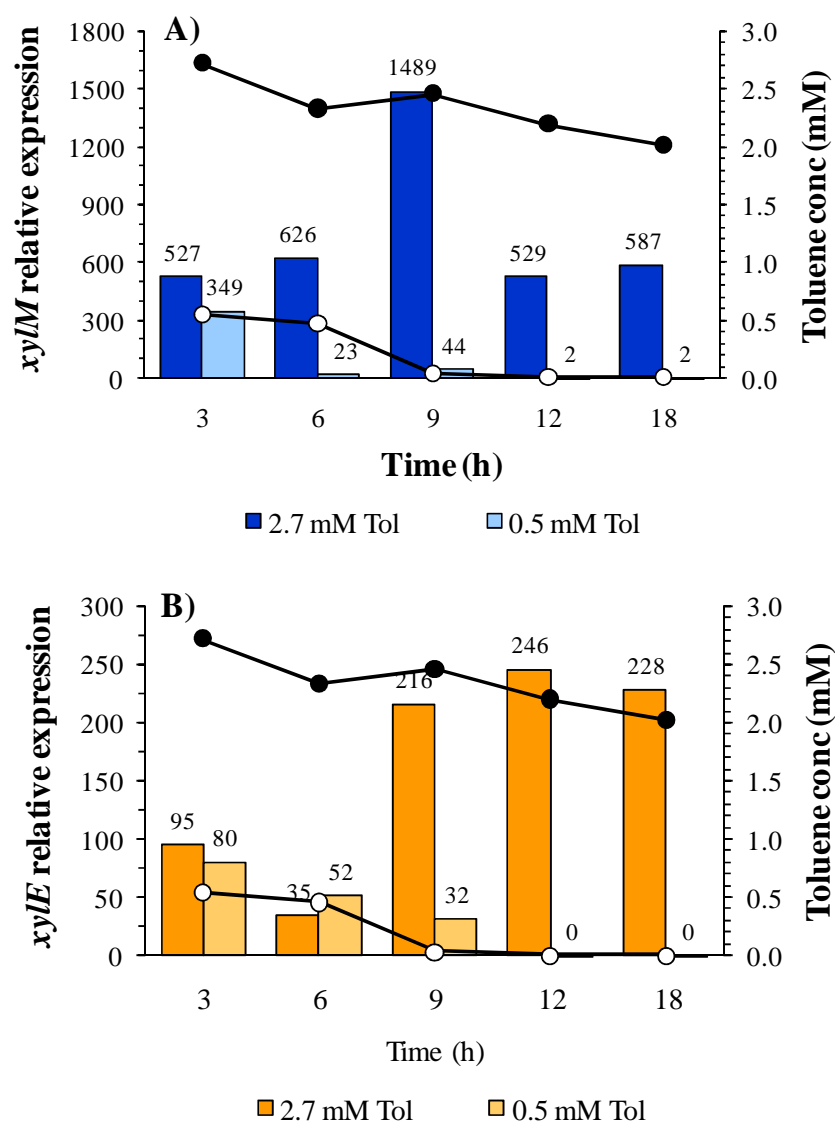

Figure 15. Relative expression profile of *xylM* and *xylE* genes of *P. putida* during toluene degradation. The bars represent the relative expression of *xylM* (A) and *xylE* (B) in the presence of toluene respect to the zero hour sample (calibrator). The lines in the graphs represent the toluene concentration in the liquid phase, closed circles: 2.7 mM, open circles: 0.5 mM initial toluene concentration.

The gene expression profile of *xylE*, which belongs to the *meta*-pathway for toluene degradation, also showed a dependency on the toluene degradation activity of bacteria (Fig. 15b). During degradation of 0.5 mM toluene, up-regulation of *xylE* was observed until toluene was detected in the media. Toluene was rapidly degraded by bacteria, and therefore metabolites are produced at high rate at the beginning of the

experiment as well, inducing the *meta*-pathway genes. At a 2.7 mM toluene concentration *xylE* was always up-regulated and high values were observed at the last half of the experiment. The production of metabolites as benzoate was probably gradual in this case because toluene degradation occurred at lower rates. Therefore, the inducer of the *meta*-pathway genes was continuously formed during the experiment and an up-regulation of the genes was observed.

4.2.2. Gene expression of *xylM* and *xylE* during a batch fermentation using toluene as carbon source

To study the gene expression of catabolic gene of *P. putida* during oxygen oscillation a continuous fermentation system was used. This system assures more homologous sampling and controlled growing conditions. The first experiment consisted of a batch fermentation in order to determine optimal growth conditions of *P. putida* when toluene (1.1 ± 0.1 mM) and oxygen were supplied constantly into the fermentor (see scheme in section 3.2.2) (Fig. 16) as well as to investigate *xylM* and *xylE* relative gene expression over time under these conditions.



Figure 16. Fermentation of *P. putida* mt-2 using the reactor Labfors (Infors AG) using toluene as carbon source.

The growth of bacteria was measured by optical density at certain sampling times (Fig. 17a). As can be seen in Fig. 17, the bacteria were growing in the course of the whole fermentation ($\mu = 0.15 \text{ h}^{-1}$) while toluene was consumed. Additionally, CO_2 percentage was monitored online during the complete experiment and showed a similar behaviour to the optical density, except in the last hours of the experiment where CO_2 production already showed a stationary phase whereas the OD curve was still increasing (Fig 17b). During the first 6 hours toluene degradation was not significant (Fig. 17a). When bacteria entered exponential phase a decrease in toluene concentration was observed and the concentration was relatively constant during the whole experiment (0.6 mM). After 20 hours bacteria reached stationary phase, probably because of lack of other nutrients in the media. Toluene, on the other hand, was still supplied at a constant rate but was not consumed anymore, and therefore, an increase in toluene concentration was observed (Fig. 17a). Together with toluene also air was continuously supplied during the whole fermentation (Fig 17b) and the percentage of dissolved oxygen (%pO₂) was monitored on line together with the CO_2 percentage. A correspondence was observed between the oxygen consumption and the CO_2 formation. At the beginning of the experiment %pO₂ started to decrease slowly when CO_2 still showed no increase, toluene was not degraded and bacteria were in lag phase. When bacteria entered exponential growth phase an abrupt decrease on %pO₂ was observed, and very low values were reached when bacteria were in the middle of exponential phase (Fig. 17b). Air was continuously supplied to bacteria, and therefore the drop on %pO₂ values is due to the high activity of the cells and it does not constitute an oxygen limitation. When bacteria reached the stationary growth phase, the %pO₂ started to increase again (data not shown) because it was not used by bacteria for toluene degradation anymore.

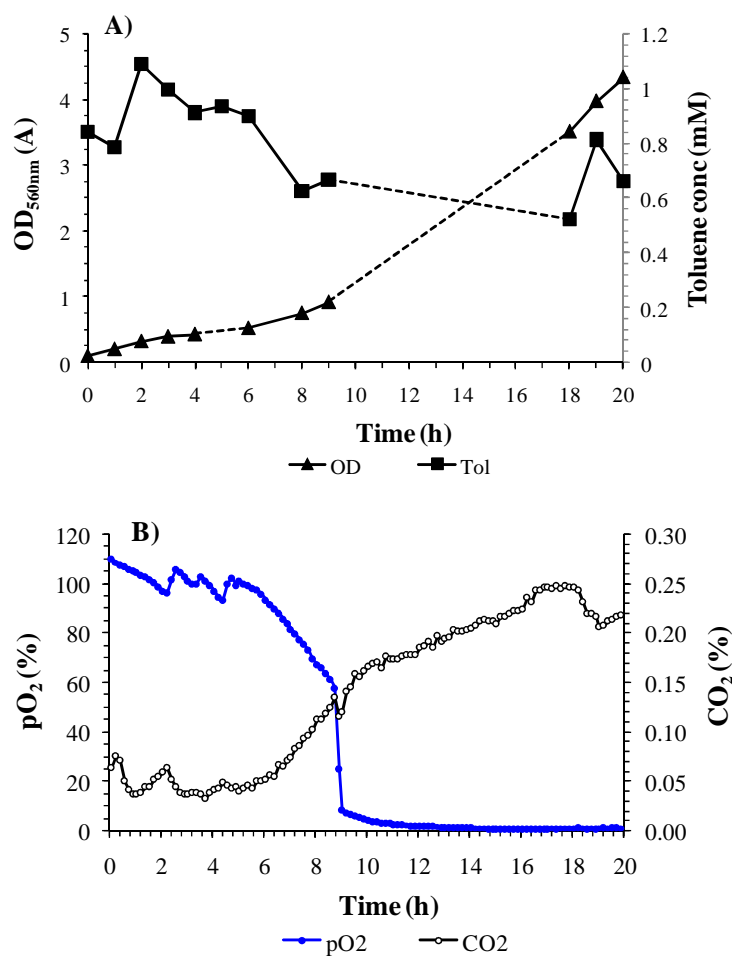

Figure 17. (A) Growth (OD) and toluene degradation (B) % pO₂ and %CO₂ during the growth of *P. putida* mt-2 in a fed-batch fermentation using toluene as carbon source.

The relative expression of the gene *xylM* and *xylE* were studied by real time PCR using the zero hour as calibrator (Fig 18). Both genes were up-regulated during the whole experiment compared to the inoculation time. When bacteria entered exponential phase after approximately 8 hours, the over expression values were higher for the case of *xylM* and it remained like this until the end of the experiment (Fig. 18a). The increase in the up-regulation values of *xylE* was smooth and the highest values were reached close to the end of the experiment similarly to the batch cultures. This result indicates that high induction levels of *meta*-pathway genes were obtained once toluene degradation started and probably later metabolites were present (Fig. 18b).

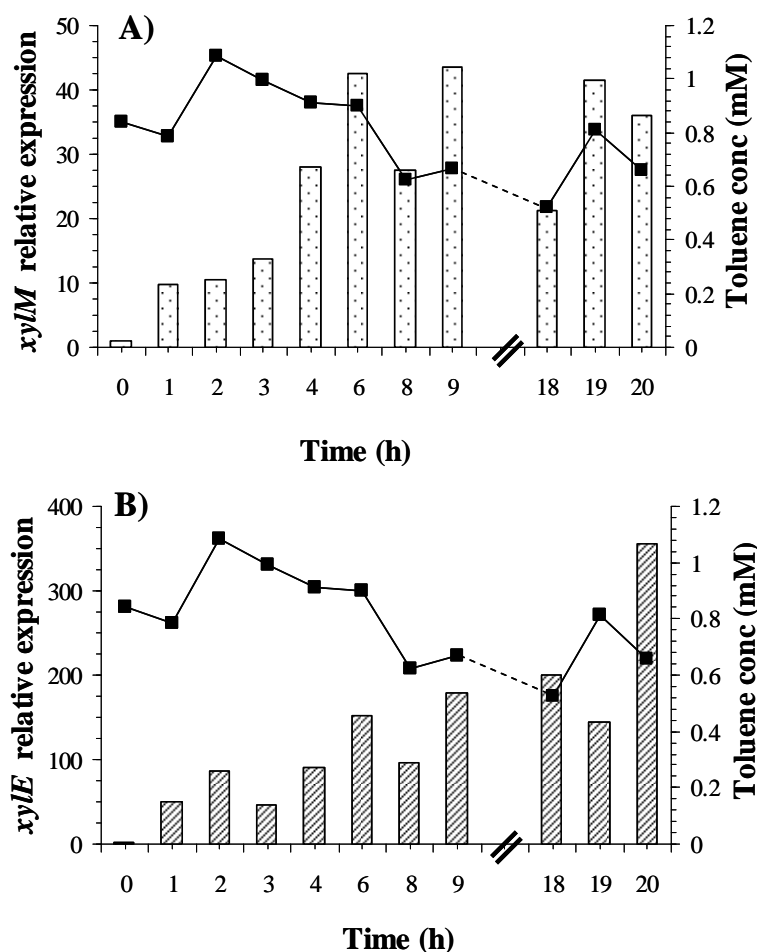

Figure 18. *xylM* (A) and *xylE* (B) relative expression by *P. putida* mt-2 in a fed-batch fermentation. The values of relative gene expression were calculated using the zero-hour sample as calibrator.

4.2.3. Gene expression of *bssA* and *bcrA* during toluene degradation in anaerobic conditions

The bacterium *Thauera aromatica* is able to degrade toluene only in the absence of oxygen using NO_3^- as alternative electron acceptor. To investigate the gene expression of the catabolic genes *bssA* and *bcrA*, *T. aromatica* was grown with 0.5 mM of toluene as carbon source under denitrifying conditions. The growth of bacteria on toluene was compared with growth on 5mM benzoate and 6mM acetate, as control. The highest optical density together with the highest growth rate (0.25 h^{-1}) was obtained when benzoate was used as carbon source (Fig. 19a).

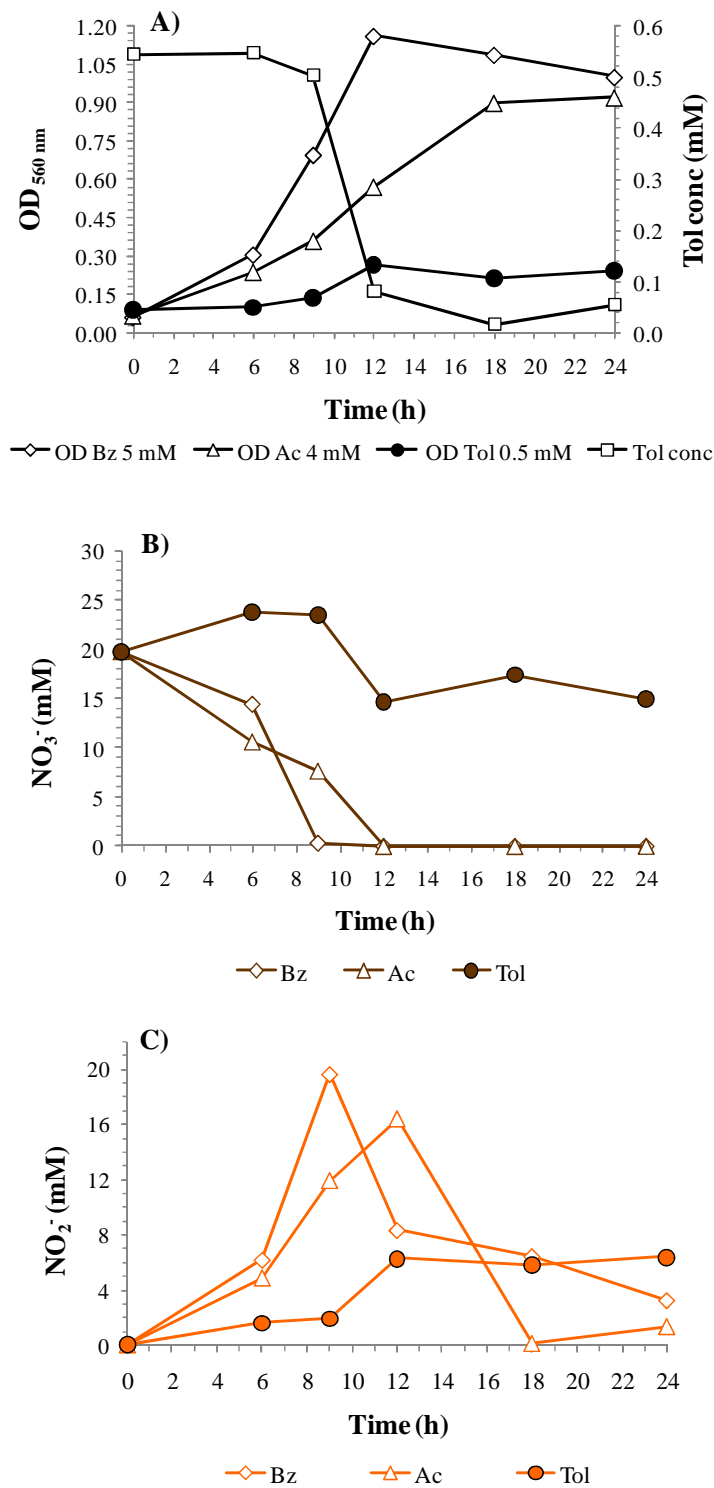

Figure 19. (A) Toluene degradation and growth curve (B) Nitrate (NO₃⁻) concentration and (C) Nitrite (NO₂⁻) concentration in *T. aromatica* K172 cultures growing on 0.5 mM toluene (Tol), 5 mM benzoate (Bz) and 6 mM acetate (Ac).

The growth rate with acetate (0.18 h^{-1}) as carbon source was lower than with benzoate, the stationary phase was reached later and with a lowest optical density. With toluene as carbon source the growth rate was the lowest (0.04 h^{-1}), bacteria reached stationary phase after 12h and with a lower optical density ($0.27A \approx 7.4 \times 10^8 \text{ cells/mL}$) (Fig. 19a). Toluene degradation was not significant during the first 9 hours of incubation. A sudden decrease in toluene concentration was observed after 9 hours and no significant toluene degradation occurred at the end of the experiment (Fig. 19a). During the experiment nitrate consumption and nitrite formation was measured with bacteria growing with the three different carbon sources (Fig. 19b and c). Reduction of NO_3^- to N_2 via NO_2^- as first intermediate occurs when nitrate reducing bacteria are actively consuming a carbon source. During growth of bacteria on benzoate and acetate a complete disappearance of nitrate was observed. Together with nitrate depletion, NO_2^- started to be produced with both carbon sources (Fig 19c). Nitrite started to accumulate until 9h in the case of benzoate and 12 hours in the case of acetate. A complete conversion of NO_3^- to NO_2^- was observed in the cultures growing on benzoate.

Nitrate and nitrite curves showed a certain delay in the case of acetate compared to the benzoate curves, which correlate with the slower growth observed with acetate as carbon source (Fig. 19a, b and c). In the case of the growth on toluene, *T. aromatica* reduced NO_3^- much slower in concomitance with a slower NO_2^- formation (Fig. 19c). After 12h nitrate and nitrate concentration remained stable when bacteria reached stationary phase and toluene was not degraded anymore.

The gene expression profile of the two catabolic genes, *bssA* and *bcrA*, during anaerobic toluene degradation was studied. Relative expression of *bssA* gene was calculated using parallel flasks of benzoate grown cells as calibrator (Fig. 20). At the first sampling point *bssA* was up-regulated but toluene degradation was not significant, showing that probably a threshold enzyme concentration has to be reached to start with the active toluene degradation. The highest gene expression occurred before the highest decrease on toluene concentration was observed.

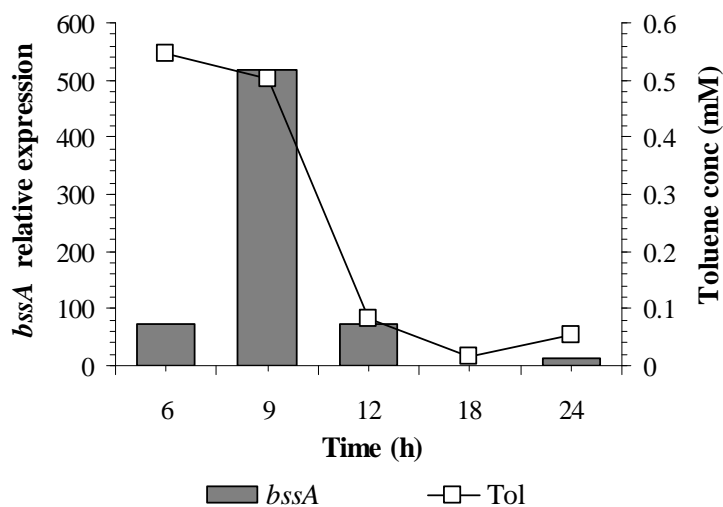

Figure 20. Gene expression profile of *bssA* gene of *T. aromatica* during anaerobic growth on toluene. The grey bars represent the relative expression of *bssA* in the presence of toluene respect to benzoate grown cells (calibrator).

To determine the relative expression of *bcrA* in the presence of toluene as carbon source two conditions were used as calibrator, benzoate or acetate grown cells and both profiles were compared (Fig. 21a). Depending on the calibrator used two different profiles were obtained. When acetate was used as calibrator a clear up-regulation of *bcrA* was observed during the growth on toluene. High values of relative expression were observed during the first 12 hours of incubation and later on the values decreased, the gene however was up-regulated until the end of the experiment. When benzoate grown cells were used as calibrator to calculate *bcrA* relative expression in the presence of toluene, no up-regulation was observed except for the 9 hours point (Fig 21a). This observation is because *bcrA* is expressed on toluene and benzoate growing cultures approximately at the same rate. Benzoate is also degraded via benzoyl-CoA as intermediate, and therefore, *bcrA* gene was up-regulated as well. To confirm this hypothesis *bcrA* relative expression was calculated using parallel flasks of cells growing on acetate as calibrator (Fig. 21b). An up-regulation of *bcrA* was observed during 18 hours of incubation. At the last sampling point a basal expression of the gene with respect to acetate was detected. The highest value was reached at 9 hours, which corresponds to the middle of the exponential growth phase (Fig. 19a). This experiment showed that *T. aromatica* induced at high levels the gene *bcrA* during growth on benzoate as carbon source.

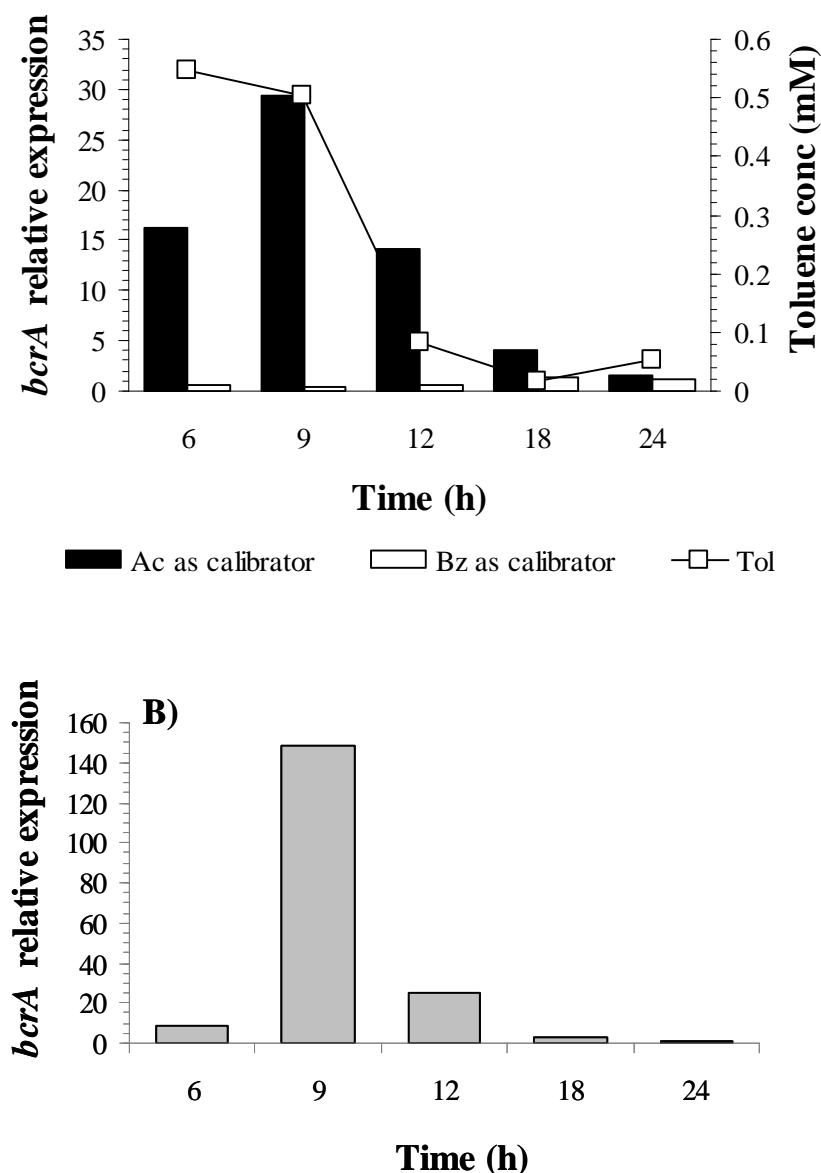

Figure 21. Relative expression of *bcrA* during growth of *T. aromatica* on toluene or benzoate as carbon source. (A) Comparison of *bcrA* gene expression profile of toluene growing bacteria obtained using two different calibrators. (B) Relative expression of *bcrA* during growth on benzoate using acetate grown cells as calibrator. Ac: acetate, Bz: benzoate, Tol: toluene.

During the first part of this thesis, the conditions to use the specific primers targeting catabolic genes involve in toluene degradation under aerobic and anaerobic conditions were determined and optimised. Additionally, the methodology to study the gene expression profiles has been chosen, which corresponds to the relative quantification

method or relative-fold method. The optimal growth conditions for the two model toluene degraders, *P.putida* and *T. aromatica*, have been determined in order to study the effect of oxygen on catabolic gene expression in an aerobic/anaerobic mixed culture. The gene expression of the targeted catabolic genes was studied for both organisms in these optimal growth conditions to get a general view of the response of bacteria, at a molecular level, when they can actively degrade toluene. Finally, a fermentor system was optimised in order to study the gene expression of *P. putida* under oxygen controlled conditions to simulate diurnal cycles as they occur, for example, in the rhizosphere. In further experiments, the expression of catabolic genes of *P. putida* and *T. aromatica* was studied when bacteria were exposed to different redox conditions as isolated culture or in a binary mixed culture.

4.3. Effect of oxygen availability on catabolic gene expression of toluene degrading bacteria

4.3.1. *Pseudomonas putida* mt-2

In order to investigate the dependency of TOL plasmid expression on the presence/absence of oxygen, the degrading capacity of *P. putida* mt-2 under anaerobic conditions was studied. The expression of the TOL genes *xylM* (upper-operon) and *xylE* (meta-operon) was investigated during anaerobic conditions using toluene, succinate and toluene plus succinate as carbon sources. The different carbon source conditions allowed to investigate the possible differences in gene expression when an easy consumable carbon source is present. This last condition could lead to a higher energetic status of the cells and may influence the gene expression profile. As calibrator samples a parallel set of flasks was set up using the already mentioned carbon sources but in aerobic conditions, in order to calculate relative expression. The relative gene expression was monitored during the first six hours of growth according to previous experiments where cells growing aerobically on a low concentration of succinate (3.2 mM) plus 0.5 mM of toluene would reach stationary phase after 6 hours of growth (data not shown). The bacteria did show any activity under anaerobic conditions (Table 6). Additionally, no toluene degradation was observed under anoxic conditions.

Table 6. Growth (OD_{560 nm}) and toluene concentration (mM) of *P. putida* mt-2 in anaerobic conditions using different carbon sources. Succ: succinate (C_{succ} = 3.1 mM); Tol: toluene (C_{tol} = 0.5 mM).

Time (h)	OD _{560 nm} (A)			Tol Conc (mM)		
	Succ + Tol	Tol	Succ	Succ + Tol	Tol	Succ
0	0.04	0.04	0.03	0.5	0.5	0.0
2	0.05	0.05	0.05	0.6	0.6	0.0
4	0.05	0.08	0.05	0.5	0.5	0.0
6	0.05	0.05	0.04	0.5	0.5	0.0

To examine the influence of oxygen on gene expression of the catabolic TOL genes *xylM* and *xylE*, real time PCR was performed. The relative expression is shown in Table 7. The gene expression was calculated relative to normal degrading conditions, it means each anaerobic sample had a parallel aerobic sample for each time and each carbon source conditions to calculate the relative expression.

Table 7. Relative gene expression of *xylM* and *xylE* genes of *P. putida* under anaerobic conditions. Succ: succinate (C_{succ} = 3.1 mM); Tol: toluene (C_{tol} = 0.5 mM).

Time (h)	<i>xylM</i>			<i>xylE</i>		
	Succ + Tol	Tol	Succ	Succ + Tol	Tol	Succ
2	0.54	0.03	0.17	0.0	0.0	0.4
4	0.37	0.00	0.21	0.0	0.0	0.3
6	0.15	0.01	0.04	0.0	0.0	1.0

As can be seen in Table 7, a down-regulation of both catabolic genes occurred in anaerobic conditions when growing on solely toluene or succinate or a mixture of both. In the culture where both toluene and succinate were present, a bit higher numbers of relative expression were observed in the case of *xylM*. However, in this case the values still showed a down-regulation of the genes and a decrease in time. This could be due to small differences in the expression of the gene used for normalisation in the calculations. However, all values indicate a down-regulation of genes under anaerobic conditions even in the presence of toluene, which constitute the main result of this experiment. According to the previous experiments it is clear that a dependency of the gene expression of *xylM* and *xylE* on the presence/absence of oxygen and toluene in the media exists.

In the environment, not always the optimal conditions are found regarding availability of oxygen and carbon sources, thus bacteria have to modulate their gene expression according to the existing conditions. *P. putida* was grown under different initial oxygen concentrations in order to investigate the response of catabolic gene expression under suboptimal growth conditions. Three different oxygen concentrations, 2.73, 1.63 and 0.68 mM, were injected to the flasks at the end of the inoculation process, to avoid any disturbance of the gas phase in the system. A parallel set of flasks in anoxic conditions was also prepared. According to growth curves of *P. putida*, a strong effect was observed depending on different initial oxygen concentrations (Fig. 22a). During the first three hours of growth the cultures with oxygen present in the media had similar growth rates (app. 0.2 h^{-1}). In general, quite low OD values were obtained in this experiment, showing that *P. putida* has a strong dependency on oxygen to growth with toluene as carbon source. In anaerobic conditions growth was not detected (Fig. 22a). The culture with an initial oxygen concentration of 0.68mM reached stationary phase after three hours incubation. The flasks with 1.63 and 2.73 mM injected oxygen continued growing at growth rates of 0.08 and 0.12 h^{-1} , respectively. A correspondence was observed between optical density and toluene degradation in the different experimental conditions (Fig. 22b). Only in the experiment with the highest initial oxygen concentration a complete disappearance of toluene after 12 hours incubation was observed. The concentration of dissolved oxygen was also measured during the experiment. The oxygen measured in the liquid phase in equilibrium conditions was considered as a starting value of dissolved oxygen in the media and not the total injected concentration. Toluene degradation was not observed under anoxic conditions. The measured dissolved oxygen concentrations were very low in all oxic cultures (Fig. 22c). This observation indicates that a fast uptake by bacteria of the available oxygen in the aqueous phase occurred. However, since the oxygen in the gas phase was not measured, it is not possible to estimate the remained oxygen concentration in the complete system. In the case of anaerobic cultures, the dissolved oxygen was also monitored during the complete experiment and it was constantly zero.

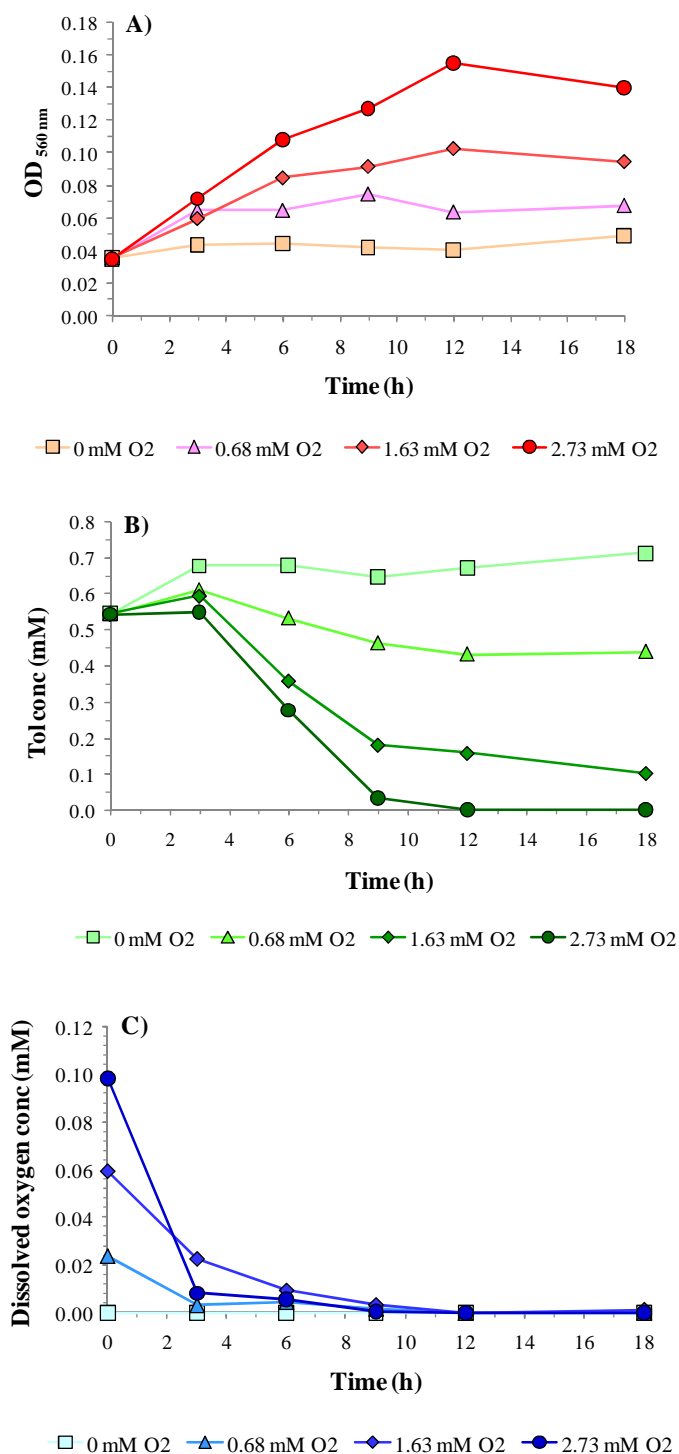

Figure 22. Effect of different initial oxygen concentrations (0, 0.68, 1.63, 2.73 mM) on the (A) Growth (OD_{560 nm}) and (B) Toluene degradation when *P. putida* mt-2 was grown on 0.5 mM toluene. (C) Dissolved oxygen concentrations during degradation of 0.5 mM toluene by *P. putida* mt-2 grown with different initial oxygen concentrations (0, 0.68, 1.63, 2.73mM).

The effect of the different initial oxygen concentrations on the gene expression of the catabolic genes *xyIM* and *xyIE* are shown in Figure 23. For this experiment the zero hours was used as calibrator. According to the toluene degradation curves bacteria were exposed to four different conditions. In anoxic conditions the carbon source was present but the co-substrate oxygen was not available. With 2.7 mM initial oxygen concentration complete toluene degradation took place and only at the end of the experiment both substrates, toluene and oxygen, were not available anymore. When 0.68 mM oxygen was initially injected, toluene was present along the whole experiment but the co-substrate oxygen was limiting at a certain point. The 1.6 mM oxygen concentration represents an intermediate situation, where the effect of decrease in toluene concentration and oxygen depletion was difficult to distinguish.

Different responses in *xyIM* expression were observed according to the different oxygen concentrations injected and each case has to be analysed separately (Fig. 23a). The anoxic cultures showed an up-regulation of *xyIM* at the beginning of the experiments, but at 6 hours of incubation the gene expression was already equal to the initial conditions and after that point a strong down-regulation was observed. However, the up-regulation was low compared to the flasks with oxygen available at the beginning of the experiment. When 2.7 mM oxygen was initially injected an up-regulation of *xyIM* was observed until the 9 hours. When toluene was not detected anymore in the medium no expression of *xyIM* was detected as well (Fig. 23a). The gene expression profile obtained is similar to the profile obtained in aerobic conditions using 0.5 mM toluene as carbon source.

An extended up-regulation in time of *xyIM* was observed when 1.63 mM oxygen was injected at the beginning of the experiment (Fig. 23a). When toluene was still present in the media and dissolved oxygen was not detected anymore an up-regulation of *xyIM* could still be observed. However, after some hours under these conditions gene expression was not detected. This experiment was the first indication that even in the presence of toluene as inductor bacteria did not up-regulate the catabolic gene if oxygen was not present as well.

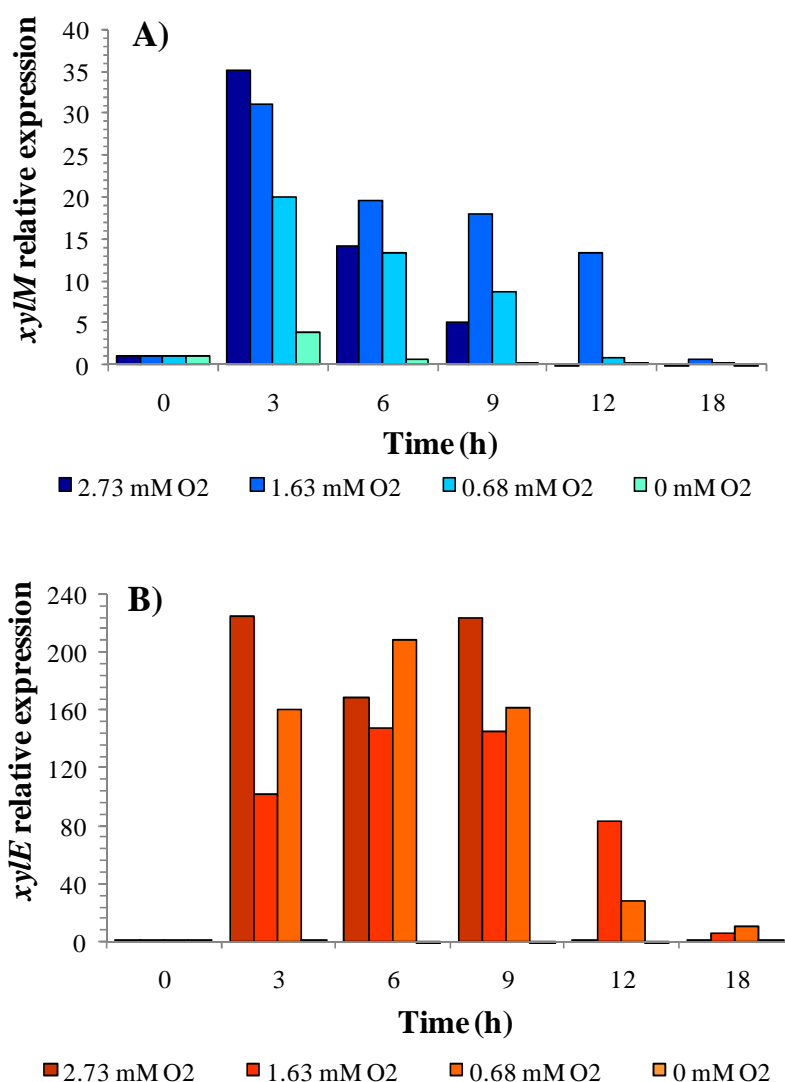

Figure 23. *xylM* (A) and *xylE* (B) relative expression in *P. putida* cultures growing on 0.5 mM toluene and different initial oxygen concentrations (0, 0.68, 1.63, 2.73 mM). The gene expression is relative to the 0h sample. Darker colours represent higher oxygen concentrations.

The clearest effect of the limiting oxygen availability on *xylM* relative expression was observed when 0.68 mM oxygen was initially injected to the cultures. The amount of 0.68 mM injected in these sets of flasks corresponds to microaerophilic conditions (section 3.4). With this initial amount oxygen *P. putida* was able to up-regulate *xylM* for the first 9 hours of the experiment. During this period 14% of the toluene has been consumed and no significant increase in optical density was observed. At 12 hours incubation dissolved oxygen was not detected anymore, no significant toluene degradation occurred as well as cell growth. At this point a strong drop in *xylM* relative

expression occurred. After a prolonged time under the same conditions, no expression of *xyIM* was detected even toluene was present in high concentration. These last set of cultures strongly indicated that when *P. putida* sensed the absence of oxygen, even in the presence of the inductor of the upper pathway, they down-regulate the expression of the initial catabolic gene of the pathway.

Relative expression profiles of *xyIE* looked much different than *xyIM*. In anoxic cultures no up-regulation of *xyIE* was observed (Fig. 23b). The absence of toluene degradation under anoxic conditions led to the absence of metabolites as well and therefore, the *meta*-pathway genes were not induced in these conditions and only a basal expression of *xyIE* was detected. An apparent weaker effect of the availability of oxygen on the gene expression was observed for *xyIE*. In the case of the highest oxygen concentration injected (2.73 mM) *xyIE* was up-regulated during the first 9 hours of the experiment and a sudden drop in gene expression was observed after 12 hours (Fig. 23b). At this point, toluene was completely consumed and also dissolved oxygen was not detected, both factors could cause the drop in gene expression. When 1.63 or 0.68 mM oxygen was injected at the beginning of the experiment similar *xyIE* expression profiles were observed. In both cases, *xyIE* was up-regulated during the whole experiment and only after several hours of absence of oxygen a strong decrease in gene expression was observed (Fig. 23b).

4.3.2. *Thauera aromatica* K172

The experimental set up for the anaerobic model bacteria *T. aromatica* had to be different than *P. putida*, because is known that this bacterium is not able to grow on toluene under aerobic conditions. Therefore, to study the effect of different oxygen concentrations on catabolic gene expression bacteria were grown on toluene under anaerobic conditions for a period of 9 hours. According to previous experiments, both catabolic target genes *bssA* and *bcrA* were highly up-regulated at this time relative to benzoate and acetate expression, respectively. After the 9 hour sample had been taken, 0.68 or 1.63 mM of pure oxygen was injected into the flasks. The effect of the presence of oxygen on the growth and toluene degradation was studied and compared to the anaerobic grown condition (Fig. 24).

The effect of both oxygen concentrations injected to the anaerobic cultures was similar. After one hour that oxygen was injected the first sample was taken and it was possible to observe that growth and toluene degradation stopped. Additionally, denitrifying activity of the cells also ceased after injection of oxygen (data not shown).

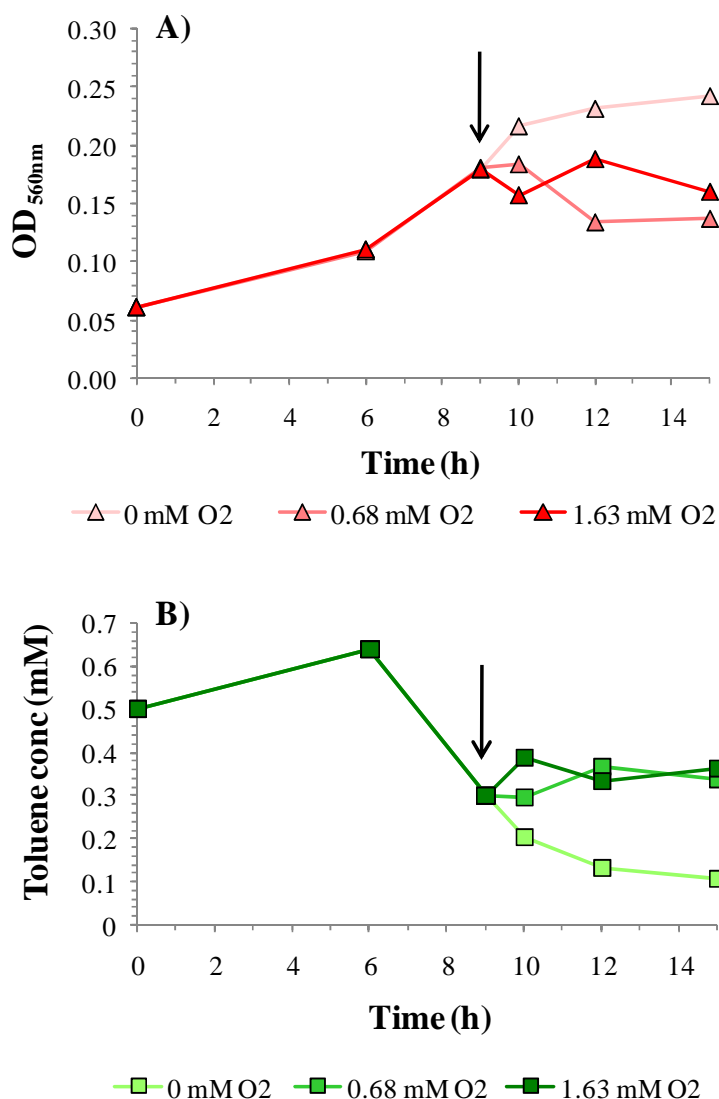

Figure 24. Effect of oxygen on growth (OD 560 nm) (A) and toluene degradation (B) by *T. aromatica* growing on anaerobic conditions and 0.5 mM toluene as carbon source. The point when the oxygen was injected in the cultures is indicated by an arrow.

The effect of the presence of oxygen on the gene expression of the catabolic genes *bssA* and *bcrA* was again studied using real time PCR and the zero hour sample was used as calibrator for the calculation of relative expression (Fig. 25).

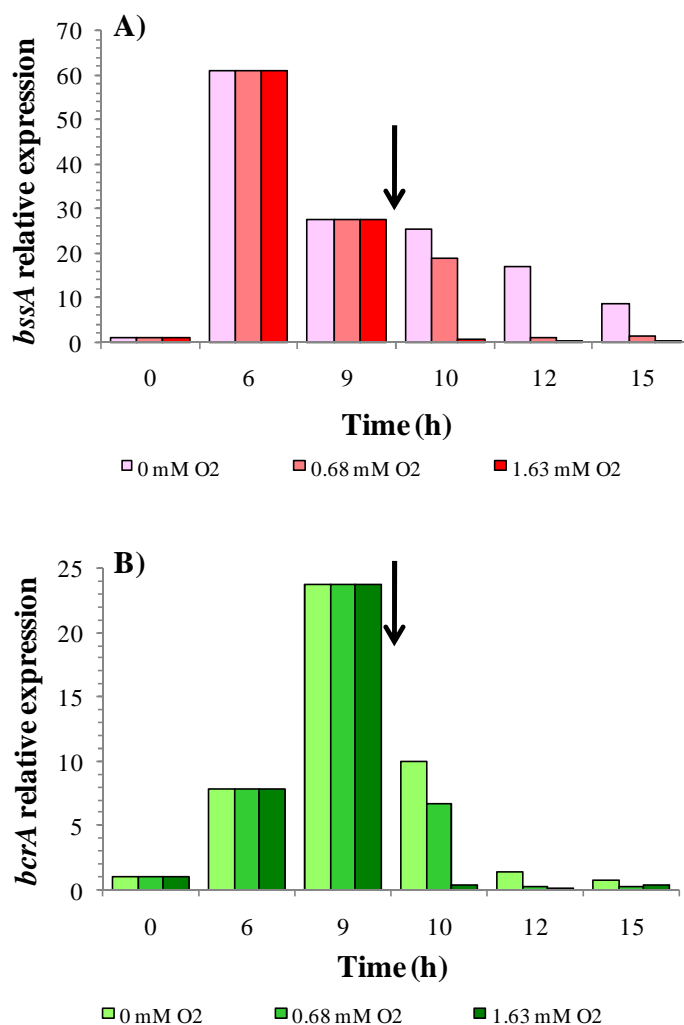

Figure 25. Effect of oxygen injection (0.68 and 1.63 mM) on relative expression of *bssA* (A) and *bcrA* (B) when *T.aromatica* cultures were growing on anaerobic conditions and using 0.5 mM of toluene as carbon source. The gene expression is relative to the 0h sample. Darker colours represent higher oxygen concentrations.

The anaerobic samples, used as control condition, showed an up-regulation of *bssA* during the complete experiment (Fig. 25a). A high up-regulation of *bssA* was observed at 6 hours just before toluene degradation starts, showing that a threshold of enzyme concentration has to be reached by *T. aromatica* to actively degrade toluene.

After nine hours, gene expression showed a gradual decrease until the end of the experiment, which correlates with the degradation of the carbon source (Fig. 24b). Probably because toluene remained present until the end of the experiment *bssA* was up-regulated as well. In samples with lower oxygen (0.68 mM) *bssA* was still up-regulated after one hour of the oxygen injection. Only after 12 hours a drop in gene expression was observed, however, *bssA* still showed basal expression levels (Fig. 25a). When the higher oxygen concentration was injected in *T. aromatica* cultures, a fast response in the gene expression was observed. After one hour that oxygen was injected almost no expression of *bssA* was detected. These results could indicate that the response at enzymatic level is more drastic than at the gene expression level, at least for low oxygen concentrations like 0.68 mM.

During anaerobic growing conditions *bcrA* was up-regulated up to 10 hours and the highest expression was observed after 9 hours of incubation (Fig. 25b). A delay in the maximum of gene expression compared to *bssA* was observed, probably due to the later intermediates formation which up-regulate the *bcrA* gene at high levels. When toluene degradation slowed down, the gene expression of *bcrA* reached the same level like at the beginning of the experiment. The response of *bcrA* expression also showed a dependency on the oxygen concentration injected. When 0.68 mM oxygen was injected in the flasks, a down-regulation was not detected immediately, but at 12 and 15 hours no expression of *bcrA* was detected (Fig. 25b). When a higher oxygen concentration (1.63 mM) was present in the medium a down-regulation of *bcrA* was observed already after 10 hours.

4.4. Effect on catabolic gene expression in *P. putida* mt-2 during oxygen oscillations

In the environment not only different availabilities of oxygen can be observed. In the rhizosphere, for example, bacteria are exposed to oscillation of oxygen concentrations according to the active photosynthesis periods of plants. In order to determine the effect of these oxygen oscillations on gene expression, *Pseudomonas putida* was used as a model bacterium. Unfortunately, difficulties to growth *T. aromatica* on a fermentor

system using a constant supply of toluene as carbon source impeded these kinds of experiments with this anaerobic bacterium.

4.4.1. Batch shaking cultures

In the previous section the need of dissolved oxygen for TOL gene expression could be demonstrated. Subsequently, it was investigated whether *P. putida* mt-2 is able to recover its gene expression after a period in which oxygen is lacking. This was done by simulation of oxic and anoxic periods. The experimental set-up is described in Figure 26.

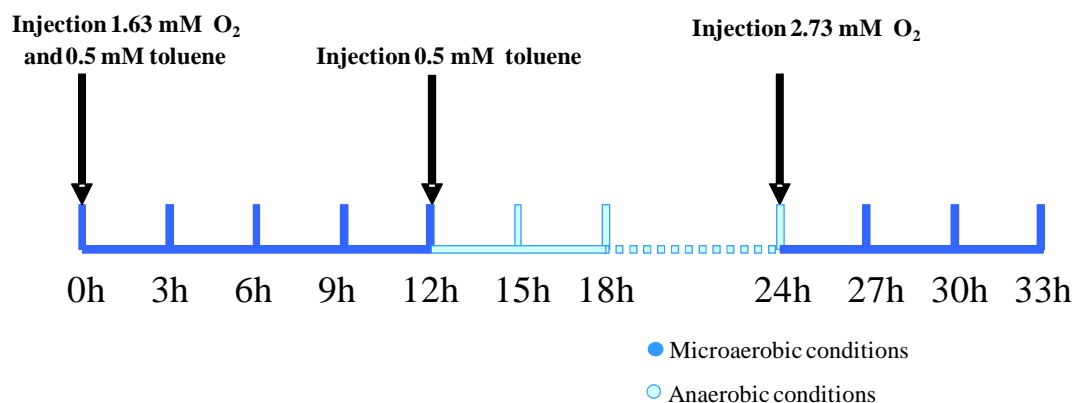

Figure 26. Scheme of the experimental set-up of diurnal oxygen cycle simulation. The 12- and 24-hour samples were taken before injection of additional toluene or oxygen, respectively. Each time sample corresponds to an independent flask.

Bacteria were grown initially in the presence of oxygen. However, the oxygen concentration used (1.63 mM) corresponds to a limiting oxygen concentration according to previous experiments (section 4.3.1). After 12h incubation the consumed oxygen was not replaced, but to avoid starvation, toluene was injected. Consequently, anaerobic conditions arose in which toluene was still present as a carbon source. After 24 hours oxygen was injected, but no additional toluene was added to prevent toxic effects. Each time sample corresponded to one independent flask. Oxygen measurement, toluene concentration, optical density, nitrate and nitrite concentration and ATP content were determined at each sampling time before to harvest the content of the flask to get enough

cells for RNA isolation. The effect of oscillations in oxygen concentration on the gene expression of *xyIM* and *xyIE* were studied using real time PCR.

During the first 12 hours *P. putida* showed a growth rate of 0.08 h^{-1} (Fig. 27). After that, the cell density was stable until 24 hours, when growth continued at a similar rate ($\mu = 0.06 \text{ h}^{-1}$). As expected, the toluene degradation stopped in the absence of oxygen as well as cell growth (Fig. 27). After injection of oxygen at 24 hours, toluene degradation and growth was fast recovered.

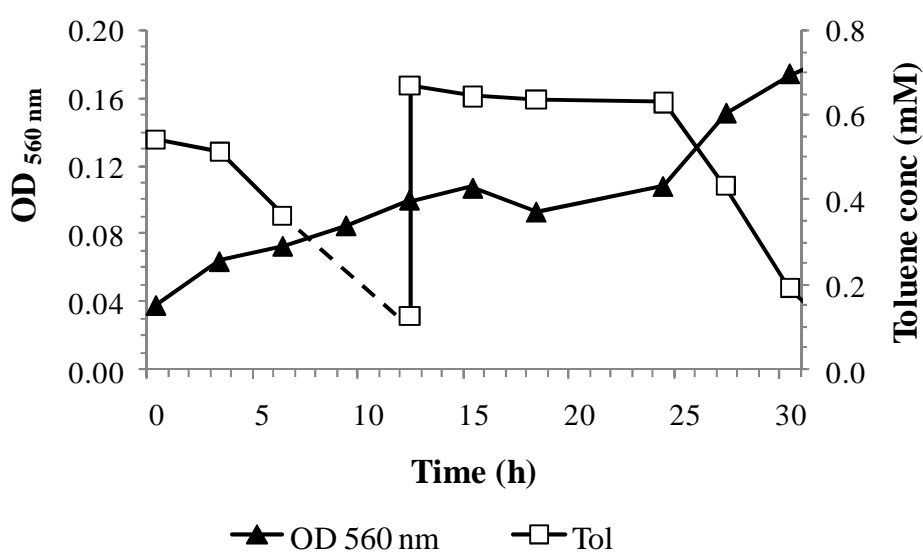

Figure 27. Growth and toluene consumption by *P.putida* during simulation of diurnal cycles of oxygen. OD: optical density, Tol: toluene.

Both catabolic genes *xyIM* and *xyIE* decreased their expression when oxygen was not available anymore in the media (Fig.28a and b). In the case of *xyIM* a down-regulation with respect to the zero hours was observed (Fig. 28a). Relative expression values of *xyIE* are higher than those for *xyIM*, however, a sudden decrease in the gene expression was observed when oxygen was consumed compared to the previous hours values (Fig. 28b). Down-regulation of *xyIE* was observed only after 24 hours. When oxygen was injected in the flasks after twelve hours in anaerobic conditions, both catabolic genes were immediately up-regulated and consequently oxygen as well as toluene was rapidly consumed.

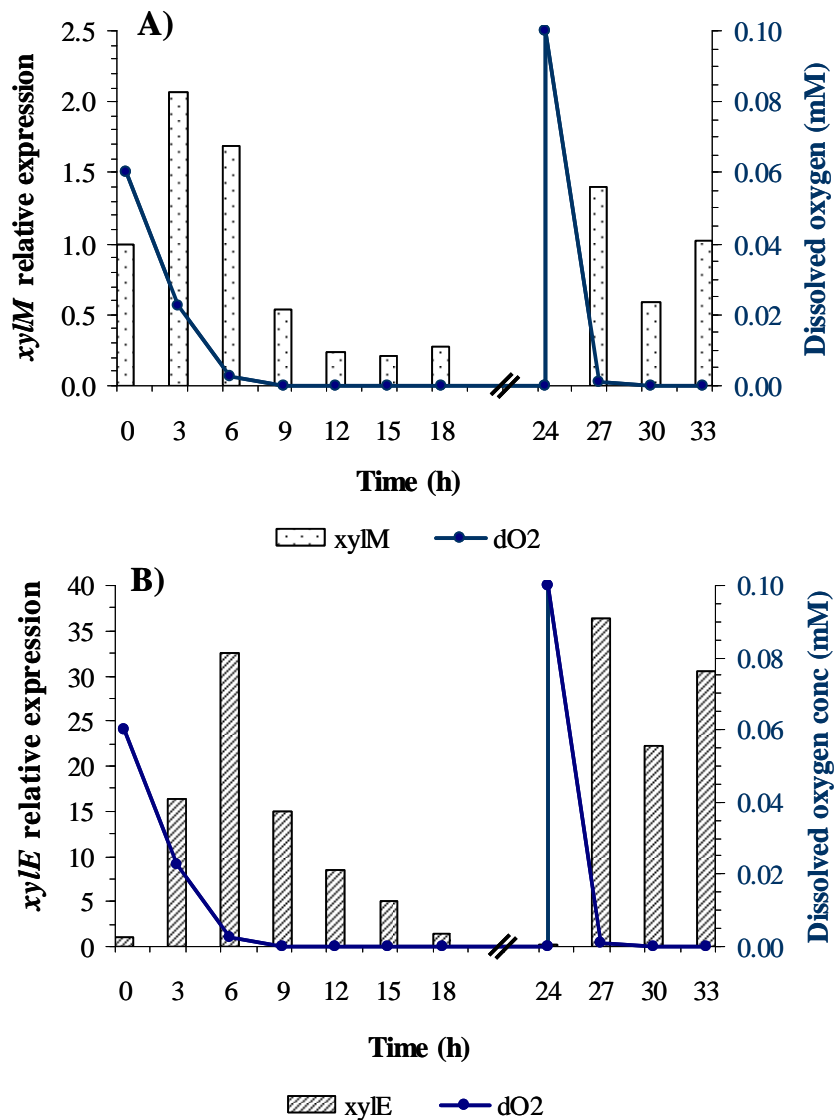

Figure 28. Relative gene expression and oxygen consumption by *P. putida* during simulation of diurnal cycles of oxygen. (A) *xyIM* (B) *xyIE* relative expression, the blue line represents the dissolved oxygen concentration (dO₂). The values of relative gene expression were calculated using an average zero-hour sample.

As mentioned before, media used in this work was initially described for the optimal growth of nitrate reducing bacteria and therefore, nitrate was present as a potential alternative electron acceptor. Some bacteria belonging to the genus *Pseudomonas* are capable of using nitrate as electron acceptor. Thus, it could have been expected that *P. putida* mt-2 can reduce NO₃⁻ to NO₂⁻ under anaerobic conditions.

However, no changes were observed in nitrate or nitrite concentrations in any of the experiments (data not shown). The lack of oxygen as an electron acceptor could influence the energetic state of the bacteria producing the fast decrease in gene expression. Since it has been reported that *P. putida* mt-2 is not able to use nitrate as an alternative electron acceptor because it misses the necessary genes (Velázquez *et al.*, 2006), the nitrate consumption could not be used as bacterial activity indicator. Instead, ATP content was chosen as an indicator of the physiological fitness of cells (Fig. 29).

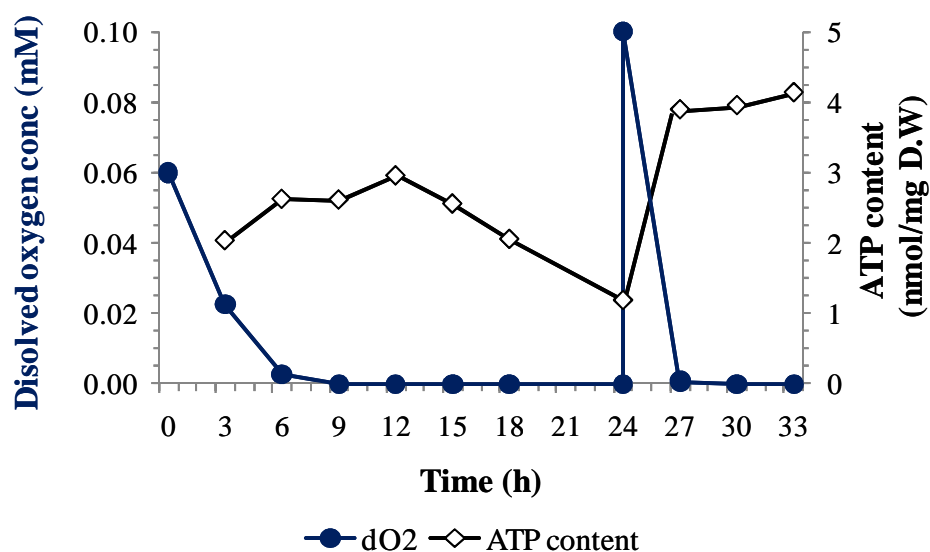

Figure 29. ATP content and dissolved oxygen concentration of *P. putida* cells during simulation of diurnal cycles of oxygen.

The ATP content of the cells was relatively stable the first 12 hours of incubation. After that point a slow decrease in ATP level was observed and at 24 hours of incubation the minimum value (1 nmol/mg D.W) was reached. Three hours after oxygen was not detected anymore in the media the ATP content started to decrease. Together with the decrease in ATP, toluene was not degraded anymore and growth stopped, which was characterised by a stationary phase in the growth curve (Fig. 27). The decrease in relative expression of both catabolic TOL genes was observed earlier than the decrease in ATP content of the cells. After injection of oxygen at 24 hours incubation bacteria reacted very fast increasing their gene expression, reassumed toluene degradation and, as a consequence increasing ATP content level. This fast response of bacteria and the increase in bacterial activity caused that the level of oxygen dropped to zero after an additional six

hours. However, a stable level in the ATP content of the cells was observed until the end of the experiment. Therefore, it can be concluded that the decrease in gene expression of *xylM* and *xylE* was faster than the decrease in ATP content of the cells and that most probably the response of bacteria is due to a sensing of the lack of oxygen than an energetic stimulus.

4.4.2. Continuous Fermentation

In order to have more homogeneous sampling and controlled conditions, a continuous culture of *P. putida* mt-2 growing on toluene was set up in a 5 L fermentor (Fig. 10). Diurnal cycles of oxygen were simulated, using two aerobic/anaerobic cycles that remained for several hours. In this way, the response of catabolic genes to oxygen oscillations could be monitored. Bacteria were continuously feed with toluene as carbon source (1.1 ± 0.1 mM, measured in the liquid phase), which was provided as saturated air phase to create aerobic conditions in the reactor or as toluene saturated nitrogen for anaerobic conditions. A dilution rate of 0.13 h^{-1} was applied during the aerobic periods and 0.0075 h^{-1} during the anoxic cycles. Samples were taken periodically in order to measure optical density and toluene concentration in the liquid phase (Fig 30a). An increase in optical density was observed during the first aerobic period. Toluene degradation started after inoculation, which is shown by a decrease in its concentration. During first anaerobic period bacterial growth stopped and toluene accumulated as no consumption took place (Fig. 30a). Once the aerobic cycle started again, the growth continued at the same rate as before ($\mu = 0.16 \text{ h}^{-1}$) and toluene decreased again to remain constant during the complete cycle. A similar effect as described before was observed in the second anaerobic cycle.

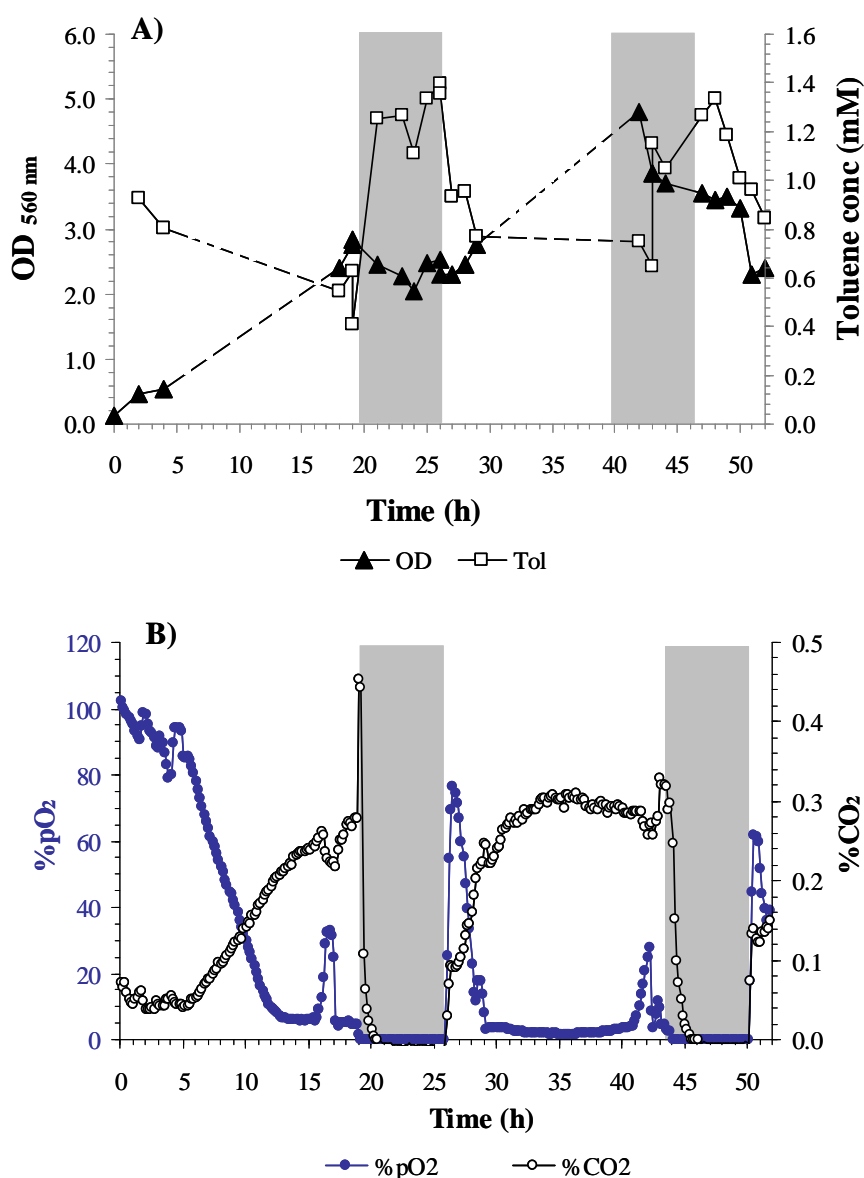

Figure 30. Growth and toluene degradation (A) and pO₂ and CO₂ percentage (B) during continuous fermentation of *P. putida* mt-2 using toluene as carbon source. The anaerobic cycles are indicated by the gray areas.

The percentage of formed CO₂ and the dissolved oxygen percentage were monitored online during the complete experiment (Fig. 30b). The same behaviour was observed for both parameters during the repetition of the cycles (Fig. 30b). During aerobic conditions *P. putida* cells consumed oxygen as indicated by the low percentage of dissolved oxygen concentration. A continuous increase in the CO₂ percentage was observed during the aerobic cycles. When CO₂ production started to increase exponentially, bacteria started to consume oxygen at high rates. At the beginning of both

anaerobic cycles, when dissolved oxygen was replaced by nitrogen, the percentage of CO₂ dropped drastically until undetectable values. However, once oxygen was available again after 26 hours, the CO₂ production recovered rapidly, in accordance to toluene and oxygen consumption.

During fermentation experiments samples were taken to measure the ATP content of the cells during the different oxic/anoxic cycles. The obtained results (Fig. 31) showed a constant level of ATP content of the cells during the aerobic cycles with values between 2 to 3 nmol ATP per mg dry weight of cells.

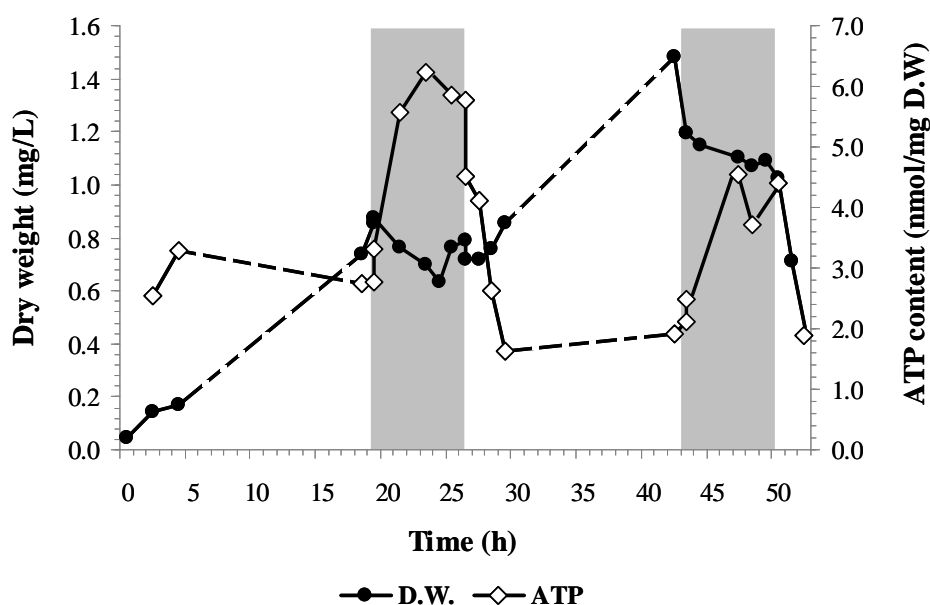

Figure 31. ATP content and dry weight of *P. putida* mt-2 during continuous fermentation using toluene as carbon source. The anaerobic cycles are represented by the gray areas.

During the anaerobic phase, an increase of the ATP content of the cells was observed (Fig. 31). This observation suggests that the increase in ATP content correspond to a non-equilibrated production and consumption of ATP, respectively. Together with the lack of oxygen, an increase in toluene concentration was also observed, which could be involved in the effect on ATP content as well. In figure 31 the growth is represented by the dry weight of the cells or biomass, which correlates with optical density measurements.

The relative gene expression of the catabolic genes *xyIM* and *xyIE* was monitored at different point of the fermentations, using the zero hours as calibrator for the calculations. For both catabolic genes there was a correspondence between the level of expression and the oxygen availability in the media (Fig. 32a and b).

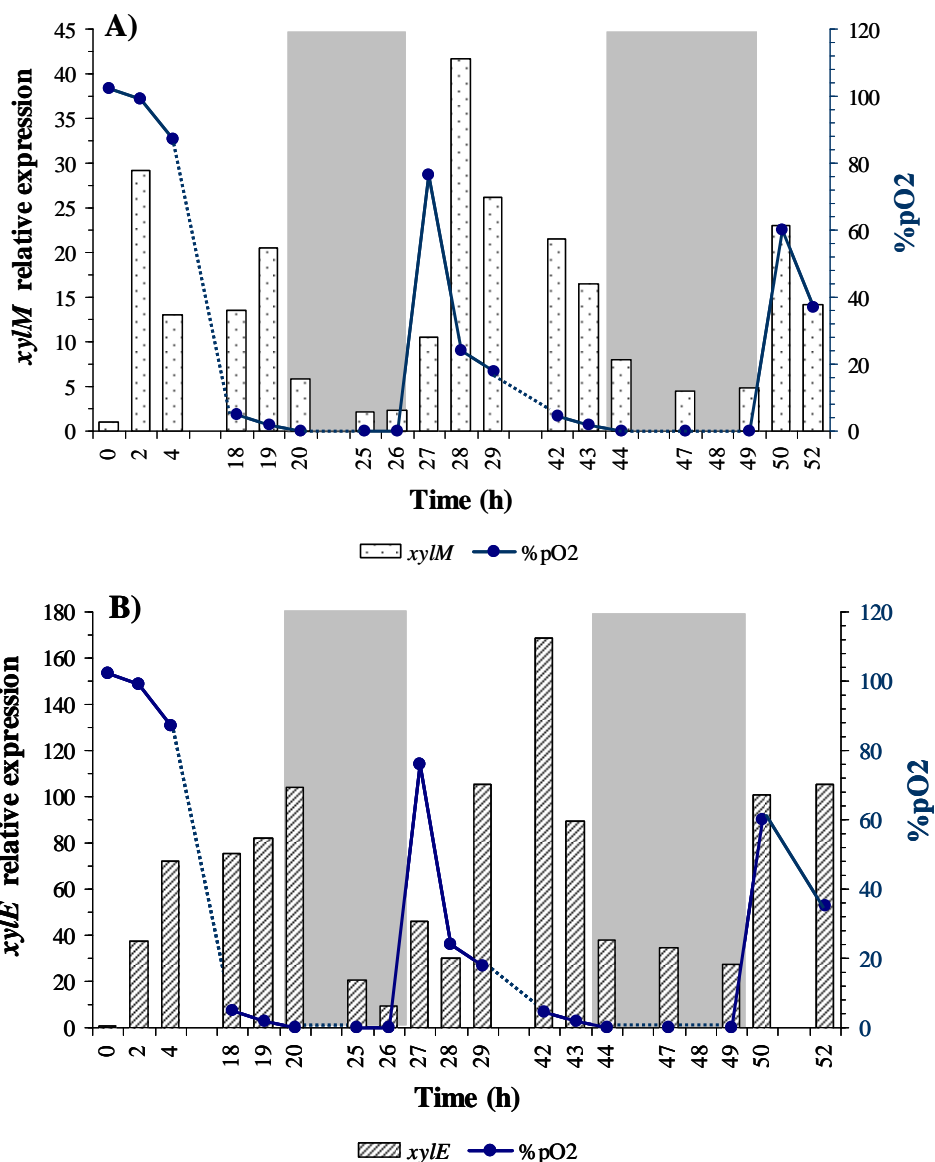

Figure 32. Dissolved oxygen concentration and *xyIM* (A) or *xyIE* (B) expression by *P. putida* mt-2 in a continuous fermentation. The values of relative gene expression were calculated using an average zero-hour sample. The anaerobic cycles are indicated by the gray areas.

In general, no down-regulation was observed during the anaerobic periods, like those observed in previous batch experiments. During continuous fermentation

experiments, bacteria were permanently fed with toluene and the media was constantly refreshed. Therefore, cells were in optimal growth conditions and with high energetic status with the transcriptional machinery working at optimal rates. This fact probably allows the cells to keep a certain transcriptional level of the catabolic genes when toluene is present in the media but when there is lack of oxygen. As soon as oxygen was not available anymore in the media, the level of gene expression dropped drastically for the case of *xylM* and to a lesser extent for *xylE*. However, no complete down-regulation of the genes was observed. Moreover, when the aerobic conditions were recovered again, bacteria quickly responded and the gene expression increased again.

With the last experiments it was shown that a clear effect of oxygen availability on catabolic gene expression exists. Obviously, there is a decrease in the level of gene expression when bacteria detect that oxygen is not present in the media. However, another important observation is that *P. putida* could modulate its gene expression levels according to the presence or absence of oxygen in the media. Even after certain time of sub-optimal growth conditions, like anoxic conditions, bacteria are able to respond activating their transcriptional machinery to take advantage when the optimal conditions are restored. This corresponds to an important ability considering that in the environment the availability of nutrients, electron acceptors and in this case also co substrates are permanently changing.

4.5. Effect of oxygen fluctuation on catabolic gene expression in a mixed culture formed by *P. putida* mt-2 and *T. aromatica* K172

In the environment, bacteria not only have to cope with changes in environmental conditions. The presence of other microorganisms in their niches makes them interact, cooperate or compete for certain substrates or electron acceptor. In order to study the catabolic gene expression regarding oxygen oscillations in a more complex scenario, a mixed culture was created using *P. putida* mt-2 and *T. aromatica* K172. This mixed culture was submitted to different conditions regarding oxygen availability and substrate concentration and the expression of catabolic genes *xylM*, *xylE*, *bssA* and *bcrA* from the respective bacteria was studied using real time PCR.

The goal of this experiment was to study how the catabolic gene expression is modulated in aerobic and anaerobic toluene degraders according to the oscillations in oxygen availability and toluene presence/absence, conditions that are created during bacterial degradation. The experiment started in anaerobic conditions to allow the growth of *Thauera aromatica*. Later on, desirable amounts of oxygen and toluene were injected to the cultures to create diurnal oxygen oscillations and also to keep the carbon source always available for bacteria. A scheme of the experimental set-up is described in Figure 33.

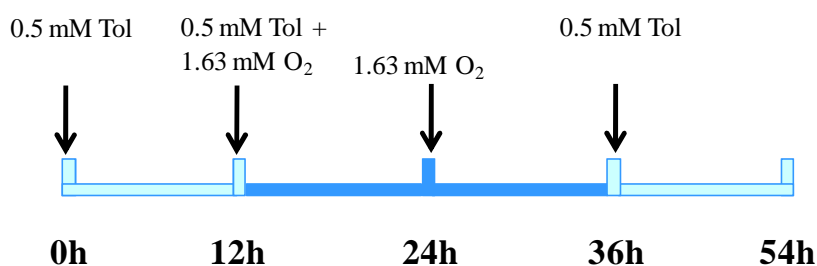

Figure 33. Scheme of experimental set-up of oxygen cycle simulation in an aerobic/anaerobic culture. The 12, 24 and 36 hour samples were taken before injection of additional toluene or oxygen, respectively. Each time sample corresponds to an independent flask.

During the experiment OD, toluene concentration in the media and dissolved oxygen concentration were measured (Fig 34a and b). During the first 9 hours of the experiments an increase in optical density was observed; since the conditions in the media were anaerobic probably because of the growth of *T. aromatica* (Fig. 34a). After the first injection of oxygen, bacterial growth ceased for a while and it was reassumed later on, probably due to the growth of *P. putida*. After the second injection of oxygen OD values remained stable until the end of the experiment, even after a new injection of carbon source. The stability at the end of the experiment is probably due to equilibrium between cells dying and the ones that can grow on those defined conditions. It is necessary to remember that each sample point corresponds to an independent flask, and therefore certain variation could have occurred between samples, even when they received the same treatment. On the other hand, optical density does not tell so much in this case because is not possible to distinguish between the two bacteria.

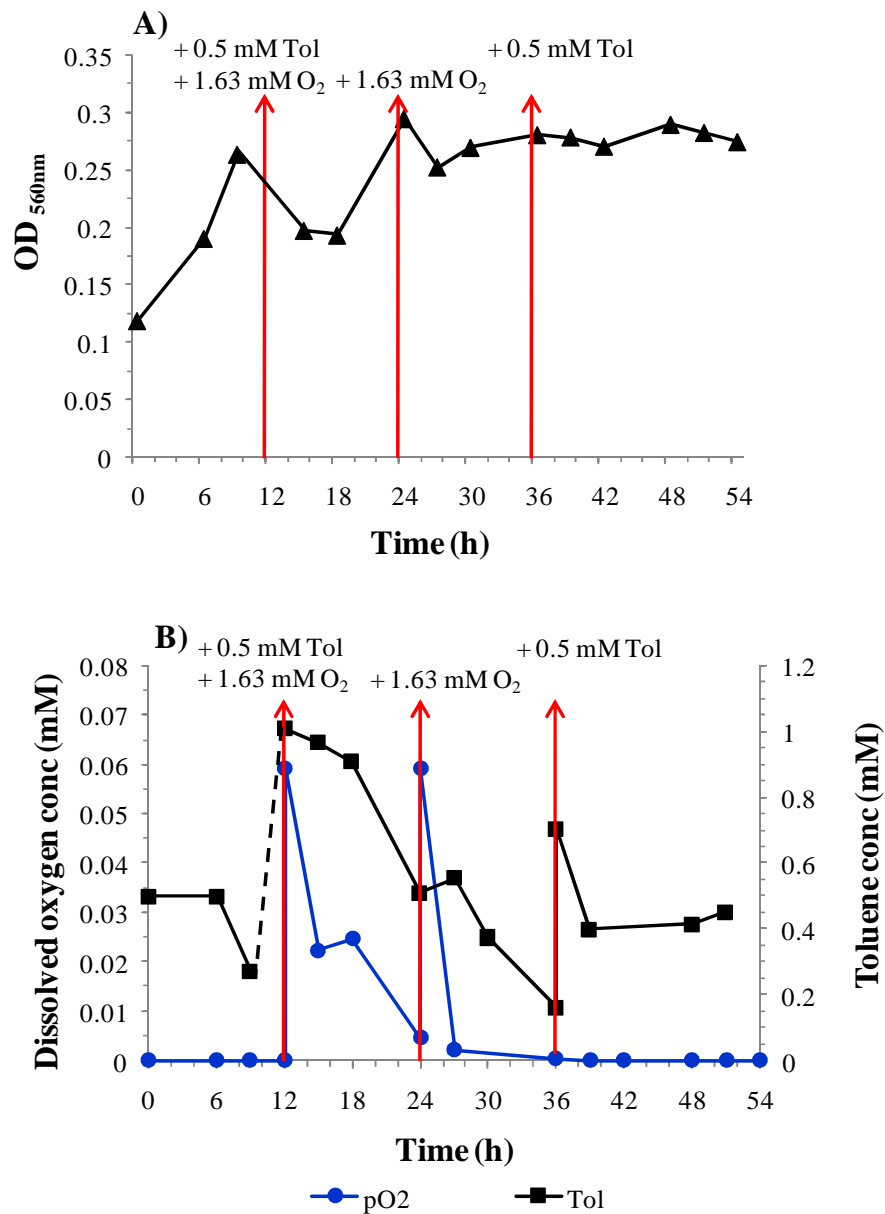

Figure 34. Growth (OD 560 nm) (A), and toluene and dissolved oxygen concentration (B) during the growth of a mixed culture formed by *P. putida* mt-2 and *T. aromatica* using toluene as carbon source. At the beginning of the experiment the conditions were anaerobic and 0.5 mM of toluene was injected. Oxygen and/or toluene were injected during the experiment; the points of injections are indicated by the red lines on the graph.

The first 6 hours of the anaerobic phase toluene was almost not degraded (Fig 34b). After the injection of toluene and oxygen the concentration of the carbon source decreased approximately 50% after 12 hours. With the second injection of oxygen, toluene was almost completely consumed; approximately 20% of the toluene remained in

the media. A new injection of toluene was done after 36 hours of incubation, but oxygen was not injected this time. After 3 hours of incubation 44% of the toluene was consumed, but after that point no significant change in toluene concentration was detected. Dissolved oxygen concentration correlates with toluene degradation (Fig. 34b). After the first injection of oxygen a gradual decrease was observed in the dissolved oxygen concentration in concomitance with the decrease on toluene in the medium. After the second injection of toluene, a much faster decrease in dissolved oxygen concentration was observed. Fifteen hours after the last injection of oxygen, the dissolved oxygen concentration remained constant at zero and toluene was not degraded anymore. Even after anoxic conditions were recovered, *T. aromatica* was not able to degrade toluene after exposure to oxygen for two cycles of 12 hours each. However, further experiments should be done to assure that *T. aromatica* does not recover an activity after a prolonged anaerobic period.

Relative gene expression of catabolic genes from both model bacteria was studied by real time PCR, using the zero hours as calibrator. In general, a sequence of transient events in catabolic gene expression was observed. According to the gene expression profiles, *xyIM* was not detectable at the beginning of the experiment during anoxic conditions (Fig. 35a). After the first injection of oxygen, after 15 hours, *xyIM* was highly up-regulated. In concomitance with a decrease in dissolved oxygen concentration a decrease in the up-regulation level was observed, but after the second injection of oxygen the high levels were recovered again (Fig. 35a). After 36 hours again a decrease in the up-regulation level was observed, probably due to the decrease in the concentrations of both toluene and dissolved oxygen. After a new injection of toluene, the level of up-regulation was recovered again. From the 39 hours until the end of the experiment there was a decrease in the up-regulation of *xyIM* to reach finally basal expression, which correlated with the absence of oxygen in the system when toluene was still present in the media. A similar expression profile was observed for *xyIE* (Fig. 35b). However, after the last injection of toluene no increase in up-regulation was observed, probably because complete degradation of toluene was not possible since dissolved oxygen was not present anymore.

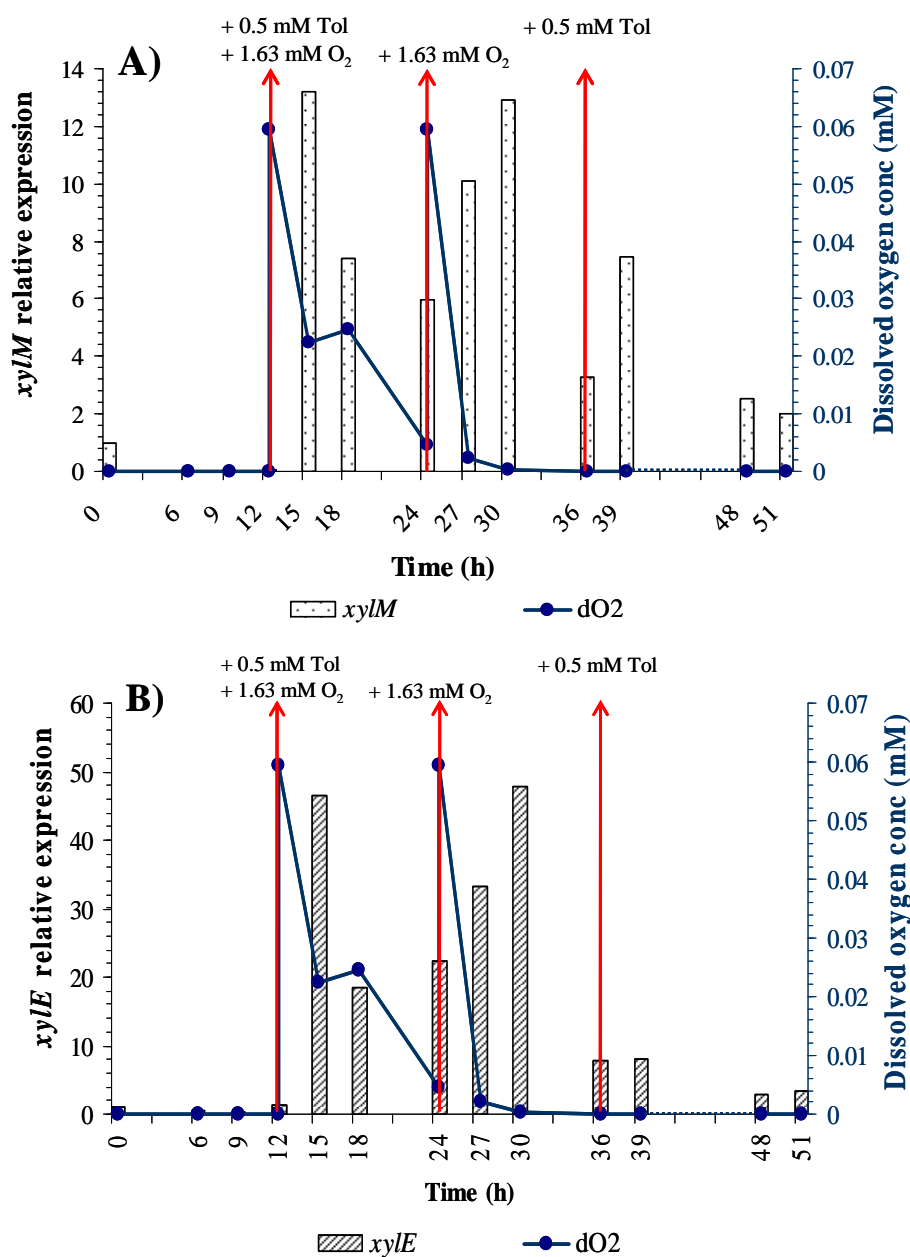

Figure 35. Gene expression profile of *P. putida* mt-2 and dissolved oxygen concentration in a mixed culture. (A) *xyIM*, (B) *xylE*. The bars represent the relative expression values of the corresponding genes calculated using an average zero-hour sample as calibrator. The blue lines represent the dissolved oxygen concentration (dO₂). Oxygen and/or toluene were injected during the experiment; the points of injections are indicated by the red lines on the graph.

Expression of catabolic genes of *T. aromatica* showed an opposite profile than for the aerobic toluene degrader (Fig. 36).

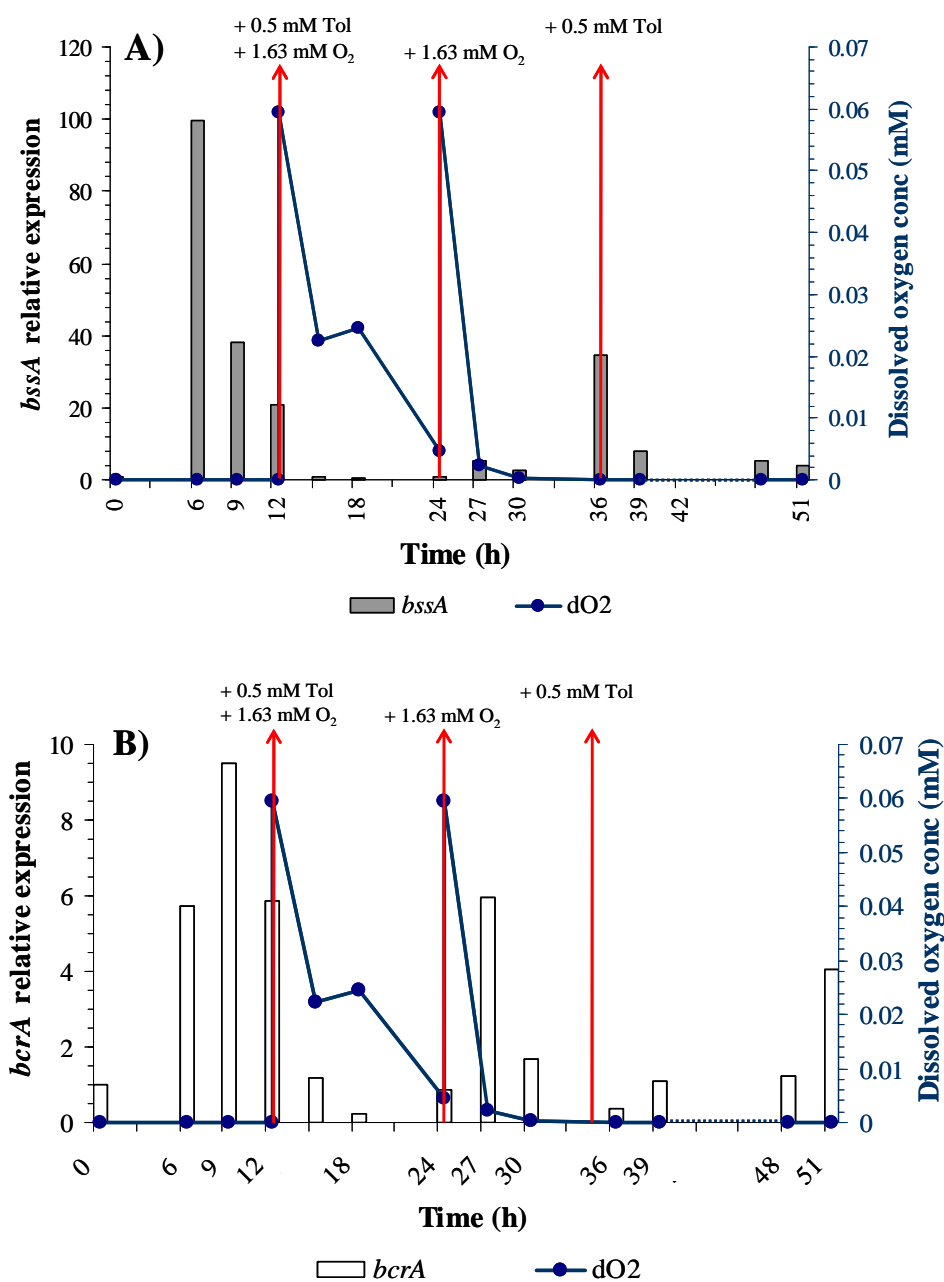

Figure 36. Gene expression profile of *T. aromatica* and dissolved oxygen concentration in a mixed culture. (A) *bssA*, (B) *bcrA*. The bars represent the relative expression values of the corresponding genes calculated using an average zero-hour sample as calibrator. The blue lines represent the dissolved oxygen concentration (dO₂). Oxygen and/or toluene were injected during the experiment; the points of injections are indicated by the red lines on the graph.

In the case of the catabolic gene *bssA* of the anaerobic bacteria *T. aromatica* a strong up-regulation was observed during the first anaerobic cycle. After injection of oxygen at 12 hours of incubation, the gene expression dropped until basal level in a very

short time. Again here was possible to see the fast response of the gene expression in anaerobic toluene degraders to the presence of oxygen. However, during the experiment down-regulation of the gene *bssA* was not observed. In the points where dissolved oxygen concentration was low a slight increase in up-regulation of *bssA* was observed. At 36 hours, when the dissolved oxygen concentration was almost zero and a new injection of carbon source was done *bssA* showed a strong up-regulation. It seems that fast up-take of oxygen by *P. putida* restored the optimal conditions of gene expression for *T. aromatica*. The up-regulation of *bssA* remained until the end of the experiment (Fig. 36a). However, the toluene concentration remained constant, indicating that even if *T. aromatica* have the gene expression machinery active they are not able to resume toluene degradation, at least after 12 hours after anaerobic conditions were restored. The nitrate and nitrite measurements indicate that during the two anoxic periods, reduction of nitrate and nitrite production were taking place, however, after the two oxic cycles reduction of nitrate was slower (data not shown). This is a second indication, together with the gene expression, that *T. aromatica* recover activity when growth conditions turned favourable.

In the case of the gene *bcrA*, after up-regulation during the first 12 hours of anaerobic incubation, a down-regulation was observed during the first aerobic cycle (Fig 36b). Surprisingly, up-regulation of the gene was observed at 27 and 30 hours, at the same points where *bssA* was up-regulated. However, when toluene was injected the second time no up-regulation of *bcrA* was observed; even when *bssA* was up-regulated. Only at the end of the experiment *bcrA* was slightly up-regulated. Therefore, it is not possible to discharge the idea that *T. aromatica* is only very slowly recovering the degradative capacities.

These last experiments showed that both, aerobic and anaerobic bacteria are able to modulate the expression of catabolic genes depending on the oxygen availability. Additionally, both bacteria kept their physiological fitness even under adverse growth conditions. This fact allowed them to react quickly, with respect to catabolic gene expression, once the favourable growth conditions are restored regarding oxygen concentration.

5. DISCUSSION

In the environment, microorganisms experience many different stresses and can be exposed to several signals which vary in time. Today, one of the key issues in environmental microbiology research is to understand how bacteria respond and regulate their metabolic pathways to allow bacteria to adapt to environmental changes. One of the environmental factors that soil microbes must cope with is fluctuating oxygen concentrations. In this work, the effect of oxygen availability on catabolic gene expression of toluene degrader bacteria was studied using real time PCR and the relative quantification method.

Relative quantification using Real time PCR has become a common tool to quantify gene expression changes (Kühner et al., 2005; Chini et al., 2007; Gunsch et al., 2007; Lee et al., 2008). Two models for relative quantification have been described: the $\Delta\Delta C_t$ method (Livak and Schmittgen, 2001; Schmittgen and Livak, 2008) and an adaptation of this method known as relative-fold method (Pfaffl, 2001) (eq. 2). The last method was used in this work and it requires a previous optimisation of the method because the efficiencies of the PCR reaction could varied between sets of primers. Our target genes corresponded to *xylM* and *xylE* in the case of *P. putida* and *bssA* and *bcrA* in the case of *T. aromatica* involved in aerobic and anaerobic toluene degradation pathways, respectively. Additionally, a housekeeping gene should be used to normalise between different samples. The reference gene used in this work was 16SrRNA of both investigated bacteria, which is one of the often used housekeeping genes for prokaryotes (Devers et al., 2004). A calibrator has to be defined in this method, and it corresponds to a single reference sample used as the basis for relative-fold increase in the expression study. Each of the normalised target values is divided by the calibrator normalised target value to generate the relative levels of expression. Thus, the normalised amount of target is a unit-less number and all quantities are expressed relative to the calibrator (Pfaffl, 2001; Sharkey et al., 2004). An advantage of this method is that relative quantification does not require the use of standards curves, which makes its use easier and faster (Pfaffl, 2001). However, some important facts have to be considered when using this quantification method. The expression level of different genes cannot be compared since absolute concentrations of each mRNA are not determined (Shalel-Levanon et al., 2005). Additionally, the selection of the calibrator condition is a very important issue to consider

because the relative changes in expression level will be highly dependent on the calibrator as it was shown in this thesis. For example, when the expression of *xylM* and *xylE* was monitored in time using the fermentor system to grow *P. putida* on toluene as carbon source, the zero hour was used as calibrator. The zero hour sample was taken immediately after inoculation of bacteria in the fermentor containing already toluene in the media. When the zero hours was measured by real time PCR always high Ct values were obtained, which were similar to values of the samples when degradation already started, and therefore relative gene expression values were also low. Between inoculation of bacteria in the fermentor and taking the zero-hour sample, around 20 minutes passed, which was obviously enough time for the bacteria to induce at a high level at least the first gene in the pathway (Dominguez-Cuevas et al., 2006). Therefore, especially in the case of the fermentations done in this work, the definition of a common zero hour was very important as well as to define the calibrator according to the objective of each experiment.

Pseudomonas putida (Nozaki et al., 1963) and *Thauera aromatica* (Tschech and Fuchs, 1987; Anders et al., 1995) are well known toluene degraders (Parales et al., 2008) under aerobic and anaerobic conditions, respectively. In the attempt to describe optimal growth condition for each bacterium it was observed that *P. putida* could tolerate much higher concentrations of toluene (3.3 mM) in the media than *T. aromatica* (1.6 mM). This phenomenon has been already described, establishing that anaerobic bacteria are about 3 times more sensitive to organic solvents than aerobic bacteria (Duldhardt et al., 2007). Toluene, *o*- and *p*- xylene are inducers of the TOL pathway and substrates for *P. putida* (Kunz and Chapman, 1981).

The pWW0 plasmid, harboured by *P. putida* mt-2, is the archetypical TOL plasmid. Hence, in the past 20 years the functioning and regulation of the catabolic genes encoded by this plasmid has been intensively studied (Ramos et al., 1997; Cases and de Lorenzo, 2001; Dominguez-Cuevas et al., 2006; Parales et al., 2008). When *Pseudomonas putida* was grown in mineral media with toluene as carbon source the target genes, *xylM* and *xylE*, were up-regulated with the concomitant toluene degradation. These results are in agreement with those observed previously in *P. putida* mt-2 grown on citrate and exposed to toluene (Dominguez-Cuevas et al., 2006). Another study also showed up-regulation of the upper-operon and the *meta*-pathway genes using *m*-xylene as

inducer (Velázquez et al., 2006). Additionally, the presence of nitrate in the medium seems not to have a negative effect on gene expression, which is in agreement with the observation that the presence of nitrate does not affect toluene degradation rate of *P. putida* PaW1 (Leahy and Olsen, 1997). Moreover, an enhanced activity of Pu promoter, controlling upper pathway transcription, has been observed in the presence of nitrate as nitrogen source in cells growing on mineral medium and succinate as carbon source (Velázquez et al., 2006). However, the gene expression profiles followed in time of *P. putida* growing on toluene have not been described before. Differences in the gene expression were observed depending on the initial concentration of toluene. The lowest toluene concentration (0.5 mM) applied was consumed very fast by *P. putida* and simultaneous up-regulation of *xylM* and *xylE* was observed. When bacteria completely degraded the toluene, the inducer of the upper pathway and carbon source was not present anymore and bacteria decreased the expression of *xylM* as well as *xylE*. The opposite occurred in the case of the higher toluene concentration (2.7 mM) applied where the genes remained up-regulated during the complete experiment because toluene is also present until the end of the experiment. The *meta*-pathway operon, which *xylE* belongs to, is regulated in two different ways. First, toluene is able to induce also the *meta*-pathway due to the recognition of Ps1 by XylR, the regulator of the upper pathway (Ramos et al., 1997). Second, the presence of the metabolite benzoate, formed during toluene degradation, is a direct inducer of the lower-pathway of the TOL plasmid (Ramos et al., 1997). Therefore, an up-regulation of *xylE* was observed since the beginning of the experiment and when metabolites start to accumulate due to toluene degradation an even higher relative expression of the gene was observed. Velázquez *et al.* (2006) also observed a certain delay in induction of the *meta*-operon genes when *P. putida* growing on citrate was exposed to *m*-xylene.

During anaerobic growth of *T. aromatica* on 0.5 mM toluene, nitrate consumption and turnover of intermediary formed nitrite was slower compared to denitrification observed with 4 mM acetate or 5 mM benzoate growth (Fig. 19). With acetate as well as with benzoate the middle exponential growth phase coincided with complete depletion of nitrate and maximum formation of nitrite. In the case of toluene as substrate for *T. aromatica* an incomplete degradation was observed. After 24 hours, 0.05 mM toluene was still detected in the media. According to the graphs and the stoichiometric equation

of denitrifying bacterial toluene oxidation (eq. 3) *T. aromatica* had an excess of electron acceptor to completely degrade the carbon source since it only needs 3.6 mM NO_3^- to degrade 0.5 mM toluene.



It was observed that a new injection of C-source would allow bacteria to resume the growth (data not shown), indicating that bacteria were physiologically fit and had appropriate conditions to continue growing except for the presence of toluene.

In the case of the anaerobic toluene degrader *T. aromatica*, there is still a lack of knowledge on regulation of gene expression. Most of the work has been done at the protein level, either measuring enzyme activity or using 2D-gel profiles (Heider et al., 1998; Leuthner and Heider, 2000). The results from this work confirmed that *bssA* gene is induced by toluene growing cells under nitrate reducing conditions (Heider et al., 1998). This work additionally gives a hint about the gene expression during toluene degradation, showing that the highest expression of *bssA* occurred when cells entered exponential growth phase and decreased when toluene was degraded. The common intermediate in aromatic hydrocarbon degradation under anaerobic conditions is benzoyl-CoA (Heider et al., 1998; Heider and Rabus, 2008). It has been observed that benzoyl-CoA reductase, the first enzyme in the benzoyl-CoA degradation pathway, has activity in the presence of the aromatic substrates: benzoate, phenol, 4-hydroxybenzoate, 2-aminobenzoate and toluene (Heider et al., 1998). In accordance, in this work an up-regulation of *bcrA* in toluene or benzoate growing cells was observed. Moreover, when the relative induction of *bcrA* in toluene growing cells was calculated using benzoate growing cells as calibrator, no difference in the gene expression was observed. This result showed that expression of *bcrA* is similar during toluene or benzoate degradation. A two-component system involved in regulation of toluene metabolism in *T. aromatica* has been identified called *tdiSR* (Leuthner and Heider, 1998a). This system is predicted to sense toluene and induce *bss* and *bbs* operon, which encode the enzymes for the transformation of toluene to benzoyl-CoA. However, not so much research has been further done on this regulatory system in *T. aromatica*. More detailed regulatory studies have been published using the

related strain *Aromatoleum aromaticum* strain EbN1, which is able to degrade several aromatic compounds, including ethylbenzene, toluene, *p*-cresol, and phenol, under anoxic conditions (Rabus and Widdel, 1995). Together with complete genome sequencing of strain EbN1 a detailed proteomic analysis of substrate-dependent regulation of individual degradation pathways has been performed (Kühner et al., 2005; Rabus et al., 2005a; Wöhlbrand et al., 2007). In this bacterium, cells grown on toluene up-regulated *bss* and *bbs* operon genes as well as ethylbenzene-related genes and some additional enzymes with unknown function until now (Kühner et al., 2005; Heider and Rabus, 2008).

The effect of oxygen on aerobic aromatic hydrocarbon degradation has previously been studied (Shaler and Klečka, 1986; Olsen et al., 1995; Leahy and Olsen, 1997; Alagappan and Cowan, 2004; Shim et al., 2005). These studies established that oxygen half-saturation values for aerobic heterotrophs which use oxygen as electron acceptor is lower than when oxygen is additionally used as co-substrate for enzymes involved in the degradation, like during toluene degradation by *P. putida* mt-2. However, the effect of oxygen on expression of the catabolic TOL genes has not been extensively investigated. The first experiments done in this work investigated the effect of the absence of oxygen on the catabolic genes *xylM* and *xylE*. Relative to the “normal” expression conditions (oxic and toluene as substrate) a repression of the mentioned genes was detected, even in the presence of succinate in the media. Similar results were observed by Velázquez *et al.* (2006), using DNA microarrays and *P. putida* cells grown on *m*-xylene and exposed to anaerobic conditions. Several species and strains belonging to the genus *Pseudomonas* are able to use nitrate as electron acceptor anaerobically (Madigan and Martinko, 2006). However, *Pseudomonas putida* mt-2 is only able to use nitrate as nitrogen source via conversion to nitrite and finally to ammonia (Velázquez et al., 2006). Thus, it is not surprising a non activation of the catabolic genes under anaerobic conditions and the presence of nitrate in the media.

According to the stoichiometric reaction for aerobic toluene degradation (eq. 4) the amounts of oxygen injected (2.73 mM, 1.63 mM and 0.683 mM as total concentrations) in the experiment were not enough to completely mineralize toluene until CO₂ and H₂O.



For the complete conversion of 0.5 mM toluene 4.5 mM O₂ would be, in theory, necessary. Nevertheless, a complete disappearance of toluene was observed with the highest injected oxygen concentration (2.73 mM). However, the values of the equation do not take into consideration the biomass production in growing systems (Evans et al., 1991). In that case less amount of oxygen is necessary to completely degrade toluene. Cultures with an initial oxygen concentration of 2.73 mM showed a growth yield of approximately 0.6 g (dry weight) g toluene⁻¹, indicating that part of the carbon source was incorporated into the cell biomass (data not shown). On the other hand, it has been previously described that during growth on 4-hydroxybenzoate, protocatechuate was excreted in large amounts by *P. putida* KT2442 under oxygen limiting conditions (at oxygen tensions below 0.02 mM) (Arras et al., 1998). This indicates that under oxygen limiting conditions incomplete degradation of toluene may occur.

A clear effect of the oxygen depletion was observed on the gene expression of *xyIM* and *xyIE*. After three hours under anoxic conditions slight up-regulation of *xyIM* was observed. Later on, the expression of the gene was not detected anymore. It seems that the energetic status of cells growing on succinate, which were used as inoculum, allowed *P. putida* cells to initially up-regulate *xyIM* when toluene was present in the media but oxygen was lacking. However, this up-regulation is really low compared to cultures with oxygen available at the beginning of the experiment. On the other hand, no up-regulation of *xyIE* was observed under anoxic conditions. These results are partially in disagreement with the results reported by Velázquez *et al.* (2006), where a switch from aerobic conditions to anaerobiosis repressed the genes of the complete TOL pathway. However, in their experiments *P. putida* cells pre-grown on *m*-xylene were transferred to anoxic mineral medium containing succinate, and therefore the tested conditions differ considerably with this work (Velázquez et al., 2006).

A strong effect on catabolic gene expression was observed when a concentration of 0.68 mM oxygen was initially injected in *P. putida* mt-2 cultures using toluene as carbon source. After 12h incubation when dissolved oxygen was not detected anymore a down-regulation of *xyIM* as well as *xyIE* occurred, even if toluene was still present in the medium. Due to the possible decrease on the upper-pathway enzymes because of the lack

of oxygen, the amount of metabolites formed maybe also reduced. Therefore, the effect observed on *xylE* expression could be an indirect effect because of the lack of oxygen. Arras *et al.* (1998) demonstrated for *P. putida* KT2442 cells growing on benzoate that at a dissolved oxygen concentration of 0.01 mM, the diffusion of oxygen into the cytoplasm is still higher than the oxygen consumption of oxygenases. It means that the decrease in growth rates is not due to limiting oxygen diffusion but by the high oxygen affinity constant values of the catechol-1,2-dioxygenase (0.6 mg/L) (Shaler and Klečka, 1986).

The present work also showed that *P. putida* is able to modulate the expression of the catabolic TOL genes according to the presence or absence of oxygen in the media. The expression of *xylM* and *xylE* were recovered after anoxic periods. As soon as oxygen is lacking and toluene was still present in the medium, the genes were down-regulated and when oxygen is present again, fast recovery of gene expression arises. Little is known about the signals and regulation mechanisms controlling the responses when switching between oxic and anoxic conditions although recently some regulatory genes have been found and characterised. The most studied oxygen-dependent regulation systems are FNR (fumarate and nitrate reduction) and the Arc (aerobic respiratory control) system in *E. coli* (Sawers, 1999). Both FNR and ArcA are transcription factors and their DNA-binding activities are activated in anaerobic cells. FNR appears to sense molecular oxygen directly through a redox-sensitive iron-sulphur cluster in the protein (Sawers, 1999). Homologous proteins to FNR have been described in the genus *Pseudomonas* (Galimand *et al.*, 1991; Zimmermann *et al.*, 1991; Sawers, 1999). The *anr* gene, also present in the genome of *P. putida* KT2440 (Nelson *et al.*, 2002), showed 51% identity with the *fnr* of *E. coli* at amino acid level (Zimmermann *et al.*, 1991). Recently, it has been reported that *anr* has an important role coordinating the levels of different terminal oxidases (Cyo and CIO oxidases) in *P. putida* as a response to oxygen availability (Ugidos *et al.*, 2008). Additionally, it has been described that Cyo oxidase is involved in modulation of the expression of *PalkB* promoter (alkane oxidation) under different oxygen availabilities (Dinamarca *et al.*, 2003). Thus, according to the results obtained in this work it is clear that *P. putida* mt-2 posses a regulation system, which modulates the expression of catabolic genes according to the oxygen availability in the media.

The facultative anaerobic bacterium *T. aromatica* was strongly affected by the presence of oxygen in the medium during growth on toluene as carbon source under

denitrifying conditions. The growth, toluene degradation and denitrification were immediately stopped after the injection of oxygen to the flasks, independently on the concentration of oxygen. It is known that the contact of the glycyl radical enzyme benzyl succinate synthase with oxygen leads to the cleavage of the polypeptide chain in the radical site, and an irreversible inactivation of the enzyme (Heider and Rabus, 2008). Similar results were described in *Clostridium acetobutylicum* where exposure of anaerobic cultures to oxygen prevented the net synthesis of DNA, RNA and protein, suggesting that oxygen could inhibit critical enzymes involved in those processes and arrest growth (O'Brien and Morris, 1971). Therefore, it is not surprising that toluene degradation stopped so fast after addition of oxygen to the media. When only a small amount of oxygen (0.68 mM, as total concentration) was added, the expression of *bssA* and *bcrA* was not repressed immediately, but after at least one hour. Maybe, bacteria keep the catabolic genes up-regulated for a certain time in order to react rapidly to possible changes in the unfavourable conditions. On the other hand, it has been described that several factors can influence the lifetimes of mRNAs in bacteria, and that their stability can vary considerably (Deana and Belasco, 2005). Indeed, Hermuth *et al.* (2002) have detected different processing times for mRNA transcripts containing *bssD* or *bssC*, using RNA prepared from *T. aromatica* cultures growing exponentially on toluene and exposed to rifampicin for different time periods. mRNA species beginning in front of *bssD* had faster disappearance than those beginning in front of *bssC*. The latest were detected even after 30 min of incubation with rifampicin when, in contrast, the mRNA transcripts containing *bssD* were not detected after a couple of minutes (Hermuth *et al.*, 2002). A similar result was found for *Paracoccus denitrificans*, which is able to growth heterotrophically in aerobic or nitrate reducing conditions. When anaerobic cultures of *P. denitrificans* were switched back to aerobic respiration, denitrification of the cells stopped at once, although mRNA levels for the individual denitrification enzymes decreased slightly and not abruptly to their aerobic, non-induced levels (Baumann *et al.*, 1996). The response mechanism to oxygen availability is not known in *T. aromatica*. However, it is presumed the existence of at least one oxygen regulatory protein, but this has not been described so far (Heider and Fuchs, 1997). However, the presence of a transcriptional activator, AcpR, which allows the expression of *bzd* for benzoate degradation under

anoxic conditions in *Azoarcus* sp. strain CIB has been described (Durante-Rodríguez et al., 2006).

It has been suggested by Duetz *et al.* (1996) that the energy status of the cell could play a key role in the repression of the TOL genes, this implies that oxygen depletion imposes an energy limitation on the cells and this causes a decrease in expression of the TOL genes. In the mentioned study the activity of benzylalcohol dehydrogenase was 20% to 35% of the activity measured in glucose grown cultures (carbon limiting conditions) in the presence of the gratuitous inducer *o*-xylene and under oxygen limiting conditions (Duetz et al., 1996). However, the activity of catechol-2,3-dioxygenase was 200 to 300% of the activity in the control conditions mentioned above (Duetz et al., 1996). Therefore, that low energetic status of the cells produces those effect results is a confusing argument. In order to test if the down-regulation of catabolic genes is directly produced by a decrease in the ATP levels of the cells, the energetic state of *P. putida* and *T. aromatica* was measured through ATP content. Chemical energy of cells is primarily stored in ATP, which is considered the most important molecule for capturing and transferring free energy in cells (Russell and Cook, 1995). The ATP content by itself does not always reflect the actual energy status, which is more exactly expressed by the energy charge. However, the cellular ATP content does indicate the cellular energetic state (Neumann et al., 2006), and therefore is a parameter suited for the quantification of active biomass. After a period of six hours in anoxic conditions, the ATP content of *P. putida* cells started to decrease slowly. However, a decrease in gene expression of *xylM* and *xylE* was observed much earlier. Thus, the general fitness of the cells is a clear indication that oxygen is a direct agent affecting the expression of TOL genes. Most probably the regulation does not occur directly on TOL regulation machinery but indirectly by oxygen sensors present in *P. putida* mt-2. Also, *T. aromatica* kept its ATP content constant until the end of the experiment, six hours after oxygen was injected in the media. Fact is that catabolic genes are down-regulated when depletion of oxygen is the only change in growth conditions, and in the case of *P. putida* as soon as this change is reverted, up-regulation of catabolic genes occurs immediately as well as increase of ATP content of the cells. These results showed that respiratory chain processes are not affected immediately after the lack or presence of oxygen, respectively for the aerobic and anaerobic bacteria. The long-term decrease in ATP content of *P. putida* is probably part

of the response to extended anoxic period, where bacteria utilize energy to produce stress proteins or use it as maintenance energy (Russell and Cook, 1995).

In the mixed culture of *P. putida* and *T. aromatica* it was possible to observe that both bacteria could modulate their gene expression according to the availability of oxygen. In the first anoxic cycle no expression of the aerobic genes was observed. However, immediately after the injection of oxygen and additional doses of toluene *xylM* and *xylE* were up-regulated. After several hours in anoxic conditions, after two aerobic cycles, the expression of catabolic genes was still detected. In the case of *T. aromatica*, up-regulation of *bssA* and *bcrA* was observed in the first anoxic cycle in concomitance with toluene degradation. After the second aerobic cycle when oxygen was injected to the cultures, dissolved oxygen was rapidly depleted and up-regulation of *bssA* and *bcrA* was again observed. After six hours in anoxic conditions and a new injection of toluene in the media *bssA* was highly up-regulated while *bcrA* expression increases. This experiment showed that also anaerobic bacteria have the potential to recover gene expression after having been exposed to oxygen for a long period, when conditions turn oxic again. Previously, it was observed in a mixed culture growing on benzoate as carbon source and submitted to oxic/anoxic cycles that aerobic ring-cleavage enzymes were maintained for up-to 9 hours of anoxic conditions. Likewise, benzoyl-CoA reductase is maintained for up to 9 hours under aerobic conditions (Deniz et al., 2006). However, in this work no toluene degradation was observed during the last anoxic cycle and until the end of the experiment. To try to explain this observation additional experiment should have been done using *T. aromatica* separately to submit bacteria to anoxic/oxic cycles similar to the continuous fermentation experiments done with *P. putida*. However, the capacity to cope with oxygen stress has been described in other anaerobic bacteria. The strict anaerobic bacterium *Desulfovibrio gigas* appears to be suitably equipped to cope with oxygen stress, and possesses well-known antioxidative stress systems, it can perform very efficient NTP synthesis from the aerobic metabolism of internal reserves, and it is able to resume growth even after long periods of exposure to oxygen (Fareleira et al., 2003).

It was clearly observed in this work that both aerobic and anaerobic bacteria catabolic gene expression respond to availability of oxygen. It is generally known that bacteria have maximally combined and exploited the limited transcription factors to

integrate transcriptional regulation, which allow bacteria to respond not only to the presence of a catabolic substrate but also to different physiological signals or status (Cases and de Lorenzo, 2001). How this regulation is organised needs to be investigated in future biochemical and molecular biological studies. Additionally, it was possible to observe that bacteria can arrest their growth and activity during non-optimal growth conditions, in this case regarding oxygen availability, and activate gene expression when environmental conditions are favourable again.

The presented work provides new knowledge about the response of pollutant-degrading bacteria to potential *in situ* environmental conditions regarding oxygen availability. Further investigation should focus on the study of modulation of catabolic gene expression in more complex systems, where oxygen gradients and oscillation occurred naturally, e.g. in planted systems. The results obtained in this work represent an important issue in order to optimise and/or design appropriate remediation techniques. Previous works have suggested that bacterial cultures growing under cyclic aerobic-anoxic conditions constitute an effective method to remove aromatic hydrocarbons, for example, in reactor systems (Ma and Love, 2001; Deniz *et al.*, 2006; Wang *et al.*, 2007). The fact that aerobic and anaerobic bacteria showed stability and physiological fitness under unfavourable conditions, regarding oxygen availability, gives the possibility to think about new approaches for bioremediation. In that sense, the bioengineering of polluted sites focusing on oxygen fluctuations could be an alternative to accelerate biodegradation processes.

6. REFERENCES

- Abril, M.A., Michan, C., Timmis, K.N., and Ramos, J.L. (1989) Regulator and enzyme specificities of the TOL plasmid-encoded *upper* pathway for degradation of aromatic hydrocarbons and expansion of the substrate range of the pathway. *J Bacteriol* **171**: 6782-6790.
- Adams, P.S. (2006) Data analysis and reporting. In *Real Time PCR (BIOS Advanced Methods)*. Dorak, M.T. (ed). New York: Taylor & Francis Group, pp. 39-61.
- Alagappan, G., and Cowan, R.M. (2004) Effect of temperature and dissolved oxygen on the growth kinetics of *Pseudomonas putida* F1 growing on benzene and toluene. *Chemosphere* **54**: 1255-1265.
- Altenschmidt, U., and Fuchs, G. (1991) Anaerobic degradation of toluene in denitrifying *Pseudomonas* sp.: indication for toluene methylhydroxylation and benzoyl-CoA as central aromatic intermediate. *Arch Microbiol* **156**: 152-158.
- Altenschmidt, U., and Fuchs, G. (1992) Anaerobic toluene oxidation to benzyl alcohol and benzaldehyde in a denitrifying *Pseudomonas* strain. *J Bacteriol* **174**: 4860-4862.
- Amann, R., Fuchs, B.M., and Behrens, S. (2001) The identification of microorganisms by fluorescence in situ hybridisation. *Curr Opin Biotechnol* **12**: 231-236.
- Amann, R.I., Ludwig, W., and Schleifer, K.H. (1995) Phylogenetic identification and in situ detection of individual microbial cells without cultivation. *Microbiological Reviews* **59**: 143-169.
- Anders, H.J., Kaetzke, A., Kampfer, P., Ludwig, W., and Fuchs, G. (1995) Taxonomic position of aromatic-degrading denitrifying Pseudomonad strains K 172 and KB 740 and their description as new members of the genera *Thauera*, as *Thauera aromatica* sp. nov., and *Azoarcus*, as *Azoarcus evansii* sp. nov., respectively, members of the beta subclass of the *Proteobacteria*. *Int J Syst Bacteriol* **45**: 327-333.
- Andreoni, V., and Gianfreda, L. (2007) Bioremediation and monitoring of aromatic-polluted habitats. *Appl Microbiol Biotechnol* **76**: 287-308.
- Arras, T., Schirawski, J., and Uden, G. (1998) Availability of O₂ as a substrate in the cytoplasm of bacteria under aerobic and microaerobic conditions. *J Bacteriol* **180**: 2133-2136.
- Arya, M., Shergill, I.S., Williamson, M., Gommersall, L., Arya, N., and Patel, H.R.T. (2005) Basic principles of real-time quantitative PCR. *Expert Rev. Mol. Diagn* **5**: 209-219.
- Assinder, S.J., and Williams, P.A. (1990) The TOL plasmids: Determinants of the catabolism of toluene and the xylenes. *Adv. Microb. Physiol* **31**: 1-69.
- Baumann, B., Snozzi, M., Zehnder, A.J., and Van Der Meer, J.R. (1996) Dynamics of denitrification activity of *Paracoccus denitrificans* in continuous culture during aerobic-anaerobic changes. *J Bacteriol* **178**: 4367-4374.
- Baun, A., Reitzel, L.A., Ledin, A., Christensen, T.H., and Bjerg, P.L. (2003) Natural attenuation of xenobiotic organic compounds in a landfill leachate plume (Vejen, Denmark). *J. Contam. Hydrol* **65**: 269-291.

- Beller, H.R. (2002) Analysis of benzylsuccinates in groundwater by liquid chromatography/tandem mass spectrometry and its use for monitoring in situ BTEX biodegradation. *Environ Sci Technol* **36**: 2742-2728.
- Beller, H.R., Kane, S.R., Legler, T.C., and Alvarez, P.J. (2002) A real-time polymerase chain reaction method for monitoring anaerobic, hydrocarbon-degrading bacteria based on a catabolic gene. *Environ Sci Technol* **36**: 3977-3984.
- Beller, H.R., Spormann, A.M., Sharma, P.K., Cole, J.R., and Reinhard, M. (1996) Isolation and characterization of a novel toluene-degrading, sulfate-reducing bacterium. *Appl Environ Microbiol* **62**: 1188-1196.
- Biegert, T., Fuchs, G., and Heider, J. (1996) Evidence that anaerobic oxidation of toluene in the denitrifying bacterium *Thauera aromatica* is initiated by formation of benzylsuccinate from toluene and fumarate. *Eur J Biochem* **238**: 661-668.
- Boll, M., and Fuchs, G. (1995) Benzoyl-coenzyme A reductase (dearomatizing), a key enzyme of anaerobic aromatic metabolism. ATP dependence of the reaction, purification and some properties of the enzyme from *Thauera aromatica* strain K172. *Eur J Biochem* **234**: 921-933.
- Boll, M., Fuchs, G., and Heider, J. (2002) Anaerobic oxidation of aromatic compounds and hydrocarbons. *Curr Opin Chem Biol* **6**: 604-611.
- Breese, K., Boll, M., Alt-Morbe, J., Schagger, H., and Fuchs, G. (1998) Genes coding for the benzoyl-CoA pathway of anaerobic aromatic metabolism in the bacterium *Thauera aromatica*. *Eur J Biochem* **256**: 148-154.
- Brune, A., Frenzel, P., and Cypionka, H. (2000) Life at the oxic-anoxic interface: microbial activities and adaptations. *FEMS Microbiol Rev* **24**: 691-710.
- Burlage, R.S., Hooper, S.W., and Sayler, G.S. (1989) The TOL (pWWO) Catabolic Plasmid. *Appl Environ Microbiol* **55**: 1323-1328.
- Camara, B., Strompl, C., Verbarq, S., Sproer, C., Pieper, D.H., and Tindall, B.J. (2007) *Pseudomonas reinekei* sp. nov., *Pseudomonas moorei* sp. nov. and *Pseudomonas mohnii* sp. nov., novel species capable of degrading chlorosalicylates or isopimaric acid. *Int J Syst Evol Microbiol* **57**: 923-931.
- Cases, I., and de Lorenzo, V. (2001) The black cat/white cat principle of signal intergration in bacterial promoters. *The EMBO Journal* **20**: 1-11.
- Cases, I., and de Lorenzo, V. (2005) Promoters in the environment: transcriptional regulation in its natural context. *Nat Rev Microbiol* **3**: 105-118.
- Cavalca, L., Dell-Amico, E., and Andreoni, V. (2004) Intrinsic bioremediability of an aromatic hydrocarbon-polluted groundwater: diversity of bacterial population and toluene monooxygenase genes. *Appl Microbiol Biotechnol* **64**: 576-587.
- Cebon, A., Norini, M.P., Beguiristain, T., and Leyval, C. (2008) Real-Time PCR quantification of PAH-ring hydroxylating dioxygenase (PAH-RHD α) genes from Gram positive and Gram negative bacteria in soil and sediment samples. *J Microbiol Methods* **73**: 148-159.
- Chakraborty, R., and Coates, J.D. (2004) Anaerobic degradation of monoaromatic hydrocarbons. *Appl Microbiol Biotechnol* **64**: 437-446.

References

- Chini, V., Foka, A., Dimitracopoulos, G., and Spiliopoulou, I. (2007) Absolute and relative real-time PCR in the quantification of *tst* gene expression among methicillin-resistant *Staphylococcus aureus*: evaluation by two mathematical models. *Lett Appl Microbiol* **45**: 479-484.
- Coates, J.D., Chakraborty, R., and McInerney, M.J. (2002) Anaerobic benzene biodegradation - a new era. *Res Microbiol* **153**: 621-628.
- Da Silva, M.L., and Alvarez, P.J. (2007) Assessment of anaerobic benzene degradation potential using 16S rRNA gene-targeted real-time PCR. *Environ Microbiol* **9**: 72-80.
- Deana, A., and Belasco, J.G. (2005) Lost in translation: the influence of ribosomes on bacterial mRNA decay. *Genes Dev* **19**: 2526-2533.
- Deniz, T., Cinar, O., Marques, A.C., and Grady, C.P., Jr. (2006) The effect of cyclic aerobic-anoxic conditions on biodegradation of benzoate. *Water Environ Res* **78**: 340-352.
- Devers, M., Soulas, G., and Martin-Laurent, F. (2004) Real-time reverse transcription PCR analysis of expression of atrazine catabolism genes in two bacterial strains isolated from soil. *J Microbiol Methods* **56**: 3-15.
- Díaz, E. (2004) Bacterial degradation of aromatic pollutants: a paradigm of metabolic versatility. *Int Microbiol* **7**: 173-180.
- Dinamarca, M.A., Aranda-Olmedo, I., Puyet, A., and Rojo, F. (2003) Expression of the *Pseudomonas putida* OCT plasmid alkane degradation pathway is modulated by two different global control signals: evidence from continuous cultures. *J Bacteriol* **185**: 4772-4778.
- Dominguez-Cuevas, P., Gonzalez-Pastor, J.E., Marques, S., Ramos, J.L., and de Lorenzo, V. (2006) Transcriptional tradeoff between metabolic and stress-response programs in *Pseudomonas putida* KT2440 cells exposed to toluene. *J Biol Chem* **281**: 11981-11991.
- Drew, M.C., He, C.J., and Morgan, P.W. (2000) Programmed cell death and aerenchyma formation in roots. *Trends Plant Sci* **5**: 123-127.
- Dua, M., Singh, A., Sethunathan, N., and Johri, A.K. (2002) Biotechnology and bioremediation: successes and limitations. *Appl Microbiol Biotechnol* **59**: 143-152.
- Duetz, W.A., Marques, S., Wind, B., Ramos, J.L., and Van Andel, J.G. (1996) Catabolite repression of the toluene degradation pathway in *Pseudomonas putida* harboring pWW0 under various conditions of nutrient limitation in chemostat culture. *Appl Environ Microbiol* **62**: 601-606.
- Duldhardt, I., Nijenhuis, I., Schauer, F., and Heipieper, H.J. (2007) Anaerobically grown *Thauera aromatica*, *Desulfococcus multivorans*, *Geobacter sulfurreducens* are more sensitive towards organic solvents than aerobic bacteria. *Appl Microbiol Biotechnol* **77**: 705-711.
- Durante-Rodríguez, G., Zamarro, M.T., García, J.L., Díaz, E., and Carmona, M. (2006) Oxygen-dependent regulation of the central pathway for the anaerobic catabolism of aromatic compounds in *Azoarcus* sp. strain CIB. *J Bacteriol* **188**: 2343-2354.
- EEA (2005) Progress in management of contaminated sites (CSI 015). *European Environmental Agency-Assessment published Jul 2005*.
- El Fantroussi, S., and Agathos, S.P. (2005) Is bioaugmentation a feasible strategy for pollutant removal and site remediation? *Curr Opin Microbiol* **8**: 268-275.

- Evans, P.J., Mang, D.T., and Young, L.Y. (1991) Degradation of toluene and *m*-xylene and transformation of *o*-xylene by denitrifying enrichment cultures. *Appl Environ Microbiol* **57**: 450-454.
- Fareleira, P., Santos, B.S., Antonio, C., Moradas-Ferreira, P., LeGall, J., Xavier, A.V., and Santos, H. (2003) Response of a strict anaerobe to oxygen: survival strategies in *Desulfovibrio gigas*. *Microbiology* **149**: 1513-1522.
- Fleige, S., Walf, V., Huch, S., Prgomet, C., Sehm, J., and Pfaffl, M.W. (2006) Comparison of relative mRNA quantification models and the impact of RNA integrity in quantitative real-time RT-PCR. *Biotechnol Lett* **28**: 1601-1613.
- Galimand, M., Gamper, M., Zimmermann, A., and Haas, D. (1991) Positive FNR-like control of anaerobic arginine degradation and nitrate respiration in *Pseudomonas aeruginosa*. *J Bacteriol* **173**: 1598-1606.
- Gallegos, M.T., Marqués, S., and Ramos, J.L. (1996) Expression of the TOL plasmid *xyIS* gene in *Pseudomonas putida* occurs from a σ^{70} -dependent promoter or from σ^{70} - and σ^{54} -dependent tandem promoters according to the compound used for growth. *J Bacteriol* **178**: 2356-2361.
- Grbic-Galic, D., and Vogel, T.M. (1987) Transformation of toluene and benzene by mixed methanogenic cultures. *Appl Environ Microbiol* **53**: 254-260.
- Grotzschel, S., Koster, J., and de Beer, D. (2004) Degradation of 2,4-dichlorophenoxyacetic acid (2,4-d) by a hypersaline microbial mat and related functional changes in the mat community. *Microb Ecol* **48**: 254-262.
- Gunsch, C.K., Kinney, K.A., Szaniszlo, P.J., and Whitman, C.P. (2007) Relative gene expression quantification in a fungal gas-phase biofilter. *Biotechnol Bioeng* **98**: 101-111.
- Harayama, S., Mermod, N., Rekik, M., Lehrbach, P.R., and Timmis, K.N. (1987) Roles of the divergent branches of the *meta*-cleavage pathway in the degradation of benzoate and substituted benzoates. *J Bacteriol* **169**: 558-564.
- Heider, J., and Fuchs, G. (1997) Anaerobic metabolism of aromatic compounds. *Eur. J. Biochem.* **243**: 577-596.
- Heider, J., and Rabus, R. (2008) Genomic insights in the anaerobic biodegradation of organic pollutants. In *Microbial biodegradation: Genomics and Molecular biology*. Diaz, E. (ed). Norfolk: Caister Academic Press, pp. 25-54.
- Heider, J., Boll, M., Breese, K., Breinig, S., Ebenau-Jehle, C., Feil, U. et al. (1998) Differential induction of enzymes involved in anaerobic metabolism of aromatic compounds in the denitrifying bacterium *Thauera aromatica*. *Arch Microbiol* **170**: 120-131.
- Hermuth, K., Leuthner, B., and Heider, J. (2002) Operon structure and expression of the genes for benzylsuccinate synthase in *Thauera aromatica* strain K172. *Arch Microbiol* **177**: 132-138.
- Hiltner, L. (1904) Über neue Erfahrungen und Probleme auf dem Gebiet der Bodenbakteriologie und unter besonderer Berücksichtigung der Grundfragen und Brauche. *Arb. Dtsch. Landwirtsch. Ges. Berlin* **98**: 59-78.

References

- Hosoda, A., Kasai, Y., Hamamura, N., Takahata, Y., and Watanabe, K. (2005) Development of a PCR method for the detection and quantification of benzoyl-CoA reductase genes and its application to monitored natural attenuation. *Biodegradation* **16**: 591-601.
- Hunkeler, D., Höhener, P., and Zeyer, J. (2002) Engineered and subsequent intrinsic in situ bioremediation of a diesel fuel contaminated aquifer. *J Contam Hydrol* **59**: 231-245.
- Inouye, S., Nakazawa, A., and Nakazawa, T. (1985) Determination of the transcription initiation site and identification of the protein product of the regulatory gene *xylR* for *xyl* Operons on the TOL Plasmid. *J Bacteriol* **163**: 863-869.
- Inouye, S., Nakazawa, A., and Nakazawa, T. (1987) Expression of the regulatory gene *xylS* on the TOL plasmid is positively controlled by the *xylR* gene product. *Proc Natl Acad Sci U S A* **84**: 5182-5186.
- Inouye, S., Nakazawa, A., and Nakazawa, T. (1988) Nucleotide sequence of the regulatory gene *xylR* of the TOL plasmid from *Pseudomonas putida*. *Gene* **66**: 301-306.
- Jahn, M.K., Haderlein, S.B., and Meckenstock, R.U. (2005) Anaerobic degradation of benzene, toluene, ethylbenzene, and *o*-xylene in sediment-free iron-reducing enrichment cultures. *Appl Environ Microbiol* **71**: 3355-3358.
- Junca, H., and Pieper, D.H. (2004) Functional gene diversity analysis in BTEX contaminated soils by means of PCR-SSCP DNA fingerprinting: comparative diversity assessment against bacterial isolates and PCR-DNA clone libraries. *Environ Microbiol* **6**: 95-110.
- Kerkhof, L.J., and Häggblom, M.M. (2008) Detecting active bacteria involved in biodegradation in the environment. In *Microbial biodegradation: Genomics and Molecular biology*. Diaz, E. (ed). Norfolk: Caister Academic Press.
- Kühner, S., Wöhlbrand, L., Fritz, I., Wruck, W., Hultschig, C., Hufnagel, P. et al. (2005) Substrate-dependent regulation of anaerobic degradation pathways for toluene and ethylbenzene in a denitrifying bacterium, strain EbN1. *J Bacteriol* **187**: 1493-1503.
- Kuiper, I., Lagendijk, E.L., Bloemberg, G.V., and Lugtenberg, B.J.J. (2004) Rhizoremediation: A Beneficial Plant-Microbe Interaction. *Mol Plant Microbe Interact* **17**: 6-15.
- Kunz, D.A., and Chapman, P.J. (1981) Catabolism of pseudocumene and 3-ethyltoluene by *Pseudomonas putida* (*arvilla*) mt-2: evidence for new functions of the TOL (pWWO) plasmid. *J Bacteriol* **146**: 179-191.
- Leahy, J.G., and Olsen, R.H. (1997) Kinetics of toluene degradation by toluene-oxidizing bacteria as a function of oxygen concentration, and the effect of nitrate. *FEMS Microbiol Ecol* **23**: 23-30.
- Lee, C., Kim, J., Hwang, K., O'Flaherty, V., and Hwang, S. (2008) Quantitative analysis of methanogenic community dynamics in three anaerobic batch digesters treating different wastewaters. *Water Res.*
- Leuthner, B., and Heider, J. (1998a) A two-component system involved in regulation of anaerobic toluene metabolism in *Thauera aromatica*. *FEMS Microbiol Lett* **166**: 35-41.

- Leuthner, B., and Heider, J. (2000) Anaerobic Toluene Catabolism of *Thauera aromatica*: the *bbs* Operon Codes for Enzymes of β Oxidation of the Intermediate Benzylsuccinate. *J Bacteriol* **182**: 272-277.
- Leuthner, B., Leutwein, C., Schulz, H., Horth, P., Haehnel, W., Schiltz, E. et al. (1998b) Biochemical and genetic characterization of benzylsuccinate synthase from *Thauera aromatica*: a new glycyl radical enzyme catalysing the first step in anaerobic toluene metabolism. *Mol Microbiol* **28**: 615-628.
- Leutwein, C., and Heider, J. (1999) Anaerobic toluene-catabolic pathway in denitrifying *Thauera aromatica*: activation and *beta*-oxidation of the first intermediate, (*R*)-(+)-benzylsuccinate. *Microbiology* **145 (Pt 11)**: 3265-3271.
- Leutwein, C., and Heider, J. (2002) (*R*)-Benzylsuccinyl-CoA dehydrogenase of *Thauera aromatica*, an enzyme of the anaerobic toluene catabolic pathway. *Arch Microbiol* **178**: 517-524.
- Livak, K.J., and Schmittgen, T.D. (2001) Analysis of relative gene expression data using real-time quantitative PCR and the $2^{-\Delta\Delta CT}$ method. *Methods* **25**: 402-408.
- Lovley, D.R. (2003) Cleaning up with genomics: Applying molecular biology to bioremediation. *Nat Rev Microbiol.* **1**: 35-44.
- Low, L.K., Meeks, J.R., and Mackerer, C.R. (1988) Health effects of the alkylbenzenes. I. Toluene. *Toxicol Ind Health* **4**: 49-75.
- Madigan, M.T., and Martinko, J.M. (2006) *Brock Biology of Microorganisms. International Edition*. New Jersey: Pearson Education, Inc.
- Marqués, S., Holtel, A., Timmis, K.N., and Ramos, J.L. (1994) Transcriptional induction kinetics from the promoters of the catabolic pathways of TOL plasmid pWWO of *Pseudomonas putida* for metabolism of aromatics. *J Bacteriol* **176**: 2517-2524.
- McLeod, M.P., and Eltis, L.D. (2008) Genomics insights into the aerobic pathways for degradation of organic pollutants. In *Microbial biodegradation: Genomics and Molecular biology*. Diaz, E. (ed). Norfolk: Caister Academic Press, pp. 1-23.
- Morgan, J.A.W., Bending, G.D., and White, P.J. (2005) Biological costs and benefits to plant-microbe interactions in the rhizosphere. *J Exp Bot* **56**: 1729-1739.
- Morgan, P., Lewis, S.T., and Watkinson, R.J. (1993) Biodegradation of benzene, toluene, ethylbenzene and xylenes in gas-condensate-contaminated ground-water. *Environ Pollut* **82**: 181-190.
- Muyzer, G., and Smalla, K. (1998) Application of denaturing gradient gel electrophoresis (DGGE) and temperature gradient gel electrophoresis (TGGE) in microbial ecology. *Antonie Van Leeuwenhoek* **73**: 127-141.
- Nakai, C., Kagamiyama, H., and Nozaki, M. (1983) Complete nucleotide sequence of the metapyrocatechase gene on the TOL plasmid of *Pseudomonas putida* mt-2. *J Biol Chem* **258**: 2923-2928.
- Nelson, K.E., Weinel, C., Paulsen, I.T., Dodson, R.J., Hilbert, H., Martins dos Santos, V.A. et al. (2002) Complete genome sequence and comparative analysis of the metabolically versatile *Pseudomonas putida* KT2440. *Environ Microbiol* **4**: 799-808.

References

- Neufeld, J., Vohra, J., Dumont, M.G., Lueders, T., Manefield, M., Friedrich, M.W., and Murrell, J.C. (2007) DNA stable-isotope probing. *Nat Protoc* **2**: 860-866.
- Neumann, G., Cornelissen, S., van Breukelen, F., Hunger, S., Lippold, H., Loffhagen, N. et al. (2006) Energetics and surface properties of *Pseudomonas putida* DOT-T1E in a two-phase fermentation system with 1-decanol as second phase. *Appl Environ Microbiol* **72**: 4232-4238.
- Nijenhuis, I., Stelzer, N., Kastner, M., and Richnow, H.H. (2007) Sensitive detection of anaerobic monochlorobenzene degradation using stable isotope tracers. *Environ Sci Technol* **41**: 3836-3842.
- Nozaki, M., Kagamiyama, H., and Hayaishi, O. (1963) Metapyrocatechase. I. Purification, Crystallization And Some Properties. *Biochem Z* **338**: 582-590.
- Nozaki, M., Kotani, S., Ono, K., and Seno, S. (1970) Metapyrocatechase. 3. Substrate specificity and mode of ring fission. *Biochim Biophys Acta* **220**: 213-223.
- O'Brien, R.W., and Morris, J.G. (1971) Oxygen and the growth and metabolism of *Clostridium acetobutylicum*. *J Gen Microbiol* **68**: 307-318.
- Olsen, R.H., Mikesell, M.D., Kukor, J.J., and Byrne, A.M. (1995) Physiological attributes of microbial BTEX degradation in oxygen-limited environments. *Environ Health Perspect* **103**: 49-51.
- Parales, R.E., Parales, J.V., Pelletier, D.A., and Ditty, J.L. (2008) Diversity of microbial toluene degradation pathways. *Adv Appl Microbiol* **64**: 1-73, 72 p following 264.
- Pelz, O., Chatzinotas, A., Andersen, N., Bernasconi, S.M., Hesse, C., Abraham, W.R., and Zeyer, J. (2001) Use of isotopic and molecular techniques to link toluene degradation in denitrifying aquifer microcosms to specific microbial populations. *Arch Microbiol* **175**: 270-281.
- Pfaffl, M.W. (2001) A new mathematical model for relative quantification in real-time RT-PCR. *Nucleic Acids Res* **29**: 2002-2007.
- Rabus, R., and Widdel, F. (1995) Anaerobic degradation of ethylbenzene and other aromatic hydrocarbons by new denitrifying bacteria. *Arch Microbiol* **163**: 96-103.
- Rabus, R., Kube, M., Heider, J., Beck, A., Heitmann, K., Widdel, F., and Reinhardt, R. (2005a) The genome sequence of an anaerobic aromatic-degrading denitrifying bacterium, strain EbN1. *Arch Microbiol* **183**: 27-36.
- Ramos, J.L., Marqués, S., and Timmis, K.N. (1997) Transcriptional control of the *Pseudomonas* TOL plasmid catabolic operon is achieved through an interplay of host factors and plasmid-encoded regulators. *Annu Rev Microbiol* **51**: 341-372.
- Ramos, J.L., Rojo, F., Zhou, L., and Timmis, K.N. (1990) A family of positive regulators related to the *Pseudomonas putida* TOL plasmid XylS and the *Escherichia coli* AraC activators. *Nucleic Acids Res* **18**: 2149-2152.
- Russell, J.B., and Cook, G.M. (1995) Energetics of bacterial growth: balance of anabolic and catabolic reactions. *Microbiol Rev* **59**: 48-62.
- Sahm, K., MacGregor, B.J., Jorgensen, B.B., and Stahl, D.A. (1999) Sulphate reduction and vertical distribution of sulphate-reducing bacteria quantified by rRNA slot-blot hybridization in a coastal marine sediment. *Environ Microbiol* **1**: 65-74.

- Saleh-Lakhaa, S., Millera, M., Campbell, R.G., Schneider, K., Elahimaneshd, P., Harta, M.M., and Trevors, J.T. (2005) Microbial gene expression in soil: methods, applications and challenges. *J Microbiol Methods* **63**: 1-19.
- Sawers, G. (1999) The aerobic/anaerobic interface. *Curr Opin Microbiol* **2**: 181-187.
- Schirmer, M., Butler, B.J., Church, C.D., Barker, J.F., and Nadarajah, N. (2003) Laboratory evidence of MTBE biodegradation in Borden aquifer material. *J Contam Hydrol* **60**: 229-249.
- Schirmer, M., Dahmke, A., Dietrich, P., Dietze, M., Gödeke, S., Richnow, H.H. et al. (2006) Natural attenuation research at the contaminated megasite Zeitz. *J Hydrol* **328**: 393-407.
- Schmittgen, T.D., and Livak, K.J. (2008) Analyzing real-time PCR data by the comparative C(T) method. *Nat Protoc* **3**: 1101-1108.
- Schwieger, F., and Tebbe, C.C. (1998) A new approach to utilize PCR-single-strand conformation polymorphism for 16S rRNA gene-based microbial community analysis. *Appl Environ Microbiol* **64**: 4870-4876.
- Scow, K.M., and Hicks, K.A. (2005) Natural attenuation and enhanced bioremediation of organic contaminants in groundwater. *Curr Opin Biotechnol* **16**: 246-253.
- Scullion, J. (2006) Remediating polluted soils. *Naturwissenschaften* **93**: 51-65.
- Seyfried, B., Glod, G., Schocher, R., Tschsch, A., and Zeyer, J. (1994) Initial reactions in the anaerobic oxidation of toluene and *m*-xylene by denitrifying bacteria. *Appl Environ Microbiol* **60**: 4047-4052.
- Shalel-Levanon, S., San, K.Y., and Bennett, G.N. (2005) Effect of oxygen, and ArcA and FNR regulators on the expression of genes related to the electron transfer chain and the TCA cycle in *Escherichia coli*. *Metab Eng* **7**: 364-374.
- Shaler, T.A., and Klečka, G.M. (1986) Effects of dissolved oxygen concentration on biodegradation of 2,4-dichlorophenoxyacetic acid. *Appl Environ Microbiol* **51**: 950-955.
- Sharkey, F.H., Banat, I.M., and Marchant, R. (2004) Detection and quantification of gene expression in environmental bacteriology. *Appl Environ Microbiol* **70**: 3795-3806.
- Shaw, J.P., and Harayama, S. (1992) Purification and characterisation of the NADH: acceptor reductase component of xylene monooxygenase encoded by the TOL plasmid pWWO of *Pseudomonas putida* mt-2. *Eur. J. Biochem.* **209**: 51 -61.
- Shim, H., Hwang, B., Lee, S.S., and Kong, S.H. (2005) Kinetics of BTEX biodegradation by a coculture of *Pseudomonas putida* and *Pseudomonas fluorescens* under hypoxic conditions. *Biodegradation* **16**: 319-327.
- Spooner, R.A., Bagdasarian, M., and Franklin, F.C. (1987) Activation of the *xylDLEGF* promoter of the TOL toluene-xylene degradation pathway by overproduction of the *xylS* regulatory gene product. *J Bacteriol* **169**: 3581-3586.
- Suzuki, M., Hayakawa, T., Shaw, J.P., Rekik, M., and Harayama, S. (1991) Primary structure of Xylene monooxygenase: similarities to and differences from the alkane hydroxylation system. *J Bacteriol* **173**: 1690-1695.
- Taylor, B.L., Zhulin, I.B., and Johnson, M.S. (1999) Aerotaxis and other energy-sensing behavior in bacteria. *Annu Rev Microbiol* **53**: 103-128.

References

- Thompson, I.P., van der Gast, C.J., Ciric, L., and Singer, A.C. (2005) Bioaugmentation for bioremediation: the challenge of strain selection. *Environ Microbiol* **7**: 909-915.
- Tschech, A., and Fuchs, G. (1987) Anaerobic degradation of phenol by pure cultures of newly isolated denitrifying pseudomonads. *Arch Microbiol* **148**: 213-217.
- Ugidos, A., Morales, G., Rial, E., Williams, H.D., and Rojo, F. (2008) The coordinate regulation of multiple terminal oxidases by the *Pseudomonas putida* ANR global regulator. *Environ Microbiol* **10**: 1690-1702.
- Unciuleac, M., and Boll, M. (2001) Mechanism of ATP-driven electron transfer catalyzed by the benzene ring-reducing enzyme benzoyl-CoA reductase. *Proc Natl Acad Sci U S A* **98**: 13619-13624.
- US-EPA (1994) OPPT Chemical fact sheet: Toluene (CAS NO. 108-88-3). EPA 749-F-94-021. *Pollution Prevention and Toxics, Washington, DC*.
- Van Agteren, M.H., Keuning, S., and Janssen, D.B. (1998) *Handbook on biodegradation and biological treatment of hazardous organic compounds*: Kluwer Academic Publishers, Dordrecht.
- Velázquez, F., de Lorenzo, V., and Valls, M. (2006) The *m*-xylene biodegradation capacity of *Pseudomonas putida* mt-2 is submitted to adaptation to abiotic stresses: evidence from expression profiling of *xyl* genes. *Environ Microbiol* **8**: 591-602.
- Vogel, T.M., and Grbic-Galic, D. (1986) Incorporation of Oxygen from Water into Toluene and Benzene during Anaerobic Fermentative Transformation. *Appl Environ Microbiol* **52**: 200-202.
- Widada, J., Nojiri, H., and Omori, T. (2002) Recent developments in molecular techniques for identification and monitoring of xenobiotic-degrading bacteria and their catabolic genes in bioremediation. *Appl Microbiol Biotechnol* **60**: 45-59.
- Widada, J., Nojiri, H., Kasuga, K., Yoshida, T., Habe, H., and Omori, T. (2001) Quantification of the carbazole 1,9a-dioxygenase gene by real-time competitive PCR combined with co-extraction of internal standards. *FEMS Microbiol Lett* **202**: 51-57.
- Wießner, A., Kappelmeyer, U., Kusch, P., and Kastner, M. (2005) Influence of the redox condition dynamics on the removal efficiency of a laboratory-scale constructed wetland. *Water Res* **39**: 248-256.
- Williams, P.A., and Murray, K. (1974) Metabolism of benzoate and the methylbenzoates by *Pseudomonas putida* (*arvilla*) mt-2: evidence for the existence of a TOL plasmid. *J Bacteriol* **120**: 416-423.
- Wilson, L.P., and Bouwer, E.J. (1997) Biodegradation of aromatic compounds under mixed oxygen/denitrifying conditions: a review. *J Ind Microbiol Biotechnol* **18**: 116-130.
- Wöhlbrand, L., Kallerhoff, B., Lange, D., Hufnagel, P., Thiermann, J., Reinhardt, R., and Rabus, R. (2007) Functional proteomic view of metabolic regulation in "*Aromatoleum aromaticum*" strain EbN1. *Proteomics* **7**: 2222-2239.
- Worsey, M.J., Franklin, F.C.H., and Williams, P.A. (1978) Regulation of the degradative pathway enzymes coded for by the TOL plasmid (pWWO) from *Pseudomonas putida* mt-2. *J Bacteriol* **134**: 757-764.

Zimmermann, A., Reimmann, C., Galimand, M., and Haas, D. (1991) Anaerobic growth and cyanide synthesis of *Pseudomonas aeruginosa* depend on *anr*, a regulatory gene homologous with *fnr* of *Escherichia coli*. *Mol Microbiol* **5**: 1483-1490.

Acknowledgements

At the end of these 4 years of work I have many people to thank and probably not all of them can be mentioned in these pages, but I will always be grateful for all the help, support, friendship and good moments that I have spent in Leipzig. Many thanks go to Dr. Hermann J. Heipieper who gave me the opportunity to join his group and for the supervision of this thesis. Special thanks also go to Prof. Gabriele Diekert for giving me the chance to submit and defend my thesis within the Faculty of Biology-Pharmacy at the University Friedrich-Schiller in Jena, for the interesting discussions and kindness every time that we met. I have to thank once more to Dr. Heipieper together with Dr. Nijenhuis and Dr. Kappelmeyer, who always supported my work, helped me with experimental troubles and especially for the nice friendship that we have developed.

I would like to acknowledge all people I have met during these almost four years at the bioremediation and isotope biogeochemistry departments to give a familiar environment to the working days; Prof Matthias Kästner for his support; and especially I like to thanks to Kerstin Ethner and Ines Mäusezahl to take care of us and of the labs. Many thanks go to the AXIOM group, to Hans H. Richnow for the coordination of the project, and especially to Danuta, Makeba and Gwenaël, great friends that I will never forget. I was always grateful to meet you and I am very happy to be your friend and to have shared with you this common way.

This work could have not been completed without the help of my students and friends Christina Müller, Marieke Buffing, Alejandro Sarrión, Clara García, Fabio Ugolini, Aina Børve, Fabrizio Lecce and Erika Schulze, sorry guys to make you work so hard. Further, I always got external help regarding to answer a lot of questions from: Dr. Howard Junca, Dr. Olga Zafra, Karin Trescher, Dr. Anja Dohrmann and Dr. Christoph C. Tebbe, thank you very much for the knowledge that you have shared with me. I have to thank as well all the love and care that I have got from my family in Chile and the good old friends there. Mamá, papá y hermanas, otra etapa se ha terminado y la hemos terminado juntos, muchas gracias por todo el amor que siempre me han dado. Mamita, los grandes sacrificios que has hecho y los difíciles momentos que hemos pasado me han traído hasta este punto, en donde no puedo de dejar de agradecerte todo lo que me has dado. Papito, tu

fuerza espiritual, todo tu apoyo y comprensión me han dado fuerzas para terminar los grandes desafíos que han llegado a mi vida, mil gracias. I also have to thanks the family Cornelissen to always make me feel at home, for all the laughs and care.

During these years I have made many friends with who I have shared good and happy but also sad and stressful moments. Many thanks to: Cecilia, Mónica, Nadja, Aldo, Ana la catalana, Alvaro G., Anna, Cristóbal, Petra, Charo, Jaime, Cristian, Alvaro and Tita, Annette, Eva and Alessandro, again Makeba, Gwen and Danuta, Camelia, Stefan, Anko, Kevin, Alexandra and of course my lovely cats Simón and Porteña. To Laura and Gustavo from who I have learned so much about word and endnote these last days. But, especial and huge thanks go to Sjef for all his love and patience, Nicole and Lei, all of you were always my support and were there for me whenever I needed you, thank you very much.

Declaration of Independent Work

Herewith I, Paula Martínez Lavanchy, born the 21.03.1978 in Stockholm, confirm that I am familiar with the promotion regulations of the faculty of Biology and Pharmacy of the Friedrich-Schiller-University Jena.

I further approve, that this present doctoral thesis represents my own work in accordance with the university regulations and no other support than listed were used in this work.

The help of a promotion consultant was also not demanded and I did not generate any monetary perquisites which are in conjunction with the content of my thesis.

This doctoral thesis was only submitted at the faculty board of the faculty of Biology and Pharmacy of the Friedrich-Schiller-University Jena and nowhere else for scientific evaluation or dissertation.

This work is neither identical nor partly identical with work, which was already presented at the Friedrich-Schiller-University Jena or at any other university for obtaining an academic degree or academic credits.

Leipzig, December 2008

Curriculum Vitae

Personal Data

Name : Paula Martínez Lavanchy
Date of birth : March 21, 1978
Place of birth : Stockholm, Sweden
Citizenship : Chilean

Education

March 2005- present: PhD student at the Department of Bioremediation, UFZ-Centre for Environmental Research. Leipzig-Halle, Germany.
European Union Marie Curie Host Fellowships for Early Stage Training. “Assessment of *in situ* Transformation of Xenobiotic Organic Material” (AXIOM).

April 2004 Molecular Biotechnology Engineer,
Universidad de Chile. Santiago, Chile

Aug. 2001-Dec. 2002 Msc thesis at the Molecular Microbiology and Environmental Biotechnology Laboratory, Department of Chemistry, UTFSM. Theme: “Response of *Burkholderia* sp. LB400 to chlorobenzoates”
Supervisor: Professor Dr. Michael Seeger, Dep. of Chemistry, UTFSM. Valparaiso, Chile

Aug. 2001 Bachelor degree in Molecular Biotechnology Engineer,
Universidad de Chile. Santiago, Chile

Working experience

Jan. 2003-Jan.2005: Researcher at the Molecular Microbiology and Environmental Biotechnology Laboratory
Professor Dr. Michael Seeger, Department of Chemistry
Universidad Técnica Federico Santa María (UTFSM),
Valparaíso, Chile

Publications

Nikolausz M, Chatzinotas A, Palatinszky M, Imfeld G, **Martínez P**, Kästner M. (2008). "Single-nucleotide primer extension assay for detection and sequence typing of "*Dehalococcoides*" spp.". *Appl Environ Microbiol.* 74(1):300-4

Martínez, P., Agulló, L., Hernández, M. and Seeger, M. (2007). "Chlorobenzoate inhibits growth and induces stress proteins in the PCB-degrading bacterium *Burkholderia xenovorans* LB400". *Arch Microbiol.* 188(3): 289-97.

Agulló, L., Cámara, B., **Martínez, P.**, Latorre, V. and Seeger, M. (2007). "Response to (chloro)biphenyls of the polychlorobiphenyl-degrader *Burkholderia xenovorans* LB400 involves stress proteins also induced by heat shock and oxidative stress" *FEMS Microbiol Lett.* 267(2): 167-75.

Oral Presentation

Paula Martínez, Christina Müller, Fabio Ugolini, Alejandro Sarrión, Clara García, Ivonne Nijenhuis, Uwe Kappelmeyer and Hermann J. Heipieper. "Effect of oxic/anoxic fluctuations on catabolic gene expression of bacterial toluene degraders". AXIOM-VIBE-e-Trap-HIGRADE Workshop: Electron transfer Processes at biogeochemical gradients 2008, Leipzig, Germany.

Poster Presentations

2008 **Martínez, P.M.**, A-B. Dohrmann, C.C. Tebbe, S. Weber, N. Stelzer, H-H. Richnow, and I. Nijenhuis. "Investigation of anaerobic degradation of monochlorobenzene using stable isotope tracers". Workshop on Metabolomics and Environmental Biotechnology 2008, Palma de Mallorca, Spain. Book of Abstracts, p: 43.

2007 **Paula M. Martínez**, Anja-Bettina Dohrmann, Christoph C. Tebbe, Matthias Kästner, Nicole Stelzer, Hans-Hermann Richnow, Ivonne Nijenhuis. "Microbial community analysis of anaerobic microcosms degrading monochlorobenzene". Bacterial Genetics and Ecology-BAGECO 2007, Wernigerode, Germany. Boof of Abstracts, p: 126

Marcell Nikolausz, Antonis Chatzinotas, Márton Palatinszky, Gwenael Imfeld G, **Paula Martínez**, Matthias Kästner. "A multiplex taxon-specific primer extension assay for the detection of microorganisms". Bacterial Genetics and Ecology-BAGECO 2007, Wernigerode, Germany. Boof of Abstracts, p: 152.

- 2006 **Martínez, P.**, Børve, A., Lecce, F., Nijenhuis, I., Kappelmeyer, U., Heipieper, H. J. “Aerobic/anaerobic toluene degradation: elucidation of microbial networks using molecular tools”. XVII Congreso Latinoamericano de Microbiología-ALAM 2006, Pucón, Chile. Book of Abstracts, p: 69 (P14).
- Paula Martínez**, Fabrizio Lecce, Ivonne Nijenhuis, Marcell Nikolausz, Uwe Kappelmeyer, Hermann J. Heipieper. “Elucidation of microbial networks in aerobic and anaerobic toluene degradation using molecular tools”. Microbial Ecology-ISME-11 2006, Vienna, Austria. Book of Abstracts, p: A409 (PO 299).
- Paula Martínez**, Fabrizio Lecce, Ivonne Nijenhuis, Marcell Nikolausz, Uwe Kappelmeyer, Antonis Chatzinotas and Hermann J. Heipieper. “Molecular biology tools to elucidate microbial activity in aerobic/anaerobic toluene degradation system”. Axiom Virtual Institute Spring school: Microbial activity at biogeochemical gradients 2006, Leipzig, Germany.
- Martínez P.**, Lecce F., Nijenhuis I., Nikolausz M., Kappelmeyer U., Heipieper H.J. “Molecular tools to elucidate microbial networks in aerobic and anaerobic toluene degradation”. VAAM-Jahrestagung 2006, Jena. BIOSpektrum Sonderausgabe: p. 208 (PR24).
- 2005 **Paula Martínez**, Ivonne Nijenhuis, Marcell Nikolausz, Uwe Kappelmeyer, Antonis Chatzinotas and Hermann J. Heipieper. “Microbial community metabolic networks involved in toluene degradation”. International Summer School: Biomonitoring, bioavailability and microbial transformation of pollutants in sediments and approaches to stimulate their biodegradation. 2005. Genoa, Italy. Book of Abstracts, p: 180.

Leipzig, December 2008