

Purdue University Purdue e-Pubs

International Refrigeration and Air Conditioning
Conference

School of Mechanical Engineering

2018

Modeling And Experimental Study On A Direct Expansion Based Enhanced Dehumidification Air Conditioning System

Wenjing Chen

The Hong Kong Polytechnic University, Department of Building Services Engineering, Hong Kong SAR, China,
15900834r@connect.polyu.hk

Ming-yin Chan

The Hong Kong Polytechnic University, Department of Building Services Engineering, Hong Kong S.A.R. (China), ming-
yin.chan@polyu.edu.hk

Wen Bing Weng

University of Shanghai for Science and Technology, School of Environment and Architecture, Shanghai, China,
wenbing@vip.163.com

Shi Ming Deng

Department of Building Services Engineering, The Hong Kong Polytechnic University, Hong Kong S.A.R. (China), simon.shi-
ming.deng@polyu.edu.hk

Follow this and additional works at: <https://docs.lib.purdue.edu/iracc>

Chen, Wenjing; Chan, Ming-yin; Weng, Wen Bing; and Deng, Shi Ming, "Modeling And Experimental Study On A Direct Expansion Based Enhanced Dehumidification Air Conditioning System" (2018). *International Refrigeration and Air Conditioning Conference*. Paper 1890.
<https://docs.lib.purdue.edu/iracc/1890>

This document has been made available through Purdue e-Pubs, a service of the Purdue University Libraries. Please contact epubs@purdue.edu for additional information.

Complete proceedings may be acquired in print and on CD-ROM directly from the Ray W. Herrick Laboratories at <https://engineering.purdue.edu/Herrick/Events/orderlit.html>

Modelling And Experimental Study On A Direct Expansion Based Enhanced Dehumidification Air Conditioning System

Wenjing Chen¹, Ming-yin Chan¹, Wenbing Weng², Shiming Deng^{1,*}

¹The Hong Kong Polytechnic University, Department of Building Services Engineering,
Hong Kong SAR, China

Contact Information (+86 852 27665989, +86 852 27657198, wenjing.chen@connect.polyu.hk)

²University of Shanghai for Science and Technology, School of Environment and Architecture, Shanghai,
China

Contact Information (+86 021 55273240, +86 021 55273240, wenbing@vip.163.com)

* Corresponding Author

ABSTRACT

Direct expansion (DX) air conditioning (A/C) systems are widely used for controlling indoor air temperature and humidity in various buildings in hot and humid climates since they are simpler and more energy efficient, and generally cost less to own and maintain. However, it is often problematic for a DX A/C system to provide desired humidity control due to the current system design trends, variable weather conditions and the commonly used control strategies for DX A/C systems. Therefore, a standalone DX based enhanced dehumidification air conditioning (EDAC) system is proposed to provide suitable indoor humidity control at different seasons. There are two evaporators in the EDAC system, thus it could act as a dehumidifier, i.e., air dehumidification only (ADO) mode, on the days when less or no additional cooling is required by employing one evaporator as a reheating coil, or act as an enhanced dehumidification A/C system i.e., EDAC mode, by functioning two evaporators to separately deal with sensible and latent cooling. A prototype experimental EDAC system was established in a laboratory.

The operational characteristics of the EDAC system at ADO mode in terms of the moisture removal capacity (MRC), the specific moisture extraction rate (SMER) and the resulted supply air temperature were investigated and reported in this paper. Firstly, the experimental results on operational characteristics are reported. Secondly, the development of a steady-state mathematical model for the ADO mode of the EDAC system is presented. The developed model was thereafter used to study the influence of different sizes of the evaporator and the reheating coil on the operational characteristic of the EDAC system at ADO mode. The study results could lead to a better understanding of the operational characteristics of the EDAC system, facilitating its design, operation and control.

1. INTRODUCTION

In buildings, controlling indoor humidity at an appropriate level is critically important since this directly affects building occupants' thermal comfort, indoor air quality (IAQ) and the operating efficiency of building A/C systems (Toftum & Fanger, 1999; H. Zhang & Yoshino, 2010). Direct expansion (DX) based A/C systems are widely used for controlling indoor air temperature and humidity in various buildings because they are simpler and more energy efficient, and generally cost less to own and maintain.

In hot and humid climates, the latent load in a conditioned space that directly influences indoor air humidity level can vary substantially due to the change in outdoor weather conditions and indoor occupancy. Therefore, for a DX A/C system, it has to be operated to meet variable dehumidification requirement in an air conditioned space. However, to deal with space latent cooling load using a conventional DX A/C system is more challenging and difficult (Zheng Li, Chen, Deng, & Lin, 2006). This is partly due to the current trend in designing a conventional DX A/C system to have a smaller moisture removal capacity in an attempt to boost its energy efficiency ratings (EER) and Coefficient of Performance (COP). Furthermore, the operation of a conventional DX A/C system with

only one main cooling and dehumidifying coil is usually controlled by indoor air temperature through On-Off cycling of its compressor, whereas indoor air humidity is not controlled directly. Therefore, when a conventional On-Off controlled DX A/C system is used at a variable indoor latent load condition, inadequate dehumidification is often encountered due to its fixed moisture removal capacity, leading to a higher equilibrium indoor air humidity.

In the transitional seasons, indoor latent load is high and sensible load low due to a moderate outdoor air temperature and high moisture content. When a conventional on-off controlled DX AC system is used, space overcooling is therefore common, unless reheating is provided. However, reheating is obviously energy inefficient and is prohibited in many building energy codes. Furthermore, it is difficult to include a re-heater in certain DX AC systems such as a room air conditioner. To address the problem of space overcooling, an additional standalone dehumidifier, either desiccant based or vapor compression based, may be employed. However, heat generated by a solid desiccant dehumidifier or rejected from the condenser of a vapor compression based dehumidifier can cause thermal discomfort for occupants (Alpuche, Heard, Best, & Rojas, 2005). On the other hand, a DX AC system may be modified, so that the heat rejected from its condenser which is usually air cooled, or the hot refrigerant gas discharged from its compressor, may be used for reheating air, as described in a number of US patents (Knight, Bellah, & Pickle, 2008; Trent, 2003). The common problems resulting from these modifications, however, included complicated refrigerant circuits and increased air flow resistance due to the addition of a re-heater which is redundant when not in use. In addition, these modifications only address the issue of space overcooling in this particular period of relatively short durations.

In the conditioned seasons when the demands for both air cooling and dehumidification are high, two major approaches are often adopted to address the problem of inadequate dehumidification. The first is DX based separate sensible and latent cooling (SSLC) technology. Usually, a DX A/C system was used to directly cool and dehumidify the air while supplementary chilled ceiling (Zhao Li, Chen, Wang, Cui, & Qu, 2018) / radiant panels (L. Zhang & Niu, 2003) or thermally activated solid / liquid desiccant units (Eicker, Schneider, Schumacher, Ge, & Dai, 2010; Wang, Zhang, & Xia, 2013) were employed to provide variable dehumidification capacity. However, these radiant panel / desiccant assisted SSLC A/C systems were inevitably complicated, with higher initial and operational / maintenance costs, thus not suitable for residential applications. The other major approach is to simultaneously vary the compressor and supply fan speeds in a DX A/C system, so as to obtain different system output total cooling capacity and SHR to deal with different space sensible and latent loads. Over the years, there have been extensive detailed studies on the operational characteristics of a DX A/C system under variable speed (VS) operation (Zheng Li & Deng, 2007; Qi & Deng, 2009) and thus a number of novel capacity controllers (Xu, Deng, & Chan, 2008; Xu, Xia, Chan, & Deng, 2010) have been developed. The novel capacity controllers developed, in addition, are usually complicated and need to be supported by suitable mathematical models, involving such advanced complex calculation algorithms as artificial neural network and fuzzy logic, thus leading to a high development cost.

Therefore, based on the multi-evaporator technologies, a novel standalone DX based enhanced dehumidification A/C (EDAC) system is proposed to provide suitable indoor humidity control at different seasons, without employing any complicated and costly supplementary measures to provide variable dehumidification ability. There are two evaporators in the EDAC system, thus it could act as a dehumidifier (ADO mode) on the days when less or no additional cooling is required by employing one evaporator as a reheating coil, or act as an enhanced dehumidification A/C system (EDAC mode) by functioning two evaporators to separately deal with sensible and latent cooling.

This paper reports on a modelling and experimental study on such an EDAC system when it was operated at its ADO mode. Firstly, detailed descriptions on the configuration of the EDAC system and a prototype experimental EDAC system are presented, followed by reporting the operational characteristics of the EDAC system under different inlet air conditions. Thirdly, the development of a steady-state mathematical model for the ADO mode of the EDAC system is presented. Then, a modelling study is carried out to study the influence of different sizes of the evaporator and the reheating coil on the operational characteristic of the EDAC system at ADO mode. Finally, conclusion are given.

2. SYSTEM DESCRIPTION AND PROTOTYPE EXPERIMENTAL SYSTEM

2.1 Configuration of The EDAC System

The proposed EDAC system is shown schematically in Figure 1. As seen, there were two evaporators, HX1 and HX2, which were parallelly-connected. Correspondingly, there were two electronic expansion valves (EEVs), with EEV1 connected to HX1 and EEV2 to HX2. Three modulating valves (SV1 to SV3) were installed on the refrigerant pipeline to allow different refrigerant flow arrangements when needed. A two speed compressor and supply fan are employed. Two air volume control dampers (VCDs) were included for adjusting air flow passing through the two evaporators, and reducing air flow resistance when either HX1 or HX2 was not in use.

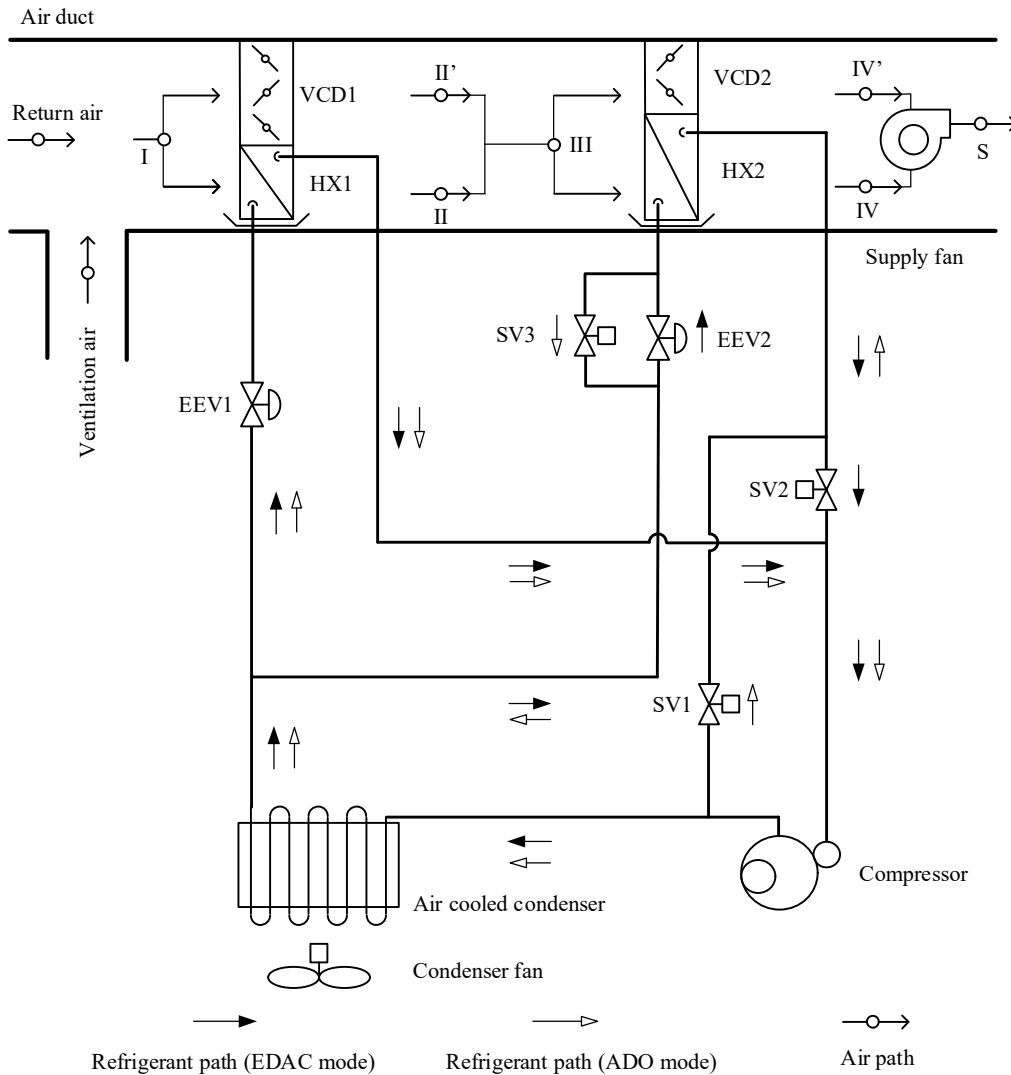

HX1 - the first heat exchanger
HX2 - the second heat exchanger
EEV - electronic expansion valve
VCD - volume control damper

SV - solenoid valve
I - mixed air
II - outlet air of HX1
II' - bypassed air from VCD1

III - inlet air of HX2
IV - outlet air of HX2
IV' - bypassed air from VCD2
S - supply air

Figure 1: Schematic of the proposed configuration for the EDAC system

At ADO mode, SV1 and SV3 were opened, while SV2, VCD1 and VCD2 closed. HX1 acted as an evaporator to cool and dehumidify air and HX2 a condenser to reheat the air to a suitable temperature. At this operational mode,

both compressor and supply fan operate at low speeds. Depending on the indoor air states, there are two different operational status of condenser fan, namely Status 1 and Status 2. At ADO mode, when indoor air temperature, T_i , is lower than $T_{i,s(ADO)} - \Delta T$, where $T_{i,s(ADO)}$ is indoor air temperature set point at ADO mode and ΔT temperature control dead-band, the EDAC system is operated at Status 1. At this Status, the condenser fan is stopped, so that HX2 acts as a main condenser to reheat the cooled and dehumidified air. If T_i is higher than $T_{i,s(ADO)} + \Delta T$, the EDAC system is operated at Status 2, where the condenser fan runs at a low speed to allow more condensation heat being rejected to the air cooled condenser and less to HX2, thus lowering supply air temperature, T_{as} , for a lower T_i . However, when the indoor air temperature is within the dead-band, the current operational status remains unchanged.

On the other hand, at EDAC mode, SV1 and SV3 were closed and SV2 opened. Therefore, HX2 was intended to be a main cooling and dehumidifying coil in the EDAC system and HX1 a supplementary one to provide variable latent cooling capacity when needed.

2.2 The Prototype Experimental EDAC System

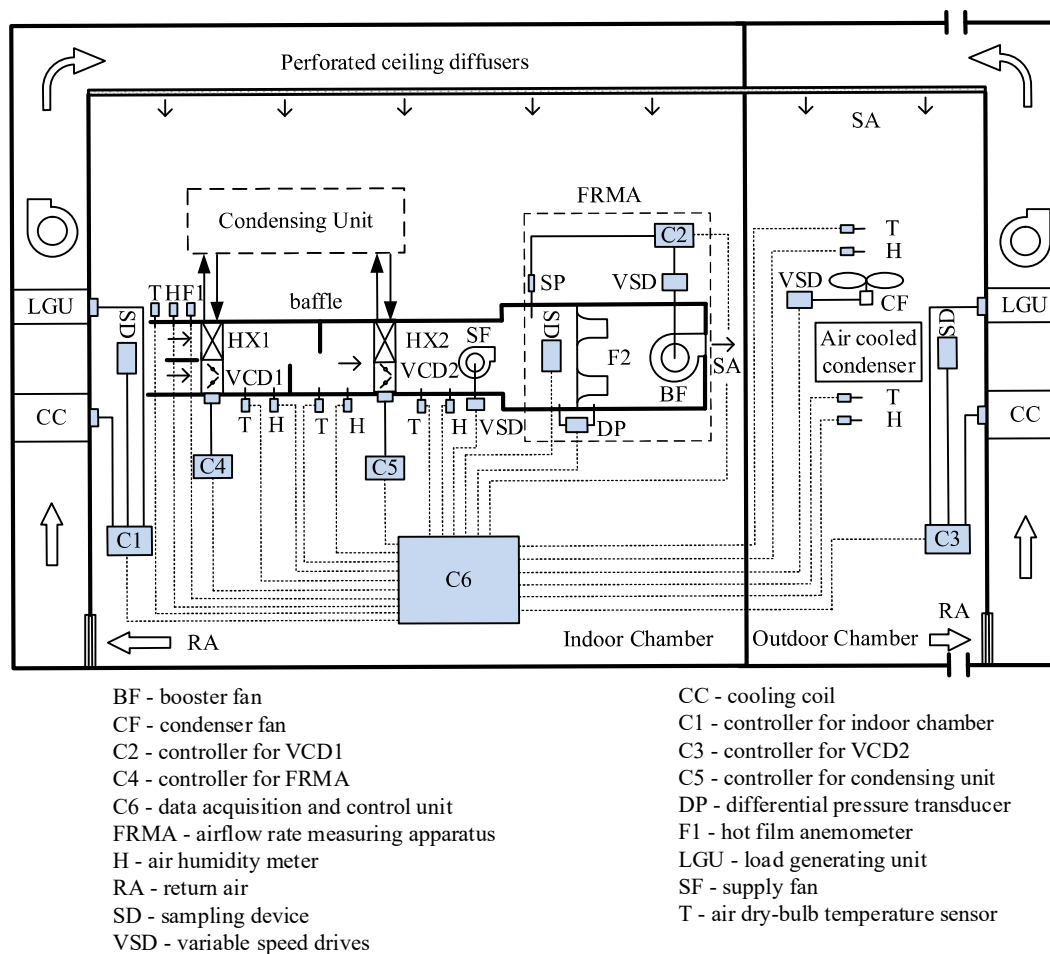

Figure 2: The schematic diagram of the prototype experimental EDAC system.

To experimentally validate the developed model of the proposed EDAC system presented in Section 2, a prototype experimental EDAC system, in accordance with the schematics shown in Fig. 1, was specifically set up in a laboratory with two environmental chambers, one indoor chamber and the other outdoor chamber, where the required experimental indoor and outdoor air conditions could be created and maintained respectively by an existing air conditioning system and load generation units (LGU), as shown in Figures 2. To allow greater flexibility in outputting variable cooling capacities and air flow rates during experiments for possible further study, a variable speed (VS) compressor, VS supply fan and VS condenser fan were used, although during the current study, fixed

speeds for compressor, supply fan and condenser fan were employed. The experimental EDAC system was fully instrumented for measuring all of its operating parameters, which may be classified into three types: temperature, pressure and flow rate. All the measurements were computerized, so that all the measured operating parameters can be real-time monitored and recorded for subsequent analysis.

3. THE OPERATIONAL CHARACTERISTICS OF THE EDAC SYSTEM

For the proposed EDAC system, as mentioned, it can be operated at different modes. However, the current study only covered the mode of air dehumidification only (ADO), i.e., with HX1 functioning solely to cool and dehumidify air and HX2 as a condenser to reheat the cooled and dehumidified air. In this section, the operational characteristics of the EDAC system at ADO mode were experimentally studied using the prototype experimental system.

3.1 The Experimental Conditions

The moisture removal capacity (MRC), the specific moisture extraction rate (SMER) and the resulted supply air temperature (T_{as}) were used to represent the operational characteristics of the EDAC system at ADO mode. Given that different inlet air states to the proposed EDAC system may also affect its operational characteristics, in this study, five experimental cases at five different inlet air states, i.e. 22 °C and 50% RH, 24 °C, 50% RH, 26 °C, 50% RH (T Group) and 26 °C, 40% RH, 26 °C, 50% RH and 26 °C, 60% RH (RH Group), were carried out. The compressor, supply fan and condenser fan were set to run at 40 %, 40 % and 50 % of their maximum speeds, i.e., 2400 rpm, 800 rpm and 2800 rpm, respectively.

For all the cases, using the obtained experiment outputs, MRC and $SMER$ were calculated by the follow equations, respectively:

$$MRC = m_{aHX1}(d_{al} - d_{as}) \quad (1)$$

Where m_{aHX1} was the air mass flow rate through HX1, d_{as} the supply air moisture content from the EDAC system and T_{al} the inlet air moisture content to the EDAC system

$$SMER = \frac{MRC}{W_{com} + W_{sf} + W_{cf}} \quad (2)$$

Where W_{com} , W_{sf} and W_{cf} were the power consumption of the compressor, supply fan and condenser fan, respectively.

3.2 The Experimental Results

Figure 3 shows the experimental results of the five cases at ADO mode. From Figure 3, it was found that the resulted supply air temperature at Status 2 was 3 - 4.7 °C lower than the inlet air temperature while that at Status 1 was 1 - 3.2 °C higher. Furthermore, the MRC at Status 1 was a little lower than that at Status 2. This suggested that the EDAC system could output a larger reheat capacity but a slightly smaller dehumidification capacity during Status 1 than those during Status 2. However, the energy consumption of EDAC system at Status 2 would be less than that at Status 1, since the outside condenser fan was stopped at Status 2. Therefore, at ADO mode, indoor air temperature control could be realized by varying the operation durations between Status 1 and 2, while indoor air relative humidity is indirectly controlled, depending on the dehumidification abilities of the EDAC system at the two statuses.

The influence of inlet air temperature and relative humidity on the T_{as} , MRC and $SMER$ of the EDAC system was also shown in Figure 3. As seen, both the increase of the inlet air temperature and relative humidity would result in an increase in the supply air temperature, but with different extent: 4.3 °C at Status 1 and 4.8 °C at Status 2 for T group test while only 2 °C and 1.7 °C for RH group test. However, the inlet air relative humidity could influence the difference between inlet and outlet air temperature with a range of 2 °C at Status 1 and 1.7 °C at Status 2, while the influence of the inlet air temperature was less significant, only 0.3 °C and 0.8 °C, respectively.

Furthermore, the inlet air temperature has little effect on the MRC s of the EDAC system: with air temperature increasing from 22 °C to 26 °C, the MRC was only increased by 9.1% at Status 1, 8.2% at Status 2. However, at the

same time the *SMER* of the EDAC system was decreased approximately 12.5% and 10.9%, respectively. On the other hand, the higher the inlet relative humidity is, the higher the *MRCs* and *SMERs* are, but with different extent of variation: 57.9%-66.3% for *MRC*, 10%-11.2% for *SMER*.

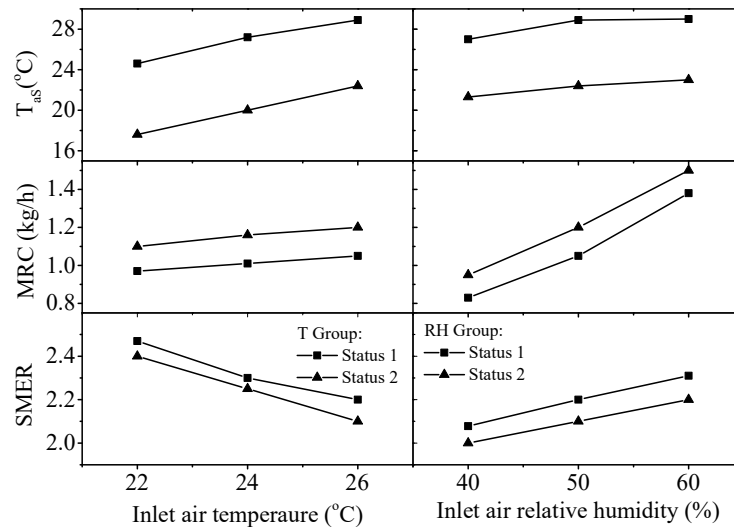

Figure 3: The influence of different indoor air states on the operational characteristics of the EDAC system at ADO mode

4. DEVELOPMENT OF THE EDAC MODEL

4.1 Modeling of The EDAC System

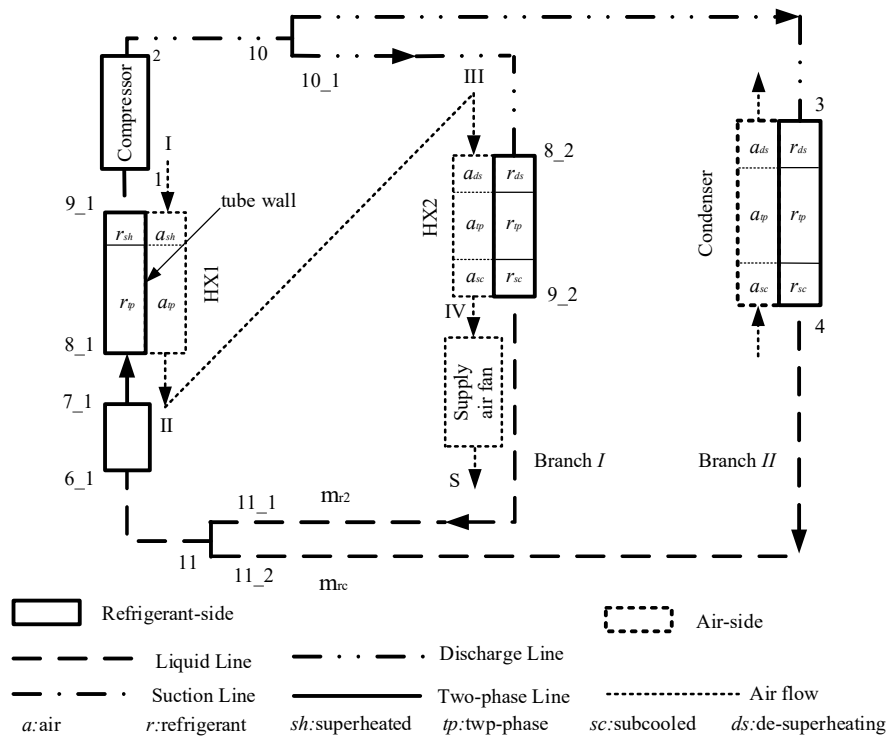

Figure 4: Conceptual model for EDAC system at ADO mode

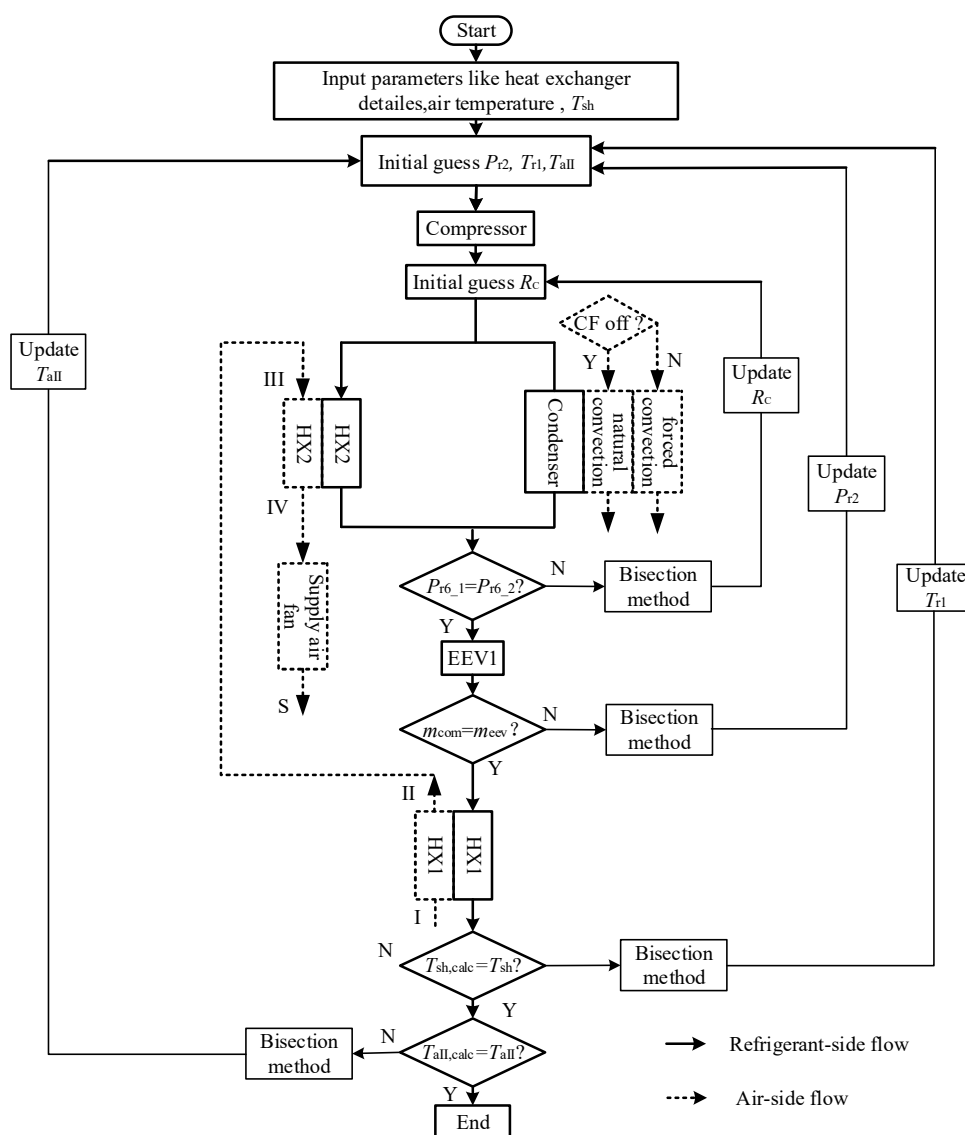

Figure 5: Flow chart of the calculation procedure of the complete EDAC system model for ADO mode

It was necessary to develop a steady-state physical-based mathematical model for the proposed EDAC system to help fully comprehend the operational characteristics of the EDAC system in different operating conditions and system configurations, which were difficult and costly to realize by using an experimental EDAC system. Therefore, a steady-state mathematical model was developed for the EDAC system at the ADO mode, taking reference to an existing single and dual-evaporator air conditioning model (Chen & Deng, 2006; Yan, Xiangguo, Liang, & Shiming, 2012).

A conceptual model of the EDAC system is shown in Figure 4. It was made up of two sub-models for its refrigerant-side and air-side, respectively. The modules in the SEAC and DEAC system (Chen & Deng, 2006; Yan et al., 2012) could be used directly when modelling the ADO mode. The outside condenser module could be transferred to HX2 module, however, there are two different issues need to be specially considered. First, in ADO mode, HX2 acted as a condenser, the heat exchange between the air and refrigerant in the HX2 would be parallel-flow typed instead of the counter-flow. Second, when the outside condenser fan was stopped, the type of the heat change would be converted from the forced convection to nature convection, thus the radiation would account for a great proportion in the heat transfer.

The component modules were combined into an overall program according to the relationship between various components. Some parameters are assumed before calculation, including the refrigerant mass flow rate through the HX2 to the total mass flow rate through compressor, R_C , the compressor discharge pressure, P_{r2} , the compressor suction temperature, T_{r1} , and the air temperature at HX1 outlet, T_{air} . The values of these parameters are found by using bisection method in the trial and error procedure, as shown in Figure 5.

4.2 Model Experimental Validation

The experimental validation of the model developed was also carried out at the same inlet air conditions in Section 3. Using the developed model, the predicted MRC, SMER and resulted supply air temperature were obtained and compared to the experimental results from Section 3, under the same experimental conditions and settings.

Figure 6 plots all the simulated results against the experimental results for the ADO mode. As seen, the model performs very well in predicting the supply air temperature, the MRC and the SMER of the EDAC system when operating at ADO mode under various inlet air conditions. The difference between the modelled data and experimental data is within $\pm 8\%$ for all the operating conditions and within 4% for 80% of the operating conditions.

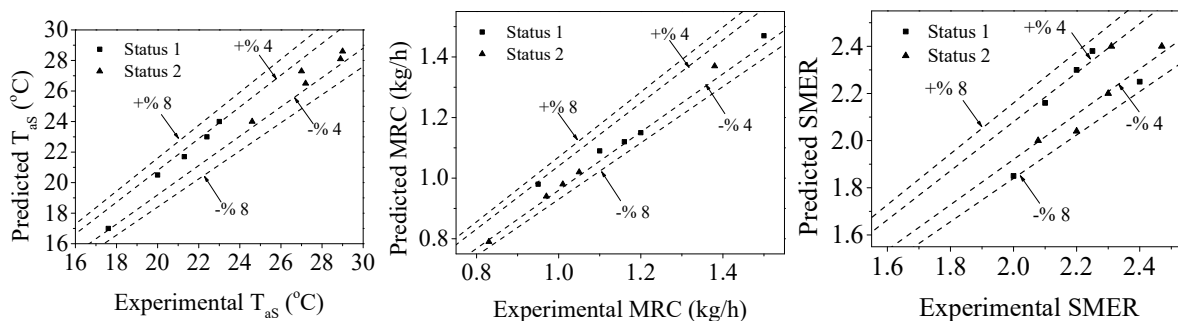

Figure 6: Modelled data versus experimental data

4.3 Model Application

The relative size of HX1 and HX2, in terms of the surface area ratio of them can affect the overall operational characteristics of the EDAC system. Using the validated model, the impacts of different surface area ratios on the operational characteristics of the EDAC system were numerically studied and are reported in this Section.

For a cooling coil, its total surface area was determined based on the peak cooling load it handled. The ratio of surface area for HX1 and HX2 (R_s) in an EDAC system was defined using Equation (3).

$$R_s = \frac{A_{HX1}}{A_{HX2}} \quad (3)$$

Where A_{HX1} is the total surface area of HX1 and A_{HX2} the total surface area of HX2.

At five different R_s values of 1:3, 2:5, 1:2, 2:3 and 1:1, the operational characteristics of the EDAC system in terms of MRC, SMER and T_{as} , at a fixed inlet air state of 26 °C and 50% RH were simulated using the validated model.

From Figure 7, it was found that as R_s increased, the supply air temperature was decreased, while both MRC and SMER increased slightly at lower R_s value and then decreased at higher R_s value. The reason was detailed as follows: A higher R_s indicated a relative large size of HX1, but a smaller one of HX2, thus resulted in a higher evaporating temperature. Consequently, the TCC of the HX1 would increase, leading to a lower air temperature at HX1 outlet. Furthermore, the reheat capacity of HX2 would be reduced due to decrease of its size, however, the increased mass flow rate due to the higher evaporating temperature in HX1 would also lead to an increased reheat capacity in HX2. Therefore, with the increase of R_s , the supplied air temperature would decrease, but not seriously. In term of MRC, a higher evaporating temperature of HX1 resulted from the increase of R_s would lead to a worse dehumidification effect in per unit area. However, the dehumidification area of the HX1 would also increase due to the larger HX1 size. At a lower R_s level, the increase of dehumidification area of the HX1 would influence more significantly on the

dehumidification capacity, leading to a slight increase in MRC. At a higher R_s level, the evaporating temperature was increased to a relative high level, thus the passing air was hard to be dehumidified, resulting in a considerable decrease in MRC. Furthermore, the variations of $SMERs$ was similar with $MRCs$.

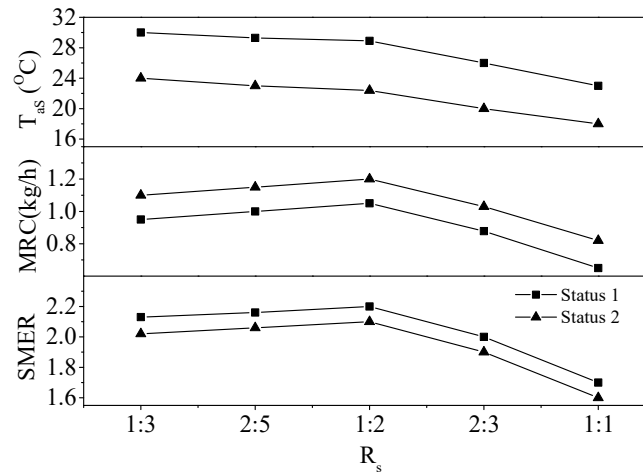

Figure 7: The operational characteristic of the EDAC system at ADO mode for the Case T-26 with different R_s values.

5. CONCLUSIONS

This paper proposes and builds up a standalone EDAC system which could suitably handle the space cooling loads encountered at different seasons in hot and humid climate, without requiring any supplementary measures to provide additional dehumidification capacity. There are two different operational modes: ADO mode and EDAC mode in the EDAC system. Through experiment and simulation study, it can be concluded that:

- On-Off controlling condenser fan could directly control indoor air temperature and indirectly control indoor air relative humidity
- The inlet air temperature and relative humidity would significantly influence the operational characteristics of the EDAC system at ADO mode, but with different patterns.
- The predicting accuracy of the developed model for ADO mode was not greater than $\pm 8\%$ in a wide range of inlet air condition. It can therefore be used as an effective platform in studying the operational performance of the EDAC system at different system configurations, like different size ratios.

NOMENCLATURE

T_{as}	supply air temperature	°C
T_i	indoor air temperature	°C
$T_{i,s(ADO)}$	indoor air temperature set point at ADO mode	°C
ΔT	temperature control dead-band	°C

Subscript

a	air
calc	calculation
cf	condenser fan
com	compressor
sf	supply fan

REFERENCES

- Alpuche, M. G., Heard, C., Best, R., & Rojas, J. (2005). Exergy analysis of air cooling systems in buildings in hot humid climates. *Applied Thermal Engineering*, 25(4), 507-517.

- Chen, W., & Deng, S. (2006). Development of a dynamic model for a DX VAV air conditioning system. *Energy conversion and management*, 47(18-19), 2900-2924.
- Eicker, U., Schneider, D., Schumacher, J., Ge, T., & Dai, Y. (2010). Operational experiences with solar air collector driven desiccant cooling systems. *Applied Energy*, 87(12), 3735-3747.
- Knight, J. T., Bellah, S. W., & Pickle, S. B. (2008). System and method for using hot gas reheat for humidity control. In: Google Patents.
- Li, Z., Chen, J., Wang, F., Cui, L., & Qu, M. (2018). A simulation study for evaluating the performances of different types of house-hold radiant air conditioning systems. *Applied Thermal Engineering*, 131, 553-564.
- Li, Z., Chen, W., Deng, S., & Lin, Z. (2006). The characteristics of space cooling load and indoor humidity control for residences in the subtropics. *Building and Environment*, 41(9), 1137-1147.
- Li, Z., & Deng, S. (2007). An experimental study on the inherent operational characteristics of a direct expansion (DX) air conditioning (A/C) unit. *Building and Environment*, 42(1), 1-10.
- Qi, Q., & Deng, S. (2009). Multivariable control of indoor air temperature and humidity in a direct expansion (DX) air conditioning (A/C) system. *Building and Environment*, 44(8), 1659-1667.
- Toftum, J., & Fanger, P. O. (1999). Air humidity requirements for human comfort. *ASHRAE transactions*, 105, 641.
- Trent, R. W. (2003). Advanced, energy efficient air conditioning, dehumidification and reheat method and apparatus. In: Google Patents.
- Wang, N., Zhang, J., & Xia, X. (2013). Desiccant wheel thermal performance modeling for indoor humidity optimal control. *Applied Energy*, 112, 999-1005.
- Xu, X., Deng, S., & Chan, M. (2008). A new control algorithm for direct expansion air conditioning systems for improved indoor humidity control and energy efficiency. *Energy conversion and management*, 49(4), 578-586.
- Xu, X., Xia, L., Chan, M., & Deng, S. (2010). Inherent correlation between the total output cooling capacity and equipment sensible heat ratio of a direct expansion air conditioning system under variable-speed operation (XXG SMD SHR DX AC unit). *Applied Thermal Engineering*, 30(13), 1601-1607.
- Yan, P., Xiangguo, X., Liang, X., & Shiming, D. (2012). A modeling study on the effects of refrigerant pipeline length on the operational performance of a dual-evaporator air conditioning system. *Applied Thermal Engineering*, 39, 15-25.
- Zhang, H., & Yoshino, H. (2010). Analysis of indoor humidity environment in Chinese residential buildings. *Building and Environment*, 45(10), 2132-2140.
- Zhang, L., & Niu, J. (2003). Indoor humidity behaviors associated with decoupled cooling in hot and humid climates. *Building and Environment*, 38(1), 99-107.

ACKNOWLEDGEMENT

The funding from The Research Grant Council (RGC) of Hong Kong (PolyU 152597 / 16E) to support the work reported in this paper is grateful acknowledged.