

Received April 25, 2017, accepted May 15, 2017, date of publication May 18, 2017, date of current version June 27, 2017.

Digital Object Identifier 10.1109/ACCESS.2017.2705638

# Exploiting Interference for Energy Harvesting: A Survey, Research Issues, and Challenges

NAN ZHAO<sup>1</sup>, (Senior Member, IEEE), SHUN ZHANG<sup>2</sup>, (Member, IEEE),  
F. RICHARD YU<sup>3</sup>, (Senior Member, IEEE), YUNFEI CHEN<sup>4</sup>, (Senior Member, IEEE),  
ARUMUGAM NALLANATHAN<sup>5</sup>, (Fellow, IEEE), AND VICTOR C. M. LEUNG<sup>6</sup>, (Fellow, IEEE)

<sup>1</sup>School of Information and Communication Engineering, Dalian University of Technology, Dalian 116024, China

<sup>2</sup>State Key Laboratory of Integrated Services Networks, Xidian University, Xi'an 710071, China

<sup>3</sup>Department of Systems and Computer Engineering, Carleton University, Ottawa, ON K1S 5B6, Canada

<sup>4</sup>School of Engineering, University of Warwick, Coventry CV4 7AL, U.K.

<sup>5</sup>Department of Informatics, King's College London, London WC2R 2LS, U.K.

<sup>6</sup>Department of Electrical and Computer Engineering, The University of British Columbia, Vancouver, BC V6T 1Z4, Canada

Corresponding author: Shun Zhang (zhangshunsdu@gmail.com)

This work was supported in part by the Xinghai Scholars Program, in part by the Fundamental Research Funds for the Central Universities under Grant DUT17JC43, and in part by the National Natural Science Foundation of China under Grant 61671101.

**ABSTRACT** Interference is one of the fundamental aspects that makes wireless communication challenging, which has attracted great research attention for decades. To solve this interference problem, many interference management (IM) techniques have been developed. Nevertheless, interference can also provide some benefits to wireless networks if it is properly utilized according to the latest research advances. Wireless signal can carry information as well as energy, and thus the redundant resource of interference can be exploited using energy harvesting (EH) to provide the power to support the operation of wireless nodes. In this paper, we provide a comprehensive survey on the research works of exploiting interference for wireless EH. Some fundamental aspects are first reviewed, including the receiver architecture, antenna dimension, network topology, and IM techniques, for wireless EH systems that exploit interference. Then, two IM techniques for wireless EH, beamforming optimization and interference alignment, are discussed in detail. In addition, several research issues are also presented, including the adversarial jamming signal and artificial noise for EH. Finally, some research challenges of exploiting interference for wireless EH are discussed.

**INDEX TERMS** Beamforming optimization, interference alignment, interference management, power splitting, simultaneous wireless information and power transfer, time switching, wireless energy harvesting.

## I. INTRODUCTION

Interference and fading are the two fundamental problems of wireless networks that make wireless transmission challenging [1]. For fading, there have been plenty of proven methods to handle it; while for interference, the problem can become intractable, and researchers have studied this aspect for decades. *Interference* used to be deemed as a negative factor for wireless networks, which will disrupt the information transmission greatly if not properly managed. Therefore, interference management (IM) has always been one of the key topics in wireless networks [2]. Some conventional methods of IM are to divide wireless resources into several orthogonal fractions, and each user can only access one fraction, e.g., frequency-division multiple access (FDMA), time-division multiple access (TDMA), and orthogonal FDMA (OFDMA). To further improve the spectrum efficiency of OFDMA, non-orthogonal multiple

access (NOMA) is developed recently [3], which is a potential technique of the 5th generation (5G) cellular systems. In addition, other IM techniques have also been proposed, and an important one is interference alignment (IA) [4], [5].

Nevertheless, the role of interference in wireless networks is turning from adversarial to beneficial gradually [6], thanks to the recent research advances in *wireless energy harvesting* (EH) [7], [8]. Wireless signal can carry information as well as energy [9], [10], and thus the redundant resource of interference can be further exploited for wireless EH, which is an important aspect to achieve green communications by providing power supply for wireless nodes [11]. Especially, in the future 5G and Internet of things (IoT) systems, a huge number of wireless devices are deployed in a small area [12], [13], i.e., ultra-dense networks, and the interference among users is severe, which should be well managed to exploit interference for wireless EH with the quality of

service (QoS) of information transmission (IT) guaranteed. Therefore, interference has two sides. On one hand, it will affect the transmission of information. On the other hand, it can be exploited for EH.

There are mainly three methods to achieve wireless EH, i.e., near-field methods including resonant inductive coupling [14], [15], magnetic resonance coupling [16], [17], and far-field method using radio-frequency (RF) energy harvesting [8], [18], [19]. These methods have been studied extensively [8], [20]–[23]. In this paper, we mainly focus on RF energy harvesting, because it is the only one among the three methods that is suitable for long-distance energy transfer. In RF energy harvesting, information is usually transferred together with energy, as simultaneous wireless information and power transfer (SWIPT) [24].

One of the key challenges in wireless EH systems exploiting interference is interference management, i.e., the interference should be properly managed to guarantee both IT and EH performance with less transmission power. One method for interference management in wireless EH systems is to jointly design the beamforming matrix and the PS ratio [25], [26], [26]–[32], [32]–[35], in which the total transmit power is minimized with IT and EH requirements guaranteed. Due to the non-convex nature of the problem, it is very difficult to solve, and many suboptimal algorithms were developed with lower computational complexity, e.g., semi-definite programming and second-order cone programming. Another method for interference management in wireless EH systems is IA [4], [5], through which the capacity of interference networks can be approached at high signal-to-noise ratio (SNR). In IA-based wireless EH [30], [36]–[45], IA is performed first, and then the received power at each receiver is divided into two parts, one for EH and the other for ID according the decoding matrix of IA. The optimization problem of IA-based wireless EH systems is much easier to solve, since the beamforming matrices have already been obtained by IA.

In this paper, we provide a comprehensive survey on the research works of exploiting interference for wireless EH. Particularly, we discuss five important aspects of exploiting interference for wireless EH: fundamentals of wireless EH, wireless EH systems exploiting interference, interference management techniques, research issues, and open research challenges. A taxonomy graph of our paper towards the design and analysis of exploiting interference for wireless EH is presented in Fig. 1. To the best of our knowledge, this is the first comprehensive survey on exploiting interference for wireless EH.

In the following, we will elaborate on these aspects and discuss the related issues. In Section II, fundamentals of wireless EH will be presented. In Section III, wireless EH systems exploiting interference will be reviewed and categorized, including receiver architecture, antenna dimension, network topology, and interference management. In Section IV, two important interference management techniques for wireless EH will be shown, i.e., beamforming

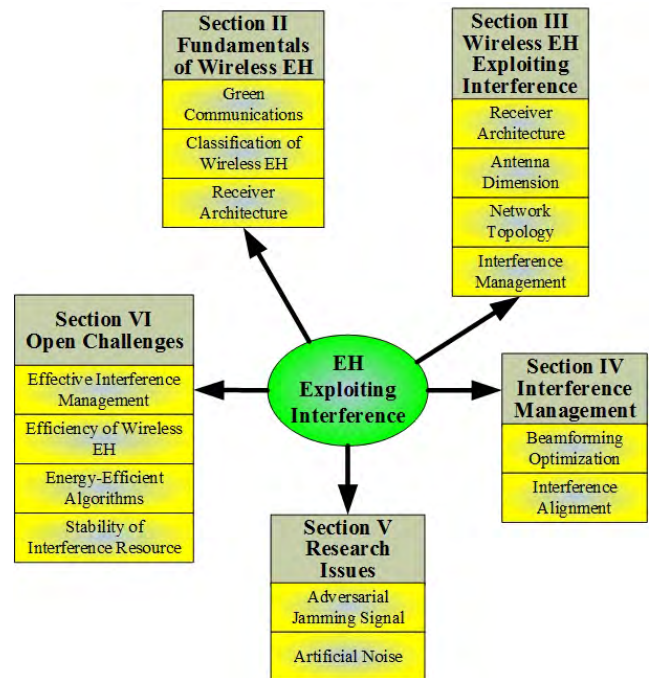

FIGURE 1. Technical roadmap of exploiting interference for wireless EH : A taxonomy graph.

optimization and interference alignment. Some interesting research issues will be presented in Section V, including adversarial jamming signal for EH and artificial noise (AN) for EH. In Section VI, some open research challenges of exploiting interference for wireless EH will be summarized, and finally, we conclude this study in Section VII. Table 1 provides a list of the acronyms used in this paper.

## II. FUNDAMENTALS OF WIRELESS ENERGY HARVESTING

In this section, fundamentals of wireless EH are introduced, especially the two working modes for SWIPT, i.e., power splitting and time switching.

Due to the rapid increase of energy consumption in information and communication industries, green communications have attracted a lot of research interest [46], [47]. There are mainly two kinds of methods to achieve green communications. One is to deliver more information with less energy, which is known as energy efficiency [48]–[50]. The other one is to power the mobile node or to replenish the rechargeable battery by collecting and then converting the energy from ambient environments, such as wind power, solar power, vibration power, thermal power and wireless power, which is called energy harvesting [20], [22], [51], as shown in Fig. 2. One important part of EH is wireless EH [8], [18], [19], through which the ambient or dedicated radio signals can be received and converted into electricity.

Basically, there are three kinds of methods to achieve wireless EH, including resonant inductive coupling [14], [15], magnetic resonance coupling [16], [17] and RF energy harvesting [8], [18], [19]. The first two kinds of methods are based on magnetic coupling between two coils or two resonators, through which the energy is transferred. Thus,

TABLE 1. List of acronyms.

Acronym	Full form
5G	5th Generation
AN	Artificial Noise
CSI	Channel State Information
DC	Direct Current
EH	Energy Harvesting
FCC	Federal Communications Commission
FDMA	Frequency-Division Multiple Access
IA	Interference Alignment
ID	Information decoding
IM	Interference Management
IoT	Internet of Things
IT	Information Transmission
MIMO	Multiple-Input and Multiple-Output
MISO	Multiple-Input and Single-Output
MRT	Maximum Ratio Transmission
NOMA	Non-Orthogonal Multiple Access
OFDMA	Orthogonal Frequency-Division Multiple Access
PA	Power Allocation
PD	Primary Destination
PSO	Power-Splitting Optimization
PT	Primary Transmitter
QoS	Quality of Service
RF	Radio-Frequency
SD	Secondary Destination
SIMO	Single-Input and Multiple-Output
SINR	Signal-to-Interference-plus-Noise Ratio
SISO	Single-Input and Single-Output
SNR	Signal-to-Noise Ratio
SR	Secondary Relay
ST	Secondary Transmitter
SWIPT	Simultaneously Wireless Information and Power Transfer
TDMA	Time-Division Multiple Access
ZF	Zero-Forced / Zero-Forcing

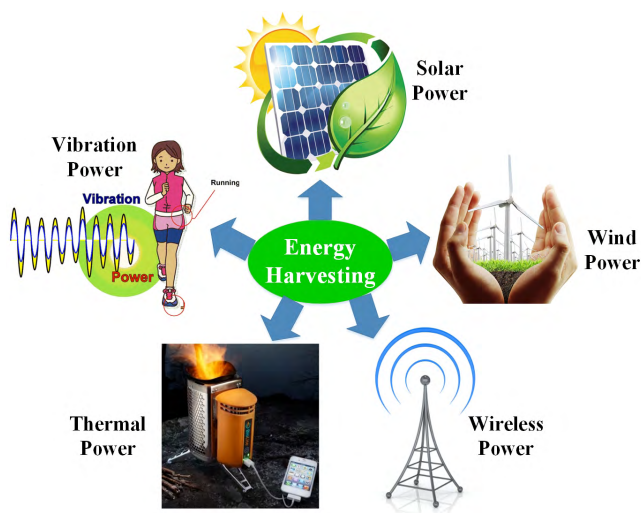

FIGURE 2. Demonstration of several kinds of methods for energy harvesting in wireless networks.

the methods of resonant inductive coupling and magnetic resonance coupling are near-field wireless energy transmission, and they are not suitable for long-distance transmis-

sion, e.g., longer than a few meters, because the attenuation of power strength is extremely severe with longer distance. In contrast, the wireless RF energy harvesting is a kind of far-field wireless energy transmission, and it is more suitable to be applied in the long-distance and mobile scenarios. Thus in this paper, we mainly focus on the wireless RF energy harvesting, in which interference is an important kind of energy source.

Another reason why we adopt wireless RF energy harvesting in mobile networks is that information is also carried by wireless RF signals, together with energy. Thus information and energy can be retrieved at the receivers at the same time from wireless RF signals, and we call this simultaneous wireless information and power transfer. Some initial works of SWIPT were done in [9], [10], and it was widely studied and spread by Zhang and Ho [7], Zhou *et al.* [52], and Liu *et al.* [53]. To achieve SWIPT, the received signal at each receiver should be utilized for both IT and EH, and there are two classical receiver architectures, i.e., time-switching and power-splitting [7], as shown in Fig. 3.

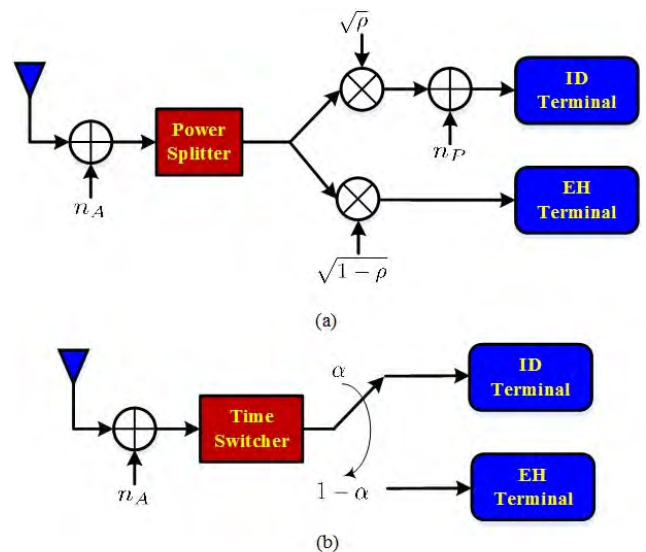

FIGURE 3. Receiver architecture for SWIPT with a single antenna. (a) Power-splitting mode; (b) time-switching mode.

When the PS mode is adopted in Fig. 3(a), the received signal by the antenna is first corrupted by the channel noise  $n_A$ . The signal is then fed back to the power splitter, through which the signal is divided into two parts, one for ID and the other for EH.  $\rho$  defines the portion of received power that is split to the ID terminal, and thus  $1 - \rho$  portion of the received power is split to the EH terminal. During the process in the ID terminal, another noise  $n_P$  is also introduced that can affect the decoding performance of the ID terminal. In the EH terminal, the received signal is converted into electricity power to be utilized or stored. The channel noise  $n_A$  is negligible when EH is performed, and thus can be ignored in the EH terminal. When the TS mode is considered as Fig. 3(b), each transmission frame is divided into two

time slots, one for information transmission and the other for power transfer. Thus, the received signal is fed back to the ID and EH terminals periodically through a time switcher at each receiver.  $0 < \alpha < 1$  is the percentage of transmission time in each frame, and  $1 - \alpha$  is the percentage of EH time. Fig. 3 depicts a single-antenna case. When multiple antennas are equipped at each receiver, the PS or TS method can be similarly performed at each antenna, and the divided ID signals and EH signals of these antennas at a specific receiver are fed back to the ID and EH terminals using the same coefficient  $\rho$  or  $\alpha$ .

Comparing TS and PS modes, the TS mode is much simpler to realize than the PS mode [7]. Nevertheless, it is shown theoretically that the PS mode can achieve much better tradeoffs between transmission rate and harvested energy [7], [52]. Besides, accurate time synchronization between the transmitter and receiver is required in the TS mode, and the receiver should adjust its switching function according to the time information of transmitter. Therefore, in the practical systems, the PS mode is more suitable to be utilized than the TS mode, and most of the research works are based on the PS mode.

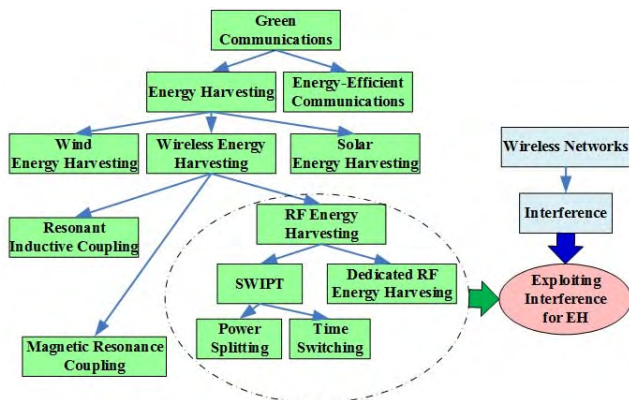

FIGURE 4. Logic map of the research on exploiting interference for energy harvesting.

Interference is ubiquitous and adequate in the wireless networks, including the interference between multi-users and the dedicated interference like jamming signal and artificial noise [45], [54]. Thus the interference can be exploited as a perpetual energy source for wireless EH systems, and the logic map of the topic in this paper, i.e., exploiting interference for EH, is presented in Fig. 4. In the rest of this paper, we will mainly concentrate on the aspect of interference-based wireless EH systems.

### III. EXPLOITING INTERFERENCE FOR WIRELESS ENERGY HARVESTING

Interference is ubiquitous in wireless networks, and it used to be deemed as a harmful factor that can affect the QoS of the information transmission [2]. Many techniques have been developed to mitigate the influence of interference on the performance of wireless networks, e.g., orthogonal multiple access, interference alignment [4], [5], interference cancellation [55], dirty paper [56], etc. On the other hand, inter-

ference is also a kind of RF signal, which can carry energy together with information. Thus the harmful interference can be exploited as a helpful energy source for wireless energy harvesting. A pictorial illustration of exploiting ambient interferences for wireless EH is shown in Fig. 5.

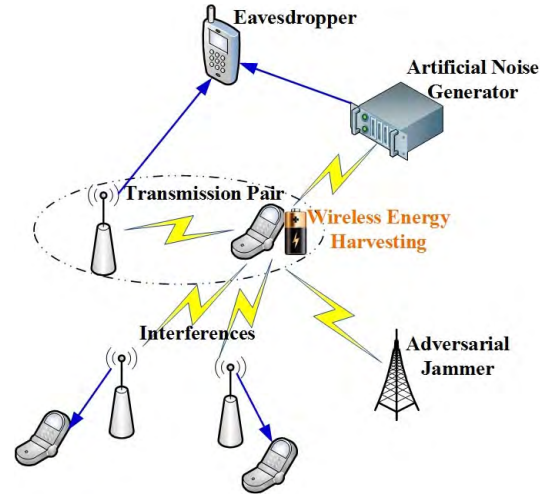

FIGURE 5. Pictorial illustration of exploiting ambient interferences for wireless energy harvesting.

In the figure, it is shown that the signals transmitted by other users will affect the transmission of a specific transceiver as interferences, which can be harvested by the receiver to support its operation and recharge the battery. This is especially suitable in the scenarios of hyper-dense small-cell networks, where plenty of users coexist in a limited area, and the interferences from other users are very strong. One key challenge to exploit interference for wireless EH is that the interference should be perfectly eliminated to recover the transmitted information and harvest energy. Besides, when there exists an adversarial jammer that intends to disrupt the legitimate transmission of the network, its transmit power is usually very high, and the jamming signal can be properly managed and harvested to support the legitimate receiver. When the security of wireless networks is considered, artificial noise can be generated to disrupt the potential eavesdroppers, without affecting the legitimate transmission. Thus the AN can be re-utilized as energy source that is harvested by the legitimate receivers.

In this section, the classifications and applications of wireless EH systems exploiting interference are demonstrated in detail as in Table 2, including receiver architecture, antenna dimension, network topology, and interference management.

#### A. RECEIVER ARCHITECTURE

There are mainly three kinds of receiver architectures of exploiting interference for wireless EH [7], i.e., power splitting [25], [27]–[37], [40], [42], [45], [57]–[65], time switching [38], [41], [43], [44], [65]–[70], and separated ID and EH [71]–[79], which are discussed as follows.

**TABLE 2. Classifications and applications of wireless energy harvesting systems that exploit interference.**

	Classifications and Applications		Remark	References
Energy Harvesting Exploiting Interference	Receiver Architecture	Power Splitting	Most used	[25], [27]–[37], [40], [42], [45], [59]–[67]
		Time Switching	Strict synchronization	[38], [41], [43], [44], [67]–[72]
		Separated ID and EH	Not suitable for SWIPT	[73]–[81]
	Antenna Dimension	SISO	Interference not eliminated	[33], [59], [60], [62], [68], [79]
		MISO	Downlink	[25]–[29], [31], [32], [61], [82]
		SIMO	Not suitable	[66]
		MIMO	Most used	[30], [36]–[44], [63], [69], [73], [75]–[78], [81], [83]
		Massive MIMO	Future direction	[84]
	Network Topology	Interference Network	Most researched	[25], [27]–[33], [36]–[38], [40]–[44] [59]–[63], [68]–[71], [73]–[81]
		External Interference	Need not manage interference	[45], [64], [66], [67], [84], [85]
		Broadcast Network	Downlink	[26], [82]
		Relay-Based Network	Relay should be well powered	[34], [35], [65], [67], [72], [85]
	Interference Management	Beamforming Optimization	Optimal, but Complex	[25]–[35]
Interference Alignment		No interference, easy to optimize	[30], [36]–[45], [56]	
Interference Cancellation		Not widely researched	[24]	

1) POWER SPLITTING

At the receiver for SWIPT based on the PS mode, both an ID terminal and an EH terminal are equipped at each receiver, and the SWIPT exploiting interference can be achieved through a power splitter [25], [27]–[37], [40], [42], [45], [57]–[63], [65], as shown in Fig. 3(a). With the help of the power splitter, one part of the received power that contains both information and interference is fed to the ID terminal, and the other part is split to the EH terminal. In most of the research works, the PS ratios of all the antennas of a certain receiver are set to be equal. Nevertheless, in some works, the PS ratios of different antennas of a certain receiver can be different and are also optimized to improve the performance with relatively high complexity, which is called independent power splitting [64]. The independent power splitting is much more difficult to optimize for better performance.

2) TIME SWITCHING

In the time-switching architecture for SWIPT exploiting interference, both an ID terminal and an EH terminal are equipped at each receiver, and the received signals and interferences are devoted to either the ID terminal and EH terminal in different time slots periodically through a time switcher as shown in Fig. 3(b) [38], [41], [43], [44], [65]–[70]. Besides, the TDMA and user selection modes can also be deemed as a kind of time switching.

3) SEPARATED ID AND EH

The third kind of receiver architecture for wireless EH systems exploiting interference is the mode of separated ID and EH [71]–[79], with only one ID or one EH terminal equipped at each receiver, i.e., each receiver can be devoted to either ID or EH. Thus, it incurs a huge amount of hardware complexity, but can be a good choice for wireless EH.

Comparing these three receiver architectures, the TS mode is the easiest one to achieve. However, strict time synchronization among users is required, which is difficult to ensure, and it is more sensitive to system parameters than the PS mode. For the mode of separated ID and EH, one receiver can only decode the information or harvest the energy, and thus it is not flexible to utilize. Therefore, the PS mode is the most popular receiver architecture for wireless EH systems that exploit interference.

**B. ANTENNA DIMENSION**

Interference oriented wireless EH can be achieved with different antenna dimensions, e.g., single-input and single-output (SISO) [33], [57], [58], [60], [66], [77], multiple-input and single-output (MISO) [25]–[29], [31], [32], [59], [80], single-input and multiple-output (SIMO) [64], multiple-input and multiple-output (MIMO) [30], [30], [36]–[44], [61], [67], [71], [73]–[76], [79], [81], and massive MIMO [82].

1) SISO

Only a few research works have concentrated on the wireless EH problem in SISO multi-user networks [33], [57], [58], [60], [66], [77], due to the fact that beamforming at the transmitters and decoding at the receivers cannot be performed in the multi-user network with only a single antenna at each transceiver. Thus, in the SISO multi-user network for wireless EH, the transmitted information cannot be recovered perfectly with the residual interference, and the QoS of transmission is affected, although EH still can be performed. With the development of wireless communications, the techniques of multiple antennas are widely adopted, and we can leverage the benefit of multi-antenna to manage interference while performing wireless EH.

## 2) MISO

MISO is widely adopted in the SWIPT of interference networks. This is because that it can be utilized in the downlink of cellular networks, where more antennas are equipped at the transmitters that serve as base stations, and only a single antenna is equipped at each receiver to guarantee the mobility of end users. In addition, when the antennas at each transmitter is adequate, i.e., the number of antennas at each transmitter is no less than that at each receiver, the interference at a specific receiver can be zero-forced (ZF) by beamforming at the transmitter [32], and the SWIPT can be performed without interference. Some other beamforming schemes can also be adopted, like the maximum ratio transmission (MRT) [32], and in [28] the ZF beamforming and the MRT beamforming are combined to achieve SWIPT in MISO interference networks. Nevertheless, the requirement of number of antennas at each transmitter is high in the ZF scheme, and there may not be enough antennas to perform perfect zero-forcing in practical systems. Thus the beamforming matrices are optimized jointly with power splitting in many research works [25]–[27], [29], [31], [59], [80], to minimize the transmit power with the requirements of QoS of information transmission and energy harvested satisfied.

Besides, there are some other research works on the wireless EH technique that exploits interference in MISO networks. In [74], [79], and [80], the scenario of two users is considered, in which one receiver is adopted only for IT, and the other receiver is dedicated to EH. By separating the ID terminal and EH terminal in different receivers, SWIPT and interference management are much easier to achieve together. However, the receivers are limited to realize either IT or EH, which is not flexible. Another method to perform interference management and SWIPT is to utilize TDMA scheme [68], [69], which can also be considered as a kind of TS mode, i.e., each receiver is dedicated to either ID or EH at each time slot, and these schemes are much easier to achieve. However, when the number of users becomes larger, the time synchronization among users becomes much more complicated.

## 3) SIMO

From theoretical analysis, the SIMO model can be adopted to perform SWIPT when interferences exist. This is because zero-forcing can be performed at each multiple-antenna receiver to manage interference as well as harvest energy. However, there are quite a few research works focusing on exploiting interference for wireless EH [64], and the reasons are as follows.

- When SIMO is adopted, it is suitable to be utilized in the uplink of cellular networks, due to the fact that more antennas should be equipped at the base stations instead of mobile users. The base stations are usually connected to the grid, and thus the power supply is sufficient, while the mobile users are usually powered by batteries to guarantee the mobility. Thus, it is not reasonable to harvest energy at the base stations from

mobile users in SIMO based systems, although SWIPT can be performed in the SIMO interference networks.

- In the SIMO interference networks, when wireless EH is performed, the energy is transferred by some single-antenna transmitters to the multiple-antenna receivers. This is difficult to achieve, because little energy can be generated and emitted by only a single antenna, which is far from sufficient to be harvested by so many antennas at the receivers. Thus the MISO system is more suitable to perform wireless EH than SIMO, where multiple antennas generate and emit energy that is harvested by a single-antenna end.

## 4) MIMO

MIMO technology is widely utilized in the modern wireless networks, as the rapid development of the multi-antenna techniques. Thus, most of the research works on wireless EH in interference networks are based on MIMO systems. There are mainly two methods to achieve this, i.e., to optimize the beamforming matrices [30], [61], [67], [71], [73]–[76], [79], [81], and to design the SWIPT scheme based on some interference management technologies such as interference alignment [30], [36]–[44] and interference cancellation [24]. When the beamforming matrices and PS ratios are jointly optimized, the interferences at each receiver are not perfectly eliminated, instead, the best performance is sought by the joint optimization. Usually, the sum transmit power of the network is minimized with both of the QoS and EH thresholds satisfied. Exploiting interference for wireless EH when adopting beamforming optimization will be demonstrated in Section IV-A in detail. When IA is adopted to achieve the SWIPT in interference networks, the interferences at each receiver can be eliminated completely, and some part of the received signal is split for EH. The wireless EH in IA-based networks will be demonstrated in Section IV-B in detail.

## 5) MASSIVE MIMO

Massive MIMO is a key technique for the future 5G mobile networks. Interference can also be exploited for the wireless EH in massive MIMO based interference systems, in which the interferences among users can be collected as power source by the receiver with massive antennas. Although only quite a few research works are done on this aspect [82], the direction of wireless EH in massive MIMO is growing up [84]–[86], and thus interference oriented wireless EH based on massive MIMO will attract more interest in the future.

## C. NETWORK TOPOLOGY

In the existing research works, interference has been exploited for wireless EH in different kinds of network topologies, e.g., interference network [25], [27]–[33], [36]–[38], [40]–[44], [57]–[61], [66]–[69], [71]–[79], external interference outside the network [45], [62], [64], [65], [82], [83], broadcast network [26], [80], relay-based multi-user network [34], [35], [63], [65], [70], [83], etc.

### 1) INTERFERENCE NETWORK

Interference network is the fundamental kind of topology for multi-user network [87], in which each transmitter sends independent information to its corresponding receiver, and the signals received at the undesired receiver are deemed as interferences. Therefore, most of the research works on the interference-based wireless EH is developed in interference networks, in which the interferences among users can be further exploited as a source of energy supply for wireless EH, as shown in Fig. 6, with the information decoding also performed.

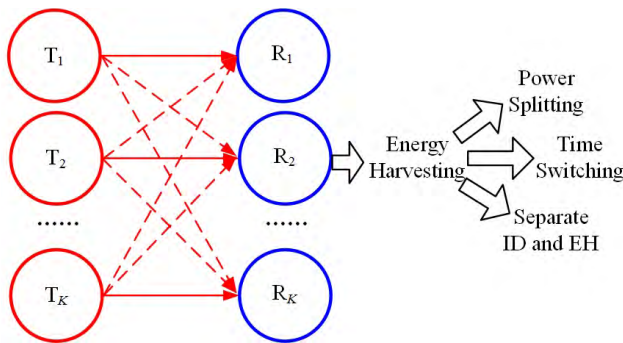

FIGURE 6. An interference network for wireless energy harvesting that exploits interference.

There are mainly three methods to achieve wireless EH in interference networks. For the first one, the ID and EH can be performed simultaneously at each user, through the receiver architecture of PS as shown in Fig. 3(a) [25], [27]–[33], [36], [37], [40], [42], [57]–[61]. In the second method, both ID and EH terminals are equipped at each receiver, and the TDMA, the user selection, and the TS mode can be all classified as this method, which is shown in Fig. 3(b) [38], [41], [43], [44], [66]–[69]. In this method, the receiver either operates in the EH function or in the ID function at a certain time slot, and the functions will be switched among users over different time slots. In the last method, each receiver is dedicated to either ID or EH, and the function of each receiver cannot change in different time slots [71]–[79]. That is to say, at some receivers, only ID can be performed, and at other receivers, only EH can be achieved. Among these three methods, the PS mode is most used, because it can be realized easily without the requirement of accurate time synchronization.

### 2) EXTERNAL INTERFERENCE OUTSIDE THE NETWORK

In the interference network, the interferences among users can be adopted as an energy supply for wireless EH. Nevertheless, sometimes, the interference does exist, and we cannot definitely know where it comes from. Thus some research works are done on this aspect, in which SWIPT is considered in a certain network, with some external interferences as potential energy source [45], [62], [64], [65], [82], [83], as show in Fig. 7. The external interferences can be some signals from other networks or cells, or some adversarial

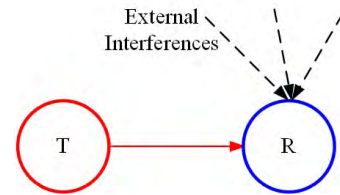

FIGURE 7. Wireless energy harvesting system that exploits external interference outside the network.

TABLE 3. Summary of the methods of wireless energy harvesting with external interferences.

Network Types	References
Point-to-Point Transmission Link	[64], [66]
Massive MIMO system	[84]
Relay System	[67], [85]
Anti-Jamming Network	[45]

jamming signals outside the network, which are summarized as Table 3.

In [64] and [62], interference and transmitted information were adopted to perform SWIPT at the receiver of a point-to-point pair through using the PS architecture, with SIMO and SISO adopted, respectively. In [82], the external interference was utilized along with the transmitted signal as a energy supply for SWIPT in a massive MIMO system. Relay system was also considered in [83] and [65], in which the power-constrained relay harvests wireless energy from the external interference and transmitted signal from the source, and then performs information processing in the TS or PS mode. In [45], an anti-jamming IA network was proposed, in which the external jamming signal can be exploited as a source of wireless energy to be harvested with the QoS of IA users satisfied, through the PS mode.

### 3) BROADCAST NETWORK

Broadcast network is usually adopted in the downlink of cellular networks [88], in which a multi-antenna transmitter serves as the base station, and some receivers with less antennas are mobile users. In the broadcast network, the transmitted signals from the base station to other mobile users are interferences for a specific user, which should be properly managed or even completely eliminated to guarantee the QoS of each user by beamforming. However, the interferences among mobile users can be also deemed as an adequate source of energy supply, and utilized for wireless EH for the mobile users, as shown in Fig. 8. In [26] and [80], constructive interference in MISO broadcast networks was leveraged to improve the performance of information detection, and was also utilized as a energy supply for wireless EH.

Although there exist only a few research works on this aspect [26], [80], it is reasonable and suitable to achieve wireless EH in broadcast networks. This is due to the fact that the base station can be the energy transmitter, with sufficient

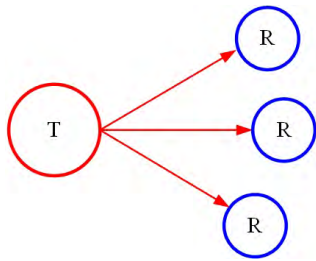

**FIGURE 8.** Broadcast network for wireless energy harvesting that exploits interference.

power supply from the power grid, while for the mobile users, the power supply is limited due to the size of batteries, and wireless power supply is needed much more urgently. Thus, we believe that this direction is promising in the future.

4) RELAY-BASED NETWORK

Wireless relaying is widely used in modern wireless networks [89], [90], and it can extend the network coverage by receiving the transmitted signal from the source and then forwarding it to the destination with or without any further processing. Nevertheless, the relays are usually equipped flexibly without connecting to the grid, and thus its power supply is one of the key challenges. Thus, in some of the research works, the interferences from ambient environment or other users can be exploited by the relays as an abundant power supply for wireless EH. In [65], [67], and [85], a wireless system with one source, one relay and one destination was considered as shown in Fig. 9(a), and the interference from ambient environment is collected to support the operation of the relay through wireless EH. The relaying interference network was considered in [34] and [35] as shown in Fig. 9(b), in which multiple transmitters send independent information to their corresponding receivers through multiple relays. In the network, the relays harvest energy from the transmitted signals of the transmitters, to support the operations of the relays. In [70], a cognitive radio network was considered as shown in Fig. 9(c), where a secondary relay (SR) is utilized to assist the communication between the secondary transmitter (ST) and secondary destination (SD). In the system, the interferences from the primary transmitters (PTs) are harvested as power supply for the secondary relay (SR).

**D. INTERFERENCE MANAGEMENT TECHNIQUE**

When interference is considered in the research of SWIPT, it is very important to guarantee the requirements of both IT and EH, with the transmit power relatively low. Thus the interference management is a key challenge in the interference-based wireless EH systems [2]. There are mainly two kinds of method to achieve interference management for wireless EH systems, i.e., beamforming optimization [25]–[32], [32]–[35] and interference alignment

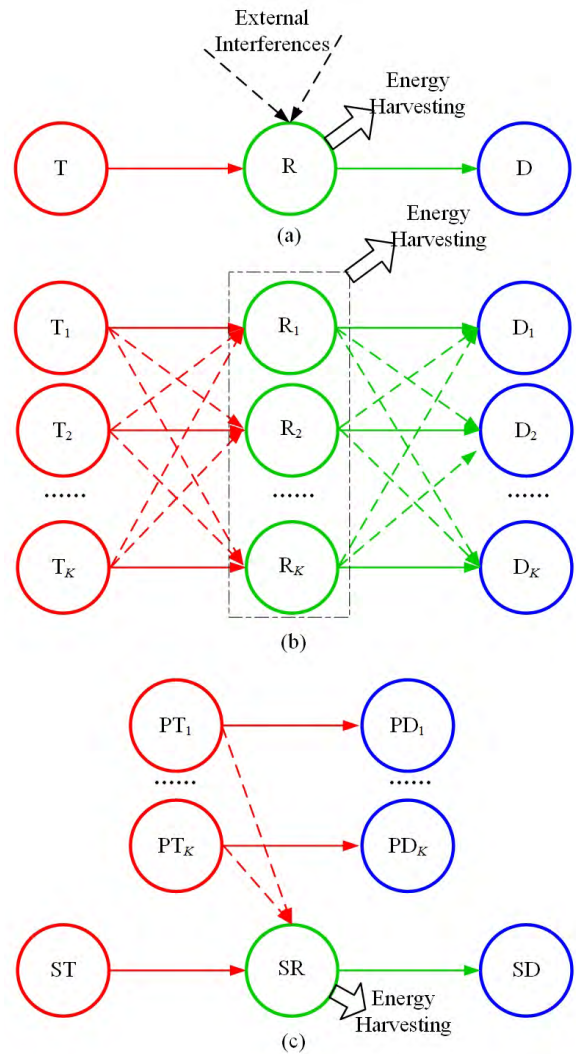

**FIGURE 9.** Three types of wireless energy harvesting in relay-based systems that exploit interference.

[30], [36]–[45]. In addition, interference cancellation has also been applied to the interference management for wireless EH [24].

1) BEAMFORMING OPTIMIZATION

The most natural idea to perform wireless EH in interference networks is to optimize the beamforming matrices of the transmitters, usually, jointly with the PS ratios. In most of the research works, the beamforming and power splitting are jointly optimized to minimize the total transmit power of the network with the QoS and EH requirements of each users satisfied. Nevertheless, the optimization problems in these works are non-convex, and some suboptimal solutions should be derived with lower computational complexity [25]–[32], [32]–[35]. More details about the beamforming optimization based wireless EH will be presented in Section IV-A.



## 2) INTERFERENCE ALIGNMENT

Interference alignment is an excellent interference management technique that has emerged in recent years [4], [5]. It can approach the capacity of interference channel at high SNRs. In IA-based networks, the interferences are constrained into certain subspaces at the undesired receivers, and thus the information can be decoded free of interference at the target receiver [91]. When it is adopted for wireless EH in interference networks, perfect IA is first performed, and then the received signal is split into two parts, one for ID and the other for EH [30], [36]–[45]. More details about the IA-based wireless EH will be demonstrated in Section IV-B.

## 3) INTERFERENCE CANCELLATION

The method of interference cancellation can also be adopted to solve the interference management problem in the wireless EH systems exploiting interference [24], however, it is not as widely researched as the above two methods.

## IV. INTERFERENCE MANAGEMENT FOR WIRELESS ENERGY HARVESTING BASED ON INTERFERENCE

The most important task for wireless EH systems that exploit interference is interference management [2]. This is due to the fact that information should also be transmitted along with energy, and interference will degrade the performance of IT but help the EH [92]. Proper interference management will significantly improve the performance of both IT and EH, and it should be carefully designed to obtain better performance with lower computational complexity. Generally speaking, there are mainly two kinds of methods to achieve interference management in wireless EH systems based on interference, i.e., beamforming optimization [25]–[35] and interference alignment [30], [36]–[45], [54], which will be discussed in detail in this section.

### A. BEAMFORMING OPTIMIZATION

Interference should be properly managed when it is exploited for SWIPT, for the reason that information should also be transmitted along with energy, which will be affected by the interferences. A natural method is to design the beamforming matrices of the transmitters to minimize the influence of the interference for better performance of IT and EH. Besides, wireless EH is usually achieved by the PS architecture, and the performance of IT and EH should be optimized by jointly designing the PS ratio and the beamforming matrices. Therefore, the beamforming and PS ratio should be jointly optimized, and usually the total transmit power should be minimized with the requirements of IT and EH satisfied. For example, the optimization function in [30] can be expressed as

$$\begin{aligned} & \min_{\{\mathbf{v}^{[k]}, \rho^{[k]}, \mathbf{u}^{[k]}\}} \sum_{k=1}^K \|\mathbf{v}^{[k]}\|^2 \\ & \text{s.t. SINR}^{[k]}(\mathbf{v}^{[k]}, \mathbf{u}^{[k]}, \rho^{[k]}) \geq \gamma^{[k]}, \end{aligned}$$

TABLE 4. Methods of deriving the suboptimal algorithms for joint beamforming and power-splitting optimization.

Methods	References
Semi-definite programming	[25], [28], [30] [26], [27], [29]
Second-order cone programming	[26], [31], [32]
Linear programming	[32]
Game	[33]–[35]

$$\begin{aligned} Q^{[k]}(\mathbf{v}^{[k]}, \rho^{[k]}) & \geq e^{[k]}, \\ 0 < \rho^{[k]} < 1, \quad \|\mathbf{u}^{[k]}\|^2 & = 1, \quad k \in \mathcal{K}, \end{aligned} \quad (1)$$

where

$$\begin{aligned} \text{SINR}^{[k]} & = \frac{\rho^{[k]} |\mathbf{u}^{[k]\dagger} \mathbf{H}^{[kk]} \mathbf{v}^{[k]}|^2}{\sum_{j \neq k} \rho^{[k]} |\mathbf{u}^{[k]\dagger} \mathbf{H}^{[kj]} \mathbf{v}^{[j]}|^2 + \rho^{[k]} \sigma^2 \|\mathbf{u}^{[k]}\|^2 + \delta^2 \|\mathbf{u}^{[k]}\|^2}, \end{aligned} \quad (2)$$

and

$$Q^{[k]} = \zeta \left(1 - \rho^{[k]}\right) \sum_{j=1}^K \|\mathbf{H}^{[kj]} \mathbf{v}^{[j]}\|^2, \quad k \in \mathcal{K}. \quad (3)$$

In (1)–(3),  $\mathbf{v}^{[k]}$  and  $\mathbf{u}^{[k]}$  are the precoding and decoding vectors of the  $k$ th user, respectively, and  $\rho^{[k]}$  is the PS ratio.  $\text{SINR}^{[k]}$  and  $Q^{[k]}$  are the received signal-to-interference-plus-noise ratio (SINR) and the harvested power of the  $k$ th user, respectively.  $0 < \zeta < 1$  denotes the efficiency of power conversion at the EH terminal.  $\mathbf{H}^{[kj]}$  represents the complex channel matrix from the  $j$ th transmitter to the  $k$ th receiver.  $\sigma^2$  and  $\delta^2$  are the noise power introduced by the antennas and the ID terminal, respectively.

In (1),  $\|\mathbf{v}^{[k]}\|^2$  also represents the transmit power of the  $k$ th user. Therefore, according to the optimization, the total transmit power is minimized by jointly optimizing  $\mathbf{v}^{[k]}$ ,  $\mathbf{u}^{[k]}$  and  $\rho^{[k]}$ , with the targets of received SINR and harvested power satisfied. In addition, we can see that the beamforming vector and the PS ratio are twisted together in the above optimization function, and thus it is a non-convex problem which is very difficult to solve. To achieve the non-convex optimization problem in (1), we should derive some sub-optimal algorithms with much lower computational complexity. In the existing research works, semi-definite programming, second-order cone programming, linear programming and game have been utilized to solve the problem (1), which is further presented in Table 4.

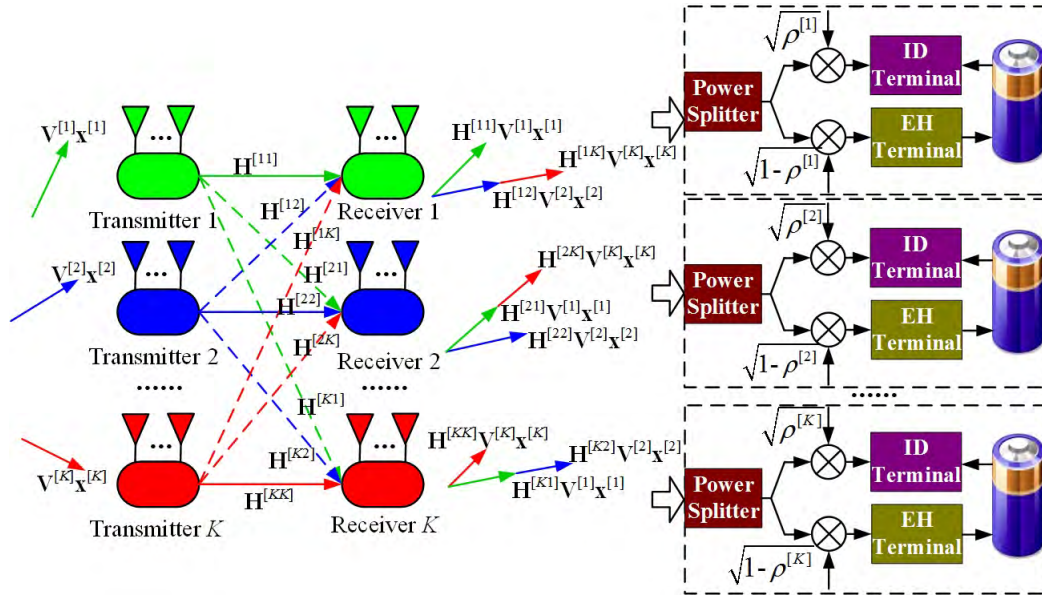

FIGURE 10. Demonstration of the IA-based wireless energy harvesting.

**B. INTERFERENCE ALIGNMENT**

IA is an effective interference management technique for interference networks [4], [5], [91], in which the interferences are constrained into certain subspaces at all the receivers by the precoding matrices cooperatively, and thus the information can be recovered free of interference through decoding. The interference can be perfectly eliminated when IA is feasible [93], with the following conditions satisfied.

$$\mathbf{U}^{[k]\dagger} \mathbf{H}^{[ki]} \mathbf{V}^{[i]} = \mathbf{0}_{d^{[k]} \times d^{[i]}}, \quad \forall i \neq k, \quad (4)$$

$$\text{rank} \left( \mathbf{U}^{[k]\dagger} \mathbf{H}^{[kk]} \mathbf{V}^{[k]} \right) = d^{[k]}, \quad \forall k \in \{1, 2, \dots, K\}. \quad (5)$$

In the IA-based wireless EH systems [30], [36]–[45], [54], the received signal is first split into two parts at each receiver according to the PS ratio  $\rho$ , one for ID and the other for EH, as shown in Fig. 10. At the ID terminal, the information is recovered without interference by the decoding matrix, while at the EH terminal, energy harvesting is performed. Some of the important works on IA-based networks for wireless EH are summarized in Table 5.

As the precoding and decoding matrices are calculated and set in advance in the IA-based wireless EH systems, and these matrices need not to be optimized again as in the beamforming optimization method in Section IV-A. Thus, only the PS ratio should be optimized to satisfied the IT and EH performance, which is much easier to be solved. If we want to further improve the performance of SWIPT, the PS ratio and the transmit power can be jointly optimized. In [37], a power-splitting optimization (PSO) algorithm is proposed, in which the performance of IT and EH are optimized at the same with a specific weight  $\alpha$  between them by designing the PS ratio properly. Besides, we also assume that the sum transmit power of the users in the network is fixed, and the transmit

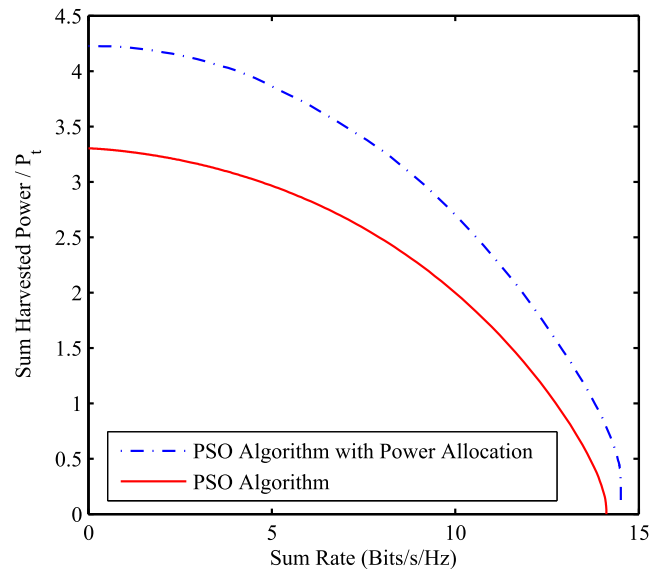

FIGURE 11. Power-rate tradeoffs of the PSO algorithms with and without power allocation in the 5-user IA-based network for wireless energy harvesting. Average received SNR is 10dB.

power and the PS ratio can be jointly optimized to improve the IT and EH performance. The simulation results are shown in Fig. 11. From the results, it is shown that when power allocation (PA) is performed jointly with the PS optimization, the IT and EH performance will be improved significantly compared with that achieved by only PS without PA.

The advantages and disadvantages of the above two methods are analyzed as follows.

- When the beamforming matrices and the PS ratio are jointly optimized, the optimal performance can be

TABLE 5. Some of the important works on IA-based networks for wireless energy harvesting.

Year	Authors	Publications	Features and advantages
2014	N. Zhao, etc [44]	IWCMC'14	A common framework, user selection power splitting
2014	B. Koo and D. Park [40]	IEEE CL	Antenna selection
2014	N. Zhao, etc [43]	WCSP'14	User selection
2014	X. Li, etc [42]	GLOBECOM'14	Antenna selection and power splitting
2015	N. Zhao, etc [38]	IEEE WC	User selection
2015	N. Zhao, etc [37]	IEEE CM	Joint transmit power and power splitting optimization
2015	Z. Xie, etc [36]	IEEE WCL	Distributed IA, HetNets, pseudo DoF
2015	N. Zhao, etc [41]	ICC'15	Angle Switching
2016	Z. Zong, etc [30]	IEEE TWC	Semi-decouple the joint optimization by diversity interference alignment
2016	J. Guo, etc [45]	WCSP'16	Exploiting jamming for energy harvesting
2016	Y. Ren, etc [39]	IEEE ACCESS	Uplink, multi-cluster, user selection
2016	Y. Cao, etc [56]	IEEE ICCS'16	Exploiting artificial noise for energy harvesting

achieved, i.e., the total transmit power is minimized with IT and EH requirements satisfied. Nevertheless, the optimization is usually non-convex, and is very difficult to solve.

- When IA is adopted, the interferences among users can be perfectly eliminated with the precoding and decoding matrices of IA. No complex optimization is needed, due to the fact that only the PS ratio should be optimized based on the solutions of IA, which is much easier to be solved.
- In addition, when beamforming is performed, we cannot know whether the interference can be perfectly suppressed by the precoding and decoding matrices, although the performance of the wireless EH can be optimized. When IA is adopted, we can easily know whether the interference can be perfectly eliminated when ID is performed, and the minimal antennas that are required to handle the interference can be derived.

### V. CASE STUDIES ON JAMMING BASED WIRELESS ENERGY HARVESTING

In the security area of wireless networks, interference can be generated by a certain transmitter to disrupt the information decoding at a specific receiver, and we can call this jamming signal or artificial noise [94]. When the active attacker is considered, the jamming signal is emitted by the adversarial jammers to disrupt the legitimate transmission of the network [95], [96]. For the defender, the AN can be generated by the legitimate transmitters to prevent eavesdropping by some potential eavesdroppers [97]–[100]. The jamming signal and AN are two kinds of actively generated interference, and usually their transmit power is relatively high to have better disruption performance. Therefore, the jamming signal and AN can be served an adequate energy source for wireless EH of the legitimate network, which will be discussed in this section in detail.

#### A. ADVERSARIAL JAMMING SIGNAL FOR ENERGY HARVESTING

Jamming is an important active attack in wireless network, and the jamming signal is generated by some adversarial jammers to intentionally disrupt the legitimate transmission of wireless networks [95], [96]. To relieve the influence of the jamming and guarantee the legitimate transmission, many anti-jamming methods have been proposed [101]–[103], among which the anti-jamming IA scheme is a very effective method to combat with the jamming signals for interference networks [104], [105], as shown in Fig. 12. In the anti-jamming IA scheme, the original solutions is no longer effective towards the jamming signals, and thus the precoding and decoding matrices of IA should be re-designed.

According to Fig. 12, the interferences from other users are constrained into the same subspace as the jamming signal at each receiver by the precoding matrices cooperatively, and thus the interferences and jamming signal can be eliminated together by the decoding matrices. Consider a  $K$ -user symmetric IA network with  $M$  antennas at each transmitter and  $N$  antennas at each receiver, and  $d$  data streams are sent by each user. When there exist a jammer with  $N_j$  antennas, the feasibility conditions of the anti-jamming IA scheme can be expressed as [105]

$$\begin{aligned}
 M + N &\geq (K + 1)d + N_j, \\
 N &\geq N_j + d, \\
 M &\geq d.
 \end{aligned} \tag{6}$$

The condition (6) gives the minimal requirements of the antennas at each transceiver to achieve perfect anti-jamming performance, i.e., to eliminate the interferences as well as the jamming signal completely.

Although the anti-jamming IA scheme has excellent performance in handling the jamming signals and interferences, they are just eliminated without reutilization. As we know, the transmit power of the jammer is usually very high to achieve

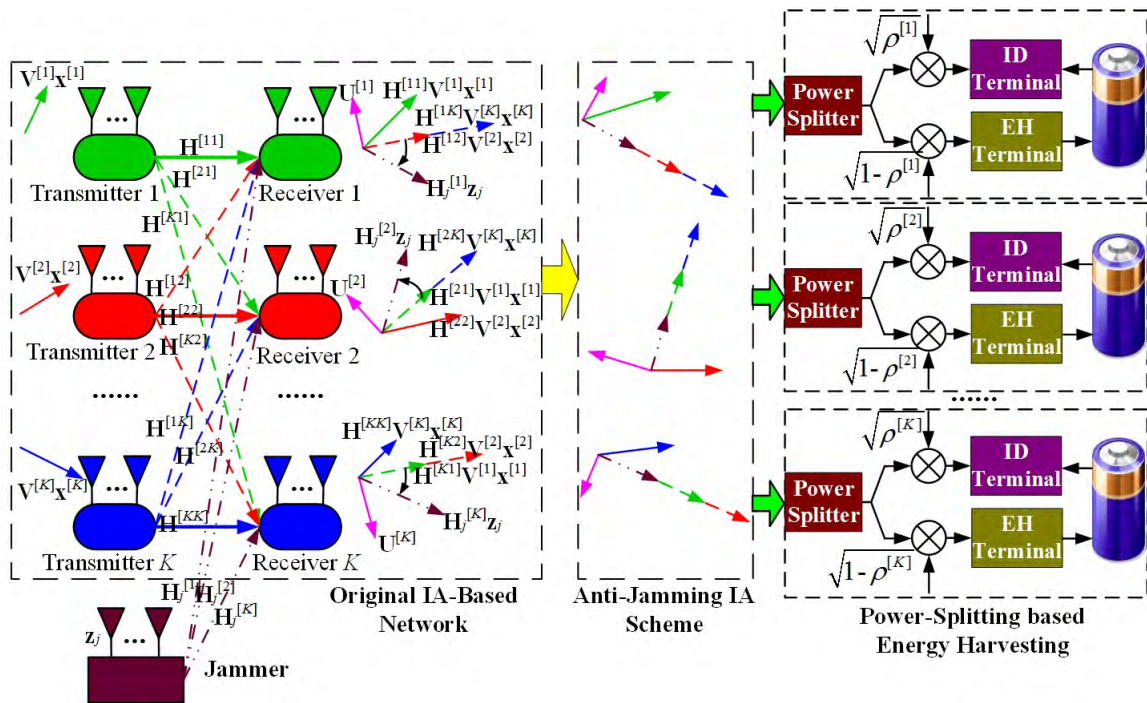

FIGURE 12. Demonstration of wireless energy harvesting in the anti-jamming IA network.

better performance in disrupting the legitimate transmission, and it is really a waste of energy to just eliminate the jamming signal. Therefore, a novel wireless EH scheme is proposed for the anti-jamming IA scheme in [45] and [106], in which the received signals, including the desired signal, the interferences among users, and the jamming signal, are split into two parts at each receiver, one for the ID terminal, and the other for the EH terminal. In [45] and [106], the total transmit power of the legitimate network is minimized through jointly optimizing the transmit power and the PS ratio, with the requirements of both IT and EH guaranteed. According to the scheme, the redundant power of the interferences and jamming signals can be further exploited for wireless EH, as long as the QoS of the IT can be met. Thus the interference and jamming that used to be deemed as harmful factors, can be fully utilized to provide power for the wireless systems. Nevertheless, the variables of transmit power and PS ratio are coupled together, and thus the above optimization problem is non-convex, which is difficult to solve. In [45] and [106], a suboptimal algorithm is designed for the problem, and the corresponding low-complexity solutions are derived.

The performance of the anti-jamming IA scheme for wireless EH is shown in Fig. 13, with different values of the transmit power of jammer  $P_j$  and the SINR threshold for IT  $\gamma$ . From the simulation results, we can see that when the transmit power of the jamming signal becomes higher, the minimal required total transmit power of the legitimate network becomes lower, due to the fact that more power of the jamming signal can be leveraged by the legitimate receivers to replenish their batteries. Besides, we can also know that more transmit power is needed by the legitimate network

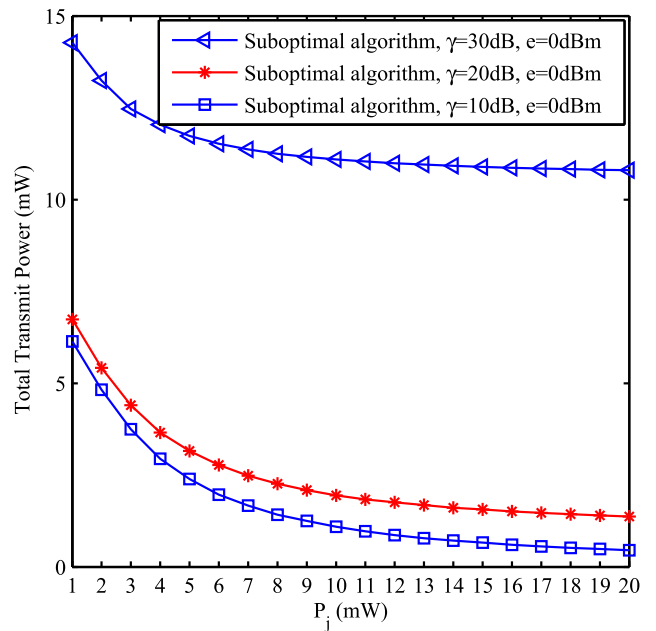

FIGURE 13. Comparison of the total transmit power of the proposed anti-jamming IA scheme with wireless energy harvesting when the transmit power of jammer and the threshold for IT  $\gamma$  are changing.

when the threshold of SINR  $\gamma$  becomes larger. Therefore, we can conclude that the adversarial jamming signal can be changed from harmful to beneficial to the wireless networks as an abundant energy source, if the interference management and EH can be properly designed and optimized in the interference networks.

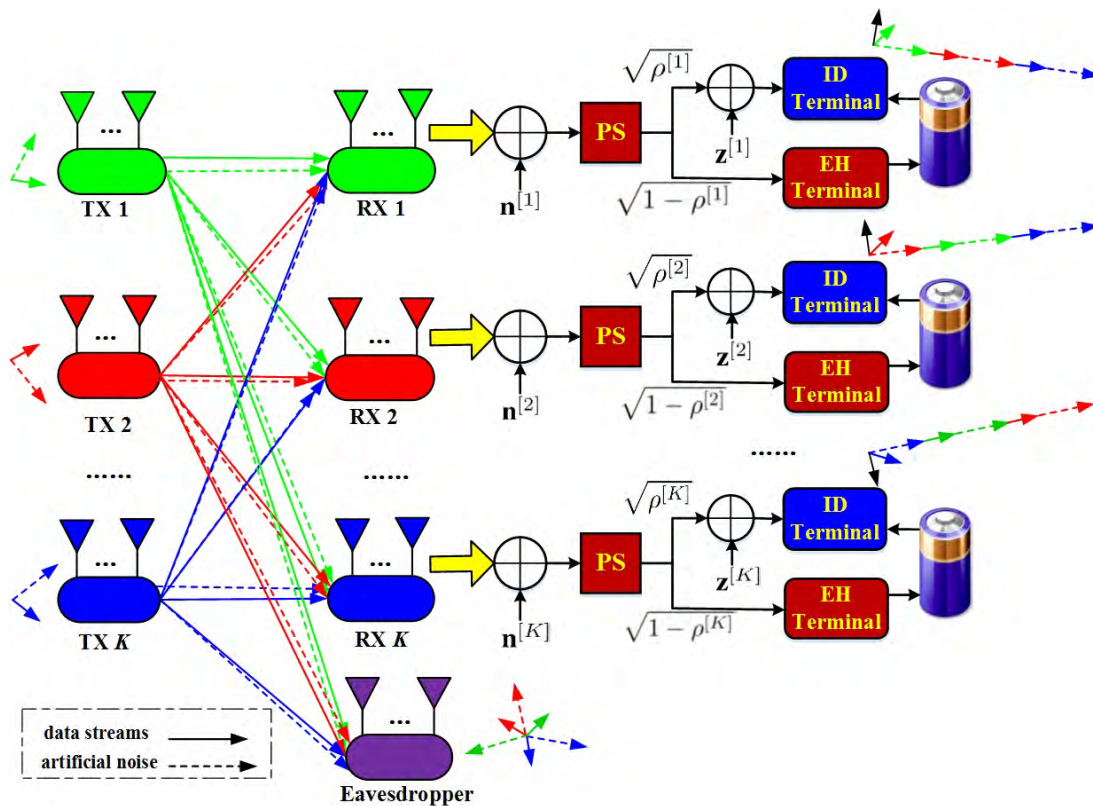

FIGURE 14. Demonstration of wireless energy harvesting in the anti-eavesdropping IA network with artificial noise.

### B. ARTIFICIAL NOISE FOR WIRELESS ENERGY HARVESTING

Another important issue of physical layer security is eavesdropping, which is a key threat to the secure transmission of wireless networks [94]. When the eavesdropping is considered, it should guarantee that the confidential messages transmitted by the legitimate users should not be intercepted by the passive eavesdropper [107]. There have been many methods to protect the confidential transmission of legitimate transmission, and one of the most effective ones is to use artificial noise [97]–[100]. In this method, AN is generated by the legitimate user, which will disrupt the eavesdropping without affecting the legitimate transmission. Especially, for the interference networks, a novel anti-eavesdropping scheme was proposed in [108] and [109] through using the techniques of IA and AN, as shown in Fig. 14. In the scheme, AN is generated by each transmitter along with the information streams, which will disrupt the passive eavesdropping without affecting the legitimate transmission, i.e., the AN will be eliminated at all the receivers together with the interferences. The feasibility conditions of the anti-eavesdropping IA scheme based on AN can be presented as

$$\begin{aligned}
 (d + 1)M + dN &\geq d^2K + d^2 + dK + 1 \\
 M &\geq d \\
 M &\geq d.
 \end{aligned}
 \tag{7}$$

The meanings of the symbols in (7) are similar to those in (6). The condition (7) presents the minimal required number of the antennas at each node to transmit information free of interference and AN.

Nevertheless, most of the transmit power is allocated to the AN to guarantee the security performance in the AN-based schemes. For example, in the AN-based IA network in [108] and [109], the AN is just eliminated at the receiver along with the interferences, which is a great waste of energy. If we can perform wireless EH that leverages AN and interference, the abundant power of AN can be collected to support the operation of the receivers. Therefore, an AN-based IA network with wireless EH was proposed in [54] and [110], as shown in Fig. 14. In the scheme, the received signal, including the desired signal, interferences and AN, is divided into two parts at each receiver through a power splitter, one part for the ID terminal and the other part for EH. At the ID terminal, the split signal is treated by the decoding matrix, through which the desired information can be recovered with the interferences and AN perfectly eliminated. At the EH terminal, the split part of the signal is converted to electrical energy to support the operations of the receiver. To further improve the performance of the scheme, the transmit power and the PS ratio are jointly optimized to maximize the transmit power of AN with the requirements of IT and EH guaranteed [54], [110]. However, the optimization problem is non-convex and

very difficult to solve. Thus, a suboptimal algorithm for the problem is also developed with much lower complexity.

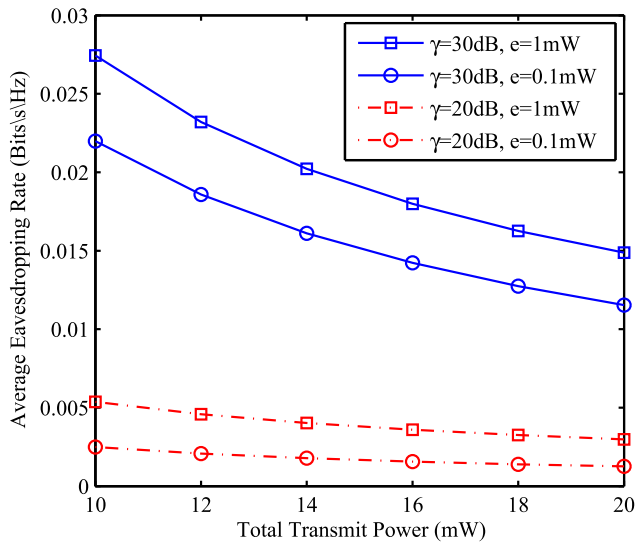

**FIGURE 15.** Comparison of the average eavesdropping rate in the anti-jamming AN scheme for wireless energy harvesting under different values of total transmit power, IT threshold  $\gamma$  and EH threshold  $e$ .

To show the performance of the anti-eavesdropping IA scheme for wireless EH, the average eavesdropping rate is compared with different values of the ID threshold  $\gamma$ , the EH threshold  $e$  and the total transmit power, in Fig. 15. From the results, we can see that, when the total transmit power of the network is increased, the average eavesdropping rate will become lower with the requirement of IT  $\gamma$  and the requirement of EH  $e$  guaranteed. This is due to the fact that more redundant power of AN and interferences can be collected for the operation of receivers with the IT and EH requirements satisfied, when the total transmit power of the network becomes higher. Besides, when the values of  $\gamma$  and  $e$  become larger, the average eavesdropping rate will also become higher, because more power will be devoted to IT and EH, and thus the power of AN becomes lower. Therefore, we can conclude that the AN in the anti-eavesdropping IA scheme to disrupt the eavesdropping can also be exploited as an abundant energy source as well as to guarantee the security, if the IM and EH are properly designed in the interference networks.

## VI. OPEN RESEARCH CHALLENGES

Although some excellent research works have been done on exploiting interference for wireless EH, there still remain some open research challenges to be solved in the future, and we will discuss some of them in this section.

### A. EFFECTIVE INTERFERENCE MANAGEMENT WITH LOW COMPLEXITY

In the SWIPT system that exploits interference, information should be transmitted as well as energy, and the QoS of IT will surely be affected by the interference. Thus a key challenge that should be solved for the interference

based wireless EH is the interference management problem. As analyzed in Section III-D, there are mainly two kinds of methods to achieve interference management, i.e., beamforming optimization and interference alignment.

#### 1) BEAMFORMING OPTIMIZATION

The first method is to design the beamforming of transceivers directly, especially in the wireless EH systems, the beamforming is usually jointly optimized with the PS ratio. The joint optimization problem is a non-convex problem, which is very difficult to solve. Although many suboptimal algorithms have been proposed to solve the joint optimization problem, e.g., semi-definite programming, second-order cone programming, linear programming and game, the computational complexity is still high for the practical systems. Therefore, more efforts should be devoted to the development of low-complexity suboptimal algorithms for the jointly optimization of the beamforming matrices and PS ratio.

#### 2) INTERFERENCE ALIGNMENT

IA is a promising technique for interference management in wireless networks, and it can be adopted to be utilized in the wireless EH systems exploiting interference. Although the performance of the IA-based wireless EH is excellent, there still remain some challenges, one of which is its high computational complexity. First, the closed-form solutions of IA cannot be derived when there exist more than 3 users in the network, and thus some iterative algorithms should be leveraged to obtain the solutions of IA with relatively high computational complexity. Second, the accurate channel state information (CSI) of the whole network should be available at each node to obtain the solutions of IA, which is surely a strict requirement. Although there are plenty of research works that focus on these aspects of IA, there is still a long road ahead. Therefore, we should pay much more attention on the directions that make IA more suitable and practical for wireless EH.

### B. EFFICIENCY OF WIRELESS ENERGY HARVESTING

Another challenge is the efficiency of wireless EH. Although wireless signal can carry energy as well as information, which can be harvested as a power source, the power strength of the wireless signal is attenuated seriously as the distance of transmission becomes longer. For the resonant inductive coupling and magnetic resonance coupling [14]–[17], the power strength is attenuated 60 dB per decade of distance, which means the power strength is decreased by  $10^6$  times with the increase of distance by 10 times. Thus these two methods are only suitable to be utilized for the near-field applications of wireless EH with limited distance. For the wireless RF energy harvesting, it is suitable for the far-field applications of wireless energy transfer with relatively longer distance.

Nevertheless, the power strength of wireless RF energy harvesting is also attenuated 20dB per decade of distance, and it is not efficient or even not suitable when applied to the scenarios with much longer distance [8]. Besides, due to the

regulations of government, e.g., the federal communications commission (FCC), the radiated power is limited, and the wireless EH is thus limited to be applied within a very small area. Thus wireless EH is only suitable to be utilized in some low-power small-area networks, such as wireless sensor networks and wireless body networks. In the future research of this direction, much more efficient wireless EH schemes should be derived, in order to expand its applications. For example, the receive antennas for wireless EH with much higher gain and much better direction performance should be designed, and much more efficient RF-to-DC converters should be developed, *etc.*

### C. ENERGY-EFFICIENT ALGORITHMS

The algorithms for the wireless EH system that exploits interference are usually very complex, due to the fact that the beamforming matrices should be optimized or the solutions of IA should be calculated to manage the interference as well as to optimize the perform of IT and EH. In addition, in the existing algorithms, the global CSI of the interference network is usually required by the nodes, which is also not easy to obtain.

On the other hand, the harvested energy is usually limited, due to the path loss of the wireless channels and the conversion loss of the EH terminal. If the consuming power of obtaining CSI and performing the beamforming algorithm at the receiver is no less than the collected power through EH, there seems to have no need to perform EH. Besides, more antennas will consume more power, and the number of antennas at the wireless EH powered communication nodes should be limited to save energy. Thus there exists a tradeoff between the power consumption of nodes supported by the wireless EH and the power harvested by these nodes.

For the SWIPT users, information receiving is more sensitive than the energy receiving. When the users are far from the interference energy source, there may be no need to perform wireless EH with information transmission still performed. Thus we should decide whether wireless EH should be performed for the SWIPT receiver adaptively.

Therefore, in the future, more energy-efficient beamforming algorithms should be developed to save energy at the receivers of the wireless EH system that exploits interference, which is essential to the wireless EH systems and thus will surely become one of the key challenges.

### D. STABILITY OF THE INTERFERENCE ENERGY RESOURCE

In the wireless EH systems that mainly depend on the ambient interference, the energy source is not stable all the time, which will surely affect the stability of the wireless EH. At the peak time, e.g., the day time, more active users may exist in the network, the resource of interference for wireless EH is sufficient, but the transmission requires more energy too; while at the off-peak time, e.g., midnight, fewer active users exist in the network, the resource of interference for EH is insufficient, but the information transmission also requires less energy. Thus it is a key problem to balance the wireless EH between the

peak time and the non-peak time, and schedule the power utilization and storage adaptively.

In addition, the power resource of the interference can change dynamically in a short time, because some strong interference may disappear suddenly. Therefore, it is a challenge to perform the wireless EH from dedicated energy source or from the ambient interference according to the requirements of the systems adaptively.

## VII. CONCLUSIONS

Interference used to be deemed as a negative factor for wireless networks, for the reason that it will degrade the reliable transmission of information greatly. However, it can also provide benefits as a sufficient power source thanks to the recent research advances in wireless EH. Thus, in this paper, we have presented a comprehensive survey of exploiting interference for wireless EH. We began our discussion with an overview of some fundamentals of wireless EH, from green communications to SWIPT, and from the methods to achieve wireless EH to receiver architectures of PS and TS. Then we discussed the classifications of wireless EH systems exploiting interference, according to receiver architecture, antenna dimension, network topology and interference management, respectively. Next, one of the key problems, interference management, was presented, including beamforming optimization and IA. In addition, some case studies on jamming and AN based wireless EH systems were discussed. Finally, some open research challenges are exploited, such as effective interference management with low complexity, efficiency of wireless EH, energy-efficient algorithms, and stability of the interference energy resource.

In summary, the research on exploiting interference for wireless EH is quite broad, and there is still a long way ahead to utilize the interference-based wireless EH technique to practical systems due to some challenging issues. In this article, the state-of-the-art in the research of interference-based wireless EH is surveyed, and some research issues and challenges are discussed, which can be beneficial for the future research of wireless EH systems exploiting interference.

## REFERENCES

- [1] D. Tse and P. Viswanath, *Fundamentals Wireless Communication*. Cambridge, U.K.: Cambridge Univ. Press, 2005.
- [2] N. Lee and R. W. Heath, Jr., "Advanced interference management technique: Potentials and limitations," *IEEE Wireless Commun.*, vol. 23, no. 3, pp. 30–38, Jun. 2016.
- [3] L. Dai, B. Wang, Y. Yuan, S. Han, C.-L. I, and Z. Wang, "Non-orthogonal multiple access for 5G: Solutions, challenges, opportunities, and future research trends," *IEEE Commun. Mag.*, vol. 53, no. 9, pp. 74–81, Sep. 2015.
- [4] V. R. Cadambe and S. A. Jafar, "Interference alignment and degrees of freedom of the K-user interference channel," *IEEE Trans. Inf. Theory*, vol. 54, no. 8, pp. 3425–3441, Aug. 2008.
- [5] N. Zhao, F. R. Yu, M. Jin, Q. Yan, and V. C. M. Leung, "Interference alignment and its applications: A survey, research issues and challenges," *IEEE Commun. Surveys Tut.*, vol. 18, no. 3, pp. 1779–1803, 3rd Quart., 2016.
- [6] C. Masouros, T. Ratnarajah, M. Sellathurai, C. B. Papadias, and A. K. Shukla, "Known interference in the cellular downlink: A performance limiting factor or a source of green signal power?" *IEEE Commun. Mag.*, vol. 51, no. 10, pp. 162–171, Oct. 2013.

- [7] R. Zhang and C. K. Ho, "MIMO broadcasting for simultaneous wireless information and power transfer," *IEEE Trans. Wireless Commun.*, vol. 12, no. 5, pp. 1989–2001, May 2013.
- [8] X. Lu, P. Wang, D. Niyato, D. I. Kim, and Z. Han, "Wireless networks with RF energy harvesting: A contemporary survey," *IEEE Commun. Surveys Tut.*, vol. 17, no. 2, pp. 757–789, 2nd Quart., 2015.
- [9] L. R. Varshney, "Transporting information and energy simultaneously," in *Proc. IEEE Int. Symp. Inf. Theory*, Toronto, ON, Canada, Jul. 2008, pp. 1612–1616.
- [10] P. Grover and A. Sahai, "Shannon meets Tesla: Wireless information and power transfer," in *Proc. IEEE Int. Symp. Inf. Theory*, Austin, TX, USA, Jun. 2010, pp. 2363–2367.
- [11] Q. Liu, M. Golinski, P. Pawelczak, and M. Warnier, "Green wireless power transfer networks," *IEEE J. Sel. Areas Commun.*, vol. 34, no. 5, pp. 1740–1756, May 2016.
- [12] A. Ghazanfari, H. Tabassum, and E. Hossain, "Ambient RF energy harvesting in ultra-dense small cell networks: Performance and trade-offs," *IEEE Wireless Commun.*, vol. 23, no. 2, pp. 38–45, Apr. 2016.
- [13] P. Kamalinejad, C. Mahapatra, Z. Sheng, S. Mirabbasi, V. C. M. Leung, and Y. L. Guan, "Wireless energy harvesting for the Internet of Things," *IEEE Commun. Mag.*, vol. 53, no. 6, pp. 102–108, Jun. 2015.
- [14] S. Valtchev, B. Borges, K. Brandisky, and J. B. Klaessens, "Efficient resonant inductive coupling energy transfer using new magnetic and design criteria," in *Proc. IEEE 36th Power Electron. Specialists Conf. (PESC)*, Jun. 2005, pp. 1293–1298.
- [15] H. Liu. (2011). *Maximizing Efficiency of Wireless Power Transfer With Resonant Inductive Coupling*. [Online]. Available: [http://hxl95.github.io/media/ib\\_ee.pdf](http://hxl95.github.io/media/ib_ee.pdf)
- [16] A. Kurs, A. Karalis, R. Moffatt, J. D. Joannopoulos, P. Fisher, and M. Soljačić, "Wireless power transfer via strongly coupled magnetic resonances," *Science*, vol. 317, no. 5834, pp. 83–86, 2007.
- [17] O. Jonah and S. V. Georgakopoulos, "Wireless MIMO power transfer in concrete via strongly coupled magnetic resonance," *IEEE Trans. Antennas Propag.*, vol. 61, no. 3, pp. 1378–1384, Mar. 2013.
- [18] H. J. Visser and R. J. M. Vullers, "RF energy harvesting and transport for wireless sensor network applications: Principles and requirements," *Proc. IEEE*, vol. 101, no. 6, pp. 1410–1423, Jun. 2013.
- [19] S. Kim et al., "Ambient RF energy-harvesting technologies for self-sustainable standalone wireless sensor platforms," *Proc. IEEE*, vol. 102, no. 11, pp. 1649–1666, Nov. 2014.
- [20] S. Sudevalayam and P. Kulkarni, "Energy harvesting sensor nodes: Survey and implications," *IEEE Commun. Surveys Tut.*, vol. 13, no. 3, pp. 443–461, 3rd Quart., 2011.
- [21] R. V. Prasad, S. Devasenapathy, V. S. Rao, and J. Vazifehdan, "Reincarnation in the ambiance: Devices and networks with energy harvesting," *IEEE Commun. Surveys Tut.*, vol. 16, no. 1, pp. 195–213, 1st Quart., 2014.
- [22] M.-L. Ku, W. Li, Y. Chen, and K. J. R. Liu, "Advances in energy harvesting communications: Past, present, and future challenges," *IEEE Commun. Surveys Tut.*, vol. 18, no. 2, pp. 1384–1412, 2nd Quart., 2016.
- [23] X. Lu, P. Wang, D. Niyato, D. I. Kim, and Z. Han, "Wireless charging technologies: Fundamentals, standards, and network applications," *IEEE Commun. Surveys Tut.*, vol. 18, no. 2, pp. 1413–1452, 2nd Quart., 2016.
- [24] C. Psomas and I. Krikidis, "Successive interference cancellation in bipolar Ad Hoc networks with SWIPT," *IEEE Wireless Commun. Lett.*, vol. 5, no. 4, pp. 364–367, Aug. 2016.
- [25] Z. Zhu, Z. Wang, Z. Chu, X. Gao, Y. Zhang, and J. Cui, "Robust beamforming based on transmit power analysis for multiuser multiple-input single-output interference channels with energy harvesting," *IET Commun.*, vol. 10, no. 10, pp. 1221–1228, Jul. 2016.
- [26] S. Timotheou, G. Zheng, C. Masouros, and I. Krikidis, "Exploiting constructive interference for simultaneous wireless information and power transfer in multiuser downlink systems," *IEEE J. Sel. Areas Commun.*, vol. 34, no. 10, pp. 1772–1784, May 2016.
- [27] T. Peng, F. Wang, Y. Huang, and X. Wang, "Robust transceiver optimization for MISO SWIPT interference channel: A decentralized approach," in *Proc. IEEE (VTC)*, Nanjing, China, May 2016, pp. 1–5.
- [28] S. Timotheou, I. Krikidis, G. Zheng, and B. Ottersten, "Beamforming for MISO interference channels with QoS and RF energy transfer," *IEEE Trans. Wireless Commun.*, vol. 13, no. 5, pp. 2646–2658, May 2014.
- [29] M.-M. Zhao, Y. Cai, Q. Shi, B. Champagne, and M.-J. Zhao, "Robust transceiver design for MISO interference channel with energy harvesting," *IEEE Trans. Signal Process.*, vol. 64, no. 17, pp. 4618–4633, Sep. 2016.
- [30] Z. Zong, H. Feng, F. R. Yu, N. Zhao, T. Yang, and B. Hu, "Optimal transceiver design for SWIPT in  $K$ -user MIMO interference channels," *IEEE Trans. Wireless Commun.*, vol. 15, no. 1, pp. 430–445, Jan. 2016.
- [31] Q. Shi, W. Xu, T. H. Chang, Y. Wang, and E. Song, "Joint beamforming and power splitting for MISO interference channel with SWIPT: An SOCP relaxation and decentralized algorithm," *IEEE Trans. Signal Process.*, vol. 62, no. 23, pp. 6194–6208, Dec. 2014.
- [32] S. Timotheou, I. Krikidis, and B. Ottersten, "MISO interference channel with QoS and RF energy harvesting constraints," in *Proc. IEEE Int. Conf. Commun. (ICC)*, Jun. 2013, pp. 4191–4196.
- [33] H. Chen, Y. Ma, Z. Lin, Y. Li, and B. Vucetic, "Distributed power control in interference channels with QoS constraints and RF energy harvesting: A game-theoretic approach," *IEEE Trans. Veh. Technol.*, vol. 65, no. 12, pp. 10063–10069, Dec. 2016.
- [34] H. Chen, Y. Li, Y. Jiang, Y. Ma, and B. Vucetic, "Distributed power splitting for SWIPT in relay interference channels using game theory," *IEEE Trans. Wireless Commun.*, vol. 14, no. 1, pp. 410–420, Jan. 2015.
- [35] H. Chen, Y. Jiang, Y. Li, Y. Ma, and B. Vucetic, "A game-theoretical model for wireless information and power transfer in relay interference channels," in *Proc. IEEE (ISIT)*, Honolulu, HI, USA, Jun. 2014, pp. 1161–1165.
- [36] Z. Xie, Y. Chen, and Y. Gao, "Joint iterative interference alignment and energy harvesting for multi-user networks," *IEEE Wireless Commun. Lett.*, vol. 4, no. 6, pp. 597–600, Dec. 2015.
- [37] N. Zhao, F. R. Yu, and V. C. M. Leung, "Wireless energy harvesting in interference alignment networks," *IEEE Commun. Mag.*, vol. 53, no. 6, pp. 72–78, Jun. 2015.
- [38] N. Zhao, F. R. Yu, and V. C. M. Leung, "Opportunistic communications in interference alignment networks with wireless power transfer," *IEEE Wireless Commun.*, vol. 22, no. 1, pp. 88–95, Feb. 2015.
- [39] Y. Ren, T. Lv, H. Gao, and S. Yang, "Wireless information and energy transfer in multi-cluster MIMO uplink networks through opportunistic interference alignment," *IEEE ACCESS*, vol. 4, pp. 3100–3111, Jul. 2016.
- [40] B. Koo and D. Park, "Interference alignment and wireless energy transfer via antenna selection," *IEEE Commun. Lett.*, vol. 18, no. 4, pp. 548–551, Apr. 2014.
- [41] N. Zhao, F. R. Yu, and V. C. M. Leung, "Wireless power transfer based on angle switching in interference alignment wireless networks," in *Proc. IEEE (ICC)*, London, U.K., Jun. 2015, pp. 5386–5391.
- [42] X. Li, Y. Sun, F. R. Yu, and N. Zhao, "Antenna selection and power splitting for simultaneous wireless information and power transfer in interference alignment networks," in *Proc. IEEE Global Commun. Conf. (GLOBECOM)*, Dec. 2014, pp. 2667–2672.
- [43] N. Zhao, F. R. Yu, and V. C. M. Leung, "Opportunistic interference alignment networks for simultaneous wireless information and power transfer through user selection," in *Proc. 6th Int. Conf. Wireless Commun. Signal Process. (WCSP)*, Oct. 2014, pp. 1–5.
- [44] N. Zhao, F. R. Yu, and V. C. M. Leung, "Simultaneous wireless information and power transfer in interference alignment networks," in *Proc. IWCMC*, Nicosia, Cyprus, Aug. 2014, pp. 7–11.
- [45] J. Guo, N. Zhao, F. R. Yu, X. Liu, and V. C. M. Leung, "Wireless energy harvesting in interference alignment networks with adversarial jammers," in *Proc. (WCSP)*, Yangzhou, China, Jun. 2016, pp. 1–5.
- [46] C. Despin et al., "Leveraging green communications for carbon emission reductions: Techniques, testbeds, and emerging carbon footprint standards," *IEEE Commun. Mag.*, vol. 49, no. 8, pp. 101–109, Aug. 2011.
- [47] F. R. Yu, X. Zhang, and V. C. M. Leung, *Green Communications and Networking*. Boca Raton, FL, USA: CRC Press, 2012.
- [48] S. Cui, A. J. Goldsmith, and A. Bahai, "Energy-efficiency of MIMO and cooperative MIMO techniques in sensor networks," *IEEE J. Sel. Areas Commun.*, vol. 22, no. 6, pp. 1089–1098, Aug. 2004.
- [49] R. Xie, F. R. Yu, H. Ji, and Y. Li, "Energy-efficient resource allocation for heterogeneous cognitive radio networks with femtocells," *IEEE Trans. Wireless Commun.*, vol. 11, no. 11, pp. 3910–3920, Nov. 2012.
- [50] N. Zhao, F. R. Yu, and H. Sun, "Adaptive energy-efficient power allocation in green interference alignment wireless networks," *IEEE Trans. Veh. Technol.*, vol. 64, no. 9, pp. 4268–4281, Sep. 2015.
- [51] D. Gunduz, K. Stamatiou, N. Michelusi, and M. Zorzi, "Designing intelligent energy harvesting communication systems," *IEEE Commun. Mag.*, vol. 52, no. 1, pp. 210–216, Jan. 2014.
- [52] X. Zhou, R. Zhang, and C. K. Ho, "Wireless information and power transfer: Architecture design and rate-energy tradeoff," *IEEE Trans. Commun.*, vol. 61, no. 11, pp. 4754–4767, Nov. 2013.



- [53] L. Liu, R. Zhang, and K.-C. Chua, "Wireless information and power transfer: A dynamic power splitting approach," *IEEE Trans. Commun.*, vol. 61, no. 9, pp. 3990–4001, Sep. 2013.
- [54] Y. Cao, N. Zhao, F. R. Yu, Y. Chen, X. Liu, and V. C. M. Leung, "An anti-eavesdropping interference alignment scheme with wireless power transfer," in *Proc. IEEE (ICCS)*, Shenzhen, China, Dec. 2016, pp. 1–5.
- [55] J. G. Andrews, "Interference cancellation for cellular systems: A contemporary overview," *IEEE Wireless Commun.*, vol. 12, no. 2, pp. 19–29, Apr. 2005.
- [56] K. M. Rege, K. Balachandran, J. H. Kang, and M. K. Karakayali, "Practical dirty paper coding with sum codes," *IEEE Trans. Commun.*, vol. 64, no. 2, pp. 441–455, Feb. 2016.
- [57] B. Xu, Y. Zhu, and R. Zhang, "Optimized power allocation for interference channel with SWIPT," *IEEE Wireless Commun. Lett.*, vol. 5, no. 2, pp. 220–223, Apr. 2016.
- [58] L. Li, H. Wang, Z. Wang, and A. Paulraj, "Simultaneous wireless information and power transfer in multi-user interference SISO system," in *Proc. IEEE (ICUWB)*, Montreal, QC, Canada, Oct. 2015, pp. 1–5.
- [59] Q. Shi, C. Peng, W. Xu, and Y. Wang, "Joint transceiver design for MISO SWIPT interference channel," in *Proc. IEEE (ICASSP)*, Florence, Italy, May 2014, pp. 4753–4757.
- [60] B. Xu, Y. Zhu, and R. Zhang, "Optimal power allocation for a two-link interference channel with SWIPT," in *Proc. 6th Int. Conf. Wireless Commun. Signal Process. (WCSP)*, Oct. 2014, pp. 1–5.
- [61] Z. Zong, H. Feng, S. Zhang, T. Yang, and B. Hu, "Joint transceiver design for simultaneous wireless information and power transfer in multi-user MIMO interference networks," in *Proc. 6th Int. Conf. Wireless Commun. Signal Process. (WCSP)*, Oct. 2014, pp. 1–6.
- [62] L. Hu, C. Zhang, and J. Xu, "Simultaneous wireless information and power transfer with co-channel interference," in *Proc. IEEE (PIMRC)*, Washington DC, USA, Sep. 2014, pp. 2125–2129.
- [63] G. Zhu, C. Zhong, H. A. Suraweera, G. K. Karagiannidis, Z. Zhang, and T. A. Tsiftsis, "Wireless information and power transfer in relay systems with multiple antennas and interference," *IEEE Trans. Commun.*, vol. 63, no. 4, pp. 1400–1418, Apr. 2015.
- [64] S. Li, W. Xu, Z. Liu, and J. Lin, "Independent power splitting for interference-corrupted SIMO SWIPT systems," *IEEE Commun. Lett.*, vol. 20, no. 3, pp. 478–481, Mar. 2016.
- [65] Y. Chen, "Energy-harvesting AF relaying in the presence of interference and Nakagami- $m$  fading," *IEEE Trans. Wireless Commun.*, vol. 15, no. 2, pp. 1008–1017, Feb. 2016.
- [66] Y. Zhu, K.-K. Wong, Y. Zhang, and C. Masouros, "Geometric power control for time-switching energy-harvesting two-user interference channel," *IEEE Trans. Veh. Technol.*, vol. 65, no. 12, pp. 9759–9772, Dec. 2016.
- [67] S. Lee, L. Liu, and R. Zhang, "Collaborative wireless energy and information transfer in interference channel," *IEEE Trans. Wireless Commun.*, vol. 14, no. 1, pp. 545–557, Jan. 2015.
- [68] C. Shen, W.-C. Li, and T.-H. Chang, "Wireless information and energy transfer in multi-antenna interference channel," *IEEE Trans. Signal Process.*, vol. 62, no. 23, pp. 6249–6264, Dec. 2014.
- [69] C. Shen, W.-C. Li, and T.-H. Chang, "Simultaneous information and energy transfer: A two-user MISO interference channel case," in *Proc. IEEE Global Commun. Conf. (GLOBECOM)*, Dec. 2012, pp. 3862–3867.
- [70] S. S. Kalamkar and A. Banerjee, "Interference-assisted wireless energy harvesting in cognitive relay network with multiple primary transceivers," in *Proc. IEEE Global Commun. Conf. (GLOBECOM)*, Dec. 2015, pp. 1–6.
- [71] J. Xiao, C. Xu, Q. Zhang, X. Huang, and J. Qin, "Robust transceiver design for two-user MIMO interference channel with simultaneous wireless information and power transfer," *IEEE Trans. Veh. Technol.*, vol. 65, no. 5, pp. 3823–3828, May 2016.
- [72] H. Lee, S.-R. Lee, K.-J. Lee, H.-B. Kong, and I. Lee, "Optimal beamforming designs for wireless information and power transfer in MISO interference channels," *IEEE Trans. Wireless Commun.*, vol. 14, no. 9, pp. 4810–4821, Sep. 2015.
- [73] T. Leem and D. Park, "Rate-energy region of joint information and energy transfer in a two-user MIMO interference channel," *IEEE Commun. Lett.*, vol. 19, no. 10, pp. 1758–1761, Oct. 2015.
- [74] J. Park and B. Clerckx, "Joint wireless information and energy transfer with reduced feedback in MIMO interference channels," *IEEE J. Sel. Areas Commun.*, vol. 33, no. 8, pp. 1563–1577, Aug. 2015.
- [75] J. Park and B. Clerckx, "Joint wireless information and energy transfer in a  $K$ -user MIMO interference channel," *IEEE Trans. Wireless Commun.*, vol. 13, no. 10, pp. 5781–5796, Oct. 2014.
- [76] J. Park and B. Clerckx, "Joint wireless information and energy transfer in a two-user MIMO interference channel," *IEEE Trans. Wireless Commun.*, vol. 12, no. 8, pp. 4210–4221, Aug. 2013.
- [77] Z. B. Zawawi, J. Park, and B. Clerckx, "Simultaneous wireless information and power transfer in a two-user OFDM interference channel," in *Proc. (ISWCS)*, Brussels, Belgium, Aug. 2015, pp. 1–5.
- [78] H. Lee, S. R. Lee, K. J. Lee, H. B. Kong, and I. Lee, "Transmit beamforming techniques for wireless information and power transfer in MISO interference channels," in *Proc. IEEE Global Commun. Conf. (GLOBECOM)*, Dec. 2015, pp. 1–6.
- [79] J. Park and B. Clerckx, "Transmission strategies for joint wireless information and energy transfer in a two-user MIMO interference channel," in *Proc. IEEE Int. Conf. Commun. Workshops (ICC)*, Jun. 2013, pp. 591–595.
- [80] G. Zheng, C. Masouros, I. Krikidis, and S. Timotheou, "Exploring green interference power for wireless information and energy transfer in the MISO downlink," in *Proc. IEEE (ICC)*, London, U.K., Jun. 2015, pp. 149–153.
- [81] A. Ozcelikkale and T. M. Duman, "Linear precoder design for simultaneous information and energy transfer over two-user MIMO interference channels," *IEEE Trans. Wireless Commun.*, vol. 14, no. 10, pp. 5836–5847, Oct. 2015.
- [82] H. Wang, W. Wang, X. Chen, and Z. Zhang, "Wireless information and energy transfer in interference aware massive MIMO systems," in *Proc. IEEE Global Commun. Conf. (GLOBECOM)*, Dec. 2014, pp. 2556–2561.
- [83] Y. Gu and S. Aissa, "Interference aided energy harvesting in decode-and-forward relaying systems," in *Proc. IEEE (ICC)*, Sydney, NSW, Australia, Jun. 2014, pp. 5378–5382.
- [84] G. Yang, C. K. Ho, R. Zhang, and Y. L. Guan, "Throughput optimization for massive MIMO systems powered by wireless energy transfer," *IEEE J. Sel. Areas Commun.*, vol. 33, no. 8, pp. 1640–1650, Aug. 2015.
- [85] G. Amarasuriya, E. G. Larsson, and H. V. Poor, "Wireless information and power transfer in multiway massive MIMO relay networks," *IEEE Trans. Wireless Commun.*, vol. 15, no. 6, pp. 3837–3855, Jun. 2016.
- [86] Y. Zhu, L. Wang, K.-K. Wong, S. Jin, and Z. Zheng, "Wireless power transfer in massive MIMO-aided HetNets with user association," *IEEE Trans. Commun.*, vol. 64, no. 10, pp. 4181–4195, Oct. 2016.
- [87] R. H. Etkin, D. N. C. Tse, and H. Wang, "Gaussian interference channel capacity to within one bit," *IEEE Trans. Inf. Theory*, vol. 54, no. 12, pp. 5534–5562, Dec. 2008.
- [88] N. Jindal, "MIMO broadcast channels with finite-rate feedback," *IEEE Trans. Inf. Theory*, vol. 52, no. 11, pp. 5045–5060, Nov. 2006.
- [89] F. Gao, T. Cui, and A. Nallanathan, "On channel estimation and optimal training design for amplify and forward relay networks," *IEEE Trans. Wireless Commun.*, vol. 7, no. 5, pp. 1907–1916, May 2008.
- [90] F. Gao, R. Zhang, and Y. C. Liang, "Optimal channel estimation and training design for two-way relay networks," *IEEE Trans. Commun.*, vol. 57, no. 10, pp. 3024–3033, Oct. 2009.
- [91] S. A. Jafar, "Interference alignment—A new look at signal dimensions in a communication network," *Found. Trends Commun. Inf. Theory*, vol. 7, no. 1, pp. 1–130, 2010.
- [92] Y. Chen, D. B. da Costa, and H. Ding, "Effect of CCI on WPC with time-division energy and information transmission," *IEEE Wireless Commun. Lett.*, vol. 5, no. 2, pp. 168–171, Apr. 2016.
- [93] C. M. Yetis, T. Gou, S. A. Jafar, and A. H. Kayran, "On feasibility of interference alignment in MIMO interference networks," *IEEE Trans. Signal Process.*, vol. 58, no. 9, pp. 4771–4782, Sep. 2010.
- [94] N. Zhao, F. R. Yu, M. Li, Q. Yan, and V. C. M. Leung, "Physical layer security issues in interference-alignment-based wireless networks," *IEEE Commun. Mag.*, vol. 54, no. 8, pp. 162–168, Aug. 2016.
- [95] R. A. Poisel, *Modern Communications Jamming Principles and Techniques*. Boston, MA, USA: Artech House, 2003.
- [96] Q. Liu, M. Li, X. Kong, and N. Zhao, "Disrupting MIMO communications with optimal jamming signal design," *IEEE Trans. Wireless Commun.*, vol. 14, no. 10, pp. 5313–5325, Oct. 2015.
- [97] H.-M. Wang, M. Luo, Q. Yin, and X.-G. Xia, "Hybrid cooperative beamforming and jamming for physical-layer security of two-way relay networks," *IEEE Trans. Inf. Forensics Security*, vol. 8, no. 12, pp. 2007–2020, Dec. 2013.
- [98] J. Zhu, R. Schober, and V. K. Bhargava, "Secure transmission in multicell massive MIMO systems," *IEEE Trans. Wireless Commun.*, vol. 13, no. 9, pp. 4766–4781, Sep. 2014.

- [99] F. Zhu, F. Gao, M. Yao, and H. Zou, "Joint information- and jamming-beamforming for physical layer security with full duplex base station," *IEEE Trans. Signal Process.*, vol. 62, no. 24, pp. 6391–6401, Dec. 2014.
- [100] H.-M. Wang, C. Wang, D. W. K. Ng, M. H. Lee, and J. Xiao, "Artificial noise assisted secure transmission for distributed antenna systems," *IEEE Trans. Signal Process.*, vol. 64, no. 15, pp. 4050–4064, Aug. 2016.
- [101] B. Wang, Y. Wu, K. J. R. Liu, and T. C. Clancy, "An anti-jamming stochastic game for cognitive radio networks," *IEEE J. Sel. Areas Commun.*, vol. 29, no. 4, pp. 877–889, Apr. 2011.
- [102] X. He, H. Dai, and P. Ning, "Dynamic adaptive anti-jamming via controlled mobility," *IEEE Trans. Wireless Commun.*, vol. 13, no. 8, pp. 4374–4388, Aug. 2014.
- [103] S. Fang, Y. Liu, and P. Ning, "Wireless communications under broadband reactive jamming attacks," *IEEE Trans. Depend. Sec. Comput.*, vol. 13, no. 3, pp. 394–408, Jun. 2016.
- [104] J. Guo, N. Zhao, F. R. Yu, M. Li, and V. C. M. Leung, "A novel anti-jamming scheme for interference alignment (IA)-based wireless networks," in *Proc. IEEE ICC*, Shenzhen, China, Nov. 2015, pp. 1–5.
- [105] N. Zhao, J. Guo, F. R. Yu, M. Li, and V. C. M. Leung, "Antijamming schemes for interference-alignment-based wireless networks," *IEEE Trans. Veh. Technol.*, vol. 66, no. 2, pp. 1271–1283, Feb. 2017.
- [106] J. Guo, N. Zhao, F. R. Yu, X. Liu, and V. C. M. Leung, "Exploiting adversarial jamming signals for energy harvesting in interference networks," *IEEE Trans. Wireless Commun.*, vol. 16, no. 2, pp. 1267–1280, Feb. 2017.
- [107] Y. Zou, X. Wang, and L. Hanzo, "A survey on wireless security: Technical challenges, recent advances and future trends," *Proc. IEEE*, vol. 104, no. 9, pp. 1727–1765, Sep. 2016.
- [108] N. Zhao, F. R. Yu, M. Li, and V. C. M. Leung, "Secure transmission in interference alignment (IA)-based networks with artificial noise," in *Proc. IEEE VTC Spring*, Nanjing, China, May 2016, pp. 1–5.
- [109] N. Zhao, F. R. Yu, M. Li, and V. C. M. Leung, "Anti-eavesdropping schemes for interference alignment (IA)-based wireless networks," *IEEE Trans. Wireless Commun.*, vol. 15, no. 8, pp. 5719–5732, Aug. 2016.
- [110] N. Zhao, Y. Cao, F. R. Yu, Y. Chen, M. Jin, and V. C. M. Leung, "Artificial noise assisted secure interference networks with wireless power transfer," *IEEE Trans. Veh. Technol.*, to be published.



**SHUN ZHANG** received the B.S. degree in communication engineering from Shandong University, Jinan, China, in 2007, and the Ph.D. degree in communication and signal processing from Xidian University, Xi'an, China, in 2013. He is currently with the State Key Laboratory of Integrated Services Networks, Xidian University. His research interests include massive MIMO, MIMO-OFDM systems, relay networks, and detection and parameter estimation theory.



**F. RICHARD YU** (S'00–M'04–SM'08) received the Ph.D. degree in electrical engineering from The University of British Columbia, Vancouver, BC, Canada, in 2003.

From 2002 to 2006, he was with Ericsson, Lund, Sweden, and a start-up in CA, USA. He joined Carleton University, Ottawa, ON, Canada, in 2007, where he is currently a Professor. His research interests include cross-layer/cross-system design, security, and green ICT and QoS provisioning in wireless-based systems. He received the IEEE Outstanding Service Award in 2016, the IEEE Outstanding Leadership Award in 2013, the Carleton Research Achievement Award in 2012, the Ontario Early Researcher Award in 2011, the Excellent Contribution Award at the IEEE/IFIP TrustCom 2010, the Leadership Opportunity Fund Award from the Canada Foundation of Innovation in 2009, and the Best Paper Awards at the IEEE ICC 2014, Globecom 2012, the IEEE/IFIP TrustCom 2009, and International Conference on Networking 2005.

Dr. Yu is a Fellow of the Institution of Engineering and Technology. He serves as a member of the Board of Governors of the IEEE Vehicular Technology Society. He has served as the Technical Program Committee Cochair of numerous conferences. He serves on the editorial boards of several journals, including the Co-Editor-in-Chief of *Ad Hoc & Sensor Wireless Networks*, a Lead Series Editor of the IEEE TRANSACTIONS ON VEHICULAR TECHNOLOGY, and the IEEE TRANSACTIONS ON GREEN COMMUNICATIONS AND NETWORKING, the IEEE COMMUNICATIONS SURVEYS & TUTORIALS. He is a registered Professional Engineer in the province of ON, Canada.



**NAN ZHAO** (S'08–M'11–SM'16) received the B.S. degree in electronics and information engineering, the M.E. degree in signal and information processing, and the Ph.D. degree in information and communication engineering from Harbin Institute of Technology, Harbin, China, in 2005, 2007, and 2011, respectively. He is currently an Associate Professor with the School of Information and Communication Engineering, Dalian University of Technology, China. He has authored or

co-authored more than 100 papers in refereed journals and international conferences. His recent research interests include interference alignment, cognitive radio, wireless power transfer, and physical-layer security.

Dr. Zhao is a Senior Member of the Chinese Institute of Electronics. He also served as a TPC Member for many conferences, e.g., Globecom, VTC, and WCSP. He received the Top Reviewer Award from the IEEE TRANSACTIONS ON VEHICULAR TECHNOLOGY in 2016, and was nominated as an Exemplary Reviewer by the IEEE COMMUNICATIONS LETTERS in 2016. He is serving or served on the editorial boards of several journals, including the *Journal of Network and Computer Applications*, the *IEEE Access*, *Wireless Networks*, *Physical Communication*, the *AEU-International Journal of Electronics and Communications*, *Ad Hoc & Sensor Wireless Networks*, and the *KSII Transactions on Internet and Information Systems*.



**YUNFEI CHEN** (S'02–M'06–SM'10) received the B.E. and M.E. degrees in electronics engineering from Shanghai Jiao Tong University, Shanghai, China, in 1998 and 2001, respectively, and the Ph.D. degree from the University of Alberta, Canada, in 2006. He is currently an Associate Professor with the University of Warwick, U.K. His research interests include wireless communications, cognitive radios, wireless power transfer, energy harvesting, channel modeling, SNR estimation, diversity, modulation, and UWB systems.



**ARUMUGAM NALLANATHAN** (S'97–M'00–SM'05–F'17) was an Assistant Professor with the Department of Electrical and Computer Engineering, National University of Singapore, from 2000 to 2007. He served as the Head of Graduate Studies with the School of Natural and Mathematical Sciences, King's College London, U. K., from 2011 to 2012, where he is currently a Professor of Wireless Communications with the Department of Informatics. He has authored or co-authored more

than 300 technical papers in scientific journals and international conferences. His research interests include 5G wireless networks, Internet of Things, and molecular communications. He was a co-recipient of the Best Paper Award presented at the IEEE International Conference on Communications 2016 and the IEEE International Conference on Ultra-Wideband 2007. He is an IEEE Distinguished Lecturer. He has been selected as a Web of Science Highly Cited Researcher in 2016.

Dr. Nallanathan received the IEEE Communications Society SPCE Outstanding Service Award 2012 and the IEEE Communications Society RCC Outstanding Service Award 2014. He served as the Chair of the Signal Processing and Communication Electronics Technical Committee of the IEEE Communications Society and as a Technical Program Chair and a member of Technical Program Committees in numerous IEEE conferences. He was an Editor of the IEEE TRANSACTIONS ON WIRELESS COMMUNICATIONS from 2006 to 2011, the IEEE WIRELESS COMMUNICATIONS LETTERS, and the IEEE SIGNAL PROCESSING LETTERS. He is currently an Editor of the IEEE TRANSACTIONS ON COMMUNICATIONS and the IEEE TRANSACTIONS ON VEHICULAR TECHNOLOGY.



**VICTOR C. M. LEUNG** (S'75–M'89–SM'97–F'03) received the B.A.Sc. degree (Hons.) in electrical engineering from The University of British Columbia (UBC) in 1977 and the Ph.D. degree in electrical engineering from the Graduate School at UBC in 1982. He received the APEBC Gold Medal as the Head of the graduating class in the Faculty of Applied Science. He received the Canadian Natural Sciences and Engineering Research Council Postgraduate Scholarship from UBC.

From 1981 to 1987, he was a Senior Member of Technical Staff and a Satellite System Specialist with MPR Teltech Ltd., Canada. In 1988, he was a Lecturer with the Department of Electronics, The Chinese University of Hong Kong. He returned to UBC as a Faculty Member in 1989, where he is a Professor and a TELUS Mobility Research Chair in Advanced Telecommunications Engineering with the Department of Electrical and Computer Engineering. He has co-authored more than 1000 journal/conference papers and book chapters, and co-edited 12 book titles. Several of his papers have been selected for best paper awards. His research interests are in the broad areas of wireless networks and mobile systems.

Dr. Leung is a fellow of the Royal Society of Canada, the Engineering Institute of Canada, and the Canadian Academy of Engineering. He received the IEEE Vancouver Section Centennial Award and the 2011 UBC Killam Research Prize. He received the 2017 Canadian Award for Telecommunications Research. He is a co-author of the paper that has received the 2017 IEEE ComSoc Fred W. Ellersick Prize. He was a Distinguished Lecturer of the IEEE Communications Society. He is a registered Professional Engineer in BC, Canada. He is serving on the editorial boards of the IEEE WIRELESS COMMUNICATIONS LETTERS, the IEEE TRANSACTIONS ON GREEN COMMUNICATIONS and NETWORKING, the IEEE ACCESS, *Computer Communications*, and several other journals. He has previously served on the editorial boards of the IEEE JOURNAL ON SELECTED AREAS IN COMMUNICATIONS C Wireless Communications Series and Series on Green Communications and Networking, the IEEE TRANSACTIONS ON WIRELESS COMMUNICATIONS, the IEEE TRANSACTIONS ON VEHICULAR TECHNOLOGY, the IEEE TRANSACTIONS ON COMPUTERS, and the *Journal of Communications and Networks*. He has guest edited many journal special issues, and provided leadership to the organizing committees and technical program committees of numerous conferences and workshops.

• • •