

Old Dominion University ODU Digital Commons

Physics Faculty Publications

Physics

2013

Tests of an RF Dipole Crabbing Cavity for an Electron-Ion Collider

A. Castilla

Old Dominion University

J. R. Delayen

Old Dominion University

Follow this and additional works at: https://digitalcommons.odu.edu/physics_fac_pubs

 Part of the [Elementary Particles and Fields and String Theory Commons](#), and the [Engineering Physics Commons](#)

Repository Citation

Castilla, A. and Delayen, J. R., "Tests of an RF Dipole Crabbing Cavity for an Electron-Ion Collider" (2013). *Physics Faculty Publications*. 298.

https://digitalcommons.odu.edu/physics_fac_pubs/298

Original Publication Citation

Castilla Loeza, A., & Delayen, J. R. (2013). *Tests of an RF Dipole Crabbing Cavity for an Electron-Ion Collider*. Paper presented at the North American Particle Accelerator Conference, Pasadena, CA.

TESTS OF AN RF DIPOLE CRABBING CAVITY FOR AN ELECTRON-ION COLLIDER *

A. Castilla^{1,2,3†}, J. R. Delaysen^{1,2},

¹Center for Accelerator Science, Old Dominion University, Norfolk, VA 23529, USA.

²Thomas Jefferson National Accelerator Facility, Newport News, VA 23606, USA.

³Universidad de Guanajuato (DCI-UG), Departamento de Fisica, Leon, Gto. 37150, Mex.

Abstract

On the scheme of developing a medium energy electron-ion collider (MEIC) at Jefferson Lab, we have designed a compact superconducting rf dipole cavity at 750 MHz to crab both electron and ion bunches and increase luminosities at the interaction points (IP) of the machine. Following the design optimization and characterization of the electromagnetic properties such as peak surface fields and shunt impedance, along with field nonuniformities, multipole components content, higher order modes (HOM) and multipacting, a prototype cavity was built by Niowave Inc. The 750 MHz prototype crab cavity has been tested at 4 K and is ready for re-testing at 4 K and 2 K at Jefferson Lab. In this paper we present the detailed results of the rf tests performed on the 750 MHz crab cavity prototype.

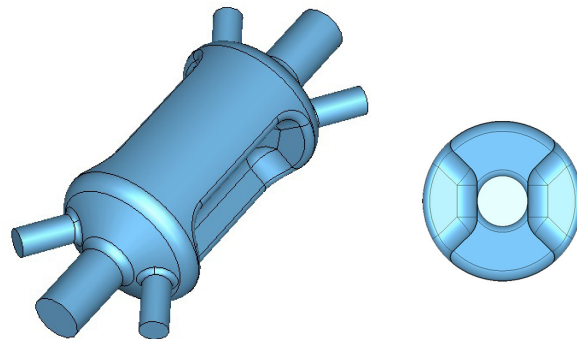

Figure 1: Rf dipole geometry and corresponding cross sections for the 750 MHz crab cavity design.

INTRODUCTION

The rf dipole geometry has been studied as a compact and efficient design for an electron-ion crabbing scheme for electron-ion colliders [1]. Among some of the most attractive properties of this design are the lower balanced surface fields with higher net deflection, higher shunt impedance, the advantage of having the operating deflecting/crabbing mode as the lowest mode, and the simple dependency of the rf properties on just a few geometrical parameters [2]. It is for all these reasons that the designed 750 MHz crab cavity prototype shown in Fig. 1 built by Niowave Inc. [3] has been tested and characterized at its facilities and the Center for Accelerator Science at Old Dominion University (CAS-ODU) to corroborate that the fields' symmetry, operation performance, conditioning to multipacting and external Q factor are in agreement with the designed values.

ROOM TEMPERATURE TESTS

Bead-Pull

In a TE_{11} deflector/crabber such as the rf dipole, the transverse kick has contributions from both the electric and the magnetic components of the fundamental mode, thus

* Authored by Jefferson Science Associates, LLC under U.S. DOE Contract No. DE-AC05-06OR23177. The U.S. Government retains a nonexclusive, paid-up, irrevocable, world-wide license to publish or reproduce this manuscript for U.S. Government purposes. Part of this work was done in collaboration with and supported by Niowave Inc. under the DOE STTR Phase II program.

† acastill@jlab.org

Table 1: Properties of the 750 MHz Crab Cavity

Parameter	750 MHz	Units
$\lambda/2$ of π mode	200.0	mm
Cavity length	341.2	mm
Cavity radius	93.7	mm
Aperture diameter d	60.0	mm
Deflecting voltage V_T^*	0.200	MV
Peak electric field E_P^*	4.45	MV/m
Peak magnetic field B_P^*	9.31	mT
B_P^*/E_P^*	2.09	mT/(MV/m)
Energy content U^*	0.068	J
Geometrical factor	131.4	Ω
$[R/Q]_T$	124.2	Ω
$R_T R_S$	1.65	$\times 10^4 \Omega^2$

At $E_T^* = 1$ MV/m

the symmetry of the field profiles is a key point in the fabrication of the cavity to avoid introducing higher-order nonlinear field effects on the beams.

Once the electromagnetic design has been characterized using computer simulations, it is of utmost importance to characterize defects introduced during the fabrication and chemical treatment processes on the cavity, like asymmetries due to offsets on the load elements, perturbations induced by deformations on the volume, etc.

Different runs of bead-pull measurements were performed on the 750 MHz rf dipole crab cavity before and after e-welding using the automated bead-pull system set at CAS-ODU (see Fig. 2).

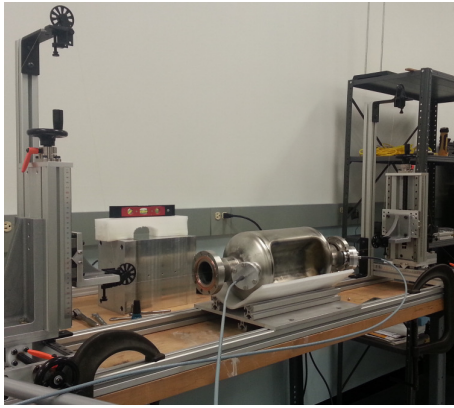

Figure 2: Bead-pull 750 MHz rf dipole set up at CAS-ODU.

The bead-pull results for both metallic and dielectric beads are presented in Figs. 3 and 4, compared with the calculations using the electric and magnetic fields for the crabbing mode found by simulations, showing a remarkable agreement at first order.

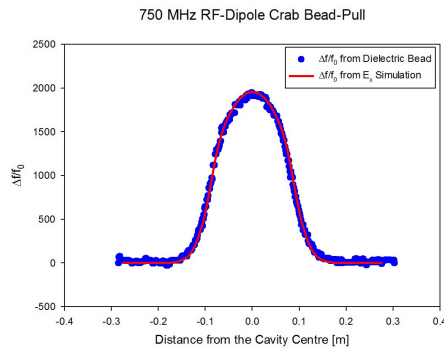

Figure 3: Frequency shift measured with a Teflon bead (blue) and calculated from the electric field by the simulations (red).

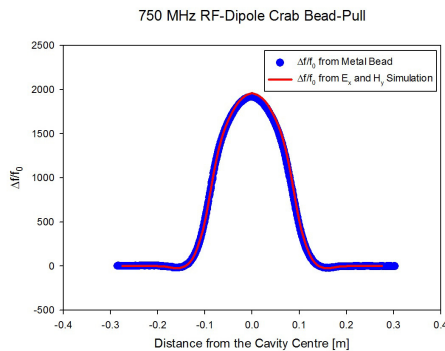

Figure 4: Frequency shift measured with a brass bead (blue) and calculated from the electric and magnetic field by the simulations (red).

Study of Losses at the Port Flanges

All the ports in the design are placed in the outer conductor regions with the lowest tangential surface magnetic fields, nevertheless these are not zero and there is still a fraction of them that can create currents on the nonsuperconducting flanges causing ohmic losses (see Fig. 5). The associated Q to these power dissipations can limit the final cavity Q_0 measured during operation or cryo-testing. For this reason a detailed numerical analysis was performed for the 750 MHz rf dipole crab cavity considering flanges both made of stainless steel and copper. The results are presented in Table 2.

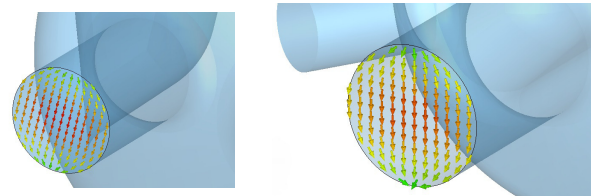

Figure 5: Visualization of the tangential magnetic field (H_y) obtained from CST Microwave Studio[®] simulations at the side-port flanges (left) and the beam-port flanges (right).

Table 2: Losses in the Port Flanges Due to Tangential Magnetic Field (H_y)

Copper			
Port	P_{loss} [W]	Q	Total P_{loss} [W]
2 Beam-ports	1.303×10^{-2}	3.61×10^{11}	
4 Side-ports	4.27×10^{-1}	1.102×10^{10}	
			4.400×10^{-1}
Stainless Steel			
2 Beam-ports	8.23×10^{-2}	5.713×10^{10}	
4 Side-ports	2.702	1.742×10^9	
			27.844×10^{-1}

Using for the flanges:

$$Q = \frac{\omega U}{P_{loss}}, \tag{1}$$

we have:

$$Q_{S.S.} = 1.69 \times 10^9, \\ Q_{Cu} = 1.07 \times 10^{10}.$$

While for the cavity we have:

$$Q_0 = \frac{G}{R_s}. \tag{2}$$

And considering for 750 MHz: @4 K $R_s = 240 n\Omega$ with $R_{BCS} = 20 n\Omega$ and @2 K $R_s = 60 n\Omega$, while from

the simulations we obtained a $G = 131.4 \Omega$. Then using Eqn. 2:

$$\begin{aligned} (Q_0)_{@4K} &= 5.48 \times 10^8, \\ (Q_0)_{@2K} &= 2.19 \times 10^9. \end{aligned}$$

The results of this analysis showed us that the losses in stainless steel blanks and feed-throughs will not affect the measured Q_0 for the cavity on a test at 4 K, while in the case of 2 K we need to use Copper blank gaskets to minimize the losses at the flanges and reach the expected Q_0 values.

CRYOGENIC TESTS

For the performance test of the 750 MHz rf dipole crab cavity, the intrinsic quality factor (Q_0) achieved was measured as a function of the transverse voltage (V_T) at 4 K at the Niowave Inc. installations. During the testing a vertical dewar and a liquid He tank were used to cool the cavity down to 4.2 K while being driven by a 200 W amplifier (400-1000 MHz).

Among the important events during the testing to be noticed is that at low gradients a few multipacting barriers were present and conditioned without major problems and relatively quickly, this comes into agreement with the multipacting simulation results [4], even when no higher gradients were reached during this test. Due to that, the power dissipation on the cavity was enough to boil out the liquid He before we could move to higher gradients. No hard multipacting barriers or quenching occurred for the proof of principles cavity as can be appreciated in Fig. 6.

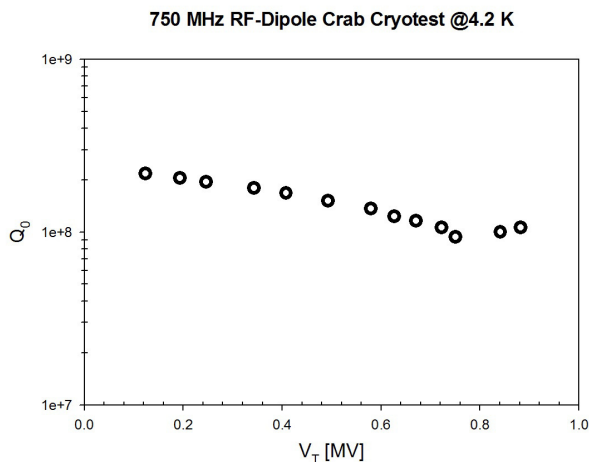

Figure 6: Q_0 curve obtained during the cryotesting of the cavity prototype up to ~ 0.9 MV of transverse voltage.

Even when the curve describes a small slope it appears to be considerably flat around a value of $Q_0 \sim 1.5 \times 10^8$ (about a factor of 4 shorter with respect to the predicted value from the simulations). The region covered by the test corresponds to the region in which the multipacting barriers were expected to be present according to the anal-

ysis, having found no major problem to condition them without thermal breakdown or quenching. It can be observed around 0.8 MV of transverse voltage that the cavity presented a bigger multipacting conditioning, which was surpassed without further problem and the value of Q_0 reestablished.

All of the information compiled during the test supports that with the capability of keeping the temperatures, the cavity should reach the design specifications for the expected gradients without major problems. For this reason the cavity was shipped to ODU to be re-processed and re-tested at 4.2 K, and then at 2 K, when a leak on one of the brazings was detected and characterized. New parts have been purchased from Niowave Inc. and the cavity is scheduled to proceed with the corresponding cryotesting after repairing and re-processing at Jefferson Lab.

CONCLUSIONS

An rf crabber for both electron/ion bunches with designed values of $V_T = 1.6$ MV, $E_p = 35.6 \frac{MV}{m}$ and $B_p = 75.5$ mT per cavity was fabricated at Niowave Inc. After surface treatment [5] and high pressure rinsing, a thorough characterization of the rf properties and performance for the 750 MHz rf dipole prototype have been realized both at room temperature (low level rf) and at 4 K with satisfying results such as symmetry of the fields in agreement with the design simulations, capability of processing multipacting and absence of quenching at the reached gradients ($E_p = 20.0 \frac{MV}{m}$, and $B_p = 41.9$ mT). Due to the success of this first test, a more detailed test at 4 K and 2 K to reach higher gradients was scheduled at the Jefferson Lab facilities, but having discovered a leak on one of the cavity brazings after shipping, the test has been rescheduled and the replacement of a new port by the cavity group at Jefferson Lab is currently undergoing.

ACKNOWLEDGMENTS

We want to express our gratitude to the Niowave Inc. personnel, CAS-ODU members Subashini De Silva, Christopher Hopper and Kevin Mitchell as well as HyeKyoung Park and the cavity group at Jefferson Lab. This research used resources of the National Energy Research Scientific Center, which is supported by the Office of Science of the U.S. Department of Energy under contract No. DE-AC02-05CH11231.

REFERENCES

- [1] A. Castilla et al., in Proc. of IPAC'12, New Orleans, Louisiana, p. 2447 (2012).
- [2] S. U. De Silva and J. R. Delayen, Phys. Rev. ST Accel. Beams 16, 012004 (2013).
- [3] D. Gorelov et al., in Proc. of IPAC'12, New Orleans, Louisiana, p. 2411 (2012).
- [4] S.U. De Silva et al., in Proc. of IPAC'13, Shanghai, China, p. 2483 (2013).
- [5] P. Kneisel, Nucl. Instrum. Methods 557, 1 (2006).